

TM 9-813

TO 19-75 AAA-18

WAR DEPARTMENT TECHNICAL MANUAL

G3 FILE



6-TON, 6x6 TRUCK (WHITE, CORBITT, AND BROCKWAY)

G3 FILE

WAR DEPARTMENT • FEBRUARY 1944

6-TON 6 X 6 TRUCK (WHITE, CORBITT, WARD LA FRANCE, AND BROCKWAY)

CHANGES)
No. 1 }

DEPARTMENT OF THE ARMY
WASHINGTON 25, D. C. 7 June 1954

TM 9-813, 19 February 1944, is changed as follows:

The title of this manual is changed to: 6-TON 6 X 6 TRUCK (WHITE, CORBITT, WARD LA FRANCE, AND BROCKWAY).

1. Scope

b. In addition to a description of the 6-ton 6x6 prime mover truck, the 2-bridge traction ponton truck, the crane truck, the gasoline tank truck, and the tractor truck, this manual contains descriptions of the major units, group assemblies, functional systems, and instructions with reference to their operation, inspection, adjustments, minor repair, and unit replacement. Specific information for the guidance of operating personnel (crew) is contained in Part One, sections I through VII. Information for the guidance of organizational maintenance personnel (using arm mechanics) is contained in Part Two, sections IX through XXXIV.1. Part Three, sections XXXVI and XXXVII, contains instructions for shipment and limited storage and destruction to prevent enemy use. The appendix at the end of the manual contains a list of references including standard nomenclature lists, forms, technical manuals, and other publications applicable to the matériel.

c. In all cases *** proper instructions issued. The replacement of certain assemblies, that is, the engine, transmission, rear axle, front axle, transfer case, clutch, and winch assemblies, is normally an ordnance maintenance operation, but may be performed in an emergency by the using organization provided authority for performing these replacements is obtained from the responsible commander. A replacement assembly, any tools needed for the operation which are not carried by the using organization, and any necessary special instructions regarding associated accessories, etc., may be obtained from the supporting maintenance unit.

1.1 Forms, Records, and Reports

(Akk-3)

a. GENERAL. Forms, records, and reports are designed to serve necessary and useful purposes. Responsibility for the proper execu-

* This change supersedes TM 9-813-1, 16 Mar 1944; TM 9-813-2, 26 May 1944, and portions of TM 11889-206, 2 January 1943; TM 41889-978, 1 April 1945; TM 41889-205, 25 June 1945; TB OHD 341, 15 July 1946; and TB OHD 342, 4 July 1946, pertaining to the matériel contained herein.

tion of these forms rests upon commanding officers of all units operating and maintaining vehicles. It is emphasized, however, that forms, records, and reports are merely aids. They are not a substitute for thorough practical work, physical inspection, and active supervision.

b. **AUTHORIZED FORMS.** The forms generally applicable to units operating and maintaining these vehicles are listed in the appendix. No forms other than those approved for the Department of the Army will be used. Pending availability of forms listed, old forms may be used. For a current and complete listing of all forms, refer to current SR 310 20 6.

c. **FIELD REPORT OF ACCIDENTS.** The reports necessary to comply with the requirements of the Army safety program are prescribed in detail in the SR 885 10 40 series of special regulations. These reports are required whenever accidents involving injury to personnel or damage to matériel occur.

d. **REPORT OF UNSATISFACTORY EQUIPMENT OR MATERIALS.** Any suggestions for improvement in design and maintenance of equipment, safety and efficiency of operation, or pertaining to the application of prescribed petroleum fuels, lubricants, and/or preserving materials will be reported through technical channels, as prescribed in SR 700 45 5, to the Chief of Ordnance, Washington 25, D. C., ATTN: ORDFM, using DA AGO Form 408, Unsatisfactory Equipment Report. Such suggestions are encouraged in order that other organizations may benefit.

3. Differences Among Models

a. BODY STYLE.

- * * * * *
- (4) (Added) *Gasoline-tank truck.* This vehicle (fig. 8.1) consists of a 6-ton 6 x 6 truck chassis (White) equipped with a 2,000-gallon subdivided gasoline tank.
- (5) (Added) *Tractor truck.* This vehicle (fig. 8.2) consists of a 6-ton 6 x 6 truck chassis (White) equipped with a fifth wheel. The vehicle is used primarily for towing semitrailers.
- (6) (Added) *Bridge erection and crane trucks.* The trucks described in (2) above are also assembled by Ward La France. The trucks described in (3) above are assembled by Brockway and Ward La France.
- * * * * *

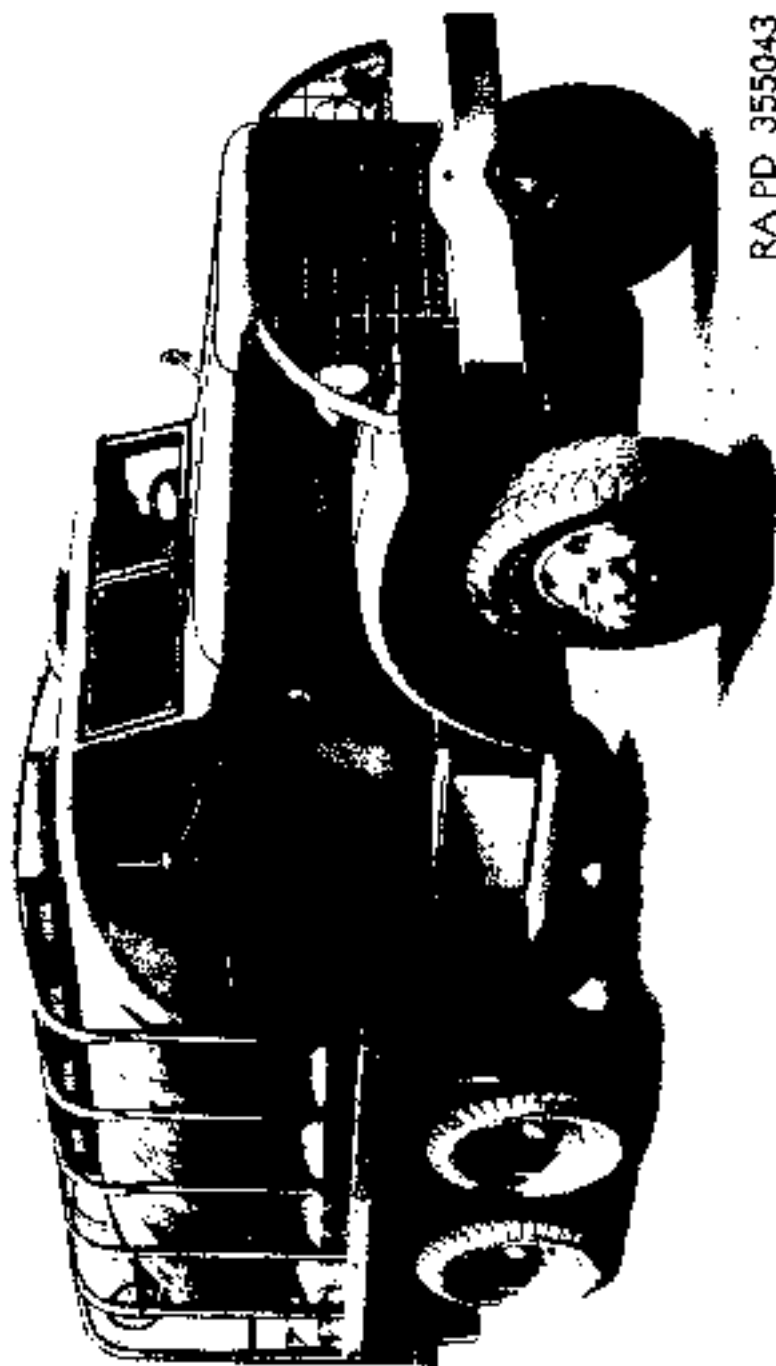


Figure 8.2 (Alford) Truck, 6-ton, 6 X 6, passenger tonik. \$,000-pullton (W.A.16)—right, front view. RA PD 355043

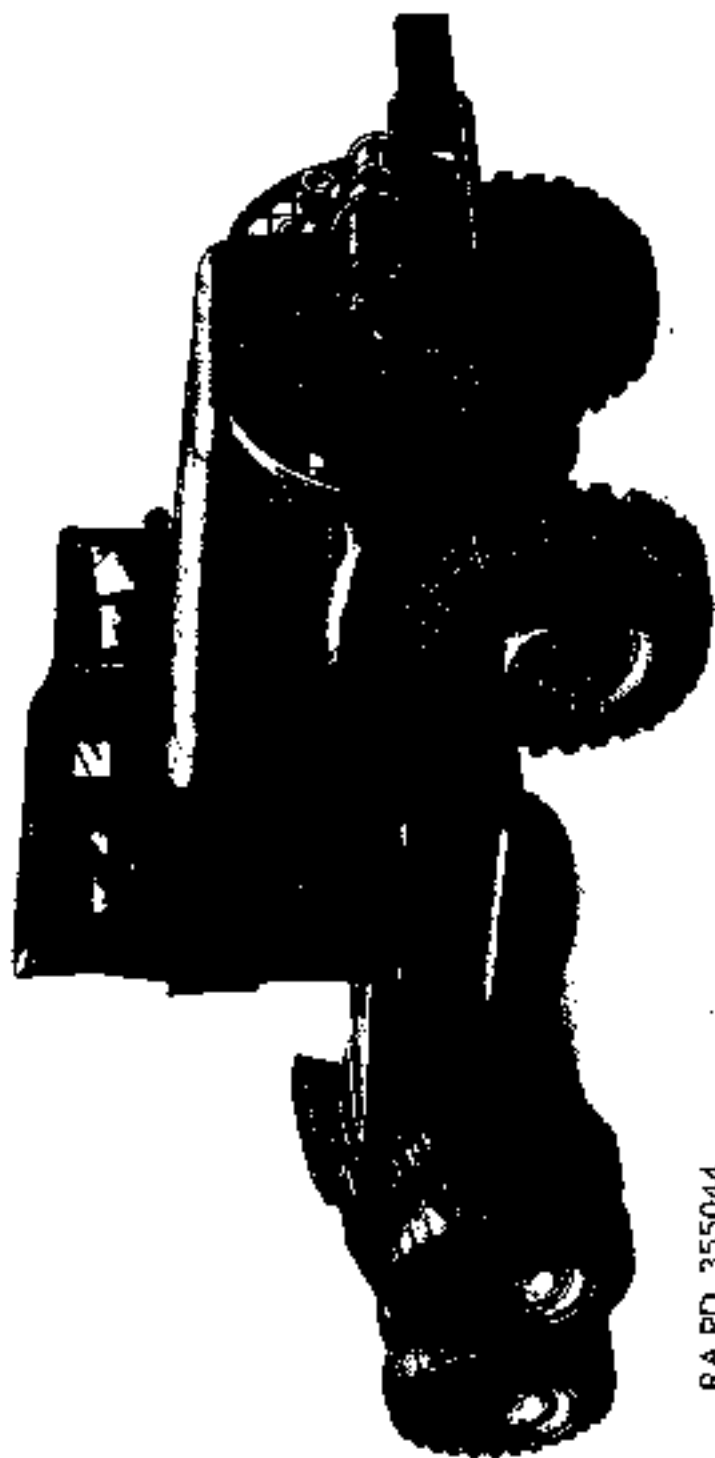


Figure 8.2 (b) (b) (b) Tractor, 4-ton, 4 X 6, tractor (F1010) (b) (b) (b)

RA PD 355044

6. Vehicle Controls

a. CONTROLS ON INSTRUMENT PANEL.

- (8) *Windshield wiper controls* (U, fig. 11). Dual windshield wipers with right wiper tight. Refer to paragraph 136 for adjustment of the maximum wiper speed.

Section V. OPERATION UNDER UNUSUAL CONDITIONS (Superseded)

12. General Conditions

a. In addition to the operating procedures described for usual conditions, special instructions of a technical nature for operating and servicing this vehicle under unusual conditions are contained or referred to herein. In addition to the normal preventive maintenance service, special care in cleaning and lubrication must be observed where extremes of temperature, humidity, and terrain conditions are present or anticipated. Proper cleaning, lubrication, and storage and handling of fuels and lubricants not only insure proper operation and functioning, but also guard against excessive wear of the working parts and deterioration of the matériel.

b. TM 21-300 contains very important instructions on driver selection, training, and supervision and TM 21-305 prescribes special driving instructions for operating wheeled vehicles under unusual conditions.

Caution: It is imperative that the approved practices and precautions be followed. A detailed study of these technical manuals is essential for use of this matériel under unusual conditions.

c. Refer to the lubrication order for lubrication, to tables I and II for preventive maintenance checks, and to section XX XIV.J for maintenance procedures under unusual conditions.

d. When chronic failure of matériel results from subjection to extreme conditions, report of the condition should be made on DA ACO Form 468 (par. 1.1).

13. Extreme Cold Weather Conditions

a. GENERAL PROBLEMS.

- (1) Extensive preparation of matériel scheduled for operation in extreme cold weather is necessary. Generally, extreme cold will cause lubricants to thicken or congeal, freeze batteries or prevent them from furnishing sufficient current for cold weather starting, crack insulation and cause electrical short circuits, prevent fuel from vaporizing and properly combining with air to form a combustible mixture for start-

ing, and will cause the various construction materials to become hard, brittle, and easily damaged or broken.

- (2) For description of operations in extreme cold, refer to FM 70-15 and TM 9-2855.

Caution: It is imperative that the approved practices and precautions be followed. TM 9-2855 contains information which is specifically applicable to this vehicle as well as to all other vehicles. It must be considered an essential part of this manual, not merely an explanatory supplement to it.

b. WINTERIZATION EQUIPMENT. Information on winterization equipment used for operation in extreme cold weather (0° to -65° F.) is contained in TM 9-2855.

c. FUELS, LUBRICANTS, AND ANTIFREEZE COMPOUNDS (STORAGE, HANDLING, AND USE). The operation of equipment at arctic temperatures will depend to a great extent upon the condition of the fuels, lubricants, and antifreeze compounds used in the equipment. Immediate effects of careless storage and handling or improper use of these materials are not always apparent, but any deviation from proper procedures may cause trouble at the least expected time. Refer to TM 9-2855 for detailed instructions.

14. Extreme Cold Weather Operation

a. GENERAL.

- (1) The driver must always be on the alert for indications of the effect of cold weather on the vehicle.
- (2) The driver must be very cautious when placing the vehicle in motion after a shut-down. Congealed lubricants may cause failure of parts. Tires frozen to the ground or frozen to the shape of the flat spot while underinflated must be considered. One or more brake shoes may be frozen fast and require preheating to avoid damage to the clutch surfaces. After warming up the engine thoroughly, place transmission in first gear and drive vehicle slowly about 100 yards, being careful not to stall the engine. This should heat gears and tires to a point where normal operation can be expected.
- (3) Constantly note instrument readings. If temperature gage reading consistently exceeds normal temperature, stop the vehicle and investigate the cause.

b. AT HALT OR PARKING.

- (1) When halted for short shut-down periods, park the vehicle in a sheltered spot out of the wind. If no shelter is available, park so that the vehicle does not face into the wind. For long shut-down periods, if high ground is not available, prepare a footing of planks or brush. Chock in place, if necessary.

- (2) When preparing a vehicle for shut-down periods, place control levers in the neutral position to prevent them from possible freezing in an engaged position. Freezing may occur when water is present due to condensation.
- (3) Clean all parts of the vehicle of snow, ice, and mud as soon as possible after operation. Refer to table I for detailed after operation procedures. If the winter front and side covers are not available or installed, be sure to protect all parts of engine and engine accessories against entrance of loose, drifting snow during the halt. Snow flurries penetrating the engine compartment may enter the crankcase filler vent, etc. Cover and shield the vehicle but keep the ends of the canvas paulins off the ground to prevent them from freezing to the ground.
- (4) If no power plant heater is present, the battery should be removed and stored in a warm place.
- (5) Refuel immediately in order to prevent condensation in the fuel tank.
- (6) Check tire pressure (par. 16b).

15. Operation in Extreme Hot Weather Conditions

a. GENERAL. Continuous operation of the vehicle at high speed or long hard pulls in low gear positions on steep grades or in soft terrain may cause the vehicle to register overheating. Avoid the continuous use of low gear ratios whenever possible. Continuously watch the temperature and halt the vehicle for a cooling-off period whenever necessary and the tactical situation permits. Frequently inspect and service cooling unit, oil filter, and air cleaner. If the engine temperature consistently rises above 200°F., look for dust, sand, or insects in radiator fins and blow out any accumulation with compressed air or water under pressure. Flush cooling system, if necessary.

b. AT HALT OR PARKING.

- (1) Do not park the vehicle in the sun for long periods, as the heat and sunlight will shorten the life of the tires. If possible, place vehicle under cover to protect it from sun, sand, and dust.
- (2) Cover inactive vehicles with paulins if no other suitable shelter is available. Where entire vehicle cannot be covered, protect window glass against sand etching, and protect engine compartment against entry of sand.
- (3) Vehicles inactive for long periods in hot humid weather are subject to rapid rusting and accumulation of fungi growth. Make frequent inspections and clean and lubricate to prevent excessive deterioration.
- (4) Check tire pressure (par. 16b).

16. Operation on Unusual Terrain

a. GENERAL.

- (1) All tactical vehicles will be fitted with cross country tire kits. The procedure for installation of such kits is indicated in MWO ORD G1-W21. These kits include large tires, 14.00-20, 12 ply, in order to permit greater mobility through increased flotation. This installation will facilitate operation of these vehicles under unusual terrain conditions, that is, in mud, snow, soft or beach sand, and on rock terrain.
- (2) Vehicle operation on snow or ice and in deep mud requires the use of tire chains. Tire chains must be installed in pairs (front and rear) to prevent power train damage and wear. Select a gear ratio low enough to move vehicle steadily and without imposing undue driving strain on engine and power train. However, racing of the engine for extended periods must be avoided.
Note. Avoid excessive clutch slippage.
- (3) Operators must, at all times, know the position in which the front wheels are steering, as the vehicle may travel straight ahead even though the wheels are cramped right or left. A piece of string tied to the front portion of the steering wheel rim in "straight-ahead" position will indicate to the driver whether the front wheels are "ploughing." This ploughing action may cause the vehicle to stall or suddenly veer to right or left.
- (4) If one or more wheels become mired and others spin, it may be necessary for the vehicle to be winched or towed by a companion vehicle or to jack up the wheel which is mired and insert planking or matting beneath it. Do not jam sticks or stones under a spinning wheel, as this only forms an effective block and will wear the tire tread unnecessarily.
- (5) Operation in sand requires daily cleaning of air cleaners and fuel and oil filters. Engine vents and other exposed vents should be covered with cloth.
- (6) At high altitudes, coolant in vehicles boils at proportionately lower points than 212°F., thus, it will be necessary to keep a close watch on the engine temperature during the summer months.

b. **RECOMMENDED TIRE PRESSURES.** For trucks equipped with cross country tire kits (a(1) above), the recommended tire pressures for the different terrain conditions are as follows:

- | | |
|--|--------|
| (1) General service..... | 90 psi |
| (2) Muddy or rocky terrain or snow..... | 55 psi |
| (3) Continuous operation in soft sand..... | 25 psi |
| (4) For sand dunes or emergency landings onto sandy beaches..... | 20 psi |

c. **AFTER OPERATION PROCEDURES.** Clean all parts of the vehicle of snow, ice, mud, dust, and sand as soon as possible after operation. Particular care should be taken to remove collections of ice, snow, and mud from the radiator core, engine compartment, steering knuckles and arms, brake chambers and hoses, crankcase ventilator oil filter, air cleaners, and electrical connections.

Caution: Carefully remove accumulations of ice, caked mud, etc from under fenders.

16.1 Forging Operations

(Added)

a. **GENERAL.** In forging, vehicles may be subjected to water varying in depth from only a few inches to an amount sufficient to completely submerge the vehicle. Factors to be considered are spray splashing precautions, normal fording capabilities, deep water fording using fording kits, and accidental complete submersion.

b. **NORMAL FORDING.** Fording of bodies of water up to maximum vehicle fording depth is based on the standard vehicle with special protection provided for critical units, but without deep water fording kit. Observe the following precautions:

- (1) Do not exceed the known fording limits of the vehicle.
- (2) The engine must be operated at maximum efficiency before attempting to ford.
- (3) Engage front axle drive; shift transfer case and transmission gearshifts into low range. Speed up engine to overcome the possibility of a "stall" when the cold water chills the engine. Enter the water slowly. If engine stalls while fording, it may be started in the usual manner.
- (4) All normal fording should be at speeds of from 3 to 4 mph to avoid forming a "bow wave." Avoid using the clutch, if possible, because frequent use while submerged may cause the clutch to slip. If the ford is deep enough for the spinning fan blades to catch water, loosen the fan belt before crossing to prevent the blades from throwing water over the electrical units. The brakes usually will be "lost" but, in some cases, may "grab" after emergence. Applying the brakes a few times will help dry out the brake linings after dry land has been reached.
- (5) If accidental complete submersion occurs, the vehicle will be salvaged and temporary preservation applied by performing a complete lubrication service (par. 22) and by checking engine crankcase and oil filter (par. 160.3b (5)), and then sent to the ordnance maintenance unit as soon as possible for necessary permanent maintenance.

c. **DEEP WATER FORDING.** Refer to TM 9-2858 for general information, descriptions, and methods of use of deep water fording kits.

d. **AFTER FORDING OPERATIONS.** Immediately after vehicle emerges from the water, if tactical situation permits, remove water from compartments, check engine oil level, and check for presence of water in crankcase. Heat generated by driving will evaporate or force out most water which has entered at various points. Also, any small amount of water which has entered the crankcase either through leakage or due to condensation usually will be dissipated by the ventilating system. Refer to paragraph 160.3 for maintenance operations after fording.

Section VI. PREVENTIVE MAINTENANCE BY DRIVER OR OPERATOR (Superseded)

17. General

a. **RESPONSIBILITY AND INTERVALS.** Preventive maintenance services are the responsibility of the using organization. These services consist generally of before operation, during operation, at the halt, after operation, and weekly services performed by the driver or operator; and of the scheduled services performed at designated intervals by organization mechanic or maintenance crews. Intervals are based on normal operations. Reduce intervals for abnormal operations or severe conditions. Intervals during inactive periods may be extended accordingly.

b. **DEFINITION OF TERMS.** The general inspection of each item applies also to any supporting member or connection and generally is a check to see whether the item is in good condition, correctly assembled, secure, and not excessively worn.

- (1) The inspection for "good condition" is usually an external visual inspection to determine whether the unit is damaged beyond safe or serviceable limits. The term "good condition" is explained further by the following: not bent or twisted, not chafed or burred, not broken or cracked, not bare or frayed, not dented or collapsed, not torn or cut, and not deteriorated.
- (2) The inspection of a unit to see that it is "correctly assembled" usually is an external visual inspection to see if it is in its normal assembled position in the vehicle.
- (3) Inspection of a unit to determine if it is "secure" usually is an external visual examination or a check by wrench, hand, or pry-bar for looseness. Such an inspection must include any brackets, lock washers, lock nuts, locking wires, or cotter pins used.

- (4) By "excessively worn" is meant worn beyond serviceable limits or to a point likely to result in failure if the unit is not replaced before the next scheduled inspection.

18. Cleaning

a. **GENERAL.** Any special cleaning instructions required for specific mechanism or parts are contained in the pertinent section. General cleaning instructions are as follows:

- (1) Use dry cleaning solvent or volatile mineral spirits paint thinner to clean or wash grease or oil from all parts of the vehicle.
- (2) A solution of one part grease-cleaning compound to four parts of dry-cleaning solvent or volatile mineral spirits paint thinner may be used for dissolving grease and oil from engine blocks, chassis, and other parts. Use cold water to rinse off any solution which remains after cleaning.
- (3) After the parts are cleaned, rinse and dry them thoroughly. Apply a light grade of oil to all polished metal surfaces to prevent rusting.
- (4) Before installing new parts, remove any preservative materials, such as rust-preventive compounds, protective grease, etc; prepare parts as required (oil seals, etc); and for those parts requiring lubrication, apply the lubricant prescribed in the lubrication order.

b. GENERAL PRECAUTIONS IN CLEANING.

- (1) Dry-cleaning solvent and volatile mineral spirits paint thinner are inflammable and should not be used near an open flame. Fire extinguishers should be provided when these materials are used. Use only in well-ventilated places.
- (2) These cleaners evaporate quickly and have a drying effect on the skin. If used without gloves, they may cause cracks in the skin and, in the case of some individuals, a mild irritation or inflammation.
- (3) Avoid getting petroleum products, such as dry-cleaning solvent, volatile mineral spirits paint thinner, engine fuels, or lubricants on rubber parts, as they will deteriorate the rubber.
- (4) The use of Diesel fuel oil, gasoline, or benzene (benzol) for cleaning is prohibited.

19. Preventive Maintenance by Driver or Operator

a. **PURPOSE.** To insure mechanical efficiency, it is necessary that the vehicle be systematically inspected at intervals each day it is operated, and also weekly, so that defects may be discovered and corrected before they result in serious damage or failure. Certain

scheduled maintenance services will be performed at these designated intervals. Any defects or unsatisfactory operating characteristics beyond the scope of the driver or operator to correct must be reported at the earliest opportunity to the designated individual in authority.

b. SERVICES. Driver's or operator's preventive maintenance services are listed in table I. Every organization must thoroughly school its personnel in performing the maintenance procedures for this vehicle as set forth in this manual.

Table I. Driver's or Operator's Preventive Maintenance Services

Before operation	During operation	Intervals			Procedure
		As the air	After operation	Weekly	
					USUAL CONDITIONS Caution: Place all tags describing condition of vehicle in the driver's compartment in a conspicuous location so that they will not be overlooked.
X		X	X	X	Fuel, oil, water. Check fuel, oil, and water levels. Look for leaks in engine compartment. Check spare containers for contents.
X		X	X	X	Tires. Gage tires for correct pressure. Remove penetrating objects such as nails or glass. Remove stones from between duals. Note any apparent loss of air, unusual wear, or missing valve caps.
X		X	X	X	Leaks, general. Look under vehicle for indication of fuel, engine oil, gear oil, or water leaks.
X				X	Vehicle equipment. Visually inspect fire extinguishers and vehicle publications, including necessary forms.
X			X	X	See that fire extinguishers are charged. Operate lights, horn or siren (if central situation permits), and windshield wipers. Visually inspect mirrors, reflectors, etc.
X			X	X	Visually inspect body, towing connections, doors, tractor truck fifth wheel, pullins, tools, etc.
				X	Check for any tampering or damage that may have occurred since last inspection.
X	X				Instruments. Observe for normal readings during warmup and during operation of vehicle (par. 7a 141). Caution: If oil pressure gage registers zero or excessively low oil pressure, shut off engine immediately and investigate cause.
	X				General operations. Be alert for any unusual noises or improper operation of steering, clutch, brakes, or gear shifting.

Table 1. Driver's or Operator's Preventive Maintenance Services—Continued

	Intervals			Weekly	Procedure
	Before operation	During operation	At the halt		
X			X	X	<p>USUAL CONDITIONS—Continued</p> <p><i>Operating faults.</i> Investigate and correct or report any faults noted during operation.</p> <p><i>Springs and suspensions.</i> Look at springs, suspensions, shock absorbers, and torque rods to see if they have been damaged.</p> <p><i>Fuel filters.</i> Check all fuel filters for leaks.</p> <p>Remove the drain plug or sediment bowl and remove all water and sediment from the filter (par. 63).</p> <p><i>Air-brake reservoirs.</i> Drain condensation.</p> <p><i>Lubricate.</i> Lubricate daily and weekly items specified on lubrication order.</p> <p><i>Clean.</i> Clean glass and inside of vehicle. Wipe off exterior of vehicle.</p> <p>Wash vehicle, clean engine, and engine compartment.</p> <p><i>Battery.</i> Clean, check water level, and inspect terminals for tightness and coating of grease.</p> <p><i>Assemblies and belts.</i> Inspect assemblies such as carburetor, generator, compressor, starter, and water pump for looseness of mountings or connections. Press drive belts to determine if tension is correct (par. 74).</p> <p><i>Electrical wiring.</i> Inspect, visually, electrical wiring, harnesses, and shielding.</p> <p><i>Axle and transfer vents.</i> Inspect for clogging.</p> <p>UNUSUAL CONDITIONS</p> <p>Preventive maintenance services for usual conditions will apply with emphasis on servicing by the operator to combat the effect of unusual conditions of extreme cold, extreme heat, unusual strain, and fording. The special services described below are required to assure optimum results under unusual conditions.</p> <p>EXTREME COLD (pars. 13, 14, 160.7 and TM 9-2855)</p> <p><i>Cooling and fuel systems.</i> Refuel and add denatured alcohol as required.</p> <p>Drain fuel tank and fuel tank pump to remove condensation, refuse tank.</p> <p>Check level and specific gravity of radiator coolant. Add ethylene glycol and/or water, if needed.</p> <p><i>Note.</i> If system carries water antifreeze contained, make a warning tag and post it on or near the engine fire mark. The tag should read: "THIS COOLING SYSTEM IS FILLED WITH ARCTIC ANTIFREEZE COMPOUND. CAUTION: DO NOT ADD WATER OR ANY OTHER TYPE OF ANTIFREEZE."</p>
			X	X	
				X	
				X	
				X	
				X	
				X	
				X	
				X	
				X	
				X	
				X	
				X	
				X	
				X	

Table 1. *Driver's or Operator's Preventive Maintenance Services—Continued*

Before operation	During operation	Intervals			Procedure
		At the end of	After operation	Weekly	
					UNUSUAL CONDITIONS—Continued
					EXTREME COLD—Continued
		X	X		<i>Transmission and transfer levers.</i> Position levers in neutral position.
X		X			<i>Tires.</i> Check for tires frozen to ground or for frozen fat spots.
X				X	Check for availability and serviceability of tire chains.
X				X	Check for proper pressure (par. 164).
			X		<i>Battery.</i> Check for proper charge.
			X		Remove battery and store in warm place, if vehicle is not equipped with power plant heater.
X			X	X	<i>Clean.</i> Clean snow, ice, and mud from all parts of vehicle.
X					<i>Brakes.</i> Check for frozen brake shoes.
					<i>Winterization equipment (if available).</i>
X					Check personnel heater and windshield defrosters for proper operation.
			X		Fill power plant heater fuel tank and check unit for proper functioning.
				X	Check all winterization equipment for secure installation and proper functioning.
X			X		Check winterfront cover, hood blankets, under-chassis blankets, hard top enclosure, etc. for security and proper adjustment.
					EXTREME HEAT (pars. 15 and 160.2)
X				X	<i>Cooling and fuel systems.</i> Check air cleaner, fuel and oil filters, and radiator fins and clean as often as necessary to keep them in good condition.
X				X	<i>Battery.</i> Check electrolyte level.
			X		Check for proper charge.
			X		If necessary to park for extended periods, remove battery and store in cool place.
		X	X		<i>Tires.</i> Shield tires, if possible, from direct rays of the sun.
X				X	Check for proper pressure (par. 166).
					UNUSUAL TERRAIN (pars. 16 and 168.4)
			X		<i>Lubrication.</i> Check for needed lubricants and lubricate as necessary.
X				X	<i>Tires.</i> Check for proper pressure (par. 166).
X				X	Check for availability and serviceability of tire chains.

Table 7. Driver's or Operator's Preventive Maintenance Services—Continued

	Intervals				Procedure
	Before operation	During operation	At the end	After operation	
				Weekly	
X				X	UNUSUAL CONDITIONS—Continued UNUSUAL TERRAIN—Continued <i>Cooling and fuel systems.</i> Check air cleaner, fuel and oil filters, and radiator fins and clean as often as necessary to keep them in good condition.
X			X	X	<i>Clean.</i> Clean all parts of vehicle of snow, ice, mud, dust, and sand.
				X	Check for any sandblasted surfaces and touch up paint as required.
X			X		<i>Vents.</i> Check engine vents and other exposed vents and keep them covered with cloth.
					FORDING OPERATIONS (pars. 16.1 and 16.3)
X					<i>Fording limits.</i> Check vehicle fording limits. Loosen fan belt if required. See paragraph 16.1 for operation precautions.
X			X		<i>Tires.</i> Check for proper pressure (par. 16h). Check for availability and serviceability of tire chains. Install if necessary.
X				X	<i>Clean.</i> Remove water and sludge from all parts of vehicle and wash with fresh water.
			X		<i>Battery.</i> Check electrolyte for contamination. Check vent caps for tightness.
X			X		<i>Cooling and fuel systems.</i> Check air cleaner, oil and fuel filters, and clean or replace if necessary.
				X	<i>Lubrication.</i> Lubricate as instructed in the lubrication order.

Section VIII. TOOLS AND EQUIPMENT STOWAGE ON THE VEHICLE

(Rescinded)

Note. For information on parts, special tools, and equipment for organizational maintenance, refer to section XII.

29. Second Echelon Preventive Maintenance Services

a. Regular scheduled maintenance *** of operating organizations.

(4) *General procedures.* These general procedures *** apply them automatically.

(d) *Special services.* These are indicated * * * special services include:

2. *Clean.* (Superseded) Clean the unit as outlined in paragraph 18 to remove old lubricant, dirt, and other foreign material.

(5) *Specific procedures.* The procedures for performing each item in the 1,000 miles or 60 days and 6,000 miles or 6 months maintenance procedures are described in table II. Each page of the table has two columns at its left edge, corresponding to the 6,000 miles or 6 months and 1,000 miles or 60 days maintenance respectively. Very often it *** opposite the number.

Table II. Organizational Mechanics or Maintenance Crew Preventive Maintenance Services

Intervals		Procedure
6,000 Miles ¹ and 6 Months ¹	1,000 Miles ¹ or 60 Days ²	
		ROAD TEST
		The driver of a vehicle is often unaware of defects in his vehicle which have developed gradually and to which he has become accustomed. The fact that many drivers lack the ability to detect the developing causes of vehicle failures makes it desirable for the mechanic to road test the vehicle as part of the periodic preventive maintenance services. Before and during this road test, any repairs and adjustments necessary to insure safe operation should be made. The appropriate paragraph in the following service procedures should be consulted. If a defect found on the road test does not require immediate correction, note it on the check sheet. The defect can be corrected later during the service. Make provision for securing necessary replacement parts or units.
		Note: When the test is *** over 10 miles.
		<i>Before operation service.</i> (Superseded) Perform the before operation service, as outlined in table I, as a check to determine whether the vehicle is in a satisfactory condition to make the road test safely and whether it is adequately supplied with fuel, engine oil, and coolant.

¹ The chart which appears on pages 85 through 104 is changed so that the "6,000 Miles" and "6 Months" columns will read "6,000 Miles or 6 Months" and "1,000 Miles or 60 Days," as above.

² Whichever occurs first.

Table II Organizational Methods of Maintenance Crew Prescribes Maintenance Services—Continued

Frequency		Procedure
5,000 Miles ¹ or 6 Months ²	1,000 Miles ¹ or 60 Days ²	
		MAINTENANCE OPERATIONS
		Raise Vehicle Block Safely
		Caution: (Added) Use necessary precautions to block the vehicle so that it may be operated safely in gear at reasonable speeds. If facilities are not available for adequately and safely jacking up and blocking vehicle, omit the services which follow that require running the engine in gear.
21		Compression test. Test compression with *** sheet, Form Nu 461. If pressure in a cylinder is appreciably below normal, squirt sufficient engine oil on the piston head to prevent loss of compression temporarily and recheck. <i>Note (Added):</i> Be sure not to get on valves. Low compression brought up to normal by all sealing indicators piston ring or cylinder wear or damage. Low compression not brought up to normal by the method indicates valve or gasket leakage.
32	32	Coil and wiring. Inspect coil, ignition *** in like manner. <i>Note (Added):</i> Do not tighten wiring connectors unless actually loose as overtightening of terminals will cause damage.
47	47	Tires and rims (check stems and caps, condition, direction, watching spare tire carrier). Inspect as follows:
47	47	Tighten. Tighten all wheel *** lug nuts securely.
47	47	Service. With tires properly *** services are completed.
71	71	Transmission (mountings, axle, linkage). Note if transmission *** or excessive wear. (Added) Tighten. Tighten all transmission mounting and external assembly bolts and cap screws securely.
86	86	Toe-in and turning stops. With front wheels on ground and in a straight-ahead position, use a toe-in gage to determine if adjustment is as specified ($\frac{1}{4} \pm \frac{1}{16}$ in.). Turn wheels fully *** by higher echelon.

¹ The chart which reports on pages 85 through 86 is changed so that the "5,000 Miles" and "1,000 Miles" columns will read "5,000 Miles or 6 Months" and "1,000 Miles or 60 Days," as above.
² * Whenever occur first.

Table II. Organizational Mechanic or Maintenance Crew Preventive Maintenance Services—Continued

Intervals		Procedure
RUNN Miles: or 5 Months ¹	LODID Miles: or 60 Days ²	
88	88	<p>MAINTENANCE OPERATIONS—Continued (Added) Fifth wheel (bed plate and bolts). Observe the fifth wheel rocker plate and bed plate to see that they are in good condition, securely assembled, and mounted. Examine the king pin lock to see that it operates properly, locks securely, and that the kingpin is not extensively worn.</p> <p>Tighten. Tighten all assembly and mounting bolts.</p> <p>Caution: (Added) When the trailer is not attached, the fifth wheel should be covered to prevent accumulation of dirt.</p>
96	96	<p>Cab (doors, hardware, windshield and glass, top and frame, side curtains, seats, gun racks, and rails, floorboards, ventilators, platforms) Inspect applicable items *** and not damaged.</p> <p>Note: (Added) Glass, even if cracked or if laminated layers are separated, need not be replaced as unserviceable unless its condition constitutes a safety hazard or obscures vision of driver or crew.</p>
103	103	<p>Paint and markings. Examine paint of *** mountings if tarnished.</p> <p>Note: Some identification plates may be made of steel and rust very rapidly. When plates are found to be in poor condition, they should be cleaned thoroughly and heavily coated with application of clear lacquer.</p>
135	135	<p>Publications and Standard Form 21. The vehicle and equipment manuals, lubrication order, and Standard Form 21 (Operator's Report of Motor Vehicle Accident), should be present, legible, and properly stowed.</p>
141	141	<p>(Superseded) Modifications. Check DA AGO Form 478 to determine whether all modification work orders have been completed. A list of current modification work orders is contained in SR 310 20 4. Enter any modifications or major unit assembly replacements made during this service on DA AGO Form 478.</p>
		<p>UNUSUAL CONDITIONS (Added) Maintenance operations and road tests as prescribed under usual conditions will apply</p>

¹ The chart which appears on pages 85 through 104 is changed so that the "8,400 Miles" and "1,400 Miles" columns will read "6,000 Miles or 6 Months" and "1,400 Miles or 60 Days," as above.

² Whichever occurs first.

Table II. Organizational Mechanic or Maintenance Crew Preventive Maintenance Service. - Continued

Interval		Procedure
5,000 Miles ¹ or 5 Months ²	1,300 Miles ¹ or 60 Days ²	
		UNUSUAL CONDITIONS—Continued equally under unusual conditions for all occasions except in extreme cold weather. Intervals are necessarily shortened in extreme cold weather servicing and maintenance. Vehicles subjected to salt water immersion or complete submersion are evacuated to ordnance maintenance unit as soon as possible after the exposure (par. 16f.3)

¹ The OMS which appears on pages 75 through 106 is changed so that the "5,000 Miles" and "1,300 Miles" entries will read "5,000 Miles or 5 Months" and "1,300 Miles or 60 Days" as above.

² Whichever occurs first.

Section XI. VEHICLE MODIFICATION RECORDS

(Rescinded)

Section XII. PARTS, SPECIAL TOOLS, AND EQUIPMENT FOR ORGANIZATIONAL MAINTENANCE

(Superseded)

31. General

Tools, equipment, and spare parts are issued to the using organization for maintaining the matériel. Tools and equipment should not be used for purposes other than prescribed and, when not in use, should be properly stored in the chest and/or roll provided for them.

31.1 Parts

(Added)

Spare parts are supplied to the using organization for replacement of those parts most likely to become worn, broken, or otherwise un-serviceable, provided such operations are within the scope of organizational maintenance functions. Spare parts, tools, and equipment supplied for the 6-ton 6 x 6 truck (White, Corbitt, Ward La France, and Brockway) are listed in Department of the Army Supply Catalog ORD 7SNL G-512 (Corbitt Model 50SD6), SNL G-514 (White Model 666), SNL G-547 (Brockway and Ward La France), and SNL G-690 (White Model 666E), which are the authorities for requisitioning replacements.

31.2. Common Tools and Equipment

(Added)

Standard and commonly used tools and equipment having general application to this matériel are authorized for issue by the ORID 7 catalog and by T/A and T/O&E.

31.3. Special Tools and Equipment

(Added)

Certain tools and equipment, specially designed for organizational maintenance, repair, and general use with the matériel are listed in table III for information only. This list is not to be used for requisitioning replacements.

Table III. Special Tools and Equipment for Organizational Maintenance

Item	Identifying number	Reference		Use
		Fig.	Par.	
EYE, lifting, engine, 1/2 SAE (break (female)	41 E 629	27.1	60	Lifting engine.
PULLER, torque rod pin.	41-P-2956-8	27.1 122	112	Removing rear axle upper torque rod to frame support pin.
REMOVER, pin, torque rod (lower).	41-R-2372-555	27.1 125 126	113	Removing rear axle lower torque rod end pin.
REMOVER, pin, torque rod (upper and lower), wedge type.	41-R-2372-562	27.1 123 124	112 113	Removing torque rod and from torque rod pin.
WRENCH, tubular, angle end, hex, size of opening 1 1/4 in., lgh overall 13 in.	41 W 3009 150	27.1	59	Removing center cube adapter of the oil filter unit assembly.
WRENCH, wheel lug nut, dble. oct. 4 3/8 and 4 1/2 in.	41-W-3825-72	27.1 109	105	Removing bearing adjusting nuts and bearing jam nuts.

33. Engine

a. ENGINE WILL NOT TURN.

- (1) *Piston lock or seizure.* (Superseded) If the starter fails to rotate the crankshaft after using the ordinary engine starting procedure, do not attempt to rotate the crankshaft by towing the vehicle. Report condition to ordnance maintenance personnel.



Figure 87.4 Special tools for organizational maintenance.

59. Oil Filter Assembly

d. **MAINTENANCE OF OIL FILTERS.** The filter elements *** replace these units. Before insertion of cleaned or new elements, drain filter housings and wash entirely with dry-cleaning solvent or volatile mineral spirits paint thinner. After removing the wrapper of the new filter element and before using the element in the vehicle, thoroughly remove any wax coating, that may be present, with a clean cloth and dry-cleaning solvent or volatile mineral spirits paint thinner. Unless the wax coating is completely removed, it will be dissolved by the passage of oil through the element and be carried into oil lines where it will cause clogging. After insertion of *** with cap screws.

e. (Added) **REMOVAL OF OIL FILTER UNIT ASSEMBLY.** Remove retaining cap screw, cover, and element from filter unit. Remove the center tube adapter with single end tubular wrench 41-W-3059-150 and remove remainder of oil filter unit assembly. Each of the three oil filter unit assemblies is removed in the same manner.

f. (Added) **INSTALLATION OF FILTER UNIT ASSEMBLY.** Before installing the filter case, insert a new gasket in the base. Place the filter case and case retainer plate in position and fasten to base with the center tube adapter, tightening with single end tubular wrench 41-W-3059-150. Install element, cover, and retaining cap screw. Each of the three oil filter unit assemblies is installed in the same manner.

60. Removal of Engine Assembly

Note. (Added): Refer to paragraph 1c for information on coordination with an overhaul maintenance unit.

i. **ATTACH ENGINE HOISTING SLING EQUIPMENT** (fig. 47). Use four engine lifting eyes 41-E-629 to remove the engine. However, if the eyes are not available, an improvised tool (figs. 46 and 47) may be used as described below. Unscrew and remove *** check all fastenings.

The nomenclature on figure 48, RA PD 335009 Air Compressor Lines Installed, is changed as follows: "MAIN DISCHARGE LINE TO GOVERNOR" to "MAIN DISCHARGE LINE TO RESERVOIR."

72. Maintenance

c. (Superseded) Reverse flush the system as follows:

- (1) **Radiator.** Remove thermostat (par. 76), then remove radiator hoses, and install radiator cap. Attach a length of hose

to the radiator top connection. Attach a length of hose to the radiator lower connection and insert reverse flushing gun in this hose. Connect the water hose of the gun to a water tap and the air hose to a compressed air line. Turn on the water and when the radiator is full, turn on the air in short blasts. Allow radiator to fill with water between blasts of air. Continue this flushing until water from top hose runs clear.

- (2) *Cylinder Block.* Remove hose from cylinder block inlet and attach a length of hose to the inlet. Remove hose from water pump outlet and attach a length to the outlet. Insert gun in this hose. Repeat procedure described in (1) above.

75. Water Pump

e. (Added) **DEFECTIVE GREASE CUPS.** A constant leak in the water pump at the packing glands, in a large number of cases, has been found to be caused by a defective water pump grease cup. Failure of the grease cup to deliver lubricant to the water pump bearing, packing, and shaft results in the water pump packing running dry, excessive bearing wear, and eventually, a leak at the packing gland. To detect defective water pump grease cups, use the following procedure:

- (1) Remove both grease cup assemblies.
- (2) Fill grease cup with water pump grease.
- (3) Hold shank of the cup with a wrench and turn the cup with the fingers. If it is impossible to force lubricant out of open end of cup shank, discard the grease cup and replace with a new one. Follow the same procedure for testing before installing the new cup.

81. Distributor

e. MAINTENANCE AND ADJUSTMENT.

- (2) *Adjustments.*

- (d) (Added) When it is necessary to use a lower octane motor fuel than is prescribed, the distributor must be adjusted to eliminate heavy detonation. After checking the distributor points, retard the manual initial spark setting (par. 6) until a slight pinging is apparent under full-throttle and full-load conditions. When the proper octane number motor fuel is again available, reset the spark setting.

Note. In no case will a fuel of less than 85 octane number be used.

91. Clutch Removal

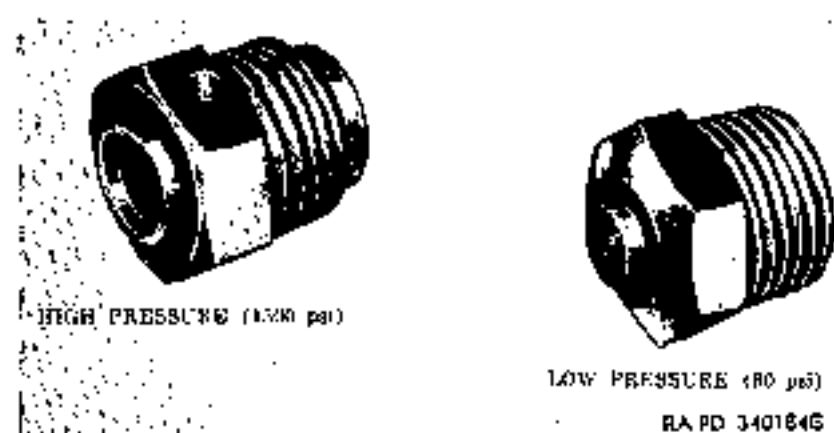
Note. (Added) Refer to paragraph 1c for information on coordination with an ordnance maintenance unit.

94. Removal of Transmission Assembly

Note. Refer to paragraph 1c for information on coordination with an ordnance maintenance unit.

99. Maintenance

b. (Added) The low pressure relief valve (fig. 96.1), used in propeller shafts of early models, relieves the lubricant before it is forced to the universal joint trunnion bearings. To correct this condition, the low pressure (80 psi) relief valve has been replaced by a high pressure (1,500 psi) valve. All low pressure relief valves found in universal joints of ordnance materiel in the field, should be replaced at the earliest practicable date. Low pressure relief valves found in new universal joint repair kits or in propeller shaft assemblies, should be changed before installing in the vehicle.



c. (Added) The lubricating gun adapter originally required for the lubrication of universal joints which cannot be reached with the hydraulic coupler on lubricating guns has an unsatisfactory metal sealing surface and cannot be locked to the coupler on the gun. A new hydraulic-to-push type lubricating gun adapter now is furnished with all ordnance materiel requiring it and will be requisitioned and used in place of the old type adapters.

102. Removal of Transfer Case Assembly

Note (Added): Refer to paragraph 1c for information on coordination with an ordnance maintenance unit.

105. Adjustments

b. TOE-IN ADJUSTMENT.

(1) Description. Toe-in, as its *** caused by camber. The proper toe-in is $\frac{1}{4} \pm \frac{1}{16}$ inch.

Figure 100 Tightening wheel bearing nut using wrench 41-W-2823-52.

106. Removal of Front Axle

Note. (Added): Refer to paragraph 1c for information on coordination with an ordnance maintenance unit.

112. Torque Rod Removal and Installation

b. REMOVE LOWER ROD. Disconnect outer end *** and anchor pin. Place remover 41-R-2372-562 between rod end and bracket (fig. 123) and drive in to loosen rod end from pin. Pull rod from *** rod from vehicle.

113. Removal of Rear Axles

Note. (Added): Refer to paragraph 1c for information on coordination with ordnance maintenance unit.

c. DISCONNECT UPPER TORQUE RODS. Bend back locking *** lock from pin. Pry torque rod from pin, using remover 41-R-2372-562 as shown (fig. 124). Repeat this operation *** rod outer end.

d. DISCONNECT LOWER TORQUE RODS. Remove collar pin *** and remove nut. Slip remover 41-R-2372-555 (figs. 125 and 126) over pin (as a puller). Screw inner nut *** and remove nut. Pull off washer and remover 41-R-2372-555, and lift off tapered dowel. Remove outside nut, *** rod outer end.

136. Windshield Wipers

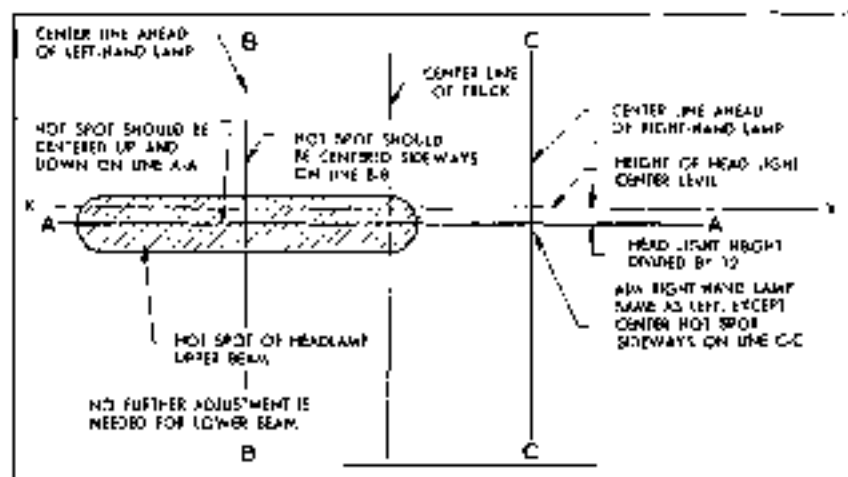
a. DESCRIPTION. (Superseded) The vehicle is equipped with dual windshield wipers which are operated by air pressure and mounted on

the upper frame of each windshield. Their operating speed is controlled by separate control knobs mounted on the dashboard. They are equipped with a lever for manual operation in case of mechanical failure.

Caution: A maximum wiper speed of not more than 60 cycles or 120 strokes per minute should be maintained at all times with the wiper blade and arm in position.

If the wiper speed is not correct, remove the wiper blade, wiper arm, and control knob and set the valve shaft to obtain a speed of 80 cycles per minute of wiper motor operation. After adjustment, install the control knob, wiper blade, and wiper arm.

Figure 160. Adjusting headlight.



RA PD 344344

Figure 160.2 (Added): Headlight adjustment.

146. Headlights

a. SERVICE HEADLIGHT.

- (5) (Added) *Aiming adjustment procedure (fig. 160.1).*
 - (a) Place unloaded truck on a smooth horizontal surface so that headlights are 25 feet away from a vertical wall or other vertical surface. The center line of the truck must be at right angles to the vertical surface.
 - (b) Measure the height of the headlight center from the floor and mark a horizontal line at this height on the vertical surface (line X-X, fig. 160.1).
 - (c) Mark line A-A, below X-X, at one-twelfth the distance between line X-X and the floor.

- (d) Draw vertical lines B-B and C-C directly in front of each headlight.
- (e) Turn on headlights at main light switch and select high beam with dimmer switch. It is not necessary to make adjustment on low beam.
- (f) Loosen headlight mounting bolt nut on each headlight. Cover one headlight and aim the other so that the center of the zone of greatest intensity (hot spot) is centered at the intersection of lines A-A and B-B or A-A and C-C, depending on which headlight is being aimed. Insert shims between light and mounting as necessary. Tighten the headlight mounting bolt nut securely, making sure adjustment is not disturbed. Aim the other headlight in the same manner.
- (g) After each headlight is aimed separately, check both headlights simultaneously for conformity to line A-A.

159. Removal

Note. (Added) Refer to paragraph 1c for information on coordination with an engine maintenance unit.

Section XXXIV.1 MAINTENANCE UNDER UNUSUAL CONDITIONS

(Added)

160.1 Extreme Cold Weather Maintenance

Refer to TM 9-2855 for a general discussion of maintenance problems, the application of antifreeze compounds and arctic-type lubrication, handling of storage batteries in extreme cold, and dewinterization procedure.

160.2 Extreme Hot Weather Maintenance

• COOLING SYSTEM. Thoroughly clean and flush the cooling system (par. 72) at frequent intervals and keep system filled to within a few inches of the over-flow pipe with clean water when operating in extremely high temperatures. Formation of scale and rust in the cooling system occurs more often during operation in extremely high temperatures, therefore, corrosion-inhibitor compound should always be added to the cooling liquid. Avoid the use of water that contains alkali or other substances which may cause scale and rust formations. Use soft water whenever possible.

6. BATTERIES.

- (1) *Electrolyte level.* In torrid zones, check level of electrolyte in cells daily and replenish, if necessary, with pure, distilled water. If this is not available, rain or drinking water may be used. However, continuous use of water with high mineral content eventually will cause damage to batteries and should be avoided.
- (2) *Specific gravity.* Batteries operating in torrid climates should have a weaker electrolyte than for temperate climates. The storage battery electrolyte (sulfuric acid, sp gr 1.280) will be diluted with pure, distilled water, as specified in TM 9-2857, to 1.200 to 1.240 specific gravity. This is the correct reading for a fully charged battery. This will prolong the life of the negative plates and separators. Under this condition, a battery should be recharged at about 1.160 specific gravity.
- (3) *Self-discharge.* A battery will self-discharge if left standing for long periods at high temperatures. This must be taken into consideration when operating in torrid zones. If necessary to park for several days, remove batteries and store in a cool place.

Note. Do not store acid-type storage batteries near stacks of tires, as the acid fumes have a deleterious effect on rubber.

c. CHASSIS AND BODY.

- (1) In hot, dry climates, a careful watch must be kept for evidence of the presence of moths and termites.
- (2) In hot, damp climates, corrosive action on all parts of the vehicle will occur and will be accelerated in areas of high humidity and during the rainy season. Evidences will appear in the form of rust and paint blisters on metal surfaces and mildew or fungi mold on fabrics, leather, and unpainted surfaces.
- (3) Protect all exposed exterior painted surfaces from the atmosphere by touch-up painting and protect unfinished exposed metal surfaces by a film of engine lubricating oil (OE-10). Cables and terminals will be protected by ignition-insulation compound.
- (4) Make frequent inspections of idle, inactive vehicles. Remove corrosion from exterior surfaces with abrasive paper or cloth and apply a protective coating of paint, oil, or suitable rust preventive.

160.3. Maintenance After Fording

a. **GENERAL.** Although all of the vehicle unit housings are vented to atmospheric pressure, with the exception of the steering gear and front axle spindles, and seals are provided which prevent the free flow of water into the housings, it must be realized that, due to the neces-

sary design of these assemblies, some water may enter, especially during submersion. It is advisable, therefore, that the following service be accomplished on all vehicles which have been exposed to some depth of water or completely submerged, especially in salt water, and precautions taken as soon as practicable to halt deterioration and avoid damage before the vehicle is driven extensively in regular road service.

b. CLEANING AND LUBRICATION.

- (1) *Body and chassis.* Drain and clean out body, engine, and tool components; clean all exposed unpainted parts and coat with film of engine lubricating oil (OE-10). Coat cables and terminals with ignition-insulation compound. In the case of assemblies which have to be disassembled for cleaning, perform these operations as soon as the situation permits or refer to ordnance maintenance unit. Lubricate the chassis thoroughly as directed in the lubrication order. Do more than the usual lubrication job, making sure that lubricant is generously forced into each bearing to force out any water present. Wheels will be removed for bearing cleaning and repacking in every case.
- (2) *Transmission and transfer case and axles.* Check the lubricant in the transmission, transfer case, and axle housings. Should there be evidence that water has entered, drain the housings and flush them thoroughly with a half-and-half mixture of oil (OE-10) and dry-cleaning solvent or volatile mineral spirits paint thinner. Locate and remedy the cause of the leak. Refill to filler plug level with the correct grade of lubricant.
- (3) *Wheels and brakes.*
 - (a) Remove the front wheels and flush out the knuckle housings with a half-and-half mixture of oil (OE-10) and dry-cleaning solvent or volatile mineral spirits paint thinner. Refill to filler plug level with the correct lubricant. Remove rear wheels. Wash all wheel bearings thoroughly with dry-cleaning solvent or volatile mineral spirits paint thinner, after which repack, assemble, and adjust them as outlined in paragraphs 105c and 109c.
 - (b) With wheels removed, dry out brake linings and clean rust and scum from brake drum face. Check wheel brake reservoirs for water.
- (4) *Steering gear.* Remove and disassemble steering gear. If the lubricant is contaminated, clean the housing thoroughly with a half-and-half mixture of oil (OE-10) and dry-cleaning solvent or volatile mineral spirits paint thinner. Assemble, refill with correct grade of lubricant, and adjust (par. 132).

(5) *Engine crankcase oil and oil filter.* Check the engine crankcase oil for presence of water. If water or sludge is found, drain, flush, and refill with the correct lubricant. Drain and clean oil filter if necessary.

(6) *Engine valve chamber.* Clean out engine valve chamber.

c. **BATTERIES.** Check the batteries for quantity and specific gravity of electrolyte to be sure no water entered through the vent caps. This is of special importance should the vehicle have been submerged in salt water. Add electrolyte and charge, if necessary.

d. **DISTRIBUTOR.** Remove the distributor cap and check to determine if any water has entered the distributor. If any water is present, remove the distributor for cleaning.

e. **ELECTRICAL CONNECTIONS.** Check all electrical connections for corrosion, particularly the bayonet-type connectors used in the various circuits.

f. **CARBURETOR BOWL, FUEL STRAINER, ETC.** Clean carburetor bowl, fuel strainer, pump, filter, tank, and lines as found necessary after inspection. If water is found in the air cleaners, clean and change the oil.

g. **ALUMINUM OR MAGNESIUM PARTS.** If vehicle remains in salt water for any appreciable length of time, aluminum or magnesium parts which were exposed to the water probably will be unfit for further use and must be replaced.

h. **CONDENSATION.** Although most units are sealed and vented, the sudden cooling of the warm interior air upon submersion may cause condensation, with resultant collection of moisture within the cases or instruments. A period of exposure to warm air after fording should eliminate this fault. Cases which can be opened may be uncovered and dried.

160.4. Maintenance After Operation on Unusual Terrain

a. **MUD.** Thorough cleaning and lubrication of all parts affected must be accomplished as soon as possible after operation in mud, particularly when a sea of liquid mud has been traversed. Clean out radiator fins and interior of engine compartment. Repack wheel bearings if necessary. Clean, oil, and stow tire chains in vehicle.

b. **SAND OR DUST.** Replace badly "frosted" windshield and door glasses. Repaint surfaces blasted by sand. Clean engine compartment. Lubricate vehicle completely to force out lubricants contaminated by sand, salt, or dust. Air cleaners and fuel and oil filters must be cleaned at least daily. Engine and other exposed vents should be covered with cloth.

Section XXXV. SHIPMENT AND TEMPORARY STORAGE (Rescinded)

PART THREE

SHIPMENT AND LIMITED STORAGE AND DESTRUCTION OF MATÉRIEL TO PREVENT ENEMY USE

(Added)

Section XXXVI. SHIPMENT AND LIMITED STORAGE

164. Domestic Shipping Instructions

a. **PREPARATION FOR SHIPMENT IN THE CONTINENTAL UNITED STATES.** When shipping the 6-ton 6 x 6 truck interstate or within the Continental United States, except directly to port of embarkation, the officer in charge of preparing the shipment will be responsible for furnishing vehicles to the carriers for transport in a serviceable condition, properly cleaned, preserved, painted, lubricated, etc. as prescribed in SB 9-4.

Note: For loading and blocking instructions of vehicles on freight cars, refer to paragraphs 166 and 167.

b. PREPARATION FOR SHIPMENT TO PORTS.

- (1) *Issue standards.* All vehicles destined to ports of embarkation must meet the requirements of TB OKD 385.
- (2) *Processing for shipment to ports.* All vehicles destined to ports of embarkation for oversea shipment will be further processed in accordance with SB 9-4.

Note: Ports of embarkation will supplement any necessary or previously omitted processing upon receipt of vehicle.

c. **REMOVAL OF PRESERVATIVES FOR SHIPMENT.** Personnel withdrawing vehicles from a limited storage status for domestic shipment must not remove preservatives, other than to insure that the matériel is complete and serviceable. If it has been determined that preservatives have been removed, they must be restored prior to domestic shipment. The removal of preservatives is the responsibility of depots, ports, or field installations (posts, camps, and stations) receiving the shipments.

d. **ARMY SHIPPING DOCUMENTS.** Prepare all Army shipping documents accompanying freight in accordance with TM 88-705.

165. Limited Storage Instructions

a. GENERAL.

- (1) Vehicles received for storage already processed for domestic shipment, as indicated on the vehicle processing record tag (DA AGO Form 9-3), must not be reprocessed unless the inspection performed on receipt of vehicles reveals corrosion, deterioration, etc.

- (2) Completely process vehicle upon receipt directly from manufacturing facilities or if the processing data recorded on the tag indicates that vehicle has been rendered ineffective by operation or freight shipping damage.
- (3) Vehicle to be prepared for limited storage must be given a limited technical inspection and be processed as prescribed in SB 9-63. The results and classification of vehicle will be entered on DA AGO Form 461-5.

b. RECEIVING INSPECTIONS.

- (1) Report of vehicles received for storage in a damaged condition or improperly prepared for shipment will be reported on DD Form 6 in accordance with SR 745 45 5.
- (2) When vehicles are inactivated, they are to be placed in a limited storage status for periods not to exceed 90 days. Stand-by storage for periods in excess of 90 days normally will be handled by ordnance maintenance personnel only.
- (3) Immediately upon receipt of vehicles for storage, they must be inspected and serviced as prescribed in section X. Perform a systematic inspection and replace or repair all missing or broken parts. If repairs are beyond the scope of the unit and the vehicles will be inactivated for an appreciable length of time, place vehicles in a limited storage status and attach tags to the vehicles specifying the repairs needed. The reports of these conditions will be submitted by the unit commander for action by an ordnance maintenance unit.

c. INSPECTIONS DURING STORAGE. Perform a visual inspection periodically to determine general condition. If corrosion is found on any part, remove the rust spots, clean, paint, and treat with the prescribed preservatives.

Note. Touch-up painting will be in accordance with TM 9-2851.

d. REMOVAL FROM LIMITED STORAGE.

- (1) If the vehicles are not shipped or issued upon expiration of the limited storage period, vehicles may either be processed for another limited storage period or be further treated for stand-by storage (vehicles inactivated for periods in excess of 90 days up to 3 years) by ordnance maintenance personnel.
- (2) If vehicles to be shipped will reach their destination within the scope of the limited storage period, they need not be re-processed upon removal from storage unless inspection reveals it to be necessary according to anticipated in-transit weather conditions.

Note. All vehicles that are to be reissued through the depot supply system to troops within the continental limits of the United States must meet the requirements of TB ORD 885. This is not required for reissues, exchanges, or redistribution among troop units where the depot supply system is not involved.

- (3) Deprocess vehicles when it has been ascertained that they are to be placed into immediate service. Remove all rust-preventive compounds as prescribed in section VI and thoroughly lubricate as prescribed in section VII. Inspect and service vehicles as prescribed in section X.
- (4) Repair and/or replace all items tagged in accordance with b(3) above.

c. **STORAGE SITE.** The preferred type of storage for vehicles is under cover in open sheds or warehouses, whenever possible. Where it is found necessary to store vehicles outdoors, the storage site must be selected in accordance with AR 700-105 and protected against the elements as prescribed in TB ORD 879.

166. Loading the 6-Ton 6 X 6 Truck for Rail Shipment

a. PREPARATION.

- (1) When vehicles are shipped by rail, every precaution must be taken to see that they are properly loaded and securely fastened and blocked to the floor of car. All on vehicle matériel (OVM) will be thoroughly cleaned, preserved, packed, and securely stowed in or on the vehicle for transit.
- (2) Prepare all vehicles for rail shipment in accordance with paragraph 164a. In addition, take the following precautions:
 - (a) Disconnect the truck battery to prevent its discharge by vandalism or accident. This is accomplished by disconnecting the positive lead, taping the end, and tying it back away from the battery.
 - (b) Apply the truck hand brake and place the transmission in neutral position after the vehicle has been finally spotted on the freight car. The vehicles must be loaded on the car in such a manner as to prevent the car from carrying an unbalanced load.
 - (c) Increase tire pressure slightly higher than normal, except where shipment is to be exposed to extremely hot weather conditions.

b. **TYPES OF CARS.** Instructions contained herein pertain to the loading of vehicles in gondola cars (open top cars having fixed sides, fixed or drop ends, and solid bottoms) and on flatcars (cars with wooden floors laid over sills and without sides or ends but equipped with stake pockets).

c. METHODS OF LOADING VEHICLES ON FREIGHT CARS.

(1) *Flatcar loading.*

- (a) When suitable hoisting equipment is not available for loading vehicles on or for subsequent unloading from a flatcar, an end ramp must be used in cases where the vehicle is not on a level with the flatcar deck. Vehicles on a ware-

house platform or loading dock can be pivoted over spanning platforms aboard a flatcar adjacent to the platform, then again pivoted into lateral position on the flatcar.

- (5) When unboxed vehicles must be loaded from ground level, a ramp may be improvised (fig. 165) by borrowing railroad ties normally found stacked in railroad yards and by procuring necessary planking. An end ramp is shown in place in figure 165.

Note. Railroad ties alone, stacked without deck planking and not securely anchored, provide a very unstable ramp and must be rearranged upon each successive use. The torque action of the wheels of self-propelled vehicles will tend to collect and collapse a simple stack of railroad ties and should, therefore, not be attempted except under conditions of extreme emergency.

- (6) To accomplish loading, the vehicle is towed onto the improvised apron at base of ramp and unhitched. Using a cable laid along the center line of the flatcar, attached to vehicle, the vehicle is pivoted to point towards the ramp. A chock behind one wheel of the vehicle will prevent undesirable rearward travel and assist pivoting.

Caution: Personnel used to assist in pivoting the vehicle into position must be careful to avoid injury by the violent side-whipping likely to occur when strain is applied to the cable. Follow up forward movement of the vehicle by chocking behind one wheel on the ramp.

- (7) For powering the towing cable, a vehicle with winch is spotted at right angles to the train. It is located at about the third or fourth flatcar to facilitate signaling and because of cable length limits. A single-sheave snatch block located between cars on the train center line will provide the necessary lateral pull. A vehicle passing this point can be towed by a vehicle on the ground with personnel guiding its passage. A long tow cable from the towing vehicle will lessen the tendency of the towed vehicle to stray from the center line of the train.

Note. The snatch block fastening chain must be lashed to an adjacent solidly fixed object or stake to offset the cross pull of the powered winch (fig. 167).

- (8) After the first vehicle is loaded on the flatcar, additional vehicles may be similarly hauled aboard by passing the towing cable beneath the loaded vehicle. When a train of flatcars is being loaded, steel or wooden spanning platforms or bridges are used to cover the gap between cars. Flatcar brake wheels must first be lowered to floor level to permit passage. A pair of improvised spanning platforms are shown in place in figure 165. These spanning platforms are moved along the train by hand as the vehicle advances.

- (f) The above method of train loading requires careful advance planning as to the order of loading, so that vehicles are arranged on each flatcar under prescribed methods and combinations.

(2) *Gondola car loading.*

- (a) Fixed-end gondola cars may only be loaded when hoisting facilities are available for initial loading and for unloading at destination. Hopper- or drop-bottom gondola cars without false flooring and hoisting facilities are not to be used for shipments of unboxed vehicles.
- (b) Drop-end gondola cars may be loaded exactly as described for flatcars ((1) above). Height of fixed sides is immaterial. Vehicles may progress through a gondola car by passing over the two inwardly-dropped ends and over spanning platforms. Vehicles selected to remain in a gondola car are first moved to the closed end of the car, then spread out for blocking after the remaining end is closed and latched.

Note. Do not block vehicle flush against ends of gondola car. When ordering gondola cars, specify inside width required as some may be received with gussets along the inner sides which affect clearance.

(3) *Loading ramp.*

- (a) A ramp for end-loading of vehicles on open top freight cars may be improvised when no permanent ramps or hoisting facilities are available. A ramp suitable for the loading of most ordnance items is shown in figures 165 and 166. For loading the 6-ton 6 x 8 truck, the width of the ramp may be reduced to two double-plank runways, each cleated together. Length of planking must be determined with consideration to underchassis clearance, in order to clear the hump at upper end of ramp.

Caution: Personnel guiding the vehicle up the ramp must exercise care when working close to the edges of the ramp planking.

- (b) The car bearing the ramp must be securely blocked against rolling, particularly when the car brakes are not applied as in train loading. Successive cars must remain coupled and be additionally chocked at several points along the train when ground towing of vehicles aboard the train is being effected.
- (c) Whenever the freight cars are not on an isolated track or blocked siding, each end approach to the train must be posted with a blue flag or light to advise that men are at work and that the siding may not be entered beyond those points.

NOTES

- 1 RAMP SHOWS 15% CAPACITY OF LARGEST END LOADING FREIGHT CAR FOR LESSEY LOADS - REDUCE NUMBER OF RAMP PLANKS
- 2 WIDTH DETERMINED BY TREAD OF MATERIAL BEING LOADED
- 3 FOR LOADING TWO WHEELED ARTILLERY TRAILERS OR 3-PORT WHEELBASE MATERIAL, RAMP PLANKS MAY BE SHORTER
- 4 CAUTION - WHEN RAMP IS 100% FULL, UNDERPINNING OF MATERIAL WILL STRIKE END OF RAMP TRAILERS AND/OR
- 5 OPENING AT CENTER MAY BE FILLED UP TO THE CAR COUPLER TO AVOID INJURY TO MAN/VEHICLE/MATERIAL
- 6 FOR LOADS OVER 40 TONS, WINDUPTHING OF FLATCAR MUST BE BLOCKED UP TO AVOID TIPPING OF FLATCAR
- 7 THIS TYPE RAMP IS ADAPTABLE TO ENGINE CONTROL AND AUTO END/DRAW BOX CAR LOADING
- 8 WHEN LOADING AN AUTO END/DRAW BOX CAR IT MAY BE NECESSARY TO LOAD A FLATCAR COUPLED TO THE BOX CAR TO GAIN OVERHEAD LOADING CLEARANCE
- 9 WHEN LOADING BY WIRELESS CABLE, MATERIAL AT PLATFORM TO TRAIN, USING A SLIDING FLATCAR AT POINT OF PICK UP MUST BE LASHED TO ADJACENT RAILS CAR, OR OTHER FIXED OBJECT.

GA PD 117513

TITLE OF MATERIAL FOR RAMP AS ILLUSTRATED					
PART NO.	QUANT. REQD.	PART NAME	LENGTH	WIDTH	THICKNESS
1	1	RAMP PLANK	20 ft	11 in.	3 in.
2	5	GUIDE RAILS	20 ft	8 in.	2 in.
3	3	TIE STRIPS	4 ft	8 in.	1 in.
4	2	CLUTS	18 in.	8 in.	2 in.
5	1	CLUT	54 in.	2 ft	3 in.
6	2	RAILROAD TIES	8	3 ft	8 in.
7	AS REQD.	FILLERS	AS REQD.	12 ft	1 in.
8	AS REQD.	WIPERS (FOR 90 LIT)	AS REQD.	12 ft	1 in.
9	1	STOPDOWN PLATE	8 ft	4 ft	4 in.
10	1	STOPDOWN PLATE	8 ft	6 in.	2 in.
11	1	STOPDOWN PLATE	8 ft	6 ft	1 in.
12	1	CHECK COUPLER	AS REQD.	4 ft	4 in.
13	AS REQD.	SPRINGS	AS REQD.	12 ft	1 in.
14	AS REQD.	GROUND BURNAGE	AS REQD.		

Figure 166. Layout for figure 163.

SINGLE SLAVE SNATCH HOOK SUPPORTED ON A 2" X 6" X 48" PLANK BRIDGING THE GAP BETWEEN CARS.

TRANSVERSE PULL OF WINCH TAKEN UP BY ANCHORING TO STAKE OR NEIGHBORING OBJECT.

FLATCARS NO. 4 NO. 5

CAR CHOCK

ARRANGEMENT OF WINCH AND BLOCK FOR LOADING MATERIAL ON OPEN TOP FREIGHT CARS USING END LOADING RAMP.
(FORWARD FLATCARS OMITTED TO SHOW RIDGING)

RA PD 115832

Figure 167. Method of securing the towing cable.

- (d) Upon completion of the loading operation, the ramp planks and bridging devices should be loaded on the train for use in unloading operations. Random sizes of timbers used in building the approach apron up to rail level should be included. All materials should be securely fastened to the car floors, after vehicles are blocked in place, and entered upon the bill of lading (B/L). Railroad ties borrowed for the operation should not be forwarded to the unloading point unless specifically required and only with the consent of the owner.

J. LOADING RULES. For general loading rules pertaining to rail shipment of Ordnance vehicles, refer to TB 9-OSSC-G.

Warning: The height and width of vehicles when prepared for rail transportation must not exceed the limitations indicated by the loading table as prescribed in AR 700-105, section II. Whenever possible, local transportation officers must be consulted about the limitations of the particular railroad lines to be used for the movement to avoid delays, danger, or damage to equipment.

167. Blocking the 6-Ton 6 X 6 Truck for Rail Shipment

n. GENERAL. All blocking instructions specified herein are minimum and are in accordance with the Association of American Railroads "Rules Governing the Loading of Commodities on Open Top Cars." Additional blocking may be added as required at the discretion of the officer in charge. Double-headed nails may be used if available, except in the lower piece of two-piece cleats. All item reference letters given below refer to the details and locations as shown in figure 168.

Note. Any loading methods or instructions developed by any source which appear in conflict with this publication or existing loading rules of the carriers must be submitted to the Chief of Ordnance, Washington 25, D. C. for approval.

b. BRAKE WHEEL CLEARANCE "A." Load trucks on flatcars with a minimum clearance of at least 4 inches below and 6 inches above, behind, and to each side of the brake wheel (fig. 168). Increase clearance as much as is consistent with proper location of load.

Note. Vehicles should be laterally spotted on flatcar so that wheels are centrally positioned between stake pockets in order that wheel strapping "G" (a below) provides uniform cross wiring.

c. CHOCK BLOCKS "B" (6 X 8 X 24 INCHES, 12 REQUIRED PER TRUCK). Locate the 45° face of blocks against the front and rear of front wheels, in front of each intermediate wheel, and in back of each rear wheel. Blocks are to be positioned in such a manner as to allow flush application of wheel side cleats "D" (a below) when nailed to chock blocks. Nail heel of blocks to car floor with three forty-penny nails and toenail both sides of blocks to car floor with two forty-penny nails each.

Note. Chock blocks may be cut from timbers (or railroad ties, when available) as shown in figure 169.

d. CUSHIONING MATERIAL "C." Locate suitable cushioning material, such as waterproof paper, burlap, etc. between tires and cleats "D." The cushioning material should protrude beyond cleats "E" at floor and above cleats "D."

e. WHEEL SIDE CLEATS "D" (FRONT WHEELS, 1 X 8 X 50 INCHES; REAR WHEELS, 1 X 9 X 96 INCHES; TWO OF EACH REQUIRED). Locate and nail cleats "D" to chock blocks "B" with four tenpenny nails at each end.

f. FLOOR SIDE CLEATS "E" (2 X 4 X 42 INCHES, 12 REQUIRED PER TRUCK). Locate two floor side cleats against each wheel side cleat "D" with cushioning material protruding underneath cleat. Nail lower cleats to ear floor with four thirtypenny nails and upper cleats to lower cleats and ear floor with four forty-penny nails.

g. CROSS CLEATS "F" (2 X 4 INCHES, LENGTH TO SUIT, FOUR REQUIRED PER TRUCK). Locate two cleats across the top of the front chock blocks and two cleats across the rear chock blocks. Nail lower cleats to the top of chock blocks with two thirtypenny nails at each end. Nail upper cleats to the lower cleats and top of chock blocks with two forty-penny nails, staggered at each end.

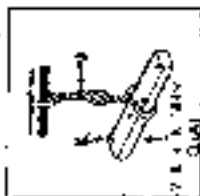
h. WHEEL STRAPPING "G" (NO. 8 GAGE BLACK ANNEALED WIRE, LENGTH TO SUIT).

Note. For gondola car loading, wheel strapping will not be required.

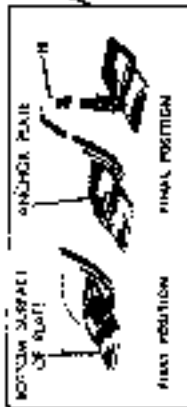
- (1) *Front wheels.* Form a cable by twist-tying four strands of wire together. Pass cable through ventilating hole in upper part of front wheel slightly forward of center and out through adjacent ventilating hole. Pass the other end of the cable through a stake pocket rearward of front wheel. Form a 6-inch loop in the end by winding each of the four wires tightly around the cable a few turns. Position the loop midway between the wheel and stake pocket. Pass the free end of the cable through the loop, hand tighten, and again wind the ends of the wires around their cable tightly to form another loop. Place a random length 2 x 2-inch cleat between cables. Insert a tightening tool at center of cable and twist just taut enough to remove all slack. Withdraw tightening tool, leaving cleat in cable to maintain an aperture for tightening cable during transit. Form another cable and pass through ventilating hole at upper part of front wheel slightly rearward of center and out through adjacent ventilating hole, crossing initial cable. Pass other end of cable through a stake pocket forward of front wheel. Complete and twist-tie as described above. Repeat above operations for the other front wheel.



DETAIL 1
METHOD OF STRAPPING
FOR WHEEL WARE

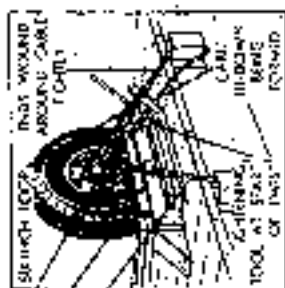
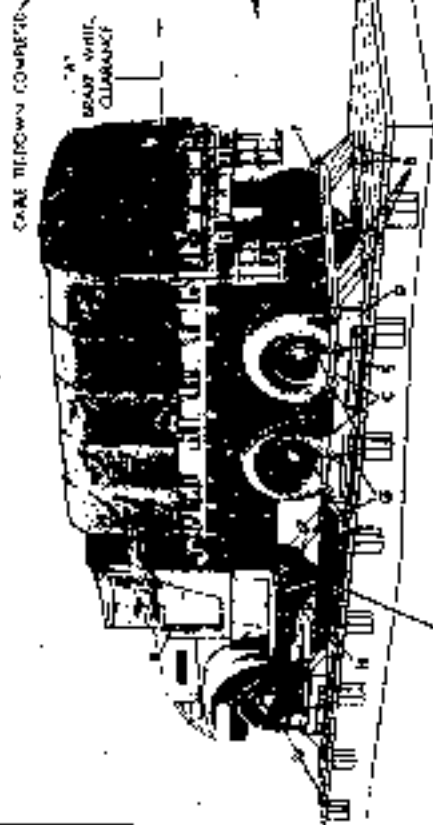


DETAIL 2
ALTERNATE METHOD
OF STRAPPING WHEELS

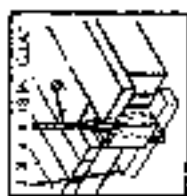


DETAIL 3
METHOD OF STRAPPING ANCHOR PLATE (ABLE STRAPPING
NOT PERMITTED FOR BLOCKING OPTIONAL FOR PLATE)

7-45 SHO PASSES THROUGH HEAD LOCK FORMING A SECOND LOOP WITH HOOKS TO SECURE CABLE. RANDOM LENGTH 2 X 2 RUN BLOCK LEFT IN PLACE AFTER DRUM BEGINNING TO ROTATE IN TURN DURING TIGHTENING FOOT APPLIED. FOR SUFFICIENT TIGHTENING OBTAINED BY TURN DUMP.



DETAIL 4
METHOD OF TIGHTENING
WHEEL STRAPPING

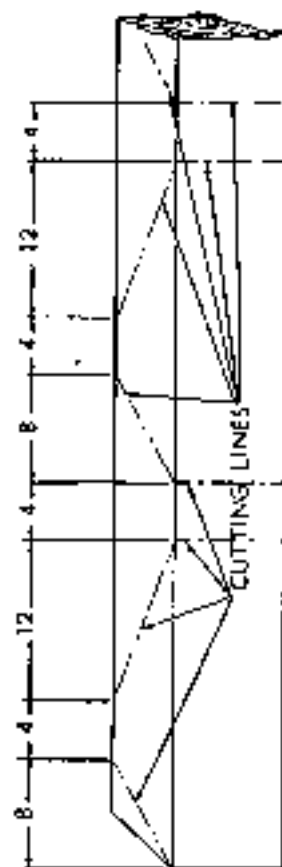


DETAIL 5
WHEEL STRAP
POCKET LASHING

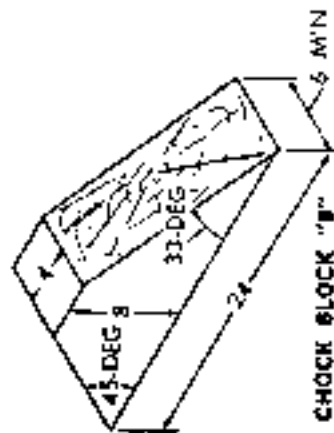
NOTE: 1 THE 6-TON 2 X 2 TRUCK SHOWN HAS NOT BEEN REDESIGNED FOR DOMESTIC FREIGHT SHIPMENT BUT SIMPLY ILLUSTRATE METHOD OF BLOCKING.
2 THE DIFFERENCE BETWEEN THESE TWO PROCEDURES IS THAT
LARGER VEHICLES HAVING 30-40 DISS WHEELS STRAPPING WILL BE PERMITTED IN A SIMILAR MANNER TO SLACK ROCKETS AND ATTACHED TO WHEELS. IT MAY BE AS SHOWN IN DETAIL 1.

SAFO 115477A

Figure 160 Method of blocking 6-ton 6 X 8 truck for rail shipment.

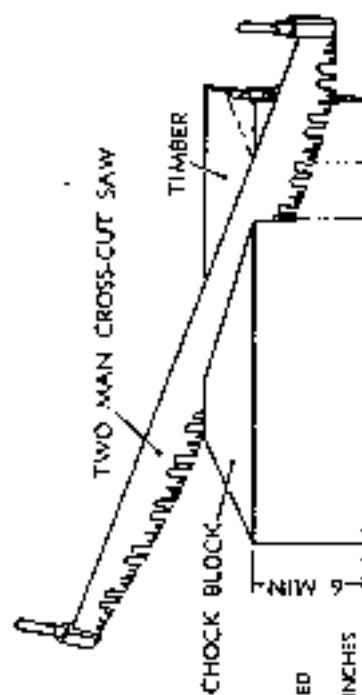


METHOD OF MARKING TIMBER
FOR CUTTING CHOCK BLOCKS



CHOCK BLOCK "B"

- NOTES: 1—RAILROAD TIES MAY BE SUBSTITUTED
FOR TIMBERS WHEN AVAILABLE
2—ALL DIMENSIONS SHOWN ARE IN INCHES



RA PD 115B246

Figure 168. Chocking chock blocks from timbers.

- (2) *Rear and intermediate wheels.* Each outside rear and intermediate wheel will be cross-cabled to stake pocket as prescribed for the front wheel (11) above and fig. 168)

Note: Cables are passed through stake pockets in such a manner that the cable loop lays against the car frame. A short stake driven into the stake pocket will protect the cable loop from chafing and loosening. (This stake is omitted in fig. 168.) When flatcars which are provided with well-type stake pockets are received, a loop of the strapping cable is passed through the stake pocket and a short piece of wood, about 2 x 4 x 18 inches, is inserted in the loop below the stake pocket. Subsequent tightening of the strapping will cause the cable to draw the wooden block securely against the bottom of the stake pocket.

i. **AXLE STRAPPING "H."** Locate two pieces of $1\frac{1}{4}$ x 0.035-inch hot-rolled steel strapping over each axle close to brakes. Coil strapping around steel anchor plates as shown in figure 168. Secure by nailing anchor plates to car floor with not less than six twentyponny nails (double-headed nails preferred). As an alternate method of securing axles, form and substitute a cable "J," consisting of four strands of No. 8 gage black annealed wire or wires of equivalent strength, at each location for steel strapping "H." Pass cables over axle and around wooden cleats "K" (2 x 4 x 18 inches). Locate cleats lengthwise of car and nail to car floor with four thirtypenny nails in each cleat. As in *k*(1) above, join both ends of cable together, twist, and tighten with rod or bolt just taut enough to take up slack (fig. 168 inset).

Section XXXVII. DESTRUCTION OF MATÉRIEL TO PREVENT ENEMY USE

168. General

a. Destruction of the vehicle and equipment, when subject to capture or abandonment in the combat zone, will be undertaken by the using arm only when, in the judgment of the unit commander concerned, such action is necessary in accordance with orders of, or policy established by, the army commander.

b. The information which follows is for guidance only. Certain of the procedures outlined require the use of explosives and incendiary grenades which normally may not be authorized items for the vehicle. The issue of these and related materials, and the conditions under which destruction will be effected, are command decisions in each case, according to the tactical situation. Of the several means of destruction, those most generally applicable are:

- Mechanical - Requires ax, pick, mattock, sledge, crowbar, or similar implement.
- Burning - Requires gasoline, oil, incendiary grenades, or other inflammables.
- Demolition - Requires suitable explosives or ammunition.

- Gunfire** Includes artillery, machine guns, rifles using rifle grenades, and launchers using antitank rockets. Under some circumstances hand grenades may be used.

In general, destruction of essential parts followed by burning usually will be sufficient to render the matériel useless. However, selection of the particular method of destruction requires imagination and resourcefulness in the utilization of the facilities at hand under the existing conditions. Time usually is critical.

c. If destruction to prevent enemy use is resorted to, the matériel must be so badly damaged that it cannot be restored to a usable condition in the combat zone, either by repair or cannibalization. Adequate destruction requires that all parts essential to the operation of the matériel, including essential spare parts, be destroyed or damaged beyond repair. However, when lack of time and personnel prevents destruction of all parts, priority is given to the destruction of those parts most difficult to replace. Equally important, the same essential parts must be destroyed on all like matériel so that the enemy cannot construct one complete unit from several damaged ones.

- d. If destruction is directed, due consideration should be given to -
- (1) Selection of a point of destruction that will cause greatest obstruction to enemy movement and also prevent hazard to friendly troops from fragments or ricocheting projectiles which may occur incidental to the destruction.
 - (2) Observance of appropriate safety precautions.

169. Destruction of the 6-Ton 6 X 6 Truck

a. METHOD NO. 1 BY BURNING.

- (1) Remove and empty portable fire extinguishers.
- (2) Puncture fuel tank as near the bottom as possible, collecting gasoline for use as outlined in (5) below. Puncture the crane fuel tank on the crane truck.
- (3) Using an ax, pick mattock, sledge, or other heavy implement, smash all vital elements such as radiator, distributor, carburetor, generator, ignition coil, fuel pump, batteries, spark plugs, air cleaner, lights, instruments, and air compressor. On the bridge erection truck, also smash the auxiliary air compressor and boom operating controls. On the crane truck, also smash the vital elements on the crane motor and boom operating controls. If time permits and a sufficiently heavy implement is available, smash the engine cylinder block and head, crankcase, transmission, and winch and hoist mechanisms.
- (4) Slash tires. Exercise care to prevent injury from inflated tires blowing out while being slashed. Whenever practicable, usually it is preferable to deflate tires before slashing.

- (5) Pour gasoline and oil over the wheels, brakes, and electrical wiring and then ignite. If gasoline and oil are not available, use incendiary grenades. If gasoline, oil, and incendiary grenades are available, a combination of them may be used. Elapsed time: about 5 minutes.

Caution: Due consideration should be given to the highly inflammable nature of gasoline and its vapor. Carelessness may result in painful burns.

5. METHOD NO. 2 WITH DEMOLITION MATERIALS.

- (1) Remove and empty portable fire extinguishers.
 (2) Puncture fuel tank. Puncture crane fuel tank on the crane truck.
 (3) Prepare demolition charges.
 (a) Prepare and place the number of 2-lb charges of explosive (two 1-lb blocks of TNT or equivalent) per charge) for destruction of the particular model of vehicle as indicated below:

<i>Model of vehicle</i>	<i>No. of charges</i>	<i>Location of charges</i>
Prime mover cargo truck	2	Set one charge on top of the clutch housing; set the second charge as low on the left side of the engine as possible.
Bridge erection truck	3	Set one charge on top of the clutch housing; set the second charge as low on the left side of the engine as possible; set the third charge on the hydraulic pump.
Crane truck	4	Set one charge on top of the clutch housing; set the second charge as low on the left side of the engine as possible; set the third charge as low as possible on the left side of the crane engine; set the fourth charge on the crane hoist gears.

- (b) Connect the charges for simultaneous detonation with detonating cord. Provide for dual priming to minimize the possibility of a misfire. For priming, either a nonelectric blasting cap crimped to at least 5 feet of safety fuse (safety fuse burns at the rate of 1 foot in 30 to 45 seconds; test before using) or an electric blasting cap and firing wire may be used. The safety fuse, which contains black powder, and blasting caps must be protected from moisture at all times. The safety fuse may be ignited by a fuse lighter or a match; the electric blasting cap requires a blasting machine or equivalent source of electricity.

Caution: Keep the blasting caps, detonating cord, and safety fuse separated from the charges until required for use.

Note. For the successful execution of methods of destruction involving the use of demolition materials, all personnel concerned will be thoroughly familiar with the pertinent provisions of FM 5-25. Training and careful planning are essential.

- (4) Destroy the tires by placing an incendiary grenade under each tire. The detonation of the explosive charges should be delayed until the incendiary fires are well started. This will prevent the fires from being extinguished by the blast when the charges are detonated.
 - (5) Detonate the charges. If primed with nonelectric blasting cap and safety fuse, ignite and take cover. If primed with electric blasting cap, take cover before firing. Elapsed time: about 6 minutes.
- c. **METHOD No. 3—BY GUNFIRE.**
- (1) Remove and empty portable fire extinguishers.
 - (2) Puncture fuel tank. Puncture the crane fuel tank on the crane truck.
 - (3) Destroy the tires as in method No. 1 or 2 above.
 - (4) Destroy the vehicle by gunfire using artillery and machine guns, by rifles using rifle grenades, or by launchers using anti-tank rockets. Fire on the vehicle, aiming at the engine, axles, wheels, and body; fire on the crane of the crane truck, aiming at the engine, body, and boom. Although one well placed direct hit may destroy the vehicle, several hits usually are required for complete destruction unless an intense fire is started, in which case the vehicle may be considered destroyed. Elapsed time: about 6 minutes.

Caution: Firing at ranges of 500 yards or less should be from cover. ||

REFERENCES

(Revised)

APPENDIX

REFERENCES

(Added)

1. Publication Indexes

The following publication indexes and lists of current issue should be consulted frequently for latest changes or revisions of references given in this appendix and for new publications relating to matériel covered in this manual:

Index of Administrative Publications ..	SR 310-20-5
Index of Army Motion Pictures and Film Strips.....	SR 110-1-1

Index of Army Training Publications	SR 310-20-3
Index of Blank Forms and Army Personnel Classification Tests	SR 310-20-6
Index of Technical Manuals, Technical Regulations, Technical Bulletins, Supply Bulletins, Lubrication Orders, Modification Work Orders, Tables of Organization and Equipment, Reduction Tables, Tables of Allowances, Tables of Organization, Tables of Equipment, and Tables of Basic Allowances	SR 310-20-4
Introduction and Index (supply catalogs)	ORD 1
Military Training Aids	FM 21-8

2. Supply Catalogs

The following catalogs of the Department of the Army Supply Catalog pertain to this matériel:

c. AMMUNITION.

Ammunition, Rifle, Carbine, and Automatic Gun ORD 11 SNL T 1

b. ARMAMENT.

Gun, Machine, Cal. 30, Browning, M1919A4, Fixed and Flexible; M1919A5, Fixed; and M1919A6; and Ground Mounts..... ORD (*) SNL A-6

Gun, Machine, Cal. 50, Browning, M2, Heavy Barrel, Fixed and Flexible; and Ground Mounts..... ORD (*) SNL A-39

Mount, Truck, M32, M36, M37, M37A1, M37A2, M37A3, and M50; Mount, Ring, M49, M49A1, M49A1C, and M49C ... ORD (*) SNL A-55, Section 19

Mount, Truck, M57 ORD (*) SNL A-55, Section 51

Mount, Truck, M58 ORD (*) SNL A-55, Section 52

c. DESTRUCTION TO PREVENT ENEMY USE.

Land Mines and Fuzes, Demolition Material, and Ammunition for Smokeless Artillery and Grenade Fire ORD 11 SNL R 7

d. MAINTENANCE AND REPAIR.

Cleaners, Preservatives, Lubricants, Re-coil Fluids, Special Oils, and Related Maintenance Materials ORD 9 SNL K-1

(*) See Ord 1 for published catalogs of the various sections of the Department of the Army Supply Catalog.

Items of Soldering, Metallizing, Brazing, and Welding Materials: Gases and Related Items	ORD 8 SNL K-2
Lubricating Equipment, Accessories, and Related Dispensers	ORD (*) SNL K 3
Tool-Sets (Common), Specialists' and Organizational	ORD 6 SNL G-27, Sec 2

d. VEHICLE.

Truck, 6-Ton, 6 x 6 (Corbett, Model 50SD0)	ORD (*) SNL G-512
Truck, 6-Ton, 6 x 6 (White, Model 606)	ORD (*) SNL G-514
Truck, 6-Ton, 6 x 6 (Brockway and Ward La France)	ORD (*) SNL G-547
Truck, 6-Ton, 6 x 6, Cargo (Treadway) w/winch (Bridge Erecting) (White, Model 606E)	ORD (*) SNL G-600

3. Forms

The following forms pertain to this matériel:

- Standard Form 51, Operator's Report of Motor Vehicle Accident.
- Standard Form 91A, Transcript of Operator's Report of Motor Vehicle Accident.
- Standard Form 93, Report of Investigating Officer.
- Standard Form 94, Statement of Witness.
- DA Form 30b, Report of Claims Officer.
- DA AGO Form 9 3, Processing Record for Storage and Shipment.
- DA AGO Form 9 68, Spot Check Inspection Report for Wheeled and Half-Track Vehicles
- DA AGO Form 9-74, Motor Vehicle Operator's Permit
- DA AGO Form 9 75, Daily Dispatching Record of Motor Vehicles
- DA AGO Form 318, Driver Qualification Record
- DA AGO Form 400, Preventive Maintenance Roster.
- DA AGO Form 401, Work Sheet for Wheeled and Half-Track Vehicles Preventive Maintenance Service and Technical Inspection.
- DA AGO Form 402 5, Limited Technical Inspection.
- DA AGO Form 408, Unsatisfactory Equipment Report.
- DA AGO Form 478, MWO and Major Unit Assembly Replacement Record and Organizational Equipment File.
- DA AGO Form 811, Work Request and Job Order.
- DA AGO Form 811-1, Work Request and Hand Receipt.
- DD Form 6, Report of Damaged or Improper Shipment.
- DD Form 110, Vehicle and Equipment Organizational Record.
- DD Form 317, Preventive Maintenance Service Due (Sticker).

(*) See Ord 4 for published catalogs of the armance section of the Department of the Army Supply Catalog.

4. Other Publications

The following explanatory publications contain information pertinent to this matériel and associated equipment:

- a. **AMMUNITION.**
Regulations for Firing Ammunition for Training,
Target Practice, and Combat SR 355-819-1
- b. **ARMAMENT.**
Browning Machine Gun, Cal.30, M1917A1,
M1919A4, and M1919A6 FM 23-55
Browning Machine Gun, Cal.50, HB, M2 FM 23-65
Machine Gun Mounts for Trucks TM 9-224
- c. **CAMOUFLAGE.**
Camouflage TM 5-267
Camouflage, Basic Principles FM 5-20
Camouflage of Vehicles FM 5-20B
- d. **DECONTAMINATION.**
Decontamination TM 9-220
Decontamination of Armored Force Vehicles FM 17-59
Defense Against Chemical Attack FM 21-40
- e. **DESTRUCTION TO PREVENT ENEMY USE.**
Explosives and Demolitions FM 5-25
- f. **GENERAL.**
Cooling Systems: Vehicles and Powered Ground
Equipment TM 9-265B
Lever Selection, Training, and Supervision,
Wheeled Vehicles TM 21-309
Driver's Manual TM 21-305
Instruction Guide: Operation and Maintenance
of Ordnance Matériel in Extreme Cold (0° to
-65° F.) TM 9-2855
Motor Transport FM 25-16
Motor Vehicles AR 590-105
Mountain Operations FM 73-10
Operations in Snow and Extreme Cold FM 70-15
Precautions in Handling Gasoline AR 850-20
Principles of Automotive Vehicles TM 9-2790
Spark Plugs TB ORD 313
Storage Batteries—Lead-Acid Type TM 9-2857
Supplies and Equipment General Unsatisfac-
tory Equipment Report SR 799-45-5
Reports of Accident Experience SR 885-10-40
- g. **MAINTENANCE AND REPAIR.**
Maintenance Responsibilities and Shop Operation AR 750-6
Cleaning, Preserving, Sealing, and Related Ma-
terials Issued for Ordnance Matériel TM 9-2850

Hand, Measuring, and Power Tools	TM 10-580
Lubrication Order	LO 9-813
Maintenance and Care of Hand Tools	TM 9-887
Maintenance and Care of Pneumatic Tires and Rubber Treads	TM 31 210
Motor Vehicle Inspection and Preventive Main- tenance Services	TM 37 2810
Painting Instructions for Field Use	TM 9 2851
Preparation of Ordnance Matériel for Deep Wa- ter Forging	TM 9-2852
h SHIPMENT AND LIMITED STORAGE.	
Army Marking Directive	TM 38-414
Army Shipping Document	TM 38-705
Inspection, Preservation, and Maintenance in Storage of Small Arms Matériel	SB 9-65
Instruction Guide: Ordnance Packaging and Ship- ping (Posts, Camps, and Stations)	TM 9-2854
Ordnance Storage and Shipment Chart—Group G	TB 9-OSSC-G
Preparation of Unboxed Ordnance Matériel for Shipment	SB 9-4
Protection of Ordnance General Supplies in Open Storage	TB ORD 379
Shipment of Supplies and Equipment: Report of Damaged or Improper Shipment	SR 745-45-5
Standards for Oversea Shipment and Domestic Issue of Ordnance Matériel Other Than Ammu- nition and Army Aircraft	TB ORD 365
Storage, Inspection, and Issue of Unboxed Serv- iceable Motor Vehicles, Preparation of Unserv- iceable Vehicles for Storage; and Deprocessing of Matériel Prior to Operation	SB 9-63

BY ORDER OF THE SECRETARY OF THE ARMY:

OFFICIAL:

Wm. E. BERGIN
Major General, USA
Acting The Adjutant General

J. LAWTON COLLINS

Chief of Staff, United States Army

DISTRIBUTION:

Army:

Tech Svc (2) except 9 (26); Arm & Svc Bd (2); AFF (2);
AA Comd (2); OS Maj Comd (10); Base Comd (2);
MDW (3); Log Comd (5); A (20); CHQ (2); D (2); R 9
(2); Bn 9 (2); C 9 (2); FC (2); Sch (5) except 9 (50); Gen
Dep (2); Dep 9 (10); PE (Ord O) (5); OSD (2); PG 9 (10);
Ars 9 (10); Dist 9 (10); One (1) copy to each of the follow-
ing T/O&E's: 5-47, 5-52, 5-121, 5-122, 5-125, 5-127,
5-136, 5-136, 5-247, 5-315, 5-316, 5-327, 5-329, 5-377,
5-387, 5-412, 5-415, 5-416, 5-417, 5-611T, 5-525T, 5-
627T, 5-555T, 5-667T, 5-558T, 55-18, 55-118; SPECIAL
DISTRIBUTION.

For explanation of distribution formula see SR 310-90-1.

WAR DEPARTMENT TECHNICAL MANUAL
TM 9-813

**This technical manual contains operating and organizational maintenance instructions from TM 10 1139, 17 August 1941; TM 10 1139, 29 August 1941; TM 10-1211, 3 February 1942; TM 10 1537, 14 May 1942; and TM 10 1539, 29 September 1942, and, together with TM 9-1613 and TM 9-1612A, supersedes these manuals.*

6-TON, 6x6 TRUCK
WHITE, CORBITT
AND
BROCKWAY



WAR DEPARTMENT • FEBRUARY 1944

WAR DEPARTMENT
Washington 25, D. C., 19 February 1944

TM 9-813, 6-ton, 6 x 6 Truck (White, Corbitt, and Brockway),
is published for the information and guidance of all concerned.

[A.G. 3007 (29 May 43)]

BY ORDER OF THE SECRETARY OF WAR:

G. C. MARSHALL,
Chief of Staff.

OFFICIAL:

J. A. ULIO,
*Major General,
The Adjutant General.*

DISTRIBUTION: X

(For explanation of symbols, see FM 21-6.)

6-TON, 6 x 6 TRUCK

(WHITE, CORBITT, AND BROCKWAY)

CONTENTS

PART ONE—VEHICLE OPERATING INSTRUCTIONS

SECTION		Paragraphs	Pages
I	Introduction	1	5
II	Description and tabulated data	2-5	6-18
III	Driving controls and operation	6-8	19-28
IV	Auxiliary equipment controls and operation	9-11	29-32
V	Operation under unusual conditions	12-16	33-36
VI	First echelon preventive maintenance services	17-21	37-47
VII	Lubrication	22-23	48-73
VIII	Tools and equipment storage on the vehicle	24-26	74-77

PART TWO—VEHICLE MAINTENANCE INSTRUCTIONS

SECTION	IX	New vehicle run-in test	27-28	78-82
	X	Second echelon preventive maintenance	29	83-106
	XI	Vehicle modification records	30	107
	XII	Organizational tools	31	108
	XIII	Trouble shooting	32-48	109-172
	XIV	Engine—maintenance and adjustment in vehicle	49-59	123-134
	XV	Engine—removal and installation	60-61	135-145
	XVI	Fuel system	62-67	146-153
	XVII	Exhaust system	68-70	154-155
	XVIII	Cooling system	71-76	156-162

TM 9-813

6-TON, 6 x 6 TRUCK (WHITE, CORBITT, AND BROCKWAY)

	Paragraphs	Pages
SECTION XIX Ignition system ..	77-84	165-172
XX Starting and generating system	85-88	173-178
XXI Clutch	89-92	179-184
XXII Transmission	93-96	185-192
XXIII Propeller shafts	97-100	193-196
XXIV Transfer case	101-103	197-201
XXV Front axle	104-107	202-213
XXVI Rear axle	108-114	214-223
XXVII Brake systems	115-123	224-238
XXVIII Wheels	124-126	239-241
XXIX Springs and torque rods .. .	127-129	242-245
XXX Steering	130-133	246-249
XXXI Body and frame	134-141	250-258
XXXII Battery and lighting system ..	142-147	259-266
XXXIII Instruments	148-156	267-269
XXXIV Winch	157-160	270-272
XXXV Shipment and temporary storage	161-163	273-277
REFERENCES		278-280
INDEX		281

PART ONE—VEHICLE OPERATING INSTRUCTIONS**Section I****INTRODUCTION**

	Paragraph
Scope	1

1. SCOPE.

a. This manual is published for the information and guidance of the using arms, and of all personnel charged with the operation and maintenance of the vehicle concerned.

b. In addition to a description of the Prime Mover 6-ton, 6 x 6 Truck, the Bridge Erection Position Truck, and the Crane Truck, this manual contains descriptions of the major units, group assemblies, functional systems, and instructions with reference to their operation, inspection, adjustments, minor repair, and unit replacement. Specific information for the guidance of operating personnel (crew) is contained in Part One, sections I through VIII inclusive. Information for the guidance of organizational maintenance personnel (using arms mechanics) is contained in Part Two, sections IX through XXXIV. Section XXXV contains instructions for shipment and temporary storage of the vehicles.

c. In all cases where the nature of the repair, modification, or adjustment is beyond the scope or facilities of the unit, the responsible ordnance service should be informed, so that trained personnel with suitable tools and equipment may be provided, or proper instructions issued.

6-TON, 6 x 6 TRUCK (WHITE, CORBITT, AND BROCKWAY)

Section II

DESCRIPTION AND TABULATED DATA

	Paragraph
Description	2
Differences among models	3
Data	4
Serial number locations of vehicle units	5

2. DESCRIPTION.

a. **Chassis.** The 6-ton, 6 x 6 truck chassis, is of special commercial-type design, powered by a 6-cylinder L-head gasoline engine and 6-wheel drive. The vehicle transmission has eight forward speeds and two reverse speeds, accomplished through the transfer case mounted to the rear of the transmission. The vehicles are equipped with air-powered brakes on all wheels, and a double-shoe propeller shaft brake mounted at the rear of the transfer case. The gasoline tanks are mounted on the left frame side rail to the rear of the cab.

3. DIFFERENCES AMONG MODELS.

a. **Body Style.**

(1) **PRIME MOVER CARGO TRUCK.** The Corbitt and White trucks are identical in design and appearance. Early models are equipped with all-steel cargo bodies and hard-top cabs. Later models are equipped with wooden cargo bodies and soft-top cabs. Both models are equipped with slotted bench seats along the sides of the cargo body, for the transport of personnel as well as cargo. The vehicles are primarily noncombat haulers, and are not provided with protective armor.

(2) **BRIDGE ERECTION TRUCK.** These vehicles are assembled by Brockway and White, and are identical in design and appearance. The changes in cab design described in subparagraph (1) above also apply to the bridge erection vehicles. An all-steel body, designed to carry pontoons and steel tread plate, is mounted on the chassis, and is equipped with a double-arm hydraulic boom. This is operated by hydraulic rams powered from the power take-off on the transmission. The vehicle carries no protective armor.

(3) **CRANE TRUCK.** This vehicle is of special design, having a one-man, soft-top cab, and a specially reinforced frame. The crane, of standard boom type, is self-powered, and is placed on a turntable above the rear axle bogie. Special low pressure, 14.00-20, dual tires are used on the rear axle bogies to accommodate the weight of the crane. The rear axle bogie is also equipped with cast-steel "walking beams" in place of the conventional spring suspension (fig. 143).

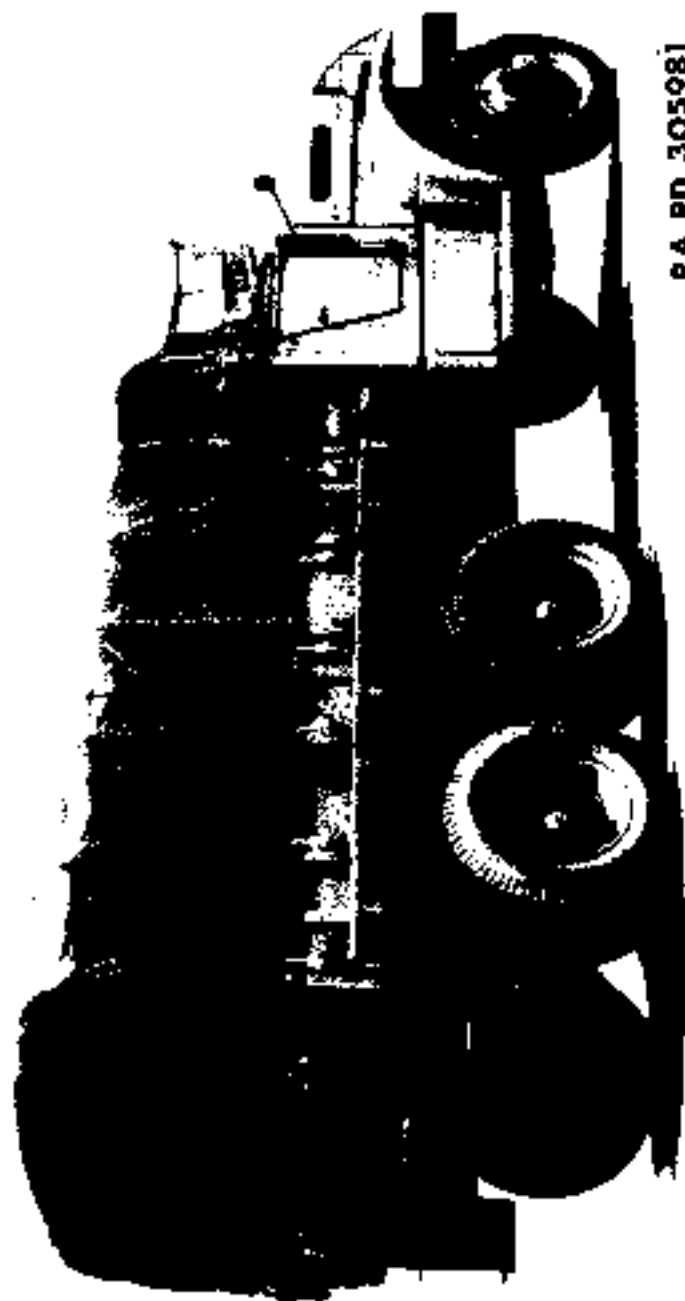
DESCRIPTION AND TABULATED DATA



RX PD 354744

Figure 1-6-Ten, 6 x 6, Prime Mover-Right Front

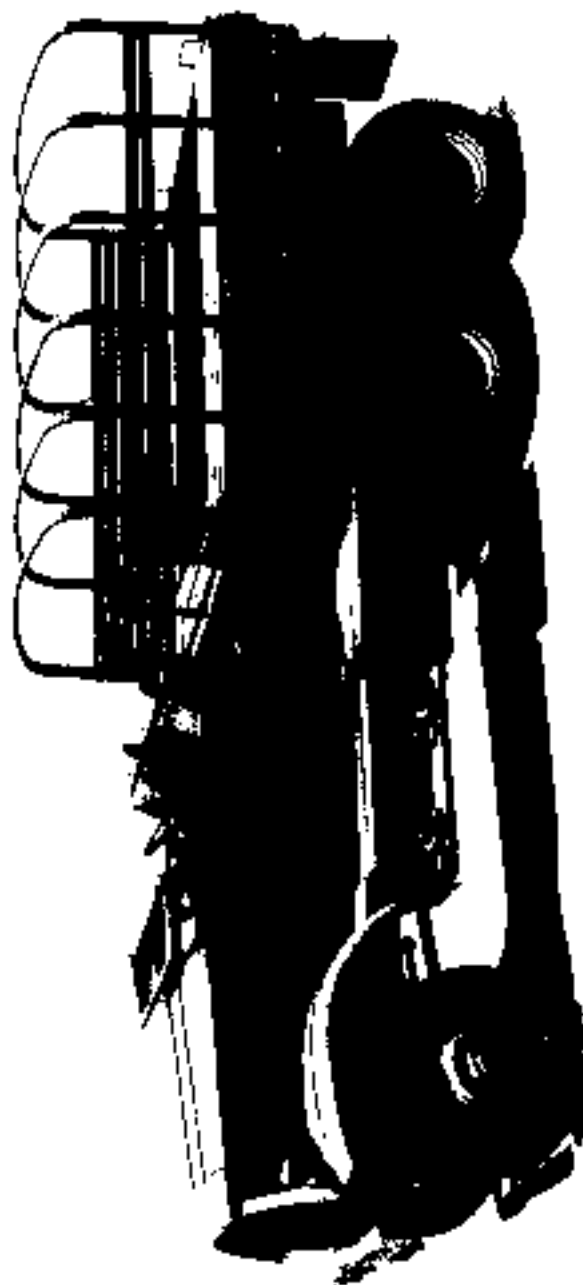
6-TON, 6 x 6 TRUCK (WHITE, CORBITT, AND BROCKWAY)



RA PD 305981

Figure 2—6-Ton, 6 x 6, Prime Mover—Right Rear

DESCRIPTION AND TABULATED DATA



RA PD 305982

Figure 3-5-Ton, 6 x 6, Prime Mover--Left Side

4-TON, 4 x 4 TRUCK (WHITE, CORBITT, AND BROCKWAY)



RA PD 306012

Figure 4—Bridge Erector Truck—Right Front

DESCRIPTION AND TABULATED DATA

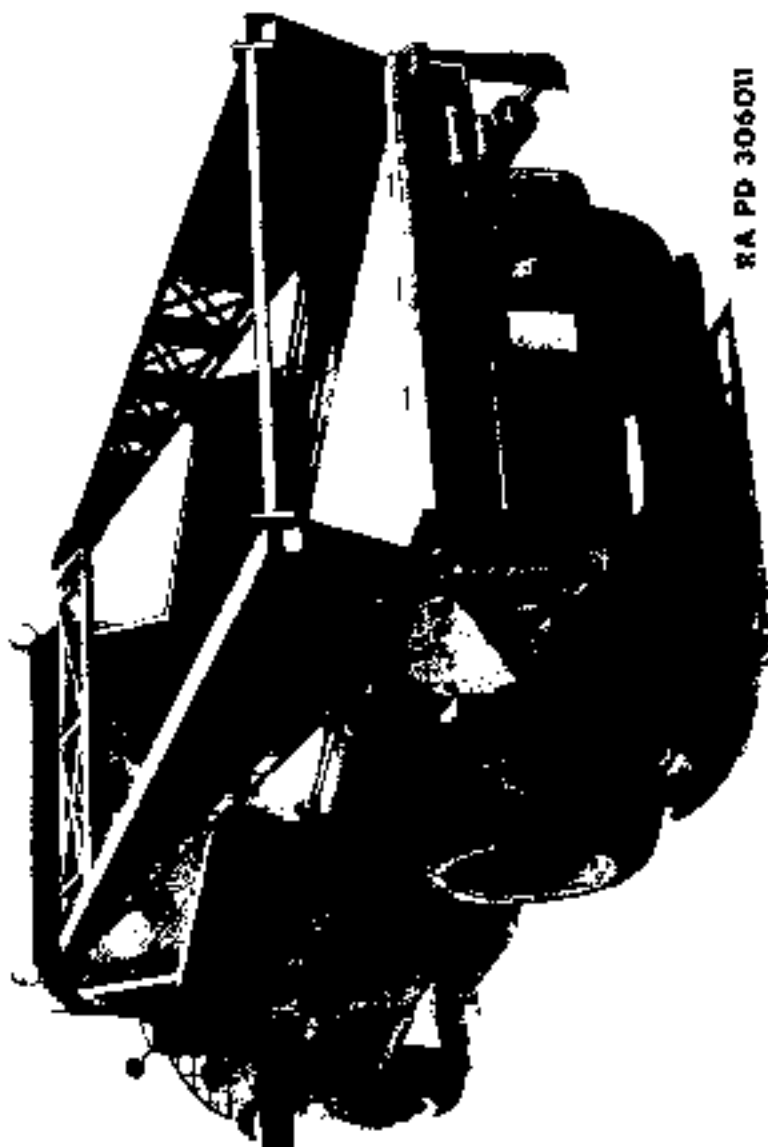
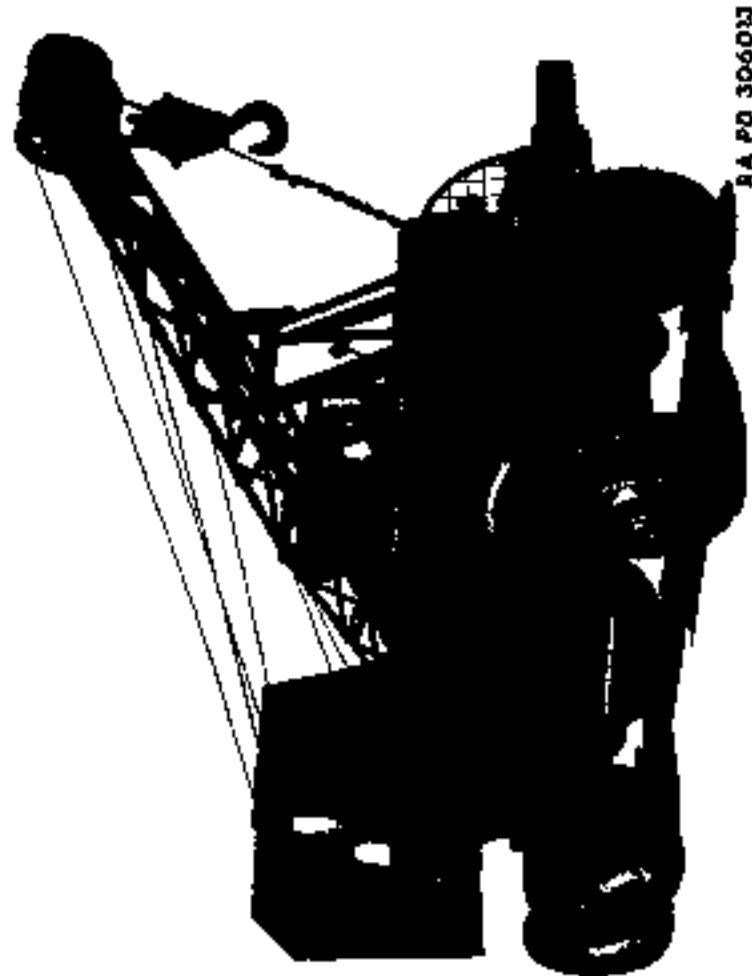


Figure 5—Bridge Erection Truck—Left Rear

TM 9-813

3

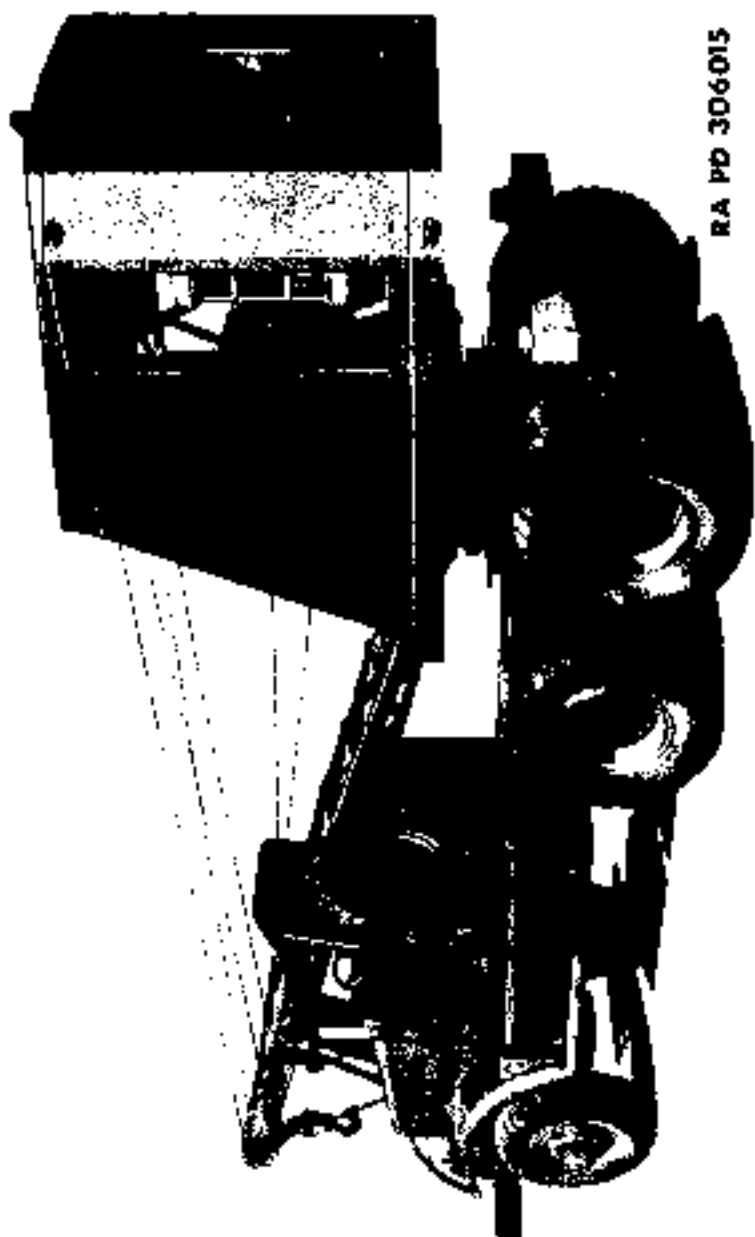
6-TON, 6 x 6 TRUCK (WHITE, CORBITT, AND BROCKWAY)



RA PD 306013

Figure 6--Crane Truck, 6 x 6--Right Front

DESCRIPTION AND TABULATED DATA



RA PD 3D6015

Figure 7—Crane Truck, 6 x 6—Left Rear

6-TON, 6 x 6 TRUCK (WHITE, CORBITT, AND BROCKWAY)



RA PD 306014

EA PD 806014

Figure 8—Crane Truck, 6 x 6—Left Side

DESCRIPTION AND TABULATED DATA**b. Auxiliary Equipment.**

(1) **PRIME MOVER CARGO TRUCK.** The winch, operated from the power take-off on the transfer case, is mounted on the frame behind the cab. The winch cable extends under the body and out from the rear of the vehicle. The winch is equipped with a cathead at the right side of the vehicle. The vehicle is equipped with pintle hooks at the front and rear center of the frame. There are two spare tire carriers mounted at the right and left front of the cargo body floor.

(2) **BRIDGE ERECTION TRUCK.** The double-drum winch is mounted at the front of the vehicle, and is powered from a power take-off on the transmission. The vehicle is equipped with an auxiliary air compressor and piping system for ponton inflation. The spare tire carrier is mounted to the right side rail of the frame. The towing equipment consists of towing rings at the front, and a pintle hook at the rear of the vehicle.

(3) **CRANE TRUCK.** The double-drum winch on this vehicle is mounted at the front. The towing equipment consists of towing rings at the front, and a pintle hook at the rear. The spare tire carrier is mounted at the rear of the cab.

6-TON, 6 x 6 TRUCK (WHITE, COBBITT, AND BROCKWAY)

4. DATA.

Data Item	White & Tan, 6 x 6 Prime Mover	
SPECIFICATIONS		
Wheelbase	185 in.	
Length, over-all	24 ft. 3 in.	
Width, over-all	8 ft.	
Height, over-all	9 ft. 6 in.	
Wheel type	Disk	
Tire size	10.00 x 22	
Tire type	Mud and snow	
Tread (center to center)	Front 7 $\frac{3}{4}$ in. Rear 7 $\frac{3}{4}$ in.	
Crew (operating)	2	
Weight of vehicle (empty)	22,900 lb.	
Ground clearance (empty)	18 $\frac{1}{4}$ in.	
Pintle height (center of hook)	29 $\frac{1}{4}$ in.	
Kind and grade of fuel	Gasoline, 72 Octane	
PERFORMANCE		
Vehicle speeds in mph (transfer case low and high)	Low	High
Reverse	1.9	4.8
First	2.1	5.4
Second	4.2	10.9
Third	7.9	20.1
Fourth	13.2	35.2
Approach angle	59°	
Departure angle	47°	
Minimum turning radius (left and right)	41 ft.	
Fording depth	14 in.	
Towing facilities (front and rear)	(F) Front (R) Rear	
Maximum grade ascent possible	60°	
Maximum allowable speed	35.2 mph	
Maximum allowable engine speed	2150 rpm	
CAPACITIES		
Transmission	9 qt.	
Transfer case	6 $\frac{3}{4}$ pt.	
Front axle center	8 qt.	
Rear axle center (two)	6 qt. each	
Fuel tank	80 gal.	
Cooling system	58 qt.	
Crankcase (dry)	20 qt.	
Winch (to level plug)	3 qt. (approx.)	
Air cleaner	4 qt.	
Oil filters	1 gal.	

DESCRIPTION AND TABULATED DATA

Cavalry & Tan, 4 x 6 Firma Mower		White and Brockway Bridge Erection Trucks		Brockway Crane Truck	
185 in.		220 in.		197 in.	
23 ft 9 in.		30 ft 10 in.		34 ft 8 in.	
R. Ft.		8 ft 4 in.		8 ft 4 in.	
9 ft 10 in.		9 ft.		11 ft 4 $\frac{3}{8}$ in.	
Disk		Disk		Disk	
10.00 x 22		12.00 x 20		12.00 x 20	
Mud and snow		Mud and snow		Mud and snow	
Front 73 $\frac{1}{4}$ in.		Front 73 $\frac{3}{4}$ in.		Front 73 $\frac{1}{4}$ in.	
Rear 72 in.		Rear 74 $\frac{1}{4}$ in.		Rear 74 $\frac{1}{4}$ in.	
2		2		2	
22,020 lb		26,500 lb		35,275 lb	
21 in.		11 in.		11 in.	
31 $\frac{3}{4}$ in.		40 in.		38 $\frac{1}{2}$ in.	
Gasoline, 72 Octane		Gasoline, 72 Octane		Gasoline, 72 Octane	
Low	High	Low	High	Low	High
2.0	5.1	2.0	5.1	2.0	5.1
2.2	5.7	2.2	5.7	2.2	5.7
4.4	11.3	4.4	11.4	4.4	11.4
8.2	21.0	8.3	21.2	8.5	21.2
14.5	37.1	14.6	37.3	14.6	37.3
59"		36"		36"	
47"		28"		45"	
41 ft		(L) 40 ft	(R) 49 ft	(L) 43 ft	(R) 44 ft
24 in.		33 in.		33 in.	
(F) Pintle (R) Pintle		(F) Link (R) Pintle		(F) Link (R) Pintle	
60"		60"		60"	
37.3 mph		37.3 mph		37.3 mph	
1200 rpm		2150 rpm		2150 rpm	
2 $\frac{1}{2}$ qt		10 qt		10 qt	
8 pt		6 $\frac{1}{2}$ pt		6 $\frac{3}{4}$ pt	
9 qt		10 qt		10 qt	
6 qt each		6 qt each		6 qt each	
80 gal		80 gal		80 gal	
50 qt		50 qt		50 qt	
20 qt		21 qt		21 qt	
2 $\frac{3}{4}$ qt		1 qt		1 qt	
4 qt		4 qt		4 qt	
1 gal		1 gal		1 gal	

4-TON, 6 x 6 TRUCK (WHITE, CORBITT, AND BROCKWAY)**5. SERIAL NUMBER LOCATIONS OF VEHICLE UNITS**

- a. **Front Axle.** Stamped on plate at front upper center of differential housing.
- b. **Forward Rear Axle.** Embossed on top of left axle shaft housing, to left of differential.
- c. **Rearward Rear Axle.** Embossed on top of right axle shaft housing, to right of differential.
- d. **Air Compressor.** Stamped on plate on side of compressor crankcase.
- e. **Battery.** Stamped on connecting strap between cells.
- f. **Carburetor.** Cast on top cover.
- g. **Chassis.** Stamped on left outside side rail of frame, above front spring center.
- h. **Clutch.** Stamped on flywheel ring.
- i. **Distributor.** Stamped on plate on engine side of distributor.
- j. **Engine.** Manufacturer's serial number stamped on plate on crankcase at lower rear left side of engine. Contractor's serial number embossed on metal strip riveted to left rear engine support.
- k. **Governor.** Stamped in plate on top of drive shaft housing.
- l. **Fuel Pump.** Stamped in top of mounting bracket.
- m. **Generator.** Stamped in plate on top of housing.
- n. **Generator Regulator.** Stamped on plate on top of cover.
- o. **Cranking Motor.** Stamped in plate on side of housing.
- p. **Solenoid Switch.** Stamped on plate on side of case.
- q. **Oil Filter Assembly.** Stamped in filter bracket casting.
- r. **Air Cleaner.** Stamped on plate on side of bowl.
- s. **Steering Gear.** Stamped on top of gear case (under fender).
- t. **Radiator Core Assembly.** Stamped on tank on engine side.
- u. **Transfer Case.** Stamped on left side of case (seen from under truck).
- v. **Transmission.** Stamped in plate on left side of case.

Section III

DRIVING CONTROLS AND OPERATION

	Paragraph
Vehicle controls	6
Operation of the vehicle	7
Towing the vehicle	8

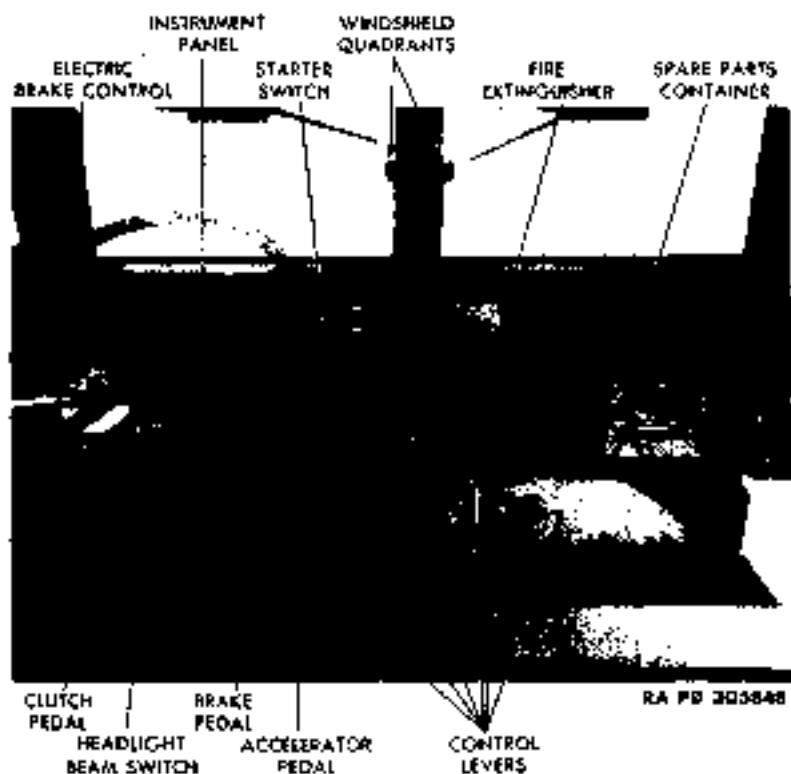


Figure 9—Cab Interior, Prime Mover, and Bridge Erection Trucks

6. VEHICLE CONTROLS.

a. Controls on Instrument Panel.

(1) **SPARK CONTROL BUTTON (N, fig. 11).** This button is pulled out to retard the spark in starting. It should be pushed in when the engine is warmed up.

(2) **MAIN LIGHT SWITCH (M, fig. 11).** The main light switch is a four-position push-pull type. It has a lock-out button for securing switch in blackout lights position. Push switch button fully in to turn lights off. Pull switch button out to first stop to obtain blackout lights. Depress lock-out button, and pull switch button out to

6-TON, 4 x 6 TRUCK (WHITE, CORBITT, AND BROCKWAY)

second position to obtain service lights. Depress lock-out button, and pull switch button fully out to obtain stop lights for daylight driving.

(3) **IGNITION SWITCH (O, fig. 11).** This is a small lever switch used for turning the engine ignition on or off. The ignition is turned on by swinging the handle to the left, and off by swinging it to the right. There is no locking device on this unit.



- | | |
|------------------------------|----------------------------------|
| A — CLUTCH PEDAL | G — TRANSMISSION GEARSHIFT LEVER |
| B — FOOT BRAKE LOCKING LATCH | H — HEAD LIGHT FOOT BEAM SWITCH |
| C — HORN BUTTON | I — FRONT AXLE SHIFT LEVER |
| D — FOOT BRAKE PEDAL | J — AUXILIARY RANGE SHIFT LEVER |
| E — DRINKING WATER SWITCH | K — WINCH SHIFT LEVER |
| F — ACCELERATOR PEDAL | L — HAND BRAKE LEVER |

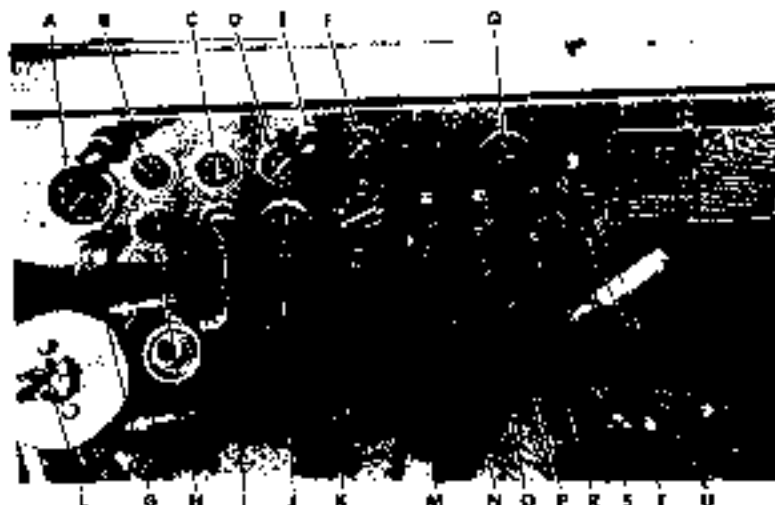
GA 40 304072

Figure 10—Driving Controls, Crane Truck

(4) **THROTTLE CONTROL BUTTON (P, fig. 11).** The hand throttle control button regulates the speed of the engine for starting, or when engine tests are being made with the truck at a standstill. When starting the engine, pull the hand throttle button out one-half or more, as required.

(5) **ELECTRIC BRAKE CONTROL RHEOSTAT (Q, fig. 11).** (Prime Mover only.) Turning this radio-type dial controls the braking rate of the towed trailer, when the trailer is equipped with electric brakes. The braking action of the electric brakes is controlled by the amount of electric current they receive. Turning the arrow to the desired load on the dial permits more or less current at the trailer brakes, and gives a heavier or lighter braking effect, as desired.

DRIVING CONTROLS AND OPERATION



- | | |
|------------------------------|--|
| A—TACHOMETER | L—ELECTRIC TRAILER BRAKE
HAND CONTROL |
| B—FUEL GAGE | M—LIGHTING SWITCH |
| C—AIR PRESSURE GAGE | N—SPARK CONTROL BUTTON |
| D—ENGINE TEMPERATURE GAGE | O—IGNITION SWITCH |
| E—DASHBOARD INSTRUMENT LIGHT | P—THROTTLE CONTROL BUTTON |
| F—OIL PRESSURE GAGE | Q—ELECTRIC BRAKE CONTROL RHEOSTAT |
| G—TACHOMETER LOCKING SWITCH | R—PANEL LIGHT SWITCH |
| H—AUXILIARY AMMETER | S—CHOKE CONTROL BUTTON |
| I—OIL VISCOSITY GAGE | T—BLACKOUT DRIVING LIGHT SWITCH |
| J—AMMETER | U—WINDSHIELD WIPER CONTROLS |
| K—SPEEDOMETER | |

RA PD 303649

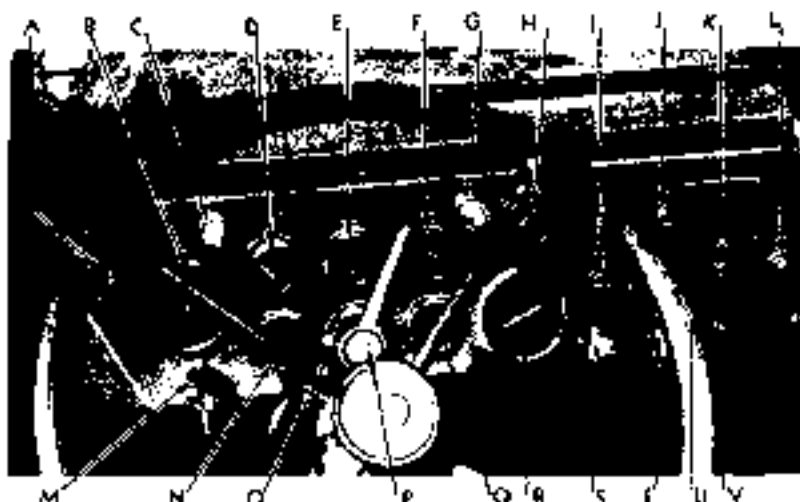
**Figure 11—Instrument Panel, Prime Mover and
Bridge Erection Track**

(6) **CHOKE CONTROL BUTTON (S, fig. 11).** The choke control regulates fuel mixture in the carburetor, and is used to aid in starting when the engine is cold. It is pulled out just far enough to allow the engine to run smoothly during the warm-up, and should be pushed in as soon as possible after the engine is started.

(7) **PANEL LIGHT SWITCH (R, fig. 11).** This is a push-and-pull switch for lighting the instrument panel only.

(8) **WINDSHIELD WIPER CONTROLS (U, fig. 11).** Dual windshield wipers are controlled by separate switches. Each wiper may be turned on or off, or its speed regulated, by its individual switch. The wiper is turned on by turning the switch control to the left. The amount the switch is turned controls the speed of the wiper action. To turn off the windshield wiper, turn the switch to the right until tight.

6-TON, 4 x 6 TRUCK (WHITE, CORBITT, AND BROCKWAY)



- | | |
|-----------------------------------|--------------------------------|
| A — FUEL TANK TOGGLE SWITCH | L — WINDSHIELD WIPER CONTROL |
| B — TACHOMETER | M — TACHOMETER LOCKING SWITCH |
| C — INSTRUMENT PANEL LIGHT | N — AUXILIARY AMMETER |
| D — FUEL GAGE | O — OIL VISCOSITY GAGE |
| E — AIR PRESSURE GAGE | P — TRAILER BRAKE HAND CONTROL |
| F — ENGINE TEMPERATURE GAGE | Q — AMMETER |
| G — INSTRUMENT PANEL LIGHT | R — SPEEDOMETER |
| H — OIL PRESSURE GAGE | S — LIGHTING SWITCH |
| I — SPARK CONTROL BUTTON | T — IGNITION SWITCH |
| J — BLACKOUT DRIVING LIGHT BUTTON | U — THROTTLE BUTTON |
| K — CHOKE CONTROL BUTTON | V — PANEL LIGHT BUTTON |

RA PB 306021

Figure 12—Instrument Panel, Crane Truck

(9) BLACKOUT MARKER LIGHT SWITCH (T. fig. 11). This switch is a push-and-pull type, and operates the blackout marker lamps.

b. Controls Not on Instrument Panel.

(1) WINCH POWER TAKE-OFF LEVER. (Used only on Prime Mover.) This lever engages or disengages power take-off in transfer case for operation of winch, and has two positions. Pull lever back and up to engage. Push lever forward and down to disengage.

(2) HAND BRAKE LEVER. Whenever the truck is parked, this lever should be pushed to the front as far as possible. This lever operates a four-shoe disk-type brake on the propeller shaft. Before moving the truck, release the latch on the hand brake lever and pull back as far as possible.

(3) WINCH DRIVE LEVER. This lever engages the winch with the power take-off. Push lever forward and down to engage; pull up and back to disengage.

DRIVING CONTROLS AND OPERATION

(4) **CENTER COWL VENTILATION HANDLE.** Push the center cowl ventilator control handle forward to open cowl and pull it rearward to close cowl.

(5) **TRANSMISSION GEARSHIFT LEVER.** The transmission shift lever permits the selection of transmission speeds (gear ratios). The transmission has four speeds forward and one reverse. The reverse gear can be engaged only when the lever is pushed all the way to the right.

(6) **TRANSFER CASE AUXILIARY RANGE LEVER.** The transfer case shifting lever controls the high or low speed range of the transfer case. Before the transfer case can be shifted into low speed, the front axle control must be engaged.

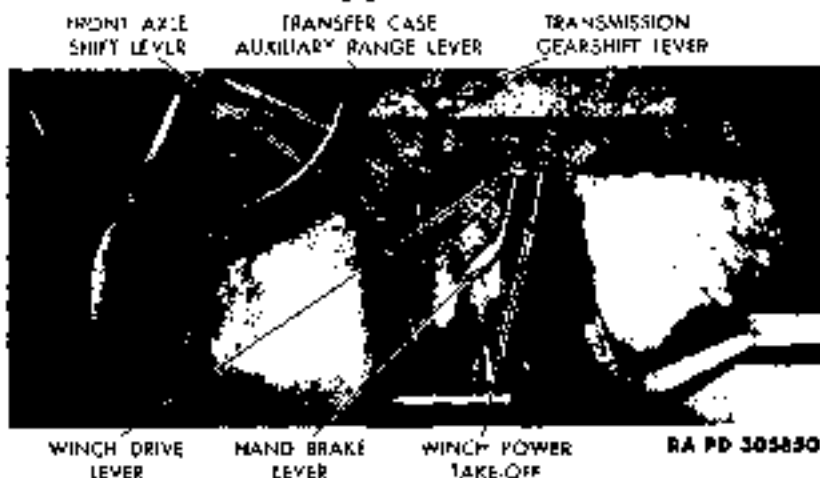


Figure 13—Control Levers, Prime Mover and Bridge Traction Truck

(7) **ACCELERATOR PEDAL.** The accelerator pedal controls the road speed of the truck by regulating the carburetor throttle valve, thereby controlling the amount of fuel and air passing through the carburetor.

(8) **FRONT AXLE SHIFT LEVER.** Engagement or disengagement of the front axle drive is controlled by pushing the lever downward to engage the axle, and upward to disengage it.

(9) **STARTING SWITCH.** The starting switch is operated by a button which is located just above the floorboard in front of the accelerator. When the button is pushed in, it connects two batteries in series when pressed in with the foot, providing 12-volt current to the cranking motor.

(10) **BRAKE PEDAL.** Pressing on this pedal applies the air brakes to all six wheels. When electric trailer brakes are used, the action of pushing down the brake pedal operates an extension arm on the brake valve and energizes the electric brakes of the trailer, producing braking action.

6-TON, 6 x 6 TRUCK (WHITE, CORBITT, AND BROCKWAY)

(11) **HEADLIGHT BEAM CONTROL SWITCH.** This switch is operated by the left foot and switches the headlight beams from the "traffic" or lower beam to the "country" or upper beam after the headlights are turned on. Use the "traffic" or lower beam when approaching and passing other vehicles at night on country roads.

(12) **CLUTCH PEDAL.** The clutch pedal provides the means of engaging and disengaging the engine from the transmission, to permit shifting the transmission, transfer case or power take-off gears. Depressing the clutch pedal disengages the engine from the transmission and power train.

(13) **HORN BUTTON.** The horn button is located in the center of the steering wheel. Depress the button to operate the air horns.

(14) **ELECTRIC TRAILER BRAKE HAND CONTROL.** This control enables the driver to set the amount of current (and braking power) to the electric trailer brakes, without relying on the braking action produced by the extension arm on the air brake valve.

(15) **STEERING WHEEL.** The steering wheel is secured to the top of the steering gear shaft and controls turning movement of the front wheels.

c. **Differences in Control Lever Arrangement.** The diagram (fig. 14) shows the prime mover control lever arrangement, with six levers, and the bridge erection control lever arrangement with five levers. The instruments and controls of the crane truck are identical with those of the bridge erection truck.

7. OPERATION OF THE VEHICLE.**a. Starting the Engine.**

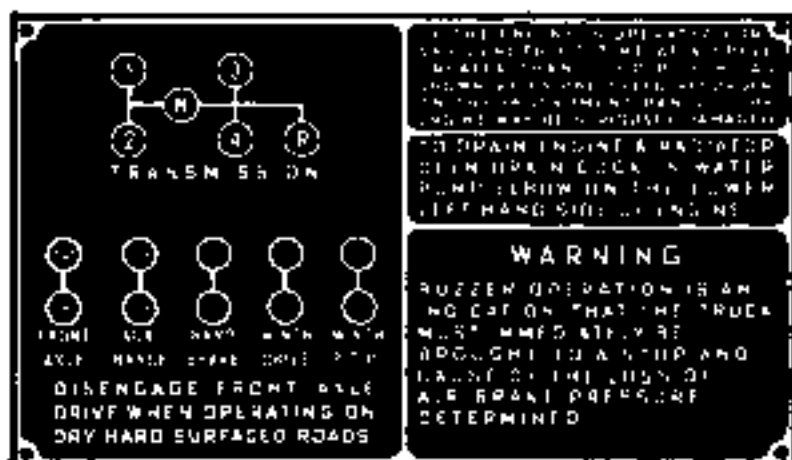
(1) **BEFORE-OPERATION INSPECTION.** Refer to paragraph 18.

(2) **STARTING THE ENGINE.** Apply the hand brake by pushing forward on lever. Place the transmission shift lever in neutral position. Pull choke button out about half way and hand throttle button out one-quarter inch. *NOTE: If the engine is warm, these two steps will not be necessary.* Move ignition switch lever to left to "ON" position. Depress clutch pedal and press starting switch button, cranking the engine. Release pressure on starting switch button as soon as the engine starts. Adjust throttle and choke until engine attains an even idling speed, then release clutch pedal slowly.

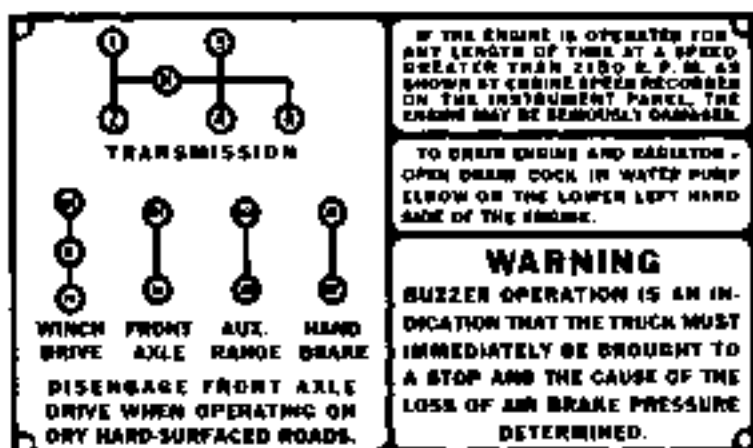
(3) **WARM-UP.** To avoid scuffing the pistons, always perform the following warm-up before operating the vehicle.

(a) Upon starting, bring the engine up to, and maintain at, a fast idle (approximately 1,000 rpm) until normal operating temperature is indicated. Normal operating temperature may be assumed when the following conditions exist: Engine idles and accelerates smoothly with the choke in nonchoke position, and the oil pressure gage indicates pressure consistent with temperature (step (4) (h)). Where warm-up difficulty is experienced, condition of the engine thermostat should be checked.

DRIVING CONTROLS AND OPERATION



GEARSHIFT DIAGRAM - PRIME MOVER AND CRANE TRUCKS



GEARSHIFT DIAGRAM - BRIDGE ERECTION TRUCKS

RA PD 308951

Figure 14—Prime Mover, Bridge Erection, and Crane Truck Gearshift Diagrams

6-TON, 6 x 6 TRUCK (WHITE, CORBITT, AND BROCKWAY)

(b) At low temperatures, warm-up can be accomplished in a minimum of time by covering the radiator to reduce cold air blasts from the fan.

(c) Avoid excessive use of choke which will result in unburned gasoline washing the protective lubricant from cylinder walls, aggravating scuffing action. Return the choke to the nonchoke position as soon as engine will run without choking.

(d) The oil pressure gage should be watched closely, and if the gage does not indicate oil pressure within 30 seconds (for temperatures below -20°F . see OFSB 6-11) the engine should be shut off, and the cause for the lack of pressure determined and corrected. Cases have been experienced where freezing of water and sludge in oil pump screen have prevented oil pump operation.

(e) Where low temperatures constantly prevail, blank off a portion of the radiator surface to insure a normal operating temperature. Refer to section V for operation under extremely low temperatures.

(4) **INSTRUMENT READINGS.** Before operating the vehicle, check the instrument panel gages for the following readings:

(a) *Tachometer.* The tachometer should show an idling speed of approximately 450 revolutions per minute.

(b) *Air Brake Pressure Gage.* This gage should show a pressure of 80 pounds.

(c) *Electric Trailer Brake Control.* If towing a trailer, set this dial to the proper braking power indication.

(d) *Ammeter.* This should show a positive reading.

(e) *Auxiliary Ammeter.* This should show a positive reading.

(f) *Fuel Gage.* This gage should indicate presence of ample fuel for the trip to be made.

(g) *Engine Temperature Gage.* This should show a slow increase in temperature until engine warms up, with a maximum reading of 180°F .

(h) *Oil Pressure Gage.* This gage should show a reading of 15 to 17 pounds with engine idling, and a maximum pressure of 25 to 35 pounds at operating speed.

(i) *Oil Viscosity Gage.* This gage should be in the "ideal" range.

b. Driving the Vehicle.

(1) **SHIFTING INTO GEAR.** Push clutch pedal down to disengage clutch. Move transfer case shifting lever into the proper speed range—high range for light loads on solid, level ground, or low range for heavy loads on uphill starts. Move the transmission shifting lever into first speed position. Pull hand brake lever toward rear as far as possible, releasing brake.

(2) **PUTTING VEHICLE IN MOTION.** Release the clutch pedal slowly, at the same time pressing the accelerator pedal the amount necessary for the engine to overcome the load and put the truck into motion.

DRIVING CONTROLS AND OPERATION

(3) **INCREASING VEHICLE SPEED.** As the truck gains speed, release the accelerator pedal, push the clutch pedal down at the same time, and move the transmission shift lever through neutral and into the next higher gear position. Push down the accelerator and release the clutch pedal as before, until the speed of the truck has increased enough for the next shift. Repeat these operations until transmission is in highest gear.

(4) **SHIFTING THE TRANSMISSION TO A LOWER GEAR, WITH THE TRUCK IN MOTION.** Push in the clutch pedal and release the accelerator pedal. Move the transmission shift lever into neutral position. Release the clutch pedal, and accelerate the engine to synchronize the truck and engine speeds. Push in the clutch pedal and move shifting lever into the next lower speed position. Release the clutch pedal slowly, accelerating the engine at the same time.

(5) **STOPPING THE VEHICLE.** Release the accelerator pedal and apply the brakes by slowly pushing in the brake pedal. **CAUTION;** *Quick application of the air brakes may shift the load or cause other damage or injury.* When forward speed of the truck has decreased to approximately the idling speed of the engine, push in the clutch pedal. When the truck has been brought to a complete stop, shift the transmission into neutral, release the clutch pedal, and push the hand brake as far forward as possible.

(6) **SHIFTING THE TRANSMISSION INTO REVERSE.** Push in the clutch pedal and bring the truck to a stop. Press down on the latch at upper right side of transmission shift lever, move the shift lever to the right as far as possible, and then rearward into reverse position. Release clutch pedal slowly and accelerate engine at the same time, and in the same manner, as when starting forward motion of the vehicle.

e. Operation of Transfer Case and Front Axle Controls.

(1) **GENERAL.** High and low speed ranges in the transfer case, and the engagement and disengagement of the front axle, are controlled by two separate shift levers. The front axle control lever and the transfer case shift lever are so arranged that the transfer case cannot be shifted into low except when the front axle is engaged. This is done in order that any heavy load or hard pull, placing gear strain on the driving members, will be distributed over the three axles. The high gear range of the transfer case can be employed when the front axle is engaged or disengaged. However, for high-speed operation on hard-surfaced roads, disengage the front axle. The position of the transmission shift lever has no effect on shifting either the transfer case or front axle.

(2) **ENGAGING OR DISENGAGING THE FRONT AXLE WITH THE TRANSFER CASE IN HIGH.** Move the front axle control lever into the desired position. It is not necessary to disengage the clutch, and the shift is usually easier to make when the truck is in motion.

(3) **DISENGAGING THE FRONT AXLE WITH THE TRANSFER CASE IN LOW.** Shift the transfer case into neutral or high. The truck must then be operated in high range as long as the front axle is disengaged.

6-TON, 6 x 6 TRUCK (WHITE, CORBITT, AND BROCKWAY)

(4) **SHIFTING THE TRANSFER CASE FROM HIGH TO LOW.** Bring truck to a standstill, or operate at low speed. Engage the front axle. Push in the clutch pedal and move the transfer case shift lever into a neutral position. Release the clutch pedal and accelerate the engine to approximately double the relative speed of the truck. Again push in the clutch and move the shift lever forward into the low speed position, being careful not to use excessive pressure to make the shift. Accelerate the engine and release the clutch. Shifting from high to low when the truck is in motion must be done in this manner to synchronize the speeds of the engaging gears and prevent damaging them.

(5) **SHIFTING THE TRANSFER CASE FROM LOW TO HIGH.** Push in the clutch pedal, and move the shift lever through neutral into high. Make the shift slowly and without excessive force. Release the clutch pedal and accelerate the engine simultaneously.

8. TOWING THE VEHICLE.

a. **Towing to Start Vehicle.** To start the engine by towing, place the transfer case in high range and the transmission in fourth or high gear. Disengage the front axle. Disengage the clutch by holding foot pedal down. Adjust choke and throttle to suit climatic conditions. After vehicle has gained speed, turn on the ignition switch and engage the clutch slowly. As soon as the engine is running smoothly, shift transmission into neutral, and signal towing vehicle to stop.

b. **Towing Disabled Vehicle.** Towing a disabled vehicle depends upon the damage to the vehicle. If the wheels are not disabled, the vehicle can be towed by a connection made to one of the tow hooks on the front end of the vehicle or to the rear pintle hook. In case either of the ends remain undamaged, the damaged end can be raised with a conventional towing hoist and the vehicle towed to a repair station. (Place the towed vehicle in neutral with all drives disengaged.) If the wheels cannot be used to support one end of the vehicle, special recovery equipment must be procured.

Section IV

AUXILIARY EQUIPMENT CONTROLS AND OPERATION

	Paragraph
Winch on prime mover trucks	9
Winch on bridge erection and crane trucks	10
Hydraulic booms on bridge erection truck	11

9. WINCH ON PRIME MOVER TRUCKS.

a. **Controls.** On models equipped with winches, the power take-off lever is at the extreme right-hand side. The winch drive lever is just to the left of the power take-off lever. The arrangement of these levers is shown on a plate on the instrument panel.

b. **Operation.** Put transfer case in neutral position. Release the safety locks at the lower end of the winch levers. Pull off cable and hook and secure to load, using the truck towing chain as a sling if the load is such that the winch line hook will not attach directly. *NOTE: The winch cable must not be wrapped around the load with the hook around the cable as this will damage the cable beyond repair.* Push in clutch pedal. Engage winch power take-off lever. Engage winch drive lever. Shift main transmission shift lever to the desired speed (including reverse). Release the clutch pedal and control winch and engine speed with accelerator pedal.

c. **Stopping the Winch.** Push in the clutch pedal. Shift the transmission lever into neutral position. Shift the winch control levers into the out position and lock them.

d. **Cable Operations.** To stack off the cable, disengage the winch drive and pull the cable from the winch drum. If the line is under a strain, put the winch in reverse as described above. The cable is reeled back on the drum, after use, in exactly the same way as making a pull. Maintain a fair amount of tension on the cable during reeling so that the cable will be tight and not kink. Make certain that the first layer of cable is wrapped smoothly with the windings close together. If necessary, hammer or push the cable in place with a block of wood to insure the first layer being closely wrapped. The remaining layers must be wound in the same manner. A cable roller and a sheave are provided to aid in this operation. Hook the cable to the line holder, and reel in until a slight tension is felt on the spring.

10. WINCH ON BRIDGE ERECTION AND CRANE TRUCKS.

a. **Controls.** This winch, mounted at the front of the vehicle, can be operated from the driver's seat. On the bridge erection truck it can also be operated from the boom operator's stand at the left rear side of the cab. When operating the bridge erection winch from the driver's seat, it is controlled by the winch drive lever, the vehicle clutch and the engine accelerator. When controlled from the boom operator's stand, it is operated by the winch power take-off lever, the declutching pedal, and the foot throttle (fig. 13).

6-TON, 6 x 6 TRUCK (WHITE, CORBITT, AND BROCKWAY)**b. Operation.**

(1) **UNWIND CABLE.** Place transfer case into neutral position. Start vehicle engine and engage winch drive lever. Push in clutch pedal, shift main transmission lever into reverse, and pull desired length of cable from winch drum. To stop unwinding, push in clutch and shift transmission into neutral.

(2) **HOOK CABLE TO LOAD.** Use the truck tow chain as a sling if the load is such that the line hook will not fasten directly. **NOTE:** *The winch cable must not be wrapped around the load with the hook around the cable, as this will damage the cable beyond repair.*

(3) **PULL LOAD.** Push in clutch pedal. Shift transmission lever to proper speed for load and conditions. Release clutch pedal and control winch speed with engine speed.

(4) **STOP WINCH AND DISCONNECT CONTROLS.** Push in clutch pedal. Shift transmission lever and winch drive lever into neutral position.

c. **Using Small Drum.** This drum is engaged by means of the drum clutch on the left end of the winch. The drum clutch operating lever is located on the clutch end of the winch. When the drum clutch is disengaged the drum turns freely on its shaft, being retarded only by the drag brake. **NOTE:** *Never attempt to disengage this clutch while the winch is under load. Always make sure the clutch is completely engaged or disengaged.* The front and rear of the chassis are equipped with rollers over which the cable should run when hooked to a load to the rear of the vehicle.

11. HYDRAULIC BOOM ON BRIDGE ERECTION TRUCK.

a. **Description.** This unit is a double-arm hydraulic boom anchored to the rear of the body. When not used it rests on stop plates at the front of the body. The boom travels in a vertical arc of approximately 150°, and is operated from a stand at the left rear of the cab.

b. Operation.

(1) **PREPARE VEHICLE FOR BOOM OPERATION.** Push down vehicle foot brake pedal, and lock pedal and brake with the latch under the pedal. Place transmission gearshift lever in neutral position, and start the engine. If cold, allow it to warm to operating temperature. Pull the operator's stand from behind the left side of the cab and lay it in a horizontal position toward the front of the vehicle.

(2) **PREPARE CONTROLS FOR BOOM OPERATION** (fig. 15). Pull rear cylinder valve lever (A) toward outside of vehicle, opening valves on rear lower power cylinders. Push down power take-off clutch pedal (D), disengaging clutch. Unfasten latch (E) on transmission power take-off lever (B), engaging power take-off to the transmission. Remove foot from clutch pedal, engaging clutch and operating hydraulic pump.

AUXILIARY EQUIPMENT CONTROLS AND OPERATION



A—REAR CYLINDER VALVE LEVER

B—TRANSMISSION POWER TAKE-OFF
LEVER

C—OPERATING LEVER

D—POWER TAKE-OFF CLUTCH LEVER

E—POWER TAKE-OFF LEVER LATCH

F—FOOT THROTTLE PEDAL

RAPD 306002

Figure 73—Boom Operating Controls

6-TON, 6 x 4 TRUCK (WHITE, CORBITT, AND BROCKWAY)

(3) **OPERATE BOOM** (fig. 15). Push operating lever (C) toward rear of vehicle. Hold in place to swing boom toward the rear of the vehicle. Control speed of boom operation with foot throttle pedal (F). The boom can be stopped at any point by releasing pressure on operating lever (C). To reverse the operation of the boom for forward travel, pull the operating lever (C) toward the front of the vehicle.

r. **Prepare Boom for Traveling** (fig. 15). Place boom in rest position on front body step plates. Push valve rod (A) toward center of vehicle. Operate the boom through a complete operating cycle (front, to back, to front position). This will place the lower cylinder rams in the cylinders, preventing rust and dirt accumulation on these units. Disengage the power take-off clutch and lock the power take-off hydraulic pump lever (B) with the latch (E). Raise operator's stand to vertical position and push into recess behind cab.

Section V

OPERATION UNDER UNUSUAL CONDITIONS

	Paragraph
Vehicle care and operation in extreme heat	12
Vehicle care and operation in extreme cold	13
Vehicle care and operation in sandy terrain	14
Vehicle operation in muddy terrain or deep snow	15
Operation over rough terrain	16

12. VEHICLE CARE AND OPERATION IN EXTREME HEAT.

a. Cooling System.

- (1) Make sure the system is clean and free-flowing.
- (2) Keep water level as high as possible in the radiator tank.
- (3) Keep the water pump, and its drive, well lubricated.
- (4) Under extremely hot conditions, remove the thermostat from the water outlet pipe, allowing a more rapid passage of water through the system.
- (5) Keep the fan belt adjusted properly.
- (6) Keep the vehicle from direct sun rays at every opportunity.
- (7) If the engine becomes overheated from lack of water, allow to cool before adding water, then add in small amounts.
- (8) Keep radiator fins free of insects, leaves, and dirt.
- (9) Use only clean, clear water when filling radiator, being cautious against salt or mineral water solutions in the system.

h. Engine.

- (1) Use only the crankcase oil viscosities recommended in the lubrication guide (par. 23). Be cautious of using heavy oil in crankcase of a new engine, as low temperatures sometimes found in night desert conditions will make starting difficult.
- (2) Keep exhaust pipe completely open.
- (3) Under extreme heat conditions, remove side panels of hood.
- (4) Be sure all cylinders are firing.
- (5) Keep engine clean. Accumulations of dust and oil form an insulation against cooling air supplied by the fan.
- (6) Keep all mountings, cylinder head nuts, and all connections tight.

c. Electrical System.

- (1) BATTERIES. Never allow batteries to become heated in service above 100°F. Guard against this in extreme heat conditions by opening the battery box when running, allowing air to circulate around the batteries. If top connectors feel hot to the touch, check temperature with a dairy thermometer, as a temperature of 120° may ruin battery. If battery feels warm, turn on lights to cut down charging rate to battery. This is particularly desirable on long runs.

TM 9-813

12-13

A-TON, 6 x 6 TRUCK (WHITE, CORLITT, AND BROCKWAY)

(2) **WIRING SYSTEM.** Check carefully to detect any bare wire or other short-circuit possibilities.

(3) **IGNITION.**

(a) Check ignition timing occasionally to avoid overheating due to mistiming of ignition system (par. 83).

(b) Occasional checks for proper operation of distributor centrifugal advance, proper condition and adjustment of distributor points, and spark plugs of the proper heat range and adjustment will aid in determining cause for continuous overheating of engine.

d. **Fuel System.**

(1) Operate the engine on the most "lean" carburetor fuel adjustment that will allow full power to the engine.

(2) Keep the air cleaner and its connecting tube to the carburetor intake as clean as possible.

e. **Clutch.** Keep the clutch in proper adjustment, to avoid racing of the engine without effective power to the power train.

f. **Transmission, Transfer Case, and Driving Axles.**

(1) Keep all vent holes clean and free.

(2) Check constantly for cracks and leaks.

(3) Be sure that proper lubricants are in the units in proper quantities (par. 23).

g. **Air Brake System.**

(1) Keep all lines and units of the system clean and well lubricated.

(2) Guard against insufficient clearance of brake linings and drum to prevent rapid wear of linings and a strain on the power plant of the vehicle (par. 121).

13. VEHICLE CARE AND OPERATION IN EXTREME COLD.

a. **Engine.**

(1) Be sure that the lubricating oils are of proper recommended viscosities for the operating temperatures (par. 23).

(2) Before starting the engine, the use of heat from oil stoves or similar equipment placed on the ground under the crankcase will warm the crankcase oil and lessen resistance to starting. At very low temperatures this heat should be applied for several hours before a start is attempted.

(3) Sheltering vehicles from winds will greatly lessen time necessary to warm them for starting.

(4) Before attempting a start, make sure that everything possible has been done to assure the starting and running of the engine on the first trial. These items include the following:

(a) Heat engine to a nonfreezing temperature if possible (subpar. a (2) above).

OPERATION UNDER UNUSUAL CONDITIONS

(b) "Free" cylinders and bearings by rotating crankshaft with hand crank.

(c) Pull choke lever out as far as possible, to provide the necessary "rich" mixture.

(d) Drain cooling system and heat cooling liquid, being careful to avoid open flame. Replace liquid in the system to warm cylinder walls and combustion chamber.

(e) Heat, without open flame, applied to the air of the battery compartment, will increase the power of batteries used in starting. Keep the batteries at full charge in extreme cold, as a battery with a specific gravity of 1.200 will freeze and become useless at -15° .

(f) Be sure that fuel lines are not clogged or frozen. If necessary, heat them lightly, being extremely cautious to prevent fires.

(g) Be sure that clutch pedal is pushed down to floor and that throttle control button is pulled out $\frac{1}{2}$ inch. Keep clutch depressed until engine running is assured.

(h) When operating vehicle in continuous subzero temperatures, it is helpful to race the engine when the ignition is cut off. This will cause the removal of all half-burned gases from the combustion chambers, and leave gas vapors to aid in quick starting.

b. Brakes. Do not apply hand brake for any great length of time, as snow and ice formations may lock the brake in this position, preventing efficient operation.

c. Ignition System. Under extremely cold temperatures the amount of current required to operate the cranking motor sometimes "bleeds" the ignition system of full power to an extent that will not allow the engine to start. In cases of this kind, tow the vehicle to be started with another vehicle, keeping the towed vehicle in fourth gear with the front axle drive disconnected until the engine is running well.

14. VEHICLE CARE AND OPERATION IN SANDY TERRAIN.

a. Before leaving solid road surface, engage front wheel drive.

b. In starting with all wheels in sand, avoid having front wheels in a cramped or turning position.

c. The use of tire chains on the driving wheels will aid in obtaining traction for sand operation. If no chains are available, and emergency movement is vital, "bleed" tires of about thirty percent of their air pressure. This will increase traction. CAUTION: Bleeding should not be undertaken except in extreme emergency to prevent damage to tires on vehicle.

d. In sand storm operation, tie a single layer of medium fine knit cotton cloth (such as undershirt cloth) loosely over the oil breather holes to prevent grit from entering the crankcase. Using the same type cloth, form a loose bag over the entire air cleaner to prevent dust and grit from entering and clogging the carburetor.

4-TON, 6 x 6 TRUCK (WHITE, CORBITT, AND BROCKWAY)

15. VEHICLE OPERATION IN MUDDY TERRAIN OR DEEP SNOW.

a. When entering area where mud or snow will be encountered, place tire chains on all wheels before leaving solid road.

b. Avoid spinning wheels in starting. Start in the highest speed possible, considering the load on the vehicle.

c. Avoid making sharp turns with the front wheels.

d. If traction is unobtainable, do not continue spinning the wheels, as this will only serve to mire the vehicle more deeply.

e. When traction is impossible, utilize the winch and winch cable, if possible, to pull the truck to more solid ground. This action may be accomplished as follows:

(1) Use any stationary, solid object as an anchor. This may be a large tree, another vehicle, or similar object.

(2) Secure an anchor chain and pulley to this object, preferably thirty or forty feet in back of vehicle, and attach a standard pulley block of proper size to the chain.

(3) Unwind winch cable from drum, passing it through pulley block and returning it to rear end of truck, where the hook should be fastened through pintle hook.

(4) Operation of winch from inside of cab can then be used to pull mired truck to more solid ground.

f. When starting on slippery and icy roads, it is advisable to start truck in second or third speeds with engine running slowly until traction is secured. This action in second or third speed gives a greater initial thrust to the contact point with the road surface and offers less possibility of wheel spinning.

16. OPERATION OVER ROUGH TERRAIN.

a. Always put vehicle power train in an "all-wheel drive" position before entering rough terrain area.

b. Avoid striking rough objects such as rocks or logs with front wheels in a cramped position.

c. Always use the same speed on steep down grades as would be required in climbing the same grade. **CAUTION:** Never, under any circumstances, allow vehicle to run on a steep downward slope without first placing it in gear.

d. Avoid straddling rocks, stumps, etc., as these may strike units under the vehicle and cause damage to Uetra.

Section VI

FIRST ECHELON PREVENTIVE MAINTENANCE SERVICES

	Paragraph
Purpose	17
Before-operation service	18
During-operation service	19
At-halt service	20
After-operation and weekly service	21

17. PURPOSE.

a. To insure mechanical efficiency it is necessary that the vehicle be systematically inspected at intervals each day it is operated and weekly, so defects may be discovered and corrected before they result in serious damage or failure. Certain scheduled maintenance service will be performed at these designated intervals. The services set forth in this section are those performed by driver or crew before-operation, during-operation, at-halt, and after-operation and weekly.

b. Driver Preventive Maintenance Services are listed on the back of "Driver's Trip Ticket and Preventive Maintenance Service Record" W.D. Form No. 48 to cover vehicles of all types and models. Items peculiar to specific vehicles but not listed on W.D. Form No. 48 are covered in manual procedures under the items with which they are related. Certain items listed on the form that do not pertain to the vehicle involved are eliminated from the procedures as written into the manual. Every organization must thoroughly school each driver in performing the maintenance procedures set forth in manuals, whether or not they are listed specifically on W.D. Form No. 48.

c. The items listed on W.D. Form No. 48 that apply to this vehicle are expanded in this manual to provide specific procedures for accomplishment of the inspections and services. These services are arranged to facilitate inspection and conserve the time of the driver, and are not necessarily in the same numerical order as shown on W.D. Form No. 48. The item numbers, however, are identical with those shown on that form.

d. The general inspection of each item applies also to any supporting member or connection, and generally includes a check to see whether or not the item is in good condition, correctly assembled, secure, or excessively worn.

e. The inspection for "good condition" is usually an external visual inspection to determine whether or not the unit is damaged beyond safe or serviceable limits. The term "good condition" is explained further by the following terms: not bent or twisted, not chafed or burned, not broken or cracked, not bare or frayed, not dented or collapsed, not torn or cut.

f. The inspection of a unit to see that it is "correctly assembled" is usually an external visual inspection to see whether or not it is in its normal assembled position in the vehicle.

6-TON, 6 x 6 TRUCK (WHITE, CORBITT, AND BROCKWAY)

g. The inspection of a unit to determine if it is "secure" is usually an external visual examination, a wrench, hand-feel, or a pry-bar check for looseness. Such an inspection should include any brackets, lock washers, lock nuts, locking wires, or cotter pins used in assembly.

h. "Excessively worn" will be understood to mean worn close to, or beyond, serviceable limits, and likely to result in a failure if not replaced before the next scheduled inspection.

i. Any defects or unsatisfactory operating characteristics beyond the scope of first echelon to correct must be reported at the earliest opportunity to the designated individual in authority.

18. BEFORE-OPERATION SERVICE.

a. This inspection schedule is designed primarily as a check to see that the vehicle has not been damaged, tampered with, or sabotaged since the After-operation Service was performed. Various combat conditions may have rendered the vehicle unsafe for operation, and it is the duty of the driver to determine whether or not the vehicle is in condition to carry out any mission to which it is assigned. This operation will not be entirely omitted, even in extreme tactical situations.

b. **Procedures.** Before-operation Service consists of inspecting items listed below according to the procedure described, and correcting or reporting any deficiencies. Upon completion of the service, results should be reported promptly to the designated individual in authority.

(1) **ITEM 1, TAMPERING AND DAMAGE.** Look for any injury to the vehicle, its accessories or equipment, caused by tampering or sabotage, collision, falling debris, or shell fire since parking. Look in engine compartment for evidence of above conditions, and for loosened or damaged engine accessories or drive belts, loose fuel, oil or coolant lines, or disconnected control linkage.

(2) **ITEM 2, FIRE EXTINGUISHER.** See that it is fully charged, securely mounted and not damaged, and look for evidence of leakage.

(3) **ITEM 3, FUEL, ENGINE OIL, AND COOLANT SUPPLY.** Check fuel supply in tank. Check crankcase oil level on dip stick, and coolant condition and level in radiator. Replenish as necessary including all spare cans. **NOTE:** Any appreciable drop in levels since After-operation Service should be investigated, and cause corrected or reported. If any great amount of water has to be added during period when antifreeze is in use, have hydrometer test made of mixed coolant.

(4) **ITEM 4, ACCESSORIES AND DRIVES.** Examine units, such as carburetor, generator, cranking motor, air compressors, fan and air cleaner for looseness, damage or leaks. Be sure drive belts are in good condition, and that adjustment provides $\frac{1}{8}$ -inch finger-pressure deflection.

(5) **ITEM 5, AIR BRAKE AND PONTOON INFLATION TANKS.** Check reservoir tanks for damage, secure mountings, and tight airline con-

FIRST ECHELON PREVENTIVE MAINTENANCE SERVICES

nections. Be sure water has been drained from the tanks and that petcocks are closed.

(6) **ITEM 6, LEAKS -GENERAL.** Inspect on ground, under vehicle and in engine compartment for leaks, particularly at fuel tanks and lines, crankcase and oil filters, radiator, water pump, water lines and connections, and all gear cases. Trace any leaks found to source, and correct or report them.

(7) **ITEM 8, CHOKE.** As engine is being started, observe if choke valve opens and closes in response to operation of control.

(8) **ITEM 7, ENGINE WARM-UP.** Start engine and note any tendency toward hard starting. Observe action of cranking motor, particularly if it has adequate cranking speed and engages and disengages without unusual noise when in operation. Set hand throttle to idle engine at 450 to 500 revolutions per minute, and during warm-up proceed with following Before-operation Services. **NOTE:** If oil pressure is not evident in 30 seconds, stop engine and investigate. As engine warms up reset choke as required for engine to run smoothly, and to prevent overchoking and oil dilution.

(9) **ITEM 9, INSTRUMENTS.**

(a) **Oil Gage.** Pressure at normal engine operating speed should be 25 to 35 pounds, and 15 pounds minimum at idle speed, 400 revolutions per minute.

(b) **Ammeters.** Regular ammeter should show positive (+) charge with engine at fast idle, and at slower speeds with lights on may show on negative (-) side. "B" ammeter indicates that second battery or "B" battery is charging or discharging. High charge readings may be indicated until generator restores to batteries current used in starting engine.

(c) **Engine Temperature Gage.** Reading should increase gradually during warm-up period to normal operating range, 150°F to 180°F. Maximum safe temperature, 200°F. **NOTE:** Do not move vehicle until temperature reaches minimum operating temperature 135°F.

(d) **Viscometer.** After engine has reached operating temperature reading should be in "ideal" range.

(e) **Tachometer.** White pointer should indicate actual engine revolutions per minute at any given time engine is running. Red hand indicates and remains at highest engine revolutions per minute reached. Should not exceed 2200 revolutions per minute.

(f) **Air Pressure Gage.** Do not move vehicle until gage registers 80 pounds pressure. Low pressure indicator (buzzer) should sound at pressures below 50 pounds. Operating pressure is 85 to 105 pounds.

(g) **Fuel Gage.** Inspect to see that gage registers the approximate amount of fuel in tanks. Ordinarily tanks will be filled after operation, and gage should register "FULL".

(10) **ITEM 10, HORN AND WINDSHIELD WIPERS.** If tactical situation permits, test horn for proper operation and tone. Test wipers to see that they operate, and observe whether the blades contact glass evenly and arms travel through full stroke. Inspect for damage.

6-TON, 6 x 6 TRUCK (WHITE, CORBITT, AND BROCKWAY)

(11) **ITEM 11, GLASS AND REAR-VISION MIRRORS.** Clean all glass and inspect for damage. Aim rear-vision mirrors properly and see that they are secure.

(12) **ITEM 12, LAMPS (LIGHTS) AND REFLECTORS.** See that all lamps and warning reflectors are clean. Examine them for looseness or damage. If tactical situation permits, open and close switches and observe if lamps respond properly. Include stop and blackout lamps.

(13) **ITEM 13, WHEEL AND FLANGE NUTS.** See that all wheel mounting and axle flange nuts are present and secure.

(14) **ITEM 14, TIRES.** Pressure 70 pounds (maximum) cool for 10.00 x 22; 80 pounds for 12.00 x 20, and 90 pounds for 14.00 x 20 tires. Inspect tires, including spars, for damage, and remove any embedded objects from treads, across, or between duals. **NOTE:** Reduce air pressure of rear tires to 14 pounds on boom-equipped vehicles during operation of boom.

(15) **ITEM 15, SPRINGS AND SUSPENSIONS.** Inspect springs or walking beams to see that they are secure and not damaged, and that all assembly and mounting nuts and screws are tight. Inspect spring seats for excessive lubricant leakage.

(16) **ITEM 16, STEERING LINKAGE.** Inspect all arms, rods, and joints for looseness or damage, and gear case for loose mountings and excessive lubricant leaks.

(17) **ITEM 17, FENDERS AND BUMPER.** Inspect for looseness or damage.

(18) **ITEM 18, TOWING CONNECTIONS.** Inspect all towing devices for looseness or damage. Examine pintle to be sure it operates freely and locks securely.

(19) **ITEM 19, BODY, LOAD, AND TARPS.** Inspect cab and top tarpaulin for damage. See that windshield, doors and latches operate properly. See that cargo is secure, and properly stowed.

(20) **ITEM 20, DECONTAMINATOR.** Be sure it is present, fully charged and secure.

(21) **ITEM 21, TOOLS AND EQUIPMENT.** Be sure all items are present, serviceable, and properly mounted or stowed.

(22) **ITEM 22, ENGINE OPERATION.** Before vehicle is put in motion, be sure engine has reached minimum operating temperature (135°F) and idles smoothly. Accelerate and decelerate, and listen for any unusual vibration or noise. Note any unsatisfactory operating characteristics, or excessive exhaust smoke.

(23) **ITEM 23, DRIVER'S PERMIT AND FORM 26.** Driver must have his operator's permit on his person. Check to see that accident form No. 26, operator's manual, W.D., A.O.O. 47B, and Lubrication Guide are present in vehicle, legible, and properly stowed.

(24) **ITEM 25, DURING OPERATION CHECK.** The During-operation Services and observations start immediately the vehicle is put in motion as follows.

FIRST ECHELON PREVENTIVE MAINTENANCE SERVICES**19. DURING-OPERATION SERVICE.**

a. While vehicle is in motion, listen for any such sounds as rattles, knocks, squeals, or hums that may indicate trouble. Look for indications of trouble in cooling system, and smoke from any part of the vehicle. Be on the alert to detect any odor of overheated components or units such as generator, brakes or clutch, fuel vapor from a leak in fuel system, exhaust gas or other signs of trouble. Each time the brakes are used, gears shifted, or vehicle turned, consider this a test and notice any unsatisfactory or unusual performance. Watch the instruments constantly. Notice promptly any unusual instrument indications that may signify possible trouble in the system to which the instrument applies.

b. **Procedures.** During-operation Services consist of observing items listed below according to the procedures following the instructions in each item, and investigating any indications of serious trouble. Notice minor deficiencies to be corrected, or reported, at earliest opportunity, usually at next scheduled halt.

(1) **ITEM 27, FOOT AND HAND BRAKES.** Foot brakes should stop vehicle smoothly and effectively with normal pedal pressure, and return to "OFF" position immediately foot pressure is released. If towed vehicle is connected, test hand-operated air application valve or electric brake control unit separately, and note if brake action on trailer is satisfactory. On vehicles so equipped, see that foot brake locking latch holds pedal in applied position. Hand brake should hold vehicle on a reasonable incline, leaving $\frac{1}{2}$ ratchet travel in reserve, and should lock securely in applied position.

(2) **ITEM 28, CLUTCH.** Clutch should not grab, chatter or squeal during engagement, or slip when fully engaged under load. Pedal should have $1\frac{1}{2}$ -inch free travel before meeting resistance.

(3) **ITEM 29, TRANSMISSION.** Gears should shift smoothly, without unusual noise, and should not creep out of mesh during operation.

(4) **ITEM 30, TRANSFER.** Transfer unit range gears and declutching mechanism should shift easily, without unusual noise and not creep out of mesh during operation.

(5) **ITEM 31, ENGINE AND CONTROLS.** The driver must be on the alert for deficiencies in engine performance such as lack of usual power, misfiring or stalling, unusual noise or vibration, indications of overheating, or excessive exhaust smoke. Observe if engine responds to all controls, and if controls operate without excessive looseness or binding.

(6) **ITEM 32, INSTRUMENTS.** Observe readings of all instruments frequently during operation to be sure units to which they apply are functioning satisfactorily.

(a) **Oil Pressure Gage.** Should show normal operating pressure, 15 pounds minimum at idle, and 25 to 35 pounds at operating vehicle speeds.

(b) **Ammeters.** During operation with all lamps and accessories turned off the main ammeter should indicate a positive (+) charge

6-TON, 6 x 6 TRUCK (WHITE, CORBITT, AND BROCKWAY)

at operating speed, or with fully charged batteries and regulator unit cut in may register zero. "B" ammeter should also show positive (+) or zero charge. Investigate or report continued negative (-) readings.

(c) *Engine Temperature Gage.* This gage should read in normal operating range, 160°F to 180°F.

(d) *Viscometer.* During operation viscometer pointer should remain in "ideal" range. Abnormal readings must be investigated or reported.

(e) *Air Pressure Gage.* Maximum reading should be 105 pounds, minimum 60 pounds.

(f) *Tachometer.* White pointer should register actual engine revolutions per minute, and red pointer should not exceed maximum governed speed, 2200 revolutions per minute.

(g) *Speedometer.* Pointer should indicate vehicle speed, and odometer should register accumulating mileage.

(h) *Fuel Gage.* Fuel gage should continue to register approximate amount of fuel in tanks.

(7) **ITEM 33, STEERING GEAR.** Note any indication of looseness or binding, pulling to one side, wandering, shimmy, wheel tramp or unusual noise.

(8) **ITEM 34, RUNNING GEAR.** Be on alert for any unusual operating characteristics or noise from wheels, axles, or suspension units that might indicate looseness or damage, or underinflated tires.

(9) **ITEM 35, BODY.** Note any noise or abnormal condition that might indicate shifting of body or load, loose top tarpaulin or curtains, loose or damaged doors, hardware, floor plates or mounted body attachments.

20. AT-HALT SERVICE.

a. At-halt Services may be regarded as minimum maintenance procedures, and should be performed under all tactical conditions even though more extensive maintenance services must be slighted, or omitted altogether.

b. *Procedures.* At-halt Services consist of investigating any deficiencies noted during operation, inspecting items listed below according to the procedures following the items, and correcting any deficiencies found. Deficiencies not corrected should be reported promptly to the designated individual in authority.

(1) **ITEM 38, FUEL, OIL, AND WATER SUPPLY.** Check fuel, oil and coolant supply, and replenish as necessary. When refueling, use safety precautions for grounding static electricity, and allow space for expansion in filler neck. Fuel tank filler-cap vents must be open, radiator pressure-cap valves must be free, and caps must be replaced securely. **CAUTION: Remove radiator cap cautiously. Do not fully remove until steam has escaped. If engine is hot, fill slowly while engine is running at a fast idle.**

(2) **ITEM 39, TEMPERATURES: HUBS, BRAKE DRUMS, TRANSFER, TRANSMISSION AND AXLES.** Place hand cautiously on each brake

FIRST ECHELON PREVENTIVE MAINTENANCE SERVICES

drum and wheel hub to see if it is abnormally hot. Inspect transfer case, transmission and axle housings for overheating, and note any excessive lubricant leaks.

(3) **ITEM 40, AXLE AND TRANSFER VENTS.** Wipe clean and inspect vents for damage or clogging. Vents must be kept open.

(4) **ITEM 41, PROPELLER SHAFTS.** Inspect all drive shafts and universal joints for looseness, damage and excessive lubricant leaks. Remove any foreign matter wound around shafts or joints.

(5) **ITEM 42, SPRINGS AND SUSPENSIONS.** Inspect for broken or shifted spring leaves, damaged or loose walking beam, or U-bolts, eyebolts, shackles, rebound clips and torque rods.

(6) **ITEM 43, STEERING LINKAGE.** Examine all steering control mechanism, arms, and linkage joints for looseness or damage. Investigate any unusual condition noted during operation.

(7) **ITEM 44, WHEEL AND FLANGE NUTS.** See that all wheel mounting and axle flange nuts are present and secure.

(8) **ITEM 45, TIRES.** Inspect all tires for underinflation or damage. Remove embedded objects in treads or carcasses and from between duals. See that spare is inflated and secure in carrier.

(9) **ITEM 46, LEAKS—GENERAL.** Look under vehicle and within engine compartment for indications of fuel, oil or coolant leaks. Trace any found to their source and correct or report them.

(10) **ITEM 47, ACCESSORIES AND BELTS.** Examine all accessible units for looseness or damage. Be sure drive belts have $\frac{1}{4}$ -inch finger-pressure deflection.

(11) **ITEM 48, AIR CLEANERS.** If operating under extremely dusty or sandy conditions, inspect air cleaner and breather cap to see that they are in condition to deliver clean air properly. Service as necessary.

(12) **ITEM 49, FENDERS AND BUMPER.** Inspect front bumper, fenders and rear splash guards for looseness or damage.

(13) **ITEM 50, TOWING CONNECTIONS.** Inspect all connections for looseness or damage. Be sure locking devices are secure, and that trailer brake air hose is supported so as not to chafe on other vehicle parts.

(14) **ITEM 51, BODY, LOAD, AND TARPULIN.** Inspect for damage, or indications of looseness or stuffing.

(15) **ITEM 52, GLASS.** Clean all windshield, mirror, light, and warning reflector glass, and inspect for damage.

21. AFTER-OPERATION AND WEEKLY SERVICE.

a. After-operation Servicing is particularly important because at this time the driver inspects his vehicle to detect any deficiencies that may have developed, and corrects those he is permitted to handle. He should report promptly, to the designated individual in authority, the results of his inspection. If this schedule is performed thoroughly, the vehicle should be ready to roll again on a moment's notice. The Before-operation Service, with a few exceptions, is then necessary

6-TON, 6 x 6 TRUCK (WHITE, CORBITT, AND BROCKWAY)

only to ascertain whether the vehicle is in the same condition in which it was left upon completion of the After-operation Service. The After-operation Service should never be entirely omitted even in extreme tactical situations, but may be reduced to the bare fundamental services outlined for the At-halt Service if necessary.

b. **Procedures.** When performing the After-operation Service, the driver must remember and consider any irregularities noticed during the day in the Before-operation, During-operation, and At-halt Services. The After-operation Service consists of inspecting and servicing the following items. Those items of the After-operation Service that are marked by an asterisk (*) require additional weekly services, the procedures for which are indicated in step (b) of each applicable item.

(1) **ITEM 55, ENGINE OPERATION.** Test engine for satisfactory performance and smooth idle. Accelerate and decelerate engine and note any tendency to miss or backfire. Listen for any unusual noise or vibration that may indicate worn or inadequately lubricated parts, loose mountings, incorrect fuel mixture or faulty ignition. Note any unusual exhaust smoke. Investigate and correct or report any deficiencies noted during operation.

(2) **ITEM 56, INSTRUMENTS.** Check all pertinent instruments to be sure they are operating properly and continue to register or indicate correct performance of the units to which they apply.

(3) **ITEM 54, FUEL, OIL AND WATER SUPPLY.** Fill fuel tanks. See if fuel gage indicates full. Check crankcase oil and add as necessary to bring to correct level. Check coolant level and add as necessary to bring to correct level. On vehicles equipped with an auxiliary compressor check crankcase oil level and add as necessary. **NOTE:** Do not overfill fuel tanks or radiator. Allow room for expansion. In freezing weather if any appreciable amount of coolant is necessary, have antifreeze value checked and add sufficient to protect cooling system against freezing. Do not add coolant while engine is too hot. Fill all spare fuel, oil and water cans if supply has been used.

(4) **ITEM 57, HORN AND WINDSHIELD WIPERS.** Inspect to see if these items are secure and not damaged. If tactical conditions permit, test horn for proper operation and tone.

(5) **ITEM 58, GLASS AND REAR-VISION MIRROR.** Clean and inspect for damage, and see that mountings are secure.

(6) **ITEM 59, LAMPS (LIGHTS) AND REFLECTORS.** Inspect for looseness or damage. If tactical situation permits test all lamps and switches for proper operation. Clean lenses.

(7) **ITEM 60, FIRE EXTINGUISHER.** Inspect for looseness or damage and full charge. If extinguisher has been in use, or if valves have been opened, report for refill or exchange.

(8) **ITEM 61, DECONTAMINATOR.** Inspect for looseness or damage and full charge. If used, report for refill or exchange.

(9) **ITEM 62, *BATTERIES.**

(a) Inspect batteries to see that they are clean, secure, and not leaking or damaged. See that cell caps are fingertight.

FIRST ECHOLON PREVENTIVE MAINTENANCE SERVICES

(b) *Weekly.* Clean dirt from top of batteries. If terminal connections or posts are corroded, clean them thoroughly and apply a thin coating of grease. Tighten terminal bolts if loose. Check level of electrolyte, and add water if required. During freezing weather do not add water until just before operation. Battery should be secure, not bulging or leaking electrolyte; battery carrier should be secure, clean, free of rust, and well painted. Tighten mountings cautiously. Report any defects.

(10) **ITEM 63, ACCESSORIES AND BELTS.** Inspect units such as carburetor, generator, cranking motor, fan, water pump, compressors, distributor, regulator unit and oil filters, for looseness, damage or leaks. Check condition and adjustment of drive belts. Belts should have $\frac{1}{4}$ -inch finger-pressure deflection. Investigate and correct or report any deficiencies of accessory units or drives noted during operation.

(11) **ITEM 64, ELECTRICAL WIRING.** Inspect all ignition wiring for looseness or damage, wipe off excessive grease or moisture. Also make an inspection of all accessible low voltage wiring and connections for looseness or damage and be sure all wiring is supported, so as not to chafe against other vehicle parts.

(12) **ITEM 65, *AIR CLEANER AND BREATHER CAPS.**

(a) Inspect for looseness or damage. Examine oil in reservoirs for correct level and excessive dirt. When operating in sandy or dusty conditions, clean and service air cleaner and breather cap as often as necessary.

(b) *Weekly.* Remove carburetor, air compressor, and crankcase reservoirs and elements, wash in dry-cleaning solvent, refill reservoirs with clean oil and reinstall securely. Be sure all gaskets seal properly and that joints and connections are secure.

(13) **ITEM 66, *FUEL FILTER.**

(a) Inspect for looseness, damage and fuel leaks.

(b) *Weekly.* Remove sediment bowl drain plug and drain off all accumulated dirt and water. If draining of fuel pump sediment bowl shows excessive dirt or water, remove and clean element in dry-cleaning solvent. When excessive water is present report to higher echelon for draining of fuel tanks.

(14) **ITEM 67, ENGINE CONTROLS.** Examine all engine operating control linkage for looseness, damage, excessive wear, and adequate lubrication.

(15) **ITEM 68, *TIRES.**

(a) Examine all tires including spares for damage and excessive wear. Remove all embedded foreign matter, such as nails, glass, or stones, from treads and carcasses, and from between duals. Check for low pressures, proper position of valve stems, and presence of valve caps. Inflate to correct pressure as needed, 70 pounds (maximum) cool for 10.00 x 22, 80 pounds for 12.00 x 20, and 90 pounds for 14.00 x 20 tires.

(b) *Weekly.* Replace badly worn or otherwise unserviceable tires. Serviceable tires which show abnormal wear should be relocated

4-TON, 6 x 6 TRUCK (WHITE, CORNITT, AND BROCKWAY)

to other wheels to even wear. Apparent mechanical deficiencies causing such wear should be reported for attention by higher echelon.

(16) **ITEM 69, SPRINGS AND SUSPENSIONS.** Inspect springs, walking beams, and torque rods for looseness or damage. Examine springs for abnormal sag or shifted leaves. Investigate any noise or unusual condition noted during operation.

(17) **ITEM 70, STEERING LINKAGE.** Inspect for looseness or damage. Examine steering gear case for excessive lubricant leakage, and joints in linkage for lack of lubrication. Investigate any unusual condition noted during operation.

(18) **ITEM 71, PROPELLER SHAFTS.** Inspect all drive shafts and universal joints for looseness or damage, and for excessive oil leaks. Remove any foreign material wound around shafts or joints.

(19) **ITEM 72, *AXLE AND TRANSFER VENTS.**

(a) See that all axle housing and transfer case vents are present, in good condition and clean. Inspect for indications of excessive lubricant leakage from vents.

(b) *Weekly.* Remove vents and clean out passages. Reinstall securely.

(20) **ITEM 73, LEAKS—GENERAL.** Look in engine compartment and under vehicle for indications of fuel, engine oil, coolant, or gear oil leaks.

(21) **ITEM 74, GEAR OIL LEVELS.** Check gear oil levels in differentials, transfer case, transmission and steering gear housing, and report if low. Correct levels are from lower edge of filler hole to $\frac{1}{2}$ inch below when cool.

(22) **ITEM 75, *AIR BRAKE TANKS.**

(a) Inspect tanks and lines for looseness or damage. Open reservoir drain cocks and drain off all accumulated water.

(b) *Weekly.* Tighten tank mountings and line connections. Clean air line rubber hose of all grease or oil.

(23) **ITEM 76, FENDERS AND BUMPERS.** Inspect front fenders, bumper, and rear splash guards for looseness or damage.

(24) **ITEM 77, TOWING CONNECTIONS.** Inspect towing hooks or shackles, and pintle hooks for looseness, excessive wear or damage.

(25) **ITEM 78, BODY, LOAD AND TARPS.** Inspect body carefully for damage or loose parts. Examine top tarpaulin and side curtains for worn spots or other damage, and see that they are secure. Load must be secure and properly stowed.

(26) **ITEM 79, WINCH.**

(a) Examine winch assembly for looseness or damage and excessive oil leaks at worm gear housing. See that winch drive shaft shear pin is in good condition and secure. Be sure sliding clutch operates freely and locks securely.

(b) *Weekly.* If vehicle has been operated in deep water, sample lubricant for contamination. If water is present, report condition. Set truck at the top of a steep bank. Fasten the winch line to a vehicle at the bottom of the bank. Start pulling the vehicle up the bank.

FIRST ECHELON PREVENTIVE MAINTENANCE SERVICES

Throw out the engine clutch; if vehicle starts to back down, the winch brake needs adjusting. Start lowering the vehicle down the bank; throw out engine clutch; if vehicle does not stop or drifts more than one or two inches, winch brake needs adjusting. If winch cable is dry or wound unevenly, unwind entire length, clean with thin oil or kerosene, rewind evenly on winch drum applying a thin coat of engine oil while winding, and secure cable chain and hook securely to front tow hooks. NOTE: *Used oil is satisfactory, if clean.*

(27) ITEM 82, *TIGHTENING.

(a) Tighten any mounting or external assembly nuts or screws where inspection of vehicle has indicated the necessity.

(b) *Weekly.* Tighten wheel mounting and axle flange nuts, cap screws, spring U-bolts, eyebolts, shackles, rebound clips, universal joint companion flanges, engine mountings, transfer case mountings, steering arms, towing connections, or any other mounting or assembly nuts or screws that inspection or experience indicates are necessary on a weekly or mileage basis.

(28) ITEM 83, *LUBRICATE AS NEEDED.

(a) Lubricate all items such as shackles, hinges, latches, control linkage frictional joints, or any point where inspection has indicated oilcan or hand greasing is needed.

(b) *Weekly.* Lubricate all points of the vehicle indicated on the Lubrication Guide as needing lubrication on a weekly or a mileage basis.

(29) ITEM 84, *CLEAN ENGINE AND VEHICLE.

(a) Clean dirt and grease or oil drippings from inside cab, and from engine compartment and exterior of engine. Wipe off excess dirt and grease from entire vehicle.

(b) *Weekly.* Wash vehicle when possible. If not possible, wipe off thoroughly. Inspect paint or camouflage pattern for rust or for bright spots which might cause light reflections. See that vehicle markings are legible unless covered for tactical reasons. CAUTION: *If vehicle is driven into water for washing, care must be taken to see that water or dirt does not get into wheel bearings, gear cases or brakes, or on electrical units or wiring.*

(30) ITEM 85, *TOOLS AND EQUIPMENT.

(a) Check vehicle stowage and tool lists to see that all items are present (pars. 24 and 25). Inspect items to see that they are in good condition, and properly mounted or stowed.

(b) *Weekly.* Clean all tools and equipment of rust or dirt, and apply preservative where necessary, and when possible. See that tools with cutting edges are sharp and properly protected, and that all items are securely mounted or stowed.

6-TON, 6 x 6 TRUCK (WHITE, CORBITT, AND BROCKWAY)

Section VII

LUBRICATION

	Paragraph
Lubrication Guide	22
Detailed lubrication instructions	23

22. LUBRICATION GUIDE.

a. War Department Lubrication Guides Nos. 506, 518, and 521 (figs. 16 through 21) prescribe lubrication maintenance for these vehicles.

b. A Lubrication Guide is placed on or is issued with each item of materiel, and is to be carried with it at all times. In the event the materiel is received without a Guide, the using arm shall immediately requisition a replacement from the Commanding Officer, Fort Wayne Ordnance Depot, Detroit 32, Michigan.

c. Lubrication instructions on the Guide are binding on all echelons of maintenance and there shall be no deviations, except as indicated in subparagraph d below.

d. Service intervals specified on the Guide are for normal operating conditions. Reduce these intervals under extreme conditions such as excessively high or low temperatures, prolonged periods of high-speed operation, continued operation in sand or dust, immersion in water or exposure to moisture, any one of which may quickly destroy the protective qualities of the lubricant.

e. Lubricants are prescribed in the "Key" in accordance with three temperature ranges: above +32°F, +32°F to 0°F, and below 0°F. Determine the time to change grades of lubricants by maintaining a close check on operation of the vehicles during the approach to changeover periods, especially during initial action. Sluggish starting is an indication of thickened lubricants, and is the signal to change to grades prescribed for the next lower temperature range. Ordinarily it will be necessary to change grades of lubricants *only when air temperatures are consistently in the next higher or lower range, unless malfunctioning occurs sooner due to lubricants being too thin or too heavy.*

f. *Localized Views.* Figures 22 through 26 are localized views of lubrication points that apply to all of the vehicles. The localized views are keyed to the Lubrication Guides to facilitate proper lubrication.

23. DETAILED LUBRICATION INSTRUCTIONS.

a. Lubrication Equipment.

(1) Each piece of materiel is supplied with lubrication equipment adequate to maintain the materiel. Clean this equipment both before and after use.

LUBRICATION

(7) Operate lubrication guns carefully and in such manner as to ensure a proper distribution of lubricant.

b. Points of Application.

(1) Lubrication fittings, grease cups, oilers, and oil holes are readily identifiable on the materiel by a red circle. Such lubricators and the surrounding surface must be wiped clean before lubricant is applied.

(2) Where relief valves are provided, apply new lubricant until the old lubricant is forced from the vent. Exceptions are specified in notes on the Lubrication Guide.

c. Cleaning. Use SOLVENT, dry-cleaning, or OIL, fuel, Diesel to clean or wash all parts. CAUTION: Use of gasoline for this purpose is prohibited. After washing thoroughly, dry all parts before applying lubricant.

d. Lubrication Notes on Individual Units and Parts (White). The following instructions supplement those notes on the Lubrication Guides (figs. 15 and 17) which pertain to lubrication and service of individual units and parts of the White vehicle.

(1) AIR CLEANERS.

(a) *Oil Bath Type.* Daily, check level and refill engine air cleaner oil reservoir to head level with used crankcase oil or OIL, engine, SAE 30 above +32°F, SAE 10 from +32°F to 0°F. From 0°F to -40°F, use OIL, hydraulic or FLUID, shock absorber, light. Below -40°F remove oil and operate dry. Every 1,000 miles, daily under extreme dust conditions, remove air cleaners and wash all parts. CAUTION: Keep all connections clean and tight.

(b) *Element Type.* Daily, check air compressor air cleaner and clean if necessary. Every 1,000 miles, wash curled hair, dry and reoil with used crankcase oil or OIL, engine SAE 30 above +32°F, SAE 10 from +32°F to 0°F. From 0°F to -40°F, use OIL, hydraulic or FLUID, shock-absorber, light. Below -40°F, wash and replace dry.

(2) BREATHERS AND VENTS.

(a) *Breathers.* Every 1,000 miles, remove crankcase breather cap, wash thoroughly, dry and reoil with used crankcase oil or OIL, engine, SAE 30 above +32°F, SAE 10 from +32°F to 0°F. From 0°F to -40°F, use OIL, hydraulic or FLUID, shock-absorber, light. Below -40°F, wash and replace dry.

(b) *Vents.* Keep gear case, axle housing, and transfer case vents clean at all times. Inspect each time oil is checked and each time truck is operated under extremely dirty or muddy conditions. Every 1,000 miles, remove brake governor and air line strainers located on the cowl under hood, and dismantle and clean the screens. Every 12,000 miles, wash cab ventilator air cleaner filter screen in water.

(3) CLUTCH PILBY BRAKING. Whenever clutch is disassembled for any other purpose, remove, clean, and repack.

(4) CRANKCASE. Daily, check level and refill to "FULL" mark with OIL, engine, SAE 30 above +32°F, or SAE 10 from +32°F to

6-TON, 6 x 6 TRUCK (WHITE, CORBITT, AND BROCKWAY)

WAR DEPARTMENT LUBRICATION GUIDE

CORPORATION DEPARTMENT

TRUCK, 6 TON, 6 x 6 (WHITE)

No. 504

NOTE: See Remarks Made for Lubrication of Machine

NOTE: See Remarks Made for Lubrication of Machine

NOTE: See Remarks Made for Lubrication of Machine

Check parts and OIL WEIGHT, dry-weights for OIL, and DRAIN. Dry before lubricating.

Lubricate shafts and rollers on both sides. Oil possible parts for clean by hand means.

A, Fig. 22

B, Fig. 22

C, Fig. 23

C, Fig. 23

E, Fig. 23

G, Fig. 23

H, Fig. 23

G, Fig. 24

H, Fig. 24

K, Fig. 22

G, Fig. 24

C, Fig. 23

F, Fig. 25

A, Fig. 25

1 CB Front Main Hook

2 Front Axle Greased Drive Shaft (See Note)

3 Front Axle Differential Oil Level (See Note)

4 Serviced Press (Slider Head)

5 WF Fan Hub

6 OC Governor (See Note)

7 CB Engine Water Support

8 CB Governor Oil

9 CB Distribution Shaft

10 CB Distributor (See Note)

11 CB Fuel Injector Governor

12 CB Fuel Injector Governor

13 WP Water Pump (See Note)

14 Governor Drive (See Note)

15 CB Air Cleaner

16 CB Governor Oil

17 CB Governor Oil

A, Fig. 22

B, Fig. 22

C, Fig. 23

C, Fig. 23

E, Fig. 23

G, Fig. 23

H, Fig. 23

G, Fig. 24

H, Fig. 24

K, Fig. 22

G, Fig. 24

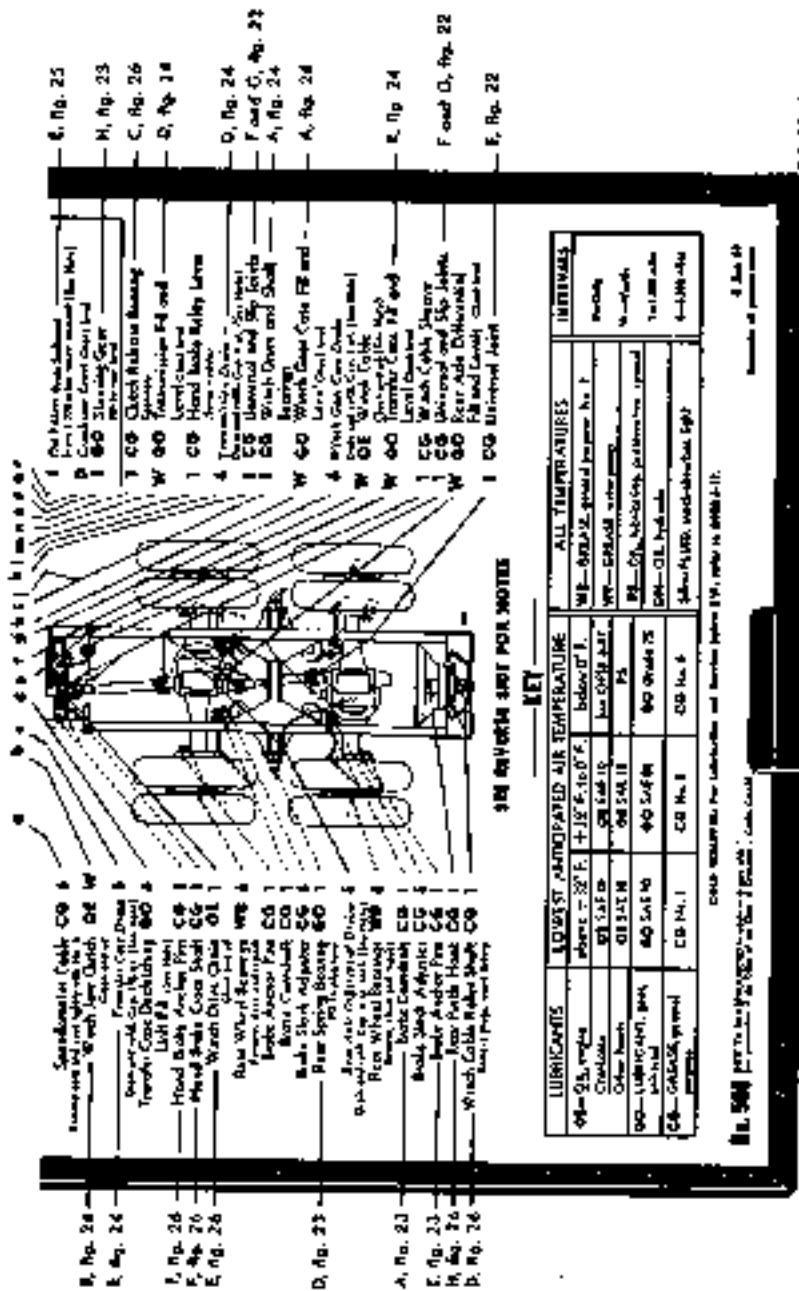
C, Fig. 23

F, Fig. 25

A, Fig. 25

8-49 PD 3300880

LUBRICATION



- 6. Fig. 25 Oil Motor Stock Lubricant
- H. Fig. 23 Grease (See Fig. 23) and Grease
- C. Fig. 26 Grease
- D. Fig. 24 Grease
- D. Fig. 24 Grease
- F and G, Fig. 22 Grease
- A, Fig. 24 Grease
- A, Fig. 24 Grease
- R, Fig. 24 Grease
- F and D, Fig. 22 Grease
- F, Fig. 22 Grease

- 1 Oil Motor Stock Lubricant
- 2 Grease (See Fig. 23) and Grease
- 3 Grease
- 4 Grease
- 5 Grease
- 6 Grease
- 7 Grease
- 8 Grease
- 9 Grease
- 10 Grease
- 11 Grease
- 12 Grease
- 13 Grease
- 14 Grease
- 15 Grease
- 16 Grease
- 17 Grease
- 18 Grease
- 19 Grease
- 20 Grease
- 21 Grease
- 22 Grease
- 23 Grease
- 24 Grease
- 25 Grease
- 26 Grease
- 27 Grease
- 28 Grease
- 29 Grease
- 30 Grease
- 31 Grease
- 32 Grease
- 33 Grease
- 34 Grease
- 35 Grease
- 36 Grease
- 37 Grease
- 38 Grease
- 39 Grease
- 40 Grease
- 41 Grease
- 42 Grease
- 43 Grease
- 44 Grease
- 45 Grease
- 46 Grease
- 47 Grease
- 48 Grease
- 49 Grease
- 50 Grease
- 51 Grease
- 52 Grease
- 53 Grease
- 54 Grease
- 55 Grease
- 56 Grease
- 57 Grease
- 58 Grease
- 59 Grease
- 60 Grease
- 61 Grease
- 62 Grease
- 63 Grease
- 64 Grease
- 65 Grease
- 66 Grease
- 67 Grease
- 68 Grease
- 69 Grease
- 70 Grease
- 71 Grease
- 72 Grease
- 73 Grease
- 74 Grease
- 75 Grease
- 76 Grease
- 77 Grease
- 78 Grease
- 79 Grease
- 80 Grease
- 81 Grease
- 82 Grease
- 83 Grease
- 84 Grease
- 85 Grease
- 86 Grease
- 87 Grease
- 88 Grease
- 89 Grease
- 90 Grease
- 91 Grease
- 92 Grease
- 93 Grease
- 94 Grease
- 95 Grease
- 96 Grease
- 97 Grease
- 98 Grease
- 99 Grease
- 100 Grease

SEE INSTRUCTIONS FOR LUBRICATION

KEY

LUBRICANTS	LOWEST ANTICIPATED AIR TEMPERATURE	ALL TEMPERATURES	INTERVALS
Oil - 25, 30, 40, 50, 60, 70, 80, 90, 100	Above +32 F. to +100 F.	Oil - 25, 30, 40, 50, 60, 70, 80, 90, 100	Monthly
Grease - 25, 30, 40, 50, 60, 70, 80, 90, 100	Below 0 F.	Grease - 25, 30, 40, 50, 60, 70, 80, 90, 100	Weekly
Oil - 25, 30, 40, 50, 60, 70, 80, 90, 100	Oil - 25, 30, 40, 50, 60, 70, 80, 90, 100	Oil - 25, 30, 40, 50, 60, 70, 80, 90, 100	1 to 2 times
Oil - 25, 30, 40, 50, 60, 70, 80, 90, 100	Oil - 25, 30, 40, 50, 60, 70, 80, 90, 100	Oil - 25, 30, 40, 50, 60, 70, 80, 90, 100	1 to 2 times
Oil - 25, 30, 40, 50, 60, 70, 80, 90, 100	Oil - 25, 30, 40, 50, 60, 70, 80, 90, 100	Oil - 25, 30, 40, 50, 60, 70, 80, 90, 100	1 to 2 times
Oil - 25, 30, 40, 50, 60, 70, 80, 90, 100	Oil - 25, 30, 40, 50, 60, 70, 80, 90, 100	Oil - 25, 30, 40, 50, 60, 70, 80, 90, 100	1 to 2 times

SEE INSTRUCTIONS FOR LUBRICATION AND SERVICE BEFORE USE, PART NO. 94000-1-11.

Fig. 5000 SEE INSTRUCTIONS FOR LUBRICATION AND SERVICE BEFORE USE, PART NO. 94000-1-11.

EA PD 1308909

Figure 16—Lubrication Guide (White)

LUBRICATION

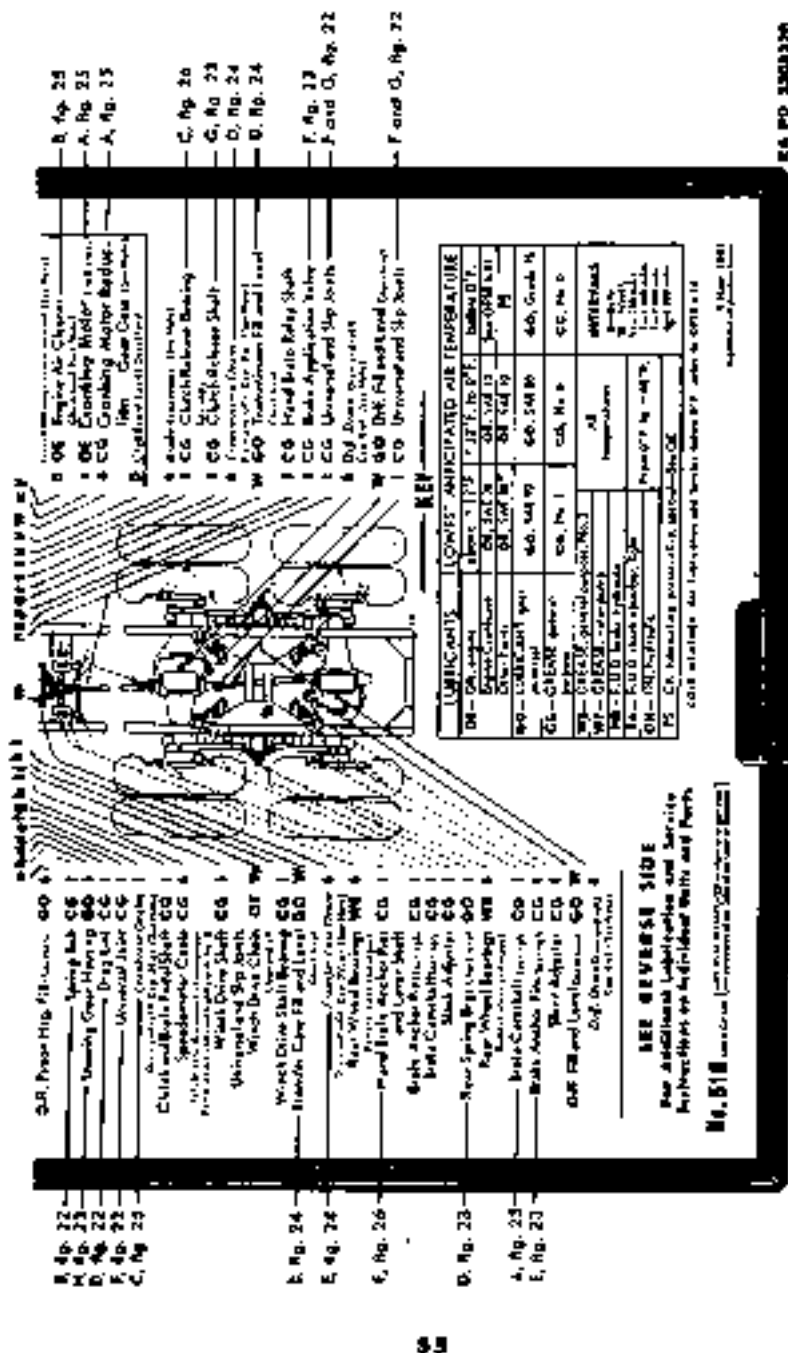


Figure 16—Lubrication Points (Rearview)

RA PD 330320

Approved for Release

6-TON, 6 x 6 TRUCK (WHITE, COBBITT, AND BROCKWAY)

WAR DEPARTMENT OIL LUBRICATION GUIDE

TRUCK, 6-TON, 6 x 6 (BROCKWAY)



SEE REVERSE SIDE

FOR

LUBRICATION DIAGRAM
OF TRUCK

NOTES—Additional Specifications and Service Instructions on Individual Units and Parts. NOTES

Check engine for repairs and service every 10,000 miles or 100 hours.

AIR CLEANER—R-513 with used crumpled paper OE type DT, 10-407, or O-14 or SA, 1000-407, version of and operate dry. Every 1,000 miles cleanable and wash at 100° F. Every 1,000 miles remove moisture, clean screen and wash thoroughly in clean, wash, dry and replace. Always use used crumpled paper OE type DT, 10-407, or O-14 or SA, 1000-407, wash and replace.

GLASS GOVERNOR—Every 1,000 miles, always use plate from governor and also replace with plate with SOA VENT, displacement or ACTIONE. Every 1,000 miles, to more fully protect through type 100° F. bearing of ball at governor and wash.

CRANKING MOTOR REDUCTION GEAR CASE—Every 1,000

mi.

LUBRICATION

DA FORM 3000306

Motorcycle handle bars shift only forward through side with OIL. Every 1,000 miles, remove handlebar clamps, remove side cover, clean handlebar and remove all the old lubricant. Pack grease and housing with CGC and install handle.

OIL CASH PUMP—Every 1,000 miles, lubricate thrust rod ends, steering knaps, driver, shock and hand brake control linkage. Use light grease support light, or compression and seal test on compression roller arms, adjust the roller shaft, use the hand, adjuster and roller with CGC.

RUBBER JOINTS—Every 1,000 miles, apply HG to torque torque rod bushings and other tapered rubber spacers. Do not use oil.

DO NOT OIL RIGGERS—Grease engine, Grease Springs, Main Ax Grease, Grease Front Bearings.

DETAILS IN INSTRUCTIONS—Refer to TM 9-811 and TM 9-113.

Copy of this Guide will be carried on the motorcycle at all times. These lubrication instructions are binding on all mechanics of maintenance.

Approved by the Director of War,
G. C. Anderson, Chief of Staff

7/1942 (REV)

47
GREASE (Engine and Auxiliary Components)—Do not use when engine is hot by removing too much plug, one each for the upper and the lower bearings, another each for the lower plug. After the plug is removed, the lower plug has a plug on the end that closes a passage by which the upper and lower bearings. Rubbing the bearings prevents the oil from a common level when refilling.

OIL CANS—Use only after operation. Fill to plug level when hot or to 1/2 inch below plug level when cold. Keep 48 inches between fuel differential piece bearings.

DIFFERENTIAL—Every 1,000 miles, wipe differential bearings clean lightly with CGC and lubricate bearing and pins and wash under roller with 1 to 2 drops of OIL.

OIL FILTERS—After cleaning element, use engine oil for several weeks until conditions are still good.

UNIVERSAL JOINTS AND LOWER STEERING SHOCKS—BUSHINGS—Front Vehicle's—Wash front on hand ground in motor inspection plug on under side of universal joint. Remove plug or wheel hub. Install Grease and fill through fitting with lubricant. Approach at inspection plug hole. Remove fitting and install plug.

Fig. 518 (REV) (See instructions on page 23 of this manual)

Figure 19—Lubrication Guide (Brooklyn)

6-TON, 6 x 6 TRUCK (WHITE, CORBITT, AND BROCKWAY)

DA PD 330834

WAR DEPARTMENT LUBRICATION GUIDE

CORBETT DEPARTMENT

TRUCK, 6 TON, 6X6
(CORBITT)

LUBRICANTS

Check Pump before operating truck after lighting.
 Reduce Speeds to safe levels when operating on down hills.

Inspection and Lubrication Schedule from War Department Lubrication Manual
 For Complete Lubrication Schedule, See Lubrication Manual, Department of War, Washington, D. C.

Check with CORBITT, Brockway or White for latest data on lubrication.

Check with CORBITT, Brockway or White for latest data on lubrication.
 Lubrication should be done on both sides.
 Opposite parts are shown by dotted lines.

NOTE: See Manual for the location of lubrication points.

F, Fig. 25	Front Drive Shaft	CG 1	Separated Spring Driver Head	CG, Fig. 25
A, Fig. 27	Spring Shackles	CG 1	W/P Front Hub	H, Fig. 25
F, Fig. 24	Front Axle Differential	CG 1	CG Brake Front Support	H, Fig. 25
	FD and Level Control	CG 1	CG Compressor Air	G, Fig. 24
	Control Valve	CG 1	CG Distributor Shaft	H, Fig. 24
B, Fig. 23	Brake Slack Adjuster	CG 6	CG Distributor (In Wheel)	H, Fig. 22
C, Fig. 23	Brake Camshaft	CG 1	CG Footboard for Adjuster	
	Universal Joint and	CG 1	CG Exhaust Air Cable	
	Steering Knuckle Upper		CG Water Pump	D, Fig. 24
	Bearing (In Wheel)		CG Air Compressor Air	A, Fig. 26
	Front Wheel Bearings	W/P 6	CG Clutch (See note on this item)	C, Fig. 25
	Steering Knuckle Upper	CG 1	CG Air Depot	B, Fig. 25
E, Fig. 27	Drop Leaf	CG 1	CG Cranking Motor	A, Fig. 25
F, Fig. 25	Leaf Axles Pin	CG 1	CG Exhaust Air Cable	G, Fig. 22
C, Fig. 27	In Road	CG 1	CG Water Pump	
	From Axle Differential	CG 6	CG Clutch	
	Drive Flange (In Wheel)		CG Cranking Motor	
D, Fig. 22	Universal Joint	CG 1	CG Steering Gear	H, Fig. 22
B, Fig. 23	Drop Leaf	CG 1		
	Spring Bolt	CG 1		

4-TON, 4 x 6 TRUCK (WHITE, CORBITT, AND BROCKWAY)

R.A. PD 130833

WAR DEPARTMENT LUBRICATION GUIDE
ORDNANCE DEPARTMENT
TRUCK, 6 TON, 6 x 6
TRAILER, 4-WHEEL, COMPOSITE

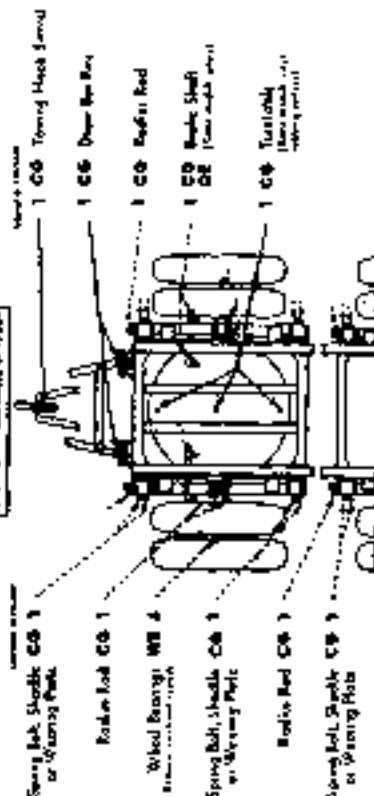
10-5-57

Check fittings before lubricating. Lubricate after
 making
 reduce stresses which occur in starting and
 slow

Figurative replacement. Use. This
 No. Consulting Officer. For Wayne
 Composite Paper. Refer to Bulletin.

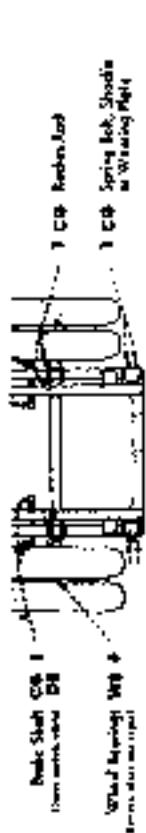
Check parts with GULFPORT. Apply. This or OK.
 but. Do not Dry before Lubricating.
 Lubricate at least every month or less often.
 Specific parts are shown by their letters.

WHITE — See Section 10-5-57
 for details of 1942



LUBRICATION

14 JAN 1954



FOR INFORMATION OF THE OPERATOR, THE FOLLOWING NOTES ARE GIVEN:

1. The lubrication system is designed to provide adequate lubrication to the engine and transmission during normal operation. The system consists of a pump, filter, and distribution lines leading to the engine and transmission.

2. The engine oil level should be checked daily. The oil level should be maintained between the "Full" and "Add" marks on the dipstick.

3. The transmission oil level should be checked weekly. The oil level should be maintained between the "Full" and "Add" marks on the dipstick.

4. The oil filter should be replaced every 100 hours of operation.

5. The oil should be changed every 200 hours of operation.

NOTES

1. The lubrication system is designed to provide adequate lubrication to the engine and transmission during normal operation. The system consists of a pump, filter, and distribution lines leading to the engine and transmission.

2. The engine oil level should be checked daily. The oil level should be maintained between the "Full" and "Add" marks on the dipstick.

3. The transmission oil level should be checked weekly. The oil level should be maintained between the "Full" and "Add" marks on the dipstick.

4. The oil filter should be replaced every 100 hours of operation.

5. The oil should be changed every 200 hours of operation.

LUBRICANTS	LOWEST ANTICIPATED AIR TEMPERATURE		ALL TEMPERATURES		INTERVALS
	Below 32°F.	4-12°F. No D.F.	14-32°F. No D.F.	32°F. and Above	
Oil - Engine	Oil SAE 30	Oil SAE 10	Oil SAE 10	Oil SAE 10	100 Miles
Oil - Lubrication	Oil SAE 30	Oil SAE 10	Oil SAE 10	Oil SAE 10	100 Miles
Oil - Gear	Oil SAE 30	Oil SAE 10	Oil SAE 10	Oil SAE 10	100 Miles

NOTE: The lubrication system is designed to provide adequate lubrication to the engine and transmission during normal operation. The system consists of a pump, filter, and distribution lines leading to the engine and transmission.

Figure 27—Lubrication Guide (Continued)

6-TON, 6 x 6 TRUCK (WHITE, CORBITT, AND BROCKWAY)



A—SPRING SHACKLE



B—SPRING BOLT



C—TIE-ROD END



D—DRAG LINK (REAR)



E—DRAG LINK



F—UNIVERSAL JOINT



G—SLIP JOINT



H—TACHOMETER ADAPTER

RA PD 303432

Figure 22—Localized Lubrication Points

LUBRICATION



A—BRAKE CAMSHAFT (REAR)



B—SLACK ADJUSTER (FRONT)



C—BRAKE CAMSHAFT (FRONT)



D—REAR SPRING BEARING



E—BRAKE ANCHOR PINS



F—BRAKE APPLICATION VALVE



G—CLUTCH LINKAGE AND SHAFTS



H—STEERING GEAR HOUSING

RA PB 300833

Figure 23—Localized Lubrication Points

6-TON, 6 X 6 TRUCK (WHITE, CORBITT, AND BROCKWAY)



A—WINCH GEAR CASE AND
SHAFT BEARINGS



B—WINCH SHAFT AND JAW CLUTCH



C—FRONT AXLE UNIVERSAL LEVEL
PLUG



D—TRANSMISSION FILLER AND DRAIN
PLUGS



E—TRANSFER CASE FILLER AND DRAIN
PLUGS



F—FRONT AXLE DIFFERENTIAL VENT
AND FILLER PLUG



G—WATER PUMP



H—DISTRIBUTOR

RA PD 305854

Figure 24—Localized Lubrication Points

LUBRICATION

A—CRANKING MOTOR OILER
AND FILLER PLUG

B—AIR CLEANER ASSEMBLY



C—CRANKCASE



D—CRANKCASE VENTILATOR



E—OIL FILTERS



F—PINTLE HOOK (FRONT)



G—FAN HUB



H—ENGINE FRONT SUPPORT

EA PG 203655

Figure 25—Localized Lubrication Points

6-TON, 6 x 6 TRUCK (WHITE, CORBITT, AND BROCKWAY)



A—COMPRESSOR AIR CLEANER



B—AIR COMPRESSOR ROCKER ARM



C—CLUTCH RELEASE BEARING



D—WINCH CABLE ROLLER SHAFT



E—WINCH DRIVE CHAIN



F—PROP SHAFT AND HAND BRAKE
SHAFT AND ANCHOR PINS



G—OIL FILLER SPOUT



H—REAR PINLE HOOK

RA PD 302834

Figure 26—Localized Lubrication Points

LUBRICATION

0°F. Below 0°F, refer to OFSB 6-11. Every 1,000 miles, remove plug from rear compartment and center compartment of crankcase, and completely drain case. Drain only when engine is hot. After thoroughly draining, replace both drain plugs and refill crankcase to "FULL" mark on gage with correct lubricant to meet temperature requirements. Run engine a few minutes and recheck oil level. The plug on end of dip stick closes a passage between the two compartments. Do not check oil level while engine is running. CAUTION: Be sure pressure gage indicates oil is circulating.

(5) DISTRIBUTOR. Every 5,000 miles, wipe distributor breaker cam lightly with GREASE, general purpose, No. 1 above +32°F or No. 0 below +32°F, and lubricate breaker arm pivot and camshaft wick under rotor with 1 or 2 drops of OIL, engine, SAE 30 above +32°F, SAE 10 from +32°F to 0°F, or OIL, lubricating, preservative, special, below 0°F.

(6) GEAR CASES. Weekly, check level with truck on level ground, and if necessary add lubricant to within ½ inch of plug level when cold, or to plug level when hot. Every 5,000 miles, drain and refill. Drain only after operation when gear lubricant is warm.

(a) Transfer Case, Declutching Unit, Power Take-off, Front Axle Differential Drive Pinion. Add approximately 1-pint of LUBRICANT, gear, universal, through filler plug opening in each of these units whenever truck has been immobile for 30 days or longer, or whenever the units have been overhauled and reassembled. This service should be performed in addition to the periodic checking of lubricant levels and drain periods. Refill with LUBRICANT, gear, universal SAE 90 above +32°F, SAE 80 from +32°F to 0°F, or grade 75 below 0°F.

(7) OIL FILTERS. Every 1,000 miles, drain sediment. Every 5,000 miles, or more often if filter becomes clogged, remove filter element, clean inside of case and install new element. After renewing element, run engine a few minutes, recheck crankcase oil level and fill to "FULL" mark with the correct grade of OIL, engine.

(8) UNIVERSAL JOINTS (FRONT WHEELS). With trucks on level ground, remove plug in center of wheel hub and insert fitting. Remove inspection plug on underside of housing, and fill through fitting until lubricant comes out inspection hole. CAUTION: After lubricating, replace plugs. Every 5,000 miles, remove, clean, reassemble and fill. Remove plug in wheel hub and apply 1 pound of GREASE, general purpose, No. 1 above +32°F, or No. 0 below +32°F.

(9) UNIVERSAL AND SLIP JOINTS. Apply GREASE, general purpose, No. 1 above +32°F, or No. 0 below +32°F, to universal joint until it overflows at relief valve, and to slip joint until lubricant is forced from end of slip joint.

(10) WHEEL BEARINGS. Remove bearing cone assemblies from hub. Wash bearings, cones, spindle and inside of hub and dry thoroughly. Do not use compressed air. Inspect bearing races and replace if damaged. Wet the spindle and inside of hub and hub cap with GREASE, general purpose, No. 2 to a maximum thickness of ⅛ inch only to retard rust. Lubricate bearings with GREASE, general pur-

6-TON, 6 x 6 TRUCK (WHITE, CORBITT, AND BROCKWAY)

pose No. 2 with a packer, or by hand, kneading lubricant into all spaces in the bearing. Use extreme care to protect the bearings from dirt, and immediately reassemble and replace wheel. Do not fill hub or hub cap. The lubricant in the bearing is sufficient to provide lubrication until the next service period. Any excess might result in leakage into the drum. Adjust bearings (par. 105).

(11) **WINCH CABLES.** After each use, clean and oil with used crankcase oil, or OIL, engine, SAE 30 above +32°F, SAE 10 from +32°F to 0°F, or OIL, lubricating, preservative, special, below 0°F. Weekly, if cable has not been used, coat outer coils. Monthly, unwind entire cable, clean and oil.

(12) **OILCAN POINTS.** Every 1,000 miles, lubricate throttle linkage, power take-off control linkage, hand brake lever, relay shafts and linkage, transfer case shift linkage, winch control shafts and linkage, winch drive chain, winch cable body roller shaft, air compressor rocker arm, water pump drive chain coupling, air compressor drive connecting chain, winch cable retaining shaft, clevises, cab and body hinges with OIL, engine, SAE 30 above +32°F, SAE 10 from +32°F to 0°F, or OIL, lubricating, preservative, special, below 0°F.

(13) **RUBBER BUSHINGS.** Every 1,000 miles, apply FLUID, brake, hydraulic, to torque rod bushings. **CAUTION:** Do not use oil.

(14) **DO NOT LUBRICATE:** Springs, generator (some models), air compressor crankcase, or governor.

e. Lubricated by Ordnance Personnel (White).

(1) **CRANKING MOTOR.** Every 6,000 miles, remove cranking motor, clean and lubricate Bendix drive with 6 to 8 drops of OIL, lubricating, preservative, special. Lubricate rear bearing through oiler with 6 to 8 drops of OIL, engine, SAE 30 above +32°F, SAE 10 from +32°F to 0°F, or OIL, lubricating, preservative, special, below 0°F. Clean and repack cranking motor reduction gear case with GREASE, general purpose, No. 1 above +32°F, or No. 0 below +32°F.

(2) **BRAKE GOVERNOR.** Every 18,000 miles, remove cover plate from the brake governor and lubricate the upper valve stem with a few drops of OIL, lubricating, preservative, special.

f. Lubrication Notes on Individual Units and Parts (Brockway). The following instructions supplement those notes on the Lubrication Guide (Figs. 18 and 19) which pertain to lubrication and service of individual units and parts of the Brockway vehicle.

(1) **AIR CLEANERS.** Daily, check level and refill engine air cleaner oil reservoir to bead level with used crankcase oil, or OIL, engine, SAE 30 above +32°F, and SAE 10 from +32°F to 0°F. For below 0°F operation, wash, dry and refill with OIL, hydraulic, or FLUID, shock-absorber, light. Allow excess oil to drain before reinstalling. Every 1,000 miles, daily under extreme dust conditions, remove and wash all parts.

LUBRICATION**(2) BREATHERS AND VENTS.**

(a) *Breathers.* Every 1,000 miles, remove crankcase breather, wash thoroughly, dry and saturate filter element with used crankcase oil, or OIL, engine, SAE 30 above +32°F, or SAE 10 for +32°F to 0°F. For below 0°F operation wash, dry and reoil with OIL, hydraulic, or FLUID, shock-absorber, light. Allow excess oil to drain before reinstalling. Every 1,000 miles, remove air compressor and auxiliary air compressor air cleaners, disassemble and wash all parts. Dry curled hair after washing, then saturate with used crankcase oil or OIL, engine, SAE 30 above +32°F or SAE 10 for +32°F to 0°F. For below 0°F operation, wash curled hair, dry and reoil with OIL, hydraulic, or FLUID, shock-absorber, light. Allow excess oil to drain before reinstalling.

(b) *Vents.* Gear case vents must be kept clean at all times.

(3) **CRANKCASE (ENGINE AND AUXILIARY COMPRESSOR).** Drain only when engine is hot by removing two drain plugs, one each for the upper and lower housings; auxiliary compressor, one drain plug. Refill with level gage removed. The level gage has a plug on the end that closes a passage between the upper and lower housings. Removing the level gage permits the oil to seek a common level when refilling. Replace gage, check level, run engine a few minutes, then recheck oil level with engine stopped. Make certain pressure gage indicates oil is circulating. Auxiliary compressor has conventional hayonet gage.

(4) **OIL FILTERS.** Weekly, remove drain plug from oil filter to drain sediment. Every 6,000 miles or more often if filter becomes clogged, remove filter, clean inside of case, and install new element. After renewing element, run engine a few minutes, check crankcase oil level and fill to "FULL" mark with correct grade of OIL, engine.

(5) **GEAR CASES.** Weekly, check level with truck on level ground and, if necessary, add lubricant to within 1/2 inch of plug level when cold, and to plug level when hot. Drain and refill at intervals indicated on Guide. Also fill reservoir between front differential pinion bearings. Drain only after operation.

(6) UNIVERSAL JOINTS AND SLIP JOINTS.

(a) *Propellar Shafts.* Apply GREASE, general purpose, No. 1 above +32°F, or No. 0 below +32°F to universal joint, until it overflows at relief valve, and to slip joint until lubricant is forced from vent at universal joint end of spline.

(b) *Winch Drive Shaft.* Apply GREASE, general purpose, No. 1 above +32°F, or No. 0 below +32°F, to universal joint until it appears at bearings, and to slip joint until lubricant is forced from end of slip joint.

(7) **UNIVERSAL JOINTS AND LOWER STEERING KNUCKLE BEARINGS (FRONT WHEELS).** With truck on level ground, remove inspection plug on underside of universal joint. Remove plug in wheel hub, install fitting and fill through fitting until lubricant appears at inspection plug hole. Remove fitting and reinstall plugs.

6-TON, 6 x 6 TRUCK (WHITE, CORBITT, AND BROCKWAY)

(8) **BRAKE GOVERNOR.** Every 6,000 miles, remove cover plate from governor, and clean upper valve stem with SOLVENT, dry-cleaning, or ACETONE. Every 6,000 miles, remove brake governor strainer from small housing at base of governor, and wash in dry-cleaning solvent.

(9) **CRANKING MOTOR REDUCTION GEAR CASE.** Every 6,000 miles, lubricate Bendix drive shaft outer bearing through oiler with OIL, engine, SAE 30 above +32°F; SAE 10 for +32°F to 0°F, or OIL, lubricating, preservative, special, below 0°F. Every 6,000 miles, remove cranking motor, disassemble reduction gear housing, and remove all the old lubricant. Pack gears and housing with GREASE, general purpose, No. 1 above +32°F, or No. 0 below -32°F, and reassemble.

(10) **DISTRIBUTOR.** Every 6,000 miles, wipe distributor breaker cam tightly with GREASE, general purpose, No. 1 above +32°F, or No. 0 below -32°F, and lubricate breaker arm pivot and wick under rotor with 1 to 2 drops of OIL, engine, SAE 30 above +32°F; SAE 10 +32°F to 0°F, or OIL, lubricating, preservative, special, below 0°F.

(11) **WHEEL BEARINGS.** Remove bearing cone assemblies from hub, and wash spindle and inside of hub. Inspect bearing races and replace if necessary. Wet the spindle and inside of hub and hub cap with GREASE, general purpose, No. 2, to a maximum thickness of $\frac{1}{16}$ inch only to retard rust. Wash bearing cones and grease seals. Inspect and replace if necessary. Lubricate bearings with GREASE, general purpose, No. 2, with a packer or by hand, kneading lubricant into all spaces in the bearing. Use extreme care to protect bearings from dirt, and immediately reassemble and replace wheel. The lubricant in the bearings is sufficient to provide lubrication until the next service period. Do not fill hub or hub cap. Any excess might result in leakage into the brake drum.

(12) **OILCAN POINTS.** Every 1,000 miles, lubricate throttle rod ends, clevises, hinges, latches, winch and hand brake control linkage, shifter level support shaft, air compressor and auxiliary air compressor rocker arms, spare tire carrier shaft, pintle hook, ratchet and cable with OIL, engine, SAE 30 above +32°F; SAE 10 +32°F to 0°F, or OIL, lubricating, preservative, special, below 0°F.

(13) **RUBBER BUSHINGS.** Every 1,000 miles, apply FLUID, brake, hydraulic, to bogie torque rod bushings and other exposed rubber surfaces. Do not use oil.

(14) **DO NOT LUBRICATE:** Generator, engine governor, springs, main air compressor, or clutch pilot bearing.

g. Lubrication Notes on Individual Units and Parts (Corbitt). The following instructions supplement those notes on the Lubrication Guide (figs. 20 and 21), which pertain to lubrication and service of individual units and parts of the Corbitt vehicle.

(1) **AIR CLEANERS.**

(a) *Oil Bath Type.* Daily, check level and refill engine air cleaner oil reservoir to bend level with used crankcase oil, or OIL, engine,

LUBRICATION

SAE 30 above +32°F, and SAE 10 from +32°F to 0°F. From 0°F to -40°F, use OIL, hydraulic, or FLUID, shock-absorber, light. Below -40°F, remove oil and operate dry. Every 1,000 miles, daily under extreme dust conditions, remove air cleaners and wash all parts. CAUTION: Keep all connections clean and tight.

(b) *Element Type.* Daily, check air compressor air cleaner and clean if necessary. Every 1,000 miles, wash curled hair, dry and refill with used crankcase oil or OIL, engine, SAE 30 above +32°F, and SAE 10 from +32°F to 0°F. From 0°F to -40°F, use OIL, hydraulic, or FLUID, shock-absorber, light. Below -40°F, wash and replace dry.

(2) BREATHERS AND VENTS.

(a) *Breathers.* Every 1,000 miles, remove crankcase breather cap, wash thoroughly, dry and refill with used crankcase oil, or OIL, engine, SAE 30 above +32°F, and SAE 10 from +32°F to 0°F. From 0°F to -40°F, use OIL, hydraulic, or FLUID, shock-absorber, light. Below -40°F, wash and replace dry.

(b) *Vents.* Gear case axle housing and transfer case vents will be kept clean at all times. Inspect each time oil is checked and each time truck is operated under extremely dirty or muddy conditions. Every 1,000 miles, remove brake governor and air line strainers, located on the cowl under hood, dismantle and clean the screens. Every 12,000 miles, wash cab ventilator air cleaner filter screen in water.

(3) CRANKCASE. Daily, check level and refill to "FULL" mark with OIL, engine, SAE 30 above +32°F, or SAE 10 from +32°F to 0°F. Below 0°F, refer to OPSE 6-11. Every 1,000 miles, remove plug from rear compartment and center compartment of crankcase, and completely drain case. Drain only when engine is hot. After thoroughly draining, replace both drain plugs, and refill crankcase to "FULL" mark on gage with correct lubricant to meet temperature requirements. Run engine a few minutes, and recheck oil level. The plug on end of dip stick closes a passage between the two compartments. Do not check oil level while engine is running. CAUTION: Be sure pressure gage indicates oil is circulating.

(4) OIL FILTERS. Every 1,000 miles, drain sediment. Every 6,000 miles or more often if filter becomes clogged, remove filter element, clean inside of case and install new element. After renewing element, run engine a few minutes, recheck crankcase oil level and fill to "FULL" mark with the correct grade of OIL, engine.

(5) GEAR CASES. Weekly, check level with truck on level ground, and, if necessary, add lubricant to within 1/2 inch of plug level when cold, or to plug level when hot. Every 6,000 miles, drain and refill. Drain only after operation when gear lubricant is warm.

(a) *Transfer Case Declutching Unit, Power Take-off, Front Axle Differential Drive Pinion.* Add approximately 1 pint of LUBRICANT, gear, universal, SAE 90 above +32°F, SAE 80 from +32°F to 0°F, and Grade 75 below 0°F, through filler plug opening in each of these units whenever truck has been immobile for 30 days or longer, or whenever the units have been overhauled and reassembled.

4-TON, 6 x 6 TRUCK (WHITE, CORBITT, AND BROCKWAY)

This service should be performed in addition to the periodic checking of lubricant level and drain periods. Refill with LUBRICANT, gear, universal, SAE 90 above +32°F, SAE 80 from +32°F to 0°F, or Grade 75 below 0°F.

(6) **CLUTCH PILOT BEARING.** When clutch is disassembled for any other purpose, remove, clean and repack.

(7) **UNIVERSAL JOINTS (FRONT WHEELS).** With truck on level ground, remove plug in center of wheel hub and insert fitting. Remove inspection plug on underside of housing, and fill through fittings until lubricant comes out inspection hole. **CAUTION:** After lubricating, replace plugs. Every 6,000 miles, remove, clean and refill. Remove plug in wheel hub and apply 1 pound of GREASE, general purpose, No. 1 above +32°F, or No. 0 below +32°F.

(8) **UNIVERSAL AND SLIP JOINTS.** Apply GREASE, general purpose, No. 1 above +32°F, or No. 0 below +32°F, to universal joint, until it overflows at relief valve, and to slip joint until lubricant is forced from end of slip joint.

(9) **DISTRIBUTOR.** Every 6,000 miles, wipe distributor breaker cam lightly with GREASE, general purpose, No. 1 above +32°F, or No. 0 below +32°F, and lubricate breaker arm pivot and camshaft wick under rotor with 1 to 2 drops of OIL, engine, SAE 30 above +32°F, SAE 10 from +32°F to 0°F, and OIL, lubricating, preservative, special, below 0°F.

(10) **WINCH CABLE.** After each use, clean and oil with used crankcase oil, or OIL, engine, SAE 30 above +32°F, SAE 10 from +32°F to 0°F, and OIL, lubricating, preservative, special, below 0°F. Weekly, if cable has not been used, coat outer coils. Monthly, unwind entire cable, clean and oil.

(11) **WHEEL BEARINGS.** Remove bearing cone assemblies from hub. Wash bearings, cones, spindles, inside of hub, and dry thoroughly. Do not use compressed air. Inspect bearing races and replace if damaged. Wet the spindle and inside of hub and hub cap with GREASE, general purpose, No. 2 to a maximum thickness of $\frac{3}{16}$ inch only, to retard rust. Lubricate bearings with GREASE, general purpose, No. 2 with a packer, or by hand, kneading lubricant into all spaces in the bearing. Use extreme care to protect the bearings from dirt, and immediately reassemble and replace wheel. Do not fit hub or hub cap. The lubricant in the bearing is sufficient to provide lubrication until the next service period. Any excess might result in leakage into the drum. Adjust bearings (par. 105)

(12) **OILCAN POINTS.** Every 1,000 miles, lubricate throttle linkage, power take-off control linkage, transfer case shift linkage, winch control shafts and linkage, winch drive chain, winch cable body roller shaft, air compressor rocker arm, water pump drive chain coupling, air compressor drive connecting chain, winch cable retaining shaft, clevises, cab and body hinges with OIL, engine, SAE above +32°F, SAE 10 from +32°F to 0°F, or OIL, lubricating, preservative, special, below 0°F.

(13) **RUBBER BUSHINGS.** Every 1,000 miles, apply FLUID, brake, hydraulic, to torque rod bushings. **CAUTION:** Do not use oil.

LUBRICATION

(14) **DO NOT LUBRICATE:** Springs, generator, air compressor crankcase, governor, hand brake lever, or relay shafts.

h. **Lubricated by Ordnance Personnel (Corbin).**

(1) **Every 6,000 miles,** remove cranking motor, clean and lubricate Bendix drive with 6 to 8 drops of OIL, lubricating, preservative, special. Lubricate rear bearing through oiler with 6 to 8 drops of OIL engine, SAE 30 above +32°F, or SAE 10 for below +32°F. Clean and repack cranking motor reduction gear case with GREASE, general purpose, No. 1 above +32°F, or No. 0 below +32°F.

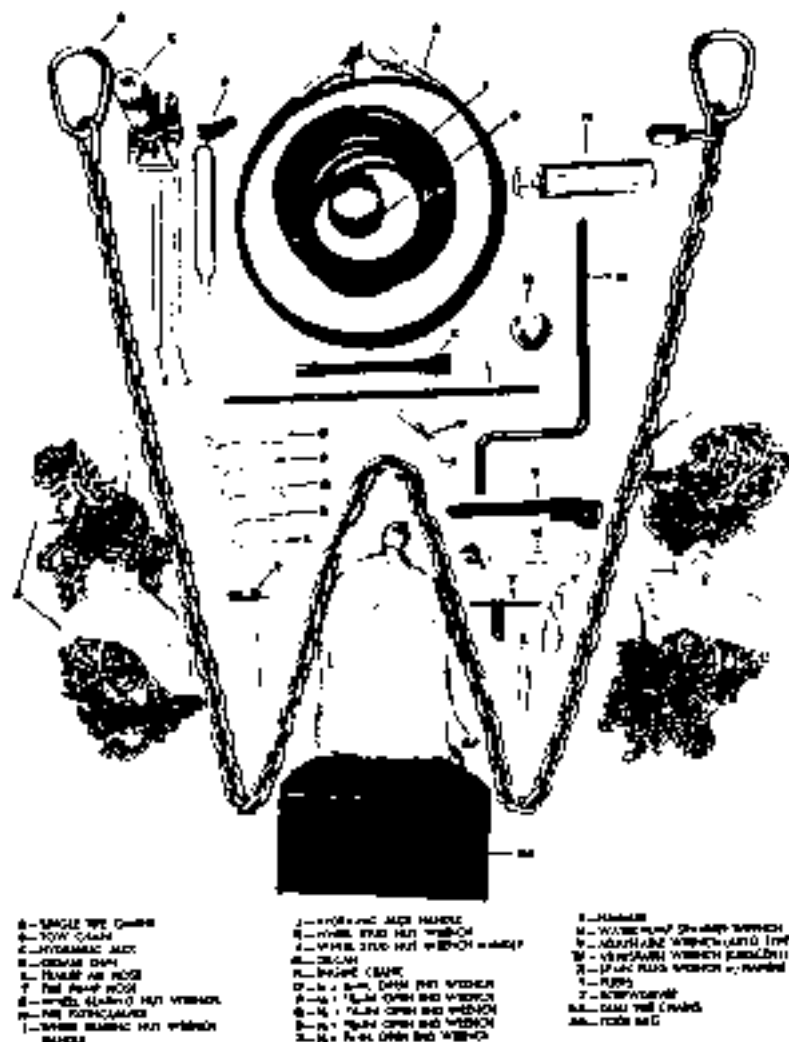
(2) **BRAKE GOVERNOR.** Every 18,000 miles, remove cover plate from the brake governor and lubricate the upper valve stem with a few drops of OIL, lubricating, preservative, special.

i. **Reports and Records.**

(1) **REPORTS.** Unsatisfactory performance of material should be reported to the Ordnance Officer responsible for maintenance.

(2) **RECORDS.** A record of lubrication should be maintained in the Duty Roster (W.D., A.G.O. Form No. 6)

6-TON, 6 x 6 TRUCK (WHITE, CORBITT, AND BROCKWAY)



GA PD 305979

Figure 27—Prime Mover Vehicle Tools and Equipment

Section VIII

TOOLS AND EQUIPMENT STORAGE ON THE VEHICLE

	Paragraph
Vehicle tools	24
Vehicle equipment	25
Vehicle spare parts	26

24. VEHICLE TOOLS.

a. Prime Mover. (One of each tool carried on vehicle.)

Tool	Fed. Stock No.	Where Carried
HAMMER	41-H-523	Tool box
HANDLE, wheel stud nut wrench		Tool box
HANDLE, wrench ext.		Tool box
PLIERS, comb., slip joint, wire-cutting	41-P-1650	Tool box
SCREWDRIVER, 6-inch	41-S-1076	Tool box
WRENCH, adj., auto type	41-W-450-15	Tool box
WRENCH, crescent	41-W-488-12	Tool box
WRENCH, open-end, 15°-angle, 3/8 x 7/16 in.	41-W-991	Tool box
WRENCH, open-end, 15°-angle, 1/2 x 15/16 in.	41-W-1003	Tool box
WRENCH, open-end, 15°-angle, 5/16 x 11/16 in.	41-W-1005-5	Tool box
WRENCH, open-end, 15°-angle, 3/8 x 23/32 in.	41-W-1008-10	Tool box
WRENCH, open-end, 15°-angle, 3/4 x 3/8 in.	41-W-1012-5	Tool box
WRENCH, rear wheel bearing out
WRENCH, spanner, water pump ..		Tool box
WRENCH, spark plug and handle.		Tool box
WRENCH, wheel stud nut ..		Tool box

b. Bridge Erection and Crane.

HAMMER	41-H-523	Tool box
HANDLE, wheel stud nut wrench		Tool box
Handle, wrench ext.		Tool box
PLIERS, comb., slip joint, wire-cutting	41-P-1650	Tool box
SCREWDRIVER, 6-inch	41-S-1076	Tool box
WRENCH, adj., auto type	41-W-452-15	Tool box
WRENCH, crescent	41-W-488-12	Tool box

TM 9-813

24-25

6-TON, 4 x 6 TRUCK (WHITE, CORBITT, AND BROCKWAY)

Tool	Fed. Stock No.	Where Carried
WRENCH, open-end, 15°-angle, 3/8 x 1/2 in.	41-W-991	Tool box
WRENCH, open-end, 15°-angle, 1/2 x 3/4 in.	41-W-1003	Tool box
WRENCH, open-end, 15°-angle, 3/16 x 1 1/16 in.	41-W-1005-5	Tool box
WRENCH, open-end, 15°-angle, 3/4 x 1 1/2 in.	41-W-1008-10	Tool box
WRENCH, open-end, 15°-angle, 1/2 x 3/8 in.	41-W-1012-5	Tool box
WRENCH, rear wheel bearing nut		Tool box
WRENCH, spanner, water pump		Tool box
WRENCH, spark plug and handle		Tool box
WRENCH, wheel stud nut		Tool box

25. VEHICLE EQUIPMENT.

a. Prime Mover.

BAG, tool		Tool box
CHAIN, tire, single (?)		Tool box
CHAIN, tire, dual (2)		Tool box
CHAIN, tow		Tool box
CRANK, engine starting		Tool box
EXTINGUISHER, fire		Tool box
GUN, grease, alemite		Tool box
HANDLE, jack, hydraulic		Tool box
Hose, tire pump		Tool box
Hose, trailer		Tool box
JACK, hydraulic	41-J-73-5	Tool box
OILCAN (1/2 pint)	13-O-1530	Tool box

b. Bridge Erection and Crane.

BAG, tool		Tool box
CHAIN, tire, single (2)		Tool box
CHAIN, tire, dual (2)		Tool box
CHAIN, tow		Tool box
CRANK, engine starting		Tool box
EXTINGUISHER, fire		Tool box
GUN, grease, alemite		Tool box
HANDLE, jack, hydraulic		Tool box
Hose, tire		Tool box
Hose, trailer		Tool box
JACK, hydraulic	41-J-73-5	Tool box
OILCAN, (1/2 pint)		Tool box

TOOLS AND EQUIPMENT STORAGE ON THE VEHICLE

26. VEHICLE SPARE PARTS.

a. Prime Mover.

SPARE PARTS KIT... .. In cab

Includes:

Part	Quantity	White Part No.
BELT, fan, generator drive	1	391991
BELT, fan, matched pair	1	391992
BULB, Mazda, No. 63, blackout marker lamp	1	A7121
BULB, Mazda, No. 51, dash panel light	1	365604
CAPS, tire valve (in box)	5	412666
CORES, tire valve (in box)	5	412667
KIT, cotter pin (in box)	1	412691
LAMP, blackout stop, unit assembly	1	396367
LAMP, blackout tail, unit assembly	2	396366
LAMP, service stop, unit assembly	1	396371
PLUG, spark, with gasket	1	390990
TAPE, friction (8-oz roll)	1	412668
WIRE (¼-pound coil or spool)	1	412669

b. Bridge Erection and Crane.

SPARE PARTS KIT... .. In cab

Includes:

Part	Quantity	White Part No.
BELT, compressor, auxiliary air	1	500669
BELT, fan, generator drive	1	500047
BELT, fan	2	500048
CAPS, tire valve (in box)	5	253075
CORES, tire valve (in box)	5	253093
KIT, cotter pin (in box)	1	Misc.
LAMP, electric, Mazda, No. 63 (blackout marker lamp)	2	124028
LAMP, electric, Mazda, No. T-51 (dash panel light)	1	126128
LAMP-UNIT, blackout stop, assembly	1	126712
LAMP-UNIT, blackout tail, assembly	1	126721
LAMP-UNIT, service tail and stop, assembly	1	126725
PLUG, spark, with gasket	1	500046
SHEAR PIN, universal joint, winch drive	1	256293
TAPE, friction (8-oz roll)	1	192753
WIRE (¼-pound coil or spool)	1	192754

6-TON, 6 x 6 TRUCK (WHITE, CORBITT, AND BROCKWAY)

PART TWO—VEHICLE MAINTENANCE INSTRUCTIONS

Section IX

NEW VEHICLE RUN-IN TEST

	Paragraph
Introduction	27
Run-in test procedures	28

27. INTRODUCTION.

a. **Purpose.** When a new or reconditioned vehicle is first received at the using organization, it is necessary for second echelon personnel to determine whether or not the vehicle will operate satisfactorily when placed in service. For this purpose, inspect all accessories, sub-assemblies, assemblies, tools, and equipment to see that they are in place and correctly adjusted. In addition, they will perform a run-in test of at least 50 miles as directed in AR 650-15, paragraph 25, table III, according to procedures in paragraph 28 below.

b. **Correction of Deficiencies.** Deficiencies disclosed during the course of the run-in test will be treated as follows:

(1) Correct any deficiencies within the scope of the maintenance echelon of the using organization before the vehicle is placed in service.

(2) Refer deficiencies beyond the scope of the maintenance echelon of the using organization to a higher echelon for correction.

(3) Bring deficiencies of a serious nature to the attention of the supplying organization.

28. RUN-IN TEST PROCEDURES.

a. Preliminary Service.

(1) **FIRE EXTINGUISHER.** See that portable extinguisher is present, and in good condition. Test it momentarily for proper operation, and mount it securely.

(2) **FUEL, OIL, AND WATER.** Fill fuel tanks. Check engine crankcase and coolant supply, and add oil or coolant as necessary to bring to correct levels. Allow room for expansion in fuel tanks and radiator. During freezing weather, test value of antifreeze, and add as necessary to protect cooling system against freezing. **CAUTION:** *If there is a tag attached to filter cap or steering wheel concerning engine oil in crankcase, follow instructions on tag before driving the vehicle.*

(3) **FUEL FILTER.** Inspect filter for leaks, damage, and secure mountings and connection. Drain filter sediment bowl. If an appreciable amount of dirt or water is evident, inspect element and change if necessary.

(4) **BATTERIES.** Make a hydrometer and voltage test of both batteries: if necessary, bring electrolyte level up to $\frac{1}{2}$ inch above plates with distilled or clean water.

NEW VEHICLE RUN-IN TEST

(5) **AIR BRAKE TANKS.** Drain water from all air brake reservoir tanks, and close drain cocks. Also drain auxiliary pontoon inflation system tanks.

(6) **AIR CLEANERS AND BREATHER CAP.** Examine carburetor and air compressor air cleaners, and crankcase breather cap, to see if they are in good condition and secure. Remove elements, and wash thoroughly in dry-cleaning solvent. Fill reservoirs to head level with fresh oil, and reinstall securely. Be sure all gaskets are in good condition, and that duct and air horn connections are tight.

(7) **ACCESSORIES AND BELTS.** See that accessories such as carburetor, generator, regulator, cranking motor, water pump, fan, oil filters, and air compressor are securely mounted. Make sure drive belts are adjusted to have $\frac{1}{2}$ -inch finger-pressure deflection.

(8) **ELECTRICAL WIRING.** Examine all accessible wiring and conduits to see if they are in good condition, securely connected, and properly supported.

(9) **TIRES.** See that all tires, including spares are properly inflated—70 pounds for 10.00 x 22, 80 pounds for 12.00 x 20 tires; cool; that stems are in correct position, all valve caps present and finger-tight. Remove objects lodged in treads, carcasses, and between duals, and inspect for damage. See that spares are secure in carriers.

(10) **WHEELS AND FLANGE NUTS.** See that all wheel mounting, and axle flange nuts are present, and secure.

(11) **FENDERS AND BUMPERS.** Inspect fenders, running boards, splash guards, brush guards, and bumpers for looseness and damage. Be sure step plates and runs are in good condition.

(12) **TOWING CONNECTIONS.** Examine all towing shackles and pintle hook for looseness and damage, and see that pintle latch operates properly and locks securely.

(13) **CAB, BODY AND TARPULINS.** See that all cab and body mountings are secure. Inspect attachments—hardware, glass, seats, doors, tailgate, chain and latches, hood, ventilators, and stowage compartment; see that they are in good condition, correctly assembled, and secure. See that cargo body tarpaulins and curtains are properly stowed or properly installed and fastened, and not damaged.

(14) **WINCHES.** Inspect winches for damage, secure mountings and oil leaks. See that rear winch drive chain is in good condition, not excessively worn, and adjusted to have $\frac{3}{4}$ -inch deflection midway between sprockets. Test winch clutch mechanism for proper operation. Test drag brakes to see if they hold drums for spinning, and as cables are unwound; inspect them for wear, damage, and adequate lubrication. Test winch automatic brakes by placing vehicle at top of steep incline and attaching cables to another vehicle stationed at bottom. While drawing towed vehicle uphill, release engine clutch; if towed vehicle backs downhill, brake needs adjustment. Start lowering vehicle downhill with winch, and throw out engine clutch; if towed vehicle fails to stop or drifts more than one or two inches, brake needs adjustment. After tests, rewind cables evenly and

4-TON, 6 x 6 TRUCK (WHITE, CORBITT, AND BROCKWAY)

tightly on drums, and while winding, clean cables thoroughly and apply a light film of engine oil.

(15) **LUBRICATE** Perform a complete lubrication service on the vehicle, covering all intervals, according to the instructions on the Lubrication Guide (par. 23), except gear cases, wheel bearings, and other units previously lubricated or serviced in items (1) to (14). Check all gear case oil levels, and add as necessary to bring to correct levels. Change only if condition of oil indicates the necessity, or if gear oil is not of proper grade for existing atmospheric temperature. **NOTE:** Perform items (16) to (19) during lubrication.

(16) **SPRINGS OR WALKING BEAM AND SUSPENSIONS.** Inspect front springs, and rear springs or walking beam (as equipped), rear bogie suspension spring seats, and torque rods, and see that they are in good condition, correctly assembled, secure, and not leaking excessively at seals.

(17) **STEERING LINKAGE.** See that all steering arms, rods, and connections are in good condition and secure; and that gear case is securely mounted and not leaking excessively.

(18) **PROPELLER SHAFTS.** Inspect all shafts and universal joints; see that they are in good condition, correctly assembled, aligned, secure and not leaking excessively at seals.

(19) **AXLE AND TRANSFER VENTS.** See that axle housing and transfer case vents are present, in good condition, and not clogged.

(20) **CHOKER.** Examine choke to be sure it opens and closes fully in response to operation of choke button.

(21) **ENGINE WARM-UP.** Start engine, noting if cranking motor action is satisfactory, and if there is any tendency toward hard starting. Set hand throttle to run engine at fast idle during warm-up. During warm-up, reset choke button so that engine will run smoothly, and to prevent overchoking and oil dilution.

(22) INSTRUMENTS.

(a) **Oil Gage.** Immediately after engine starts, observe if oil pressure is satisfactory. Normal pressure at idle speed is 15 pounds, and at operating speeds 25 to 30 pounds. Stop engine if oil pressure fails to register in 30 seconds.

(b) **Ammeter.** Main ammeter should show a slight positive (+) charge. High charge may be indicated until generator recharges to batteries the current consumed in starting. Auxiliary ammeter should also show a positive (+) charge, indicating that second battery is receiving charge.

(c) **Temperature Gage.** Engine temperature should rise gradually during warm-up to normal range (160°F to 180°F).

(d) **Tachometer.** White pointer should indicate engine speed in revolutions per minute, and red pointer should record and remain at highest engine speed attained.

(e) **Viscometer.** After engine has reached normal operating temperature, pointer should remain in "ideal" range.

NEW VEHICLE RUN-IN TEST

(1) *Air Pressure Gage.* During warm-up, air pressure should build up to 105 pounds. Governor should cut off air from compressor at this pressure and should again cut in if pressure in lines and reservoirs is reduced to 85 pounds. Warning indicator (buzzer) should sound at pressures below 60 pounds.

(g) *Fuel Gage.* Gage should register "FULL" if tank has been filled.

(23) **ENGINE CONTROLS.** Observe if engine responds properly to controls and if controls operate without excessive looseness or binding.

(24) **HORN AND WINDSHIELD WIPERS.** See that these items are in good condition and secure. If tactical situation permits, test horn for proper operation and tone. See if wiper arms will operate through their full range, and that blade contacts glass evenly and firmly.

(25) **GLASS AND REAR-VIEW MIRRORS.** Clean all body glass and mirrors, and inspect for looseness and damage. Adjust rear-view mirrors for correct vision.

(26) **LAMPS (LIGHTS)** Clean lenses and inspect all units for looseness and damage. If tactical situation permits, open and close all light switches to see if lamps respond properly.

(27) **LEAKS, GENERAL.** Look under vehicle, and within engine compartment, for indications of fuel, oil, and coolant leaks. Trace any leaks found to source, and correct or report them to designated authority.

(28) **TOOLS AND EQUIPMENT.** Check tools and On Vehicle Storage Lists (para 24 and 25), to be sure all items are present, and see that they are serviceable and properly mounted or stowed.

b. **Run-in Test.** Perform the following procedure, (1) to (11) inclusive, during the road test of the vehicle. On vehicles which have been driven 50 miles or more in the course of delivery from the supply to the using organization, reduce the length of the road test to the least mileage necessary to make observations listed below. **CAUTION:** Continuous operation of the vehicle at speeds approaching the maximums indicated on the caution plate should be avoided during the test.

(1) **DASH INSTRUMENTS AND GAUGES.** Do not move vehicle until engine temperature reaches 135°F. Maximum safe operating temperature is 200°F. Observe readings of ammeters, tachometer, viscometer; also of oil, temperature, air pressure and fuel gages, to be sure they are indicating the proper function of the units to which they apply. See that speedometer registers the vehicle speed, and that odometer records accumulating and trip mileage.

(2) **BRAKES: FOOT AND HAND** Test service air brakes to see if they stop vehicle effectively without side pull, chatter, or squealing. Also test trailer air brake band application valve, or electric brake control (as equipped) to see if they function properly. On vehicles so equipped, see that foot brake locking latch operates properly. Be sure service air brake application valve closes when pedal pressure is released, and that there is not an excessive drop in air pressure

6-TON, 6 x 6 TRUCK (WHITE, CORBITT, AND BROCKWAY)

when brakes are applied. Parking brake should hold vehicle on a reasonable incline, with $\frac{1}{4}$ lever ratchet travel in reserve, and should lock securely in applied position. **CAUTION:** Avoid long application of brakes until shoes have become seated. Do not apply full pressure, except for an emergency stop.

(3) **CLUTCH.** Observe if clutch operates smoothly without grab, chatter, or squeal on engagement, or slippage under load when fully engaged. See that pedal has $1\frac{1}{4}$ -inch free travel before meeting resistance. **CAUTION:** Do not ride clutch pedal at any time, and do not engage and disengage new clutch severely or unnecessarily until driven and driving disks have become properly worn in.

(4) **TRANSMISSION AND TRANSFER.** Gearshift mechanism should operate easily and smoothly, and gears should operate without unusual noise, and not slip out of mesh.

(5) **STEERING.** Observe steering action for binding or looseness, and note any excessive pull to one side, wander, shimmy, or wheel tramp. See that column, bracket, and wheel are secure.

(6) **ENGINE.** Be on the alert for any abnormal engine operating characteristics or unusual noise, such as lack of pulling power or acceleration; backfiring, misfiring, stalling, overheating, or excessive exhaust smoke. Observe if engine responds properly to all controls.

(7) **UNUSUAL NOISE.** Be on the alert throughout road test for any unusual noise from body and attachments, running gear, suspensions, or wheels, that might indicate looseness, damage, wear, inadequate lubrication, or underinflated tires.

(8) Halt vehicle at 10-mile intervals for services (9) to (11) below.

(9) **AIR BRAKE SYSTEM LEAKS.** With air pressure at governed maximum (105 lb) and brakes applied, stop engine. There should not be a noticeable drop in pressure in one minute.

(10) **TEMPERATURES.** Cautiously hand-feel each brake drum and wheel hub for abnormal temperatures. Examine transmission, transfer, and rear axle housings for indications of overheating, or excessive lubricant leaks at seals, gaskets, or vents.

(11) **LEAKS.** With engine running, and fuel, engine oil, and cooling systems under pressure, look within engine compartment and under vehicle for indications of leaks.

e. Upon completion of run-in test, correct or report any deficiencies noted. Report general condition of vehicle to designated individual in authority.

Section X

SECOND ECHELON PREVENTIVE MAINTENANCE

Paragraph

Second echelon preventive maintenance services

29

29. SECOND ECHELON PREVENTIVE MAINTENANCE SERVICES.

a. Regular scheduled maintenance inspections and services are a preventive maintenance function of the using arms, and are the responsibility of commanders of operating organizations.

(1) **FREQUENCY.** The frequency of the preventive maintenance services outlined herein is considered a minimum requirement for normal operation of vehicles. Under unusual operating conditions, such as extreme temperatures, and dusty or sandy terrain, it may be necessary to perform certain maintenance services more frequently.

(2) **FIRST ECHELON PARTICIPATION.** The drivers should accompany their vehicles, and assist the mechanics while periodic second echelon preventive maintenance services are performed. Ordinarily the driver should present the vehicle for a scheduled preventive maintenance service in a reasonably clean condition—that is, it should be dry and not caked with mud or grease to such an extent that inspection and servicing will be seriously hampered. However, the vehicle should not be washed or wiped thoroughly clean, since certain types of defects, such as cracks, leaks, and loose or shifted parts or assemblies are more evident if the surfaces are slightly soiled or dusty.

(3) If instructions other than those contained in the general procedures in step (4) or the specific procedures in step (5) which follow, are required for the correct performance of a preventive maintenance service, or for correction of a deficiency, other sections of this manual pertaining to the item involved, or a designated individual in authority, should be consulted.

(4) **GENERAL PROCEDURES.** These general procedures are basic instructions which are to be followed when performing the services on the items listed in the specific procedures. **NOTE:** *The second echelon personnel must be thoroughly trained in these procedures so that they will apply them automatically.*

(a) When new or overhauled subassemblies are installed to correct deficiencies, care should be taken to see that they are clean, correctly installed, and properly lubricated and adjusted.

(b) When installing new lubricant retainer seals, a coating of the lubricant should be wiped over the sealing surface of the lip of the seal. When the new seal is a leather seal, it should be soaked in SAE 10 engine oil (warm, if practicable) for at least 30 minutes. Then the leather lip should be worked carefully by hand before installing the seal. The lip must not be scratched or marred.

(c) The general inspection of each item applies also to any supporting member or connection, and usually includes a check to see whether or not the item is in good condition, correctly assembled,

6-TON, 6 x 6 TRUCK (WHITE, CORBITT, AND BROCKWAY)

secure, or excessively worn. The mechanic must be thoroughly trained in the following explanations of these terms:

1. The inspection for "good condition" is usually an external visual inspection to determine if the unit is damaged beyond safe or serviceable limits. The term "good condition" is explained further by the following terms: not bent or twisted, not chafed or burned, not broken or cracked, not bare or frayed, not dented or collapsed, not torn or cut.

2. The inspection of a unit to see that it is "correctly assembled" is usually an external visual inspection to see whether or not it is in its normal assembled position in the vehicle.

3. The inspection of a unit to determine if it is "secure" is usually an external visual examination, a wrench, hand-feel or a pry-bar check for looseness. Such an inspection should include any brackets, lock washers, lock nuts, locking wires, or cotter pins used in assembly.

4. "Excessively worn" will be understood to mean worn close to, or beyond, serviceable limits, and likely to result in a failure if not replaced before the next scheduled inspection.

(d) *Special Services.* These are indicated by repeating the item numbers in the columns which show the interval at which the services are to be performed, and show that the parts, or assemblies, are to receive certain mandatory services. For example, an item number in one or both columns opposite a TIGHTEN procedure, means that the actual tightening of the object must be performed. The special services include:

1. *Adjust.* Make all necessary adjustments in accordance with the pertinent section of this manual, special bulletins, or other current directives.

2. *Clean.* Clean units of the vehicle with dry-cleaning solvent to remove excess lubricant, dirt, and other foreign material. After the parts are cleaned, rinse them in clean fluid and dry them thoroughly. Take care to keep the parts clean until reassembled, and be certain to keep cleaning fluid away from rubber or other material that it would damage. Clean the protective grease coating from new parts, since this material is usually not a good lubricant.

3. *Special lubrication.* This applies either to lubrication operations that do not appear on the vehicle Lubrication Guide, or to items that do appear on such Guides or charts, but should be performed in connection with the maintenance operations, if parts have been disassembled for inspection or service.

4. *Serve.* This usually consists of performing special operations, such as replenishing battery water, draining and refilling units with oil, and changing or cleaning the oil filter or cartridge.

5. *Tighten.* All tightening operations should be performed with sufficient wrench torque (force on the wrench handle) to tighten the unit according to good mechanical practice. Use torque-indicating wrench where specified. Do not overtighten, as this may strip threads or cause distortion. Tightening will always be understood to include

SECOND ECHELON PREVENTIVE MAINTENANCE

the correct installation of lock washers, lock nuts, and cotter pins provided to secure the tightening.

(e) When conditions make it difficult to perform the complete preventive maintenance procedures at one time, they can sometimes be handled in sections, planning to complete all operations within the week if possible. All available time at halts and in bivouac areas must be utilized if necessary, to assure that maintenance operations are completed. When limited by the tactical situation, items with Special Services in the columns, should be given first consideration.

(f) The numbers of the Preventive Maintenance procedures that follow are identical with those outlined on W.D. A.G.O. Form No. 461, which is the Preventive Maintenance Service Work Sheet for Wheeled and Half-track Vehicles. Certain items on the work sheet that do not apply to this vehicle are not included in the procedures in this manual. In general, the numerical sequence of items on the work sheet is followed in the manual procedures, but in some instances there is deviation for the purpose of conservation of the mechanic's time and effort.

(5) **SPECIFIC PROCEDURES.** The procedures for performing each item in the 1,000-mile (monthly) and 6,000-mile (six-month) maintenance procedures are described in the following road test chart. Each page of the chart has two columns at its left edge, corresponding to the 6,000-mile and 1,000-mile maintenance respectively. Very often it will be found that a particular procedure does not apply to both scheduled maintenances. In order to determine which procedure to follow, look down the column corresponding to the maintenance due, and wherever an item number appears, perform the operations indicated opposite the number.

MAINTENANCE	
6,000-mile	1,000-mile
1	1
2	2

ROAD TEST

NOTE: When the tactical situation does not permit a full road test, perform those items which require little or no movement of the vehicle. When a road test is possible, it should be for preferably 5 miles and not over 10 miles.

1 Before-operation Service. Perform the Before-operation Service as described in paragraph 18.

2 Air Pressure (Build-Up, Governor Cut-off, Low-pressure Indicator). During warm-up period operate engine at fast idle long enough to observe if air brake pressure builds up at normal rate to specified maximum (105 lb), and that governor then cuts off air from compressor. With engine at normal idling speed, bleed air pressure from system by repeated brake application, and observe if compressor cuts in at about 65 pounds. With engine stopped continue test. Low-pressure indicator (Buzzer) should sound at pressures below 60

6-TON, 6 x 6 TRUCK (WHITE, CORBITT, AND BROCKWAY)

MAINTENANCE		DESCRIPTION
1,000 Miles	1,000 Miles	
3	3	<p>pounds. Any abnormal drop in air pressure except from brake application should be investigated by making soap suds tests.</p> <p>Dash Instruments and Gauges.</p> <p>OIL PRESSURE GAGE. Oil pressure should be between 25 and 35 pounds at normal operating engine speed, and 15-pound minimum pressure at idle speed. CAUTION: Stop engine if oil pressure is too low for safe engine operation at any speed.</p> <p>AMMETERS. Main ammeter should show a positive (+) charge for short period after starting engine, until generator restores to batteries current used in starting. Time will depend on condition of charge of batteries and electrical load carried. With batteries fully charged and regulator unit cut in, ammeter may show zero, or only slight charge. "B" ammeter should show charge to indicate "B" battery is receiving current from generator. After stopping engine, investigate any continued discharge (-) readings noted while engine was running with lights and accessories turned off.</p> <p>VISCOMETER. With engine oil at normal operating temperature, indicator should remain in "ideal" range. If pointer remains in "heavy" range inspect oil for dirt or sludge. If pointer goes to "thin" range, it may indicate oil dilution.</p> <p>ENGINE TEMPERATURE GAGE. Reading should increase gradually during warm-up to normal operating temperature (about 160°F). CAUTION: Do not move vehicle until engine temperature has reached 135°F. Maximum safe temperature is 200°F.</p> <p>TACHOMETER. White pointer should indicate actual engine revolutions per minute at any given time. Red pointer indicates and remains at highest revolution per minute attained, and should not exceed recommended governed engine speed, which is 2200 revolutions per minute.</p> <p>SPEEDOMETER. While vehicle is in motion, speedometer should register vehicle miles per hour, and odometer should record total accumulating mileage.</p> <p>FUEL GAGE. With ignition switch at "ON" position, fuel gage should register approximate amount of fuel in tanks.</p> <p>AIR PRESSURE GAGE. Refer to item 2 for specifications and tests.</p>
4	4	<p>Horns, Mirrors, and Windshield Wipers. If tactical situation permits, test horns for proper operation and</p>

SECOND ECHELON PREVENTIVE MAINTENANCE

MAINTENANCE		
1 Mile	1 Mile	
5	5	<p>tone. Test operation of wiper motors and see that wiper blades contact glass evenly, and operate through their full range. Adjust rear-vision mirrors for correct vision.</p> <p>Brakes (Service and Parking, Braking Effect, Feel, Side Pull, Noise, Chatter, Pedal Travel, Hand Control). Operate brakes at various speeds during road test.</p> <p>SERVICE BRAKES. Apply foot pedal sufficiently to stop vehicle in minimum distance and observe their effectiveness. Any pull to one side, unusual noise, or chatter. Pedal should depress with little effort, and should return to "OFF" position when released. Apply trailer brake hand application lever to see if it functions without binding.</p> <p>PARKING BRAKE. Stop vehicle on reasonable incline; apply parking brake and observe if it holds vehicle effectively; that lever has at least $\frac{1}{2}$ travel in reserve, and that ratchet and pawl latch the applied brake securely.</p>
6	6	<p>Clutch (Free Travel, Drag, Noise, Chatter, Grab, Slip). Pedal free travel should be $1\frac{1}{4}$ inches before meeting resistance. Test clutch for drag when shifting into low gear. Clutch should stop transmission entirely while vehicle is stationary, and shift should be made without clashing. Note any unusual noise when pedal is depressed, which may indicate defective or dry re-lease bearing. With transmission in gear, note any tendency to chatter or grab when clutch is engaged, or slippage when fully engaged under load. NOTE: Never allow pedal free play to become less than $\frac{1}{4}$ inch.</p>
7	7	<p>Transmission and Transfer (Lever Action, Decutching, Vibration, Noise). Levers should move into each gear range position easily and without unusual noise. Test declutching lever to see that front axle engages properly. Note any vibration that may indicate loose mountings, or any noise that may indicate damaged, excessively worn, or inadequately lubricated parts.</p>
8	8	<p>Steering (Free Play, Bind, Wander, Shimmy, Side Pull, Column and Wheel). With vehicle in motion, move steering wheel fully in both directions and observe whether there is any indication of looseness or binding. Note any tendency to wander, shimmy or pull to one side. See that steering column and wheel are in good condition and secure.</p>
9	9	<p>Engine (Idle, Acceleration, Power, Noise, and Governed Speed). Observe engine operating characteristics as follows:</p>

6-TON, 6 x 6 TRUCK (WHITE, CORBITT, AND BUCKWAY)

MAINTENANCE		
Low Mi	High Mi	
		<p>IDLE. Engine should idle smoothly without stalling.</p> <p>UNUSUAL NOISES. Listen for knocks and rattles as the engine is accelerated and decelerated, and while it is under both light and heavy loads.</p> <p>ACCELERATION AND POWER. Operate the engine at various speeds in all gear ratios, noting if the vehicle has normal pulling power and acceleration. Note any tendency to stall while shifting. A slight "ping" during fast acceleration is normal. Continued or heavy "ping" may indicate early timing or heavy accumulation of carbon.</p> <p>GOVERNED SPEED. With the vehicle in a low gear, slowly depress the accelerator to the toeboard. Observe tachometer reading and note if the engine speed exceeds the specified 2200 revolutions per minute.</p>
10	10	<p>Unusual Noises (Attachments, Cab, Body, Wheels). Be on alert during road test for any noise that may indicate loose or damaged attachments mounted on vehicle, loose cab mountings, floor plates, doors, windshield or hardware. Listen particularly for indications of loose wheel mountings.</p>
12	12	<p>Air Brake System Leaks. With the air pressure at the governed maximum and the brakes applied, stop the engine. There should not be a noticeable drop in pressure within one minute. If any pressure drop occurs during this check, test the air brake system for leaks by the soap-buds method.</p>
13	13	<p>Temperatures (Brake Drums, Hubs, Axles, Transmission, Transfer). Place hand cautiously on all brake drums and wheel hubs to see if they are abnormally hot. Inspect axle housings, transmission and transfer case for indications of overheating.</p>
14	14	<p>Leaks (Engine Oil, Water, Fuel). Look in engine compartment, and under vehicle for indications of engine oil, coolant, or fuel leaks. Trace any leaks to their source and correct or report them.</p>
<p>MAINTENANCE OPERATIONS</p> <p>Raise Vehicle—Block Safely</p>		
16	16	<p>Gear Oil Level and Leaks (Axles, Transmission, and Transfer). Remove filler plugs in front and rear axles, transmission, and transfer case, and check lubricant levels. Proper level is from lower edge of filler hole to $\frac{1}{2}$ inch below when cool. Allow sufficient time for foaming to subside before checking levels. Note condition of lubricant. If an oil change is due in any of these</p>

SECOND ECHELON PREVENTIVE MAINTENANCE

MAINTENANCE		units, or condition of lubricant indicates an oil change is necessary, drain and refill units with fresh specified oil. Note any indications of excessive lubricant leaks at oil seals or gaskets.
4,000 Miles	8,000 Miles	
17	17	<p>Unusual Noises (Engine, Belts, Accessories, Transmission, Transfer, Shafts and Joints, Axles and Wheel Bearings). With engine running observe as follows:</p> <p>ENGINE, BELTS AND ACCESSORIES. Accelerate and decelerate the engine momentarily, and listen for any unusual noise in these units that might indicate damaged, loose, or excessively worn engine parts, drive belts, or accessories. Also be sure to locate and correct or report any unusual engine noise heard during the road test.</p> <p>TRANSMISSION, TRANSFER, PROPELLER SHAFTS AND JOINTS, AXLES, AND WHEEL BEARINGS. With the transmission in an intermediate gear, and front driving axle engaged, operate these units at a constant, moderate speed by use of the hand throttle, and listen for any unusual noise that might indicate damaged, loose, or excessively worn unit parts. Also observe all propeller shafts and wheels for vibrations and runout, and for vibrations in the other units which may indicate looseness or unbalance. Also be sure to locate, correct, or report any noise noted during road test.</p>
18	18	<p>Cylinder Heads and Gaskets. Look for cracks or indications of oil, coolant, or compression leaks around studs, cap screws, and gaskets. CAUTION <i>Cylinder heads must not be tightened unless there is definite evidence of leaks.</i> If tightening is necessary, use torque-indicating wrench, and tighten head nuts in the proper sequence (par. 53 b) to 105 foot-pounds tension (fig. 35).</p>
	19	<p>Valve Mechanism (Clearances, Cover Gaskets). Adjust valve stem clearance only if noisy or if they are causing engine to run unevenly. Intake clearance 0.010 inch hot, exhaust clearance 0.016 inch hot.</p>
19		<p>ADJUST. Set valve stem clearances to above specifications. See if valve stems, tappets, tappet cluster brackets, springs, seats, and locks are in good condition, correctly assembled, and secure. Inspect valve covers to be sure they are in good condition. Reinstall them securely, using new gaskets if necessary.</p>
22	22	<p>Battery (Cables, Hold-down, Carrier, Keenod Gravity and Voltage). Inspect battery case for cracks and leaks. Clean top of battery. Inspect cables, terminals, bolts, posts, straps and hold-downs for good condition. Test specific gravity and voltage and record on W.D., A.G.O. Form No. 461. Specific gravity readings below</p>

6-TON, 6 x 6 TRUCK (WHITE, CORBITT, AND BROCKWAY)

MAINTENANCE		
EMP. NO.	TIME IN H.	
		1.225 at normal temperature indicate battery should be recharged or replaced. For freezing temperatures, see specifications in paragraph 142. Electrolyte level should be $\frac{3}{8}$ inch above top of plates.
22		Perform high-rate discharge test according to instructions for "condition" test which accompany test instrument and record voltage on W.D. A.G.O. Form No. 461. Cell variation should not be more than 30 percent. NOTE: Specific gravity must be above 1.225 to make this test.
22	22	Bring electrolyte to proper level by adding clean water. Clean entire battery and carrier. Repaint carrier if corroded. Clean battery cable terminals, terminal bolts, and hold-downs carefully to avoid damage to battery.
	20	Spark Plugs (Gaps, Deposits). Without removal, wipe off plugs and examine insulators for damage or indications of compression leaks.
20		Remove all plugs and examine to see if they are in good condition. Pay particular attention to broken insulators, excessive carbon or oxide deposits, and to electrodes burned thin. Clean plugs thoroughly. If plug cleaner is not available, install new or reconditioned plugs. NOTE: Do not install plugs until item 21 has been performed. Set plug gaps to 0.025 inch by bending only grounded electrodes.
21		Compression Test. Test compression with all spark plugs removed. There should not be more than 5 pounds variation between cylinders. Record compression pressures on space provided on back of work sheet, Form No. 461.
23	23	Crankcase (Leaks, Oil Level). With engine idling examine crankcase, valve covers, timing gear cover, and clutch housing for oil leaks. Stop engine and, after oil has drained into crankcase, check to see if it is up to proper level. If an oil change is due, or condition of oil indicates the necessity, drain crankcase and refill to correct level with fresh specified oil. Same procedure applies to auxiliary air compressor. NOTE: Do not start engine again until item 24 has been performed.
24	24	Oil Filters and Lines. Inspect filters and external engine oil lines to see if they are in good condition, secure, and not leaking. Remove filter body drain plugs and drain off contents. Remove filter cartridge and check condition. If cartridge change is due, or condition indicates the necessity, replace with new cartridge, being sure gaskets are in place, and tighten covers and drain plugs securely. CAUTION: Start engine mo-

SECOND ECHELON PREVENTIVE MAINTENANCE

WORK SHEET		DESCRIPTION
DATE	TIME	
25	25	mentarily until oil pressure is indicated. Stop engine, check oil level in crankcase, and add as necessary to bring to running mark.
		Radiator (Core, Shell, Mountings, Hose, Cap and Gasket, Antifreeze Record, Overflow Pipe). Inspect all applicable items to see if they are in good condition, secure, and not leaking. Be sure overflow pipe is not kinked or clogged. Examine condition of coolant to see whether it is so contaminated that cooling system should be cleaned. If cleaning is necessary, proceed only according to current directives covering proper procedure and recommended cleaner neutralizer, and inhibitor materials (par. 72). Clean all insects, dirt, or grease deposits from core air passages and inspect for bent cooling fins. CAUTION: Use only a suitably shaped piece of wood or blunt instrument to straighten fins. If antifreeze is in use, test its protective value and record in space provided on back of work sheet, Form No. 461.
25		TIGHTEN. Carefully tighten all loose radiator mountings, water connections and hose clamps.
26	26	Water Pump and Fan. Inspect pump to see if it is in good condition, secure, and not leaking. Examine shaft for end play or bearing looseness. Inspect fan to see if it is in good condition and that blades and hub are secure. Loosen drive belts and examine fan for hub or bearing wear. Leave drive belts loose until adjustment is made (item 29).
		TIGHTEN. Carefully tighten water pump, fan assembly, and mounting nuts or screws. Tighten water pump packing gland nuts until they are just snug. CAUTION: Overtightening of packing gland nuts will cause premature packing and shaft wear, and will result in leaks.
27	27	Generator, Starter, and Switch. Inspect generator, cranking motor, and cranking motor switch to see if they are in good condition, securely mounted, and if wiring connections are clean and secure.
27		Remove generator and cranking motor inspection covers and examine commutators and brushes to see that they are in good condition and clean. If brushes are free in brush holders and have sufficient spring tension to hold them in proper contact with commutators, and if brush connection wires are secure and not grounding.
27		CLEAN. Blow out commutator end of generator and cranking motor with compressed air. If commutators

4-TON, 4 x 6 TRUCK (WHITE, CORBITT, AND BROCKWAY)

Inspection		
1,000 Miles	1,000 Miles	
27		are dirty, clean only with flint paper 2/0 (do not use emery) placed over end of suitable-sized piece of wood, and again blow out with air. TIGHTEN. Carefully tighten cranking motor mounting bolts securely.
28	28	Air Compressor (Unloader Valve, Governor, Lines). Examine the air compressor to see that it is in good condition, properly aligned with its drive pulleys, and secure. Check unloader valve for satisfactory valve clearance. On vehicles equipped with auxiliary compressors, inspect and service in like manner. See if the governor appears to be in good condition and secure; if all the compressor water, oil, and air lines within engine compartment are in good condition and secure, and that oil and water lines do not leak. CLEAN. Clean governor air strainer in dry-cleaning solvent; dry, apply a thin film of engine oil to strainer and reinstall.
28		SPECIAL LUBRICATION. Apply a few drops of engine oil on the unloader valve fulcrum pin. Apply a few drops of kerosene or solvent on upper valve stem of governor. ADJUST unloader valve clearances 0.010 inch to 0.015 inch.
29	29	Drive Belts and Pulleys. Examine all drive belts for evidence of fraying condition, excessive wear, and deterioration. Inspect all drive pulleys and hubs to see if they are in good condition and securely mounted. ADJUST. Set adjustment so drive belts have 3/4-inch finger-pressure deflection.
30	30	Tachometer Drive and Adapter. See if they are in good condition, correctly assembled, and secure. Inspect the flexible drive shaft for kinks, and connection for indications of oil leaks.
31	31	Distributor (Cap, Rotor, Points, Shaft, Advance Units). Observe if distributor body and external attachments are in good condition and secure. Examine other parts as follows: CAP, ROTOR, AND POINTS. Clean dirt from cap and remove. Inspect cap, rotor, and breaker plate to see if they are in good condition, secure, and serviceably clean. Pay particular attention to cracks in cap and rotor, corrosion of terminals and connections, and to burned rotor bar or contact points. See that points are well aligned and adjusted to 0.018 inch to 0.024 inch when wide open. If inside of distributor is dirty, remove assembly, clean in dry-cleaning solvent, dry thoroughly with compressed air, and lubricate its friction parts very lightly.

SECOND ECHELON PREVENTIVE MAINTENANCE

MAINTENANCE		
LAB No.	LAB No.	
		When cleaning, remove wick and lubrication cup, clean them, recoil, and replace after cleaning distributor. If breaker points are pitted, burned, or worn to an unserviceable degree, replace. Also replace condenser if points are burned, as this may be the cause. When cleaning points, use fine file or flint paper 2/0 (never use emery), and blow out firing with compressed air.
		SHAFT. Test shaft by hand-feel for excessive wear in shaft or bushings.
		CENTRIFUGAL ADVANCE. Install rotor on shaft, and test distributor governor by finger-force for normal range of movement permitted by mechanism. Note if it will return to original position when released without hang-up or binding.
		MANUAL SPARK CONTROL. Inspect control for proper operation, wear, or damage.
31	31	SPECIAL LUBRICATION. Lubricate cam surfaces, breaker arm pin, and wick according to Lubrication Guide instructions.
31		ADJUST. Set breaker point gaps to 0.018 inch to 0.024 inch.
32	32	Coil and Wiring. Inspect coil, ignition wiring, and conduits to see if they are in good condition, clean, securely connected, and properly mounted. Inspect all low-voltage wiring in engine compartment in like manner.
33	33	Manifolds and Heat Control (Gaskets, Seasonal Setting). Inspect for looseness, damage, or exhaust leaks at gaskets. Examine for evidence of cracks or sand holes usually indicated by carbon streaks. Set heat control for correct seasonal use.
33		TIGHTEN. Carefully tighten all manifold assembly and mounting nuts securely.
34	34	Air Cleaners. Inspect carburetor and air compressor air cleaners to see if they are in good condition, securely mounted, and connected, and not leaking. Remove reservoir and element, clean in dry-cleaning solvent, dry, fill reservoir to proper level with clean engine oil, and reassemble. Be sure gaskets are in place and all joints and air horn connections tight.
35	35	Breather Cap. Inspect crankcase breather cap to see if it is in good condition, secure, and not leaking. Remove oil reservoir and element, wash clean in dry-cleaning solvent, refill reservoir with fresh engine oil and reassemble securely.
36	36	Carburetor (Choke, Throttle, Linkage, and Governor). See if they are in good condition, correctly assembled, and securely installed; that carburetor does

6-TON, 6 x 6 TRUCK (WHITE, CORBITT, AND BROCKWAY)

MAINTENANCE		
LINE NO.	LINE NO.	
		not leak; that control linkage, including choke and throttle shaft, is not excessively worn; if choke valve opens fully when the control is in its released position; if throttle valve opens fully when the accelerator is fully depressed, and if the governor is secure and properly sealed.
37	37	Fuel Filter and Lines. Examine filter to see if it is in good condition, securely mounted, connected, and not leaking. CLEAN. Close fuel shut-off and remove filter sediment bowl and element. Wash clean in dry-cleaning solvent and reassemble securely, being sure gaskets are in place. CAUTION: If element cannot be cleaned by washing, replace unit. Do not scrape element to clean. Turn on fuel supply and recheck for leaks.
38	38	Fuel Pump (Pressure). Inspect pump to see if it is in good condition, securely mounted, and not leaking. Remove sediment bowl and screen, and wash in dry-cleaning solvent. Be sure gasket is in place and serviceable when bowl is reinstalled.
38		Attach a test gage to pressure side of fuel pump and, after starting engine in item 39, see that pressure is satisfactory (should be 3 pounds minimum, 4 1/4 pounds maximum at idle speed).
39	39	Cranking Motor (Action, Noise, Speed). Start the engine, observing if general action of cranking motor is satisfactory, particularly that it engages and operates properly without excessive noise and has adequate cranking speed, and if the engine starts readily. Also, as soon as engine starts, note whether oil pressure gage and ammeter indications are satisfactory.
40	40	Leaks (Engine Oil, Fuel, and Water). With engine running, recheck all points of oil, fuel, and cooling systems for leaks. Trace any found to source and correct or report them.
41	41	Ignition Timing (Advance). With engine running, and a neon timing light connected, observe if ignition timing is correct. Also note whether automatic controls advance the timing as engine is accelerated gradually.
41		Adjust ignition timing to specifications in paragraph 81.
42	42	Engine Idle and Vacuum Test. Inspect as follows: ADJUST Connect a vacuum gage to intake manifold, adjust engine to its normal idle speed by means of throttle stop screw, and then adjust the idle mixture adjusting needle until vacuum gage indicates a steady maximum reading (par. 63). If these latter adjustments are made simultaneously, time will be saved.
42	42	Vacuum Test. With the engine running at normal idling speed, vacuum gage should read about 18 to 21 inches.

SECOND ECHILON PREVENTIVE MAINTENANCE

REFERENCE		
4.00 INCH	4.00 INCH	
		and pointer should be steady. A badly fluctuating needle between 10 and 15 inches may indicate a defective cylinder head gasket or valve. An extremely low reading may indicate a leak in intake manifold or gasket. Accelerate and decelerate engine quickly. If vacuum gage indicator fails to drop to approximately 7 inches as throttle is opened, and then fails to recoil to at least 24 inches as throttle is closed, it may be an indication of diluted oil, poor piston ring sealing, or abnormal restriction in carburetor, air cleaner, or exhaust. NOTE: Above readings apply to sea level. There will be approximately a 1-inch drop for each 1000 feet of altitude.
43	43	Regulator Unit (Connections, Voltage, Current, and Cut-out). Inspect regulator unit to see if it is in good condition, securely mounted, connected, and clean.
43		TEST. Connect a low voltage circuit tester and observe if generator output is properly controlled by voltage regulator, current regulator and cut-out. Follow instructions in vehicle manual, or those which accompany test instrument. Replace if test shows faulty operation. CAUTION: This test should be made only after regulator unit has reached normal operating temperature.
44	44	Power Tire Inflation (Connection, Line). Inspect tire inflation connection at reserve tank to see that it is in good condition, and clean. Be sure cap is present and connected by safety chain. Note whether valve turns easily and is not excessively worn. Examine air hose for deterioration and check for damage or clogging. Connect hose and test system for proper function when performing item No. 47. With inflation valve open and governor cut-out, see if air pressure will build up to 150 pounds, and if safety valve operates at that pressure.
47	47	Tires and Rims (Valve Stems and Caps, Condition, Direction, Matching Spare Carrier). Inspect as follows: VALVE STEMS AND CAPS. Observe if all valve stems are in good condition and in correct position, and if all valve caps are present and installed securely. Do not tighten with pliers. CONDITION. Examine all tires for cuts, bruises, breaks, and blisters. Remove embedded glass, nails, and stones. Look for irregular tread wear, watching for any sign of flat spots, cupping, feather edges, and one sided wear. Remove tires worn thin at center of tread (or otherwise unserviceable tires) and exchange for new or retreaded tires. Any mechanical deficiencies causing such conditions should be determined, and corrected.

6-TON, 6 x 6 TRUCK (WHITE, CORBITT, AND BROCKWAY)

MAINTENANCE	
1,000 MIS	1,000 MIS
47	
48	

or reported. Wheel positions of tires with irregular wear should be changed to even up wear. Front tires, worn irregularly, should be moved to rear wheel positions.

DIRECTION. Directional tires and nondirectional tires should not be installed on same vehicle. Directional tires on rear wheels should be mounted so that the V of chevron will point down when viewed from the front. Directional tires on all front wheels will ordinarily be mounted so that V of chevrons will point up when viewed from front of vehicle.

MATCHING. With tires properly inflated, inspect them to see if they are matched according to over-all circumference and type of tread.

SPARE TIRE CARRIER. See whether spare tire carrier is in good condition and secure.

RIMS. All rims and their lock rings or flanges should be in good condition and secure.

47 **TIGHTEN.** Tighten all wheel rim flange or lug nuts securely

47 **SERVS.** With tires properly inflated to 70 pounds for 10.00 x 22 tires, 80 pounds for 12.00 x 20, and 90 pounds for 14.00 x 20 tires (cool), check over-all circumference of all tires, including spares. Select tires to be mounted on duals or on driving axles, so they will not have differences in over-all circumference exceeding the 3/4-inch limits specified in current directives and bulletins. Mount all dual tires with the larger tire on the outside. The valve stem on inner wheels should point out, and the valve stem on outer wheel should point in, and should be opposite each other. **NOTE:** Spares must be matched properly and mounted for use on one of the road wheels at intervals not exceeding ninety days. A convenient time to do this is during these maintenance services. **CAUTION.** After performing the tire-matching service, do not reinstall wheels until wheel-bearing services are completed.

48 **Rear Brakes (Drums, Supports, Cams and Shafts).** Inspect and service as follows: With rear wheels removed: **NOTE:** On 6,000-mile maintenance, several wheel bearing and brake items up to 52 are group services, and thus overlap. Perform in best order for economy of time and orderly reassembly.

DRUMS AND SUPPORTS. Clean dirt and grease from drums and supports (dust shields) keeping dry-cleaning solvent away from linings. Examine drums and supports to see if they are in good condition, securely mounted and if drums are excessively worn or scored.

CAMS AND SHAFTS. See if cams and shafts, where they

SECOND ÉCHELON PREVENTIVE MAINTENANCE

MAINTENANCE		
Item No.	Time	
		contact, are excessively worn; also determine if cam shafts operate freely in collar, and if shafts and collars are worn.
		TIGHTEN. Tighten brake support cap screws and hubs to drum nuts securely.
49		Rear Brake Shoes (Linings, Anchors, Springs). Examine linings through inspection holes to see if they are so worn that rivet heads may contact drums within next 1,000 miles of operation. If vehicle has been operated in deep water, mud, or loose sand, remove forward right rear wheel and examine lining for damage. If this lining must be replaced, remove all wheels, check their brakes and service as necessary, being sure to clean, lubricate, and adjust all removed wheel bearings as described in item 52 below for 6,000-mile service.
		ADJUST. Adjust shoes by minor method if necessary.
49		While rear wheels are removed, inspect linings to see if they are in good condition, tightly secured to brake shoes, in good wearing contact with drums, free of dirt or lubricant, and not excessively worn. Also see if shoes are in good condition, properly secured to anchors, guides, and retracting springs, and that springs have sufficient tension to return shoes properly to released position. Thickness of lining at most worn point should be enough for at least 1,000 miles of service before rivet heads are likely to contact drums.
		CLEAN. Clean all dirt and grease from linings with wire brush, cloth, or compressed air.
		ADJUST. After subsequent related items to 60 inclusive are completed, adjust shoes by minor method. If new linings have been installed, adjust by major method described in paragraph 121. Adjust slack adjusters so diaphragm push-rod travel is at minimum, approximately $\frac{3}{4}$ inch, and drum to lining clearance is 0.016 inch.
50	50	Torque Rods. Inspect upper and lower torque rods and mounting brackets to see if they are in good condition, evenly adjusted, and securely connected. If rubber bushings are hard or cracked, apply a coating of hydraulic brake fluid to surfaces.
51	51	Rear Spring or Walking Beam, Seat, and Bushings. Inspect rear spring or walking beam seats to see if they are in good condition, secure, and not leaking excessive lubricant.
51		ADJUST. Check adjustment of rear spring seat bushing. Should not be allowed to exceed 0.025 inch.

6-TON, 6 x 6 TRUCK (WHITE, CORBITT, AND BROCKWAY)

MAINTENANCE		
1,000 MIL	1,000 MIL	
		SPECIAL LUBRICATION. Fill spring seat reservoirs to proper level with specified oil.
52	52	Rear Wheels (Bearings, Seals, Drive Flanges, and Nuts). Inspect and service as follows:
	52	WHEELS. Inspect wheels to see if they are in good condition, and secure.
		BEARINGS AND SEALS. Check for looseness of wheel bearing adjustment. Revolve wheels and listen for evidence of dry or damaged bearings. Inspect around flanges and brake supports for lubricant leaks.
		DRIVE FLANGES AND NUTS. Note if they are in good condition, and if nuts are tightened securely.
52		CLEAN. Disassemble rear wheel bearings and oil seals. Clean thoroughly in solvent and examine bearing cups and cones to see if they are in good condition; if machined surfaces they contact are in good condition and if there is any excessive wear.
52		SPECIAL LUBRICATION. When all of the related items are to the point where wheel bearings are to be reinstalled, lubricate bearings as follows: Take care to use clean lubricant, have all parts clean and dry, and the hands clean. The inside of the wheel hub, and hub cap or hub flange, and outside of spindle or axle shall be lubricated to a thickness of $\frac{1}{16}$ inch minimum to retard rusting. Bearing shall be either machine-packed or hand-packed by kneading lubricant into all spaces in the bearings. Coat the cups or outer races and the lips of the oil seals with lubricants, and install new lubricant retainer seals if necessary. CAUTION: Do not pack the large cavity in wheel hubs between wheel bearings with lubricant. To do so is to cause leakage past the seals.
52		ADJUST. After lubricating wheel bearings, reassemble hub and drum assemblies into place, and adjust wheel bearings correctly according to paragraphs 105 and 109.
	53	Front Brakes (Drums, Supports, Cams and Shafts, Hose, Air Chambers, Push Rods and Seals, Slack Adjusters). Inspect brake hose, chambers, push rods and seals, and slack adjusters to see if they are in good condition, correctly assembled, and secure.
	53	Remove front wheels and inspect and service as follows:
		DRUMS AND SUPPORTS. Clean and inspect in same manner as in item 48.

SECOND ECHELON PREVENTIVE MAINTENANCE

MONTH (Mileage)		
1950 Mile	1950 Mile	
		CAMS AND SHAFTS. Inspect in same manner as in item 48.
	54	Front Brake Shoes (Linings, Anchors, Springs). Inspect in same manner as in item 49. ADJUST. Adjust by minor method if necessary.
54		Remove front wheels and inspect shoes, linings, anchors, and springs in same manner as in item 49 at 6,000-mile service. CLEAN. Clean in same manner as in item 49.
54	54	ADJUST. Adjust in same manner as in item 49 after subsequent related items to 60 inclusive are completed.
55	55	Steering Knuckles (Joints, Bearings, Seals). Inspect to see if knuckle housings are in good condition. Look particularly for cracks around steering arms. See if outside knuckle felt seals and seal flanges are in good condition and secure. Remove lubrication plug, and examine sample of lubricant to see if it appears to be contaminated.
55		CLEAN. Remove constant velocity universal joint assembly. Wash thoroughly in dry-cleaning solvent and, without disassembly of universal joint, inspect parts to see if they are in good condition and not excessively worn. Pay particular attention to universal joint washers, balls, cage, races, axle splines, flanges and pivot bearings.
55		SPECIAL LUBRICATION. Pack new lubricant well into constant velocity universal joint until it fills all space between balls, cages and races. Reassemble steering knuckle, taking care to replace any unserviceable lubricant retainer seals, boots, or gaskets.
55		ADJUST. Use every precaution to reinstall shims and spacers in the original position from which they were removed at disassembly, to insure correct pivot bearing and axle end play adjustment.
56	56	Front Springs (Clips, Leaves, U-bolts, Hangers, and Shackles). See if they are in good condition, correctly assembled, and secure. Spring clips and bolts should be in place, spring leaves should not have been shifted out of their correct position. This latter condition may be an indication of a sheared center bolt. Note if deflection of both springs is normal and approximately the same. Test hangers and bolts for excessive wear by means of a pry bar. TIGHTEN. Tighten all spring U-bolts securely and uniformly.
57	57	Steering (Arms, Tie Rods, Drag Link, Seals and Boots, Pitman Arm, Gear, Column and Wheel). See

6-TON, 6 x 6 TRUCK (WHITE, CORBITT, AND BROCKWAY)

MAINTENANCE		
LINE	1,000	
IN IN.	MI.	
		if these stems are in good condition, correctly and securely assembled and mounted, if steering gear case is leaking lubricant, and if lubricant is at proper level. Pay particular attention to Pitman arm to see if it is securely mounted, and not bent out of its normal shape. Also observe if steering system is in good adjustment.
57		TIGHTEN. Tighten Pitman arm shaft nut securely. Also tighten steering gear case assembly and mounting nuts or screws, taking care not to disturb adjusting screws and lock nuts. CAUTION: <i>Loosen steering column bracket when tightening steering case mounting nuts, so as not to distort column.</i>
60	60	Front Wheels (Bearings, Seals, Flanges, Axle End Play and Nuts). Inspect front wheels, bearings, seals, drive flanges, and nuts in same manner as in item 52 for similar rear wheel items.
60		CLEAN. Disassemble, clean, and inspect the front wheel bearings and oil seals in the same manner as described in item 52, taking care to check the universal joint end play as the drive flanges are removed, so that the end play adjustment may be made conveniently when reassembling.
60		SPECIAL LUBRICATION. Apply in same manner as described in item 52.
60		ADJUST. Adjust wheel bearings in same manner as described in item 52, and adjust brake shoes as described in item 49.
61	61	Front Axle (Pinion End Play, Seal, Vent, and Alignment). If front axle appears to be out of line, measure distance from front spring eyebolt to center of axle spring pad on each side. Distance should be equal. Inspect axle housing to see if it is in good condition and not leaking. Examine pinion shaft for excessive end play, and check seal for leaks. CLEAN. Clean axle housing vent thoroughly.
62	62	Front Propeller Shaft (Joints, Alignment, Seals, and Flanges). See if these items are in good condition, correctly and securely assembled and mounted; if the universal joints are properly aligned with each other and are not excessively worn; that the slip joint is free, not excessively worn, and well lubricated; and that the seals on the universal joints and slip joint do not leak.
62		TIGHTEN. Tighten all universal joint assembly and companion flange bolts securely.
63	63	Engine (Mountings, Ground Strap, Side Pans). These items should be in good condition and securely mounted and connected. Be sure to examine both front

SECOND ECHELON PREVENTIVE MAINTENANCE

MAINTENANCE		
1,000 MI.	1,000 MI.	
64	64	and rear engine mountings, and to see, on rubber mountings, that rubber is not separating from its metal backing. If mounting bolts are loose, tighten them properly, taking care not to overtighten. Remove oil or grease from rubber mountings. Apply a film of brake fluid if rubber is hard or cracking.
64		Hand Brake (Ratchet and Pawl, Linkage, Disk, and Lining). Examine to see if catchet, pawl, and linkage are in good condition, secure, and not excessively worn; that disk is not scored or oily, and that lining is not oil-soaked or worn too thin.
64		ADJUST. Set clearance between brake disk and lining to 0.006-0.008 inch when brake lever is released.
65	65	Clutch Pedal (Free Travel, Linkage, Return Spring). Check pedal free travel, which should be $1\frac{1}{2}$ inches before meeting resistance. Examine to see if pedal is securely mounted to shaft, if clutch operating linkage is in good condition, secure, and not excessively worn at friction joints. See if return spring has proper tension to bring pedal to correct released position.
65		ADJUST. Adjust plate so clutch pedal free travel is $1\frac{1}{2}$ inches, with toeboard clearance of $\frac{3}{4}$ inch. CAUTION: No pedal adjustment should be made except for toeboard clearance. For correct procedure, see paragraph 60.
66	66	Brake Pedal (Free Travel, Linkage, and Return Spring). Pedal should have $\frac{1}{2}$ to 1 inch free travel, and should operate easily. Inspect all linkage to see if it is in good condition, securely connected, and not excessively worn at friction joints. Be sure return spring has tension to bring pedal to correct released position.
69	69	Air Brake Application Valve. See if application valve and linkage are in good condition, correctly assembled, and secure; also see that valve closes fully when brake pedal is released.
70	70	Air Brake and Pontoon Inflation Reservoirs. Observe whether they are in good condition and secure. Open the drain cocks and drain off water.
71	71	Transmission (Mountings, Seals, Linkage). Note if transmission case is in good condition and securely mounted, and inspect for lubricant leaks at seals and gaskets. Examine control linkage and shift mechanism for damage or excessive wear.
72	72	Transfer (Mountings, Linkage, Seals, Vent). See if case is in good condition and securely mounted, that transmission and declutching control linkage and shift

6-TON, 6 x 6 TRUCK (WHITE, CORBITT, AND BROCKWAY)

REQUIREMENT		
6,000 Miles	1,000 Miles	
72		mechanism are securely connected and not damaged, and if vent is open. Look for evidence of lubrication leaks at seals and gaskets. Clean vent passage if clogged. TIGHTEN. Draw up all external assembly and mounting nuts securely.
73	73	Rear Propeller Shafts. Inspect in same manner as in item 62. TIGHTEN. Draw up all universal joint and companion flange bolts securely.
74	74	Center Bearings. Inspect all drive shaft center bearings to be sure they are in good condition, securely mounted, and not leaking. Tighten securely.
75	75	Rear Axle (Pinion End Play, Seals, Vent, and Alignment). Inspect in the same manner as in item 61 for front axle. CLEAN. Clean axle housing vent thoroughly.
76	76	Rear Air Brakes (Chambers, Rods, Seals, and Slack Adjusters). See if all items are in good condition, securely connected, and mounted. Examine rods for excessive wear, also seals for lubricant leaks.
77	77	Rear Springs (Clips, Leaves, U-bolts). Inspect and tighten in same manner as in item 56.
79	79	Cab and Body Mountings. Note if they are all in good condition and secure. On cab mountings using coil springs, be sure springs are in good condition and properly compressed. These springs should be neither loose nor compressed solid. TIGHTEN. Tighten cab and body mountings evenly and securely, taking care to loosen the steering column clamp before aligning or tightening cab. When tightening spring-loaded mounting bolts, do not compress springs fully. After completing this service, be sure to tighten steering column clamp.
80	80	Frame (Side and Cross Members). Inspect frame, brackets, side rails, and cross members to see if they are in good condition, secure, and correctly aligned. If the frame appears to be out of line, report condition.
81	81	Wiring, Conduit, and Grommets. Observe these items underneath the vehicle, to see if they are in good condition, properly supported, connected, and secure.
82	82	Fuel Tank, Fittings, and Lines. Inspect fuel tank to see if it is in good condition and securely mounted. Examine cap for defective gasket or plugged vent. See that filler neck is in good condition, and that cap fits securely.
83		Remove fuel tank drain plug, and drain off accumulated water and dirt in bottom of tank. Drain only

SECOND ECHOLON PREVENTIVE MAINTENANCE

MAINTENANCE		
400 Mts	400 Mts	
83	83	until fuel runs clear. Use necessary precautions against fire.
		Brake Lines (Fittings and Hose). Examine all lines and fittings (including pontoon inflation system) and air brake hose under vehicle to see if they are in good condition, securely connected, and supported so that lines or hose will not chafe against other vehicle parts.
84	84	Exhaust Pipes and Muffler. Examine exhaust pipe to see if it is securely attached to exhaust manifold, that gasket or packing does not show visible evidence of leakage, and that the other end of exhaust pipe is clamped securely to muffler. Inspect muffler to see if it is in good condition and securely mounted. Check tailpipe to see if it is securely clamped to muffler, properly supported, and unobstructed at its outer end. See that drain holes in muffler are at lowest point, and not clogged.
85	85	Vehicle Lubrication. If due, lubricate in accordance with Lubrication Guide (section VII) and current lubrication directives, using only clean lubricant, and omitting items that have had special lubrication during service. Replace damaged or missing fittings, vents, flexible lines, or plugs.
LOWER VEHICLE TO GROUND		
86	86	Toe-in and Turning Stops. With front wheels on ground and in straight-ahead position, use a toe-in gage to determine if adjustment is as specified ($\frac{1}{8}$ to $\frac{1}{16}$ in.). Turn wheels fully in both directions and see if turn is limited by stops. In this position, note if tires clear all parts of vehicle, and if there is abnormal front drive universal joint wear, report for check of turning angle by higher echelon.
87	87	Winch (Clutch, Drive, Brakes, Shear Pin, Cable). Observe whether all items are in good condition, correctly assembled and secure. See that clutch moves freely and lever latches securely; also that drum brake holds drum from spinning when cable is unwound. Test automatic safety brake. Set truck or tractor at the top of a steep bank. Fasten the winch line to a vehicle at the bottom of the bank. Start pulling the vehicle up the bank, and throw out the engine clutch. If vehicle starts to back downhill, the brake needs adjusting. Start lowering the vehicle down the bank, and throw out engine clutch. If vehicle does not stop, or drifts more than one or two inches, brake needs adjusting. When lining is worn to rivet heads or does not hold vehicle after adjustment is made, the lining should be

4-TON, 6 x 6 TRUCK (WHITE, COBBITT, AND BROCKWAY)

MAINTENANCE		
ITEM NO.	ITEM NO.	
		replaced. CAUTION: <i>The lining used on the automatic worm brake is a special type, developed especially for this purpose. Do not substitute ordinary brake lining, as a serious injury or accident may result.</i> Inspect propeller shaft in same manner as in item 82, and see that proper shear pin is installed. Propeller shaft front yoke should slide freely on shaft to insure safety feature of shear pin. On tractor mounted winch, see if sprockets and drive chains are in good condition; adequately lubricated, and chains not too slack. Inspect cable to see that it is in good condition, evenly wound, and note whether cable chain and hook are securely attached. Lubricate winch clutch, shaft on which it slides, and operating arm, moving clutch back and forth to be sure it is free.
87		CLEAN AND SERVE. Unwind cable and inspect for broken or frayed strands and for flat or rusty spots. Clean entire length of cable with cloth saturated with very thin oil or kerosene. Remove excess, and as cable is rewound evenly on drum, apply a thin film of engine or gear oil. Sample oil in worm gear housing for contamination. If oil change is due or condition of oil warrants, drain and refill with specified oil.
89	89	Tractor to Trailer Brake and Pontoon Inflation Hose and Connections. Examine hose to see if they are in good condition, properly supported, and if connecting fittings are in good condition, and not excessively worn.
91	91	Lamps (Lights) (Head, Tail, Body, Stop, and Black-out). Operate all switches and note if lamps respond. Include stop and blackout lamps. See if foot switch controls head lamp beams properly, and if beams are aimed so as not to blind oncoming traffic. Examine all lights to see if they are in good condition and securely mounted, and that lenses are clean.
91		ADJUST. Adjust lamp-unit beams.
92	92	Safety Reflectors. See if they are all present, in good condition, clean, and secure.
93	93	Front Bumper, Tow Hooks, Brush Guards, and Grille. See if they are in good condition, secure, and that radiator grille is not obstructed.
94	94	Hood and Fasteners. Inspect hood to see if it is in good condition, and that fasteners operate properly and hold hood securely.
95	95	Front Fenders and Running Boards. Examine fenders and running boards to see if they are in good condition and securely mounted.
96	96	Cab (Doors, Hardware, Windshield and Glass, Top and Frame, Side Curtains, Seats, Gun Racks, Grab

SECOND ECHELON PREVENTIVE MAINTENANCE

MAINTENANCE		
9.000 98-99	1.000 100-104	
		Rails, Flourboards, Ventilators, Platforms). Inspect applicable items to see if they are in good condition and secure; that the hardware and ventilators operate properly and are adequately lubricated; and if the doors engage their bumpers and strikers, and latch properly in the closed position. See that the doors are properly aligned with their openings. Be sure any platforms are securely bolted and not damaged.
98	98	Circuit Breakers. Observe if they are in good condition, clean, dry, and securely connected and mounted.
99	99	Rear Splash Guards. See that they are in good condition and securely mounted.
100	100	Body (Panels, Tailgate and Chains, Floor, Skid Strips, Stakes and Sockets, Bows, Tarpaulin and End Curtains, Troop Seats, Stowage Compartments). Inspect all applicable items to be sure they are in good condition, correctly assembled, and secure. See that tarpaulin and curtains are properly lashed to body hooks or loops.
101	101	Pintle Hook. Examine pintles to see if they are in good condition and securely mounted to frame. Test pintle and latch to see if they operate properly: are adequately lubricated, and if lock pin is present and securely attached by chain. Pay particular attention for broken spring or worn draw bar.
103	103	Paint and Markings. Examine paint of entire vehicle to see if it is in good condition, paying particular attention to any bright spots in finish that might cause glare or reflection. Inspect vehicle markings and identification for legibility. Include identification plates and their mountings if furnished.
104	104	Radio Bonding (Suppressors, Filters, Condensers, and Shielding). See if all bonding connections are in good condition, clean, and secure, and note if all items are securely mounted. <i>NOTE. Any irregularities, except cleaning and tightening, should be reported to Signal Corps personnel.</i>
TOOLS AND EQUIPMENT		
131	131	Tools (Vehicle and Pioneer). Inspect standard vehicle and pioneer tools to see if they are all present (pars. 24, 25, and 26), in good condition, clean, and properly stowed or securely mounted, and if tool box is in good condition and securely mounted and locked. Also examine tools which have cutting edges to see that they are sharp. Any tools mounted on outside of vehicle

5-TON, 6 x 6 TRUCK (WHITE, CORBITT, AND BROCKWAY)

REFERENCE		
1951 Ed.	1952 Ed.	
132	132	which have bright or polished surfaces, should be painted or otherwise treated to prevent rust, glare, or reflection.
133	133	Fire Extinguisher. See if it is in good condition, securely mounted, and fully charged. The charge may be determined on gas-type extinguishers by weighing with a scale, and on liquid-type by shaking. Also be sure nozzles are free from corrosion.
134	134	Decontaminator. See if it is in good condition, securely mounted, and fully charged. Make the latter check by removing filler plug. NOTE: This solution must be replaced every three months, as it deteriorates.
134	134	First Aid Kit (if specified). See if it is in good condition, and that all of its items are present and properly packed. Report any deficiencies immediately.
135	135	Publications and Form No. 26. The vehicle and equipment manuals, Lubrication Guide, Standard Form No. 26 (Accident Report Form), and W.D., A.G.O. Form No. 478, should be present, legible, and properly stowed.
136	136	Traction Devices (Chains). Examine tire chains to be sure they are in good condition, clean (if not in use), not excessively worn, protected against rust, and properly mounted or stowed.
137	137	Tow (Chains, Cables, Rope, Snatch Blocks). See if the provided towing devices are in good condition, clean, and properly stowed. Tow chains or cables should be properly protected against rust when not in use. If snatch blocks are furnished, check to see that they operate freely.
139	139	Fuel and Water Cans and Brackets. Observe if they are in good condition and secure; if the caps fit tightly and are secured to the can with a chain; and if cans are leaking.
141	141	Modifications (MWO's Completed). Inspect the vehicle to determine if all Modification Work Orders have been completed and entered on W.D., A.G.O. Form No. 478. Enter any replacement of major unit assembly made at time of this service.
142	142	Final Road Test. Make a final road test, rechecking items 2 to 15 inclusive, and also be sure to recheck the transmission, transfer case, and all driving axles to see that the lubricant is at the correct level and not leaking. Confine this road test to the minimum distance necessary to make satisfactory observations. NOTE: Correct or report all deficiencies found during final road test.

Section XI

VEHICLE MODIFICATION RECORDS

MWO and Major Unit Assembly Replacement Record

Paragraph
30**30. MWO AND MAJOR UNIT ASSEMBLY REPLACEMENT RECORD.**

a. **Description.** Every vehicle is supplied with a copy of A.G.O. Form No. 478 which provides a means of keeping a record of each MWO completed or major unit assembly replaced. This form includes spaces for the vehicle name and U.S.A. Registration No., instructions for use, and information pertinent to the work accomplished. It is very important that the form be used as directed, and that it remain with the vehicle until the vehicle is removed from service.

b. **Instructions for Use.** Personnel performing modifications or major unit assembly replacements must record clearly on the form a description of the work completed, and must initial the form in the columns provided. When each modification is completed, record the date, hours and/or mileage, and MWO number. When major unit assemblies, such as engines, transmissions or transfer cases, are replaced, record the date, hours and/or mileage and nomenclature of the unit assembly. Minor repairs and minor parts and accessory replacements need not be recorded.

c. **Early Modifications.** Upon receipt by a third or fourth echelon repair facility of a vehicle for modification or repair, maintenance personnel will record the MWO numbers of modifications applied prior to the date of A.O.O. Form No. 478.

6-TON, 6 x 6 TRUCK (WHITE, CORBITT, AND BROCKWAY)

Section XII

ORGANIZATIONAL TOOLS

	Paragraph
Tools	31

31. TOOLS.

a. Special Tools.

EYE, engine lifting, $1\frac{1}{4}$ in.	41-E-629
PULLER, clutch pilot bearing	41-P-2906-15
PULLER, upper bogie arm pin	41-P-2956-8
REMOVER, lower bogie arm pin	41-R-2372-555
REMOVER, pin torque rod, upper and lower	41-R-2372-562

b. Organizational Standard Tool Sets. The organization standard tool sets are listed in SNL N-19. The availability of these sets to an organization can be found in the applicable table of equipment.

Section XIII

TROUBLE SHOOTING

	Paragraph
General	32
Engine	33
Fuel system	34
Cooling system	35
Ignition system	36
Starting and generating systems	37
Clutch	38
Transmission	39
Transfer case and power take-off	40
Front axle	41
Rear axle	42
Brake systems	43
Wheels	44
Springs	45
Steering	46
Windshield wipers	47
Lighting and switches	48

32. GENERAL.

a. This section contains trouble shooting information, and tests which can be made to determine causes of trouble that may develop in vehicles under average climatic conditions (above 32°F). Each trouble symptom given under the unit or system involved is followed by a list of possible causes of the trouble. The tests to determine the exact trouble are explained after each possible cause.

33. ENGINE.**a. Engine Will Not Turn.**

(1) **PISTON LOCK OR SEIZURE.** Remove the spark plugs from the engine, put vehicle transmission into high gear and pull vehicle. This should revolve the crankshaft and relieve the seizure. If the engine turns, stop towing, install spark plugs, and attempt starting with the cranking motor. If the engine does not turn over, it indicates internal damage. Report to higher authority.

(2) **CRANKING MOTOR INOPERATIVE.** See paragraph 37.

(3) **INCORRECT CRANKCASE OIL VISCOSITY.** Drain crankcase and refill with proper grade of oil.

b. Engine Turns but Will Not Start.

(1) **LACK OF FUEL.** Fill tanks with proper grade of fuel.

(2) **IMPROPER GRADE OF FUEL.** Fill tanks with proper grade of fuel.

6-TON, 6 x 6 TRUCK (WHITE, CORBITT, AND BROCKWAY)

(3) **INOPERATIVE IGNITION SYSTEM.** Remove a cable from a spark plug. Turn ignition switch on and crank the engine with the cranking motor, while holding the spark plug cable terminal $\frac{3}{4}$ inch from the cylinder head. If a spark does not jump this gap to the cylinder head, the ignition is faulty. See paragraph 36.

(4) **INOPERATIVE FUEL SYSTEM.** Unscrew coupling nut at carburetor intake fuel line fitting and crank engine with cranking motor, ignition switch off. If a weak flow or no flow is apparent, it indicates that no fuel is reaching the carburetor due to a defective fuel pump or clogged lines. See paragraph 34.

(5) **CRANKING SPEED TOO SLOW.** See paragraph 37.

c. Engine Does Not Develop Full Power.

(1) **FAULTY IGNITION.** See paragraph 36.

(2) **IMPROPER GRADE OF FUEL.** Check, drain, and fill tanks with proper grade.

(3) **PREIGNITION.** If the proper grade of fuel and proper spark plugs are being used, check ignition timing (par. 83). If this does not locate the trouble, it indicates faulty internal operation in the engine. Report to higher authority.

(4) **FAULTY OPERATION OF FUEL SYSTEM.** See paragraph 34.

(5) **LOW ENGINE COMPRESSION.** Test engine cylinder compression (par. 50). If found to be below recommended limits, report to higher authority.

(6) **IMPROPER VALVE TIMING.** With satisfactory performance of fuel and ignition systems, proper compression, and sufficient oil in lubricating system; improper valve timing is indicated. Report to higher authority.

d. Engine Misfires.

(1) **FAULTY IGNITION SYSTEM.** See paragraph 36.

(2) **LOW ENGINE COMPRESSION.** See subparagraph c (5) above.

(3) **IMPROPER CARBURETOR ADJUSTMENT.** Adjust carburetor (par. 34).

(4) **CLOGGED FUEL TANK CAP VENTS OR FUEL LINES.** See paragraph 34.

(5) **FOREIGN SUBSTANCE IN FUEL.** Remove filter bowls of fuel pump and carburetor and examine for water, oil, dirt, etc.

e. Engine "Knocks" or "Pings".

(1) **IMPROPER DISTRIBUTOR SETTING.** A sharp knock, heard upon quick acceleration, indicates improper setting of the distributor for the fuel being used. Check distributor spark setting (par. 81). If the distributor is properly set, the knock indicates excess carbon in the combustion chamber.

(2) **WORN OR FAULTY INTERNAL PARTS.** A sharp, hollow, slapping sound, when pulling on level ground, or when starting a cold engine, indicates a worn piston or piston pin. Refer to higher authority. A dull, regular knock in time with crankshaft speed indicates a loose

TROUBLE SHOOTING

or burned connecting rod or main bearings. Report to higher authority.

f. Engine Overheats.

- (1) LACK OF COOLANT IN SYSTEM. Fill cooling system.
- (2) FROZEN OR CLOGGED COOLING SYSTEM. See paragraph 72.
- (3) IMPROPER CARBURETOR ADJUSTMENT. A too-lean mixture of fuel in the carburetor will cause slow overheating of the engine. Check and adjust the fuel mixture (par. 63).

g. Engine Pops and Spits When Running.

- (1) WEAK OR BROKEN VALVE SPRINGS. Remove valve cover plates, and observe action of valve springs with engine running. Report faulty parts to proper authority.
- (2) EARLY VALVE TIMING. If valve spring operation is satisfactory, and the engine continues to pop and spit, it indicates early valve timing. Report to proper authority.

h. Excessive Oil Consumption.

- (1) IMPROPER OIL VISCOSITY. Check, drain, and refill with proper grade.
- (2) EXTERNAL OIL LEAKS. Inspect for leaks. Replace faulty gaskets.

i. Engine Will Not Stop.

- (1) OVERHEATED COMBUSTION CHAMBERS. When the engine continues to run after ignition switch is turned off, it indicates excessive heat in the combustion chambers, caused by improper fuel adjustment or carbon deposits. Clean carbon (par. 52), and adjust fuel mixture (par. 63).
- (2) FAULTY OPERATION OF IGNITION SWITCH. After engine is stopped, turn ignition switch on and off while observing ammeter and fuel gauges. A defective switch will not deflect these pointers. If this condition exists, replace switch.

34. FUEL SYSTEM.

m. No Fuel Flow at Carburetor.

- (1) LEAKAGE IN SYSTEM. Check entire system from fitting at bottom of fuel tank, along the lines to the fuel filter, fuel pump, and carburetor, for evidence of fuel leaks. Tighten loose fittings and replace defective parts.
- (2) CLOGGED FUEL SYSTEM. Check the entire system for obstructions in the units, starting at the fuel tank end of the system.
- (3) FAULTY FUEL PUMP. Check the effectiveness of the fuel pump by cranking the engine, with ignition switch off, after disconnecting the pump to carburetor fuel line at the front of the fuel pump. If the pump produces good pressure, it indicates faulty carburetor operation.

6-TON, 6 x 6 TRUCK (WHITE, CORBITT, AND BROCKWAY)**b. Faulty Engine Performance with Full Fuel Flow at Carburetor.**

(1) **IMPURITIES IN SYSTEM.** Impurities, such as water and oil, can be detected in the sediment bowls of the fuel pump and fuel filter. Remove these units, being careful not to empty them in so doing. By slowly pouring out the contents, any impure solutions can be seen at once, as they will not mix with the fuel. Condensation of air, caused by rapid temperature changes, often produces a considerable amount of water in the fuel tanks. If the check shows water deposits in the sediment bowls, clean them, then drain the tanks of a gallon of fuel each. This should remove the water from the system.

(2) **CLOGGED AIR CLEANER SYSTEM.** Check air cleaner screens for clogged condition. Wash screens in dry-cleaning solvent and replace filter oil.

(3) **FAULTY CARBURETOR ACTION.** With engine running, adjust carburetor mixture at spring screw at top of carburetor. If this fails to improve engine performance, report to higher authority.

(4) **FAULTY CARBURETOR CONTROLS.** Check the setting and operation of the choke butterfly valve in the carburetor intake. Make sure that its normal position (wide open) is maintained. If its operation is faulty, report to proper authority.

35. COOLING SYSTEM.**a. Engine Cooling System Overheats.**

(1) **LACK OF COOLANT.** Refill system.

(2) **FAULTY THERMOSTAT OPERATION.** Test thermostat, and replace if faulty (par. 76).

(3) **FAULTY WATER PUMP OPERATION.** Test flow, replace pump if faulty (par. 75).

(4) **CLOGGED SYSTEM.** Flush and clean system (par. 73).

(5) **HOSE LEAKING.** Tighten clamps or replace faulty hose.

(6) **FROZEN RADIATOR OR LINES.** When the engine overheats very quickly, it indicates a complete clogging of the cooling system, either from ice, slush, or some foreign obstruction. If evidence of freezing is found, cover the radiator with a heavy cloth or tarpaulin and run the engine slowly, shutting it off each time the engine temperature gage passes 200°. Repeat this operation until coolant thaws. If the obstruction is not snow or ice, reverse flush the cooling system (par. 72).

(7) **LOOSE OR OPEN DRAIN COCKS AND PLUGS.** Inspect and tighten.

(8) **DAMAGED RADIATOR CORE.** Seal or replace radiator.

36. IGNITION SYSTEM.**a. No Spark at Spark Plugs.**

(1) **FAULTY CABLES OR TERMINALS.** Inspect all cables and terminals for cleanliness and condition. Replace defective parts.

(2) **FAULTY IGNITION COIL.** Pull the coil distributor cable from the terminal at the center of the distributor head, and hold it about

TROUBLE SHOOTING

$\frac{3}{8}$ inch from any convenient metal ground. Make and break the primary circuit by operating the starting motor with the ignition switch on. A weak spark or no spark indicates a faulty coil. Replace coil. If a hot spark is obtained, install the cable in the distributor terminal and proceed.

(3) **FAULTY DISTRIBUTOR OPERATION.** Check inside and outside of distributor cover for cracks and moisture. Turn on ignition switch, crank the engine, and with the distributor head removed, check for excessive arcing at the breaker points. This will indicate a defective distributor condenser. Replace condenser (par. 80). Pull coil distributor cable from terminal at center of distributor. Remove cover and hold the cable terminal $\frac{3}{8}$ inch from the rotor. Create secondary voltage by making and breaking primary circuit (par. 36 a (2) above). If a spark occurs it indicates a grounded rotor. Replace rotor.

b. Full Spark at Plugs, with Faulty Engine Performance.

(1) **IGNITION OUT OF TIME.** Time ignition (par. 83).

37. STARTING AND GENERATING SYSTEMS.

a. No Action from Cranking Motor When Switch Is Closed.

(1) **FAULTY STARTER SWITCH.** Test lights and horn for battery power. Push starter button and observe ammeter on instrument panel. No deflection of this gage (with ignition switch on) indicates a faulty starter switch. Replace faulty unit.

(2) **FAULTY OPERATION OF SOLENOID.** If no sound or action is obtained at cranking motor when switch is depressed, it indicates an open circuit to the cranking motor. Check for broken cables or loose terminals. If these are found satisfactory, and the ammeter deflects when the starter button is pushed, it indicates a faulty operation of the solenoid switch. Replace solenoid switch (par. 85).

(3) **CRANKING MOTOR INOPERATIVE.** A clicking sound when the starter button is depressed indicates operation of the solenoid. If this is obtained it indicates a grounded or inoperative cranking motor. Replace cranking motor (par. 85).

b. Cranking Motor Hums When Starting Switch Is Closed.

(1) **CRANKING MOTOR DRIVE DEFECTIVE.** Clean cranking motor drive. If still inoperative, replace cranking motor (par. 85).

(2) **CRANKING MOTOR MOUNTING BOLTS LOOSE, CAUSING MISALIGNMENT.** Tighten mounting bolts.

c. Cranking Motor Not Strong Enough to Start Engine.

(1) **BATTERY WEAK OR COMPLETELY DISCHARGED.** Replace or recharge battery.

(2) **LOOSE OR CORRODED CONNECTIONS.** Tighten and clean connections. Coat with grease.

(3) **CRANKING MOTOR COMMUTATOR BURNED OR DIRTY.** Inspect and clean, or replace (par. 85).

6-TON, 6 x 6 TRUCK (WHITE, CORBITT, AND BROCKWAY)

(4) **CRANKING MOTOR ARMATURES BURNED.** Replace cranking motor (par. 85).

d. Cranking Motor Turns Over Engine, but Will Not Start.

(1) **WEAK BATTERY.** Replace or recharge battery (par. 142).

(2) **BATTERY TERMINALS CORRODED OR LOOSE CONNECTIONS.** Tighten and clean connections. Coat with grease.

e. Running Engine Misses.

(1) **BATTERY TERMINALS CORRODED OR LOOSE CONNECTIONS.** Tighten and clean connections. Coat battery posts with grease.

f. Battery Not Receiving Charge from Generator.

(1) **CIRCUIT BREAKER FAULTY.** If the ammeter on the instrument panel shows a heavy discharge when the generator is not running, and all switches are off except the battery master switch, disconnect the battery lead marked "B" in the regulator terminal box. If the condition is corrected, the regulator circuit breaker contact points are stuck. If the ammeter on the instrument panel does not show charge until generator is running at high speed, the regulator circuit breaker is adjusted to operate at too high a voltage. In either of these cases, replace the regulator (par. 88).

(2) **REGULATOR INOPERATIVE.** Start the engine and observe ammeter on the instrument panel. If no charging rate is indicated, connect the battery and armature terminals marked "B" and "A" together in the regulator terminal box using a short piece of insulated wire. Hold jumper wire across the two terminals and watch the ammeter. If reading is obtained, the regulator is not connecting the generator to the battery. If this test does not reveal the trouble, connect the battery and field terminals together with the jumper wire. If a reading is obtained, the regulator is not allowing current to reach the generator field coils, preventing charge. If excessive charge is experienced, and the batteries and circuits test properly, the trouble is caused by improper regulator adjustment. In either case, the regulator is inoperative and must be replaced (par. 88).

(3) **GENERATOR INOPERATIVE.** If regulator tests have been made and no charge is obtained, connect a test voltmeter between armature terminal marked "A" in regulator terminal box, and ground. This test will show if generator is charging. If no voltage reading is shown, leave the voltmeter connected and connect the battery and field terminals marked "S" and "F" together with the jumper wire. A flash will be seen, and the test voltmeter will show a reading when the jumper wire is connected if the circuit is complete. Check the ammeter on the instrument panel. If a charge is shown, the trouble has been corrected by flashing the fields which has increased the magnetism or properly polarized the field coil shoes. If no reading is obtained on the voltmeter, inspect the terminals at the generator for loose or broken connections. If no trouble is observed in the connections or leads, the generator is inoperative and must be replaced (par. 87).

TROUBLE SHOOTING

g. Ammeter Does Not Show Charge.

(1) GENERATOR CIRCUIT BREAKER OPEN. Reset generator circuit breaker.

(2) AMMETER INOPERATIVE. If the ammeter fails to register a charge, turn on all lights and see if a discharge is shown. If no discharge is observed, connect a new ammeter temporarily to the leads in the instrument panel. If a reading is obtained, the ammeter is faulty. If no reading is obtained, test wiring from ammeter to shunt for open circuit.

(3) REGULATOR INOPERATIVE. See subpar. f (2) above.

(4) GENERATOR INOPERATIVE. See subpar. f (3) above.

(5) LOOSE OR CORRODED CONNECTIONS. Clean and tighten connections.

(6) GENERATOR GROUND STRAP LOOSE OR BROKEN. Inspect ground strap. Tighten or replace.

h. Ammeter Shows Excessive Charge.

(1) CURRENT REGULATOR IMPROPERLY ADJUSTED. See subpar. f (2) above.

(2) BATTERIES RUN DOWN. Test batteries (par. 142). Recharge or replace.

(3) BATTERIES SHORTED INTERNALLY. Test batteries and replace if faulty (par. 142).

i. Ammeter Shows Discharge with Engine Running.

(1) GENERATOR NOT OPERATING. See subpar. f (3) above.

(2) REGULATOR CIRCUIT BREAKER CUT-IN VOLTAGE TOO HIGH. See subpar. f (2) above.

(3) GENERATOR DRIVE BELTS LOOSE OR BROKEN. Tighten or replace belts (par. 74).

j. Ammeter Shows Heavy Discharge with Engine Stopped.

(1) SHORTED CIRCUITS. Check system for current leaks.

(2) REGULATOR CIRCUIT BREAKER POINTS STUCK. See subpar. f (1) above.

(3) AMMETER HAND STICKING OR AMMETER BURNED OUT. Tap ammeter with heel of hand, and if not corrected, replace instrument cluster (par. 154).

k. Ammeter Hand Fluctuates Rapidly.

(1) GENERATOR DRIVE BELTS LOOSE. Tighten or replace belts (par. 87).

(2) GENERATOR GROUND STRAP LOOSE OR BROKEN. Tighten or replace ground strap.

(3) REGULATOR CIRCUIT BREAKER CUT-IN VOLTAGE TOO LOW OR CONTACTS BURNED. See subpar. f (2) above.

(4) REGULATOR LOOSE, NOT PROPERLY GROUNDED, OR VIBRATING AGAINST OTHER EQUIPMENT. Tighten regulator or mountings, inspect ground straps, and relieve interference.

6-TON, 4 x 6 TRUCK (WHITE, CORBITT, AND BROCKWAY)

(5) **GENERATOR OR REGULATOR FAULTY.** If ammeter needle fluctuates rapidly, while generator is running, test all regulator and generator mountings to see if they are tight, and inspect for broken ground straps. If ground straps and mountings are satisfactory, the condition is caused by incorrect setting of regulator circuit breaker, worn generator brushes, faulty generator drive belts, or regulator bumping against other equipment. If inspection reveals that the generator drive belts are properly adjusted (par. 87), and there is no interference with the regulator, connect a jumper wire between battery terminal marked "B" and armature terminal marked "A" in the regulator terminal box. If the fluctuation stops with the jumper wire connected, indicating that the regulator circuit breaker points have been vibrating, replace the regulator (par. 88). If fluctuation continues, indicating that the generator is at fault, replace the generator (par. 87).

38. CLUTCH.**a. Slipping.**

(1) **IMPROPER ADJUSTMENT.** Adjust clutch (par. 90).

(2) **OILY PRESSURE FACINGS.** Clean and correct cause. Inspect rear crankshaft oil seal. Inspect overlubrication of pilot bearing. Replace pressure plate assembly if proper condition cannot be restored (pars 91 and 92).

(3) **WEAK CLUTCH SPRINGS.** Report to higher authority.

(4) **WORN CLUTCH FACINGS.** Report to higher authority.

(5) **STICKING CLUTCH SLEEVE.** Inspect pull-back springs.

b. Rattling.

(1) **LOOSE RELEASE YOKE.** Report to higher authority.

(2) **WEAK OR BROKEN PULL-BACK SPRINGS.** Report to higher authority.

(3) **IMPROPER PEDAL ADJUSTMENT.** Adjust pedal (par. 90).

c. Chattering.

(1) **BROKEN PULL-BACK SPRINGS.** Report to higher authority.

(2) **OILY OR BURNED FACINGS.** Clean driven member assembly, or report to higher authority.

(3) **STICKING CLUTCH SLEEVE.** Report to higher authority.

39. TRANSMISSION.**a. Stiffness in Gearshifting.**

(1) **INSUFFICIENT LUBRICATION.** Fill to level plug with proper lubricant (par. 23).

(2) **IMPROPER LUBRICANT.** Fill with proper grade (par. 23).

b. Impossible to Shift Gears.

(1) **SHIFTING YOKES BROKEN OR BENT.** Report to higher authority, or replace complete assembly (pars. 94 and 95).

TROUBLE SHOOTING

(2) **BROKEN GEAR TEETH.** Report to higher authority or replace complete assembly (pars. 94 and 95).

(3) **HOUSING AND ASSEMBLY OUT OF ALIGNMENT.** Inspect and relocate or replace complete assembly if the unit is damaged (pars. 94 and 95).

e. Excessive Noise in Operation.

(1) **ASSEMBLY OUT OF ALIGNMENT.** Relocate and tighten holding bolts (par. 95).

(2) **FAULTY GEARS, BEARINGS, OR WORN SHAFT SPLINES.** Report to higher authority or replace transmission (pars. 94 and 95).

(3) **IMPROPER LUBRICANT.** Drain and refill with proper grade.

(4) **INSUFFICIENT LUBRICANT.** Fill to level plug with proper lubricant.

il. Excess Heat in Operation.

(1) **LACK OF LUBRICANT.** Fill to level plug with proper lubricant.

(2) **IMPROPER LUBRICANT.** Drain and refill with proper lubricant.

(3) **ASSEMBLY OUT OF ALIGNMENT.** Relocate and tighten (par. 95).

40. TRANSFER CASE AND POWER TAKE-OFF.

a. Excessive Noise in Operation.

(1) **INSUFFICIENT LUBRICANT.** Fill to level plug with proper lubricant.

(2) **IMPROPER LUBRICANT.** Drain and fill with proper lubricant.

(3) **DEFECTIVE GEARS OR BEARINGS.** Report to higher authority or replace complete assembly (pars. 102 and 103).

(4) **INSTALLATION OUT OF LINE.** Relocate unit and tighten supports (par. 103).

b. Overheating.

(1) **INSUFFICIENT LUBRICANT.** Fill to level plug with proper lubricant.

(2) **IMPROPER LUBRICANT.** Drain and fill with proper grade.

c. Loss of Lubricant.

(1) **IMPROPER GRADE LUBRICANT.** Drain and fill with proper grade.

(2) **DEFECTIVE GASKETS OR SEALS.** Report to higher authority.

(3) **CRACKED OR BROKEN HOUSING.** Report to higher authority.

41. FRONT AXLE.

a. Hard Steering.

(1) **FRONT AXLE SHIFTED.** Relocate and tighten spring clip nuts (par. 107).

(2) **BENT FRAME.** Report to higher authority.

6-TON, 6 x 6 TRUCK (WHITE, CORBITT, AND BROCKWAY)

- (3) **EXCESSIVE CASTER.** Report to higher authority.
 - (4) **TIRES UNDERINFLATED.** Inspect and inflate to proper pressure (70 lb).
 - (5) **TIGHTNESS IN TIE ROD OR DRAG LINK JOINTS.** Inspect and correct joints for wear, adjustment, and lubrication.
 - (6) **TIGHTNESS IN STEERING GEAR ASSEMBLY.** Inspect and correct adjustment of steering gear, alignment of steering column, and lubrication of steering gear (par. 132).
 - (7) **IMPROPER TOE-IN.** Adjust the tie rod yoke (par. 105).
- b. Low Speed Shimmy.**
- (1) **TOO MUCH OR TOO LITTLE CASTER.** Report to higher authority.
 - (2) **LOOSE FRONT WHEEL BEARINGS.** Adjust, replace if adjustment does not correct (par. 105).
 - (3) **LOOSE OR WORN STEERING MECHANISM.** Inspect and adjust, or replace ball joints, bracket, steering gear to frame, Pitman arm, spring shackles and spring U-bolts.
 - (4) **ECCENTRIC WHEELS.** Replace wheel or tire.
 - (5) **TIE ROD LOOSE.** Tighten or replace worn parts.
- c. High Speed Shimmy.**
- (1) **FRONT WHEELS Wobble.** Report to higher authority or replace.
 - (2) **RUPTURED OR WEAR TIRE CARCASS.** Replace tire.
 - (3) **DRAGGING FRONT WHEEL BRAKES.** Adjust brakes.
- d. Wandering.**
- (1) **BENT AXLE PARTS.** Report to higher authority.
 - (2) **LOOSE FRONT WHEEL BEARINGS.** Adjust bearings (par. 105).
 - (3) **FRONT BRAKE DRUMS OUT-OF-ROUND.** Report to higher authority.
 - (4) **TIRES UNDERINFLATED.** Correct inflation.
 - (5) **ZERO OR REVERSE CASTER.** Report to higher authority.
 - (6) **EXCESSIVE ERROR IN TOE-IN.** Correct toe-in (par. 105).
 - (7) **AXLES SHIFTED.** Relocate axles (par. 107).
 - (8) **TIGHT STEERING ASSEMBLY OR GEAR.** Adjust defective part.
 - (9) **LOOSE WHEELS.** Inspect and tighten wheel nuts.

42. REAR AXLE.**a. Axle Noises.**

- (1) **CONTINUOUS HUM.** Adjust sprocket wheel bearings. Fill axle centers to level plug with proper lubricants.
- (2) **COASTING HUM.** Inspect sprocket wheel bearings. If source of trouble is not located, report to higher authority.
- (3) **PULLING HUM.** Report to higher authority.

TROUBLE SHOOTING

h. Backlash.

- (1) **LOOSE AXLE SHAFT FLANGE.** Tighten axle flange nuts.
- (2) **EXCESSIVE CLEARANCE AT AXLE SHAFT SPLINES.** Report to higher authority.

c. Grease Leakage.

- (1) **GREASE APPPEARING ON BRAKES.** Inspect seals and replace if faulty.

d. Dull Thud in Time with Speed of Truck.

- (1) **BROKEN GEAR TOOTH IN AXLE.** Report to higher authority.

43. BRAKE SYSTEMS.

a. No Resistance to Pressure on Foot Pedal.

- (1) **LINING WEAR.** Adjust brakes for lining wear (par. 121).
- (2) **INCORRECT BRAKE SHOE ADJUSTMENT.** Adjust brake shoes (par. 121).
- (3) **LEAKAGE IN SYSTEM.** Inspect the diaphragms and brake air lines for evidence of leaks. If caused by loose fittings, tighten the fitting. If caused by faulty or broken parts, replace the faulty unit.

b. No Brake Action with Hard Pedal Pressure.

- (1) **IMPROPERLY ADJUSTED BRAKE SHOES.** Adjust brake shoes (par. 121).
- (2) **FAULTY OPERATION OF SLACK ADJUSTER.** Replace unit or report to higher authority.
- (3) **WORN BRAKE LININGS.** Replace brake shoes (par. 120).

c. All Brakes Drag (with Pedal Released).

- (1) **INSUFFICIENT BRAKE SHOE CLEARANCE.** Inspect and adjust clearance if insufficient (par. 121).
- (2) **WEAK OR BROKEN PEDAL RETURN SPRING.** Replace faulty spring.

d. One Brake Drags.

- (1) **WEAK OR BROKEN BRAKE SHOE RETURN SPRING.** Replace faulty unit (par. 120).
- (2) **BRAKE SHOE BINDING ON ANCHOR PIN.** Remove shoe, clean, and lubricate anchor pin.
- (3) **INSUFFICIENT BRAKE SHOE CLEARANCE.** Inspect and adjust clearance if insufficient.

e. Brakes "Grab" When Pedal Is Depressed.

- (1) **BRAKE SHOE CLEARANCE TOO GREAT.** Adjust clearance (par. 121).
- (2) **GREASE OR OIL ON LININGS.** Clean linings.

f. Noisy Brakes.

- (1) **BENT OR BROKEN BACKING PLATE.** Replace backing plate.
- (2) **DAMAGED BRAKE SHOES.** Replace shoes (par. 120).

6-TON, 8 x 6 TRUCK (WHITE, CORBITT, AND BROCKWAY)

(3) **BRAKE DRUMS OUT-OF-ROUND.** Replace drums or report to higher authority.

(4) **DIRT IN LININGS.** Clean brake linings.

g. Propeller Shaft Brake Does Not Hold When Applied.

(1) **LININGS WORN OUT.** Replace shoe and lining assemblies.

(2) **LININGS AND BRAKE SHOES IMPROPERLY ADJUSTED.** Adjust brake (par. 121).

44. WHEELS.

a. Hard Steering.

(1) **TIRES UNDERINFLATED.** Inflate to proper pressure (70 lb).

(2) **DEFECTIVE WHEEL BEARING.** Replace defective units (par. 105).

(3) **UNEQUAL CAMBER.** Report to higher authority.

(4) **BENT OR DAMAGED WHEEL.** Report to proper authority, or replace wheel (par. 126).

(5) **LOOSE WHEEL.** Tighten wheel nuts.

b. Noisy Operation.

(1) **LOOSE WHEEL NUTS.** Tighten nuts.

(2) **DAMAGED WHEEL.** Replace wheel (par. 126).

c. Air Leakage.

(1) **VALVE CAP MISSING OR BROKEN.** Replace with new cap.

(2) **DEFECTIVE VALVE CORE.** Replace with new core.

(3) **PUNCTURE OR TORN TUBE.** Repair if possible, or replace.

45. SPRINGS.

a. Hard Riding.

(1) **DRY SPRING SHACKLES OR BOLTS.** Lubricate units (figs. 16 through 21).

(2) **BROKEN SHACKLE PINS.** Replace defective parts (par. 129).

b. Excessive Spring Action.

(1) **BROKEN LEAVES.** Replace spring (par. 129).

(2) **BROKEN SPRING CLIPS.** Replace clip.

c. Hard Steering.

(1) **SPRING SHIFTED.** Relocate spring and tighten clips (par. 129).

(2) **BROKEN LEAVES.** Replace spring (par. 129).

d. Noisy Operation.

(1) **DRY SHACKLES OR BOLTS.** Lubricate units (figs. 16 through 21).

(2) **BROKEN BRACKETS OR SHACKLES.** Replace defective unit (par. 129).

TROUBLE SHOOTING

46. STEERING.

a. Hard Steering.

- (1) TIRES UNDERINFLATED. Inspect and inflate to proper pressure (70 lb).
- (2) EXCESSIVE FRICTION IN TIE ROD OR DRAG LINK JOINTS. Inspect and adjust or lubricate as required (par. 105)
- (3) EXCESSIVE FRICTION IN STEERING GEAR ASSEMBLY. Inspect lubrication, and if not corrected, report to higher authority.

b. Low Speed Shimmy.

- (1) TIRES UNDERINFLATED. Inspect and inflate to proper pressure (70 lb).
- (2) TOO MUCH OR TOO LITTLE CASTER. Report to higher authority.
- (3) LOOSE FRONT WHEEL BEARINGS. Adjust bearings (par. 105).
- (4) LOOSE OR WORN STEERING MECHANISM. Inspect and adjust or replace ball joints, steering gear mounting (housing to frame), Pitman arm, spring shackles and U-bolts.
- (5) ECCENTRIC WHEELS. Replace wheel or tire.
- (6) FRONT SPRING HANGERS LOOSE ON FRAME. Tighten hangers.
- (7) UNEQUAL FRONT WHEEL CAMBER. Report to higher authority.
- (8) WEAK OR SAGGED FRONT SPRINGS. Inspect for broken leaves and replace. Check for overlubrication and wash off excess oil.
- (9) DRAG LINK OUT OF LINE. Inspect and correct alignment.
- (10) FRONT BRAKE DRUMS OUT-OF-ROUND (SHIMMY ONLY WHEN BRAKES ARE APPLIED). Report to higher authority.

c. High Speed Shimmy.

- (1) TIRES UNDERINFLATED. Inspect and inflate to proper pressure (70 lb).
- (2) TOO MUCH OR TOO LITTLE CASTER. Report to higher authority.
- (3) LOOSE FRONT WHEEL BEARINGS. Adjust bearings (par. 105).
- (4) LOOSE OR WORN STEERING MECHANISM. Inspect and adjust or replace ball joints, steering gear mounting (housing to frame), Pitman arm, spring shackles and U-bolts.
- (5) ECCENTRIC WHEELS. Replace wheel or tire.
- (6) FRONT SPRING HANGERS LOOSE ON FRAME. Tighten hangers.
- (7) UNEQUAL FRONT WHEEL CAMBER. Report to higher authority.
- (8) WEAK OR SAGGED FRONT SPRINGS. Inspect for broken leaves and replace. Check for overlubrication and wash off excess oil.
- (9) DRAG LINK OUT OF LINE. Inspect and correct alignment.
- (10) FRONT BRAKE DRUMS OUT-OF-ROUND (SHIMMY ONLY WHEN BRAKES ARE APPLIED). Report to higher authority.
- (11) DAMAGED WHEEL DISKS. Report to higher authority or replace wheel.

6-TON, 4 x 4 TRUCK (WHITE, CORRETT, AND BROCKWAY)

(12) **FRONT WHEELS OUT OF BALANCE.** Report to higher authority or replace wheel.

(13) **RUPTURED OR WEAK SPOT IN TIRE.** Replace tire (par. 126).

(14) **DRAAGING FRONT WHEEL BRAKES.** Adjust brakes (par. 121).

d. Steering Wander.

(1) **TIRES UNDERINFLATED.** Inflate to proper pressure (70 lb).

(2) **ZERO OR REVERSE CASTER.** Report to higher authority.

(3) **EXCESS ERROR IN TOE-IN.** Correct toe-in (par. 105)

(4) **AXLE SHIFTED IN SPRINGS.** Relocate and tighten (par. 129).

(5) **TIGHT STEERING ASSEMBLY.** Adjust (par. 132).

(6) **LOOSE WHEELS.** Tighten.

47. WINDSHIELD WIPERS.

a. Wiper Moves Too Slowly.

(1) **INSUFFICIENT PRESSURE.** Inspect lines and connections for leaks, and replace if necessary.

(2) **CLOGGED PORTS.** Replace wiper assembly (par. 136).

(3) **LACK OF LUBRICANT.** Replace wiper assembly (par. 136).

b. Wiper Will Not Oscillate.

(1) **ONE SET OF PORTS CLOGGED.** Replace wiper assembly (par. 136).

(2) **LACK OF LUBRICANT.** Replace wiper assembly (par. 136).

c. Wiper Will Not Move.

(1) **LINE SPLIT OR CONNECTION BROKEN.** Inspect and replace damaged part.

(2) **CLOGGED PORTS.** Replace wiper assembly (par. 136).

(3) **WIPER BLADE STUCK.** Free blade and check operation.

d. Wiper Blade Streaking Windshield.

(1) **DIRT ON WINDSHIELD.** Clean windshield.

(2) **WORN OR DAMAGED BLADE.** Replace blade assembly.

48. LIGHTING AND SWITCHES.

a. Engine Will Not Start.

(1) **IGNITION SWITCH OFF.** Close switch.

b. Lights of Vehicle Stay Bright When Starting Switch is Closed.

(1) **OPEN CIRCUIT IN CRANKING MOTOR.** Refer to paragraph 85.

(2) **CRANKING MOTOR SWITCH OPEN.** Inspect switch.

c. Lights of Vehicle Go Very Dim or Out When Starting Switch is Closed.

(1) **DISCHARGED BATTERY.** Replace or recharge battery

(2) **POOR CONNECTION AT BATTERY TERMINALS OR ELSEWHERE IN CIRCUIT.** Tighten connections.

Section XIV

ENGINE—MAINTENANCE AND ADJUSTMENT IN VEHICLE

	Paragraph
Description and tabulated data	49
Tune-up	50
Cylinder head removal	51
Carbon removal	52
Cylinder head installation	53
Manifolds	54
Removal of oil pan	55
Installation of oil pan	56
Crankcase ventilator	57
Valves	58
Oil filter assembly	59

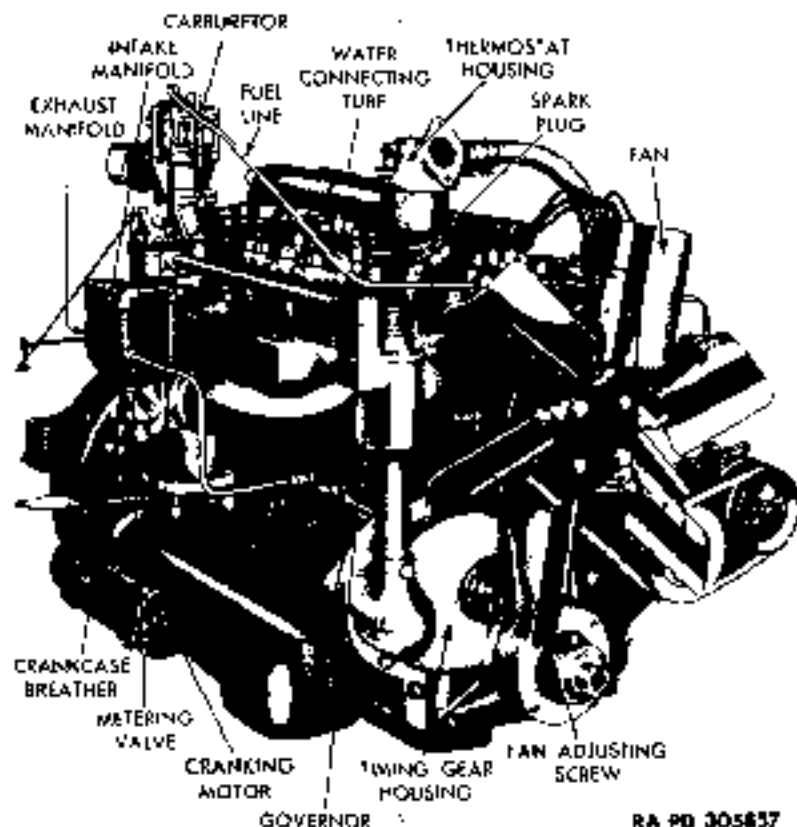


Figure 26—Right Front View of Engine

4-TON, 6 x 6 TRUCK (WHITE, CORBITT, AND BROCKWAY)

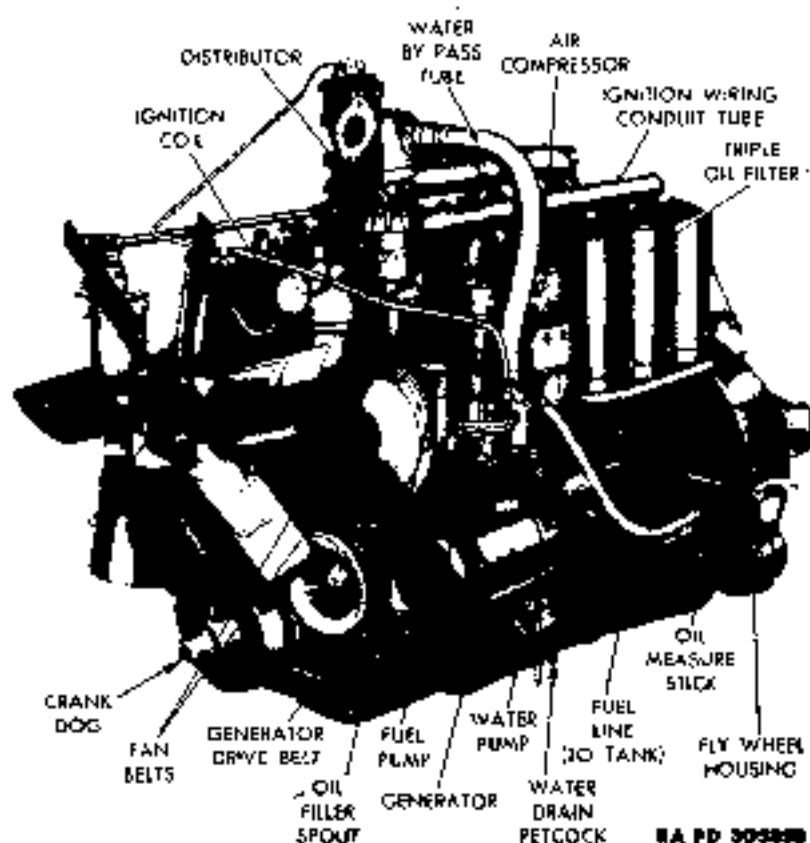


Figure 29—Left Front View of Engine

49. DESCRIPTION AND TABULATED DATA.

a. **Description.** The engine is a 4-cycle, 6-cylinder L-head type. The cylinders are cast three in a block, and these are removable from the crankcase in two individual parts. There are two cast-iron cylinder heads held in place by stud nuts on long through studs, extending from above the cylinder head down through the cylinder blocks, the crankcase, and the main bearing caps. They hold all main engine assemblies in place, and have an eccentric section set into the upper part of the crankcase, keeping them rigidly in place, regardless of disconnections to the block assembly. The engine oil pump is a gear type, and is located at the bottom center of the engine. It is secured to the crankcase, and is driven by a spiral gear from the camshaft.

b. **Tabulated Data.**

Model	Hercules HXD
Cylinders	6

ENGINE—MAINTENANCE AND ADJUSTMENT IN VEHICLE

Bore	5 $\frac{3}{4}$ in.
Stroke	6 in.
Displacement	855 cu. in.
Compression ratio	5.49 to 1
A.M.A. horsepower	72.6
Brake horsepower (developed at rpm)	202 hp at 2150 rpm
Torque (ft.-lb. at rpm)	642 ft.-lb. at 900 rpm
Crankcase capacity (dry)	20 qt
Oil filler location	Left front upper side of engine
Oil drain location	Bottom of crankcase
Water drain location	Bottom of water pump
Cooling system capacity	58 qt

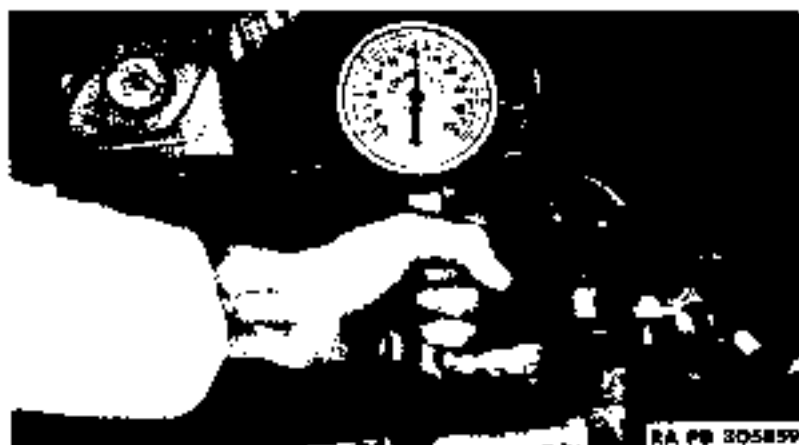


Figure 30—Making Compression Test with Gage 41-Q-124

50. TUNE-UP.

a. **Compression Test.** Insert a compression gage in a spark plug hole, and with the throttle and choke wide open, and the ignition key off, rotate the engine at cranking speed until the maximum compression is indicated. Record this reading. Repeat this process for each cylinder. The specified compression pressure is 102 pounds. Five pounds pressure above or below normal is permissible. If pressure in a cylinder is more than five pounds below normal, squirt sufficient engine oil on the piston head. This will temporarily prevent loss of compression. Low compression brought up to normal by this method indicates piston, ring, or cylinder wear or damage. Low compression not brought up to normal by this method indicates compression leakage past a valve or gasket. Compression above normal may indicate excessive carbon.

6-TON, 6 x 6 TRUCK (WHITE, CORBITT, AND BROCKWAY)

b. **Spark Plugs.** Check for fouled spark plug gap, cracked porcelain, and proper spark gap measurement (par. 81).

c. **Battery, Ignition Cables, and Wiring.** Inspect battery terminals for corrosion or looseness. Inspect battery cables for loose connections and broken or frayed points. Check ignition wiring for loose connections or defective condition. Check ignition coil for dirty condition and loose connections.

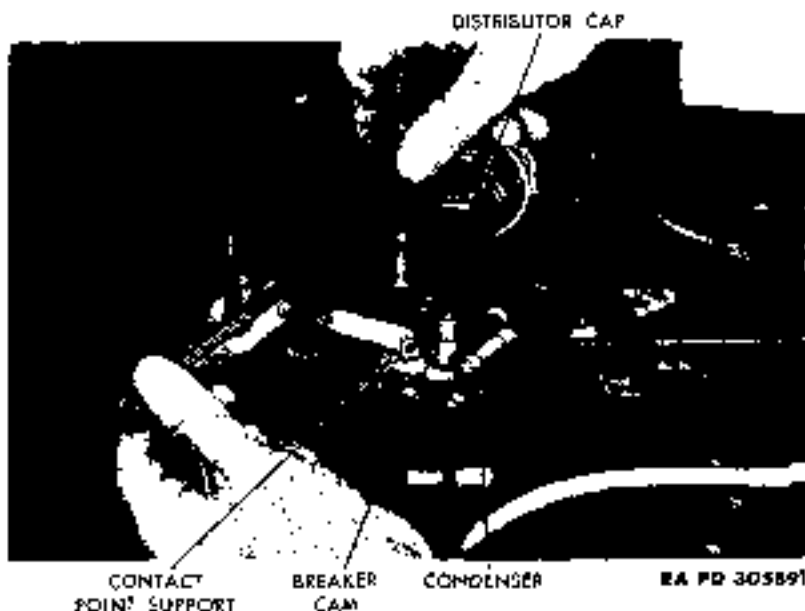


Figure 31—Checking Distributor Point Gap with Gage 47-G-400

d. **Distributor.** Check gap and cam, and operation of centrifugal weights (par. 81). Check condenser condition. Inspect distributor points and cap for evidence of pitting or burning; also check cap for cracks.

e. **Carburetor.** Clean air cleaner (par. 62). Clean fuel filter (par. 65). Check fuel line for leaks. Adjust idling screws (par. 63) to obtain even idle. Check manifold heat control lever for proper position. Inspect carburetor linkage.

f. **Timing.** Check ignition timing (par. 83).

g. **Generator, Regulator, and Wiring.** Check generator output with engine running. Check tightness of regulator terminals and condition of wiring. Check units for cleanliness.

51. CYLINDER HEAD REMOVAL.

a. **Disconnect Cooling System Hose.** Remove radiator filler pressure cap, open petcock in water line at bottom of water pump

ENGINE—MAINTENANCE AND ADJUSTMENT IN VEHICLE

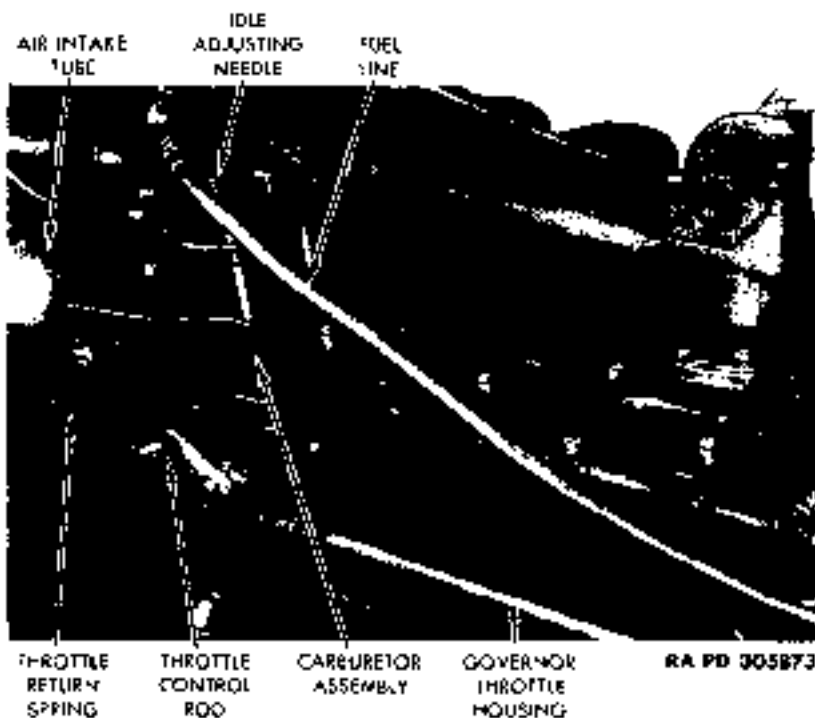


Figure 32—Carburetor Installed

and drain coolant into a container. Unscrew upper radiator hose clamp and pull hose from outlet pipe. Unscrew the hose clamp at the top end of the bypass tube (running down the left side of the engine to the water pump).

b. **Remove Fuel Pump to Carburetor Fuel Line.** Unscrew coupling nut on fuel line at top of carburetor. Unscrew coupling nut on fuel line at upper front of fuel pump. Remove bolt, nut, and locking washers holding fuel line clamp to coil bracket at front of cylinder head, and lift off fuel line.

c. **Disconnect Ignition Wiring and Units from Cylinder Head.** Disconnect all spark plug connections at spark plugs and remove spark plugs and gaskets. Pull wire running from coil to distributor cap from coil end. Disconnect three wires from the two terminals on right-hand end of coil. Unscrew nuts on ignition cable (black loom) at dash terminal. Unsnap two spring clamps holding cap to distributor. Remove four nuts holding wiring conduit tube to cylinder head and lay conduit, distributor cap, and wiring aside. Remove two nuts holding ignition coil bracket to cylinder head, and lift bracket and coil.

6-TON, 6 x 6 TRUCK (WHITE, CORBITT, AND BROCKWAY)



Figure 33—Loosening Cylinder Heads with Pinch Bars

d. **Remove Cylinder Heads.** Remove two cap screws with lock washers from each end flange of water connecting tube. Lift tube and gaskets. Remove heat indicator line from left rear cylinder head. Disconnect air compressor water cooler line from front cylinder head. Remove remaining cylinder head nuts, and lift clip holding radio suppression strap to rear cylinder head and also clip supporting spark retarding cable. Use a pinch bar under lugs on each side of cylinder head to loosen the heads, then lift heads and gaskets from block.



RA 90 305863

Figure 34—Tightening Sequence of Cylinder Head Nuts

52. CARBON REMOVAL.

a. **Clean Carbon From Combustion Chambers, Valves, and Piston Heads.** Use a wire brush and scraper on surface of each cylinder combustion chamber to remove all carbon deposits. Use the same tools to clean valve heads and piston heads.

53. CYLINDER HEAD INSTALLATION.

a. **Install Cylinder Heads and Gaskets.** Place cylinder head gaskets in position over studs, after inspecting to establish their

ENGINE—MAINTENANCE AND ADJUSTMENT IN VEHICLE

proper condition. Place cylinder heads, wiring conduit tube, fuel line and bracket, radio suppression strap, and spark control cable clip in position on cylinder head studs. Run all nuts down fingertight.

b. **Tighten Cylinder Heads.** Tighten all nuts gradually, using a tension wrench and following the tightening sequence shown in figure 35, until both cylinder heads are tightly secured. The proper tension reading for each nut is 105 foot-pounds.

c. **Install Attaching Parts.** Place gaskets and water connecting tube on cylinder heads, and insert and tighten the two cap screws on each end of flange. Insert and tighten heat indicator line to rear cylinder head. Connect water cooler line from air compressor to front cylinder head.

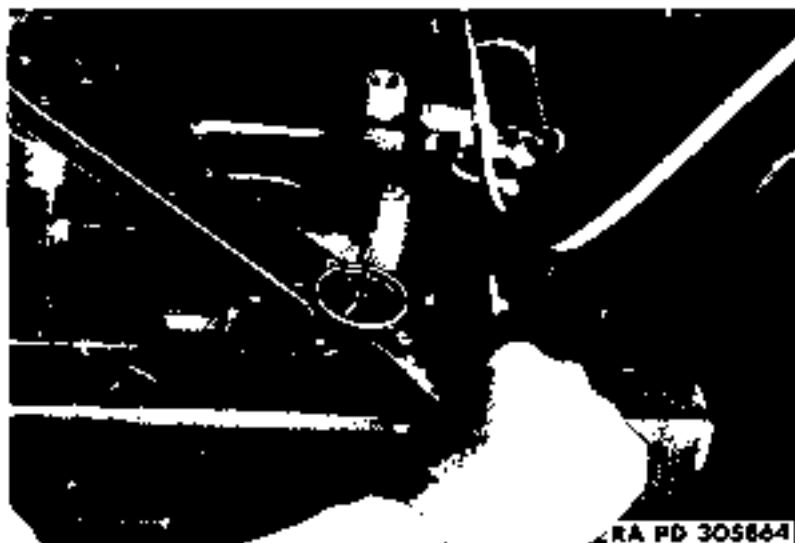


Figure 35—Tightening Cylinder Head Nuts with Wrench 47-W-3630

d. **Tighten Fuel Line Connections.** Connect and tighten fuel line coupling nut at carburetor fitting. Connect and tighten fuel line coupling nut at fuel pump fitting.

e. **Install Spark Plugs and Wiring.** Insert all gaskets and spark plugs, and tighten with spark plug wrench. Return proper ignition wire fittings on spark plugs, coil and dash.

f. **Install Cooling System Hoses.** Slide upper radiator hose on water outlet tube and tighten hose clamp. Push bypass tube into hose at the fitting of the front end of the water connecting tube, and tighten the hose clamp.

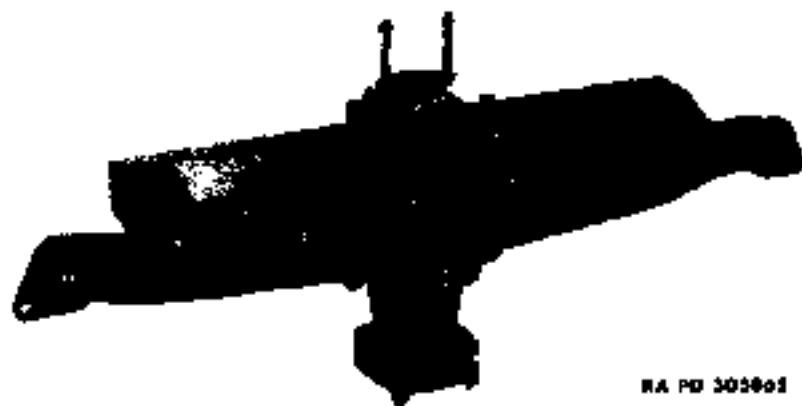
g. **Fill Cooling System.** Shut drain cocks. Fill the cooling system, and check for water leaks.

6-TON, 6 x 6 TRUCK (WHITE, CORBITT, AND BROCKWAY)**54: MANIFOLDS.**

a. **Description.** The intake manifold is a conventional cast-iron single-piece unit, secured to the cylinder block by stud nuts which also support the exhaust manifold. The exhaust manifold is made in three parts, consisting of the central heating box to which the two exhaust pipes are secured.

b. Removal of Intake Manifold.

(1) **REMOVE CARBURATOR.** Unscrew four stud nuts to disconnect air intake tube at rear of carburetor. Unscrew coupling nut and disconnect fuel line at carburetor. Take off nut and disconnect throttle control rod at carburetor. Loosen set screw and pull choke control



RA PD 303601

Figure 35—Manifold Assembly (Engine Side)

cable from carburetor fitting. Remove two nuts from carburetor flange, and lift carburetor from engine.

(2) **Remove Governor.** Remove cap screw at the front of the base of the vertical governor housing. Disconnect oil pressure tube at fitting on governor. Lift assembly straight up and remove from engine.

(3) **Remove Metering Valve.** Unscrew coupling nuts on metering valve and lift from manifold.

(4) **REMOVE MANIFOLD.** Remove five cap screws from center top of manifold. Remove stud nuts holding manifold to cylinder block. Pull manifold from gaskets and block and remove from engine.

c. Installation of Intake Manifold.

(1) **INSTALL MANIFOLD ASSEMBLY.** Determine proper condition of gaskets, then place them in position over studs in cylinder block. Guide manifold into position over studs and against gaskets. Install and tighten stud nuts. Insert and tighten five cap screws at top center of manifold.

ENGINE—MAINTENANCE AND ADJUSTMENT IN VEHICLE



Figure 37—Removing Intake Manifold

(2) **INSTALL METERING VALVE.** Attach metering valve fittings to lines at side of intake manifold and tighten.

(3) **INSTALL GOVERNOR.** Place governor in position on engine. Insert and tighten cap screw at front of lower vertical housing. Connect and tighten coupling nut to fitting on governor housing.

(4) **INSTALL CARBURETOR.** Place carburetor in position over studs on intake manifold. Install and tighten two lock washers and nuts on the studs. Connect throttle control rod at carburetor fitting, and tighten nut. Slide choke control cable into carburetor fitting, and tighten set screw. Install and tighten four lock washers and stud nuts on carburetor air intake flange at rear of carburetor. Install and tighten fuel line coupling nut at fitting on top of carburetor.

d. **Removal of Exhaust Manifold.** Unscrew five cap screws at top center of intake manifold. Unscrew and remove all stud nuts holding manifold against side of block. Disconnect metering valve at valve cover and intake manifold. Unscrew and remove four brass nuts from studs at bottom of manifold, and pull entire assembly off studs.

e. **Installation of Exhaust Manifold.** Guide the manifold into place on the studs and against the cylinder block. Install stud nuts

6-TON, 6 x 4 TRUCK (WHITE, COBBITT, AND BROCKWAY)

and tighten. Insert five cap screws through intake manifold heating box and tighten. Install four brass nuts on exhaust pipe flange at bottom of flange and tighten. Connect metering valve at valve cover and intake manifold and tighten securely.

55. REMOVAL OF OIL PAN.

a. **Drain Oil.** Remove oil dip stick. Unscrew two drain plugs on bottom of pan and drain oil from engine.

b. **Remove Pan.** Remove 20 nuts and lock washers along the sides of the oil pan. Remove four cap screws from front of oil pan and five from rear of oil pan. Pry oil pan loose and remove from engine.

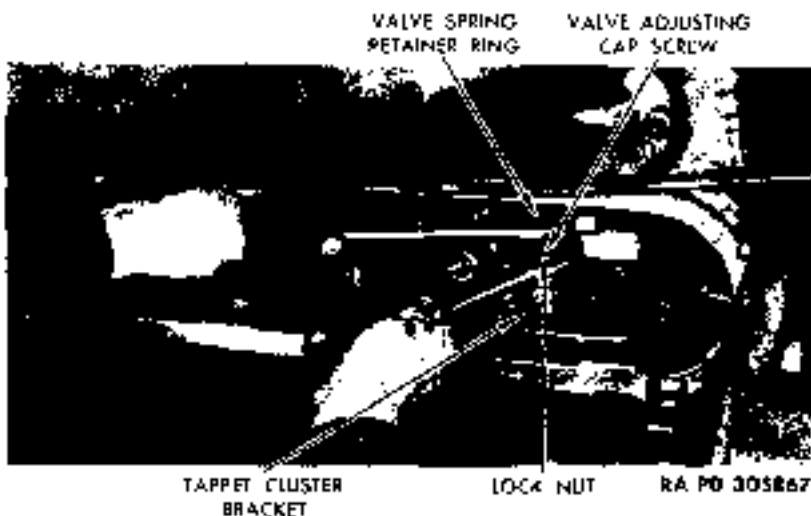


Figure 22—Adjusting Valve Tappet

56. INSTALLATION OF OIL PAN.

a. **Install Gaskets and Pans.** Shellac and install new gaskets on oil pan flange. Place oil pan in position over studs and insert the five rear cap screws, running them down to fingertight position. Insert four cap screws at front of pan. Install and tighten 20 nuts and lock washers along side of oil pan. Tighten all cap screws.

b. **Refill Crankcase.** Insert oil dip stick into opening at lower left rear side of engine, and refill with 20 quarts of seasonal grade engine oil. Test for 4/4 marks on dipstick.

57. CRANKCASE VENTILATOR.

a. **Description.** The ventilator located at the right rear lower side of the engine is an oil-bath type, with a removable cap and screen.

ENGINE—MAINTENANCE AND ADJUSTMENT IN VEHICLE

It filters air entering the crankcase through oil and a wire mesh screen element.

b. **Maintenance.** Remove cap and screen and wash in dry-cleaning solvent. Dry screen, install screen and cap, and secure with snap fasteners.

c. **Removal and Installation.** Unscrew unit to remove from mounting bracket. Screw unit into mounting bracket to install.

58. VALVES.

a. **Description.** The valves are of poppet type with 30°-angle seat. They are operated by the camshaft and mushroom-type tappets,



Figure 39—Adjusting Oil Pressure, Using Screwdriver 41-5-1400

which are equipped with a set screw and lock nut to provide adjustment of valve tappet clearance. This clearance should be adjusted and established with the engine hot. When testing or setting valve clearance, crank the engine to the firing position of the cylinder related to each valve before setting that valve.

b. **Adjustment.** Measure clearance between tappet and valve stem with engine hot. Loosen the lock nut and adjust intake valve to 0.010-inch, and the exhaust valve to 0.016-inch clearance. Hold the adjusting screw stationary with one open-end wrench and tighten the lock nut with another open-end wrench (fig 38). After tightening lock nut, check with feeler gage for proper clearance.

6-TON, 6 x 6 TRUCK (WHITE, CORBIT, AND BROCKWAY)**59. OIL FILTER ASSEMBLY.**

a. **Description.** The engine is equipped with a three stage, replaceable element-type oil filter, which strains all oil through filtering elements after it leaves the oil pump, and before it reaches the bearings.

b. **Maintenance of Oil Filters.** The filter elements should be inspected at regular intervals to detect any sludge formations on the outer surface of the elements. If the elements are coated with sludge, the crankcase should be drained and the filters serviced as follows: Unscrew retaining cap screw, lift off covers, and lift elements from filters. If filters show evidence of being clogged with sludge, replace these units. Before insertion of cleaned or new elements, drain filter housings and wash entirely with dry-cleaning solvent. After insertion of elements install covers, and secure with cap screws.

c. **Removal of Oil Filter Assembly.** Remove three nuts and lock washers holding filter on cylinder block studs. Pull assembly from block, guiding it off studs carefully.

d. **Installation of Filter Assembly.** Place a new shellacked gasket in position over studs, and guide filter assembly into place. Install and tighten three lock washers and nuts.

Section XV

ENGINE—REMOVAL AND INSTALLATION

	Paragraph
Removal of engine assembly	60
Installation of engine assembly	61

60. REMOVAL OF ENGINE ASSEMBLY.

a. **Drain Fuel, Lubricant, and Coolant from System.** Remove pressure cap of radiator, and open petcock on water pipe below water pump to drain coolant. Unscrew and remove two plugs from bottom of oil pan and drain oil into container. Unscrew and remove plug from bottom center of fuel tank, and allow fuel to drain into container.

b. **Remove Cooling System Pipes and Hose.** Loosen screws on clamps on upper and lower radiator hose connections, and remove these hose.

c. **Remove Hood Assembly.** Remove two nuts (under hood) on studs which hold rear hood hinge brackets to cowl, and remove brackets. Remove two nuts (under hood) and bolts which hold center panel of hood to cowl. Lift rear end of hood, slide assembly toward windshield, and lift from vehicle.

d. **Disconnect Wiring.** Disconnect the positive terminals on batteries and tape cable ends. Unscrew nut and remove cranking motor cable from terminal at top center of cranking motor. Unscrew nut and disconnect dash end of ignition coil ground wire (black loom) at filter terminal on dash (left of two terminals below regulator terminals). Unrigger clamp screw and disconnect two clips holding this cable to the underside of the wiring conduit, one clip holding it to the coil bracket, and lift off cable. Unscrew nut and disconnect armature cable (red cover) from the left terminal of the three on the underside of the regulator. Unscrew nut and disconnect generator field cable (black cover) from the center terminal under the regulator. Unscrew nut and disconnect radio shielding conduit terminal at lower left regulator support flange.

e. **Remove Radio Bonding Straps.** Unscrew and remove cylinder head stud nut at rear center of cylinder head and lift bonding strap from stud. Remove cap screw and toothed lock washer holding bonding straps to each side of flywheel housing. Remove cap screw and toothed lock washer at underside of generator and free generator to frame bonding strap.

f. **Remove Ignition Wiring.** Pull all snap connections from spark plug caps. Pull snap connection from ignition coil at front of engine. Unscrew nuts on terminal on right end of coil and remove wires. Pull off snap clamps and lift off the distributor head. Disconnect ignition wire (black loom) at dash terminal. Remove four cylinder head stud nuts, and lift the ignition wiring conduit tube from cylinder heads.

5-TON, 6 X 6 TRUCK (WHITE, CORBITT, AND BROCKWAY)

CHOKER CONTROL WIRE AIR CLEANER CONNECTION AIR HORNS SPARK CONTROL WIRE BONDING STRAP



IGNITION WINDING CONDUIT TUBE WATER LINE FLEXIBLE FUEL LINE AIR LINE TACHOMETER DRIVE CABLE GENERATOR LEAD ENGINE TEMPERATURE THERMAL UNIT VISCOMETER ASSEMBLY

Figure 40—Instrument Controls and Lines on Engine

g. Disconnect Engine End of Instrument Lines. Unscrew coupling nut, and pull tachometer drive cable from distributor drive housing. Unscrew clip supporting tachometer cable to engine block. Hook cable back on cowl. Unscrew coupling nut and pull engine temperature gage (thermal unit) from left rear of cylinder head. Unscrew coupling nut, and separate oil viscosity gage line (small tube) from the rear of two fittings at lower rear left side of crankcase. Unscrew coupling nut and separate oil pressure gage line (large tube) at lower rear left side of crankcase.

h. Remove Air Compressor Lines at Compressor End (fig. 48). Loosen main air pressure line coupling nut (large tube at top of air compressor) and bend tube back over the left fender. Loosen coupling nut on connection at front top of compressor head, also the coupling nut at front of airline junction block (to left of series parallel starter switch on dash). Lift out air compressor to governor airline.

i. Remove Control Cables and Rods. Remove nut and disconnect throttle control rod at linkage from accelerator pedal (near rear

ENGINE-REMOVAL AND INSTALLATION



Figure 41—Carburetor Controls

of oil filter). Loosen set screw and disconnect hand throttle control wire. Loosen set screw, and pull choke control cable wire from fitting at lower left side of carburetor air intake. Unhook carburetor throttle rod return spring (fig. 41). Loosen set screw and pull out spark control cable at fitting on right side of distributor housing.

j. **Disconnect Auxiliary Air Compressor (Bridge Erection Truck Only).** Open petcocks on pontoon reservoir tanks and drain all air. Disconnect the large air supply line at the large elbow on top of the compressor, and swing line aside. Disconnect flexible water tubing at elbows at rear of compressor head. Disconnect compressor to governor pipe (beside rocker arm shaft) and push aside.



Figure 42—Driving Out Auxiliary Compressor Pulley Locking Pin



Figure 43—Removing Auxiliary Compressor Pulley

ENGINE-REMOVAL AND INSTALLATION

k. **Remove Auxiliary Air Compressor (Bridge Erection Truck Only).** Remove four cap screws and lock washers holding compressor to mounting bracket. Push top of compressor several inches toward the governor and pry the drive belt from the compressor pulley. Lift unit vertically and remove to a suitable place.

l. **Remove Radiator (par. 73).**

m. **Remove Auxiliary Compressor Pulley Locking Pin (Bridge Erection Truck Only).** Insert pliers through holes in pulley, and pull cotter pin from each end of pulley locking pin.



Figure 44—Driving Out Rear Engine Support Bolt

n. **Remove Pulley (Bridge Erection Truck Only).** Remove locking wire from crank dog plate, and remove four cap screws and crank dog. Install puller (41-P-2905-60) and pull pulley from crankshaft.

o. **Remove Fuel Pump and Lines.** Unscrew coupling nut at front of fuel filter on left frame side rail. Unscrew fuel pump end of this line at elbow at upper rear of fuel pump, and remove line. Unscrew coupling nuts at upper front of fuel pump and top of carburetor. Remove nut, bolt, and toothed lock washer holding this line to coil bracket at front of engine, and remove line. Remove two cap screws, and lift fuel pump from air compressor drive housing.

6-TON, 4 x 6 TRUCK (WHITE, CORBITT, AND BROCKWAY)

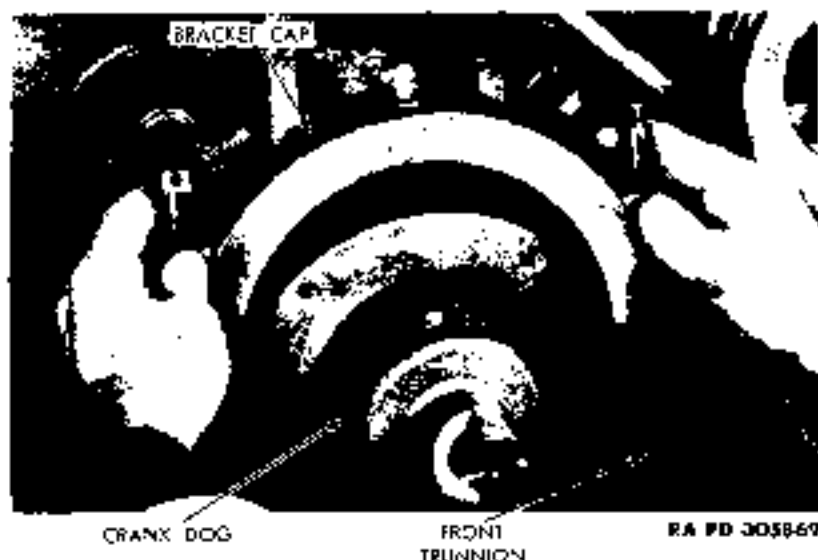


Figure 45—Removing Front Trunnion Bracket Cap

p. **Disconnect Exhaust Pipe.** Remove four brass nuts from studs holding exhaust pipe to the bottom center of the exhaust manifold, and pull pipe over against right frame side rail.

q. **Remove Air Cleaner Assembly.** Remove four stud nuts holding air intake to carburetor. Remove four nuts and lock washer hold-

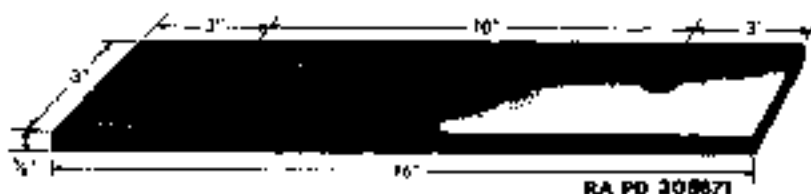


Figure 46—Steel Strap for Holding Engine

ing air cleaner to dash. Remove two nuts and lock washers from inside of cab to release cleaner bowl clamp ring from dash. Lift air cleaner assembly from dash.

r. **Remove Air Horns** (fig 51). Unscrew coupling nut at air line fitting at left side of air horns. Remove three nuts, lock washers, and bolts holding air horns to bracket. Lift horn assembly from brackets.

s. **Disconnect Engine Supports.** Remove two cotter pins and nuts from rear engine supports on each side of engine. Tap support

ENGINE-REMOVAL AND INSTALLATION

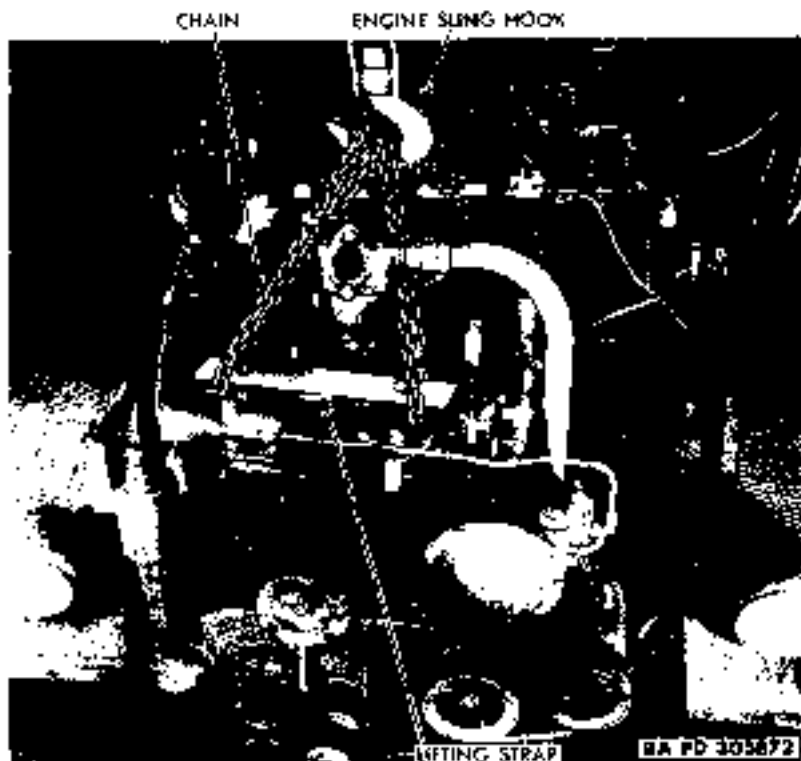


Figure 47—Removing Engine from Chassis

bolts down through brackets with a hammer and brass drift (fig. 44). NOTE: Right-hand support bolts are longer and have springs on them. Remove locking wire and two cap screws which hold engine front trunnion bracket cap, and lift off cap (fig. 45).

1. Attach Engine Hoisting Sling Equipment (fig. 47). Use engine lifting eye (41 E-629), if available, to remove the engine. However, if the eye is not available an improvised tool (figs. 46 and 47) may be used as described below. Unscrew and remove No. 1 and No. 6 spark plugs and priming cups. Unscrew and lift off the second stud nut from the front, on each side of the engine. Unscrew and lift off the second stud nut on each side, from the rear of the engine. Lay steel straps in position over these studs, install and tighten stud nuts over the studs and plates. Install a 15-foot length of $\frac{3}{4}$ -inch chain in a cross sling under the extended part of the plates and over a hoist hook. Lift hoist enough to put slight tension on chain and check all fastenings.

6-TON, 6 x 6 TRUCK (WHITE, CORBITT, AND BROCKWAY)

u. **Disconnect Engine from Transmission.** Lower engine approximately three inches, still supporting it with the hoist and chain. Install a rope or chain sling to support the transmission after engine removal. Remove 12 cap screws holding transmission housing to flywheel housing.

v. **Remove Engine from Chassis.** Lift the engine slowly, at the same time pushing the chassis slowly backwards. This will allow the engine to pull free from the clutch pilot shaft, and to clear front bumper and frame. Roll chassis from under engine and lower engine to suitable truck or stand.

61. INSTALLATION OF ENGINE ASSEMBLY.

a. **Attach Engine Hoisting Sling Equipment** (par. 60 f).

b. **Place Engine Assembly in Position in Chassis.** Lift the engine slowly until high enough to clear front bumper. Push the chassis under the engine. Lower engine and guide it so that the clutch pilot shaft can be inserted in the bore of the flywheel. NOTE: A slight forward or backward movement of the vehicle, while in gear, will rotate this shaft to aid in engaging the splines. When it is apparent that the splines are meshed and the pilot shaft definitely started in the bore, the engine assembly should be pushed back until the flywheel housing is against the bell housing of the transmission.

c. **Secure Lower Transmission Support Bracket.** Install four nuts, lock washers, and bolts to each side rail, holding the support bracket at the front of the engine.

d. **Secure Transmission Housing to Engine.** Lay asbestos pads in place on top of rear engine support brackets. Lower engine until supported by rear brackets and front transmission support. Insert and tighten 12 cap screws holding transmission housing to flywheel housing.

e. **Secure Engine Supports.** Install front transmission bracket cap, insert and tighten with two cap screws and locking wire. Drive right-hand rear engine support bolts (with springs) on underside of bracket up through gaskets and rear engine support, insert and tighten two nuts and cotter pins. These nuts should be pulled down sufficiently to put $\frac{1}{4}$ -inch compression on the springs. Insert left rear engine support bolts in the same manner (these do not have springs), install and tighten two nuts and cotter pins.

f. **Install Air Horns** (fig. 51). Place horns in position on bracket, install and tighten three bolts, lock washers, and nuts. Connect and tighten coupling nut at airline fitting (left side of horns).

g. **Install Air Cleaner Assembly** (fig. 49). Place air cleaner bowl assembly bracket in position on four bolts on dash. Install lock washers and bolts on these and tighten. Insert clump ring bolts through dash and secure with lock washers and nuts on inside of cab. Install and tighten four stud nuts holding air intake to carburetor.

ENGINE—REMOVAL AND INSTALLATION

h. Connect Exhaust Pipe. Place exhaust pipe, flange, and gasket in position under center of manifold assembly. Tighten four nuts on inverted studs.

i. Install Fuel Pump and Lines (fig 52). Place fuel pump in position on air compressor drive housing insert and tighten two cap screws. Place fuel line and clip in position on coil bracket at front of engine and secure with bolt, toothed lock washer, and nut. Connect and tighten coupling nut at fitting on upper front of fuel pump. Connect and tighten coupling nut at fitting on upper part of carburetor. Screw flexible fuel line elbow to rear of fuel pump. Connect and tighten coupling nut on the line at fitting on front of fuel filter on left front side rail.

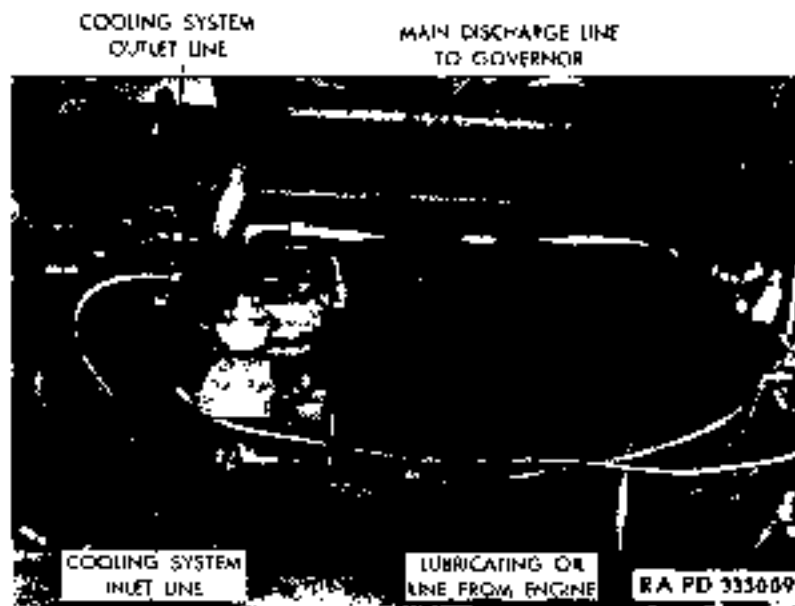


Figure 48—Air Compressor Lines Installed

j. Install Auxiliary Air Compressor Pulley (Bridge Erection Truck Only). Press pulley on crankshaft. Line up holes for locking pin. Insert locking pin and secure with a cotter pin at each end. Place crank dog on face of pulley, insert and tighten four cap screws. Lock these with a single locking wire.

k. Install Auxiliary Air Compressor (Bridge Erection Truck Only). Lower compressor assembly vertically to mounting bracket. Slip belt over crankshaft pulley, and while tilting compressor assembly toward the governor, slip the belt over the compressor pulley.

6-TON, 6 x 6 TRUCK (WHITE, CORBITT, AND BROCKWAY)

Insert and tighten four lock washers and cap screws holding the compressor to the mounting bracket. Connect and tighten compressor to governor line at fitting beside rocker arm shaft. Connect and tighten flexible water tubing fittings at elbows at rear of compressor head. Connect and tighten large air supply line at the large elbow on top of the compressor.

l. Adjust Auxiliary Compressor Belt Tension. Partially loosen cap screws in compressor mounting and pull unit toward outer side of vehicle, until a proper tension is judged. Tighten the cap screws while holding this tension. Lay a straightedge on the top of the belt from pulley to pulley. Press down on the center of the belt with a ruler. Proper tension will give a $\frac{1}{2}$ -inch to $\frac{3}{4}$ -inch deflection with normal finger pressure. See figure 60 for an illustration of this type measurement.

m. Install Radiator and Grille Guard (par. 73).

n. Install Control Cables and Rods (fig. 41). Push spark control wire into fitting on right side of distributor housing, and tighten set screw. Push choke control cable wire into fitting at lower left side of carburetor air intake and tighten set screw. Fasten carburetor throttle hand control wire at set screw on left-hand end of throttle cross shaft. Install and tighten nut on accelerator linkage at left-hand end of throttle cross shaft.

o. Install Air Compressor Lines on Compressor. Place air compressor to governor air line in assembly. Connect and tighten coupling nut on connection at front top of compressor head. Connect and tighten the coupling nut on this line at the front of the air line junction block (to left of series parallel starter switch on dash). Push main air pressure line into position, connect coupling nut to fitting on top of air compressor and tighten.

p. Install Engine End of Instrument Lines (fig. 40). Place oil pressure gage (large tube) line fitting on front of two fittings at lower rear left side of crankcase, and tighten coupling nut. Place oil viscosity gage (small tube) fitting on rear of these two fittings, connect and tighten coupling nut. Insert engine temperature gage thermal unit into fitting on left rear of cylinder head. Connect and tighten coupling on this unit. Insert tachometer drive cable fitting into distributor drive housing, and connect and tighten coupling nut. Fasten cable supporting clip to engine block.

q. Install Ignition Wiring (fig. 65). Remove four cylinder head stud nuts from center section of left side of cylinder head. Lay ignition wiring conduit brackets in position over these studs and install and tighten the stud nuts. Place distributor head in position and secure snap clamps. Install snap connections of ignition cables to tops of spark plugs. Install and fasten wires to right-hand end coil terminals. Connect ignition cable (black loom) to dash terminal.

r. Install Radio Bonding Straps. Remove cylinder head stud nut at rear center of cylinder head, place bonding strap terminal over stud, install, and tighten stud nut. Remove cap screw, place

ENGINE—REMOVAL AND INSTALLATION

flywheel housing bonding straps (one each side), in position, insert and tighten cap screw and toothed lock washer. Install generator bonding strap (under generator) and tighten nut on terminal.

s. **Install Electrical System Wiring.** Install radio shielding conduit terminal on support bolt at lower left regulator support flange and tighten toothed lock washer and nut. Place generator field cable (black cover) on the center terminal on underside of regulator, install and tighten washer and nut. Place generator armature cable (red cover) on the left terminal of the three on the underside of the regulator, and install. Install dash end of ignition coil ground wire (black loom) on filter terminal on dash (left of two terminals below regulator terminals). Attach this cable to two clips on the underside of the wiring conduit and to clip which holds it to the coil bracket, then tighten clip bolts, nuts, and washers. Push cranking motor cable on terminal at top center of cranking motor, and install and tighten lock washer and nut. Remove tape from battery cables. Place cable fittings over battery terminals and tighten clamp nuts.

t. **Install Cooling System Pipes and Hoses.** Push upper and lower radiator hose connections on flanges, and tighten clamp screws.

u. **Install Hood Assembly** (par. 73)

v. **Fill System with Proper Fuel, Lubricant, and Coolant.** Remove oil filler cap and fill lubricating system with five gallons of lubricating oil of proper grade. Close petcock on water pipe below water pump, and fill system with $14\frac{1}{2}$ gallons of coolant. Install and secure drain plug on gasoline tank, and fill with gasoline of proper grade.

w. **Test Engine Operation.** Start engine and allow it to warm up. Check operation of units with connections and instruments on instrument panel. Tune up engine (par. 50). Inspect lines and wiring for leaks or short circuits. Check engine for unusual sounds and operation.

6-TON, 6 x 6 TRUCK (WHITE, CORBITT, AND BROCKWAY)

Section XVI

FUEL SYSTEM

	Paragraph
Air cleaner	62
Carburetor	63
Fuel pump	64
Fuel filter	65
Fuel tank	66
Governor	67

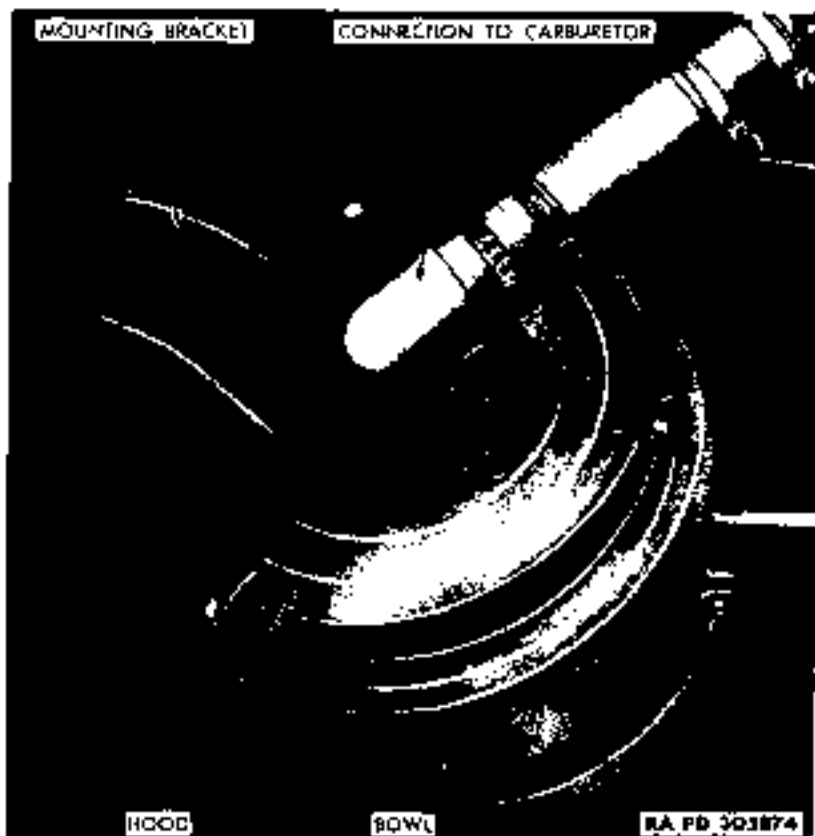


Figure 49—Air Cleaner Installed

FUEL SYSTEM

62. AIR CLEANER.

a. **Description** (fig 49). The air cleaner, mounted on the right upper cowl (under the hood), is an oil-bath and screen type, and is connected to the carburetor with a flexible hose.

b. **Maintenance.** Unscrew three clamp nuts at top of bowl, loosen bowl clamp screws, lower and remove housing and filter assembly. Wash out accumulated grit and dust in sump, and refill with clean crankcase grade oil to lower head of bowl. If screens are dirty, wash

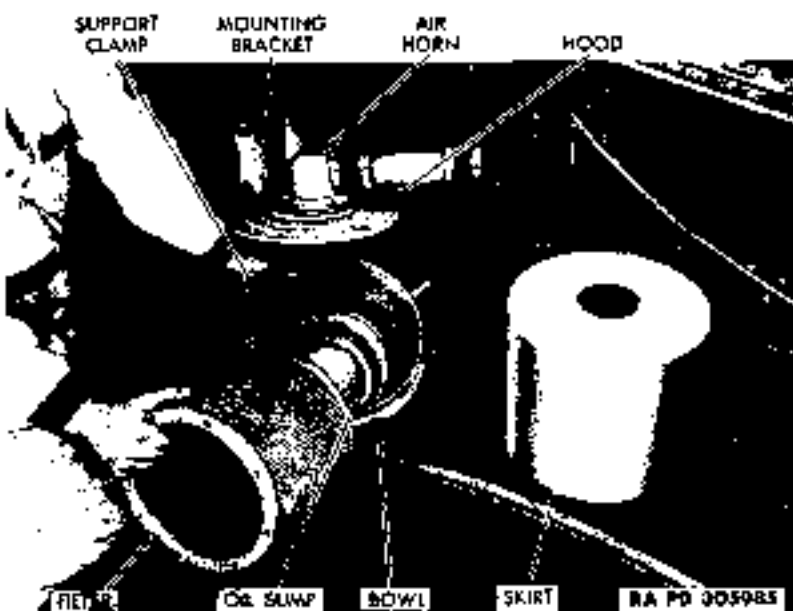


Figure 50—Air Cleaner Disassembled

thoroughly in dry cleaning solvent and allow to dry. Install filter in bowl, place skirt over filter, and secure bowl to hood with three clamp nuts at top of bowl.

c. **Removal.** Unscrew forward air intake tube clamp, and pull hose off carburetor flange. Loosen clamp screw holding clamp around center of assembly. Remove four nuts and lock washers holding air cleaner bracket to bolts on cowl, and lift assembly up and out of chassis.

d. **Installation.** Lower air cleaner into bowl clamp ring and onto bracket bolts on cowl. Install and tighten four lock washers and nuts on cowl. Install air intake hose to carburetor flange and tighten thumbscrew clamp. Tighten bowl clamp screw.

6-TON, 6 x 6 TRUCK (WHITE, CORBITT, AND BROCKWAY)

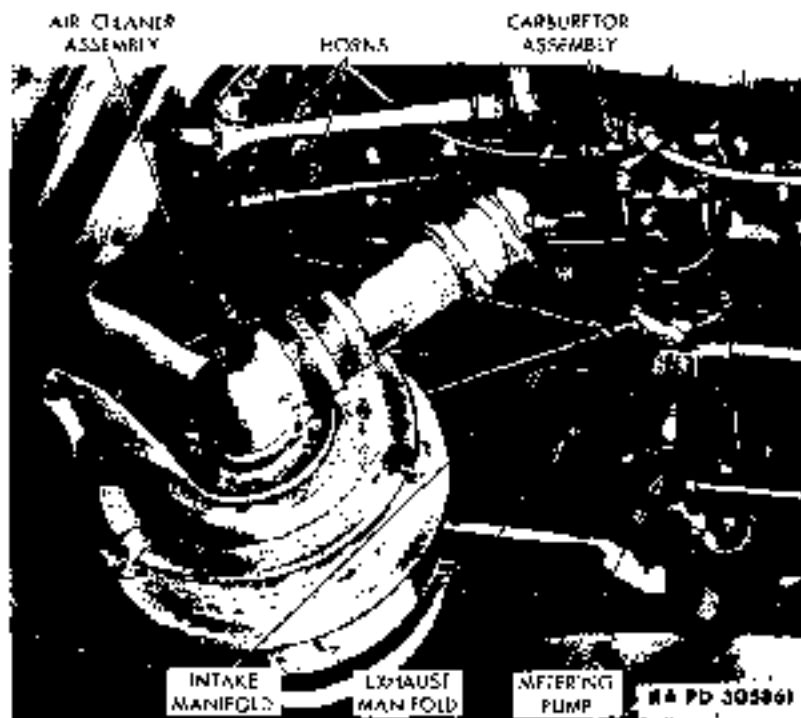


Figure 51—Air Cleaner and Carburetor Assemblies Installed

63. CARBURETOR.

a. **Description.** The unit is a downdraft, "balanced" type, using a secondary venturi (mixing chamber). It is designed with a vacuum control power jet and accelerating system, providing extra fuel required for heavy loads. It is mounted on the right upper side of the engine, and is manually controlled as to acceleration and choke valve operation.

b. **Tabulated Data.**

	Bridge Engine	Prime Mover	Crane
Make	Zenith	Zenith	Zenith
Model	29AW-16	1N-167S-J	29AW-16
Type	Downdraft	Downdraft	Downdraft

c. **Adjustment.** The throttle stop screw (lower right side) should be screwed in against the stop pin to hold the throttle plate slightly open, and providing the desired idling speed of the engine. The idling adjusting screw (top cover, with spring) should be one to one and

FUEL SYSTEM

one-half turns off its seat. Turning this screw down cuts off the air, making the idling fuel mixture richer, while unscrewing it provides a more lean fuel mixture.

d. **Removal.** Unscrew coupling nut on fuel line fitting on top of carburetor. Loosen air intake hose clamp at rear of carburetor, and pull hose from carburetor flange. Remove nut, and disconnect throttle control rod at carburetor. Unscrew set screw, and pull out choke control wire at carburetor. Remove two nuts and lock washers at front and rear of carburetor base, and lift assembly from engine.

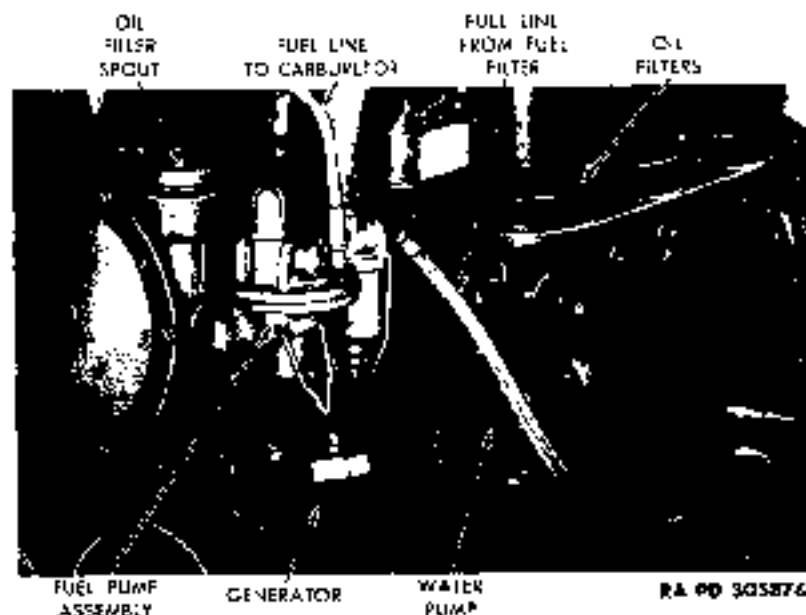


Figure 52—Fuel Pump Installed

e. **Installation.** Place a new gasket on intake manifold studs. Place carburetor assembly in position over studs. Install and tighten two lock washers and nuts at front and rear of carburetor flange. Slide choke control cable into fitting at carburetor, and tighten set screw. Connect throttle control at carburetor, and install and tighten nut. Connect air intake tube to carburetor flange, and tighten thumb clamp screw. Connect fuel line fitting at top of assembly, and tighten coupling nut. Crank engine and adjust idling speed after engine warms up.

64. FUEL PUMP.

a. **Description.** This unit pumps fuel from the tanks to the carburetor through means of a mechanically operated diaphragm and

6-TON, 6 x 6 TRUCK [WHITE, CORBITT, AND BROCKWAY]

valve system. It is mounted on the air compressor drive housing (front lower left side of the engine), and is driven through a connecting rod operating from an eccentric on the air compressor drive shaft. It is provided with a special hand lever (fig. 32) for pumping an initial supply of fuel to an empty carburetor.

b. Tabulated Data.

Make	AC
Model	D-Series
Number	1537710

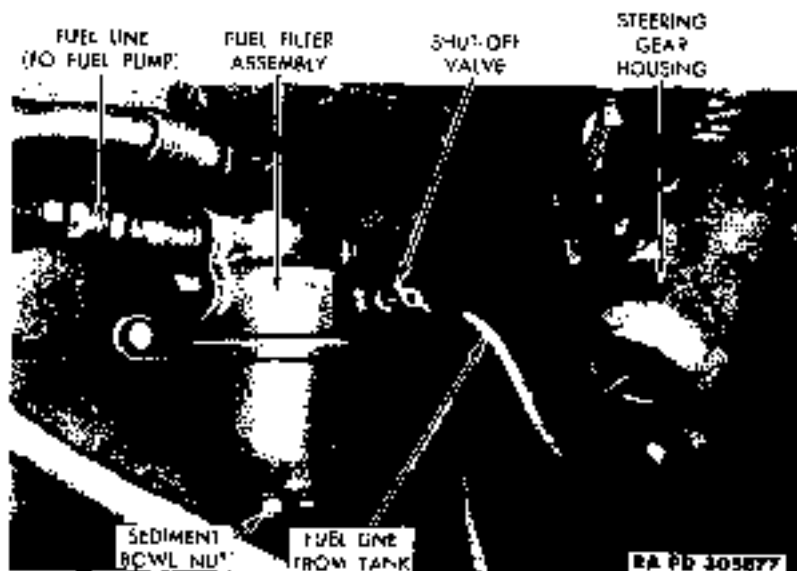


Figure 33—Fuel Filter Assembly Installed

c. Removal. Unscrew coupling nut on fuel line connection at front side of pump. Screw in shut-off valve at rear of fuel filter. Unscrew fitting at front of fuel filter. Remove two nuts and lock washers from studs, and pull pump assembly off studs.

d. Installation. Install pump and gasket over two studs on compressor drive housing. Install and tighten two lock washers and nuts. Screw flexible gas line fitting into fixture at rear of pump. Connect carburetor fuel line at fitting at top front of pump and tighten coupling nut. Operate pump hand-operating lever several times to pull fuel into the pump.

FUEL SYSTEM

65. FUEL FILTER.

a. **Description.** This unit is a metal-cased filter and sediment bowl, mounted on the left frame side rail in front of the steering gear housing. Its purpose is to filter gasoline before it passes into the fuel pump.

b. **Maintenance.** The filter should be inspected and cleaned at regular intervals. Close shut-off cock on tank side of fuel filter. Remove nut from bottom center of bowl, remove disks and swish in dry-cleaning solvent. Dry unit, and place in position in assembly.

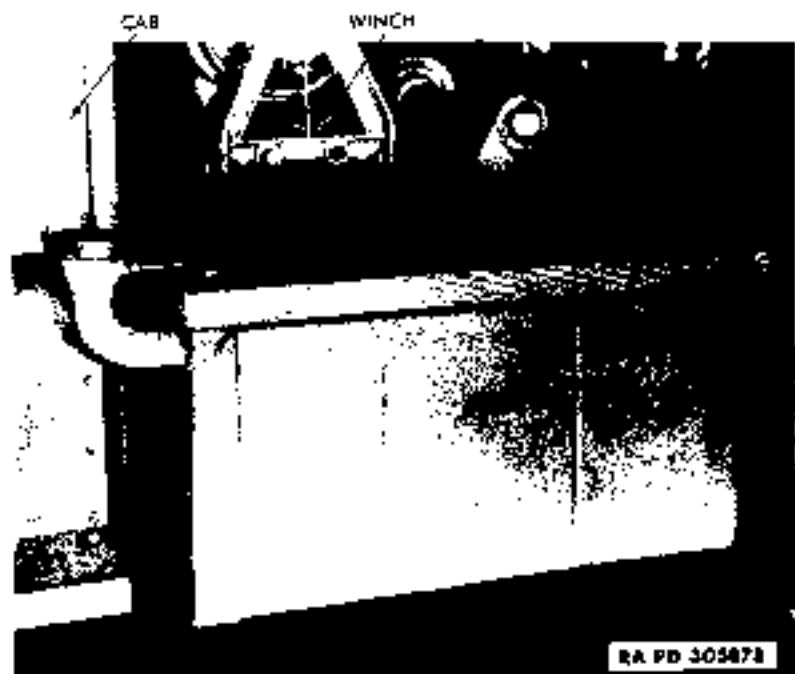


Figure 34—Fuel Tank Assembly Installed

Place bowl in position, and insert and tighten nut on bottom of bowl. Open shut-off cock.

c. **Removal.** Unscrew coupling nut to disconnect intake (at rear) and outlet (at front) fuel line connections, plugging rear line to prevent loss of fuel. Remove two nuts and lock washers (inside frame) and pull filter and bolts from frame.

d. **Installation.** Place filter in position and push two bolts through holes in frame, securing with two lock washers and nuts tightened on inside of frame. Connect intake and outlet lines at fittings at rear and front of filter, and tighten.

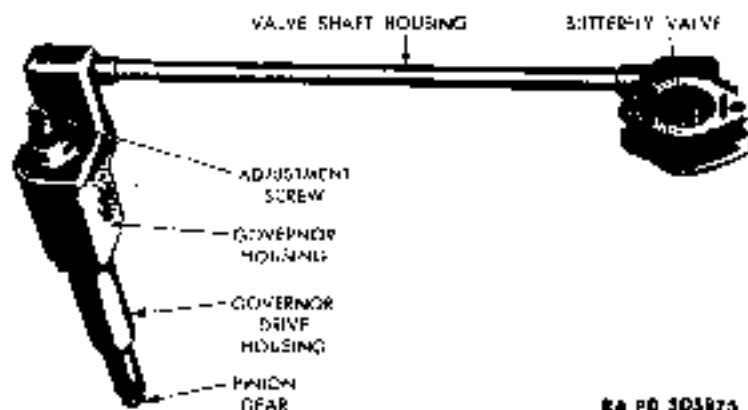
6-TON, 6 x 6 TRUCK (WHITE, CORBITT, AND BROCKWAY)

66. FUEL TANK.

a. **Description.** The fuel tank is mounted on the left-hand side of the frame. It is suspended on straps from brackets mounted to the left side rail. The capacity is 80 gallons.

b. **Maintenance.** These straps should be kept tight at all times to prevent rubbing and wear on the tanks. This adjustment is made by tightening the four nuts found on the step plate and at the upper ends of the straps.

c. **Removal.** Unscrew plug on bottom of tank and drain tank of all fuel. Unscrew coupling nut and disconnect fuel line at tank end. Place a jack tight under tank to prevent dropping. Remove four nuts



SA PD 303875

Figure 53—Governor Assembly

and lock washers from straps. Push straps down, releasing tank. Disconnect fuel gage wiring at terminal on tank. Lower tank to floor and remove from chassis.

d. **Installation.** Use a jack to raise tank into position. Install fuel gage wiring at terminal on tank. Place support straps in place, and tighten and secure four lock washers and nuts on straps. Connect fuel line coupling nut at tank fitting, and tighten. Refill tank with proper fuel.

67. GOVERNOR.

a. **Description.** The unit is operated from a special gear in the timing gear train, and cuts off gasoline vapor (as engine speeds increase) through the closing of a butterfly valve in the intake manifold.

FUEL SYSTEM

b. Tabulated Data.

Make	Pierce
Model	MA 1028 and MA 1475
Type	Mechanical
Setting rpm	2200

c. **Maintenance.** Check at regular intervals for proper setting (2150 rpm on tachometer). If engine speed exceeds this, turn adjusting nut on top of vertical governor housing and retest. Repeat until engine shows top speed of 2200 revolutions per minute.

d. **Removal of Governor.** Remove carburetor (par. 63). Unscrew and remove cap screw and lock washer at bottom front of vertical housing. Disconnect oil pressure tube at fitting on governor. Lift governor assembly vertically and remove from assembly.

e. **Installation of Governor.** Install assembly, lowering vertically, guiding pinion gear into mesh with gear in timing gear train, and guiding butterfly valve housing down over top studs on intake manifold. Insert and tighten lock washer and cap screw at bottom front of vertical housing. Connect and tighten coupling nut on oil pressure tube at fitting on governor. Install carburetor (par. 63).

6-TON, 4 x 6 TRUCK (WHITE, CORBITT, AND BROCKWAY)

Section XVII

EXHAUST SYSTEM

	Paragraph
Description	68
Maintenance	69
Unit replacement	70

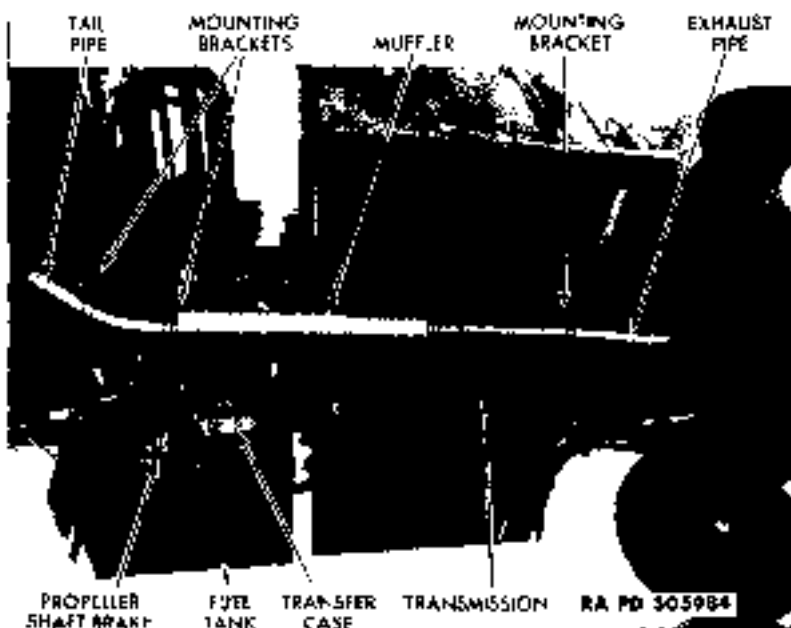


Figure 36—Exhaust System Installed

68. DESCRIPTION.

a. The exhaust system consists of muffler, pipes, brackets, clamps and mountings, and an exhaust pipe to manifold flange. At all points except the manifold, it is mounted to the frame or its cross members with clamp straps or brackets.

69. MAINTENANCE.

a. The exhaust assembly should be inspected, and all parts tightened, at regular intervals. A new gasket should be used each time the exhaust pipe is attached to the manifold.

EXHAUST SYSTEM**70. UNIT REPLACEMENT.****a. Exhaust Pipe Removal and Installation.**

(1) **REMOVAL.** Remove four stud nuts and lock washers at bottom of exhaust manifold. Remove nut, lock washer, and bolt holding pipe clamp to frame cross member at right of transmission. Loosen clamp bolt holding exhaust pipe in muffler sleeve, and pull pipe from sleeve, and assembly from the chassis.

(2) **INSTALLATION.** Slide exhaust pipe manifold flange and clamp bracket into position on replacement pipe. Install pipe bracket to frame, and secure with a bolt, lock washer and nut. Install a new gasket and the manifold flange. Install and tighten four stud nuts. Tighten clamp ring bolt on exhaust pipe at front of muffler.

b. Muffler Assembly Removal and Installation.

(1) **REMOVAL.** Remove nut, lock washer, and bolt which holds tailpipe clamp to bracket on frame. Loosen clamp bolt nut at rear of muffler, and pull tailpipe from muffler. Remove one nut, lock washer, and bolt from each of front and rear frame brackets which support muffler. Loosen front clamp bolt on exhaust pipe connection to muffler, and pull muffler from pipe and assembly.

(2) **INSTALLATION.** Fit muffler front sleeve over exhaust pipe, and tighten clamp bolt nut. Install muffler to front and rear frame brackets. Insert and tighten one bolt, nut, and lock washer in each bracket. Push tailpipe into rear muffler sleeve. Secure tailpipe to frame bracket with one bolt, lock washer, and nut. Tighten muffler rear clamp bolt nut.

6-TON, 6 x 6 TRUCK (WHITE, CORBITT, AND BROCKWAY)

Section XVIII

COOLING SYSTEM

	Paragraph
Description	71
Maintenance	72
Radiator	73
Fan	74
Water pump	75
Thermostat	76

71. DESCRIPTION.

a. The cooling system consists of a radiator, grille, thermostat, heat indicator, water pump, fan, belts, water jackets in the engine block surrounding the cylinders, and connecting pipes and hoses.

72. MAINTENANCE.

a. Give cooling systems a thorough servicing each 6,000 miles of service, also before filling the system with antifreeze solution, and after its removal.

b. Servicing the system consists of dissolving and removing rust, scale, dirt, and sludge in the system. Remove a gallon of water from the system, and replace with a solution of one pound of washing soda or ½ pound of soda ash mixed with a gallon of clear water. Run the engine at a fast idle until the solution penetrates all system parts thoroughly, then drain through the lower drain connection.

c. Flush the system in the opposite direction to normal flow. Flush the radiator under water pressure from the lower hose connection. Pressure-flush the engine block from the upper hose connection.

d. If the cooling system coolant freezes solid, thaw it by placing the vehicle in a warm place. Never run the engine when the coolant is completely frozen. With mush ice, the system may be thawed by removing the radiator cap, covering the radiator, and running the engine slowly. Add coolant as needed. When engine heat indicator shows heat in excess of 200°F, stop engine until temperature is reduced to safe operating range.

73. RADIATOR.

a. **Description.** The radiator is of the conventional tubular type. It is equipped with a fan shroud to increase the efficiency of air passage through the radiator. Two mounting studs are welded to the bottom of the lower tank, and two support brackets to the upper tank. It is equipped with a pressure filler cap which maintains a pressure of two pounds on the coolant after the liquid has reached normal operating temperature. This increase in pressure raises the

COOLING SYSTEM

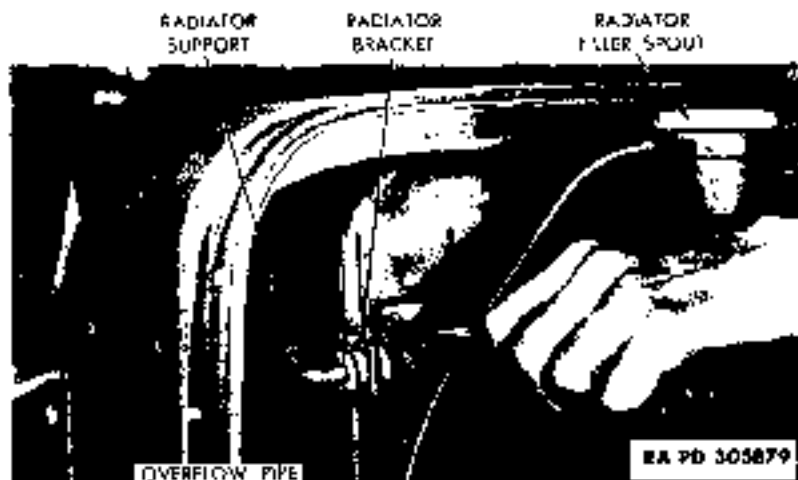


Figure 57—Disconnecting Radiator Upper Support Rods

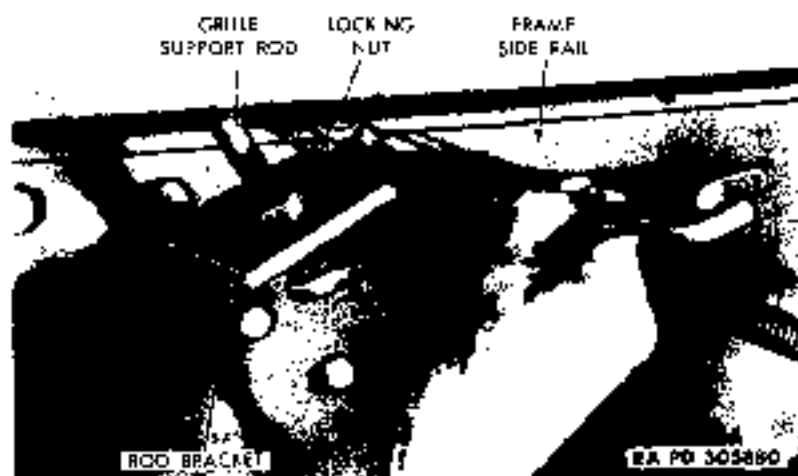


Figure 58—Disconnecting Radiator Lower Support Rods

temperature at which the liquid will boil, resulting in greater cooling efficiency and prevention of evaporation and surge losses.

b. Removal of Radiator Assembly.

(1) REMOVE HOOD. Push down and unlatch front and rear latches on each side of hood. Remove two nuts and lock washers on hood hinge brackets at rear end of hinges. Remove two nuts on center

6-TON, 6 x 6 TRUCK (WHITE, COBBITT, AND BROCKWAY)



Figure 59—Removing Radiator

panel bolts. Lift hood and remove hood hinge brackets and center panel bolts. Pull hood back, and lift from chassis.

(2) **DISCONNECT UPPER SUPPORTS OF BRUSH GUARD AND RADIATOR SHELL.** Remove hood lower splash guards at each side. Remove cotter pin and washer from upper radiator supports (inside shell at each upper corner of radiator), and disconnect by pushing support rod through hole of bracket attached to radiator.

(3) **DISCONNECT RADIATOR TIE RODS AND RADIATOR SHELL AT ENGINE SPLASH GUARDS.** Remove nuts and lock washers from radiator shell tie rods at brackets on each side of the frame (under each fender). Remove nuts, lock washers, and bolts which hold right and left lower sides of radiator shell to fender splash guards.

COOLING SYSTEM

(4) **REMOVE BRUSH GUARD AND RADIATOR SHELL.** Remove 16 nuts, lock washers, and bolts which hold the brush guard to the frame and front fenders. Move radiator shell and grille forward and upward to clear assembly, and lift off.

(5) **DISCONNECT RADIATOR.** Drain the cooling system by opening petcock on left side of engine in lower elbow of water pump. Also remove pipe plug on right forward side of air compressor cylinder head. Unscrew clamp screws and disconnect all radiator to engine hose connections.

(6) **REMOVE RADIATOR.** Remove nuts, flat washers, and springs from two studs from radiator through front frame cross member, and tilt radiator slightly forward. Remove four cap screws holding blade assembly to fan hub, after marking fan and hub for position.

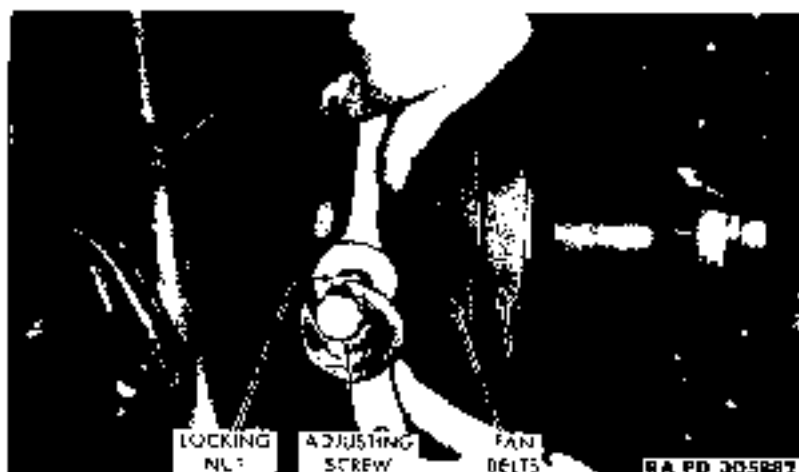


Figure 60—Adjusting Fan Belt Tension

in installation, and remove blade. Lift radiator off chassis using S-hooks through the upper radiator brackets, and a chain or rope sling fastened to a hoist.

c. Installation of Radiator Assembly.

(1) **INSTALL RADIATOR.** Using a hoist and rope sling through S-hooks on the upper radiator brackets, place the radiator in position on the front frame cross member. Install springs, flat washers, and nuts on two bottom studs, and tighten until springs are compressed approximately $\frac{1}{2}$ inch, then secure nuts with cotter pins.

(2) **INSTALL FAN BLADES AND RADIATOR HOSE.** Install the fan blades in proper position on the fan hub, and insert and tighten four cap screws. Install radiator to engine inlet hose and outlet hose, but do not tighten hose clamps.

6-TON, 6 x 6 TRUCK (WHITE, CORBITT, AND BROCKWAY)

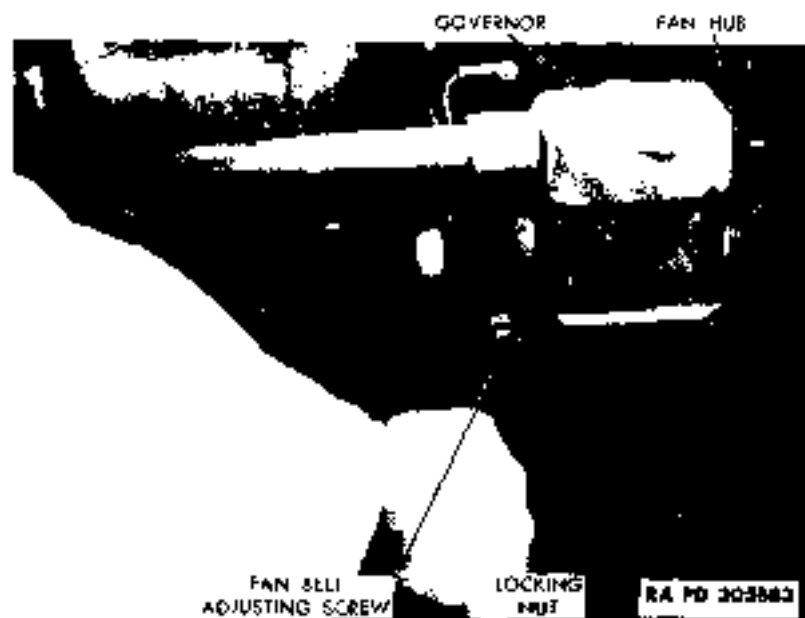


Figure 67—Unscrewing Fan Shaft Hex Nut

(3) **INSTALL RADIATOR SHELL AND BRUSH GUARD.** Place radiator shell and brush guard assembly in position. Push radiator shell tie rods into brackets on frame side rails, and install and tighten lock washers and nuts. Secure brush guard and shell to fenders, frame, and lower splash guards, by inserting and tightening 16 bolts, lock washers, and nuts. Insert upper radiator supports in brackets at each upper corner of radiator, and secure with cotter pins. Tighten all radiator to engine hose connections.

(4) **INSTALL HOOD.** Place hood in position, pushing front of hood hinges into brackets on radiator. Slide rear hinge brackets on hinges and insert bolts through cowls. Install center panel bolts. Install and tighten four lock washers and nuts. Fill radiator with proper coolant.

74. FAN.

a. **Description.** The fan is mounted to a hub on a bracket attached to the crankcase forward of the cylinder block. It is driven by two V-type belts.

b. **Adjustment of Fan Belts.** Loosen large hex nut between fan bracket and front cylinder block. Loosen lock nut on long adjusting screw. Turn adjusting screw to left to loosen, or right to tighten fan belt tension. When a light pressure halfway between the pulleys will

COOLING SYSTEM

deflect the belts $\frac{1}{8}$ inch to $\frac{3}{8}$ inch, they are properly adjusted. Tighten lock nut. Tighten large hub hex nut.

c. **Removal of Fan and Hub Assembly.** Loosen lock nut, unscrew and remove long adjusting screw from shaft of fan hub. Remove large hex nut and washer from rear of fan hub shaft. Move fan and hub assembly forward, at the same time slipping two V-type belts from fan pulley, and lift fan from engine.

d. **Installation of Fan and Hub Assembly.** Place hub and fan assembly in position with V-type belts in place on pulleys and rear of fan hub shaft through adjusting bracket. Install but do not tighten



Figure 62—Tightening Water Pump Packing Nut

washer and large hex nut on this shaft. Install adjusting screw and tighten until fan belts have proper tension. Lock adjusting screw by tightening lock nut. Tighten large hex nut. Check accuracy of belt adjustment.

75. WATER PUMP.

a. **Description.** The impeller-type water pump is mounted on the lower left side of the engine, and is driven from the accessory drive through a chain-type coupling. It has graphite-type packing in each end of the shaft to prevent water leakage.

b. **Maintenance and Adjustment.** The pump is lubricated by means of two grease cups which should be turned down one complete turn each day of use. The packing nuts should be kept fingertight, plus enough pressure with a spanner wrench to allow the snap lock to drop into one of the notches.

6-TON, 6 x 6 TRUCK (WHITE, CORBITT, AND BROCKWAY)

c. **Removal of Water Pump Assembly.** Open petcock on engine inlet line at water pump. Unscrew coupling nut on air compressor water line at water pump end. Remove cotter on removable link of sprocket chain and remove link and chain from sprocket. Remove two cap screws and disconnect engine water inlet pipe at bottom of pump. Remove four cap screws and lock washers, holding pump to engine block, and lift off pump.

d. **Installation of Water Pump Assembly.** Place water pump in position against engine block and secure with four lock washers and cap screws. Install engine water inlet pipe and gasket at bottom of pump and secure with two cap screws. Close petcock on water



Figure 63—Removing Thermostat

inlet line. Install sprocket chain and removable link on sprocket and secure with cotter pin. Install and tighten coupling nut on air compressor water line fitting at water pump.

76. THERMOSTAT.

a. **Description.** The thermostat, located in the water outlet passage, is provided with a small bypass hole to prevent steam pressure. Its construction is such that it can fail only in an "open" position, leaving a free circulation of water through the engine.

b. **Removal and Installation of Thermostat.** Unscrew clamp on hose connection at thermostat housing on water bypass tube. Remove four cap screws in the cap at the front of the water jacket above the cylinder block. Lift the cap, exposing the thermostat, and lift thermostat from housing. Install thermostat (bellows side down) in the housing. Install gasket and cap, and insert and tighten four cap screws.

Section XIX

IGNITION SYSTEM

	Paragraph
Description	77
Operation	78
Ignition coil	79
Condenser	80
Distributor	81
Spark plugs	82
Timing adjustment	83
Radio suppression	84

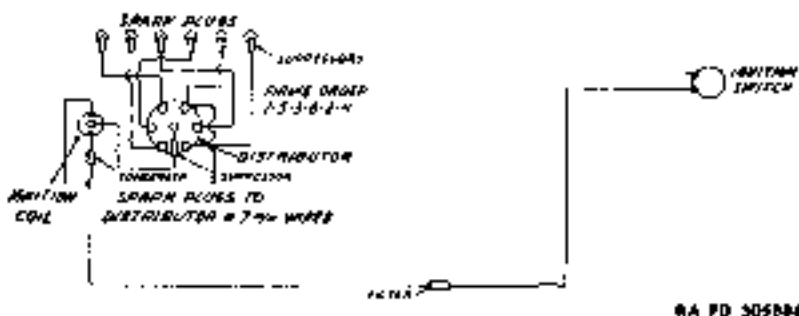


Figure 64—Ignition System Wiring Diagram

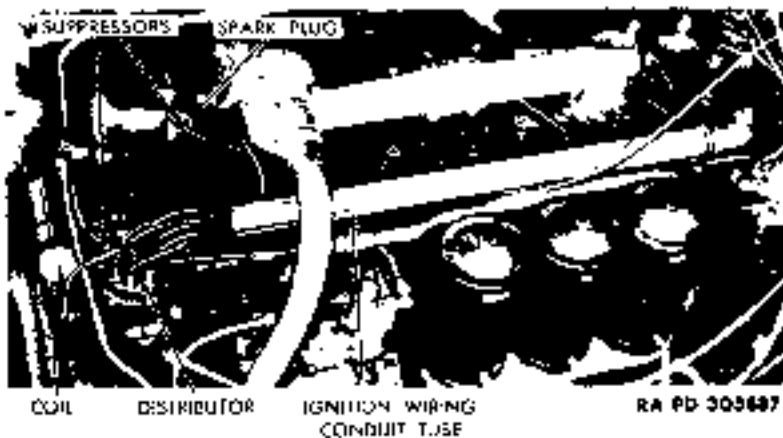


Figure 65—Ignition System Wiring Installed

6-TON, 6 x 6 TRUCK (WHITE, CORBITT, AND BROCKWAY)

77. DESCRIPTION.

a. The system (fig. 64) consists of a source of power (battery or generator), ignition coil, distributor, condenser, low- and high-tension wiring, and spark plugs. There are two distinct circuits in the system. The primary (low-tension) circuit includes the source of energy, the distributor contact points and circuit-breaking mechanism, the primary of the ignition coil, and the condenser. The secondary (high-tension) circuit includes the secondary of the ignition coil, rotor and distributor cap, high-tension wiring and spark plugs.

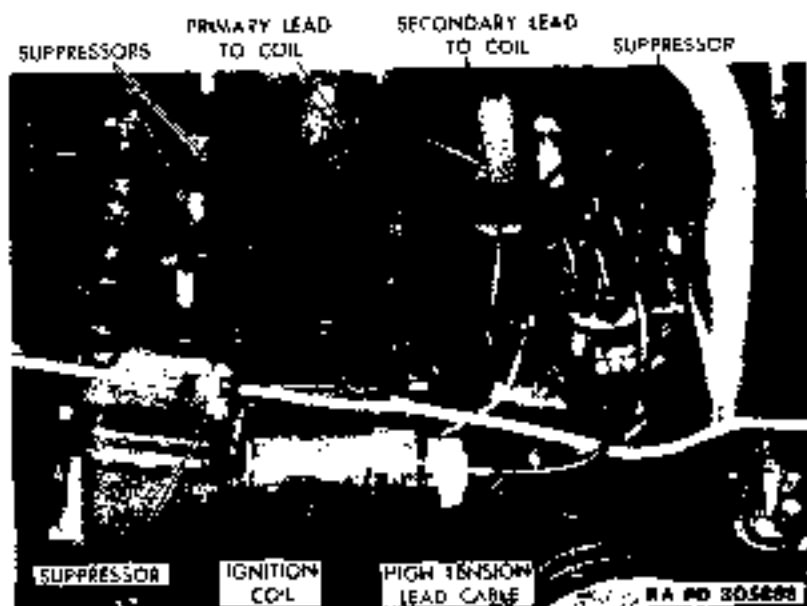


Figure 64—Ignition Coil and Distributor Installed

78. OPERATION.

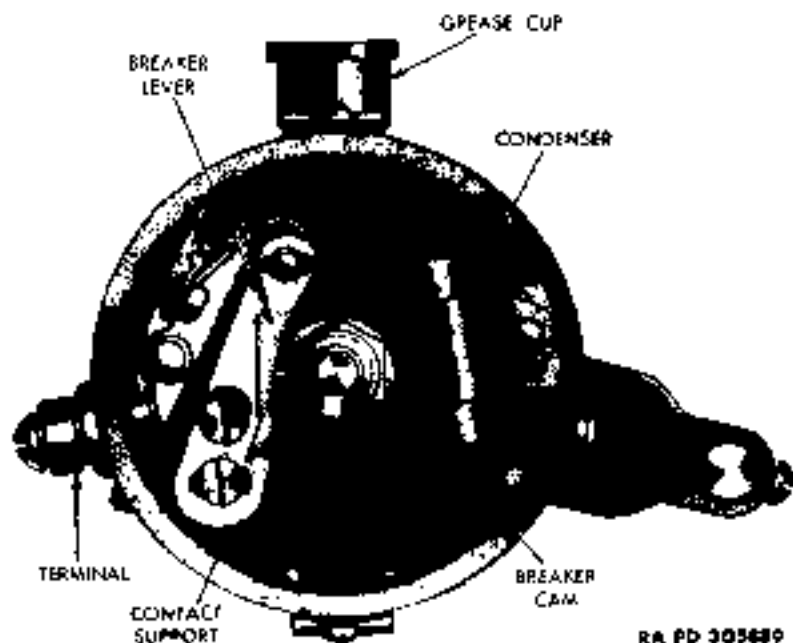
a. The system delivers a high-voltage spark at the spark plug gap in the combustion chamber of each cylinder, in timing with the valve operation and position of piston, to produce properly timed firing of the cylinders. The primary circuit is completed and broken by a circuit breaker mechanism of the distributor, causing a build-up and collapse of a magnetic field in the ignition coil. The condenser is connected across the distributor contact points. When the points open, current has a tendency to continue to flow and arc across the points. The condenser stores up electric energy and reduces this arc to a minimum. Current flowing into the condenser discharges it almost instantly back through the primary of the ignition coil. This

IGNITION SYSTEM

action causes a rapid collapse of the coil magnetic field, inducing a high voltage in the secondary circuit. This high voltage is distributed in correct timing to proper spark plugs, by means of the rotor and distributor cap terminals.

79. IGNITION COIL.

a. **Description.** The ignition coil converts low-voltage primary current, from generator or battery, to a higher voltage which is strong enough to jump the spark plug gaps. The coil is mounted on



RA PD 305689

Figure 67—Top View of Distributor

the front of the engine just behind the fan. The heavy cable on one end of the coil (high-tension wire) leads to the distributor cap. The negative low-tension lead on the other end of the coil is connected to the distributor points. The positive low-tension lead is connected to the filter coil.

b. **Removal.** Disconnect wires at terminals on each end of the coil, loosen binder bolt, and slide coil out of bracket. Ignition switch should be "OFF" during such operation.

c. **Installation.** Slip coil into bracket with flat end to right-hand side. Tighten binder bolt. Snap on high-tension wire. Connect the low-tension wire from the filter coil, and the ground wire from the

6-TON, 6 x 6 TRUCK (WHITE, CORBITT, AND BROCKWAY)

bracket, to the positive terminal, and the wire from the distributor points to the negative terminal. Tighten nuts on terminals.

80. CONDENSER.

a. **Description.** The condenser is mounted in the body of the distributor and is connected across the distributor points (fig 67). This unit protects the breaker contacts, and also serves to intensify the spark across the spark plug gap to insure the firing of the gas mixture in the cylinders.

b. **Removal.** Remove distributor cap, unscrew retainer clip screw and terminal screw. Lift condenser out of distributor body.

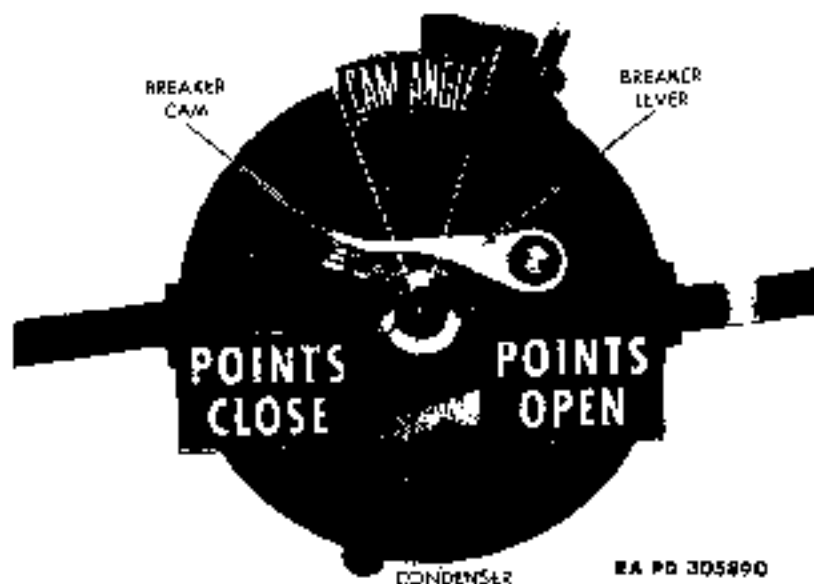


Figure 68—Distributor Cam Angle

c. **Installation.** Place condenser and retainer clip in distributor body, and insert and tighten retainer clip screw. Cable should be formed away from distributor point arm. Slide cable on terminal, and tighten set screw.

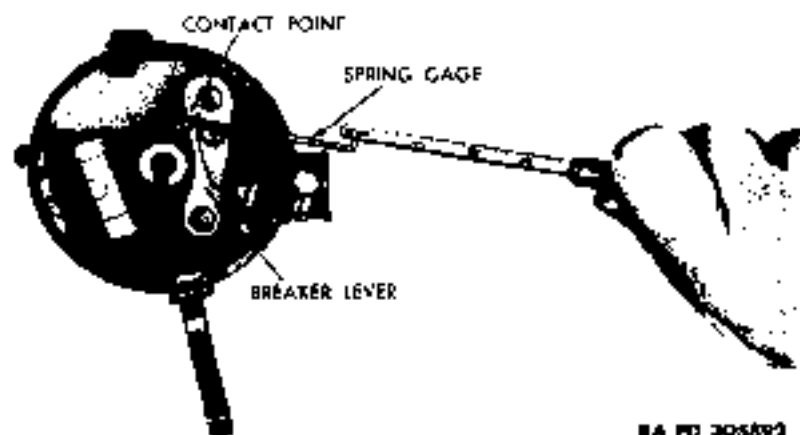
81. DISTRIBUTOR.

a. **Description.** The distributor is a six-cylinder semiautomatic unit which has an integral centrifugal advance mechanism. The distributor shaft, rotation of which is counterclockwise as viewed from the bottom of the unit, is driven from the accessory drive shaft gears in the tachometer drive adapter. Engagement is made between the lower portion of the distributor shaft and tachometer drive adapter by means of a tongue in the shaft engaging with a slot in the adapter.

IGNITION SYSTEM

b. Tabulated Data.

	Pyram Motor	Bridge Division	Cross
Make	Delco-Remy	Delco-Remy	Delco-Remy
Model	1110135	1110151	1110151
Point opening (in.) . .	0.018-0.024	0.018-0.024	0.018-0.024
Cam angle	35°	35°	35°
Contact point tension .	17-21 oz	17-21 oz	17-21 oz
Initial timing	T.D.C.	T.D.C.	T.D.C.
Firing order	1-5-3-6-2-4	1-5-3-6-2-4	1-5-3-6-2-4
Distributor condensers:			
Make	Delco-Remy	Delco-Remy	Delco-Remy
Model	1869704	1869704	1869704



BA PD 305892

Figure 69—Checking Contact Point Pressure

c. Maintenance and Adjustment.

(1) **MAINTENANCE.** Clean points with a contact file (or stone) if they are pitted or burned. Never use emery cloth to clean points. Contact points, after considerable use, will not appear smooth and bright, but this is not an indication that they are not functioning satisfactorily, since they may be making contact over a greater area than new points.

(2) **ADJUSTMENTS.**

(a) Contact point opening may be checked with a feeler gage, a dial indicator, or a cam angle meter. The correct point opening is 0.018-0.024 inch. Cam angle is the number of degrees the cam rotates between the instant the points close and the instant they open again. This cam angle increases as point opening is increased.

(b) Adjust cam angle by loosening locking screw which holds stationary contact support, and turning the eccentric. After adjustment is made, tighten locking screw and recheck setting.

6-TON, 6 x 6 TRUCK (WHITE, CORBITT, AND BROCKWAY)

(c) Contact point pressure is checked by using a spring scale (measuring ounces) hooked to the lever arm (fig. 69) and a pull exerted in a direction vertical to the point surface. Adjustment may be made by bending breaker lever spring to increase or decrease tension as required. The correct point pressure is 17-21 ounces. If spring scale is not available, check by "feel." NOTE: *New breaker lever springs may have too much tension. Therefore, after installing new points, always check point pressure, and adjust if required.*

d. Removal.

(1) REMOVE DISTRIBUTOR HEAD AND WIRING. Snap off clips and lift off distributor head, laying it aside. Unscrew set screw and pull spark control wire from fitting on engine side of distributor. Unscrew terminal nut on engine side of distributor and remove wire to coil.

(2) REMOVE TACHOMETER DRIVE. Unscrew coupling nut and pull tachometer cable from distributor drive housing.

(3) REMOVE DISTRIBUTOR. Remove two cap screws from flange below distributor. Lift distributor vertically from engine.

e. Installation.

(1) SET ENGINE TIMING. Rotate engine with hand crank until No. 1 piston is on the compression stroke. This point is found by removing No. 1 spark plug, then placing thumb over plug hole. Rotate engine with hand crank. When pressure is felt against thumb, it indicates that No. 1 piston is on compression stroke. Continue turning slowly by hand and bring to top dead center as indicated by DC mark on flywheel.

(2) INSTALL DISTRIBUTOR. Insert distributor drive shaft into tachometer drive extension, then push the assembly in place with rotor pointing to No. 1 cylinder. The rotor should be set so that contact points are just ready to open.

82. SPARK PLUGS.

a. Description. The spark plugs are of conventional construction consisting of two electrodes insulated from each other. They are spaced to form a spark gap at the lower end of the plug which projects into the combustion chamber.

b. Maintenance.

(1) Caps are burned open by the constant application of heat, spark, pressure, and chemical action of the fuel mixture. Electrodes become oxidized and corroded, causing increased resistance to the passage of current. The firing end of the core becomes encrusted with carbon and other deposits, resulting in engine missing because of current loss over and through these deposits. Plugs may develop a gas leak between the core and shell, or between the center electrode and core. If, after being properly cleaned and regapped, plugs do not measure up to requirements when checked on a reliable tester, replace with new plugs.

IGNITION SYSTEM



FEELER GAGE

RA PD 305804

Figure 70—Checking Spark Plug Gap with Gage 41-G-330



RA PD 305777

Figure 71—Removing Spark Plug

(2) Remove spark plugs, clean, and check gaps with a round feeler gage every 500 miles. Use a resistance tester every 4,000 miles. Set gap at 0.025 inch.

c. **Removal and Installation:** Pull high-tension cables from plug snap terminals. Unscrew and remove spark plugs and gaskets. To install, place a new copper gasket over threaded end of spark plug. Screw in plug using spark plug wrench or tension wrench (fig 71). Snap high-tension wires on proper plugs.

6-TON, 6 x 6 TRUCK (WHITE, CORBITT, AND BROCKWAY)

83. TIMING ADJUSTMENT.

a. Remove distributor cap assembly. Check the breaker points carefully to make sure that they are in good condition and have the correct gap (0.018 inch-0.024 inch) when fully separated.

b. Remove No. 1 spark plug and rotate engine with hand crank until No. 1 piston reaches top dead center on the compression stroke as indicated by DC mark on flywheel being up in center of timing hole. At this point the rotor should point to No. 1 cylinder with the contact points just ready to open. Install rotor distributor cap. If the above directions are carefully followed, ignition timing should be correct. Make final check for distributor to engine timing, using a neon timing light as follows:



Figure 72—Timing Marks on Flywheel

(1) Connect one lead of the timing light to No. 1 spark plug, and the other to No. 1 spark plug wire.

(2) Mark housing with narrow mark in line with DC mark on flywheel. Start engine, let run at idle speed, and with flash of timing light directed on opening in flywheel housing, check position of DC line in relation to chalk line at flywheel hole. The lines will coincide if the timing is correct. If the lines do not coincide, loosen the distributor advance arm clamp, and rotate the distributor to advance or retarded position.

84. RADIO SUPPRESSION.

a. *Analysis of System.* In automotive wiring systems, when the current is generated or high-tension current used, a condition is

IGNITION SYSTEM

created causing the broadcast of radio waves. These waves act as undesirable static or noises picked up by radio equipment in the vehicle, or in other radios close by.

b. **Description of Noises.** The type of interference produced will indicate definite electrical circuits. A whining noise in the radio signal, increasing and decreasing with engine speeds, indicates faulty generator suppression. A regular, clicking sound in time with the

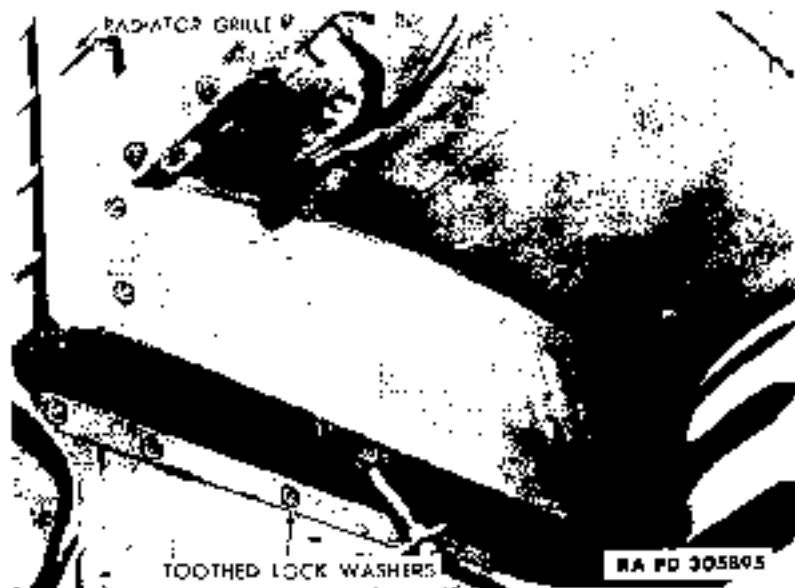


Figure 73—Toothed Lock Washer Bonds

engine indicates a faulty spark plug suppressor. A very rapid clicking indicates a faulty distributor suppressor.

c. **Methods of Suppression.**

(1) **DESCRIPTION OF SUPPRESSION UNITS USED.**

(a) **Condenser.** Condensers are used on the ignition coil regulator field terminal, and the generator armature post to suppress high-current surges in the system. In each case, the unit being suppressed is grounded through the condenser used.

(b) **Suppressor.** Suppressors are used on the high-tension cables of the ignition system between the coil and distributor cap, and between the distributor and the spark plugs. The carbon core of the suppressors refracts electrical impulses, and prevents them from reentering the terminals for radiation.

6-TON, 6 x 6 TRUCK (WHITE, CORBITT, AND BROCKWAY)

(c) *Radio Filter.* A radio filter mounted on the cowl inside the cab suppresses radio noise by absorbing the current surges that would cause an undesirable radio signal.

(d) *Bonds.* These bonds are used to ground the entire electrical system within itself to prevent radiation of undesirable radio signals.

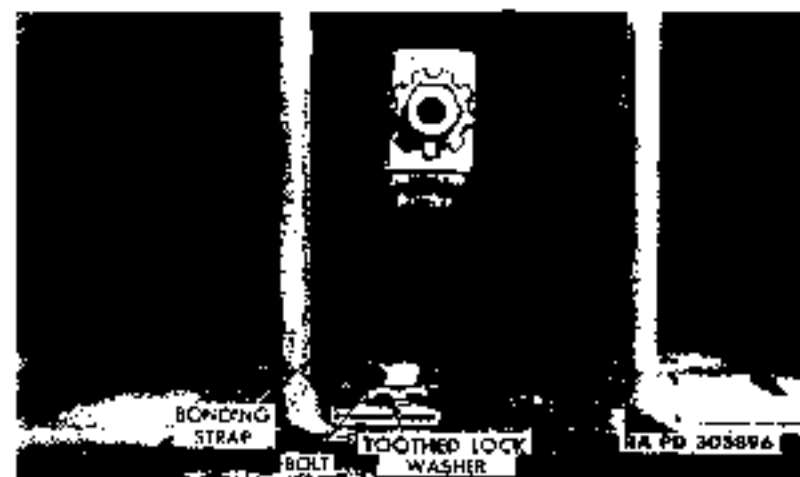


Figure 74—Braided Bond Strap

(e) *Shielding.* A braided shielding, grounded to the cowling at the voltage regulator, prevents radiation of electrical waves from the generator to regulator cable.

(2) **MAINTENANCE OF SUPPRESSION UNITS.** Keep all condensers and their terminals dry and clean. Keep all suppressors and terminals clean and tight. Inspect bonding straps and toothed lock washers to determine their condition, and keep them tight at all times.

Section XX

STARTING AND GENERATING SYSTEM

	Paragraph
Cranking motor	85
Solenoid switch	86
Generator	87
Voltage regulator	88

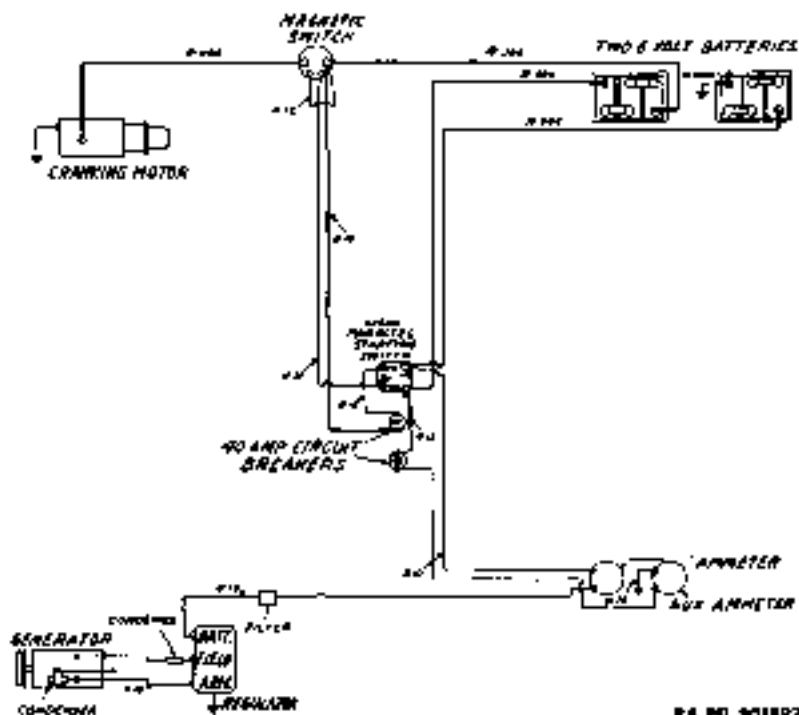


Figure 75—Prime Mover Starting and Generating System Wiring Diagram

85. CRANKING MOTOR.

a. **Description.** The cranking motor is a heavy-duty, 12-volt, 6-pole, 6-brush, gear-reduction type, and is secured to the flywheel housing on the right side of the engine. Power is transmitted to the engine flywheel ring gear through a Bendix drive. The Bendix drive provides an automatic means of engaging cranking motor drive pinion with flywheel teeth to crank engine for starting, and of disengaging pinion after engine has started. A removable cover band around the field frame permits inspection of the commutator and brush connections.

6-TON, 6 x 6 TRUCK (WHITE, CORBITT, AND BROCKWAY)

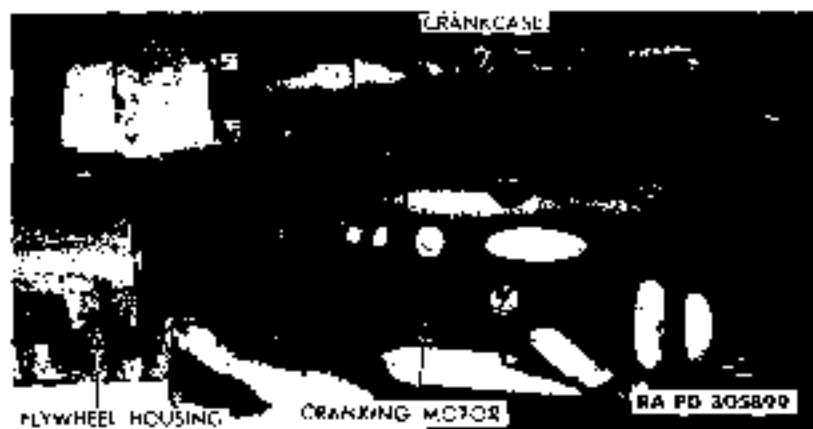


Figure 76—Removing Cranking Motor

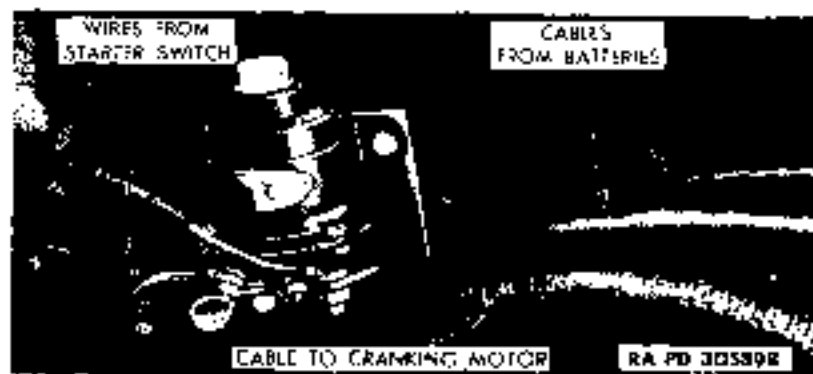


Figure 77—Solenoid Switch Installed

b. Tabulated Data.

Make	Delco-Remy
Model	494
Voltage	12
Flange mounting	3 stud

c. Maintenance and Adjustment.

(1) **MAINTENANCE.** The cover band should be removed periodically and the brushes and commutator inspected. If dirty, clean with

STARTING AND GENERATING SYSTEM

2/0 flint paper (never use emery cloth). If brushes wear with excessive rapidity, check for excessive brush spring tension, rough or high mica of commutator.

(2) **ADJUSTMENT.** Adjust tension springs to 36-40 ounces. Brushes must seat properly and not bind. Check connections, cables between cranking motor and battery. Check for loosened flange mounting screws and oil seepage into the drive from the flywheel housing.

d. **Removal.** Disconnect cable at terminal on cranking motor, and tape end to avoid grounding. Remove three cap screws and lock

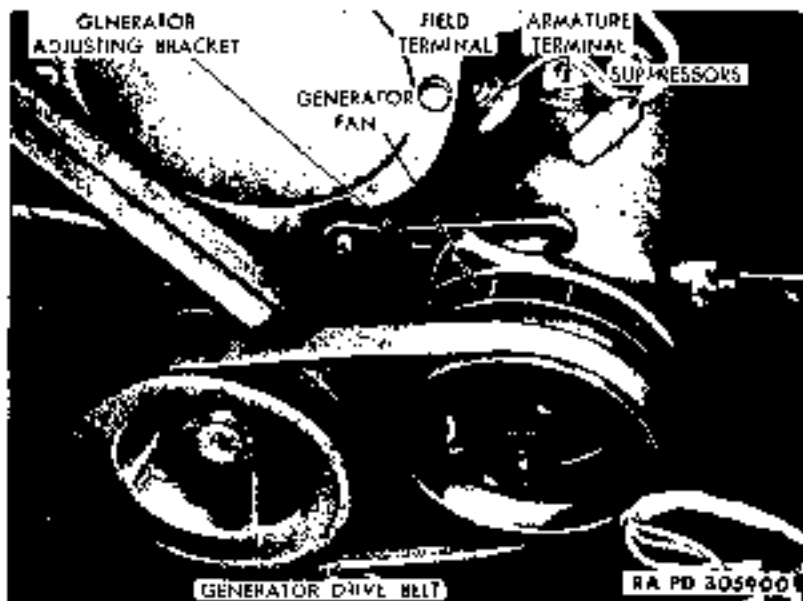


Figure 78—Generator Installed

washers from flange which holds unit to flywheel housing. Then pull forward and free.

e. **Installation.** Guide cranking motor gear end into hole in flywheel housing. Start three cap screws with lock washers into holes provided and tighten. Install cable on terminal and tighten locking nut.

86. SOLENOID SWITCH.

a. **Description and Operation.** The switch is a solenoid type, installed in the cranking motor and generator electric system, and connects the batteries directly to the cranking motor in series.

4-TON, 4 x 4 TRUCK (WHITE, CORBETT, AND BROCKWAY)**b. Tabulated Data.**

Make	Delco-Remy
Model	1422-12-volt

c. **Maintenance.** Check terminals and mounting at regular intervals. Keep them clean and tight.

d. Removal and Installation.

(1) **REMOVAL.** UnscREW terminal nuts and washers, and pull off cable fittings. UnscREW two nuts which hold switch to bracket on



Figure 79—Removing Generator

right frame side rail in front of rear engine support, and lift switch from assembly.

(2) **INSTALLATION.** Place switch in position on bracket, insert two bolts, lock washers and nuts, and tighten. Install cables on terminals, and install and tighten two bolts, lock washers and nuts which hold switch to frame bracket.

87. GENERATOR.

a. **Description.** The generator is a ventilated, two-brush shunt unit, equipped with ball bearings in drive end and a bronze bushing in commutator end, designed for use with a current and voltage

STARTING AND GENERATING SYSTEM

regulator. It is mounted on the left side of the engine, being driven by means of a belt in a clockwise direction (viewing drive end). Belt tension is maintained by adjusting the slotted supporting strap (fig. 78). A removable cover band around the field frame permits inspection of the commutator and brush connections.

b. Tabulated Data.

Make	Delco-Remy
Model	1105854
Voltage	6
Type of drive	Belt

c. **Maintenance and Adjustment.** Check unit at regular intervals for drive belt adjustment and lubrication. Keep mounting

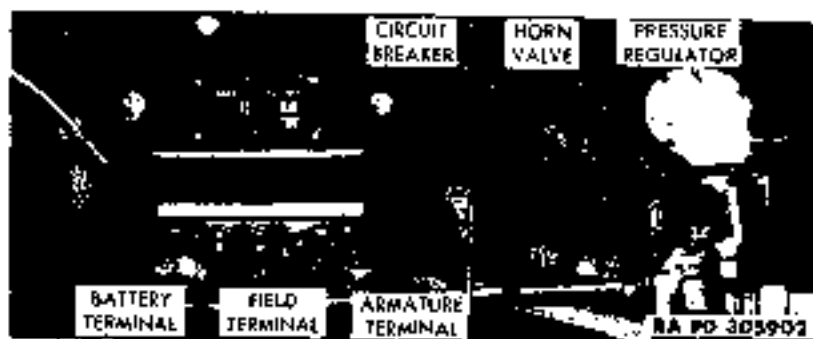


Figure 80—Voltage Regulator Installed

bracket and bolts tight, and entire assembly clean. Keep terminals clean and tight.

d. **Removal.** To remove generator, disconnect leads, tagging them for proper identification and taping clips to avoid grounding. Remove nuts and lock washers from two bracket bolts at bottom of generator ends but leave bracket bolts in place to support generator. Remove belt tension adjusting bracket bolt on top of the generator, push generator toward cylinder block, lift off belt and remove the bracket bolts and withdraw generator.

e. **Installation.** Locate the generator so that the holes in the flange line up with the holes in the supporting bracket. Insert two bolts at the bottom of the generator and partially pull down lock washer and nuts on these bolts. Install auxiliary drive belt, adjusting arm bracket, bolt, nut, and lock washer. Tighten nuts and adjust bracket and belt tension. Untape leads and connect them to generator armature and field terminals.

6-TON, 6 x 6 TRUCK (WHITE, CORBITT, AND BROCKWAY)

88. VOLTAGE REGULATOR.

a. **Description.** The generator output to the electrical system is controlled automatically by a device called a voltage regulator, which is mounted to the left on the engine side of the dash. The regulator consists of three units: a cut-out relay, a voltage regulator, and a current regulator.

(1) **CUT-OUT RELAY.** This automatic switch closes the circuit between the generator and the battery when the generator voltage has built up to a value sufficient to force a charge into the battery. The cut-out relay opens the circuit when the generator slows or stops, and current begins to flow back from the battery into the generator.

(2) **VOLTAGE REGULATOR.** This device prevents line voltage from exceeding a predetermined value, and thus protects battery and other electrical units in the system from high voltage. One characteristic of batteries is this: as either specific gravity or charging rate increases, other conditions being equal, battery terminal voltage increases. If terminal voltage is held constant, as battery comes up to charge (specific gravity increases), charging rate will be reduced. The voltage regulator performs this job of holding voltage constant, and this protects the electrical system from high voltage and possible damage from overcharge.

(3) **CURRENT REGULATOR.** This unit limits generator output to a safe amount. It is in effect a current-limiting device which operates when generator output has increased to its safe maximum, and prevents generator from exceeding this amount.

b. **Tabulated Data.**

Make	Delco-Remy
Model	5628
Voltage	6

c. **Removal of Regulator.** Disconnect leads from terminals, tagging them for proper identification. Remove four nuts and lock washers which hold regulator to dash, and remove regulator.

d. **Installation of Regulator.** Place regulator over studs protruding from dash. Install lock washers and nuts on studs. Replace leads on proper terminals, and tighten connections.

Section XXI

CLUTCH

	Paragraph
Description and operation	89
Maintenance and adjustment	90
Clutch removal	91
Clutch installation	92

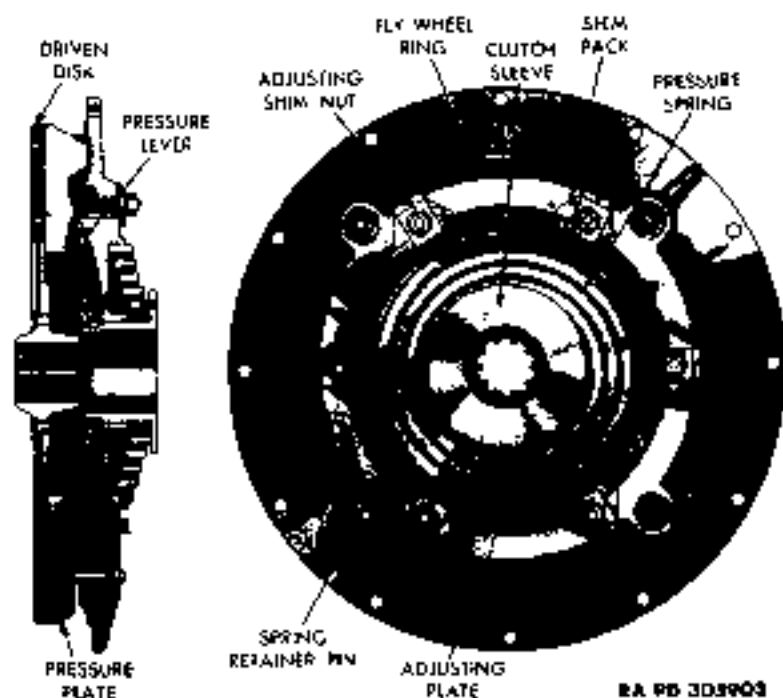


Figure 81—Cross Section and Rear View of Clutch

89. DESCRIPTION AND OPERATION.

a. **Description.** The clutch is a single-plate, dry-disk type, and transmits power from the engine to the transmission.

b. **Tabulated Data.**

Make	Lipe
Model	ISSP-Z40-SX
Pedal ratio	13 to 1

c. **Operation.** The clutch is known as a "push type," meaning that it must be pushed to release it. When the clutch pedal is dis-

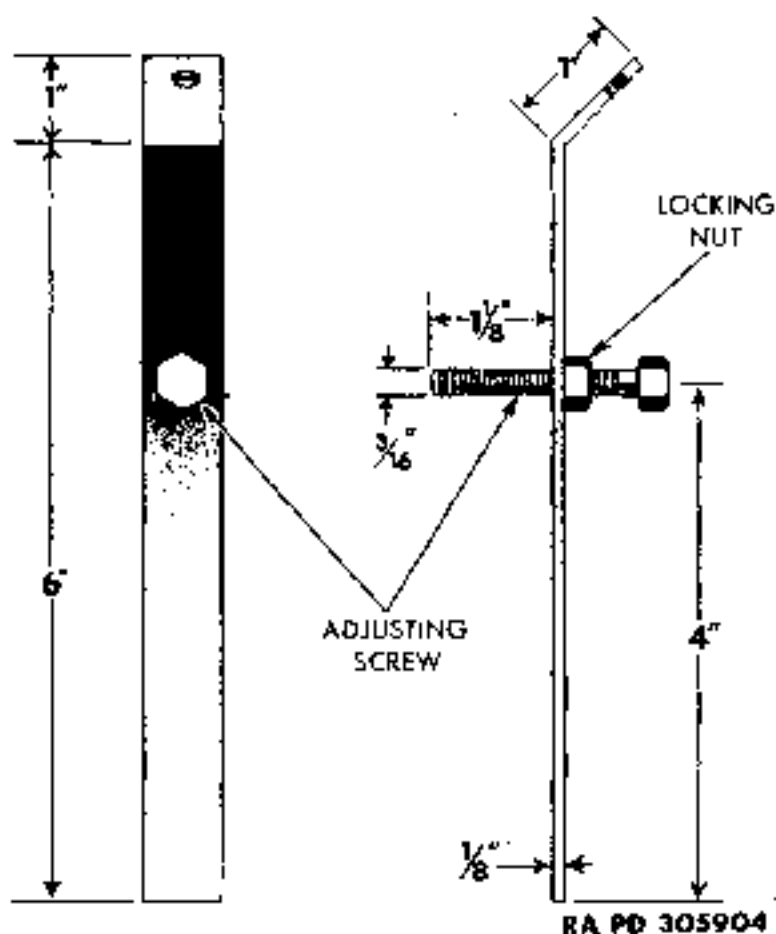
6-TON, $\phi = 6$ TRUCK (WHITE, CORBITT, AND BROCKWAY)

Figure 82—Gage for Clutch Adjustment

engaged (pushed in), the clutch sleeve moves toward the flywheel, providing an action on the hinged levers that is opposed to the spring pressure on these levers. This removes pressure against the pressure plate, allowing the retractor spring to prevent contact of the pressure plate and the driven plate. When the pedal is engaged (pedal out), the pressure spring acts upon the hinged levers, increasing the pressure of the spring and engaging the friction face tightly with the flywheel.

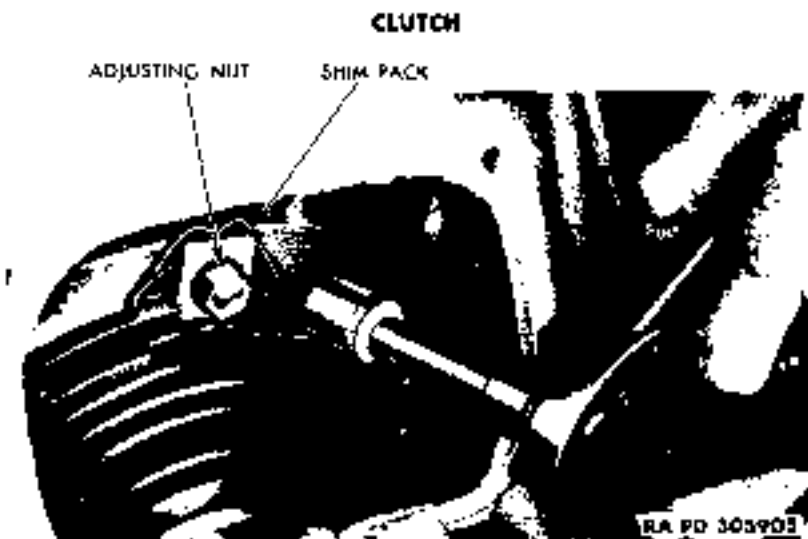


Figure 83—Loosening Clutch Adjusting Nuts

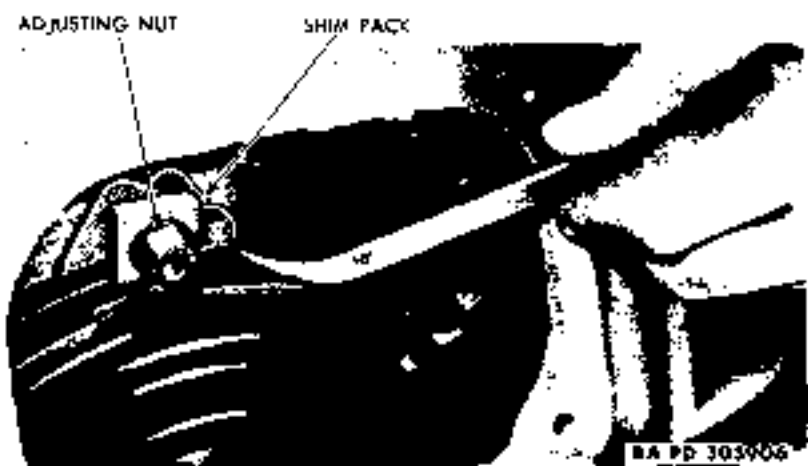
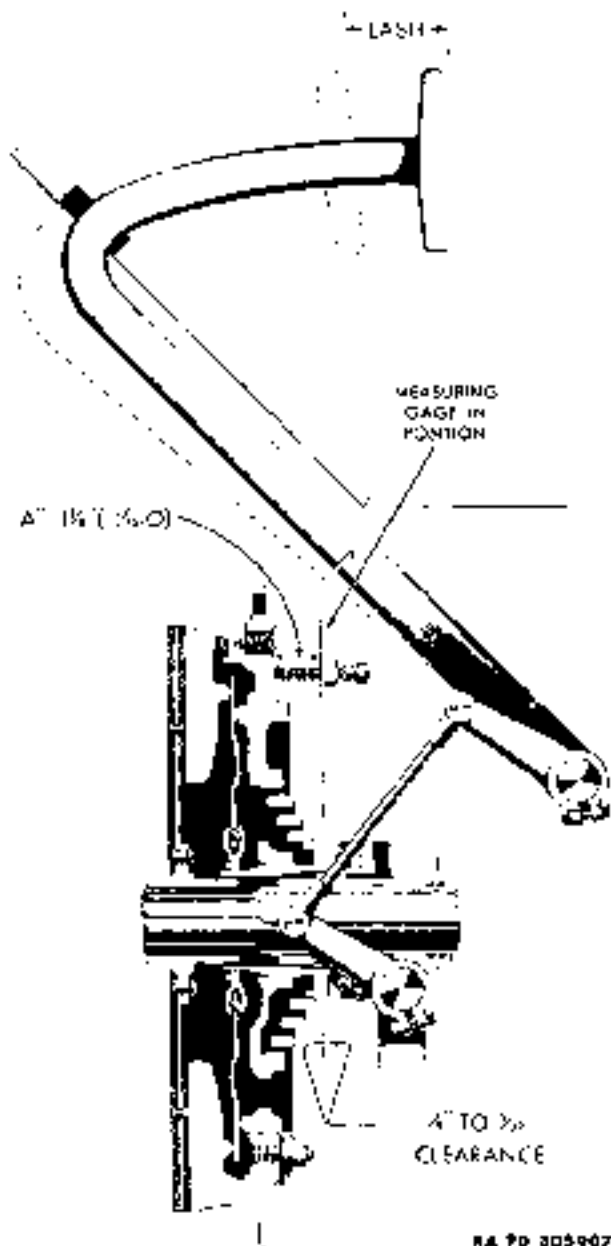


Figure 84—Removing Shim from Shim Pack

90. MAINTENANCE AND ADJUSTMENT.

a. **Maintenance.** Inspect unit at regular intervals for operation. Lubricate pedal shaft and clutch release bearing as per lubrication specifications (figs. 15 through 21).

b. **Adjustment.** Adjust the clutch when the pedal free travel becomes $\frac{1}{2}$ inch or less. Adjust clutch, using common method with two six-inch scales, or with improvised gages (fig. 82).



RA 90 205907

Figure 83—Cross Section of Clutch with Special Measuring Gage in Position

CLUTCH

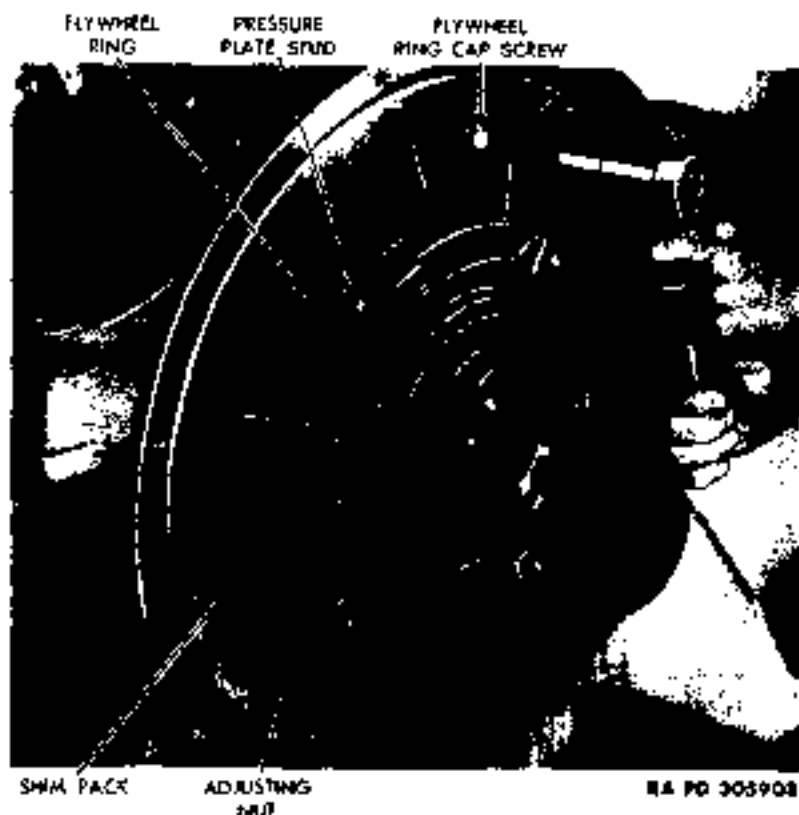


Figure 86—Removing Flywheel Ring Cap Screws

(1) **PREPARE EQUIPMENT FOR ADJUSTMENT.** Remove toe- and floorboards. Unscrew four screws and lift off plate covering view hole at top center of bell housing. Block clutch pedal into "IN" position, using wooden block braced against seat front.

(2) **LOOSEN ADJUSTING NUTS.** By revolving clutch with cranking motor, bring each adjusting strap into working position, backing off each of six adjusting nuts five full turns. Engage the clutch by removing the block on the pedal. This will permit the adjusting plate to move out of contact with the adjusting shims.

(3) **PULL SHIMS AND TIGHTEN ADJUSTING NUTS.** Using a tapered shim puller pull one shim from under each adjusting strap. Do not drop shims or tools into the housing. Block the clutch pedal again into "IN" position with wooden block. Tighten six adjusting strap nuts firmly.

r. **Check Clutch Adjustment.** Insert special gage (with stop screw set $1\frac{1}{8}$ inch from gage edge) into space between clutch sleeve

4-TON, 4 x 6 TRUCK (WHITE, CORBITT, AND BROCKWAY)

and clutch release bearing. Push release bearing against special gage so that gage will be vertical. In this position the stop screw tip of the gage should touch the machined surface (which is against the shims). Each series of shims removed from the group of six adjusting straps will reduce dimension "A" $\frac{1}{8}$ inch. When the correct adjustment measurement has been obtained, the release bearing should be $\frac{1}{8}$ inch to $\frac{3}{16}$ inch away from the clutch sleeve. As the special gage is $\frac{3}{16}$ -inch thick, it will mean a tolerance fit of the gage in this groove.

91. CLUTCH REMOVAL.

- a. **Remove Transmission to Transfer Case Propeller Shaft** (par. 100).
- b. **Remove Transmission Assembly** (par. 94).
- c. **Remove Clutch.** Remove 12 cap screws and lock washers and lift clutch assembly from flywheel.

92. CLUTCH INSTALLATION.

- a. **Installation.** Try clutch cover plate to be sure of free fit in flywheel. Use a tapered spline of the same specification as that of the pilot shaft ($1\frac{3}{4}$ in.—10 C. S.A.E. std.) to align the driven disk, and place the clutch assembly in position on the flywheel. Insert and tighten 12 cap screws. Pull these down until all contact the cover plate assembly, then gradually tighten every other screw until assembly is tightly secured to the flywheel.
- b. **Install Transmission Assembly** (par. 95).
- c. **Install Transmission to Transfer Case Propeller Shaft** (par. 100).

Section XXII

TRANSMISSION

	Paragraph
Description and tabulated data	93
Removal of transmission assembly	94
Installation of transmission assembly	95
Power take-offs	96

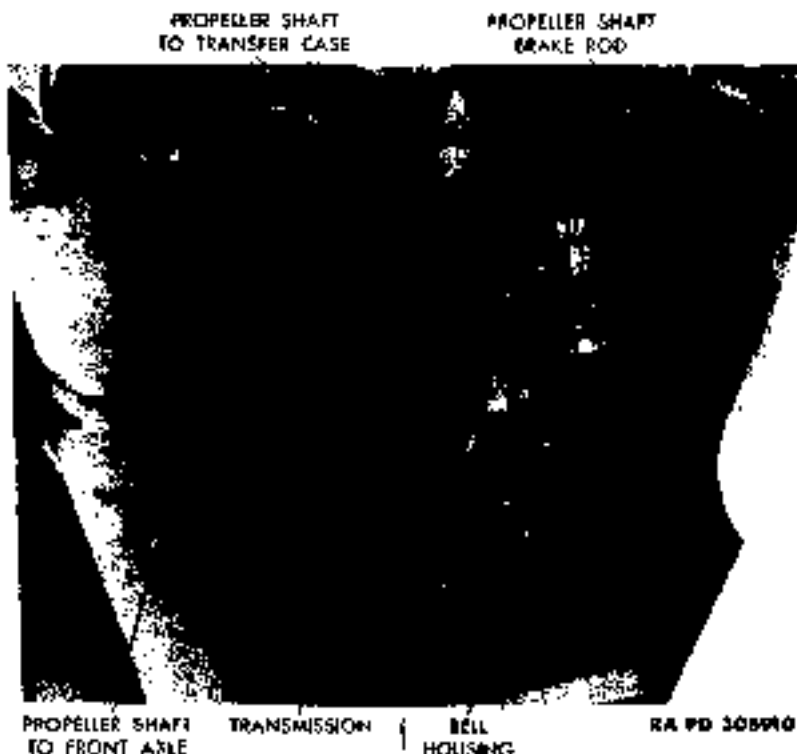


Figure 87—Transmission installed

93. DESCRIPTION AND TABULATED DATA.

a. **Description.** The transmission is the selective gear type, having four speeds forward and one reverse. This unit transfers power through the clutch to the balance of the power train of the vehicle, and permits a selection of proper gear ratios for the load carried or the speed of the vehicle.

b. Tabulated Data.

Make	Fuller
Model	4-A-86

6-TON, 6 x 6 TRUCK (WHITE, CORBIT, AND BROCKWAY)



Figure 88—Removing Transmission

94. REMOVAL OF TRANSMISSION ASSEMBLY.

a. **Remove Floorboards and Drain Transmission.** Remove floorboards and torboards to gain access to the transmission. Drain lubricant from bottom of case.

b. **Disconnect and Remove Propeller Shafts.** Disconnect transfer case to front axle propeller shaft at transfer case end (par 100). Disconnect and remove transmission to transfer case propeller shaft (par 100).

c. **Disconnect Linkage.** Disconnect clutch pedal linkage at clevis on left side of clutch housing. Support transmission with rope or chain sling. Unscrew two cap screws, and remove bracket, which holds hand brake relay lever, from right side of housing.

d. **Remove Transmission Shift Lever.** Unscrew four cap screws and lock washers in gearshift lever housing, and lift off lever and housing.

e. **Remove Transmission.** Remove 12 cap screws holding bell housing to flywheel housing. Pull transmission assembly to rear until clutch pilot shaft clears flywheel bore. Lower transmission carefully out of chassis.

TRANSMISSION

95. INSTALLATION OF TRANSMISSION ASSEMBLY.

a. **Attach Transmission to Engine.** Support transmission with rope or chain sling. Lift into position, and guide splined clutch pilot shaft into flywheel bore until bell housing is tight against flywheel housing. Insert 12 cap screws holding bell housing to flywheel housing, and pull down tight.

b. **Install Hand Brake Lever Relay.** Install hand brake relay lever and bracket to right side of housing. Insert and tighten two lock washers and cap screws.

c. **Install Gearshift Lever.** Install gearshift lever and housing. Insert and tighten four lock washers and cap screws.



LOCKING NUT

ADJUSTING SCREW

RA PD 303909

Figure 89—Clutch to Transmission Linkage

d. **Install Propeller Shafts.** Install propeller shaft between transmission and transfer case (par. 100). Install transfer case to front axle propeller shaft at transfer case end (par. 100).

e. **Install Pedal Linkage.** Install clutch pedal linkage at clevis on left side of clutch housing, and secure to pedal rod with clevis pin and cotter pin.

f. **Install Floorboards and Lubricate Transmission.** Install floorboards and toeboards. Fill transmission case to level plug with proper lubricant (figs. 16 through 21).

96. POWER TAKE-OFFS.

(Bridge erection trucks only.)

a. **Description.** A power take-off is mounted on the right side and on the left side of the transmission housing. The one on the left

6-TON, 6 x 6 TRUCK (WHITE, CORBITT, AND BROCKWAY)

side, commonly called the winch power take-off, transfers power from the transmission to the winch propeller shaft and winch. The one on the right side is called the pump power take-off, and transfers power to the hydraulic pump for operation of the boom.

b. Tabulated Data.

	Right-hand	Left-hand
Make	Hiel	Hiel
Model	357	356



Figure 90—Disconnecting Drive Chain

c. Maintenance. The binding straps supporting the power take-offs must be inspected at regular intervals. Keep tight at all times.

d. Removal. *NOTE: Since the left-hand power take-off is equipped with an adapter, and the balance of the removal operations are applicable to both units, the removal description is given for the left-hand power take-off.*

(1) **REMOVE FLOORBOARDS AND BOOTS.** Remove screws from floorboards and toeboards. Unlace boots around shifting lever and steering column and remove boards from cab.

(2) **DISCONNECT CONTROLS.** Disconnect remote control cable from shifter bar. Remove mounting bracket U-bolt and bend flexible

TRANSMISSION



Figure 91—Removing Drive Sprocket



Figure 92—Removing Power Take-off

cable down to permit removal. Remove cable. Disconnect hand shifter bar at clevises and remove. Disconnect throttle, remove control cable.

(3) **REMOVE DRIVE CHAIN.** Remove two cutter pans and link plate from any chain link and pull spacers from chain. Hold one end of chain to prevent dropping, and remove chain from sprockets.

(4) **REMOVE SUPPORT STRAP.** Remove two nuts, lock washers and bolts from the top support strap bracket, and two from the

5-TON, 5 x 6 TRUCK (WHITE, CORBITT, AND BROCKWAY)

bottom bracket of the transmission. Remove two cap screws and lock washers holding the strap to the power take-off. Slide the strap toward the rear of the vehicle, and lift up and out of chassis.

(5) **REMOVE BRAKE PEDAL LINKAGE AND DRIVE SPROCKET.** Disconnect brake pedal linkage at clevises, and remove linkage rod. Loosen socket-head set screw and pry drive sprocket from the power take-off. Tap square key from shaft and remove.

(6) **REMOVE POWER TAKE-OFF AND ADAPTERS.** Remove six nuts and lock washers from mounting studs. Tap power take-off with a soft-nosed hammer to loosen, pull off studs and remove. *NOTE: If replacement gaskets are not available, use extreme care not to damage gaskets, as they are used to determine proper gear lash.* Tap the adapter in the same manner, pull off studs and remove. Use extreme care not to damage this gasket.

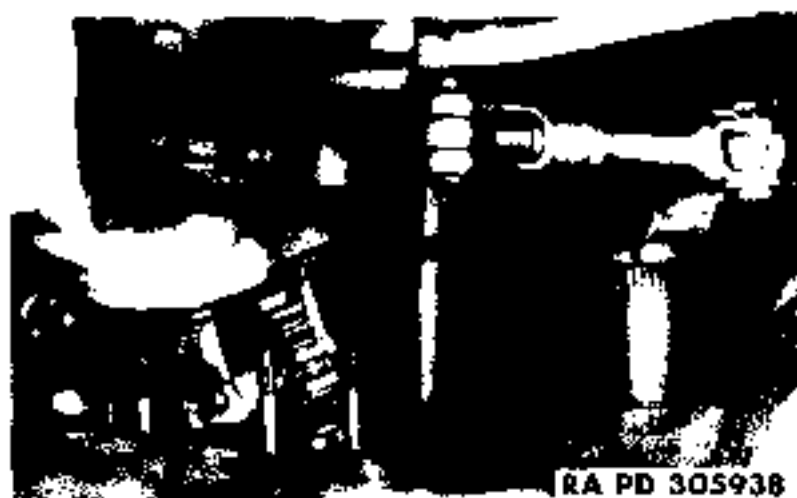


Figure 93—Removing Power Take-off Adapter

e. Installation.

(1) **INSTALL ADAPTER AND POWER TAKE-OFF.** Place new adapter gasket (of same thickness as the one removed) over mounting studs on left side of transmission, and slide adapter in place. Slide power take-off in position against adapter, and install and tighten six lock washers and nuts.

(2) **INSTALL DRIVE SPROCKET AND BRAKE PEDAL LINKAGE.** Tap square shaft key into place in sprocket shaft. Line up sprocket with key and tap into position on shaft. Tighten socket-head set screw in sprocket.

(3) **INSTALL SUPPORT STRAP.** Place support strap in position and install and tighten two lock washers and cap screws holding strap to power take-off. Install and tighten two bolts, lock washers, and

TRANSMISSION

outs at the top transmission bracket and two at the bottom, securing the support strap to the transmission.

(4) **INSTALL DRIVER CHAIN.** Place chain around propeller shaft sprocket and power take-off sprocket. Insert spacer and link plate on chain and secure with two cotter pins.

(5) **CONNECT CONTROLS.** Connect throttle remote control cable. Connect hand shifter bar at clevises. Install remote control cable at shifter bar. Install and tighten U-bolt.

(6) **INSTALL FLOORBOARDS.** Place floorboards and toeboards in position. Install and tighten screws. Lace and tie boots at steering column and gearshift lever.

6-TON, 6 x 6 TRUCK (WHITE, CORBITT, AND BROCKWAY)



Figure 94—Propeller Shafts Installed

Section XXIII

PROPELLER SHAFTS

	Paragraph
Description and tabulated data	97
Location of propeller shafts	98
Maintenance	99
Removal and installation	100

97. DESCRIPTION AND TABULATED DATA.

a. **Description.** Power is transmitted from the engine and transmission, through the transfer case and to the axle differentials through the use of propeller shafts. Each assembly consists of a tubular shaft with a nonslip (stationary) joint and a slip (movable) joint. The slip joint permits variations in length between the connected units, caused by the flexing of the springs while the truck is in motion. The joints are equipped with two types of ends, a sleeve yoke (or end) or a flange yoke as required.

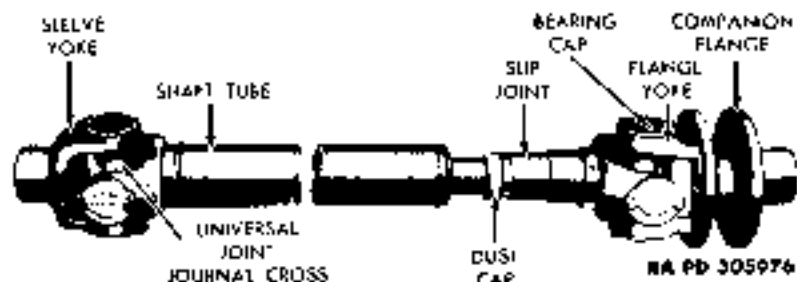
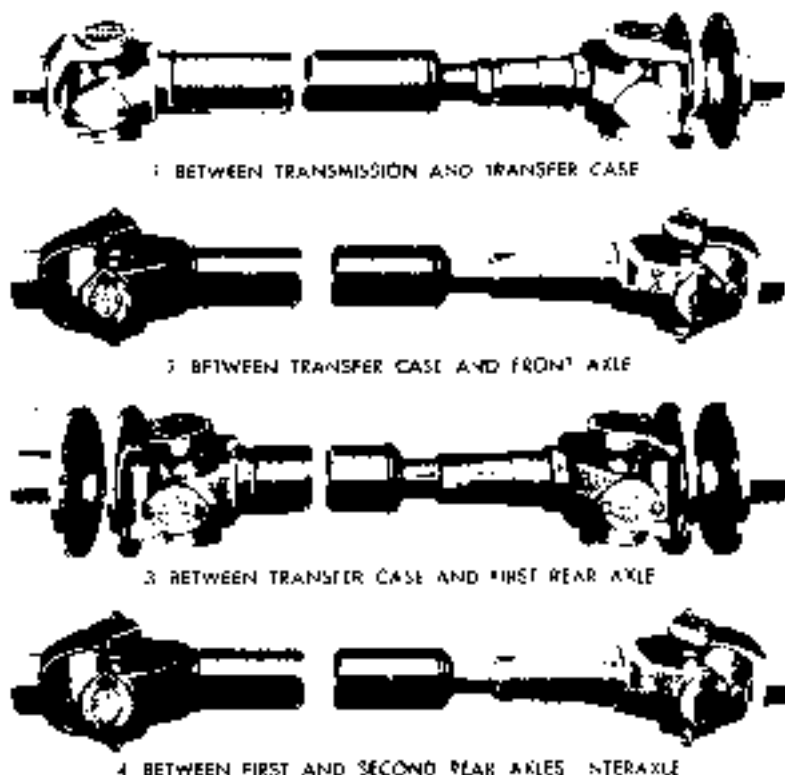


Figure 95—Propeller Shaft Assembly

b. Tabulated Data.

Make	Prime Mover		Bridge Section	Crane
	White	Cowlin		
Spicer	Spicer	Blood	Spicer	Spicer
Models:				
Transmission—				
Transfer case	9000-1SF	6N-9346	9113-1SF	9113-1SF
Transfer case—				
Front axle	9001-1SF	7N-9071	9114-1SF	9114-1SF
Transfer case—				
Forward rear axle	9002-1SF	7N-9072	9115-1SF	9115-1SF
Interaxle	8215-1SF	6N-9073	8215-1SF	8215-1SF

6-TON, 6 x 6 TRUCK (WHITE, CORBITT, AND BROCKWAY)



RA PD 305912

Figure 96—Propeller Shafts

98. LOCATION OF PROPELLER SHAFTS.

a. There are four propeller shafts used on these vehicles, and their positions are as follows:

(1) **BETWEEN TRANSMISSION AND TRANSFER CASE.** This shaft is assembled with the slip joint and a flange yoke at the transmission end, and a sleeve yoke at the transfer case end.

(2) **BETWEEN TRANSFER CASE AND FRONT AXLE.** This shaft is assembled with the slip joint at the transfer case end and sleeve yokes at both ends.

(3) **TRANSFER CASE TO FORWARD REAR AXLE.** This shaft is assembled with the slip joint at the transfer case end, and flange yokes at both ends.

(4) **FORWARD REAR AXLE TO REARWARD REAR AXLE.** This shaft is assembled with the slip joint toward the forward rear axle and sleeve yokes at both ends. **NOTE:** When installing propeller shafts mount the slip joint closest to the source of power.

PROPELLER SHAFTS

99. MAINTENANCE.

a. Check all universal joints and propeller shafts regularly for excess wear, damaged shafts, and dryness. Replace the slip joint members when their clearance causes run-out or vibration. In event of shaft breakage, install a new shaft.

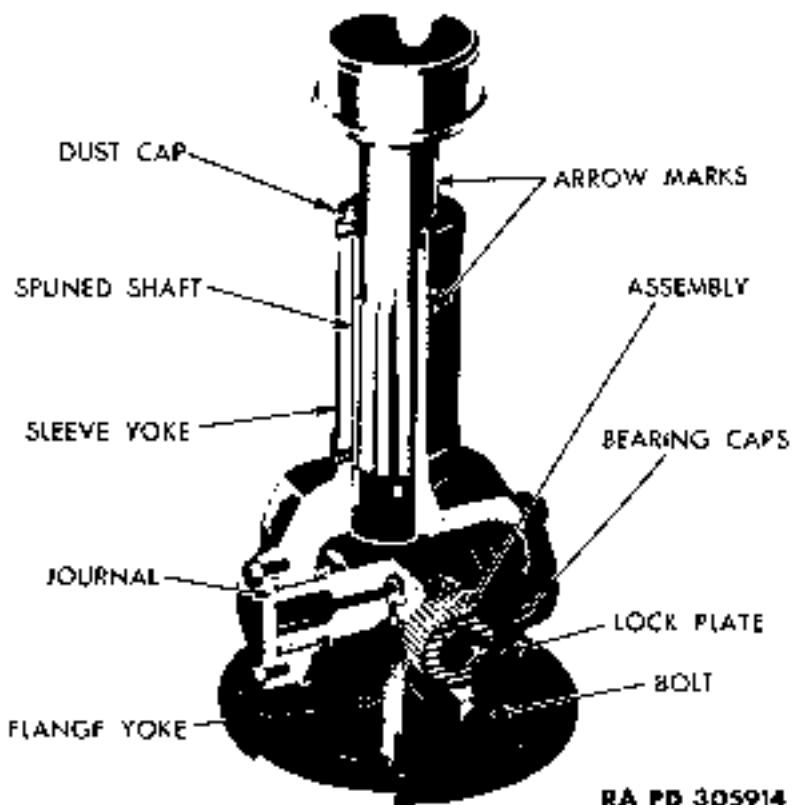


Figure 97—Cross Section of Universal Joint

100. REMOVAL AND INSTALLATION.

a. Transmission to Transfer Case Propeller Shaft Removal.

- (1) **DISCONNECT TRANSMISSION END OF SHAFT.** Remove the eight nuts, lock washers, and bolts holding the flange yoke to the companion flange on the rear of the transmission, and lower this end of the propeller shaft.
- (2) **DISCONNECT TRANSFER CASE END OF SHAFT.** Remove cotter pin and nut holding sleeve yoke to transfer case shaft and pull off shaft.

6-TON, 6 x 6 TRUCK (WHITE, CORBITT, AND BROCKWAY)**h. Transmission to Transfer Case Propeller Shaft Installation.**

(1) **INSTALL TRANSFER CASE END OF SHAFT.** To install replacement assembly, slide sleeve yoke over transfer case shaft and secure with nut and cotter pin.

(2) **INSTALL TRANSMISSION END OF SHAFT.** Match flange yoke and bolt holes with flange at rear of transmission. Insert and tighten eight bolts, lock washers, and nuts. Lubricate to proper specifications (figs 16 through 21).

i. Transfer Case to Front Axle Propeller Shaft Removal.

NOTE: *In this type shaft, with sleeve yokes on both ends, it is necessary to disassemble both universal joints to replace the assembly.*

(1) **DISASSEMBLE UNIVERSAL JOINT.** Bend down locking lug on lock plate and remove two cap screws and bearing on each side of each yoke at both ends of propeller shaft. With a soft-nosed hammer, tap exposed ends of journals. Free and remove four needle bearing assemblies from each joint.

(2) **REMOVE JOURNAL CROSS AND PROPELLER SHAFT.** Slide journal cross to one side of yoke. Tip end of trunnion bearing to clear lug on yoke, remove yoke from joint at each end, and remove propeller shaft.

j. Transfer Case to Front Axle Propeller Shaft Installation.

(1) **ASSEMBLE TRANSFER CASE END YOKE.** Insert the journal cross in position in the yokes at the transfer case end and insert four needle bearing assemblies. Install four bearing caps and locking lugs and install and tighten two cap screws.

(2) **ASSEMBLE FRONT AXLE END YOKE.** Insert the journal cross in position in the yokes at the front axle end and insert four needle bearing assemblies.

(3) **INSTALL BEARING CAPS, TIGHTEN AND LUBRICATE.** Install four bearing caps and locking lugs, insert and tighten two cap screws. Lubricate to proper specifications (figs. 16 through 21).

e. Transfer Case to Forward Rear Axle Removal. Unscrew and remove eight nuts, lock washers, and bolts from companion flanges at each end of shaft and lower shaft from chassis.

f. Transfer Case to Forward Rear Axle Installation. To install, line up companion flanges and holes, install eight bolts, nuts, and lock washers in each end and tighten. Lubricate to proper specifications (figs 16 through 21).

g. Forward Rear Axle to Rearward Rear Axle. Follow the same procedure as in subpars. d and e above.

Section XXIV

TRANSFER CASE

	Paragraph
Description and tabulated data	101
Removal of transfer case assembly	102
Installation of transfer case assembly	103

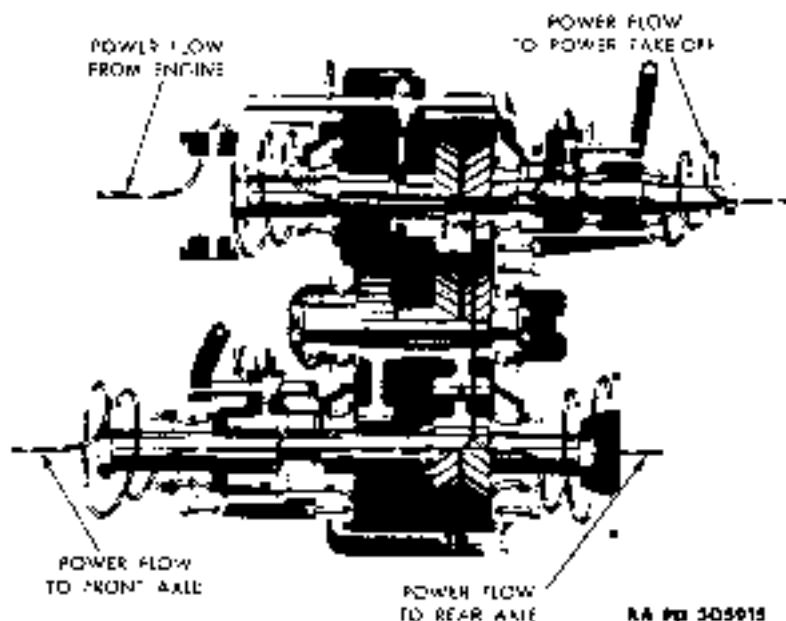


Figure 98—Transfer Case, Cross Section

101. DESCRIPTION AND TABULATED DATA.

a. **Description.** The transfer case in this vehicle is in a gear box mounted on the frame at the rear of the transmission. Its purpose (in the power train) is to transfer power from the transmission to the winch drive, and the front and rear axles. A declutching device for engaging and disengaging the front axle, and a power take-off for driving the winch chain are parts of the transfer case assembly. The unit is equipped with two speed ranges, the selection of which is controlled by a lever in the cab.

h. Tabulated Data.

Make	Timken-Wisconsin
Model	T-77-3-6

6-TON, 6 x 6 TRUCK (WHITE, CORBITT, AND BROCKWAY)

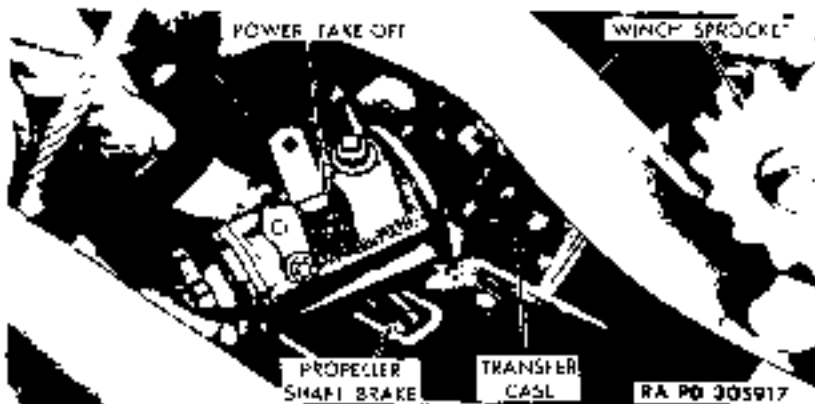


Figure 99—Removing Transfer Case Power Take-off

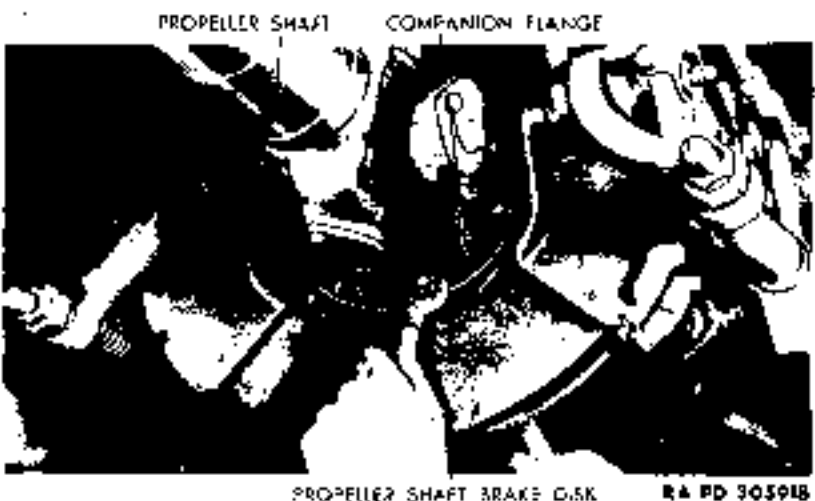


Figure 100—Disconnecting Propeller Shaft

102. REMOVAL OF TRANSFER CASE ASSEMBLY.

a. **Disconnect Propeller Shafts.** Disconnect propeller shaft from transmission to transfer case (par. 100). Disconnect propeller shaft to front axle at transfer case end (par. 100).

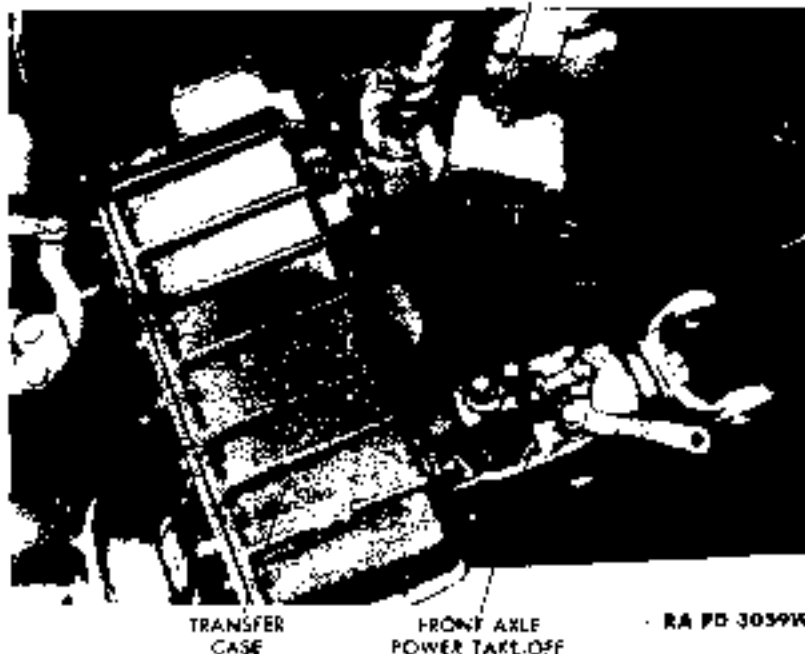
b. **Disconnect Linkage.** Remove cotter pins and clevis pins and disconnect shifting lever linkage rods from front axle shifting lever, winch drive lever, auxiliary range lever, and winch power take-off at their connections on the transfer case housing.

TRANSFER CASE

c. **Remove Speedometer Cable and Winch Drive Chain.** Unscrew coupling nut and pull out speedometer cable at fitting on housing. Remove cotter pin and locking link and lift off winch chain.

d. **Drain Case and Remove Power Take-off.** Unscrew drain plug and drain lubricant from bottom of transfer case housing. Remove six nuts and lock washers, and remove power take-off from upper rear of transfer case housing. Remove two cap screws and the rear support bearing cap and gasket.

CROSS TUBE BRACKET

**Figure 701—Lowering Transfer Case with Rope Sling**

e. **Remove Propeller Shaft Brake.** Remove eight cotter pins, nuts, and bolts, and disconnect companion flange at rear of hand brake. Pull off small pull-back springs on propeller shaft brake shoes and lower brake disks out of assembly.

f. **Remove Transfer Case.** Support transfer case assembly with heavy rope or chain sling. Remove three nuts, lock washers, and bolts from brackets on each frame side rail (holding tubular cross member to the side rails). Slide cross member forward. Remove lock wire and two cap screws from each of two transfer case to cross member brackets, and lower case assembly slowly to the floor.

4-TON, 4 x 6 TRUCK (WHITE, CORBITT, AND BROCKWAY)**103. INSTALLATION OF TRANSFER CASE ASSEMBLY.**

a. **Install Transfer Case.** Place the assembly under the vehicle and place sling around. Lift into position in chassis. Insert and tighten two cap screws in each cross member bracket. Lock these cap screws with locking wire.

b. **Install and Secure Cross Tube.** Slide tubular cross member and case assembly into position, and insert and secure three bolts, lock washers, and nuts holding cross member to each side rail.



PROPELLER SHAFT TO
FRONT AXLE

TRANSFER
CASE

RA PD 303916

Figure 102—Transfer Case Installed

c. **Install Propeller Shaft Brake.** Place brake disks in position in propeller shaft brake assembly, and connect small pull-back springs on brake shoes. Install companion flange at rear of hand brake, and install and tighten eight bolts, nuts, and cotter pins.

d. **Install Power Take-off.** Install rear support bearing cap and gasket and secure with two cap screws. Install power take-off to upper rear of transfer case housing and insert and tighten six lock washers and nuts. Install winch chain and secure with locking link and cotter pin.

e. **Install Speedometer Cable.** Install speedometer cable at fitting on housing and tighten coupling nut.

TRANSFER CASE

f. **Connect Linkage.** Connect shifting lever linkage rods to front axle shifting lever, winch drive lever, auxiliary range lever, and winch power take-off lever at their connections on the transfer case housing. Secure each with a clevis pin and cotter pin.

g. **Install Propeller Shaft.** Install propeller shaft to front axle at transfer case end (par. 100). Install propeller shaft from transmission to transfer case (par. 100). Fill transfer case to level plug with proper lubricant.

6-TON, 4 x 6 TRUCK (WHITE, CORBITT, AND BROCKWAY)

Section XXV

FRONT AXLE

	Paragraph
Description and tabulated data	104
Adjustments	105
Removal of front axle	106
Installation of front axle	107

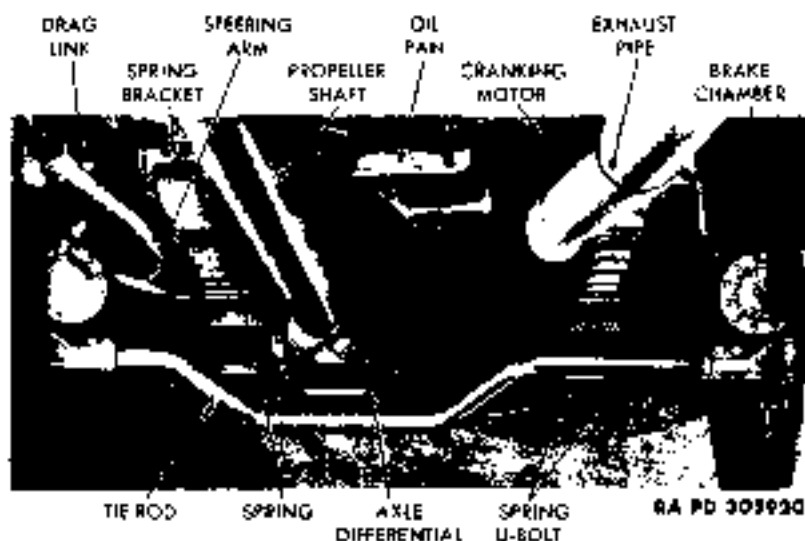


Figure 103—front Axle Installed (Rear View)

104. DESCRIPTION AND TABULATED DATA.

a. **Description.** The front axle is a driving unit of double-reduction type. The double reduction is accomplished by a spiral bevel pinion and ring gear in connection with spur gear second reduction. Power is transmitted to the front axle through a propeller shaft from the transfer case. The front wheels are driven through constant-velocity type steering drive joints.

b. **Tabulated Data.**

Make	Timken
Model	F-3100-W-X-6
Gear ratio	7.33 to 1

105. ADJUSTMENTS.

a. **Steering Knuckle Bearing Adjustments.** (Procedures apply to left front wheel.)

FRONT AXLE

(1) **DISCONNECT DRAG LINK.** Push emergency brake to full "ON" position. Remove cotter pin from screw plug at front end of drag link. Unscrew the adjusting plug and disconnect the steering arm and drag link.

(2) **REMOVE WHEEL.** Jack up left front wheel about three inches above floor. Remove wheel stud nuts and pull off wheel and tire assembly.

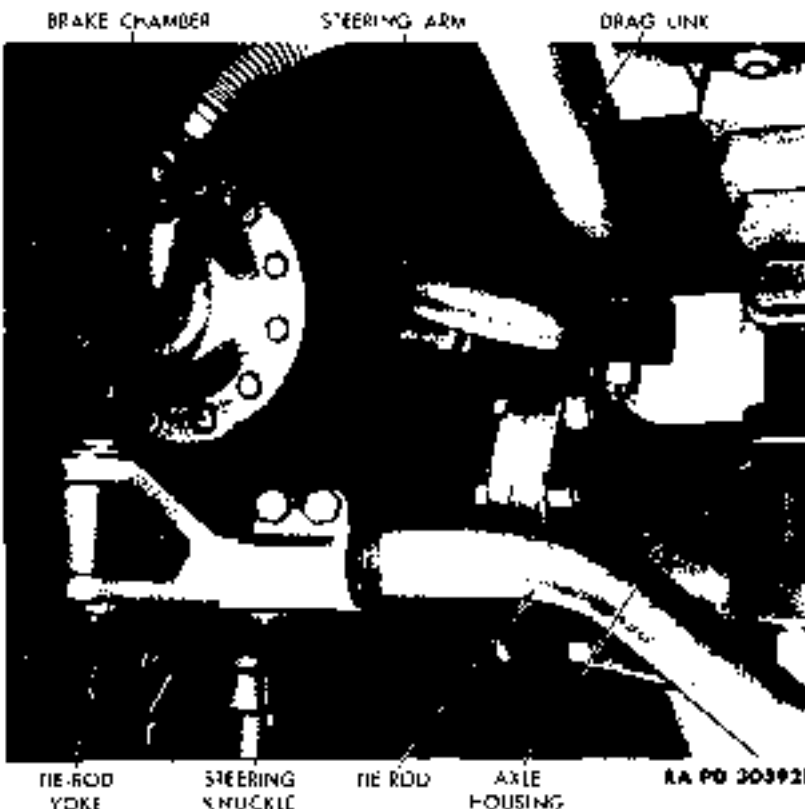


Figure 104—Left Wheel Tie-rod Yoke and Steering Knuckle

(3) **REMOVE AXLE FLANGE.** Remove eight nuts and lock washers from wheel driving flange studs. Every other stud in the driving flange has a tapered dowel. Loosen these by tapping the hub with a heavy hammer at a point close to each dowel, and pull them off studs. Unscrew and remove two cap screws and lock washers, then lift off drive shaft retainer. Using two cap screws from rear axle flange, insert and thread them through the axle flange, pulling the flange loose from the wheel hub.

6-TON, 6 x 6 TRUCK (WHITE, CORBITT, AND BROCKWAY)

(4) **REMOVE WHEEL BEARING NUTS.** Remove wheel bearing outer nut. Pull off outer nut washer and wheel bearing nut lock, prying loose with a small screwdriver. Remove adjusting nut from hub.

(5) **REMOVE HUB AND DRUM.** Pull hub and drum slightly outward to loosen outer wheel bearing, then pull off bearing. Slide wheel outward and off shaft.

(6) **REMOVE BRAKE SHOES AND BACKING PLATE.** Remove brake pull-back spring. Remove roller pin, unscrew and take off nut on anchor plate. Pull anchor plate which holds brake shoes. Slide two brake shoes off anchor pins. Remove four cap screws which hold backing plate to knuckle flange casting, then lift off two backing plates.

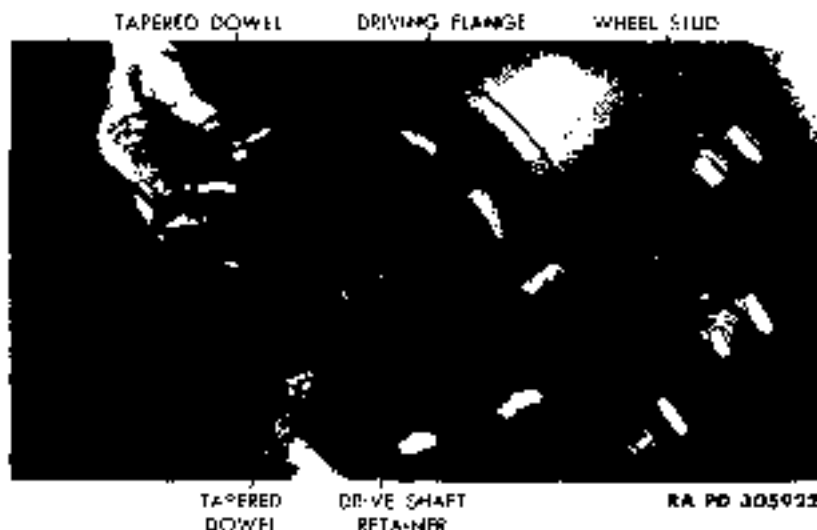


Figure 105—Removing Tapered Dowel

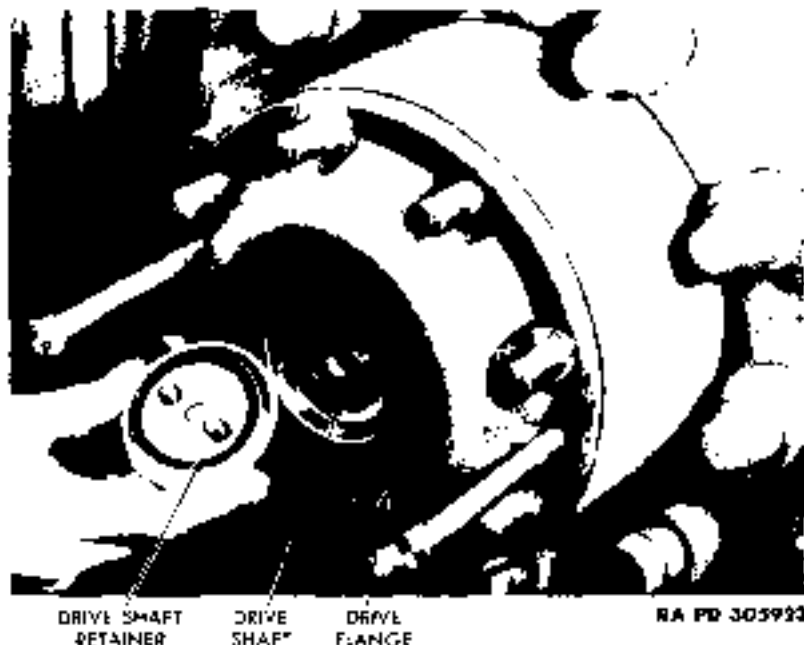
(7) **ADJUST BEARINGS.** Remove four nuts and lock washers and lift off steering arm and bearing cap assembly. Remove four cap screws and lock washers, and pull lower bearing cap off. Make adjustment of bearings by removing or adding to the number of shims under each cap.

(8) **ADJUSTMENT AND TEST.** There must be no end play of knuckle assembly after adjustment, but it must swing freely when the caps are replaced and drawn down tight. After this adjustment is obtained, remove caps and reduce shim pile 0.005 inch under each cap. This should result in a slight drag when rotating, but should not "bind." The thickness of the shim packs must be as close as possible to center the joint for shaft alignment.

FRONT AXLE

(9) **INSTALL BEARING CAPS.** Install upper and lower bearing caps. Install and tighten four lock washers and nuts on upper cap, and four cap screws and lock washers on lower cap.

(10) **INSTALL BACKING PLATE AND BRAKE SHOE ASSEMBLY.** Place upper and lower backing plates in position, insert and tighten four cap screws. Slide the two brake shoes into position on the anchor pins. Place anchor plate against them, install and tighten the nut, and secure it with a cotter pin. Install brake shoe pull back spring.



RA PD 305923

Figure 106—Removing Drive Shaft Retainer

(11) **INSTALL HUB AND DRUM.** Slide hub and drum into position on hub, then push outer wheel bearing into position in hub. Start bearing adjusting nut on shaft and pull down until the wheel beads slightly when spun slowly. Back off the nut $\frac{1}{4}$ turn. Place lock ring in position in slot, and on special lug. Install and tighten bearing outer nut.

(12) **INSTALL AXLE FLANGE AND WHEEL.** Push axle flange into position over studs, and insert tapered dowels into every other hole.

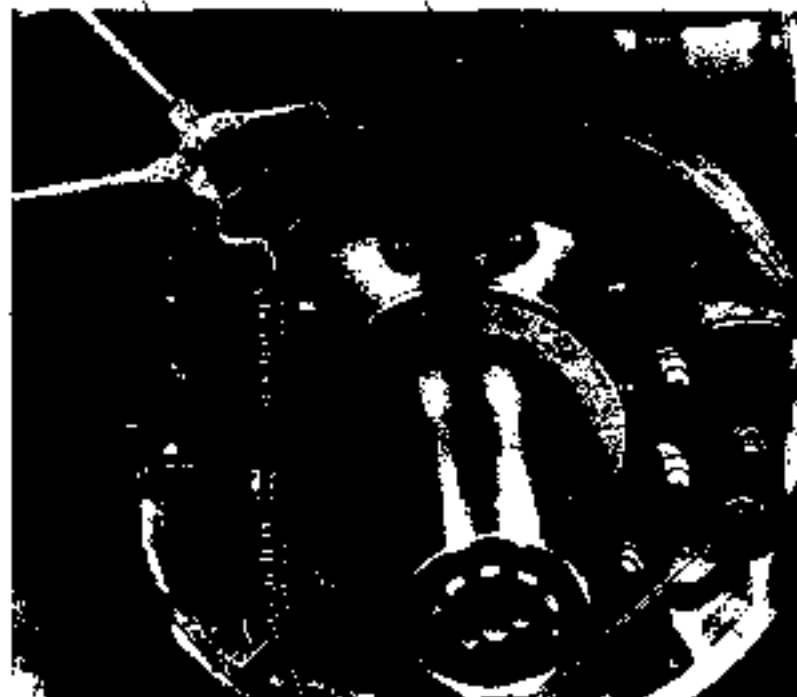
6-TON, 6 x 6 TRUCK (WHITE, CORBITT, AND BROCKWAY)

Install eight flange stud nuts and pull down tightly. Install drive shaft retainer, and insert and tighten two rap screws. Place wheel and tire assembly on wheel studs and secure with stud nuts.

(13) **CONNECT DRAG LINK.** Connect drag link and steering arm by inserting ball into socket and tightening adjusting plug until tight, then back off enough to insert locking cotter pin in its slot. Lower jack and remove from under vehicle.

BRAKE SPRING PLIERS

BRAKE SHOE

BRAKE
CAMSHAFTBRAKE
PULL BACK SPRINGANCHOR PIN
PLATE

RA PD 305924

**Figure 107—Removing Brake Pull-back Spring
with Pliers 41-P-1579**

b. Toe-in Adjustment.

(1) **DESCRIPTION.** Toe-in, as its name implies, is the amount which wheels point inward at the front. This is necessary to offset excessive tire wear caused by camber. The proper toe-in is $\frac{1}{8}$ inch to $\frac{3}{16}$ inch.

(2) **ADJUSTMENT.** Adjustment is made by lengthening or shortening the tie rod assembly which is equipped with a threaded yoke on each end. Each end has different pitch threads for a fine or coarse adjustment.

FRONT AXLE

(a) *Coarse Adjustment.* Remove right-hand yoke pin by unscrewing retaining nut and tapping pin from yoke. Loosen lock nut and binder bolts. Insert tapered bar through yoke, and turn one complete turn in or out as required.

(b) *Fine Adjustment.* For a fine adjustment, it is necessary to make one complete turn of the tie rod, as follows: Disconnect right-hand yoke and loosen lock nut and binder bolts on left yoke. Swing right-hand yoke toward rear of truck about 18 inches. Hold right



Figure 108—Removing Steering Arm and Bearing Cap Assembly

yoke rigid and turn center of rod one complete turn in the desired direction. This will increase or decrease its effective length, which should be adjusted to accomplish specified toe-in. After desired toe-in has been attained, install all bolts, washers, and nuts, and tighten. **NOTE:** Always check toe-in after any alterations in tie rod assembly.

c. *Wheel Bearing Adjustment.*

(1) **REMOVE AXLE FLANGE.** Jack up axle until wheel is off ground. Remove eight nuts and lock washers from driving flange studs. Loosen tapered dowels in flange by tapping hub with hammer at a point close to each dowel. Pull dowels off studs. Remove two

6-TON, 6 x 6 TRUCK (WHITE, CORBITT, AND BROCKWAY)

cap screws and lock washers which secure drive shaft retainer and remove retainer. Using two long cap screws from rear axle flange, thread them through special puller holes in flange and pull flange loose from wheel hub.

(2) **REMOVE JAM NUT AND WASHER.** Unscrew wheel bearing jam nut (outer nut), and remove. Remove jam nut washer and wheel bearing nut lock ring.



RA PD 305926

Figure 109—Tightening Wheel Bearing Nut, Using Wrench 41-W-3825-124 (Front) or Wrench 41-W-3825-70 (Rear)

(3) **ADJUST WHEEL BEARING.** Spin the wheel slowly and tighten adjusting nut until wheel binds slightly when rotated. Then back off nut $\frac{3}{8}$ turn. Place lock ring in position in slot and on special lug. Install and tighten jam nut and washer with wheel bearing nut wrench. Spin wheel and recheck it for binding.

(4) **INSTALL AXLE FLANGE.** Push axle flange into position over studs and install tapered dowels over every other stud. Install eight flange stud nuts and pull down tightly. Install drive shaft retainer and secure it with two lock washers and cap screws. Lower wheel to floor and remove jack.

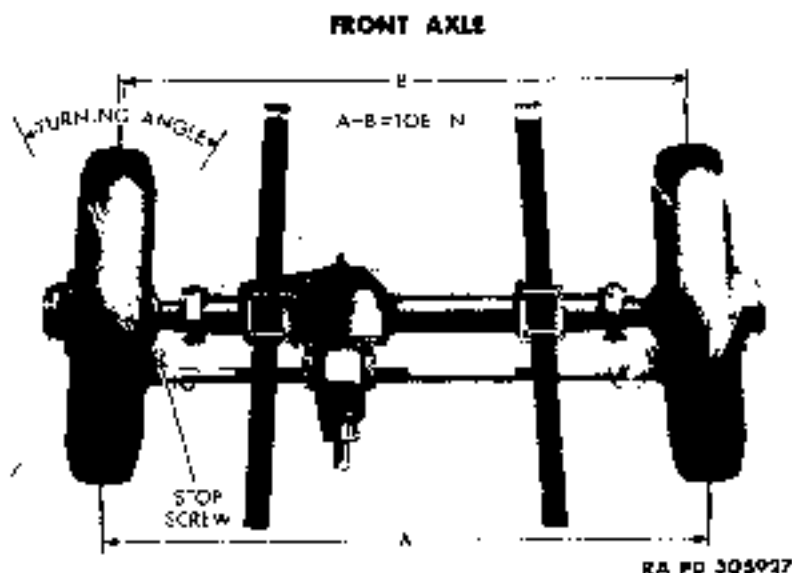


Figure 110—Front Wheel Toe-in and Turning Radius

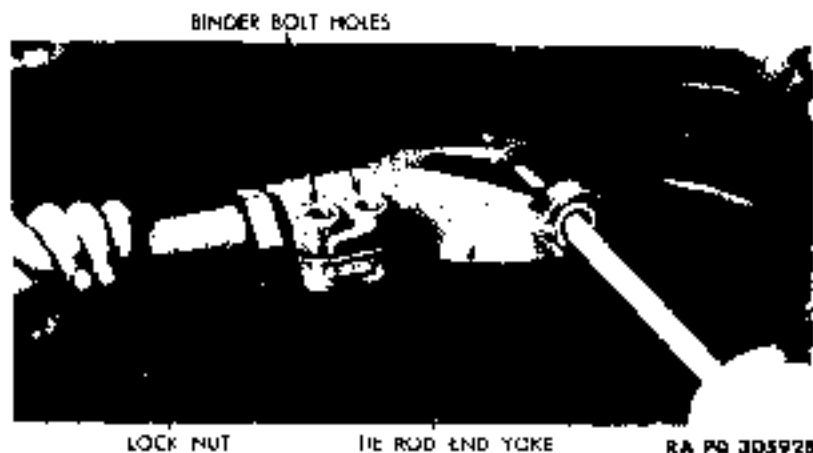


Figure 111—Turning Tie Rod End Yoke to Adjust Toe-in

106. REMOVAL OF FRONT AXLE.

a. **Prepare Vehicle for Work.** Locate vehicle on level spot, block rear wheels securely and push hand brake lever to full "ON" position.

b. **Disconnect Brake Lines and Drag Link.** Unscrew coupling nuts and disconnect brake air lines at diaphragm connections. Re-

6-TON, 6 x 6 TRUCK (WHITE, CORBITT, AND BROCKWAY)

move cotter pin, unscrew adjusting plug and lift drag link from the steering arm ball on front axle.

c. **Disconnect Front Axle Propeller Shaft.** Place a support under differential housing, immediately in front of the universal joint. Loosen dust cap on propeller shaft slip joint to allow some movement for the disassembly of universal joint. Remove only the bearings and parts used in the yoke attached to the front axle. Bend down locking lug on lock plate at each side of yoke. Remove two

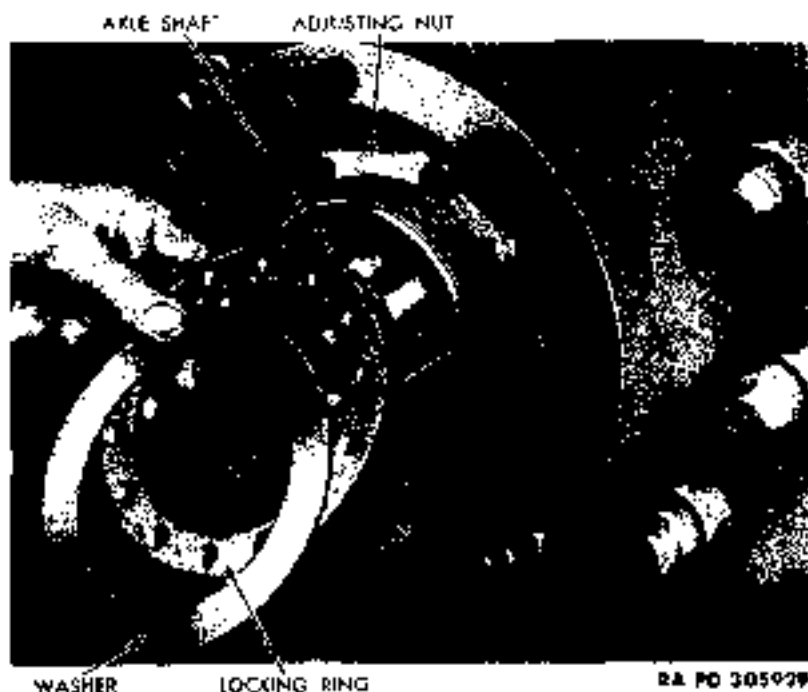


Figure 172—Removing Locking Ring and Washer

cap screws from each side and lift bearing caps from assembly. Tap lightly with small ball peen hammer on exposed face of either needle bearing cage until opposite bearing assembly comes out. Tap lightly on exposed shaft until remaining bearing is free, then remove bearing. Slide journal (center cross) to either side as far as possible. Tip one end of journal to clear lug on yoke and remove journal. Support disconnected propeller shaft with a rope or wire sling to keep it free of floor.

d. **Remove Axle.** Remove eight U-bolt nuts and washers. Using two heavy-duty jacks located on each side of chassis frame at rear of front spring bracket, raise front of vehicle until U-bolts pull free

FRONT AXLE

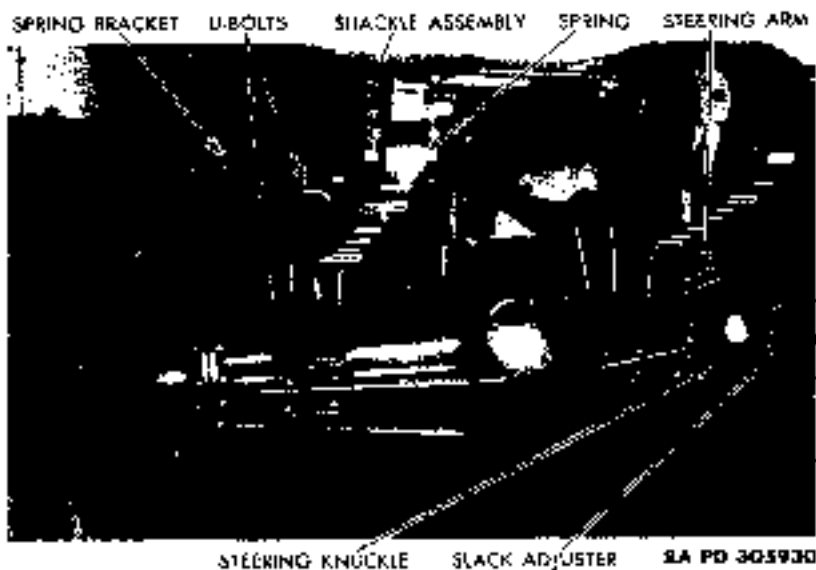


Figure 113—Front Axle Assembly, Disconnected

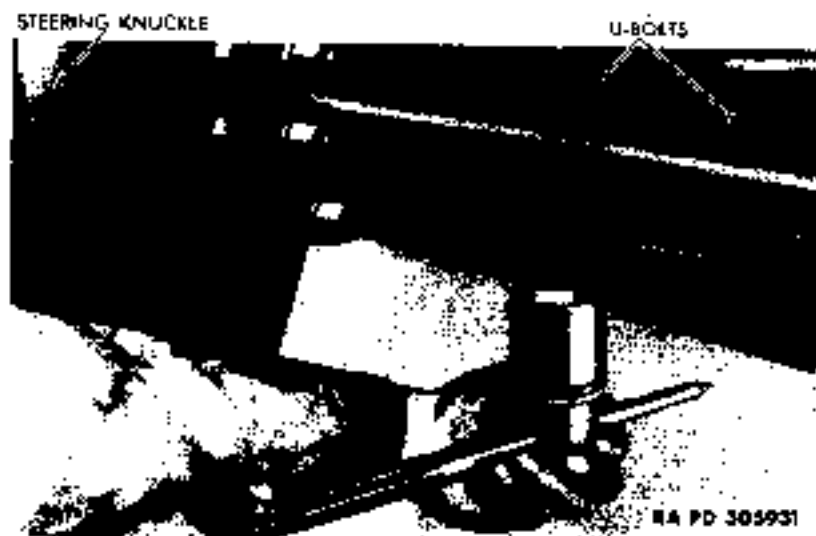


Figure 114—Tightening Spring U-bolts

6-TON, 6 x 6 TRUCK (WHITE, CORBITT, AND BROCKWAY)

of spring seats on top of axle housing. Support chassis in this position, using steel jack stands or horses. Roll axle straight forward until clear of vehicle and place on a suitable support for removal of wheels and tires. Using a wheel stud nut wrench, remove ten stud nuts from each wheel, and remove wheels.

107. INSTALLATION OF FRONT AXLE.

a. **Install Wheels on Axle.** With axle assembly on suitable support, install wheels using wheel stud nut wrench to secure ten nuts on each wheel.



Figure 175—Installing Brake Line at Diaphragm

b. **Install Axle in Chassis.** Lower wheel and axle assembly to floor in front of vehicle in proper alignment with chassis, and roll slowly under chassis until in position for installing. Lower both chassis jacks and move the axle assembly into final position so that the head of each spring bolt at center of springs will fit into recess provided in spring seats.

c. **Connect Propeller Shaft.** Upon first contact of the springs with the spring seats, and before weight is put upon the axle, the universal joint at the rear of the axle center should be connected. Remove propeller shaft from sling and guide one end of the exposed journal shaft into and through one side of the yoke at the rear of the axle center. Push the other journal shaft into the yoke, and center the shafts in the yoke. After determining satisfactory condition of the needle bearing assemblies, push them into position over

FRONT AXLE

the shafts and inside the yoke ends. Install bearing caps and locking plate and secure by inserting and tightening two cap screws. Pry up locking lugs with screwdriver.

d. **Install Spring U-bolts.** Insert spring U-bolts into spring seat. Then install and tighten eight lock washers and nuts, securing the springs to the axle. Lower chassis evenly on both sides until the full weight of the vehicle rests on the axle.

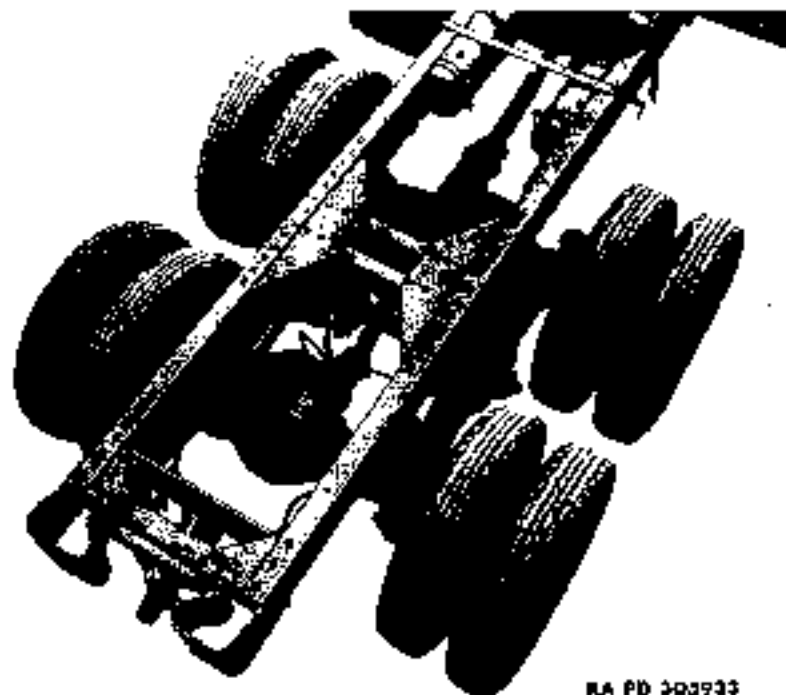
e. **Install Steering Attachments and Brake Lines.** Connect the drag link and steering arm, pushing ball into drag link socket, then adjust, running adjusting plug down tight, then backing off until locking cotter pin can be secured in slot. Connect brake air line fittings, and tighten coupling nut at diaphragm connections.

6-TON, 6 x 6 TRUCK (WHITE, CORBITT, AND BROCKWAY)

Section XXVI

REAR AXLE

	Paragraph
Description and tabulated data	108
Maintenance and adjustments	109
Axle shaft removal and installation	110
Spring seat removal and installation	111
Torque rod removal and installation	112
Removal of rear axle	113
Installation of rear axle	114



RA PD 303933

Figure 116—Rear Axle Bogie Installed

108. DESCRIPTION AND TABULATED DATA.

a. *Axles.* The tandem driving axle units are of the double-reduction, full-floating type. The double reduction is accomplished by a spiral bevel pinion and ring gear in connection with spur gear second reduction, the pinion gear being spline mounted on a shaft which extends through the carrier housing. The two carrier assem-

REAR AXLE

blies are identical except that on the rearward rear axle, a long cap is used over the rear end of the pinion shaft.

b. **Torque Rods.** Since the springs are of the slipper type, the axles are held in place by torque rods. Eight rods are used, four above and four below the axles. The upper ones are adjustable for alignment purposes.



RA PD 303934

Figure 117--Removing Rear Wheel and Tire

c. **Tabulated Data.**

Make	Timken
Model	SD-353 W-X 7
Gear ratio	7.33 to 1

6-TON, 6 x 6 TRUCK (WHITE, COBBIT, AND BROCKWAY)

109. MAINTENANCE AND ADJUSTMENTS.

a. **Rear Axle Alignment (Torque Rod Adjustment).** Measure the length of each of the upper or adjustable torque rods. This length from center to center of pin should be 26¾ inches. If one is found to be out of adjustment, proceed as follows: Loosen binder bolt nut on each end of rod. Turn torque rod to right or left, until proper adjustment is obtained. Tighten binder bolts.



Figure 178—Tightening Spring Seat Nut

b. **Spring Seat Adjustment.**

(1) **REMOVE WHEELS.** Block opposite side wheels, then jack up both rear axles. Loosen and remove outer wheel nuts with special outer wheel hex head nut wrench. Note that threads on wheels on left side of truck loosen with reverse action to those on right side of truck. Place a heavy pinch bar under the tire and lift slightly. At the same time grasp the top of the tire and pull outward. Loosen inner wheel centering nuts with special square head inner wheel nut wrench. Remove nuts and wheel as described before. **NOTE:** The bridge erection truck rear wheels are provided with a four-inch spacer between the wheels to accommodate the larger tires used. In removing the wheels of this vehicle, remove the spacer before removing the inner wheel. When installing wheels, be sure to center spacer between wheels.

REAR AXLE

(2) **ADJUST SPRING SEAT.** Remove binder bolt nut on spring seat at end of cross tube. Push out binder bolt and remove locking key. Insert pinch bar in binder bolt hole and tighten nut until there is no end play in the seat, and the slot in the nut lines up with one of the slots in the tube. Insert locking key, lining up the hole in key with binder bolt hole. Install binder bolt and nut, and tighten.

(3) **INSTALL WHEELS.** After placing inner wheel in an upright position close to axle flange, use a heavy pinch bar under the tire to lift and guide wheel into position over wheel studs, being careful not to damage threads on studs. With special square head inner wheel nut wrench, pull these nuts tight, alternating with every other



DRIVING FLANGE

RA PD 305936

Figure 119—Removing Rear Axle Shaft

nut, and making certain that they are centering in the tapered holes in the wheel. Install the outer wheel as described, pulling outer wheel nuts tight with special hex head wrench. Remove jacks and blocks. Check spring seat for proper quantity of lubricant.

c. Rear Wheel Bearing Adjustment.

(1) **REMOVE SHAFT AND LOCK NUT.** Jack up axle and remove shaft (par. 110). Remove excess grease. Unscrew and remove outer lock nut and lock washer.

(2) **ADJUST WHEEL BEARING.** Tighten the adjusting nut, turning it up tight against the outer bearing, so that the wheel binds, at the same time revolving the wheel to assure full bearing contact. Back off nut enough to allow wheel to rotate freely, but without end play.

6-TON, 6 x 6 TRUCK (WHITE, CORBITT, AND BROCKWAY)

(3) **TEST ADJUSTMENT.** Using a pinch bar, pry the bottom of the wheel up and down while holding a finger on the outer bearing cage. If a very slight movement can be felt and the wheel can be rotated freely, the adjustment is correct. Proper adjustment is 0.003 to 0.005-inch loose.

(4) **INSTALL LOCK NUT AND AXLE SHAFT.** Install and tighten lock washer and lock nut. Again test adjustment with bar. Cover end of axle tube and lock nuts with proper lubricant. Install axle shaft (par. 110).

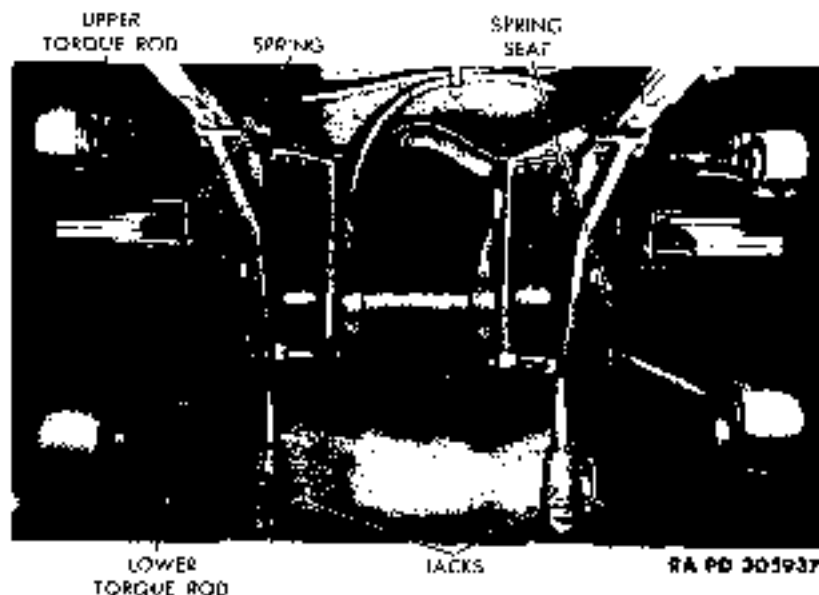


Figure 120—Spring Seat Removal

110. AXLE SHAFT REMOVAL AND INSTALLATION.

a. **Removal.** Unscrew and remove drive flange stud nuts. Loosen tapered dowels by tapping flange lightly with hammer, and pull off studs. Loosen lock nuts on flange puller screws. Loosen axle shaft by turning in two puller screws. Use pinch bar to start shaft, then pull out carefully, keeping shaft assembly from dropping to floor.

b. **Installation.** Push shafts into housing until splines engage with splines in differential center. Unscrew puller screws on flange. Tighten lock nut on lock puller screws. Insert tapered dowels and tighten flange by tightening eight lock washers and nuts.

111. SPRING SEAT REMOVAL AND INSTALLATION.**a. Removal.**

(1) **RIGIDITY TUBE NUT.** Support cross tube on two hydraulic jacks (fig. 116). Remove wheels (par. 126). Unscrew and remove

REAR AXLE

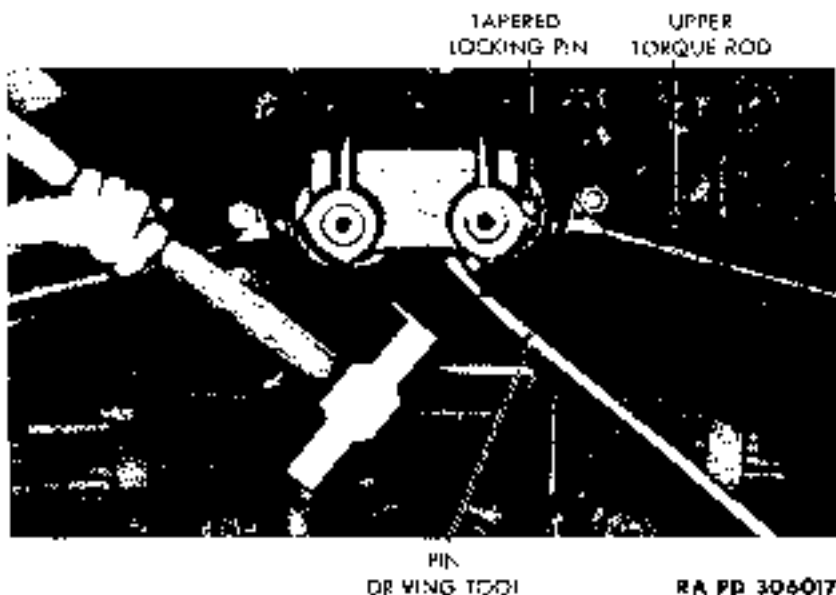


Figure 121—Driving Out Tapered Locking Pin

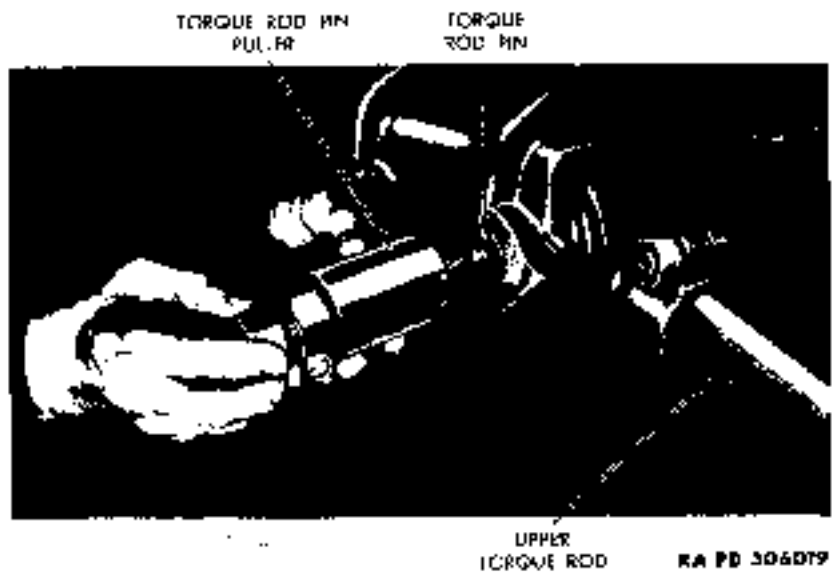


Figure 122—Installing Puller on Upper Torque Rod Pin

4-TON, 6 x 6 TRUCK (WHYTE, CORBITT, AND BROCKWAY)

binder bolt nut. Push out binder bolt and lift out locking key. Insert pinch bar in binder bolt, and loosen and remove tube nut. Remove gasket and washer from cross tube.

(2) **REMOVE SPRING SEAT.** Loosen two spring seat binder bolts. Unscrew and remove eight spring clip nuts and washers. Insert pinch bar between spring and seat, and lift out spring clips. Slide spring seat off tube.

LOWER TORQUE ROD



TAPERED TOOL

R&PD 306007

Figure 123—Removing Lower Torque Rod at Anchor End with Remover 41-R-2372-562

b. Installation.

(1) **INSTALL SPRING SEAT.** Lift spring clips up against frame bracket, and slide spring seat on tube. Drop spring clips into place and install four lock washers and four nuts. Install and tighten four jam nuts. Tighten spring seat binder bolts. Place large washer and gasket over tube.

(2) **INSTALL TUBE NUT.** Install tube nut, then insert dowel in nut in hole in washer. Tighten nut, turning with tapered bar in binder bolt hole until there is no end play, and the slot in the nut lines up with one of the slots in the tube. Insert locking key, binder bolt, and nut, and tighten. Install wheels (par. 126). Jack up vehicle, remove horses, and lower vehicle to floor.

REAR AXLE

112. TORQUE ROD REMOVAL AND INSTALLATION.

a. **Remove Upper Rod.** Disconnect outer end of upper rod (par 113). Using a pin or punch (fig. 121), drive tapered dowel from inner end rod anchor pin. Install puller (41-P-2956-8) (fig. 122), and pull anchor pin from bracket. Remove rod from vehicle.

b. **Remove Lower Rod.** Disconnect outer end of lower rod (par. 113). Remove cutter pin and nut from lower rod inner end anchor pin. Place tool between rod end and bracket (fig. 123) and drive in to loosen rod end from pin. Pull rod from pin and remove rod from vehicle.



UPPER TORQUE ROD

TAPERED TOOL

RAPD 306003

Figure 124—Prying Off Outer End of Upper Torque Rod with Remover 41-R-2372-262

113. REMOVAL OF REAR AXLES.

a. **Lift Vehicle and Remove Air Lines.** Block both front wheels, front and rear. Lift entire rear of vehicle until all weight is off springs. Unscrew coupling nut at center of air line junction block at top center of each axle and pull off air lines.

b. **Disconnect Propeller Shafts.** Disconnect transfer case to forward rear axle propeller shaft at axle end (par. 100). Disconnect and remove interaxle propeller shaft (par. 100).

6-TON, 6 x 6 TRUCK (WHITE, CORBITT, AND BROCKWAY)

c. **Disconnect Upper Torque Rods.** Bend back locking lug on upper torque rod pin nut (above spring seat). Unscrew nut, and pull nut and lock from pin. Pry torque rod from pin, using tool as shown (fig. 124). Repeat this operation for each upper torque rod outer end.

d. **Disconnect Lower Torque Rods.** Remove cotter pin from outside nut on outer lower torque rod pin, and loosen nut. Remove cotter pin from inside nut, unscrew and remove nut. Slip special

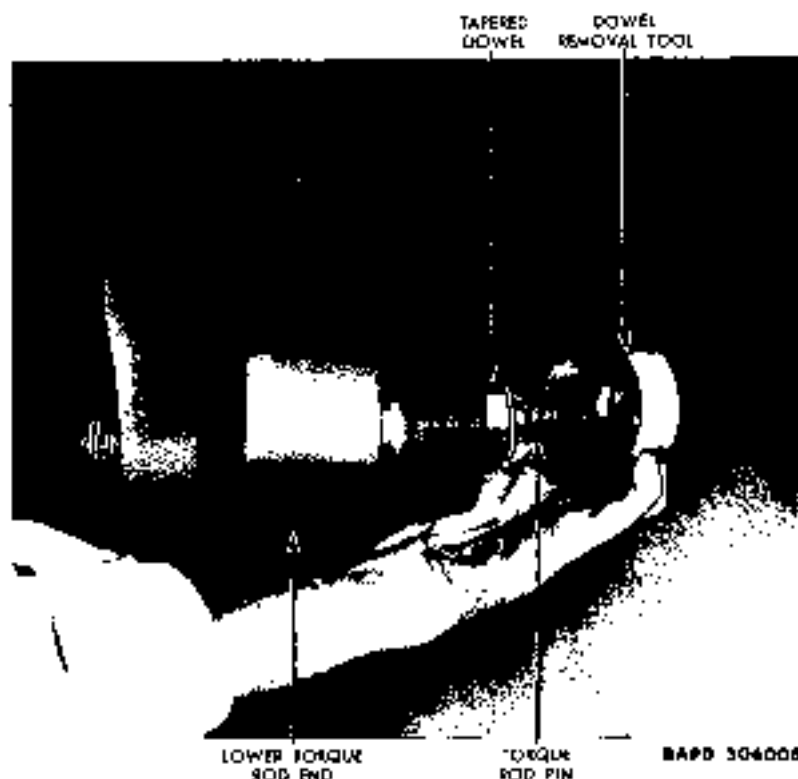


Figure 125—Installing Remover 41-R-2372-555

tool (fig. 125) over pin (as a puller). Screw inner nut on again and tighten about three turns. Unscrew and remove nut. Pull off washer and tool, and lift off tapered dowel. Remove outside nut, install inside nut about five turns, and use pinch bar to pry pin from lower torque rod. Repeat this action for each lower torque rod outer end.

e. **Remove Axles.** Hoist rear of vehicle high enough to allow the removal of forward axle, and roll axles out from chassis.

REAR AXLE

114. INSTALLATION OF REAR AXLES.

a. **Place Axles in Position.** Roll axles into position under chassis. Lower chassis, putting torque rod arms as close as possible to assembly position with pins on the axle.

b. **Install Lower Torque Rods.** Insert lower torque rod in bracket and push in pin (with taper toward outside of vehicle). Install washer and nut on outside of pin. Install tapered dowel, washer, and nut, and tighten nut to press in dowel. Back off nut slightly. Tighten outer nut and secure with a cotter pin. Tighten inner nut and secure with a cotter pin. Repeat this operation for each lower torque rod outer end.

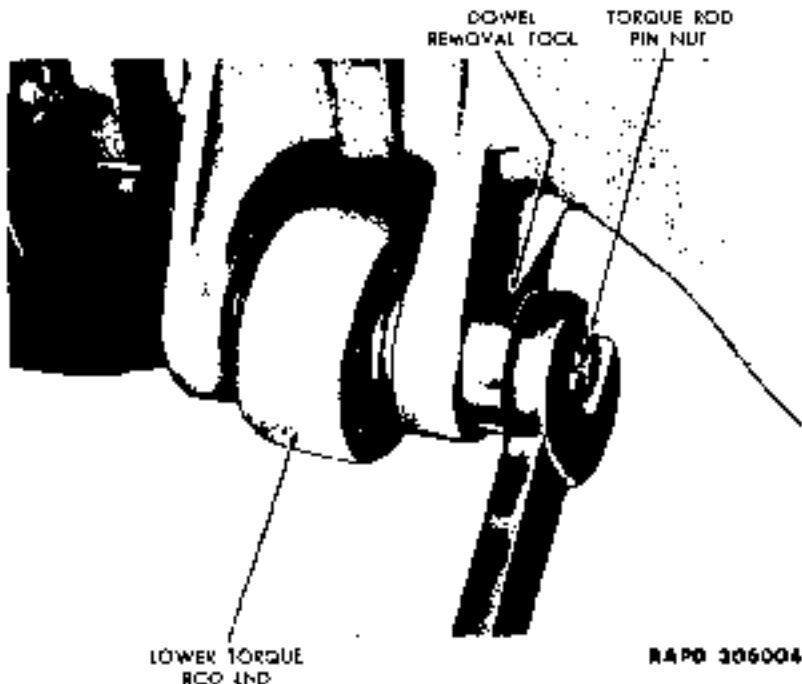


Figure 126—Pushing Tapered Dowel from Lower Torque Rod with Remover 47-R-2372-555

c. **Install Upper Torque Rods.** Push upper torque rod on axle pin. Install and tighten expander bolt and lock. Repeat this operation for each upper torque rod outer end.

d. **Install Propeller Shafts.** Install interaxle propeller shaft. Install transfer case to rear axle propeller shaft (par. 100).

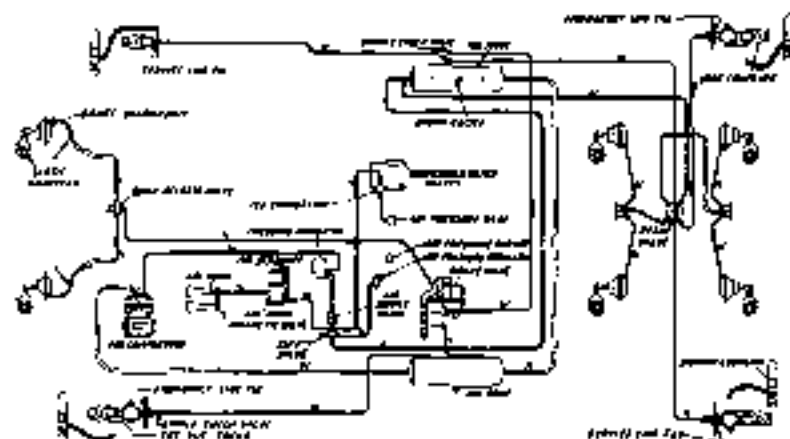
e. **Install Air Lines.** Install air lines to junction block at top center of each axle, and tighten coupling nut. Lower vehicle to ground. Remove blocks from front wheels.

6-TON, 6 x 6 TRUCK (WHITE, CORBITT, AND BROCKWAY)

Section XXVII

BRAKE SYSTEMS

	Paragraph
Description and tabulated data	115
General maintenance	116
Air compressor	117
Controls	118
Regulators	119
Service brakes	120
Service brake adjustments	121
Propeller shaft brake	122
Electric trailer brake controls	123



EA PD 303740

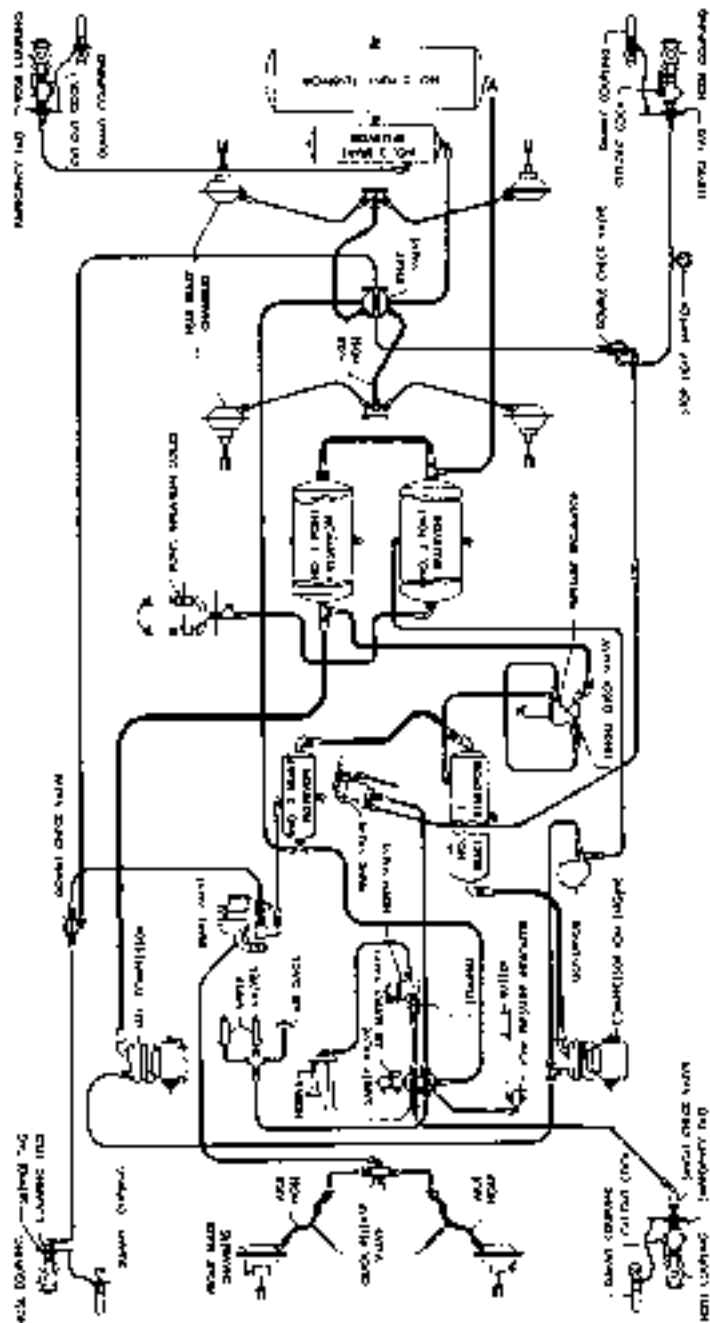
Figure 127—Prime Mover and Cross Trucks
Air Brake System Diagram

115. DESCRIPTION AND TABULATED DATA.

a. **Air Brake System.** The compressor, governor, gage and safety valve are air-controlled devices used to build up and maintain air pressure in the reservoirs, so that this pressure is constantly held within the normal range for efficient brake operation. The brake valve and relay valve are "application" devices to control air pressure delivered to the brake chambers. The brake diaphragm chambers convert the energy of compressed air into mechanical energy, operating the brake cams and brakes. The brakes are applied and released by depressing and releasing the brake pedal.

b. **Propeller Shaft Brake.** This brake is a four-shoe disk type, and is mounted on a cross member to the rear of the transfer case,

BRAKE SYSTEMS



NA PD 303845

Figure 128—Bridge Erection Truck Air Brake System Diagram

6-TON, 6 x 6 TRUCK (WHITE, CORBITT, AND BROCKWAY)

with the brake disk mounted on the propeller shaft companion flanges. The brake is operated by a ratchet handle extending into the vehicle cab. When pushed forward to "ON" position, the lever, through linkages, forces the four shoes tightly against the brake disk, holding it and the vehicle stationary.



Figure 729—Air Compressor Installed

c. Tabulated Data.

Air brake system compressor:

Make	Bendix-Westinghouse
Compressor model	2UE-12-VW
Operating pressure	85-105 lb

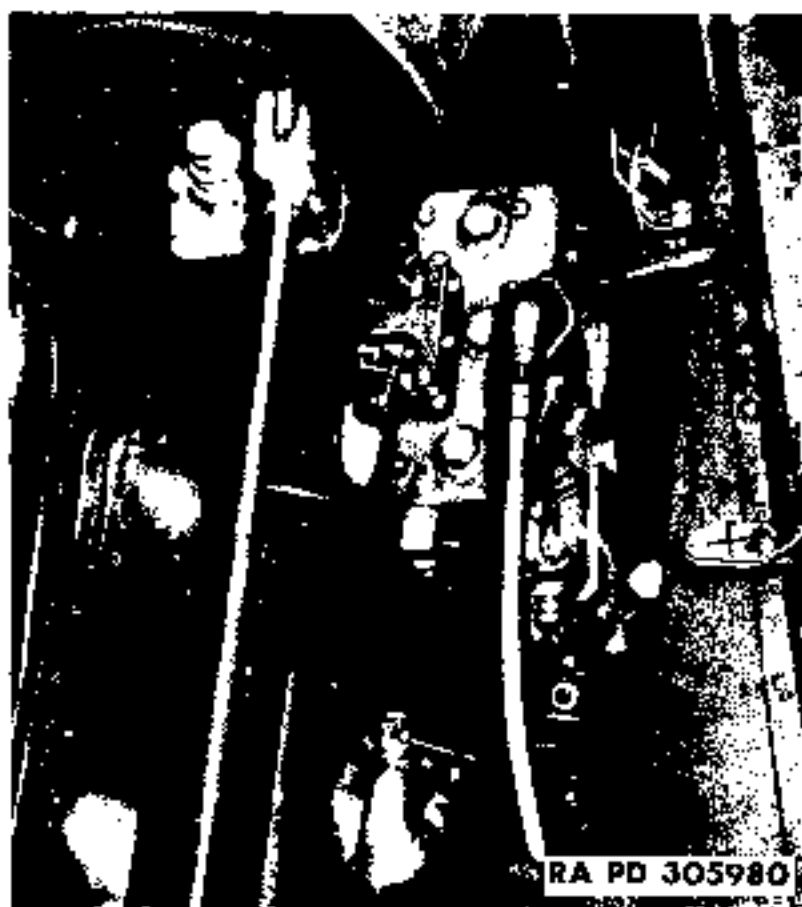
Auxiliary compressor (bridge erection truck only):

Make	Bendix-Westinghouse
Model	SA-1518-t
Operating pressure	85-105 lb

Propeller shaft brake:

Make	American Chain & Cable Co.
Model	L 5504
Type	4-shoe disk

BRAKE SYSTEMS



*Figure 130—Auxiliary Air Compressor Installed
(Bridge Erector Truck Only)*

116. GENERAL MAINTENANCE.

a. **Lines and Connections.** Drain each reservoir daily, removing any condensation collected in reservoirs. This condensation collecting in lines or valve and regulator assemblies, will cause corrosion and rust, and will generally decrease efficiency of the system. When testing for leakage, apply brakes, use soapuds on lines and connections. Lines or hoses found defective should be replaced at once. Fittings should be checked and tightened at regular intervals.

6-TON, 6 x 4 TRUCK (WHITE, CORBITT, AND BROCKWAY)**117. AIR COMPRESSOR.**

a. **Description.** The air compressor is a three-cylinder, water-cooled unit. It is mounted on the left front side of the engine, and is driven from the timing gear train. It is connected to the engine lubricating system, and oil under pressure is fed to its bearings.

b. Removal and Installation.**(1) REMOVAL.**

(a) **Disconnect Drive and Lines.** Remove cotter and locking pin, then lift off chain from sprockets on compressor drive coupling. Unscrew coupling nuts and disconnect all lines on compressor.

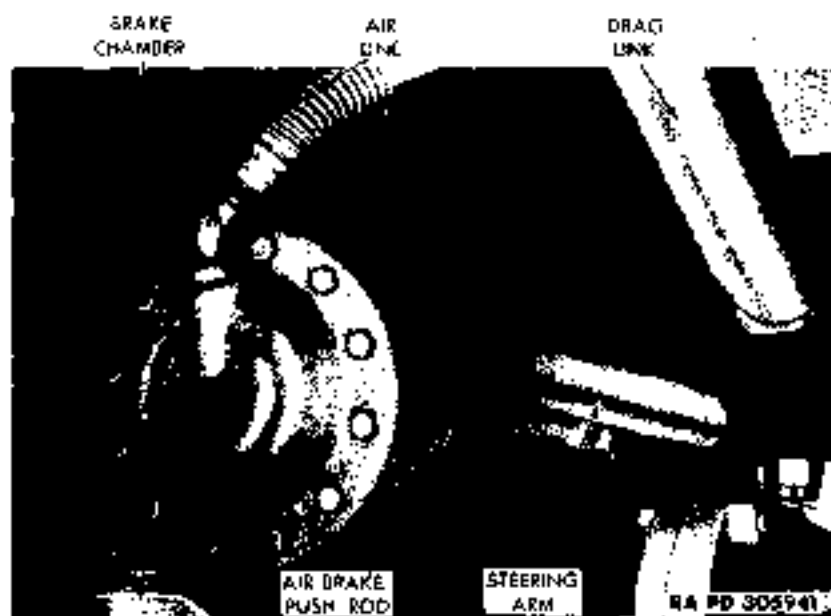


Figure 137—Brake Chamber Installed

(b) **Remove Compressor.** Unscrew and remove 6 cap screws and 12 washers (6 plain, 6 lock washers) holding compressor to engine assembly, then lift compressor from its supporting bracket.

(2) INSTALLATION.

(a) **Install Compressor.** Install new gasket and place compressor in position on bracket at left side of engine. Insert and tighten 6 cap screws and 12 washers (6 plain, 6 lock washers).

(b) **Install Drive and Lines.** Install coupling chain over sprockets and secure with locking pin and cotter pin. Connect all line fittings on compressor and tighten coupling nuts.

BRAKE SYSTEMS

11B. CONTROLS.

a. Brake Chamber.

(1) **DESCRIPTION.** The brake chamber diaphragm converts the energy of compressed air into mechanical force through a push rod which operates the slack adjuster, the brake camshaft, and cam, pressing the brake linings against the brake drum of each wheel.

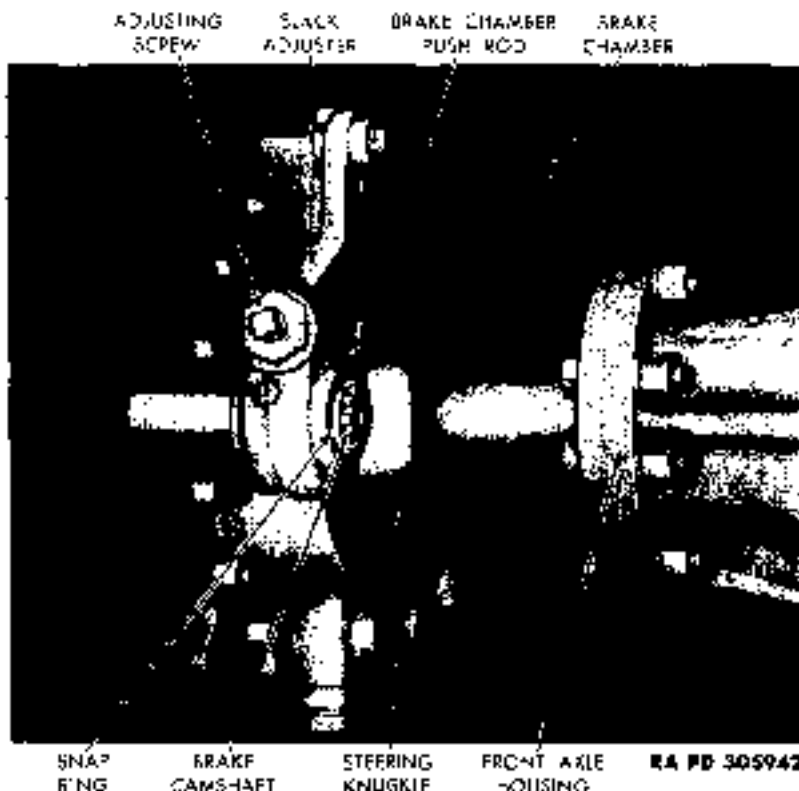


Figure 122—Slack Adjuster Installed

(2) REMOVAL OF BRAKE CHAMBERS.

(a) **Front Wheel Brakes (2).** Unscrew coupling nut and disconnect air line from quick release valve at coupling at top rear of unit. Pull out cotter pin and clevis pin at fitting on slack adjuster. Unscrew two nuts and lock washers holding diaphragm assembly to bracket at inside of wheel and lift off diaphragm.

(b) **Rear Wheel Brakes (4).** Unscrew coupling nut and disconnect air line from relay valve at coupling on rear of diaphragm. Pull out cotter pin and clevis pin at fitting on slack adjuster.

6-TON, 6 x 6 TRUCK (WHITE, CORBITT, AND BROCKWAY)

Unscrew four nuts and lock washers which hold assembly to bracket on axle, and lift assembly from vehicle.

(3) INSTALLATION OF BRAKE CHAMBERS.

(a) *Front Wheel Brakes (2).* Install diaphragm assembly on bracket at inside of wheel. Install and tighten two lock washers and nuts on bolts holding assembly to bracket. Install clevis pin at slack adjuster fitting and secure with cotter pin. Connect and tighten air line coupling nut at brake chamber fitting.

(b) *Rear Wheel Brakes (4).* Install diaphragm assembly to axle bracket. Insert and tighten four bolts, lock washers, and nuts. Install clevis pin at slack adjuster fitting and secure with cotter pin. Connect and tighten air line coupling nut on rear of diaphragm.

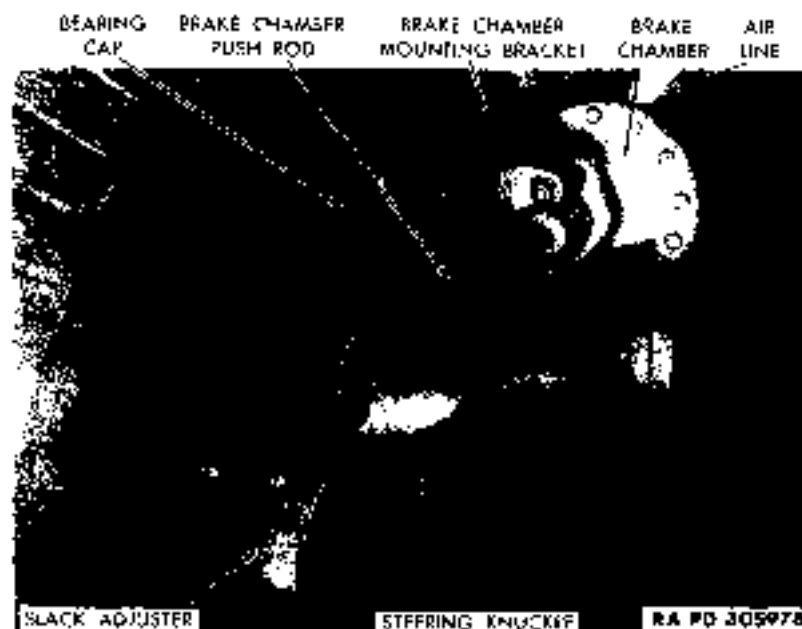


Figure 133—Brake Chamber and Slack Adjuster Installed

b. Slack Adjusters.

(1) **DESCRIPTION.** This is an adjustable lever, using a worm-and-gear mechanism to adjust cam thrust against the brake shoes. It provides an accurate adjustment of brake operation.

(2) **REMOVAL OF SLACK ADJUSTERS.** Remove cotter pin and clevis pin on clevis at slack adjuster arm. Remove snap ring (front wheels) or cotter pin and washer (rear wheels). Tap camshaft and pull slack adjuster from assembly.

BRAKE SYSTEMS

(3) **INSTALLATION OF SLACK ADJUSTERS.** Push assembly on over splines of camshaft, and install snap ring (front wheels) or washer and cotter pin (rear wheels), securing assembly on shaft. Line up hole in adjuster arm with holes in clevis, insert clevis pin and secure with a cotter pin.

c. Brake Camshaft and Cam.

(1) **DESCRIPTION.** The camshafts and cams transfer the action of the brake chamber and slack adjuster to the brake shoes inside the brake drum.

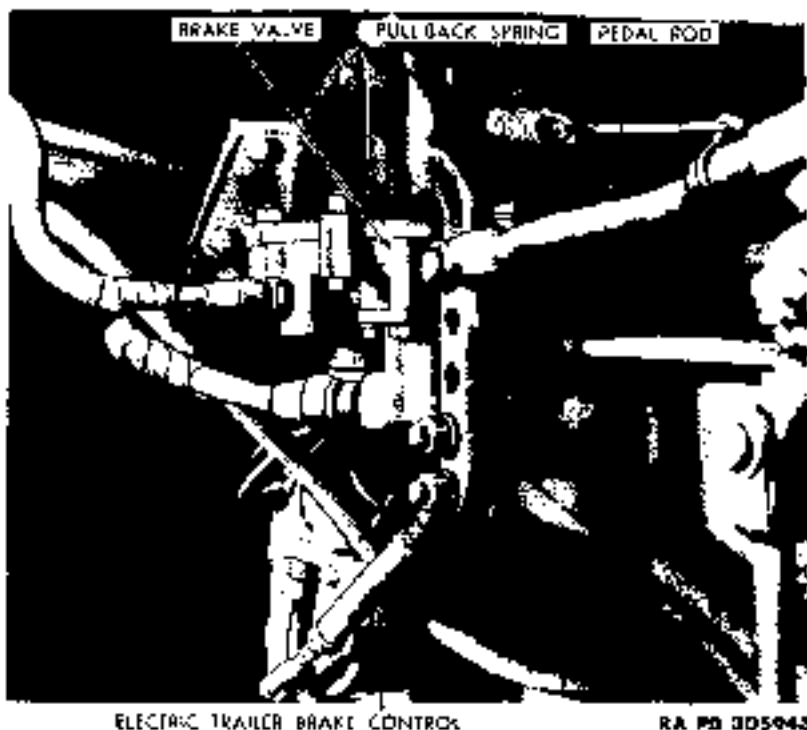


Figure 134—Brake Valve Installed

(2) **REMOVAL OF CAMSHAFT.** Remove wheel and hub assembly (par. 126). Remove slack adjuster. Unhook brake pull-back spring. Pull shaft from housing, toward outside of vehicle.

(3) **INSTALLATION OF CAMSHAFT.** Push shaft into position in housing, with brake cam in position between brake shoe ends. Hook brake pull back springs in place. Install slack adjuster. Install and adjust wheel and hub assembly (pars. 105 and 109).

d. Foot Pedal and Linkage. The foot pedal is connected on its cross shaft (mounted on left side rail) to the air brake valve. The

6-TON, 4 x 6 TRUCK (WHITE, CORBITT, AND BROCKWAY)

connecting linkage is adjustable at the cross shaft clevis of the rod, providing proper foot pedal operation. This linkage also connects with the electric trailer brake mechanism, providing a foot control for this mechanism.

119. REGULATORS.**a. Compressor Governor.**

(1) **DESCRIPTION.** The governor (located on the engine side of dashboard) operates with the "unloading" mechanism on the compressor cylinder head, so that the reservoir pressure is kept between 85 pounds minimum and 105 pounds maximum pressure.

(2) **MAINTENANCE.** Remove air strainer (inside elbow on lower right side of governor housing), and dismantle and clean air strainer in solvent. This should be done each 1,000 miles. Lubricate upper valve stem with a few drops of penetrating oil at this same time.

(3) **REMOVAL AND INSTALLATION.** Unscrew and disconnect air supply lines, and unscrew two screws holding governor to dashboard. To install governor, place assembly in position on dashboard, insert and tighten two cap screws. Connect air lines at governor couplings, and tighten coupling nuts.

b. Safety Valve.

(1) **DESCRIPTION.** The safety valve, mounted in the line between the governor and the reservoir, acts as a guard against excessive pressure in the system. Should the pressure in the system build up above 150 pounds, the excess is released to atmosphere. The valve can be removed by unscrewing from socket in air line fitting.

c. Brake Valve.

(1) **DESCRIPTION.** The brake valve (located on left side rail opposite transmission) controls the air pressure sent to the brake chambers actuating the brake camshafts. The amount of air thus delivered is controlled by the distance of travel of the brake valve lever, which is in turn controlled by the distance the foot pedal is depressed. **CAUTION:** *If the foot pedal were quickly depressed to the floor, it would act on the valve lever and valve to send the full air pressure in the system into the brake diaphragms, causing a locking of brakes and possible damage to the vehicle or its contents.* A gradual application of the brake pedal until the desired effect is obtained will aid in the safe handling of the vehicle and cargo.

(2) **REMOVAL.** Unscrew coupling nuts and disconnect air line fittings at valve couplings. Remove cotter and clevis pin from pedal linkage rod and disconnect valve lever. Unscrew and remove four nuts, lock washers, and bolts, and lift valve assembly from bracket.

(3) **INSTALLATION.** Locate valve assembly on bracket and install and tighten four bolts, lock washers, and nuts. Install pedal linkage rod clevis to valve lever, using clevis pin and cotter to secure. Connect air lines at brake valve couplings and tighten coupling nuts.

d. Relay Valve.

(1) **DESCRIPTION.** This valve, mounted on the front right side

BRAKE SYSTEMS

of the frame cross member directly above the rear axle center cross shaft, acts as a relay station, and is used to speed up application and release of rear wheel brakes.

(2) **REMOVAL.** Unscrew coupling nuts and disconnect air lines at couplings on top of valve. Unscrew and remove two nuts, lock washers, and bolts holding valve to cross member, and lift off valve.

(3) **INSTALLATION.** Install valve to cross member. Insert and tighten two bolts, lock washers, and nuts. Connect air lines at couplings on top of valve and tighten coupling nuts.

e. Quick Release Valve.

(1) **DESCRIPTION.** This valve, located in the front wheel brake line, is used to quicken release of air pressure from front wheel brake chambers.

(2) **REMOVAL AND INSTALLATION.** Unscrew coupling nuts and disconnect air lines at couplings on valve. Unscrew and remove two nuts, lock washers, and bolts holding assembly to cross member, and lift off valve. To install, place assembly on cross member and insert and tighten two bolts, nuts, and lock washers. Connect air lines at couplings on valves and tighten coupling nuts.

f. Double Check Valve.

(1) **DESCRIPTION.** This valve (mounted with one bolt to the inside right side rail, opposite the transmission) is used to permit the rear brakes of the vehicle to be operated from a towing vehicle.

(2) **REMOVAL AND INSTALLATION.** Unscrew coupling nuts and disconnect couplings at each end of valve. Unscrew and remove nut, lock washer, and bolt, and lift off valve. To install, place valve in position, insert and tighten one bolt, lock washer, and nut. Connect couplings at each end of valve and tighten coupling nuts.

g. Single Check Valve.

(1) **DESCRIPTION.** This valve is used in the emergency line at the left front of vehicle, to prevent loss of air should the emergency line cut-out cock be left open when not in use. Air can pass through this valve in only one direction.

(2) **REMOVAL AND INSTALLATION.** The valve can be unscrewed from the line.

h. Air Supply Valve.

(1) **DESCRIPTION.** This valve, immediately below the governor on the cowl, is used for an air hose for inflating tires, etc. When used, the valve is opened, cutting off the governor and allowing compressor to build up air pressure to 150 pounds. The handle of the air supply valve must be in a closed position except when the air supply feature is used.

i. Reservoirs.

(1) **DESCRIPTION.** Two reservoirs are mounted to the inside of the side rails opposite the transfer case. They are equipped with drain cocks and should be drained daily.

6-TON, 6 x 6 TRUCK (WHITE, CORBITT, AND BROCKWAY)

(2) **REMOVAL AND INSTALLATION.** Unscrew coupling nuts and disconnect air lines on each reservoir. Unscrew and remove two nuts, lock washers, and bolts holding clamps and reservoirs and lift out reservoirs. To install reservoir, place assembly in position, insert and tighten two bolts, nuts, and lock washers on holding clamps. Connect air lines to tanks and tighten coupling nuts.

120. SERVICE BRAKES.

a. The brakes are of the two-shoe type, operated by a double cam and adjusted by eccentric anchor pins. They operate against brake drum and are so designed that they cannot bind in the drum.

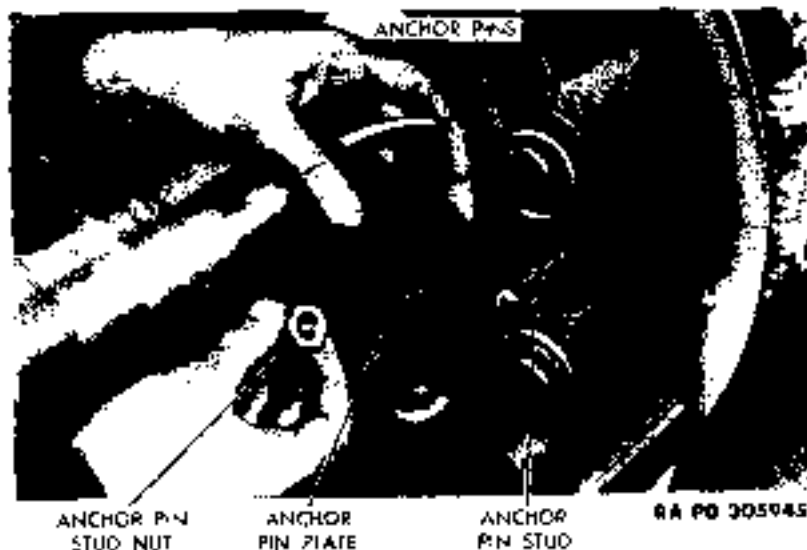


Figure 125—Removing Brake Anchor Pin Plate

b. **Removal and Installation.** Remove wheel and hub assembly (pars. 105 and 109). Unhook brake pull-back spring. Remove cotter and unscrew anchor pin nut and pull off anchor pin plate. Slide brake shoes off anchor pins. To install, slide shoes over cam and anchor pins. Install anchor pin plate. Slide brake shoes off anchor pins. To install, slide shoes over cam and anchor pins. Install anchor pin plate, and install and tighten nut. Secure with cotter pin. Install brake pull-back spring. Install wheel and hub assembly (pars. 105 and 109).

121. SERVICE BRAKE ADJUSTMENTS.**a. Linkage Adjustments.**

(1) **FOOT PEDAL TO BRAKE VALVE ROD.** Test the delivered pressure at the brake chamber, connecting an air test gage to the air

BRAKE SYSTEMS

supply line at this point. If the pressure obtained is less than 70 pounds, the pedal rod should be shortened at the pedal and clevis. The brake valve lever clevis should be connected to one of the upper holes of the lever. Care should be taken in this adjustment that the brake lever is not acting as a pedal stop, as this will break the brake valve cover at the first hard application of the brakes.

(2) After making these adjustments, be sure brake valve lever returns to its stop or full release position, otherwise the exhaust valve will be held partially closed, and slow release of brakes will result. Note that the brake valve lever has a series of holes. The pedal rod clevis is to be assembled in the third hole for a 70-pound maximum brake chamber air pressure. If the maximum brake chamber pressure varies more than two or three pounds from the required 70-pound pressure, the rod end should be moved up one hole, and a complete readjustment made.



Figure 136—Measuring Brake Clearance with Gage 41-G-400

b. Brake Chamber Linkage. After adjusting pedal travel and air pressure, check brake chamber push rods, making certain that each is fully released. A certain check is to remove cotter and clevis pin of clevis on slack adjuster. If the push rod stays in the same position, it is set correctly. If it moves out of assembly the slack adjuster should be rotated back to assembly position with the clevis. This is done by loosening the lock nut, then turning the square head adjusting nut in the desired direction. Make a full application of the brakes, and measure the travel of each push rod. Turn slack adjuster nut to set this travel at $\frac{3}{4}$ inch on rear wheels, and $\frac{1}{2}$ inch on front wheels. Be sure that this adjustment leaves a running clearance in the brake shoes so that brakes do not drag. After the adjustment, jack up wheels and see that they run freely, checking with a feeler gage for a 0.015-inch minimum clearance between shoes and drum. As levers and shoes wear, the stroke of the push rod increases. Never allow chamber push rod stroke to exceed $1\frac{1}{2}$ inch on front brake chambers.

6-TON, 6 x 6 TRUCK (WHITE, CORBITT, AND BROCKWAY)

or $1\frac{3}{4}$ inch on rear brake chambers. At this maximum, readjust to minimum as explained above.

c. Brake Shoe Adjustment.

(1) Loosen nut holding plate over gage opening on drum, push plate aside and insert feeler gage. The clearance between shoes and drum should be 0.016 inch.

(2) Adjustment to obtain this clearance is made by turning the anchor pins. This is done by loosening the lock nut and turning the adjusting nut in the desired direction. After proper clearance is established, the wheel is rotated to bring gage opening to cam end



Figure 137—Adjusting Service Brake Lining Clearance

of brake shoe. Measure the clearance at this point and adjust to 0.016 inch. It may be necessary to rotate gage opening back and forth several times between cam and anchor pins, adjusting each time to obtain proper all-around clearance.

(3) After proper all-around clearance has been established, hold the anchor pin adjusting nut stationary, and lock in position with the locking nut.

(4) After adjusting each brake, rotate the wheel and make sure there is no scapting or binding action in the shoe and drum assembly.

122. PROPELLER SHAFT BRAKE.

a. Adjustment. When brake lining wears so that brake does not hold when pushed to full "ON" position, adjustment must be made.

BRAKE SYSTEMS

Release lever to full released position. Loosen lock nut and tighten adjusting nut (on end of bolt covered with release spring) to obtain 0.006 to 0.008-inch clearance between shoes and disk, measured with a feeler gage at center of shoe at hinge pin. Tighten lock nut against adjusting nut.

b. **Removal.** Remove cotter pins and clevis pins from lever rod linkage clevises (three), on brake cross shaft. Unscrew three nuts.

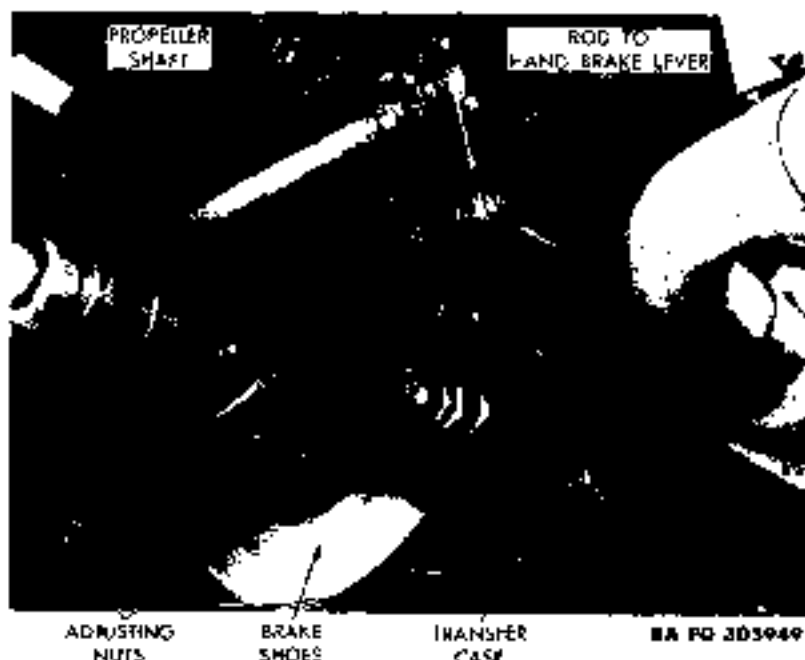


Figure 138—Propeller Shaft Brake Assembly Installed

lock washers, and bolts from the two brackets on brake cross shaft and remove cross shaft. Unscrew and remove three cap screws and lock washers on top of frame cross member, releasing right-hand side of brake assembly. Unscrew and remove three cap screws and lock washers, releasing left-hand side of brake assembly. Remove eight cotter pins and nuts on propeller shaft flange at rear of brake disk assembly. Loosen slip joint dust cap, and slide flange yoke back and off flange bolts, laying flange yoke and propeller shaft on floor. Remove brake disk from bolts in transfer case flange.

c. **Installation.** Install brake cross shaft assembly to rear of frame cross member, securing each bracket by inserting and tightening three bolts, nuts, and lock washers. Install brake disk on

6-TON, 6 x 6 TRUCK (WHITE, CORBITT, AND BROCKWAY)

bolts in transfer case flange. Slide propeller shaft flange yoke over disk bolts, install nuts and cotter pins. Tighten slip joint dust cap. Install brake left side assembly to bottom of frame cross member, and insert and tighten three cap screws and lock washers. Install brake right side assembly to bottom of frame cross member, and insert and tighten three cap screws and lock washers. Connect rod and brake cross shaft linkage clevises (three) on brake cross shaft by installing clevis pins and cotter pins. Adjust brake clearance (par. 121).

123. ELECTRIC TRAILER BRAKE CONTROLS.

a. **Description.** These controls provide simultaneous application of the electric brakes of a trailer (when used) with the service brakes. The foot controller is mounted on the inside left side rail to the rear of the air brake valve, and is operated by linkage from the brake valve lever. The hand control is mounted at the left top of the steering column, is operated from the driver's seat, and permits driver to set and maintain any degree of trailer braking power. This control is equipped with a locking mechanism for various degrees of trailer brake application. A radio-type dial load control is mounted on the dash. This provides adjustment of trailer braking rate with that of the truck. Turning the knob to the points on the dial will provide the braking force indicated.

b. Unit Replacement.

(1) **FOOT CONTROL.** Disconnect wires from terminals on controller box and tag for proper reassembly. Disconnect clevis at controller end, removing cotter pin and clevis pin. Unscrew and remove two nuts, lock washers, and bolts holding controller to frame, and lift off assembly. To install assembly, place in position on frame and insert and tighten two bolts, lock washers, and nuts. Connect control rod at clevis at control end, securing with clevis pin and cotter pin. Place wires back on proper terminals and tighten locking nuts.

(2) **HAND CONTROL.** Unscrew terminal nuts and remove wiring from bottom of control case. Unscrew and remove two nuts, lock washers, and bolts from clamp bracket and lift off unit. To install control, place clamp bracket on steering post, and install and tighten two bolts, lock washers, and nuts. Connect wiring to terminals on control case, and tighten terminal nuts.

Section XXVH

WHEELS

	Paragraph
Description	124
Maintenance and adjustments	125
Removal and installation of tire and tube assembly	126

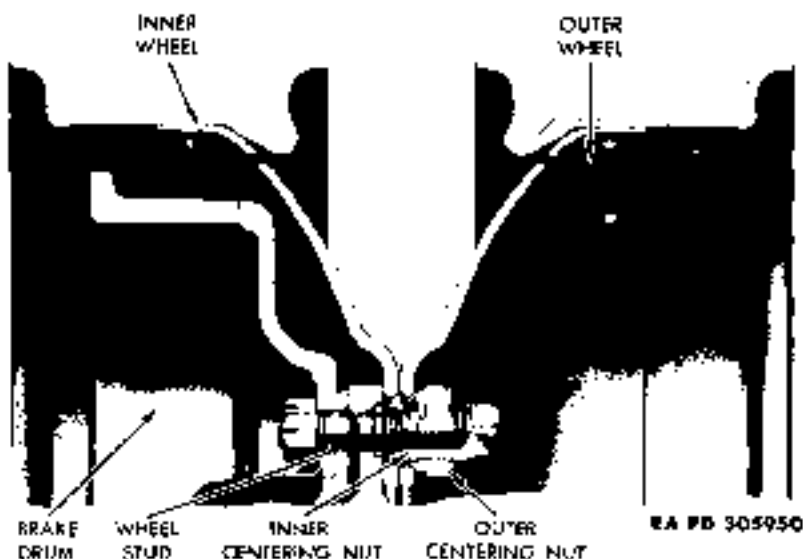


Figure 139—Cross Section of Dual Rear Wheel

124. DESCRIPTION.

a. The vehicle has ten wheels, which are the demountable 22 x 8, ten-stud disk type. They have ten mounting holes and are mounted to the brake drums. The tires are size 10.00 x 22, held on the rims with double locking rings. They are of standard "highway" type, 12-ply construction, and require 70 pounds pressure for efficient operation. The wheel studs are of special design, seating in the tapered holes of the wheels. Right- and left-hand threads are used on all wheel studs to insure tightness of these units.

125. MAINTENANCE AND ADJUSTMENTS.

a. **Maintenance.** Keep wheels clean. Check countersunk holes in wheels and be sure they are clean, so that all wheel studs will fit tightly. Also check surfaces of the dual rear wheels, as any foreign matter between the wheels will prevent proper contact, and create a wobbly or loose wheel.

b. **Adjustments.** In mounting hubs on axles, or in replacing studs and nuts, use right-hand studs on hubs with the wheel

6-TON, 6 x 6 TRUCK (WHITE, CORBITT, AND BROCKWAY)

mounting surface facing the right side of the vehicle. Use left-hand studs on hubs with the wheel mounting surface facing the left side of the vehicle. (Right and left sides are determined by operator facing the direction of vehicle travel.) Check and tighten all wheel nuts at regular intervals.



OUTER LOCKING RING INNER LOCKING RING

RA PD 309052

Figure 140—Removing Rim Locking Ring**126. REMOVAL AND INSTALLATION OF TIRE AND TUBE ASSEMBLY.**

a. **Remove Outer Wheel and Tire.** This procedure covers the change of an inside tire of the dual rear wheels, as it is the most difficult to accomplish.

(1) **JACK UP WHEEL.** Block opposite side rear wheels and lock hand brake lever into "ON" position. Setting jack under the axle, jack up one dual wheel assembly until bottom of tire is approximately three inches from ground.

(2) **REMOVE OUTER WHEEL NUTS.** Loosen and remove outer wheel nuts (hex head) with special wheel nut wrench from truck tool kit. **NOTE:** *The threads on wheels on the left side of the vehicle loosen with reverse action to those on the right side.*

(3) **REMOVE TIRE.** Place a heavy-duty punch bar under outer tire (fig. 117), and lift tire slightly. Pull outward at the same time, guiding the wheel off the studs carefully so the stud threads will

WHEELS

not be damaged. Remove tire and wheel, and lay them flat on ground.

b. **Remove Inner Wheel and Tire.** Loosen inner wheel centering nuts (square head) with special inner wheel nut wrench. Remove tire and wheel and lay them flat on ground with the rim lock side up.

c. **Remove Tire and Tube Assembly.**

(1) **DEFLATE TIRE.** Using valve cap, remove valve mechanism from valve stem and allow all air to escape from inner tube.

(2) **REMOVE RIM.** Loosen bead of tire from rim by pounding on outer rim with a heavy hammer until it shows release from rim. Drive a flat-tipped tire iron under outer locking ring, and pry loose about three-fourths around to where ring is riveted to inner lock ring. Place tire iron under both rings and pry from wheel rim.

(3) **REMOVE TIRE AND TUBE.** Turn wheel and tire over and pound tire bead loose from wheel rim. Pound wheel from outer side, driving it from tire and tube assembly.

d. **Install Tire and Wheel Assembly.**

(1) **INSTALL TIRE AND TUBE.** Place tire and tube assembly on rim, with valve stem in proper position. Place double lock ring in position and secure by pounding outer ring into wheel rim locking position. Insert valve mechanism in stem and inflate tire to about 30-pounds pressure. Inspect valve, rims, and position of tire on wheel for proper assembly and if correct, inflate tire to 70-pounds pressure.

(2) **INSTALL WHEEL.** Using pinch bar as in removal, guide inner wheel into position over studs. Secure inner wheel with centering nuts, pulling every other nut down tight. Be sure each nut is centering on its tapered seat, then tighten all nuts. Install outer wheel in a similar manner, and secure all stud nuts.

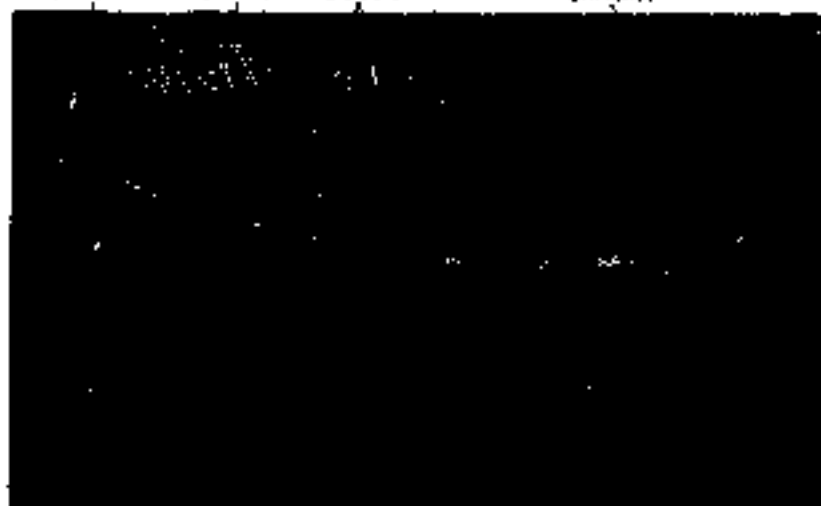
6-TON, 6 x 6 TRUCK (WHITE, CORBITT, AND BROCKWAY)

Section XXIX

SPRINGS AND TORQUE RODS

	Paragraph
Description	127
Maintenance	128
Removal and installation of springs	129

SPRING BRACKET SPRING U-BOLTS SPRING SHACKLE



BRAKE CHAMBER

BRAKE DRUM

SLACK ADJUSTER

RA PD 305953

Figure 141—Front Spring Installed

127. DESCRIPTION.

a. **Front Springs.** The front springs are of semi-elliptic type, and are connected to the frame side rails with shackles and riveted brackets. They are connected and secured to the front axle by long inverted U-bolts, nuts, and lock washers.

b. **Rear Springs.** These are of semi-elliptic type, mounted in an inverted position. The rear axle spring suspension is known as "full-floating" type, meaning that the load-carrying action is performed by the truck springs. The ends of each spring rest on hardened steel plates which are part of the axle housing. The springs are secured to the chassis by means of two spring seats, which are free to rotate on a common central tubular pivot member. These are rigidly secured to the frame by two support brackets and a girder cross member. The springs are not attached to the axles and are not subject to any twisting force due to the rise and fall of driving wheels as they follow contours of the road surface.

SPRINGS AND TORQUE RODS

c. **Torque Rods.** These rods perform a very important function in the rear axle assembly operation. The task of moving a load is accomplished by the tractive effort of driving wheels being transmitted to the vehicle chassis by means of the torque rods. These are arranged to form two parallelograms, one on each side of the spring center. When the vehicle moves forward, the forward driving wheels pull the chassis and the rear driving wheels push the chassis by means of this torque rod system. The parallel torque rod system also eliminated any possibility of transfer of weight of one axle to the other. The rods are equipped with rubber pivot ends, eliminating metal-to-metal contact and providing a cushioning effect.

d. **"Walking Beam."** The crane truck rear axle bogie is provided with a "walking beam" in place of springs. This is necessary due to the weight of the crane mounted over the axles. The spring action is accomplished with oversize, low pressure tires. The operating action of the "walking beam" is the same as the standard rear axle bogie.

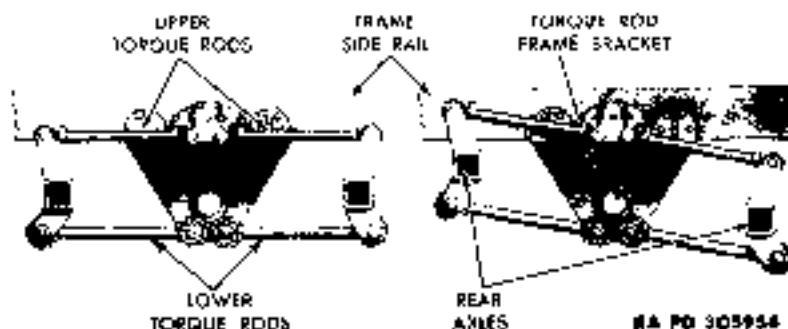


Figure 142—Torque Rods Installed

128. MAINTENANCE.

a. **Front Springs.** Inspect and tighten the shackles, spring clips and U-bolts at regular intervals.

b. **Rear Springs.** Inspect and tighten the spring clips, torque rods, and spring seats at regular intervals. Check the spring seat for end play and adjust if found to have excess end play (par. 109).

c. **Torque Rods.** If inspection shows the torque rods to be out of adjustment they should be adjusted as described (par. 109).

129. REMOVAL AND INSTALLATION OF SPRINGS.

a. Front Spring Removal.

(1) **LOOSEN U-BOLTS AND JACK UP VEHICLE.** Remove four nuts and lock washers from spring U-bolts. Place jacks under each frame side rail, immediately to the rear of the rear spring bracket, and

6-TON, 6 x 6 TRUCK (WHITE, CORBITT, AND BROCKWAY)



Figure 143—Walking Beam Installed

raise the chassis until all vehicle weight is removed from the front springs.

(2) **DISCONNECT BRACKET AND SHACKLES.** Loosen two hinder bolts in rear bracket, and drive out spring pin. Unscrew two nuts and lock washers, take out the two binder bolts from front shackle and remove side locking plate.

(3) **REMOVE SPRING.** Unscrew and pull out lower hex head shackle bolt and remove spring from assembly.

b. Front Spring Installation.

(1) **INSTALL SPRINGS.** Place spring in position on front axle

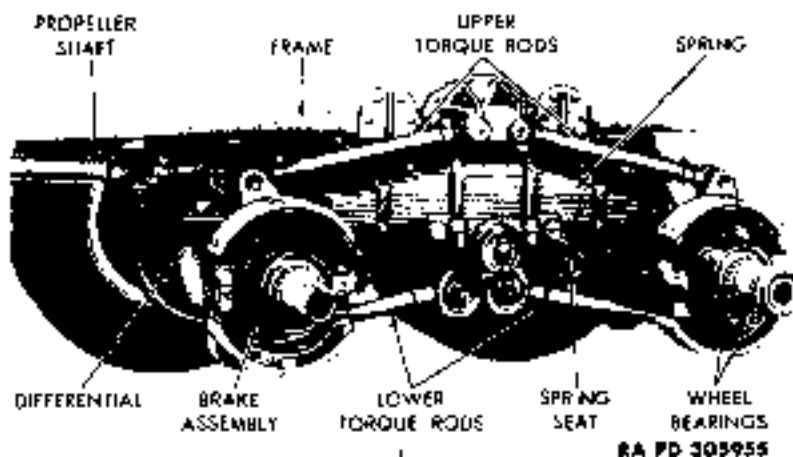
SPRINGS AND TORQUE RODS

Line up spring with rear bracket and place spring pin in position, then tighten the two binder bolts.

(2) **INSTALL SHACKLES.** Lift front of spring into position, insert lower hex shackle bolt through shackle assembly and tighten. Place locking plate on outside of shackle, insert binder bolts and tighten lock washers and nuts. Lubricate to proper specifications (figs 16 through 21).

c. Rear Spring Removal.

(1) **JACK UP VEHICLES AND REMOVE WHEELS.** Block wheels to prevent movement of chassis. Jack up cross shaft of spring seat on desired side and support on heavy-duty steel horse. Remove rear wheels (par. 126).



RA PD 303955

Figure 144—Rear Spring Installed

(2) **REMOVE SPRING U-BOLTS.** Remove four jam nuts and four nuts and lock washers holding each spring clip to spring seat, and lift clips from seat assembly.

(3) **REMOVE SPRINGS.** With a pinch bar, loosen spring from seat and remove spring assembly from chassis.

d. Rear Spring Installation.

(1) **INSTALL SPRING.** Place spring assembly in position on spring seat. Install spring U-bolts and secure with four nuts, lock washers, and four jam nuts on each U-bolt.

(2) **INSTALL WHEELS.** Install rear wheels (par. 126). Lower vehicle to ground and remove blocks.

e. **Removal and Installation of Walking Beam (Crane Truck Only).** Follow spring removal and installation procedures as given in subparagraphs c and d above.

6-TON, 6 x 6 TRUCK (WHITE, CORBITT, AND BROCKWAY)

Section XXX

STEERING

	Paragraph
Description	130
Operation of steering mechanism	131
Maintenance and adjustments	132
Replacement of component parts	133

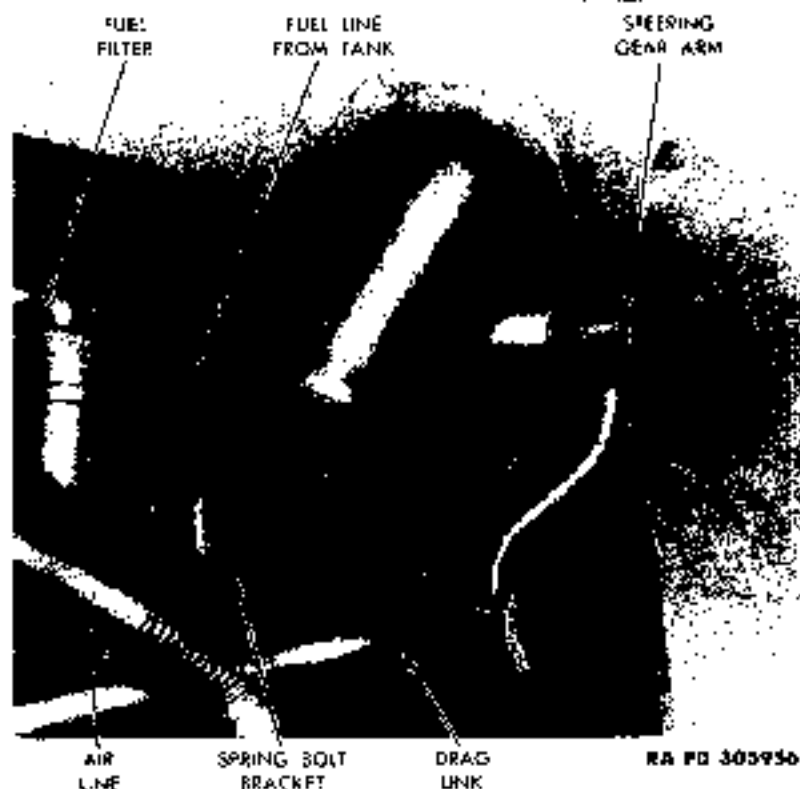


Figure 145—Steering Gear Installed

130. DESCRIPTION.

a. **Steering Gear.** The steering gear is of cam-and-twin-lever type. The housing is mounted to the frame, and the steering column is supported by a bracket bolted to the inside cowl. The gear assembly is mounted in an oiltight housing, with provision for external adjustments.

b. **Drag Link.** The drag link is of tubular type with adjustable spring-loaded ball sockets. At the axle end the spring and spacer are

STEERING

assembled between the ball seat and rod end, while at the steering gear end, the spring and spacer assembly is between the ball seat and the end plug.

c. **Steering Wheel.** The wheel is of four-spoke type, and is made of reinforced, shock-absorbing plastic.

131. OPERATION OF STEERING MECHANISM.

a. **Steering Gear.** The actuation of the steering shaft by means of the steering wheel rolls the tapered studs of the lever shaft through the groove of the cam, thus rotating the lever shaft and providing angular movement to the steering arm. The two studs engage the cam for straight-ahead driving, thus reducing unit pressure in the normal steering range. As the steering action moves into the turning range, one of the studs disengages the cam (moves out the end of the groove) and the other stud moves into position (above the cam axis) at which position effective leverage increases. An antifriction bearing is used in the upper end of the jacket tube to support the upper end of the wheel tube.



Figure 146—Tie Rod Installed

b. **Cam.** The cam is a worm of variable ratio (hence the name cam) and the thread is ground slightly higher where the normal driving action takes place. This provides closer adjustment of the clearance between the studs and cam at that point of steering action.

c. **Lever Shaft.** The lever shaft is mounted in two bronze bushings with an oil seal at the outer end of the shaft.

132. MAINTENANCE AND ADJUSTMENTS.

a. **Maintenance.** Keep the component assemblies of the steering system well lubricated, and inspect them at regular intervals for tightness. Replace any evidently defective parts if adjustments do not correct their defects. **CAUTION:** Do not attempt to correct hard steering, shimmy, or wandering by the incorrect process of tightening all steering gear assemblies. Adjust the steering gear only to remove excess play in the steering system.

6-TON, 6 x 6 TRUCK (WHITE, CORBITT, AND BROCKWAY)**b. Adjustments.**

(1) **TIE ROD.** The drop-center type tie rod connects right- and left-hand steering knuckles by means of a threaded yoke at each end. The rod has a different pitch thread at each end. This variation in threads is essential to permit an accurate toe-in adjustment due to drop-center construction.

(2) **DRAG LINK.** The drag link assembly which connects Pitman arm and knuckle arm is illustrated in figure 147. Adjustment is made by removing cotter pin and turning adjusting plug in desired direction. To adjust for wear, turn adjusting plug in until tight, then

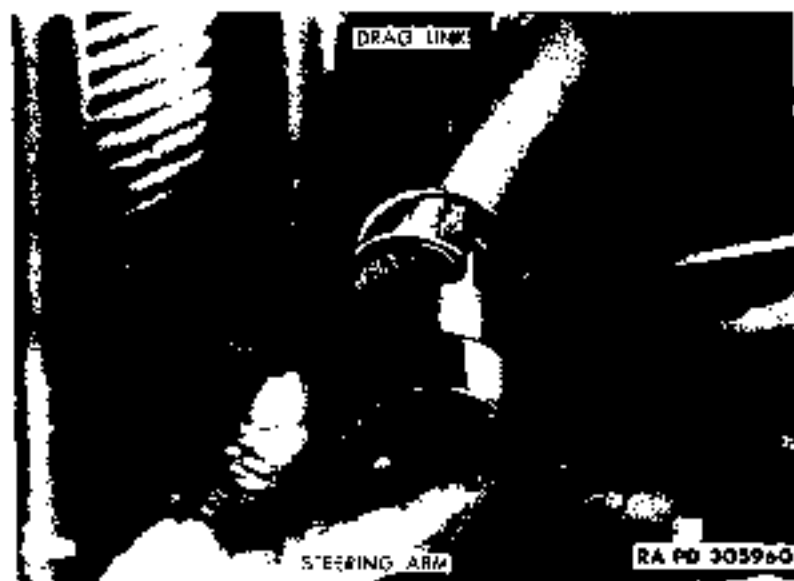


Figure 147—Adjusting Drag Link with Bit 41-B-645

back off until cotter pin enters slot in adjusting plug. Secure with a new cotter pin of proper size. The drag link should not be adjusted too tightly. The spring is located to accommodate wear, and is not intended as a shock absorber.

133. REPLACEMENT OF COMPONENT PARTS.**a. Steering Wheel Removal.**

(1) **REMOVE HORN BUTTON AND SWITCH.** Remove horn button by pressing down button and turning to the right. Remove three screws and horn contact plate from hub of steering wheel. Disconnect horn wire at terminal at bottom of steering column. Pull horn contact plate and horn wire up through and out of steering column.

STEERING

(2) **REMOVE WHEEL.** Remove wheel locking nut from hub of wheel. Use a steering wheel puller to remove wheel from steering column.

b. Steering Wheel Installation.

(1) **INSTALL WHEEL.** Press steering wheel into position on steering column and secure wheel locking nut.

(2) **INSTALL HORN WIRE AND SWITCH.** Feed horn wire down through steering column and secure it to terminal at base of steering column. Secure horn contact plate in center of wheel hub with three screws. Assemble horn button and spring by inserting into wheel hub, pressing down and turning the button to the left.

c. Drag Link Removal and Installation.

(1) **REMOVAL.** Remove cotter pin from axle end of drag link and unscrew plug until socket can be pulled off Pitman arm ball. Remove cotter pin at steering gear end and unscrew plug until socket can be pulled from steering arm ball.

(2) **INSTALLATION.** Place drag link in position with sockets over the balls of the Pitman arm and steering arm. Screw down plugs in each end of drag link until tight. Then unscrew each one-half turn and secure with locking cotter pins. Lubricate units to proper specifications.

d. Steering Gear Removal.

(1) **REMOVE WHEEL.**

(2) **DISCONNECT DRAG LINK AND STEERING GEAR.** Disconnect drag link at steering arm. Remove three nuts, lock washers, and bolts holding gear assembly to left side rail of frame.

(3) **REMOVE HORN WIRING AND POST SUPPORT BRACKET.** Disconnect horn wiring at terminal at base of steering column. Remove post support bracket after disconnecting two nuts, lock washers, and bolts, and bracket cap holding post to cowl.

(4) **REMOVE ASSEMBLY.** Lower gear and post assembly and remove from bottom of chassis.

e. Steering Gear Installation.

(1) **INSTALL GEAR AND POST ASSEMBLY.** With steering gear, steering post, and jacket assembly as a unit, place in position in chassis and secure gear housing assembly to brackets on left frame side rail with three bolts, lock washers, and nuts.

(2) **INSTALL POST SUPPORT BRACKET AND HORN WIRE.** Secure steering post jacket to cowl bracket with the bracket cap and two bolts, nuts, and lock washers. Connect horn wire at terminal at base of steering column.

(3) **INSTALL DRAG LINK.** Connect and secure drag link at steering gear arm.

(4) **INSTALL STEERING WHEEL.** Install steering wheel assembly (subpar. h above). Lubricate assembly to proper specifications.

6-TON, 6 x 6 TRUCK (WHITE, CORBITT, AND BROCKWAY)

Section XXXI

BODY AND FRAME

	Paragraph
Cab	134
Fenders and splash guards	135
Windshield wipers	136
Cargo body	137
Frame	138
Pintle hooks	139
Towing rings	140
Bumpers and guards	141

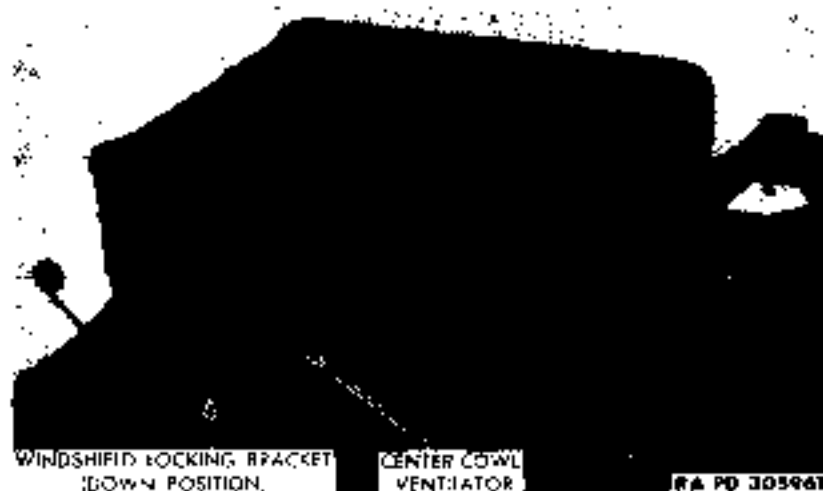


Figure 148—Cab with "Soft" Top Raised

134. CAB.

a. **General.** The lower part of the cab, including the doors, is built of pressed steel, and is welded to the cowl. It is supported on the frame with spring bolts at right front corner and rear center of cab. The left front corner of the cab is rigidly secured to the frame by a bolt running through the cab corner base plate and upper flange of frame side rail. Each side door is full hinged with the inner hinge strip secured to the body with ten recessed head screws.

b. **Ventilation.** The windshield is a single-frame split type, and is hinged across its entire base. It can be lowered forward to lock and lie flat on the hood. Each window is adjustable for ventilation

BODY AND FRAME

through use of windshield quadrants and thumbstrews inside cab. Ventilation in the cab is furnished through three points: a center cowl ventilator is operated by a handle at the right center under the cowl, and each side of the body is equipped with a hook to hold the doors in a slightly open position.

c. **Top.** The cab is equipped with a removable canvas top, held in place with rope lacing and leather grommets. The front edge of the top is held by a rope binding in the canvas, locked in a channel running the full width of the windshield. The rear upper edge of the top is supported by a steel tubular bow resting in channel brackets at each rear corner of the cab. The entire top sheet is stretched taut through the use of a draw rope secured to each side of the body, and to the rear center of the cab.



Figure 149—Cab with Top Lowered

d. **Curtains.** The back curtain is secured to the support bow at the top, using lacing straps on the tubular bow. The lower part of the rear curtain is laced to the back of the cab with heavy cord strung through grommets. The side curtains are attached to the doors and vertical windshield posts, using a rope binding in the forward edge held in a channel the full length of the windshield side posts. The rear of these curtains are supported by steel rods inserted in brackets attached to the inside of the doors.

135. FENDERS AND SPLASH GUARDS.

a. **Description.** The front fenders are made of heavy stamped steel, are equipped with non-skid tread plates, and are securely fastened to the front radiator grille guard, the engine splash guards, and the running board splash guard. They are reinforced with heavy-duty steel brackets. The battery box is built into the right-hand running board splash guard. The running boards are made of non-

6-TON, 6 x 6 TRUCK (WHITE, CORBITT, AND BROCKWAY)

skid tread plates. At the front and rear of the dual rear wheels are two vertical splash and stone guards. The rear splash guards are equipped with rungs to assist personnel in climbing into vehicle.

b. Removal and Installation of Component Parts.**(1) FRONT FENDER REMOVAL.**

(a) *Remove Engine Splash Guard.* Raise hood on the side of vehicle from which fender is to be removed. Remove two nuts, toothed lock washers, and bolts holding top splash guard to fender. Unhook two hood spring clamps, at front and rear of engine splash guard, and remove splash guard.

(b) *Disconnect and Remove Head Lamp.* Disconnect head lamp cables and connecting wire, on junction block at front inside corner of fender, and pull lamp cables through grommet. Remove two nuts on head lamp bracket, and two nuts on blackout lamp bracket, and remove lamps and cables from fender.

(c) *Remove Grille Guard Rod Bracket.* Remove three nuts, lock washers, and bolts holding grille guard support and lower bracket to side rail of frame. Remove lower nut on support rod, then slide bracket off rod. Remove seven lock washers and nuts holding fender to grille guard.

(d) *Remove Side Bolts of Fender.* Remove 12 nuts and locking washers from side bolts of fender. The nuts are inside the frame side rail.

(e) *Remove Fender to Running Board Cap Screws and Bolts.* Remove two nuts, toothed lock washers, and bolts holding fender to running board. Remove five cap screws and ten locking washers that hold rear edge of fender to front end of running board splash guard.

(f) *Remove Fender.* Pull fender from chassis assembly.

(2) FRONT FENDER INSTALLATION.

(a) *Install Fender to Running Board.* Place fender in position on chassis, inserting five cap screws and ten locking washers, securing fender to running board splash guard, and tighten. Install two bolts, toothed lock washers, and nuts holding rear of fender to running board and secure.

(b) *Install Fender to Frame.* Install 12 bolts, locking washers, and nuts holding inside edge of fender to frame side rail and secure nuts inside frame. **NOTE: Three toothed lock washers and one lock washer are used on each bolt. A lock washer is inserted between two toothed lock washers next to head of bolt and one toothed lock washer next to nut on inside frame.**

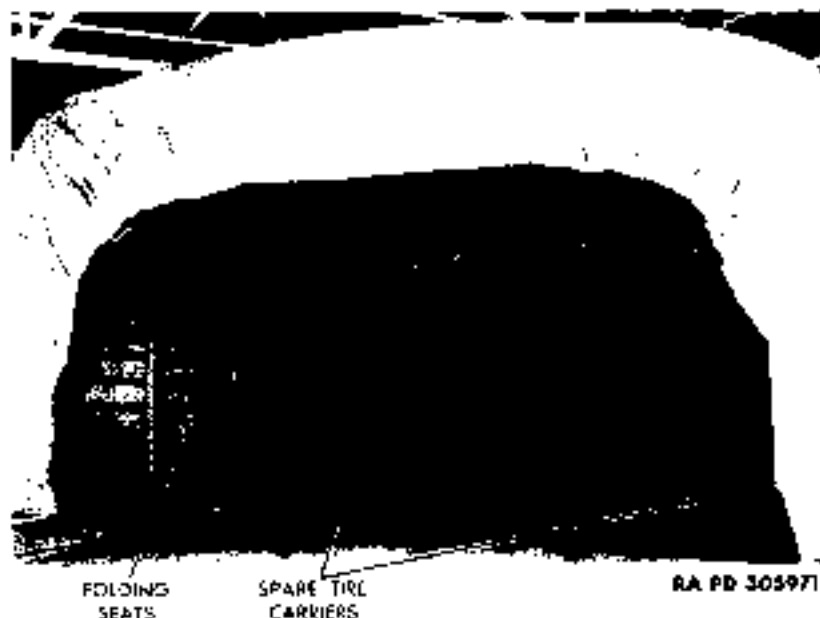
(c) *Install Fender to Grille Guard.* Install seven bolts, lock washers, and nuts holding front edge of fender to grille guard and secure.

(d) *Install Grille Guard Rod Bracket and Rod.* Install grille guard rod lower support bracket over rod and on side rail of frame, securing three bolts, lock washers, and nuts. Install lock nut on support rod, and tighten.

BODY AND FRAME

(e) *Install Head Lamps.* Install head lamp and blackout lamp and bracket assemblies on fender, and secure nuts and lock washers on bracket bolts under fender. Push head lamp and blackout lamp cables through grommet in side of fender, making sure rubber grommet is in place, and connect cables at the terminal block.

(f) *Install Splash Guards.* Install top splash guard securing two bolts, nuts and lock washers which hold splash guard to fender. Hook front and rear spring clamps holding engine splash guard.

FOLDING
SEATSSPARE TIRE
CARRIERS

RA PD 305971

Figure 150—Interior of Cargo Body**(3) RUNNING BOARD SPLASH GUARD REMOVAL AND INSTALLATION**

(a) *Removal.* Remove 15 cap screws holding splash guard to brackets. Remove seven nuts, bolts, and toothed lock washers holding splash guard to running board.

(b) *Installation.* Place splash guard in position and insert seven bolts, toothed lock washers and nuts, and secure. Insert 15 cap screws holding splash guard to brackets and secure.

136. WINDSHIELD WIPERS.

a. *Description.* The vehicle is equipped with dual windshield wipers, operated by air pressure, and mounted on the upper frame

6-TON, 6 x 6 TRUCK (WHITE, CORBITT, AND BROCKWAY)

of each windshield. Their operating speed is controlled by separate control knobs mounted on the dashboard. They are equipped with a lever for manual operation in case of mechanical failure.

b. Removal and Installation.

(1) **REMOVAL.** Remove stud nut holding blade arm and remove blade and arm from shaft at front of windshield. Disconnect air line at wiper connection. Remove two screws in upper frame of windshield, and remove wiper mechanism from inside of frame.

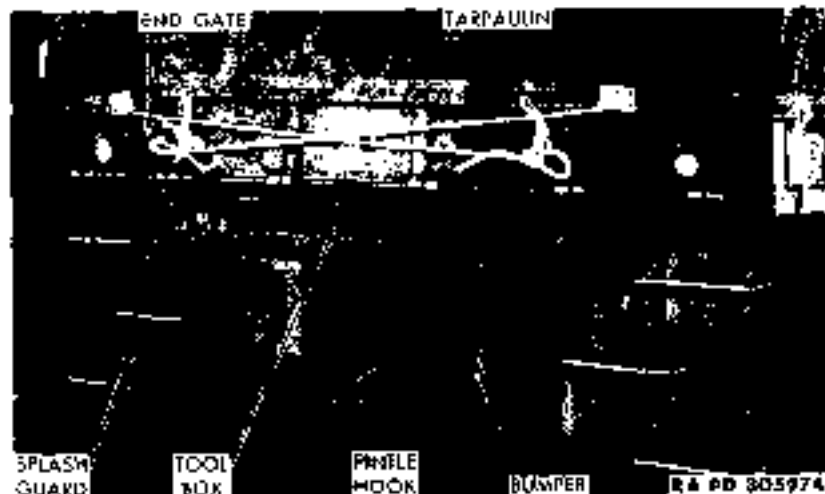


Figure 157—Rear Body Assembly

(2) **INSTALLATION.** Place wiper mechanism in position on upper frame, and secure two screws on front of windshield frame. Connect and tighten air line at wiper fitting. Replace wiper blade and arm, and secure locking nut.

137. CARGO BODY.

a. The wooden cargo body is heavily reinforced, with a wide, flat floor and low side panel. Built into this are rails, stakes, and top bows. It has folding, slotted side seats and a front seat for the use of personnel. The collapsible spare tire carriers are located in the inside front corners of the body. The entire assembly is covered with a heavy ducking, including a flap at back so that the interior is completely protected against weather. Access to body is gained by use of iron rung steps fastened to rear splash guards.

BODY AND FRAME

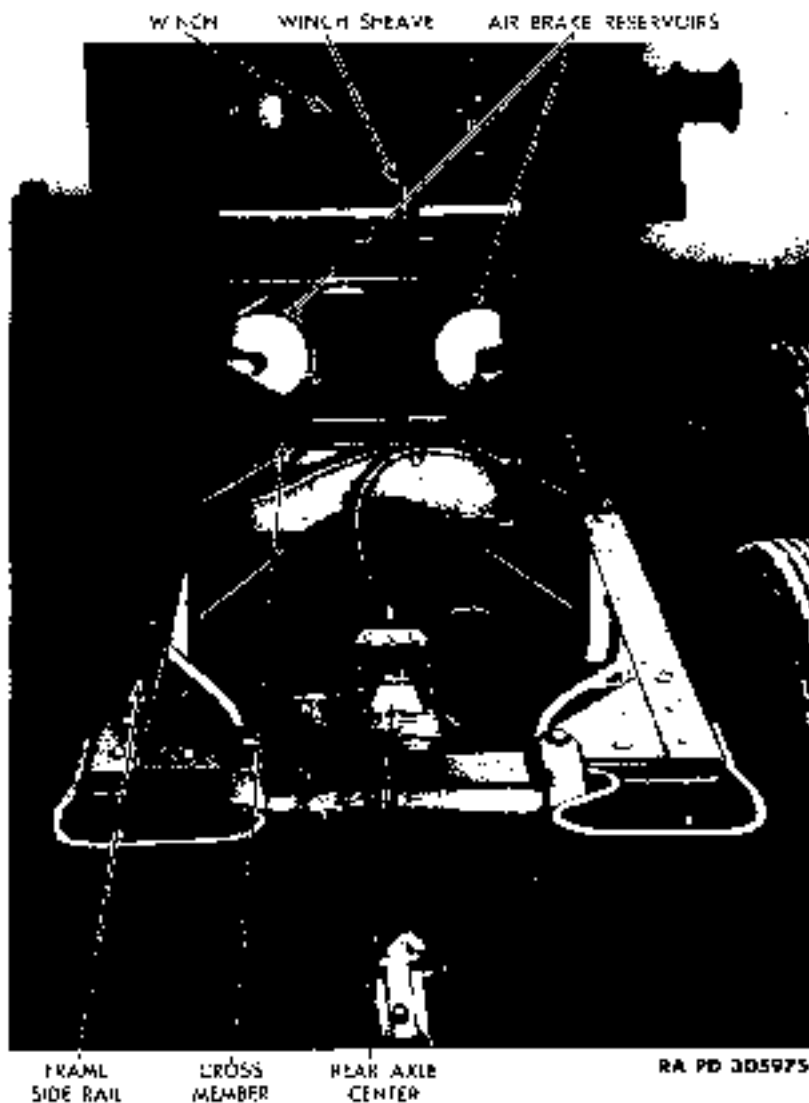
*Figure 152—Frame, Rear View*



Figure 133—Front Pintle Hook Installed

138. FRAME.

a. **Description.** The frame is made up of side rails, bumpers, cross members and bumperettes. It is the structural center of the vehicle, and in addition to carrying the cargo load, it furnishes support for the engine, transmission, and other units as well as maintaining their correct alignment.

139. PINTLE HOOKS.

a. **Description.** The vehicle is equipped with a pintle hook at the front and rear center of the chassis. They are used for towing purposes and are equipped with spring-loaded latches to keep them closed, and a locking cotter pin.

b. **Operation.** To open hook, remove large cotter pin and depress spring by pressing down on the end of the latch closest to you. Then tilt latch backward until it catches on the further end. The hook is now open to receive the chain or rope to be used. To close, lift far end of latch and it will snap back into place. Install cotter pin.

c. **Removal.** Remove eight nuts, lock washers, and bolts holding front hook assembly to front frame cross member, and remove

BODY AND FRAME

hook assembly. Remove nine nuts, lock washers, and bolts from rear cross member, and remove rear hook assembly.

d. **Installation.** Place front hook assembly in position and secure eight bolts, lock washers, and nuts. Place rear hook assembly in position and secure nine bolts, lock washers, and nuts.



*Figure 150—Towing Rings, Installed
(Bridge Erection and Crane Trucks)*

140. TOWING RINGS.

(Bridge Erection and Crane Trucks Only).

a. **Description.** These vehicles are equipped with two towing rings mounted to the underside of the front bumpers. They are used for towing purposes.

b. **Removal and Installation.** Remove four nuts, lock washers and bolts, holding tow ring bracket to frame and remove ring and bracket. To install, place ring and bracket on lower side of frame, and insert and tighten four bolts, lock washers, and nuts.

6-TON, 6 x 6 TRUCK (WHITE, CORBITT, AND BROCKWAY)**141. BUMPERS AND GUARDS.****a. Description.**

(1) **BUMPERS.** The vehicle is equipped with a heavy-duty bumper at the front, and two heavy-duty bumperettes at the rear. These are bolted to the side rails. Eight bolts, nuts, and washers secure each rear bumperette. Four bolt nuts and lock washers secure the front bumper.

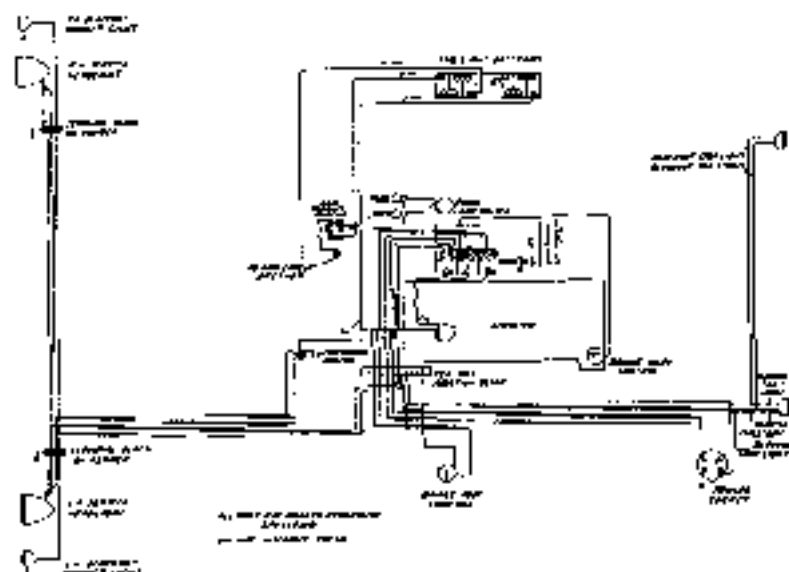
(2) **GUARDS.** The vehicle is equipped with a heavy-duty welded brush guard, shielding the radiator and the headlamp assemblies.

(a) *Removal and Installation.* Refer to paragraph 73.

Section XXXII

BATTERY AND LIGHTING SYSTEM

	Paragraph
Batteries	142
Circuit breakers	143
Switches	144
Terminal block	145
Headlights	146
Taillights	147



BA PD 302463

**Figure 155—Battery and Lighting System Wiring Diagram
(Prime Mover)**

142. BATTERIES.

a. **Description.** Two 6-volt, 19-plate, 153-ampere-hour batteries are located in a compartment at the outside of the right frame side rail below the cab door. They incorporate "safety-fill" caps and vent system, which prevent overfilling.

b. **Voltmeter Check.** Use a direct current voltmeter to test the battery condition for current supply. With the engine shut down and no load on the battery, the open circuit reading should be approximately six volts. An excessive drop of more than $1\frac{1}{2}$ volts under heavy load (cranking motor engaged) will indicate that something is wrong with the battery or its connections.

6-TON, 6 x 6 TRUCK [WHITE, CORBITT, AND BROCKWAY]

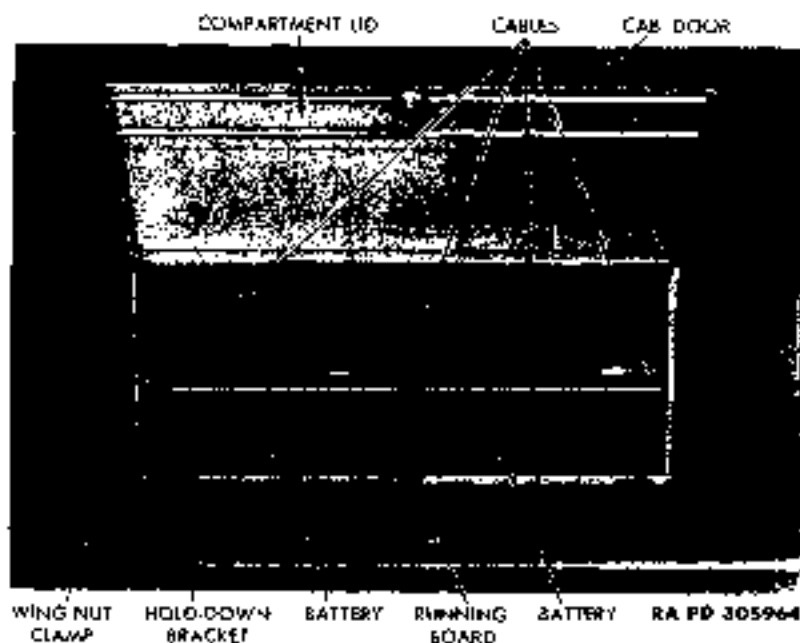
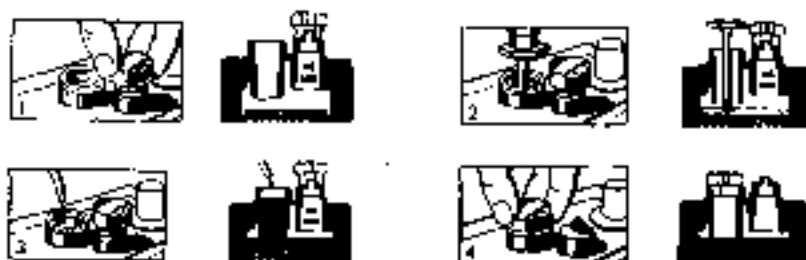


Figure 156—Batteries Installed



RA PD 305964

Figure 157—Procedure for filling Batteries

c. Battery Fluid.

(1) Add water, if necessary, before each day's run. Use nothing but pure distilled water. If any cell requires addition of an abnormal amount of water, check for possible leaks, and if all cells require an abnormal amount, charging equipment of vehicle should be checked.

(2) The batteries are equipped with "safety-fill" caps. To fill batteries, unscrew filler cap. Press filler cap onto safety-fill vent

BATTERY AND LIGHTING SYSTEM

(1, fig. 157) forming an air lock in the breather chamber. Take hydrometer reading (2, fig. 157) to determine condition of battery. If solution drawn into hydrometer cannot all be returned into battery without overflowing, discard excess. If electrolyte level is not up in filler well, add water until well is full (3, fig. 157). Remove filler plug from safety-fill vent and screw tightly into filler well (4, fig. 157). The solution will then drop to the proper level.

d. Maintenance.

(1) **BATTERY CASES.** The top of each battery should be kept clean at all times. When water is added to batteries, wipe tops and terminals with a piece of cloth or waste. The wiping cloth should then be discarded.

(2) **TERMINALS.** Use a solution of ordinary baking soda or a weak solution of ammonia for cleaning terminals. The surfaces

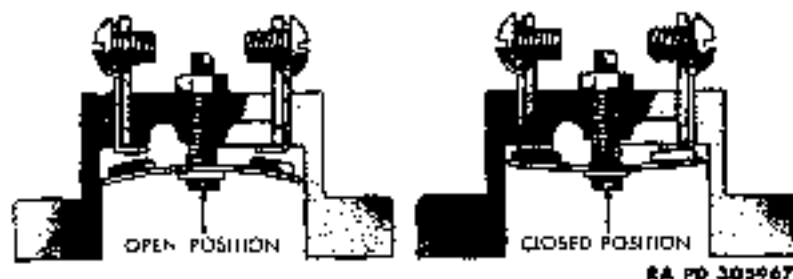


Figure 158—Circuit Breaker—Open and Closed Positions

should then be rinsed with fresh water and dried. The cables and terminals must be kept tight. Scrape clean with a coarse wire brush and then wash surface as explained above. Coat terminals with vaseline, not grease, to prevent corrosion.

(3) **TESTING.** Batteries should be tested with a hydrometer, which indicates specific gravity of liquid (electrolyte) in cells. A reading of 1.275 to 1.300 indicates a fully charged battery. If any cells are below 1.200 on two successive testing dates, remove battery, have it tested and fully charged.

e. Removal and Installation.

(1) **REMOVAL.** Open battery compartment door. Unscrew clamp bolts and pull off cables (negative lead first). Unscrew battery hold-down wing nuts and clamps. Lift out battery with carrier.

(2) **INSTALLATION.** Place battery in position in brackets. Install battery hold-down clamp and wing nuts and tighten. Push cable fittings over terminals, and tighten clamp bolts.

145. CIRCUIT BREAKERS.

a. **Description.** The lighting system is protected by circuit breakers. In the closed position (fig. 158), a snap-acting disk bridges

6-TON, 6 x 6 TRUCK (WHITE, CORBITT, AND BROCKWAY)

two terminals thereby maintaining a circuit. At predetermined overloads, the resistance heat caused by current passing through disk snaps disk into reverse position, opening contacts and breaking circuit (fig. 158). A short time after opening, disk automatically closes and re-establishes a circuit. If overload conditions still exist, breaker automatically reopens. If overload conditions are corrected, breaker remains closed.

144. SWITCHES.**a. Cranking Motor Switch.**

(1) **DESCRIPTION AND OPERATION.** The series-parallel switch (starter button switch) provides 12 volts for cranking by connecting two 6-volt batteries in series. When switch is released after starting, the two batteries are connected in parallel to provide six volts for remainder of the electrical system.

(2) REMOVAL.

(a) *Disconnect Battery.* For safety, unscrew clamp bolt nut on the positive (ground) terminal of the storage battery and place it so no short circuits can occur while removing wiring from switch terminals.

(b) *Disconnect Terminals.* Remove the nuts and lock washers from the five terminals on rear of switch. These are: ground terminal, "-B" terminal, "+B" terminal, "-A" terminal, and "SW" terminal. Tag each wire so it can be returned to its proper terminal.

(c) *Remove Switch.* Unscrew two screws holding unit to dashboard and lift switch from assembly.

(3) INSTALLATION.

(a) *Install Switch.* Place switch in position on dashboard and fasten with two screws provided for this purpose.

(b) *Install Cables.* Install the five wires, nuts, and lock washers on their respective terminals according to tags placed there in removal. Install the battery cable and tighten clamp-bolt nut.

b. Ignition Switch.

(1) **DESCRIPTION.** The ignition switch is of the keyless lever type. Turning the lever "ON" or "OFF" closes or opens the primary electrical circuit of the engine ignition system. Turn the lever to the "ON" position to start the engine. Turn the lever to the "OFF" position to stop the engine.

(2) **REMOVAL.** Unscrew nuts and pull wires from terminals. Remove collar on instrument side of panel. Lift out switch.

c. Stop Light Switch.

(1) **DESCRIPTION.** The stop light switch is operated by air pressure in the cavity acting upon the diaphragm. As pressure is admitted to this cavity, the diaphragm is raised, establishing contact between the terminals and completing the circuit. As the air pressure is exhausted from the cavity, the spring depresses the diaphragm breaking the contact.

BATTERY AND LIGHTING SYSTEM**d. Headlight Beam Switch (foot operated, push-button type).**

(1) **REMOVAL AND INSTALLATION.** Disconnect leads and remove two nuts, lock washers, and screws from toeboard. To install, place switch in position, install and tighten two screws, lock washers and nuts. Connect wires at terminals under switch and install and tighten lock washers and nuts.

e. Panel Light Switch (push-button type, pulling out to light).

(1) **REMOVAL.** Unscrew terminals and pull off wiring. Remove set screw in knob, and pull off knob. Unscrew nut, and remove switch.

f. Lighting Switch (pull-out type).

(1) **REMOVAL.** Unscrew clamp bolt nut, and lift off the positive battery (ground) terminal on battery. Disconnect terminals at rear of switch, marking for proper assembly. Remove cap screw in side of



Figure 159—Removing Headlight

button, and slide off knob. Unscrew hex nut, and push switch through panel.

(2) **INSTALLATION.** Install wires on proper switch terminals, insert switch in hole, and install and tighten hex nut. Slide knob over switch rod, and install and tighten set screw. Replace battery terminal, and tighten clamp bolt nut.

g. Blackout Driving Light Switch. This is a push-and-pull type switch which, when pulled out, will light the blackout driving lights on the unit.

(1) **REMOVAL.** Unscrew clamp bolt on positive (ground) terminal of battery and lift away from terminal. Loosen set screw in the side of blackout button, and slide knob off its shaft. Unscrew hex nut and

TM 9-813

144-146

6-TON, 4 x 6 TRUCK (WHITE, CORBITT, AND BROCKWAY)

push switch through dash panel. Disconnect terminals at rear of switch after tagging for proper reassembly.

(2) **INSTALLATION.** Connect wires to proper terminals on switch. Insert switch in dash panel from rear side of panel. Screw hex nut in place and tighten. Install blackout button and tighten set screw. Install battery terminal and tighten clamp bolt nut.

145. TERMINAL BLOCK.

a. **Description.** The terminal block is located on the engine side of the dash just to the left of the steering gear. It is a common meeting place of all chassis wiring, to facilitate the removal of the dash or other units without removing the complete wiring.

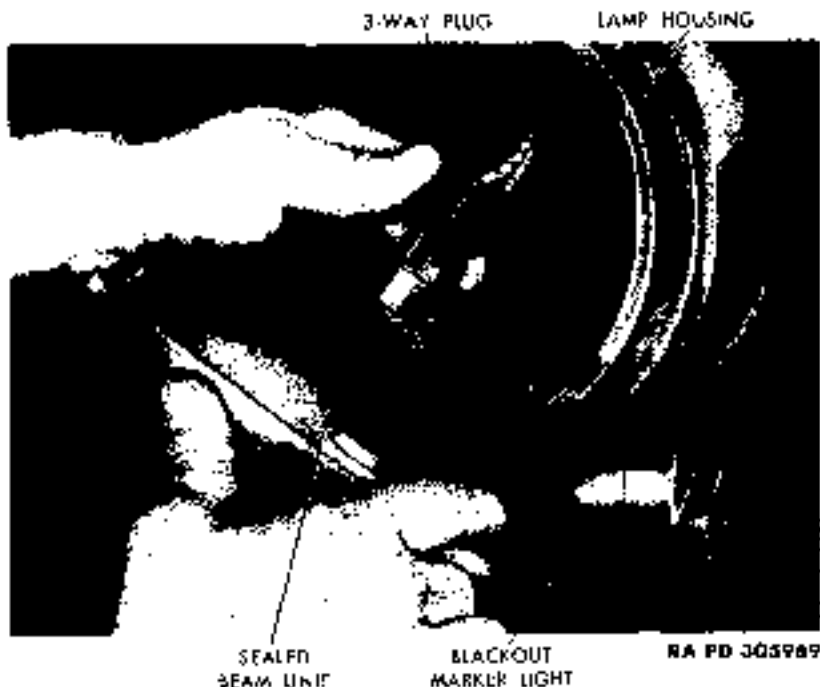


Figure 145—Removing Sealed Beam Lamp-unit

146. HEADLIGHTS.

a. Service Headlight.

(1) **DESCRIPTION.** These are of the "sealed beam" type, employing lens, reflector, and lamp in a sealed unit. These headlights contain a double filament, which provides two distinct beams, a country (upper) beam and a traffic (lower) beam. Great care should be exercised in dismantling and replacing lens and lamps because of their fragility.

BATTERY AND LIGHTING SYSTEM

(2) **REMOVAL OF HEADLIGHT ASSEMBLY.** Unscrew set screw, pull off cables from junction block at front inside corner of fender, and pull cables out through grommet in fender. Unscrew two nuts and lock washers from each head lamp bracket and lift light, bracket and cable assembly from fender.

(3) **INSTALLATION OF HEADLIGHT ASSEMBLY.** Install light and bracket assembly to fender, and install and tighten two nuts and lock washers. Run cable assembly through grommet in fender and connect to junction block at inside front corner of fender. Tighten set screws holding wires.

(4) **REMOVAL AND INSTALLATION OF SEALED BEAM LAMP-UNIT.**

(a) *Removal.* Unscrew clamp screw from rim, and lift off rim. Unscrew three hold-down screws in retainer ring and remove ring. Pull sealed beam lamp-unit partially out and pull from wiring plug.

(b) *Installation.* Push wiring plug on prongs on rear of lamp-unit. Push lamp-unit into headlight shell. Put lens in with word "top" at top. Insert and tighten three hold-down screws on ring. Install rim and tighten clamp screw.

b. **Blackout Driving Light.**

(1) **REMOVAL OF SEALED BEAM LAMP-UNIT.**

(a) *Disconnect Cables.* Disconnect cable at terminal junction block (located under hood on inside of fender) by pulling a snap connection from plug. Pull this wire enclosed in loom through grommet.

(b) *Disconnect Light Assembly.* Remove two nuts and lock washers from light mounting bracket bolts, and lift light, bracket, and wire from fender.

(c) *Remove Sealed Beam Lamp-unit.* Unscrew and remove one screw from outer clamp ring at bottom of light and lift out and up. Pull visor, rim and lamp free of back cover. Disconnect the two wires at back of sealed beam lamp-unit. Unsnap three clamping springs from inside rim of light, releasing lamp-unit from outer clamp ring.

(2) **INSTALLATION OF SEALED BEAM LAMP-UNIT.**

(a) *Install Sealed Beam Lamp-unit.* Place sealed beam lamp-unit with visor in outer clamp rim. Lay inner locking rim with three spring clamps in position, and snap locking springs in place. Connect the two wires to terminals on rear of sealed beam lamp-unit, and install assembly in outer shell. Install and tighten screw at bottom of outer clamp rim.

(b) *Install Light Assembly.* Feed cable back through grommets, mount light on fender and fasten with two bolts, nuts, and lock washers. Push wire back into snap connection at terminal block.

c. **Front Blackout Marker Light.** A small marker light equipped with a special type of blackout lens is mounted on each front fender and secured by two bolts, nuts and lock washers.

6-TON, 6 x 6 TRUCK (WHITE, CORBITT, AND BROCKWAY)

147. TAILLIGHTS.

a. Description.

(1) Vehicles for domestic use are equipped with a combination service taillight, service stop light, and blackout taillight on the left side, and with a blackout and stop light on the right side.

(2) Vehicles for export use have these lights reversed.

b. Removal and Installation.

(1) **REMOVAL.** Unscrew two nuts and lock washers on back of light under rear body cross brace, pull out light and disconnect wiring from terminals.

(2) **INSTALLATION.** Install wiring on terminals, insert light and install and tighten two lock washers and nuts.

Section XXXIII

INSTRUMENTS

	Paragraph
Tachometer	148
Fuel gage	149
Auxiliary ammeter	150
Air brake pressure gage	151
Oil viscosity gage	152
Engine temperature gage	153
Ammeter	154
Oil pressure gage	155
Speedometer	156

148. TACHOMETER (A, fig. 11).

a. **Description.** This instrument records the revolutions per minute of the engine. It has two pointers—one white and one red. The white pointer indicates the speed of the engine when running. The red pointer stops and stays at the maximum speed at which the engine has been run. The red pointer can be returned to zero only through use of the tachometer locking switch below the gage.

b. Removal and Installation.

(1) **REMOVAL.** Disconnect cable at fitting under instrument panel. Remove two nuts, lock washers, and bracket holding unit to underside of panel. Pull unit from front of panel.

(2) **INSTALLATION.** Push unit through hole in panel until dial flange rests on panel face. Install bracket over back of unit and secure with two lock washers and nuts. Connect cable at fitting.

149. FUEL GAGE (B, fig. 11).

a. **Description.** The fuel gage registers the amount of fuel in the tank when the ignition switch is turned on. "F" indicates full (80 gal), "½" indicates half-full (40 gal), and "E" indicates an empty tank.

b. Removal and Installation.

(1) **REMOVAL.** Remove three wires under panel at terminals, noting their color and markings, and relative terminals. Remove two nuts and lock washers holding bracket to under panel, and remove bracket. Pull instrument out of front of panel.

(2) **INSTALLATION.** Push instrument through hole in panel, seating dial flange on panel face. Install instrument bracket on under panel and secure with two lock washers and nuts. Install three wires and connect to proper terminals.

4-TON, 4 x 6 TRUCK (WHITE, CORBITT, AND BROCKWAY)

150. AUXILIARY AMMETER (H, fig. 11).

a. **Description.** This unit indicates whether or not the "B" battery (used only for starting), is being charged or discharged.

b. **Removal and Installation.**

(1) **REMOVAL.** Remove two nuts and lock washers which hold instrument bracket under panel, and remove bracket. Disconnect two wires at terminals, noting their color, markings and location for replacement. Push unit out front of panel.

(2) **INSTALLATION.** Push unit into panel, seating dial flange on face of panel. Install wires to proper terminals, install bracket and secure with two lock washers and nuts.

151. AIR BRAKE PRESSURE GAGE (C, fig. 11).

a. **Description.** This shows the air pressure stored in the air brake reservoirs. The system is equipped with a warning buzzer, which will operate continuously as long as the air pressure is below safe operating range (50 lb).

b. **Removal and Installation.**

(1) **REMOVAL.** Disconnect air line at fitting on gage under panel. Remove two nuts, lock washers, and bracket, and pull unit from face of panel.

(2) **INSTALLATION.** Push unit through panel, seating dial flange on panel face. Install bracket and secure with two lock washers and nuts. Connect air line at rear of gage.

152. OIL VISCOSITY GAGE (I, fig. 11).

a. **Description.** This registers the relative viscosity of engine oil. The reading on this gage at normal operating temperature will indicate any need for a change to heavier or lighter oil.

b. **Removal and Installation.**

(1) **REMOVAL.** Disconnect oil line from fitting on instrument under dash panel. Remove two nuts, lock washers and bracket, and pull unit from front of pedal.

(2) **INSTALLATION.** Push unit through panel, seating dial flange on panel face. Install bracket on rear of unit and secure with two nuts and lock washers. Install and secure oil line at fitting on unit.

153. ENGINE TEMPERATURE GAGE (D, fig. 11).

a. **Description.** This indicates, in degrees Fahrenheit, the temperature of the liquid in the cooling system. The normal operating temperature is between 160° and 180°F.

b. **Removal and Installation.**

(1) **REMOVAL.** Disconnect thermal unit at fitting on left rear side of cylinder head. Remove nut, lock washer, and bolt from clamp on cowl, and spread clamp. Remove cowl grommet and pull line carefully through hole in cowl. Remove two nuts and lock washers, and

INSTRUMENTS

bracket from rear of unit. Pull unit and line assembly from front of panel.

(2) **INSTALLATION.** Push line and unit through hole in dash panel, seating dial flange on dash panel face. Carefully install line, grommet, line clamp, and thermal unit in proper locations, and secure. Install bracket on back of unit and secure with two lock washers and nuts.

154. AMMETER (J, fig. 11).

a. **Description.** This unit indicates either the amount of current being drawn from the battery, or the rate at which current is being supplied by the generator to the battery.

b. Removal and Installation.

(1) **REMOVAL.** After marking the four wires with paper slips over the ends, remove two nuts and lock washers, and pull wires from under panel. Remove bracket from unit and pull unit from front of panel.

(2) **INSTALLATION.** Push unit through panel hole, seating dial flange on panel face. Install bracket on rear of unit, install four wires on proper terminals, and secure assembly with two lock washers and nuts.

155. OIL PRESSURE GAGE (F, fig. 11)

a. **Description.** This indicates the pressure at which oil is being forced through the lubricating system of the engine. At a speed of 40 miles per hour a normal reading of this gage should be approximately 26 pounds. **NOTE:** *If the oil pressure should fall to zero during operation of the vehicle, stop the engine immediately and determine the cause of the pressure failure.*

b. Removal and Installation.

(1) **REMOVAL.** Disconnect oil line at fitting on gage under dash panel. Remove two nuts, lock washers and bracket. Pull unit from front of panel.

(2) **INSTALLATION.** Push unit through hole in dash panel, seating dial flange on panel face. Install bracket and secure with two lock washers and nuts. Connect oil line at fitting on unit.

156. SPEEDOMETER (K, fig. 11).

a. **Description.** The dial indicates the speed in miles per hour at which the truck is being driven. The upper row of figures records the total miles the truck has been driven; the lower row indicates trip mileage, and can be reset by hand.

b. Removal and Installation.

(1) **REMOVAL.** Disconnect cable at unit under dash panel. Remove two wing nuts and bracket, and pull unit from front of panel.

(2) **INSTALLATION.** Push unit through hole in dash panel, seating dial flange on panel face. Install bracket and secure with two wing nuts. Connect cable at fitting on unit.

6-TON, 6 x 6 TRUCK (WHITE, CORBITT, AND BROCKWAY)

Section XXXIV

WINCH

Description	Paragraph
Maintenance	157
Removal	158
Installation	159

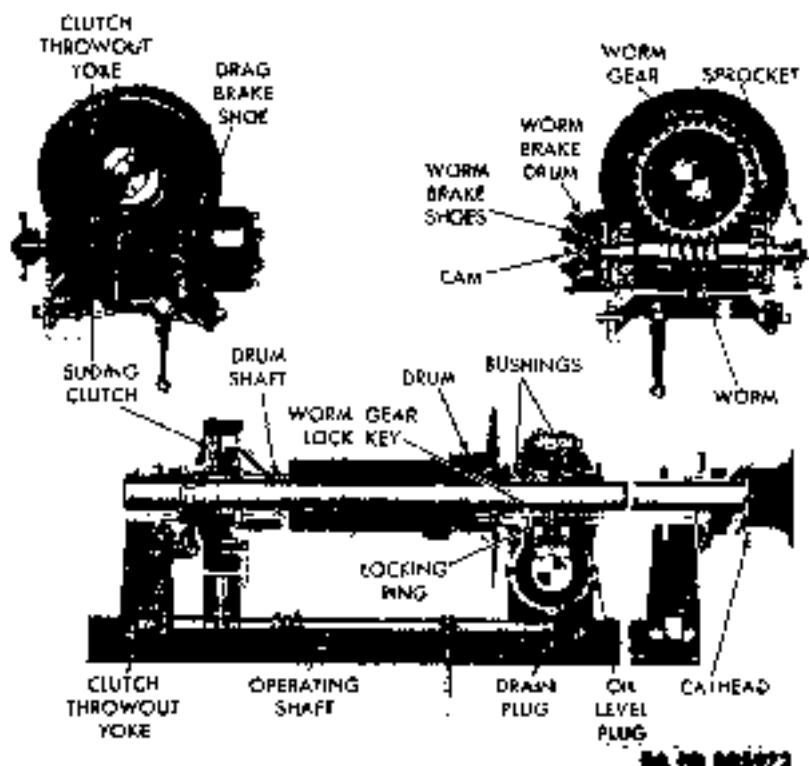


Figure 1-67—Cross Section of Prime Mover Winch

157. DESCRIPTION.

a. **Prime Mover Winch.** The winch is mounted to the frame side rails at the rear of the cab. It is chain-driven from the power take-off on the transfer case, and operates through a worm and worm gear. It is equipped with a sliding clutch and an automatic worm brake. The cathead extends to the right side of the cab, and the winch drum and cable are located at the rear center of the cab. The cable operates

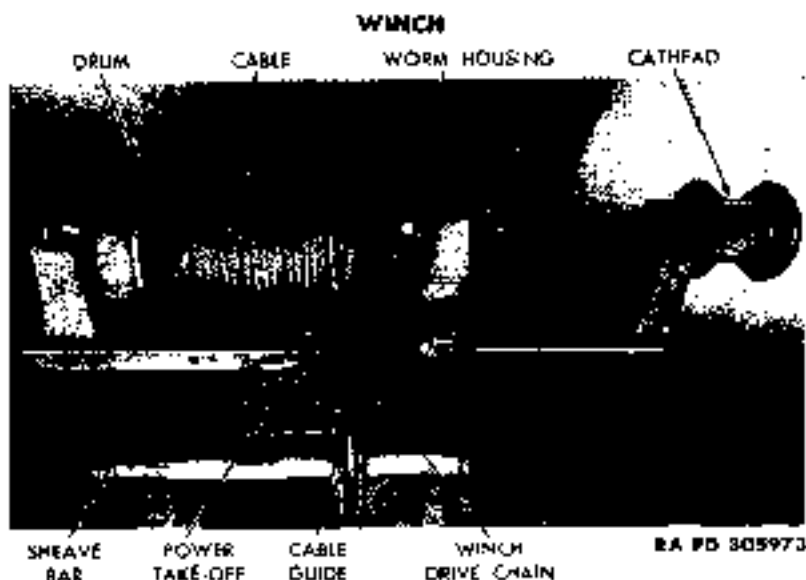


Figure 162—Prime Mover Winch Installed

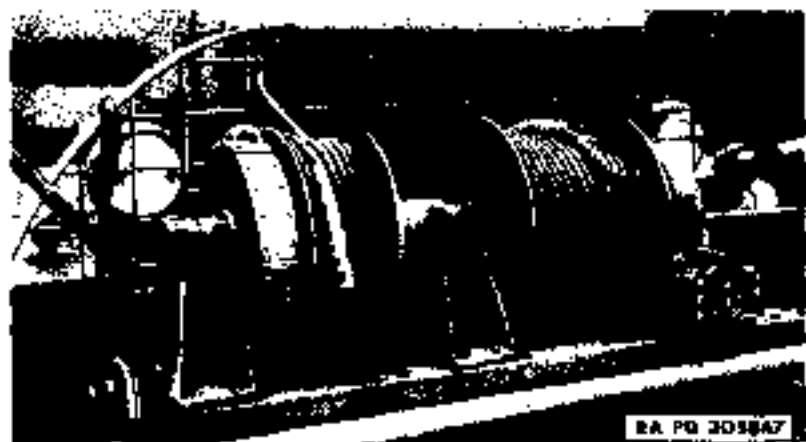


Figure 163—Bridge Erection and Crane Truck Winch Installed

on sheaves on the underside of the cargo body, and is pulled out from the roller under the tool box at the rear of the vehicle.

b. **Bridge Erection and Crane Truck Winch.** This unit is a double-drum type, having a large and a small drum. It is operated from a powered propeller shaft through a worm and gear, is equipped with a jaw clutch and drag brake, and is mounted on the front of the chassis frame.

6-TON, 6 x 6 TRUCK (WHITE, CORBITT, AND BROCKWAY)

158. MAINTENANCE.

a. **The winch should be inspected at regular intervals for lubrication, operation, and general tightness and cleanliness. The cable should be properly wrapped on the drum and all parts, clevises, and control rods cleaned and adjusted.**

159. REMOVAL.

a. **Prime Mover.** Disconnect removable link pin and link in drive chain, and remove chain from sprockets. Pull cable from under body and place it on top of assembly. Remove four nuts, lock washers, and bolts each side from frame bracket and winch, and lift winch assembly from chassis with a hoist.

b. **Bridge Erection.** Remove nuts, lock washers and bolts which hold winch to frame. Place a rope sling around and under support brackets of winch, and lift from chassis with a hoist.

160. INSTALLATION.

a. **Prime Mover.** With a hoist, lower winch assembly into position on frame brackets. Install and secure four bolts, lock washers, and nuts on each side, which hold winch assembly to frame brackets. Install drive chain on sprockets, and secure with link pin and cotter pin on removable link.

b. **Bridge Erection.** Using a hoist and rope sling as in removal, lower winch to frame, guiding it to line up with bolt holes. Install and tighten bolts, lock washers, and nuts which hold unit to frame.

Section XXXV

SHIPMENT AND TEMPORARY STORAGE

	Paragraph
General instructions	161
Preparation for temporary storage	162
Loading and blocking for rail shipment	163

161. GENERAL INSTRUCTIONS.

a. Preparation for domestic shipment of the vehicle is the same, with the exception of minor added precautions, as preparation for temporary storage. Preparation for shipment by rail includes instructions for loading the vehicle, blocking necessary to secure the vehicle on freight cars, and other information necessary to properly prepare the vehicle for domestic rail shipment. For more detailed information and for preparation for indefinite storage refer to AR 850-16.

162. PREPARATION FOR TEMPORARY STORAGE.

a. Vehicles to be prepared for temporary storage are those ready for immediate service but not used for less than 30 days. If vehicles are to be indefinitely stored after shipment by rail, they will be prepared for such storage at their destination.

b. If the vehicles are to be temporarily stored, take the following precautions:

- (1) **LUBRICATION.** Lubricate the truck completely (par. 23).
- (2) **COOLING SYSTEM.** If freezing temperature may normally be expected during the limited storage or shipment period, test the coolant with a hydrometer and add the proper quantity of antifreeze to afford protection from freezing at the lowest temperature anticipated during the storage or shipping period. Completely inspect the cooling system for leaks.
- (3) **BATTERY.** Check battery and terminals for corrosion and, if necessary, clean and thoroughly service battery (par. 142).
- (4) **TIRES.** Clean, inspect, and properly inflate all tires, including spares. Replace with serviceable tires all tires requiring repairing or retreading. Do not store tired vehicles on floors, cinders, or other surfaces which are soaked with oil or grease. Wash off immediately any oil, grease, gasoline, or kerosene which comes in contact with tires under any circumstances.
- (5) **ROAD TEST.** The preparation for limited storage will include a road test after the battery, cooling system, and lubrication services, to check on the general condition of the vehicle. Correct any defects noted in the vehicle operation before the vehicle is stored, or attach note (on a tag) to the steering wheel stating the repairs needed or describing the condition present. A written report of these items will then be made to the officer in charge.
- (6) **FUEL IN TANKS.** It is not necessary to remove fuel from the vehicle tanks for shipment within the United States, nor to label the

6-TON, 6 x 6 TRUCK (WHITE, CORBITT, AND BROCKWAY)

tanks under Interstate Commerce Commission Regulations. Leave fuel in the tanks except when storing in locations where fire ordinances or other local regulations require removal of all gasoline before storage.

(7) **EXTERIOR OF VEHICLE.** With flint paper 2/0 remove rust appearing on any part of the vehicle exterior. Repaint painted surfaces whenever necessary to protect wood or metal. Coat exposed polished metal surfaces susceptible to rust, such as winch cables and chains, with medium grade preservative lubricating oil. Close firmly all doors, latches, windows, and windshields. Top must be in place, raised and secured, all curtains in place, and windshield closed. Make sure tarpaulins are in place and firmly secured. Leave rubber floor mats, when provided, in an unrolled position on the floor, not rolled or curled up. Equipment such as fire extinguishers will remain in place on the vehicle.

(8) **INSPECTION.** Make a systematic inspection just before shipment or temporary storage to insure all above steps have been covered, and that the vehicle is ready for operation on call. Make a list of all missing or damaged items and attach it to the steering wheel. Refer to "Before-operation Service" (par. 18).

(9) **BRAKES.** Release brakes and chock the wheels.

c. **Inspections in Limited Storage.** Vehicles in limited storage will be inspected weekly for condition of battery and (in case of anticipated freezing weather) cooling system. If water is added to the battery when freezing weather is anticipated, recharge the battery with a portable charger, or remove the battery for charging. Do not attempt to charge the battery by running the engine. If freezing temperature is expected, add the proper quantity of antifreeze compound to cooling system to afford protection from freezing.

163. LOADING AND BLOCKING FOR RAIL SHIPMENT.

a. **Preparation.** In addition to the preparation described in paragraph 161 when ordnance vehicles are prepared for domestic shipment, the following preparation and precautions will be taken.

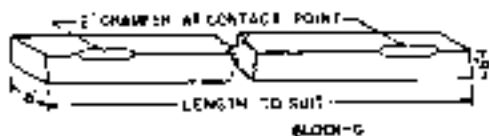
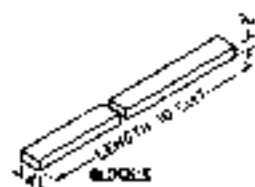
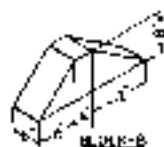
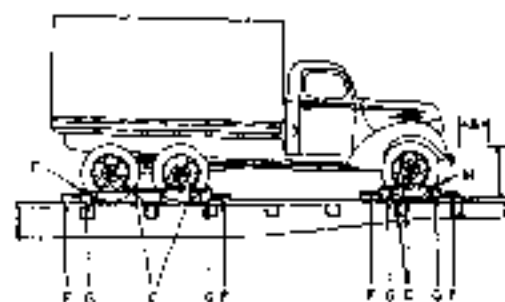
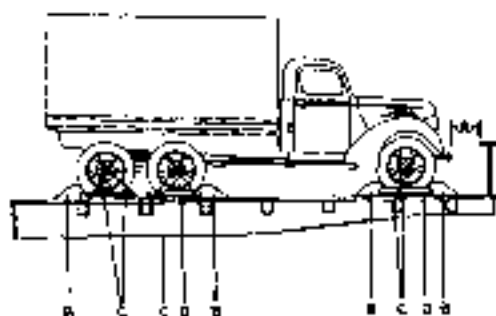
(1) **EXTERIOR.** Cover the body of the vehicle with the canvas cover supplied as an accessory or available for use during rail shipment.

(2) **BATTERY.** Disconnect the battery to prevent its discharge by vandalism or accident. This may be accomplished by disconnecting the positive lead, taping the end of the lead, and tying it back away from the battery.

(3) **BRAKES.** The hand brake must be set and the transmission placed in neutral after the vehicle has been placed in position, with a brake wheel clearance of at least 6 inches (fig. 164). The vehicles will be located on the car in such a manner as to prevent the car from carrying an unbalanced load.

(4) All cars containing ordnance vehicles must be placarded "DO NOT HUMP."

SHIPMENT AND TEMPORARY STORAGE



RA PD 330340

Figure 164—Blocking Requirements for Securing Truck to Railroad Car

4-TON, 6 x 6 TRUCK (WHITE, CORBITT, AND BROCKWAY)

(5) Ordnance vehicles may be shipped on flat cars, end-door box cars, side-door box cars, or drop-end gondola cars, whichever type car is the most convenient.

b. Facilities for Loading. Whenever possible, load and unload vehicles from open cars under their own power, using permanent end ramps and spanning platforms. Movement from one flat car to another along the length of the train is made possible by crossover plates or spanning platforms. If no permanent end ramp is available, an improvised ramp can be made from railroad ties. Vehicles may be loaded in gondola cars without drop ends by using a crane. In case of shipment in side-door box cars, use a dolly-type jack to warp the vehicles into position within the car.

c. Securing Vehicles. In securing or blocking a vehicle, three motions, lengthwise, sidewise, and bouncing, must be prevented. Two methods for blocking six-wheel trucks on freight cars (fig. 164) are given below. **NOTE:** *All blocking must be located against the outside wheel of the dual.*

(1) **FIRST METHOD** (fig. 164). Locate eight blocks (B), one to the front and to the rear of each front wheel and to the front of each forward rear wheel, and to the back of each rearward rear wheel. Nail the heel of each block to the car floor with five 40-penny nails, and toenail the portion of each block under the tire to the freight car floor with two 40-penny nails. Locate two cleats (D) against the outside face of each wheel. Nail the lower cleat (D) to the freight car floor with three 40-penny nails and the top cleat to the cleat below with three 40-penny nails. Pass four strands, two wrappings, of No. 8 gage, black annealed wire (C, figure 164) through the holes in the wheels and pass through the stake pockets. Tighten wires enough to remove slack. **NOTE:** *When a box car is used, this strapping must be applied in similar fashion and attached to the floor by the use of blocking or anchor plates. This strapping is not required when gondola cars are used.*

(2) **SECOND METHOD** (fig. 164). Place two blocks (G), one to the front and one to the rear of the front wheels. Place two blocks (G), one to the front of the forward rear wheels and one to the back of the rearward rear wheels. **NOTE:** *These blocks (G) must be at least eight inches wider than the over-all width of the vehicle at the freight car floor.* Locate 16 cleats (F), two against blocks (G) to the front and rear of each blocked wheel. Nail lower cleats to freight car floor with the five 40-penny nails, then nail top cleat (F) to lower cleat (F) with five 40-penny nails. Position four cleats (H), one over two cleats (G) and against the outside of each blocked wheel. Nail each end of cleat (H) to cleats (G) with three 40-penny nails. Pass four strands, two wrappings, of No. 8 gage, black annealed wire (c fig. 164) through the holes in the wheels and pass through the stake pockets. Tighten wires enough to remove slack. **NOTE:** *When a box car is used, this strapping must be applied in similar fashion and attached to the floor by the use of blocking or anchor plates. This strapping is not required when gondola cars are used.*

SHIPMENT AND TEMPORARY STORAGE

d. Shipping Data.

Length, over-all:

Prime mover (White)	24 ft 1 in.
Prime mover (Corbitt)	23 ft 9 in.
Bridge erection truck	30 ft 10 in.
Crane truck	34 ft 8 in.

Width, over-all:

Prime mover (White)	8 ft
Prime mover (Corbitt)	8 ft
Bridge erection truck	8 ft 4 in.
Crane truck	8 ft 4 in.

Height, over-all:

Prime mover (White)	9 ft 6 in.
Prime mover (Corbitt)	9 ft 10 in.
Bridge erection truck	9 ft
Crane truck	11 ft 4½ in.

Shipping weight per vehicle:

Prime mover (White)	22,900 lb
Prime mover (Corbitt)	22,020 lb
Bridge erection truck	26,500 lb
Crane truck	35,275 lb

Approximate floor area occupied per vehicle:

Prime mover (White)	192.64 sq ft
Prime mover (Corbitt)	190 sq ft
Bridge erection truck	256.81 sq ft
Crane truck	288.72 sq ft

Approximate volume occupied per vehicle:

Prime mover (White)	1,830.08 cu ft
Prime mover (Corbitt)	1,867.70 cu ft
Bridge erection truck	2,311.79 cu ft
Crane truck	3,284.19 cu ft

6-TON, 6 x 6 TRUCK (WHITE, CORBITT, AND BROCKWAY)**REFERENCES****PUBLICATIONS INDEXES.**

The following publications indexes should be consulted frequently for latest changes to or revisions of the publications given in this list of references, and for new publications relating to material covered in this manual:

- | | |
|--|------------------------|
| Introduction to Ordnance Catalog (explains SNL system) | ASF Cat.
ORD-1 IOC |
| Ordnance publications for supply index (index to SNL's) | ASF Cat.
ORD-2 OPSI |
| Index to ordnance publications (lists FM's, TM's, TC's and TB's of interest to Ordnance personnel, MWO's, OPSR's, BSD, S of SR's, OSSC's and OFSB's. Includes alphabetical listing of Ordnance major items with publications pertaining thereto) | OFSB 1-1 |
| List of publications for training (lists MR's, MTP's, T/BA's, T/A's, and FM's, TM's, and TR's concerning training) | FM 21-6 |
| List of training films, film strips and film bulletins (lists TP's, FS's, and FB's by serial number and subject) | FM 21-7 |
| Military training aids (lists graphic training aids, models, devices, and displays) | FM 21-8 |

STANDARD NOMENCLATURE LISTS.**Vehicular.**

- | | |
|--|-----------|
| Truck, 6-ton, 6 x 6, cargo, closed cab, prime mover, 2,000-gallon gas tank, chassis, van 1942-43 (White 666) | SNL G-514 |
| Truck, 6-ton, 6 x 6, cargo, van, chassis, open cab (White Model 666, open cab) | SNL G-526 |
| Truck, 6-ton, 6 x 6, (Brockway)
Model B666, bridge ponton, w/winch
Model B666, chassis, w/quickway crane,
w/winch | SNL G-547 |
| Truck, 6-ton, 6 x 6, prime mover, w/ or w/o winch, 1941-42-43 (Corbitt 568D-6). | SNL G-512 |

REFERENCES

Maintenance.

Cleaning, preserving and lubrication materials, special oils, and miscellaneous related items	SNL K-1
Soldering, brazing, and welding materials, gases and related items	SNL K-2
Tools, maintenance, for repair of automotive vehicles	SNL G-27 Vol. 1
Tool sets, motor transport	SNL N-19

EXPLANATORY PUBLICATIONS.**Fundamental Principles.**

Automotive electricity	TM 10-580
Basic maintenance manual	TM 38-250
Driver selection and training	TM 21-300
Electric fundamentals	TM 1-455
Military motor vehicles	AR 850-15
Motor vehicle inspections and preventive maintenance services	TM 9-2810
Precautions in handling gasoline	AR 850-20
Standard military motor vehicles	TM 9-2800

Maintenance and Repair.

Cleaning, preserving, lubricating, and welding materials and similar items issued by the Ordnance Department	TM 9-850
Cold weather lubrication and service of combat vehicles and automotive materiel	OPSB 6-11
Ordnance maintenance: Carburetors (Zenith)	TM 9-1826C
Ordnance maintenance: Electrical equipment (Delco-Remy)	TM 9-1825A
Ordnance maintenance: Fuel pumps	TM 9-1828A
Ordnance maintenance: Hercules engines	TM 9-1832A
Ordnance maintenance: Power train, chassis, and winches for 6-ton, 6 x 6, truck (White, Corbitt, and Brockway)	TM 9-1813
Tune-up and adjustment	TM 10-530

Protection of Materiel.

Chemical decontamination, materials and equipment	TM 3-220
Camouflage	FM 5-20
Decontamination of armored force vehicles	FM 17-59

TM 9-813**4-TON, 6 x 6 TRUCK (WHITE, CORBITT, AND BROCKWAY)**

Defense against chemical attack FM 21-40

Explosives and demolitions FM 5-25

Storage and Shipment.Ordnance storage and shipment chart, group G—
Major items OSSC-G

Registration of motor vehicles AR 850-10

Rules governing the loading of mechanized and
motorized army equipment, also major caliber
guns, for the United States Army and Navy, on
open top equipment published by Operations
and Maintenance Department of Association of
American Railroads.

Storage of motor vehicle equipment. AR 850-18

INDEX

A	Page No.	Page No.
Adjustment		second echelon maintenance 36
carburetor	148	trouble shooting 115
clutch	181	At-halt service 42
cranking motor	175	Auxiliary equipment controls and operation
distributor	167	hydraulic boom on bridge erection truck 30
front axle		winch on bridge erection crane trucks 19
steering knuckle bearing	201	winch on prime mover trucks 29
toe-in	206	Axle and transfer vents, after-operation and weekly service 46
wheel bearing	207	Axle shaft, removal and installation 214
generator	179	
propeller shaft	236	B
service brakes		Batteries
brake chamber linkage	215	after-operation and weekly service 44
brake shoe	238	care in temporary storage 273
linkage	234	description 259
steering system	248	maintenance 261
valves	153	removal and installation 261
wheels	239	run-in test procedures 78
After-operation and weekly service	43	second echelon maintenance 89
Air brake system		tune-up 126
care and operation in extreme heat 34		Battery and lighting system
data	216	batteries 250
description	224	circuit breakers 261
second echelon maintenance	85	headlights 264
Air cleaner assembly		switches 262
installation	142	taillights 266
removal	140	terminal block 264
Air cleaners		Before-operation service 38
after-operation and weekly service 45		Body and frame
at-halt service	43	bumper and guards 254
description	147	cab 250
installation	147	cargo body 254
lubrication		fenders and splash guards 251
Brookway	68	frame 250
Corbett	70	pinch hooks 256
White	40	towing rings 257
maintenance	147	windshield wipers 153
removal	147	Brake chamber
run-in test procedures	79	description 229
second echelon maintenance	93	installation 230
Air compressor		removal 229
data	216	
description	228	
removal and installation	228	
second echelon maintenance	91	
Ammeter		
description, removal, and installation	268, 269	

6-TON, 6 x 6 TRUCK (WHITE, CORBITT, AND BROCKWAY)

B—Cont'd		Page No.			Page No.
Brake system			Compression test.....		125
air compressor	228		Conductor, description, removal, and installation.....		166
controls.....	229		Controls (brake system)		
description and data	224		brake camshaft and cone... .		231
electric trailer brake controls .	238		brake chamber.....		229
maintenance.....	227		foot pedal and linkage		231
propeller shaft brake	236		slack adjusters		230
regulators	232		Cooling system		
service brakes.....	234		care in storage		273
adjustment	234		description		156
trouble shooting	119		fan.....		160
Brakes, preparation for rail shipment.....	274		maintenance		156
Bridge erection and crane equipment.....	76		radiators.....		156
spare parts.....	77		thermostat		162
tools	75		trouble shooting		112
Bridge erection truck			water pump		161
auxiliary equipment.....	15		Crane truck		
body style	6		auxiliary equipment.....		15
Bumper and guards, description...	258		body style.....		6
C					
Cab			Crankcase		
cans	251		lubrication		
top	251		Brockway		69
ventilation	250		Corbitt		31
Carbon, removal from combustion chambers, valves, and piston heads	128		White		40
Carburetor			second echelon maintenance		90
adjustment	148		Crankcase ventilator		
description and data.....	148		description		132
removal and installation	149		maintenance		133
second echelon maintenance	93		Cranking motor		
tune-up	126		data		174
Cargo body, description.....	254		description.....		173
Circuit breakers, description	161		lubrication by ordinance personnel		68
Clutch			maintenance and adjustment		174
care and operation in extreme cold	34		removal and installation		175
care and operation in extreme heat.....	33		second echelon maintenance		94
description and operation	170		Cylinder heads (and gaskets)		
maintenance and adjustment	181		installation		128
removal and installation	184		removal		126
run-in test	82		second echelon maintenance		80
second echelon maintenance.....	87		D		
trouble shooting	116		Data		
Clutch pedal, second echelon maintenance	101		brake system		226
			carburetor		148
			clutch		172
			cranking motor		174
			distributor		167
			front axle		202
			generator		177
			governor		153

INDEX

M	Page No.		Page No.
Maintenance		rough terrain	36
batteries	261	sandy terrain	35
brake system	127	Organization tools	108
clutch	183		
cooling system	136	F	
cranking motor	174	Fuze hooks	
distributor	167	description and operation	156
exhaust system	154	installation	157
generator	177	removal	256
oil filter assembly	134	Power take-off	
propeller shafts	195	data	188
rear axle	216	description	187
springs and torque rods	243	installation	190
steering system	247	in transfer case	200
wheels	239	removal	188
winch	272	trouble shooting	117
Maintenance operations	88	Prime mover	
Manifolds, description	130	equipment	76
MWU and major unit assembly		spare parts	77
replacement record	107	tools	75
		Prime mover cargo truck	
O		auxiliary equipment	15
Oil filters		body style	6
description and maintenance	134	Propeller shaft brake	
lubrication		adjustment	236
Brockway	69	data	226
Corbitt	71	description	224
White	67	installation	237
second echelon maintenance	90	removal	237
Oil pan, installation and removal	132	Propeller shafts	
Oil pressure gage, description,		description and data	193
removal and installation	269	installation	195
Oil viscosity gage, description,		in transfer case	201
removal and installation	268	on rear axles	223
Oilless points		location	194
Brockway	70	maintenance	195
Corbitt	72	removal	195
Operation:		R	
clutch	179	Radiator	
ignition system	164	description	156
solenoid switch	175	installation of assembly	159
steering mechanism	247	removal of assembly	157
truck		second echelon maintenance	91
driving the vehicle	26	Radio bonding straps	
starting the engine	24	installation	144
transfer case and front axle		removal	135
controls	27	Radio suppression	
under unusual conditions		analysis of system	170
extreme cold	34	description of noises	171
extreme heat	33	methods of suppression	171
muddy terrain or deep snow	36		

6-TON, 6 x 6 TRUCK (WHITE, CORBITT, AND BROCKWAY)

R—Cont'd	Page No.	Page No.	
Rear axle		Starting (and generating system)	
description and data	214	cranking motor	173
maintenance and adjustment	216	generator	176
removal and installation		walrus switch	175
axle shaft	218	trouble shooting	173
rear axle	221, 223	voltage regulator	178
spring seat	218	Steering	
torque rod	221	description	246
trouble shooting	118	maintenance and adjustment	247
Regulator (brake system)	232	operation of mechanism	247
Reports and records of lubrication	73	replacement of component parts	248
Road test chart	85	Steering gear	
Run-in test, new vehicle	78	operation	247
		removal and installation	249
S		Steering knuckle bearing,	
Second echelon preventive		adjustment	202
maintenance service	83	Steering knuckles, second echelon	
Serial number locations of vehicle		maintenance	99
unit	18	Steering wheel	
Service brakes, removal and		installation	249
installation	234	removal	248
Shipment and temporary storage		Switches	
loading and blocking for rail		blackout driving light	263
shipment	274	cranking motor	261
preparation for temporary storage	273	headlight beam	263
Shipping data	277	ignition	261
Shock adjusters		park light	263
description	239	stop light	267
installation	231		
removal	239	↑	
Solenoid switch		Tachometer, description, removal	
data	176	and installation	267
description and operation	175	Tailights, description	266
removal and installation	176	Temporary storage, preparation for	273
Spark plugs		Terminal block, description	264
description and maintenance	165	Thermostat	
removal and installation	169	description	162
second echelon maintenance	99	removal and installation	162
tune-up	126	Tire and tube assembly, removal	
Specifications of truck	16	and installation	249
Speedometer, description, removal,		Tools and equipment storage on	
and installation	269	the vehicle	
Spring seat		vehicle equipment	76
adjustment	216	vehicle spare parts	77
installation	220	vehicle tools	75
removal	218	Torque rods	
Springs and torque rods		adjustment	216
description	242	description	215
maintenance	243	removal and installation	211
removal and installation of		second echelon maintenance	97
springs	243		
trouble shooting	120		

INDEX

Y—Cont'd	Page No.	U	
Towing rings, removal and installation	257	Universal joints, lubrication	
Towing vehicle	28	Brockway	69
Transfer case		Corbett	72
care and operation in extreme heat	34	White	87
description and data	197		
during-operation service	41	V	
installation of assembly	200	Valve mechanism, second echelon	
operation	27	maintenance	49
removal of assembly	198	Valves, description and adjustment	133
run-in test	82	Vehicle controls	19
second echelon maintenance	87	Vehicle modification records	307
trouble shooting	117	Voltage regulator, description and data	178
Transmission			
care and operation in extreme heat	34	W	
description and data	185	Water pump (and fan)	
during-operation service	41	description	161
installation of assembly	187	maintenance and adjustment	161
power take-offs	187	removal and installation of assembly	160
removal of assembly	186	second echelon maintenance	91
run-in test	82	Wheel bearing	
second echelon maintenance	87	adjustment	107
trouble shooting	116	lubrication	
Transmission shift lever, removal	186	Brockway	70
Trouble shooting		Corbett	72
brake systems	119	White	67
clutch	116	Wheels	
cooling system	113	description	239
engine	109	maintenance and adjustment	239
front axle	117	removal and installation of tire and tube assembly	240
fuel system	111	trouble shooting	120
ignition system	112	Winch	
lighting and switches	122	after-operation and weekly service	46
rear axle	118	controls and operation	29, 30
springs	120	description	270
starting and generating systems steering	113	maintenance	272
transfer case and power take-off transmission	117	removal and installation	272
wheels	120	run-in test procedure	79
windshield wipers	122	Windshield wipers	
Track		description	253
care and operation in sandy terrain	35	removal and installation	254
operation in muddy terrain or deep snow	36	trouble shooting	123
operation over rough terrain	36		
Tune-up of engine	125		