

LULL

MODELS 844-644

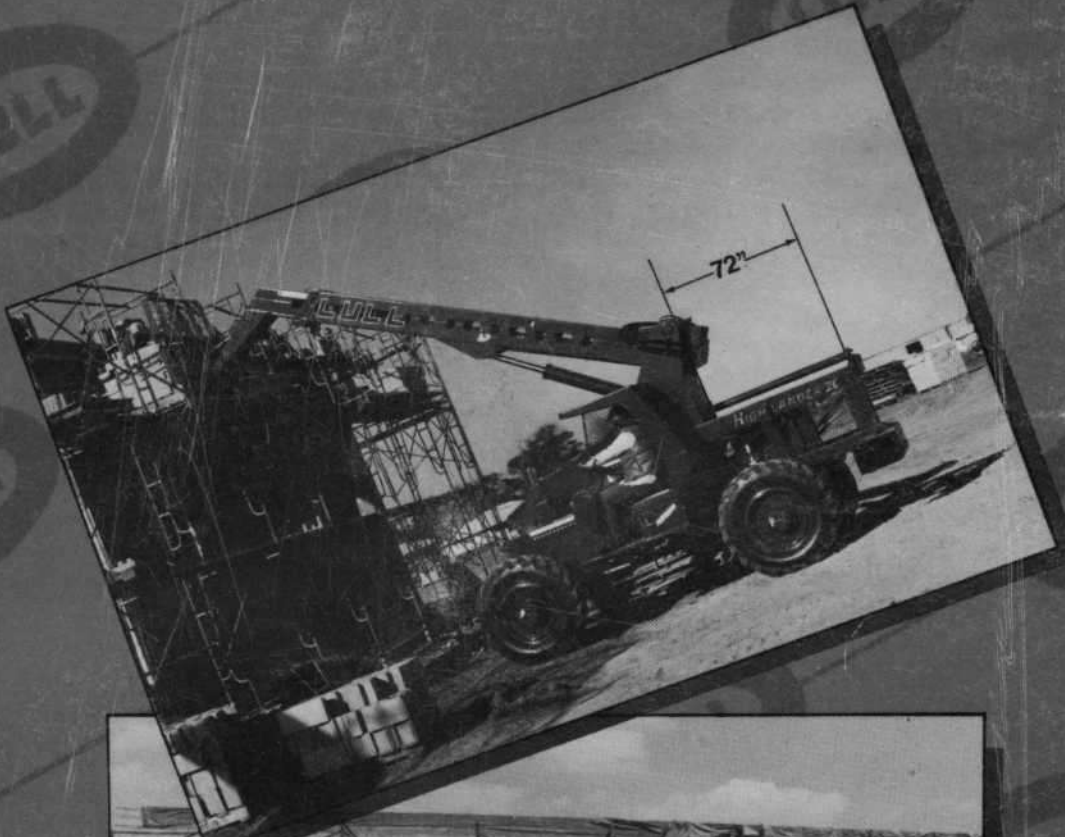

Owner/Operator Manual

INTRODUCTION

You have just purchased the finest forklift available on the market today. The manufacturer, however, has no direct control over your application, operation, inspection, lubrication, and maintenance of this machine. It is, therefore, your responsibility to read and understand the Owner/Operator Manual before operating this equipment to ensure its safe and proper use.

Remember that you are the key to safety. And good safety practices not only protect you but also protect the people around you.

WARRANTY

The Lull warranty is a separate document which will be provided along with this manual to the customer.

Proper registration is an important warranty requirement.

This manual provides information on the operation and maintenance necessary to keep your machine in good working order. Should, however, a defect or failure occur to the machine during the warranty period, contact your local dealer. Under no circumstances must the machine continue in service, because serious damage may result.

REGISTRATION

The Warranty Registration card is to be filled out by the dealer and returned to the Lull Corporation showing the date the machine went into service. And the Pre-Delivery Inspection Form must be signed by the customer when the machine is delivered.



PUB. NO. P09980

INDEX

SECTION

PAGE NO.

MACHINE FAMILIARITY	3,4,5
PRE-OPERATIVE EQUIPMENT CHECKLIST	6
PRE-OPERATIVE INSTRUCTIONS	6
OPERATOR SAFETY	7,8,9,10
STARTING THE ENGINE	11
OPERATING PROCEDURES	12,13
LOAD CHARTS	14,15,16
MAINTENANCE	17,18,19,20,21,22
LUBRICATION	23,24,25,26
SPECIFICATIONS	27,28,29
OPTIONS	30
SAFETY CAUTION AND NOTICE	31,32

MACHINE FAMILIARITY

Side View

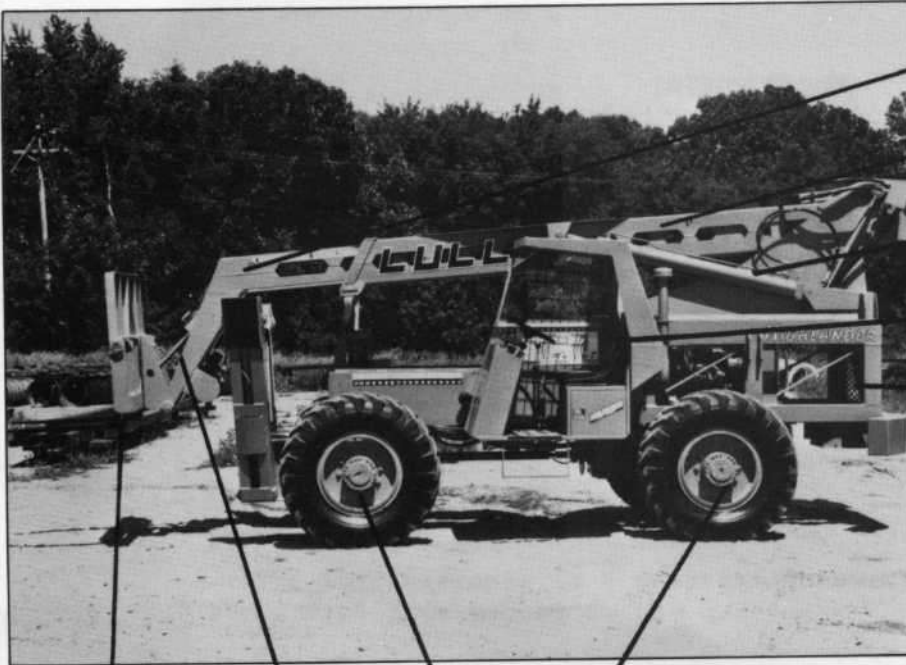

Inner Boom

Outer Boom

Boom Lift Cylinder

Operators Compartment

Engine Compartment

Fork Carriage

Front & Rear Axles

Carriage Tilt Cylinder

Front View



Outriggers

Frame Tilt Cylinder

Fork Carriage

MACHINE FAMILIARITY

Level Indicator

Cab Layout

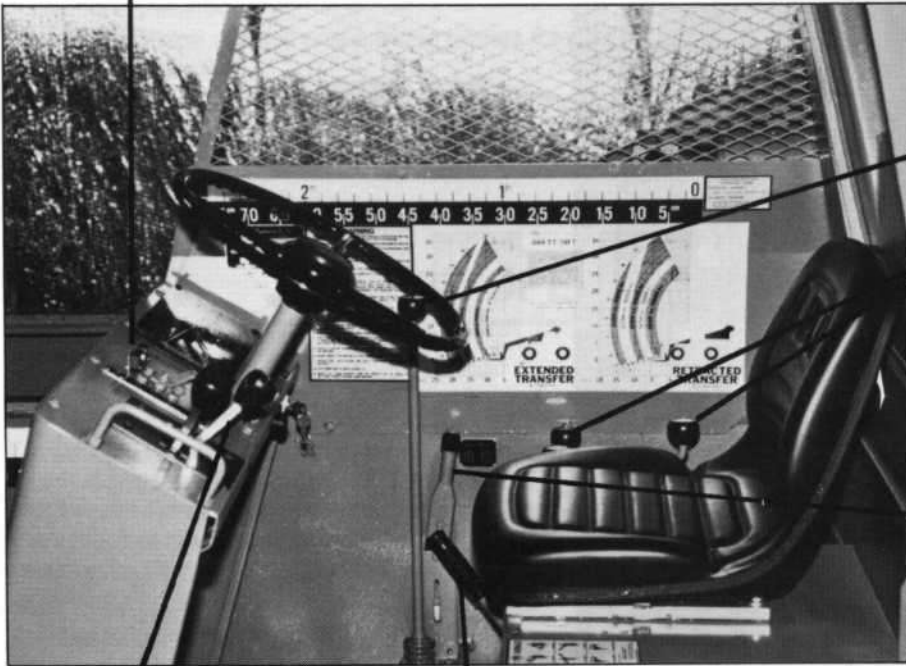

Steering Wheel

Hydraulic Controls

Parking Brake

Transmission Shift
Control

Two Wheel-Four Wheel
Disconnect Lever (844 Only)

Cab Layout

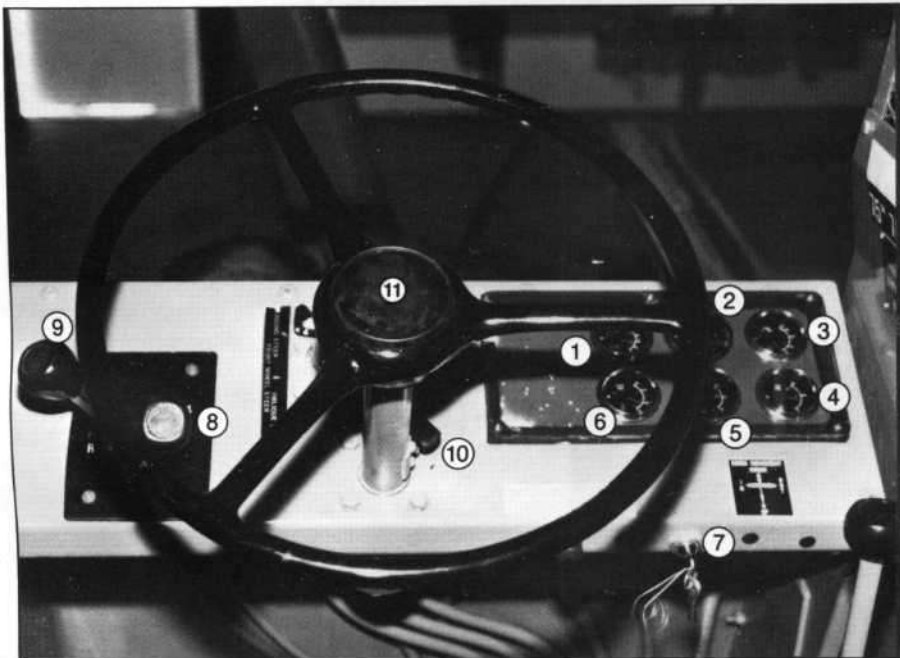

1. Engine Oil Pressure
2. Hour Meter
3. Transmission Oil Temp.
4. Fuel Gauge
5. Ammeter
6. *Engine Water Temp.
7. Ignition
8. Gear Selector
9. Forward or Reverse
10. Steering Selector
11. Horn

*Note: When air cooled engine is used
Item 6 changes to fan belt and
oil light.

MACHINE FAMILIARITY

Cab Layout

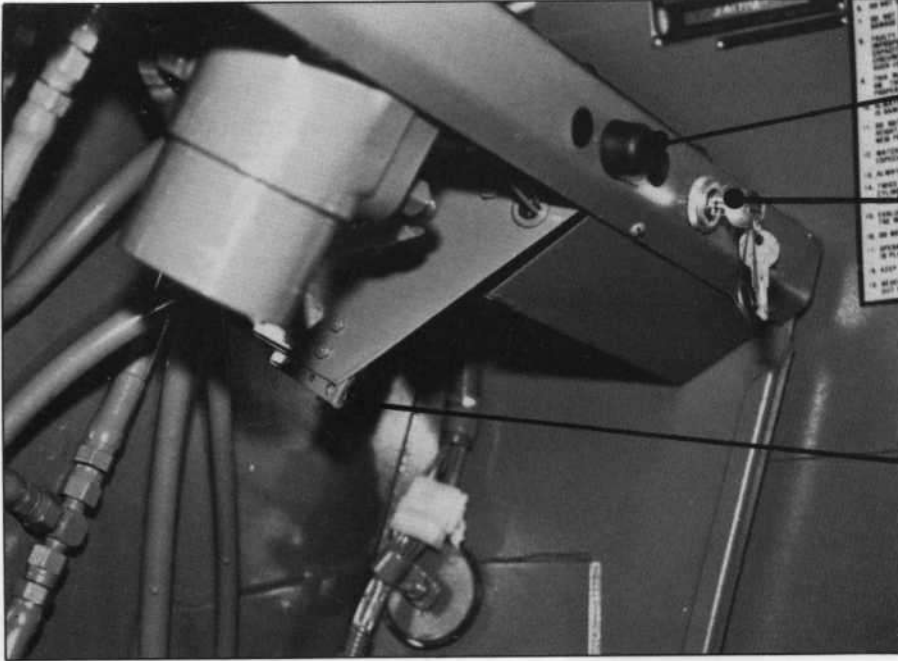

Ether Button

Ignition Switch

Fuses

Hydraulic Controls

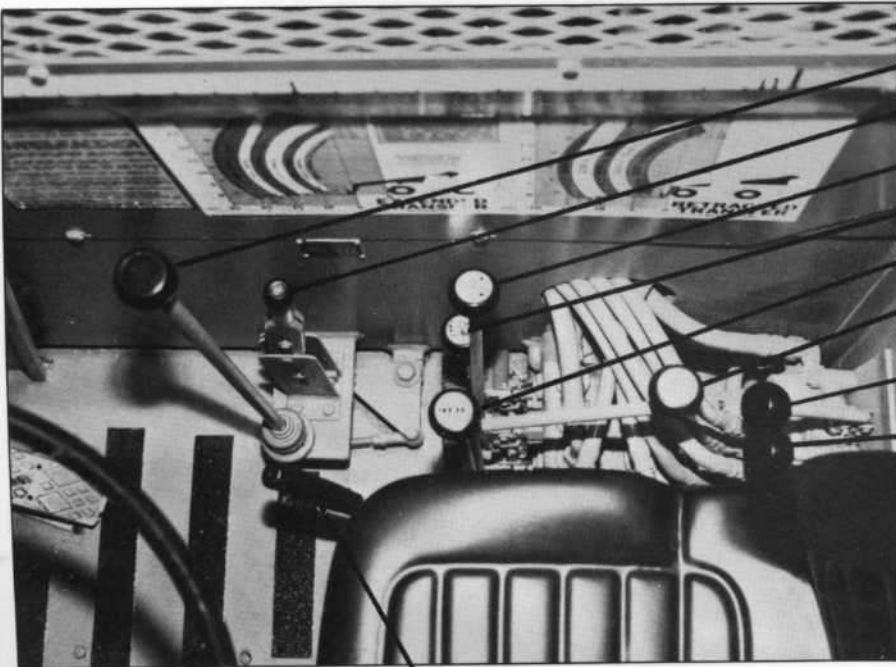

Boom Up & Down

Extend & Retract

Parking Brake

Fork Tilt

Frame Level

Transverse

Auxiliary

Right Outrigger

Left Outrigger

4 Wheel Disconnect

PRE-OPERATIVE EQUIPMENT CHECKLIST

Check The Equipment

- Check the tires for cuts, bulges and correct pressure
- Check service and parking brakes for proper operation
- Check the engine oil system
- Check forks for welds, cracks and misalignment. Have repaired or replaced as necessary.

WARNING: Do not operate a machine whose forks have been repaired by welding unless the welding was specifically authorized by the manufacturer of your forklift.

- Check the hydraulic system
- Check coolant level
- Check wheel lugs
- Check oil cooler and radiator for dirty fins. Not applicable on air cooled Duetz engines.
- Check back-up alarm and horn

PRE-OPERATIVE INSTRUCTIONS

For Safe Operation

For safe operation of this rough terrain forklift, you must be a qualified and authorized operator. To be qualified, you must understand the written instructions supplied by the manufacturer, have training, including actual operation of this machine and know the safety rules and regulations for the jobsite.

An operator should not use drugs or alcohol which can change his alertness or coordination. An operator on prescription or over-the-counter drugs needs medical advice on whether or not he can safely operate machines.

Know The Rules

Most employers have rules governing operation and maintenance of equipment. Before you start work at a new location, check with your supervisor or the safety coordinator. Ask about rules you may be expected to obey. (1)

Make sure you understand the rules covering traffic at your jobsite. Make sure you know what all signs, flags, and markings mean. Make sure you understand hand, flag, whistle, siren, or bell signals. Make sure you know when to use lights, turn signals, flashers and horn or siren.

Protect Yourself

Wear all the protective clothing and personal safety devices issued to you or called for by job conditions.

You may need:

- A hard hat
- Safety shoes
- Safety glasses, goggles, or face shield
- Heavy gloves
- Hearing protection
- Reflective clothing
- Wet weather gear
- Respirator or filter mask.

Wear whatever is needed, don't take chances. (2)

Learn where fire extinguishers and first-aid or emergency equipment are kept and where to get help in a hurry. Make sure you know how to use this equipment.

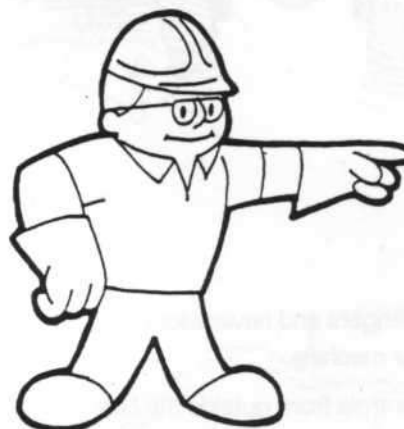

1



2

Mount Properly

Always use "three point contact," facing the machine when you enter or leave. ("Three point contact" means that 3 out of 4 arms and legs are in contact with the machine at all times during mount and dismount.)

Clean your shoes and wipe your hands before climbing on. Use handrails, grab-irons, ladders or steps (as provided) when mounting.

Never use control levers as a hand hold when climbing on or off. Never step on foot controls when mounting or climbing off.

Never enter a moving machine.

OPERATOR SAFETY

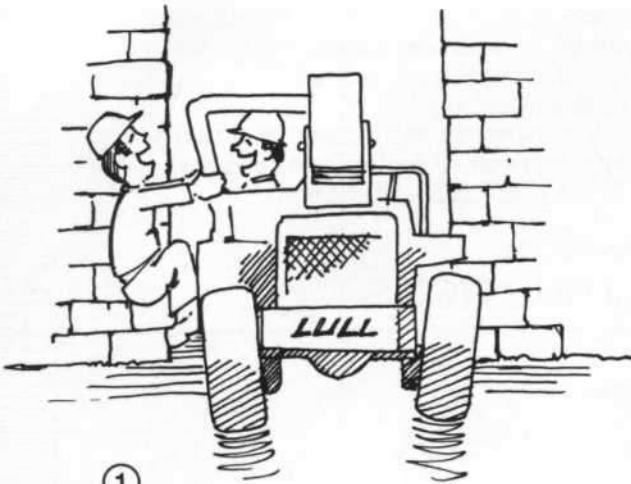

①

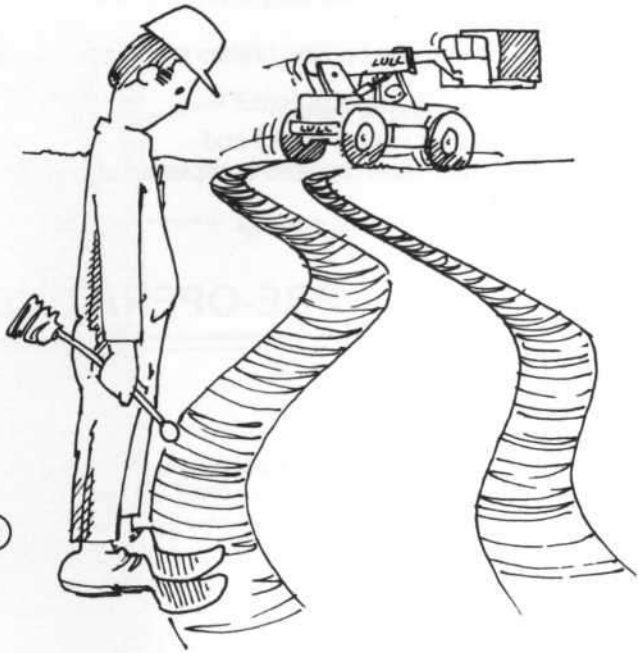

②

1. **Never** carry passengers and never allow unqualified people to use your machine.
2. **Never** operate controls from outside the cab.
3. **Never** walk, or allow others to walk under raised boom.
4. **Always** ensure there is sufficient overhead clearance for the boom.
5. **Never** operate in the vicinity of electrical power lines.



③

⑤

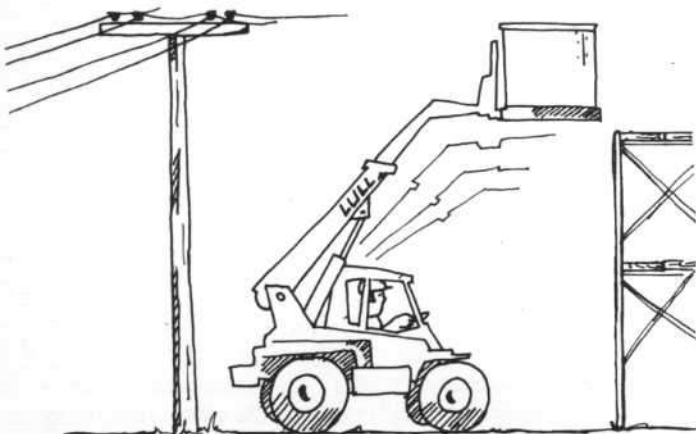

④



⑦

OPERATOR SAFETY



⑥

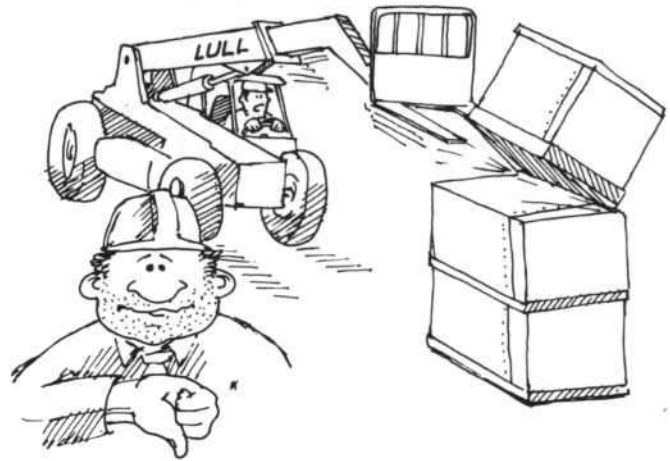

⑦

- 6. **Never** use the machine as a personnel lift.
- 7. **Never** lift a load using one fork.
- 8. **Never** attempt to discharge a load off the fork by stopping machine suddenly.
- 9. **Never** stack a load on uneven ground.
- 10. **Never** place loads that exceed the scaffold capacity.
- 11. **Never** subject scaffold to unnecessary "shock" loads.

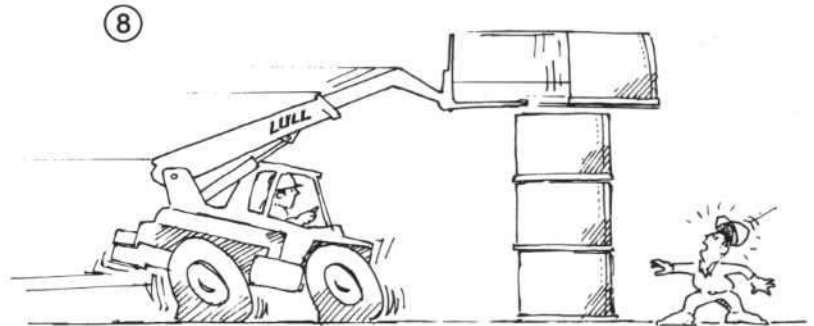

⑧

⑩ ⑪

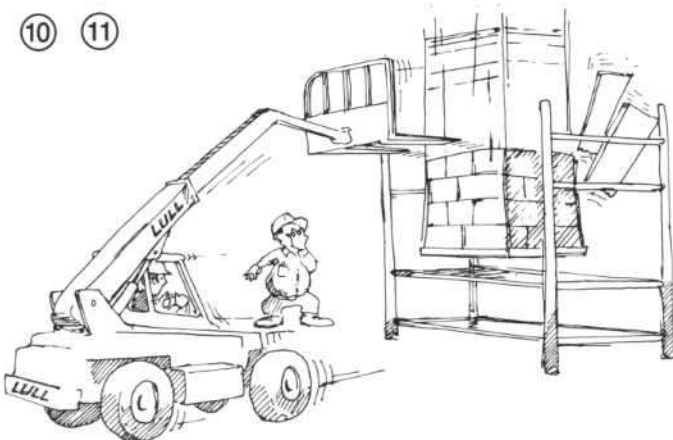

⑨

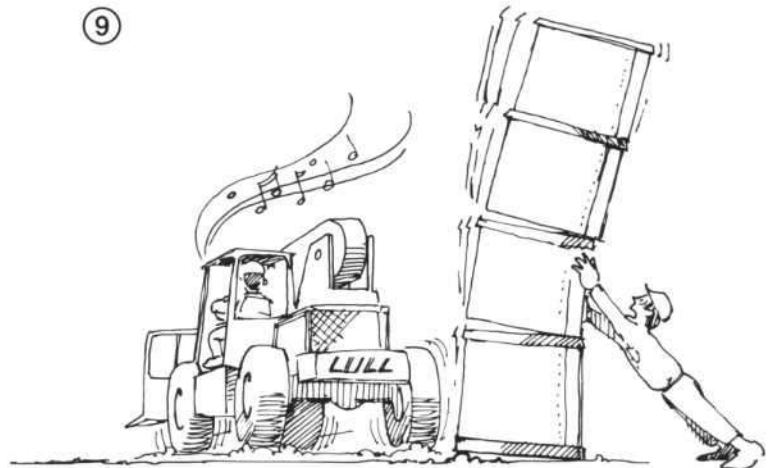

⑧

OPERATOR SAFETY

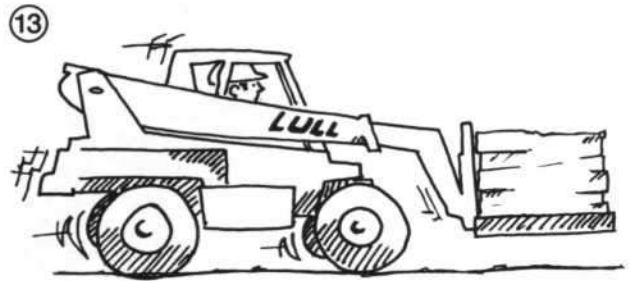
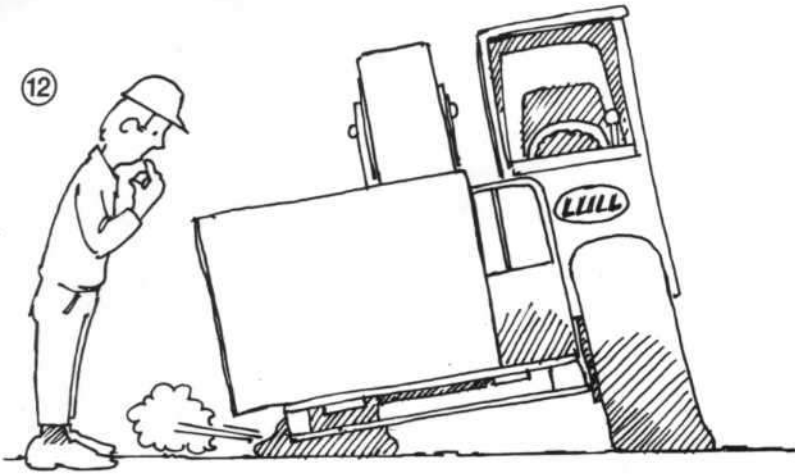

12. **Ensure** that correct tire pressure and calcium chloride levels are maintained (See Specifications on Page 28).
13. **Drive** slow and carry load no higher than your eye level.
14. **Always** be aware of load width.
15. **Ensure** that the load is stable and secure. Check to see there are no loose articles which may fall.
16. **Drive** carefully and avoid any sudden stops and changes of direction.
17. **Always** check the load charts before picking a load.

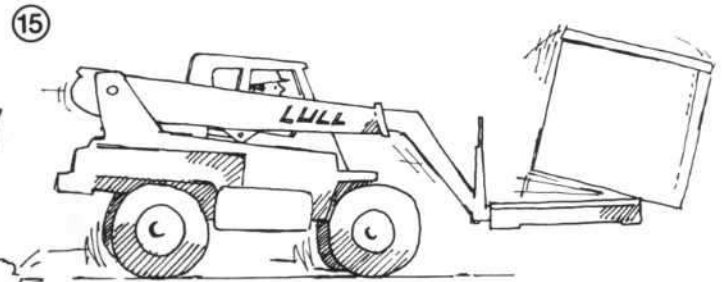
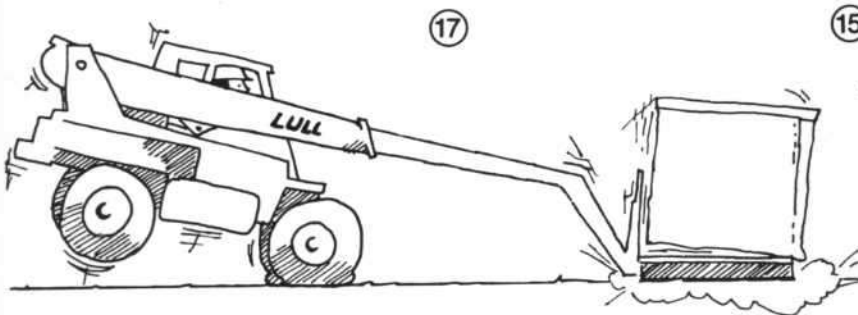
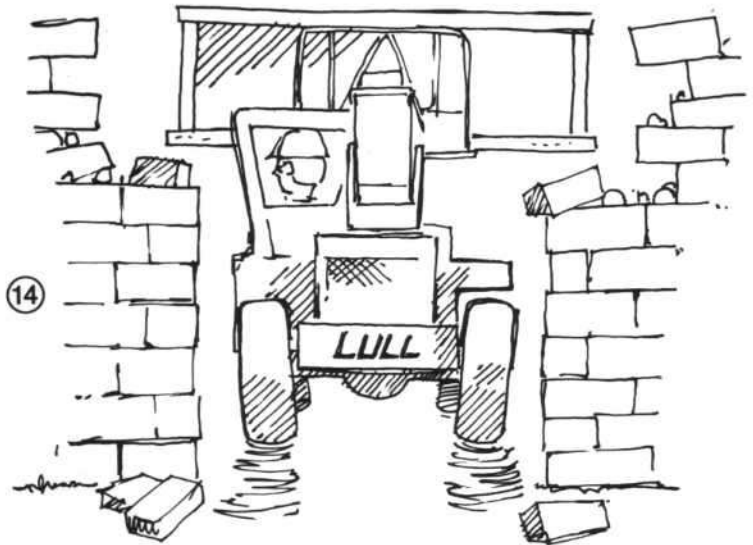

OPERATOR SAFETY

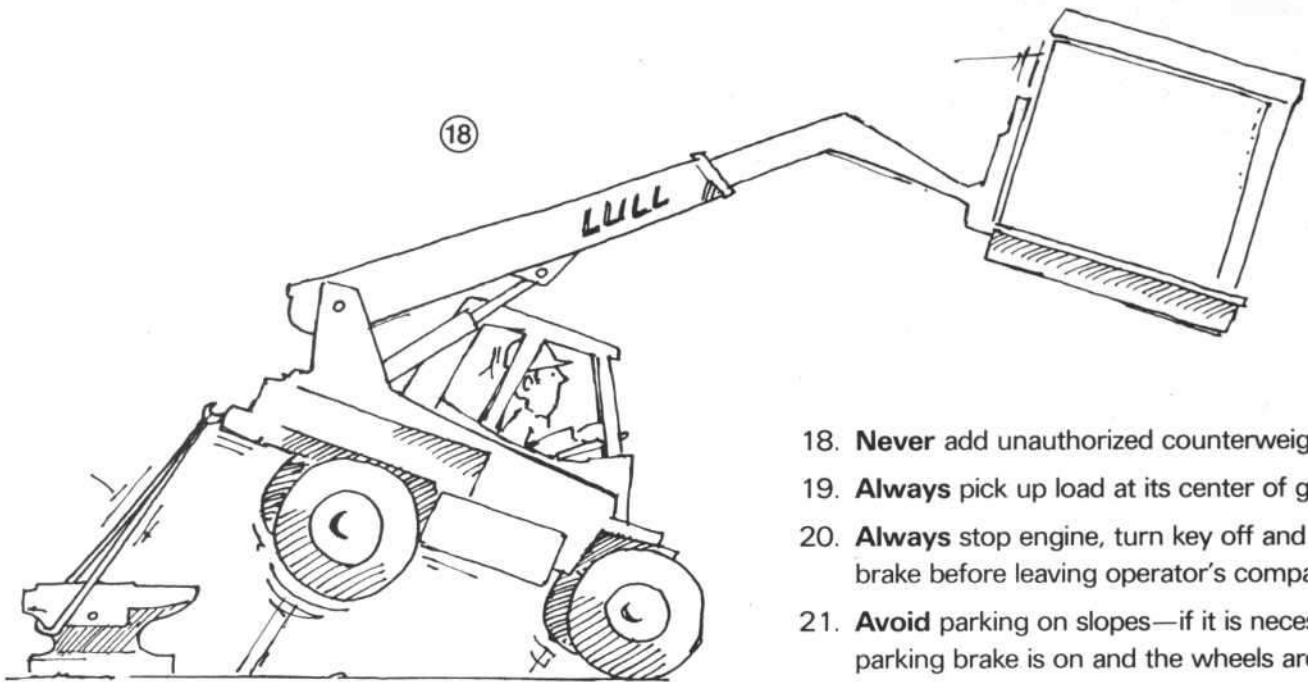

18. **Never** add unauthorized counterweight.
19. **Always** pick up load at its center of gravity.
20. **Always** stop engine, turn key off and set parking brake before leaving operator's compartment.
21. **Avoid** parking on slopes—if it is necessary, ensure parking brake is on and the wheels are chocked.

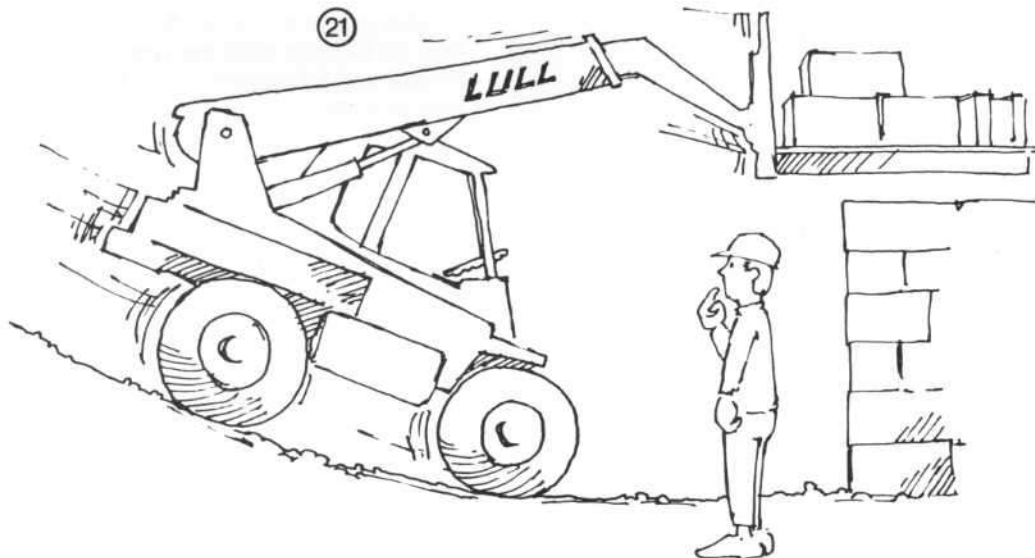
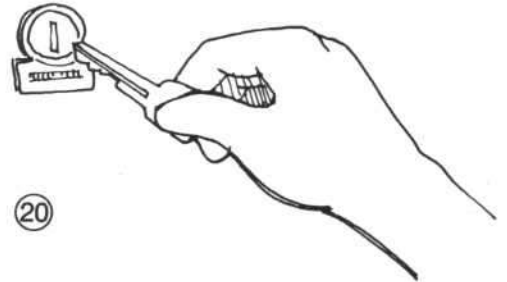
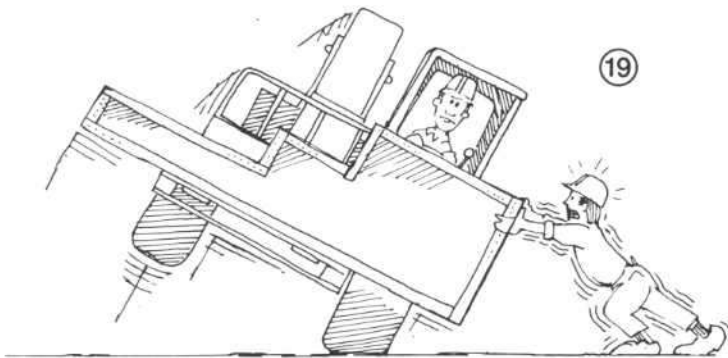

STARTING THE ENGINE



Look Out For Others

Before starting, walk completely around the machine. Make sure no one is under it, on it or close to it. Let other workmen and bystanders know you are starting up and don't start until everyone is clear of the machine.

Starting Procedure (John Deere)

With transmission in neutral turn ignition key clockwise cranking the engine. (Do not crank the engine longer than 20 seconds. Wait 2 minutes before you try again.) NOTE: During cold weather inject starting fluid ONLY while the engine is cold and cranking.

Starting Procedure (Deutz)

With transmission in neutral turn ignition key clockwise cranking the engine. When ambient temp is below 40° ether will automatically dispense into intake manifold. (Do not crank the engine longer than 20 seconds. Wait 2 minutes before you try again.)

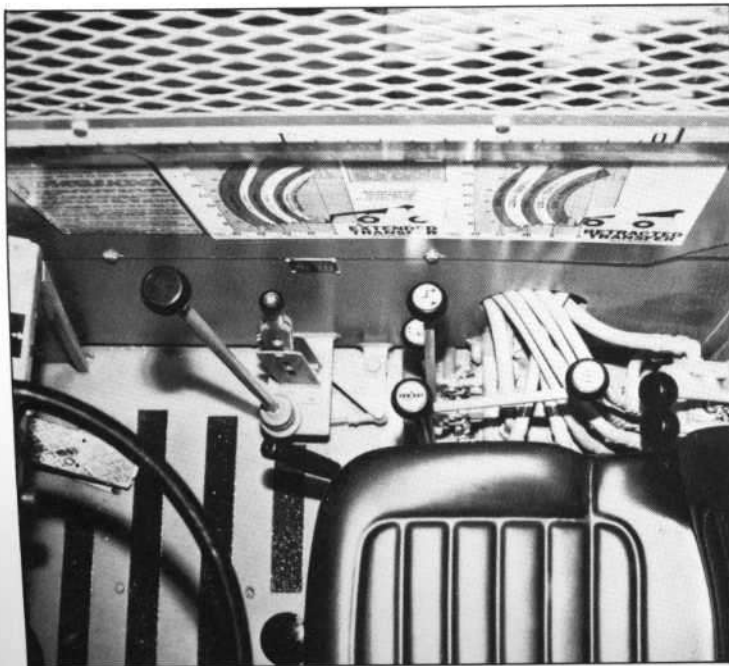

After engine has been started, operate all hydraulic functions. (NOTE: Cold weather operation, only move each function a small distance back and forth until full cycle has been accomplished.)

Level machine, move frame tilt lever to full right over relief then full left over relief then back to level. Raise boom full up to relief and full down to relief. Extend inner boom full out to relief and retract full in to relief. Tilt fork carriage full down to relief and full back to relief. Transfer transverse full forward to relief and return back to relief. When checking these functions ensure parking brake is on. Shut off engine, move all hydraulic levers. If any machine movement is detected advise your supervisor.

*NOTE: Do frame level check every 4 hours.

OPERATING PROCEDURES

IT IS YOUR RESPONSIBILITY TO EVALUATE WORKING CONDITIONS AND ADJUST YOUR OPERATION ACCORDINGLY.

When traveling over rough terrain, soft ground, or wet/icy surfaces, slow down and shift to a lower gear.

Travel only at speeds that permit stopping in a safe manner.

 **WARNING:** KEEP THE LOAD AT EYE LEVEL OR BELOW.

Traveling

- Start and stop machine to check brakes
Note: *Do Not* add fluid to brake reservoir, contact supervisor.
- check parking brake by holding on hill. Tighten knob on handle to adjust.
- Check the three steering modes —
 - 4 wheel
 - 2 wheel
 - Crab or oblique

Follow Safe Operating Practices

- Operate the controls smoothly — don't jerk the steering wheel or hydraulic controls.
- Avoid sudden stops, starts, turns or changes in direction.
- Never "cowboy" or play games with a forklift.
- Never attempt to work the controls except from operator's seat.
- Never leave the operator's seat without first lowering the forks to the ground, setting the parking brake, and placing controls in neutral (or park).

 **WARNING:** Keep all parts of your body inside the operator's compartment while operating the rough terrain forklift.

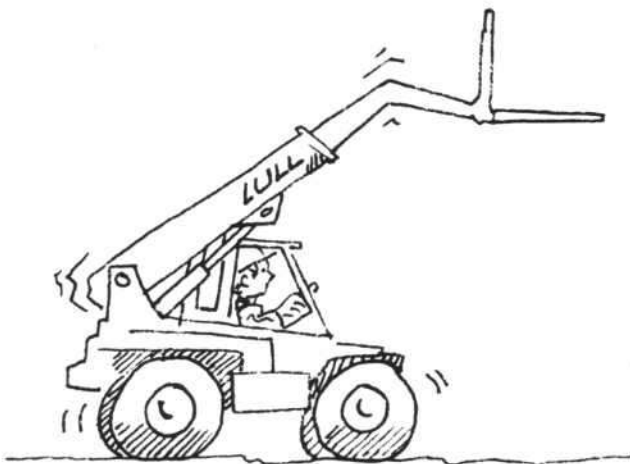

Do not touch, lean on, or reach through the mast, boom or lift mechanism or permit others to do so. Hands off! Never climb on the mast, boom or lift mechanism.

Stay alert. Should something break, come loose, or fail to operate in your equipment, stop work, shut off the engine, set parking brake and alert your Supervisor.

LIFTING THE LOAD

Lift The Load Safely

If possible, plan to load, unload and turn on flat level ground. If not level, use frame tilt to level machine. Level bubble *must* be centered. If loads are to be rehandled several times, place stacking blocks under loads. For sideshift equipped forklifts, center the forks and carriage before lifting.

Inspect load to be lifted. Approach the load slowly and squarely with fork tips straight and level. If necessary, adjust pallet forks. Boom slowly forward and engage load. Position load equally on both forks. Boom forward until load touches the carriage (backrest).

Tilt the forks back to position the load for travel, then lift the load only enough to clear obstacles. Avoid erratic stops. Be sure there is sufficient clearance overhead and all around for lifting and traveling. Watch the machine's rear clearance when you turn.

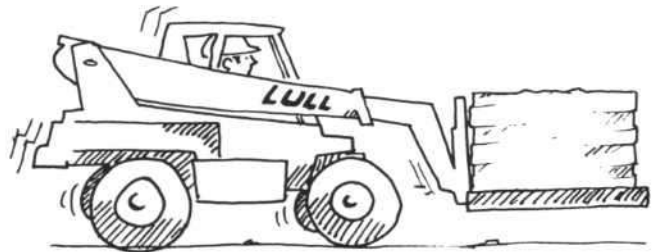

Transport The Load Safely

When you travel with a load, keep the forks tilted back with boom retracted and the load as close to the ground as possible.

 **WARNING:** ALWAYS CARRY THE LOAD NO HIGHER THAN EYE LEVEL.

WARNING: Failure to abide by these precautions could result in the forklift tipping over or losing the load.

Avoid excessively steep slopes or unstable surfaces. If you must drive on a slope, Frame Level machine, keep the load low and proceed with extreme caution. Do not drive ACROSS excessively steep slopes under any circumstances.

 **WARNING:** Travel on inclines, slopes, ramps and downgrades only as follows:

LOADED forklift . . . with forks (and load) pointed uphill.

EMPTY forklift . . . with forks pointed downhill.

Reduce speed and sound horn at blind intersections, exits and when approaching pedestrians.

OPERATING PROCEDURES

Slow down for turns, ramps, dips, uneven or slippery surfaces and in congested areas. Avoid driving over loose objects and holes in roadway surfaces to prevent losing the load or tipping the machine.

Avoid crossing ditches, curbs or exposed railroad tracks. If crossing cannot be avoided, keep the load as low as possible, travel very slowly, and proceed with caution.

Avoid panic braking. Apply brakes smoothly for a controlled stop to prevent toppling the load.

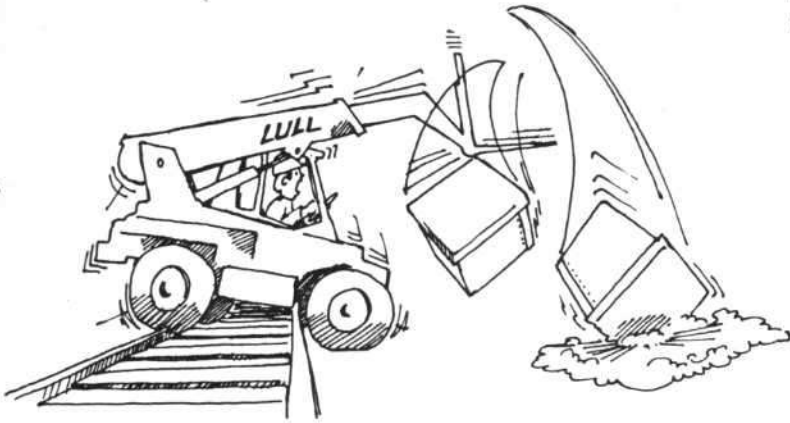

SAFELY PLACING THE LOAD

Elevated or Overhead Placement

When stacking or placing a load high, use extreme caution because there may be other workmen in the immediate area whom you cannot see. Make sure that bystanders are away from the area where the load can tip or fall.

Bring the forklift as close to the landing point as possible with the load held low. DO NOT raise the load for placement if the forks are tilted to one side. Level machine using frame tilt BEFORE the load is raised. (If your machine has outriggers, these should be lowered into position.)

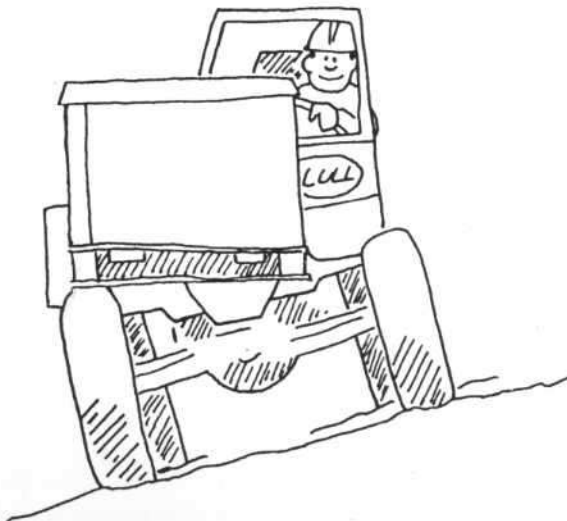

Set the parking brake back. Tilt carriage to cradle the load. Slowly and carefully raise the load.

CAUTION: As lift height increases, your depth perception decreases. Placing the load safely at a high elevation may require a signalman to guide you.

If there is any indication of instability during the lift (i.e. movement, leaning, swaying), stop immediately, lower the load, move the forklift to a more stable, level position.

As the load approaches the desired height, slow the lift speed to a minimum. Continue the lift until load is slightly higher than the landing point.

CAUTION: Do not ram a hydraulic lift cylinder to the end of its stroke. The resulting jolt could spill the load.

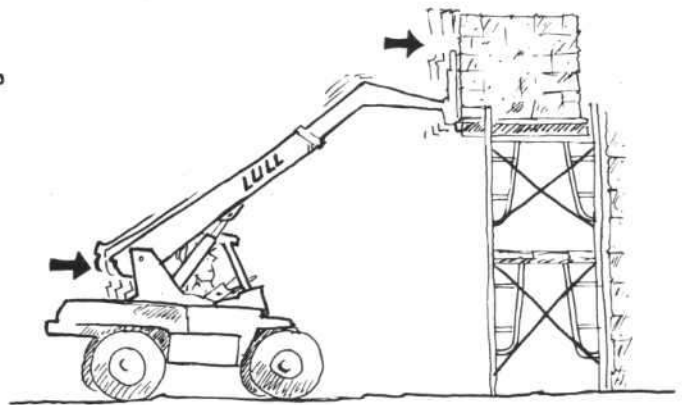

Once the load is higher than the landing point use the transverse to place the load directly over the landing point. Consult Load Chart* for transverse capacity. Forks should be nearly level and parallel to the landing surface so they may be easily retracted from under the load.

*See Pages 14, 15, 16 For Load Chart

Safe Shutdown

Correct shutdown is important to safe operation. Follow these general steps.

- Come to a full stop.
- Set parking brake.
- Lower forks to the ground.
- Place controls in neutral (or park).
- Idle engine for 1-3 minutes for gradual cooling.
- Shut off engine.
- Cycle hydraulic controls to eliminate residual pressure.
- Remove ignition key.
- Lock anti-vandalism covers and closures.
- Dismount.
- Block wheels if on a slope or incline.

LOAD CHARTS

Use angle and extension indicator for correct capacities.

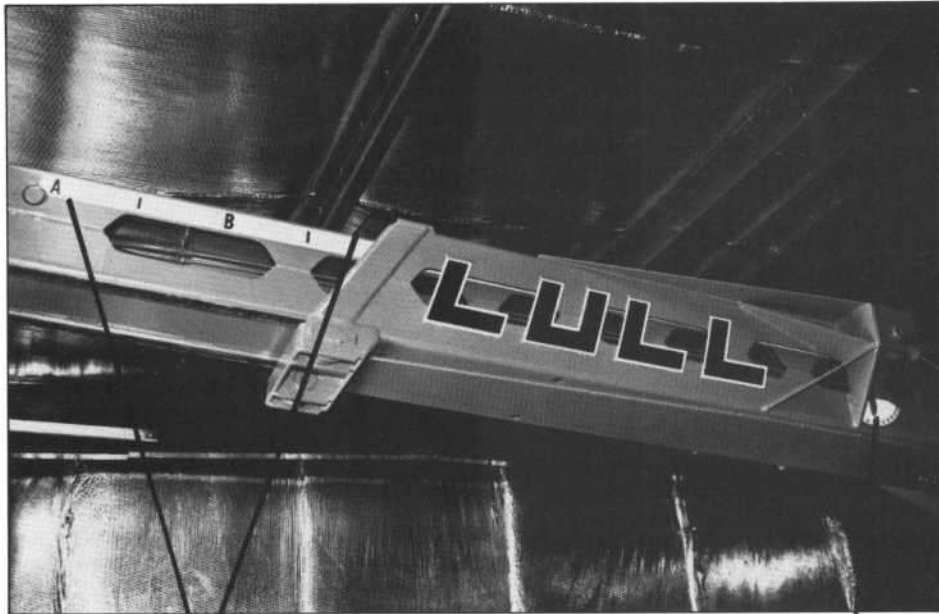

Inner Boom Extension Indicator

Angle Indicator

644 Load Chart

MODEL 644 HIGHLANDER II

MAXIMUM BOOM LOAD CAPACITIES FOR LIFT
AND REACH POSITIONS IN POUNDS/FEET
WITH METRIC CONVERSIONS
ALL CAPACITIES ARE ON
A 24" LOAD CENTER BASIS

BOOM ANGLE AND REACH INDICATORS ON
THIS CHART REPRESENT THE CENTER OF
GRAVITY OF ANY LOAD AS SHOWN WITH
INDICATOR POSITION 'A'.

VARIATIONS OF LOAD SIZES AND EXTENDED
LOAD CENTERS MUST HAVE THEIR CENTER
OF GRAVITY CORRESPOND TO THE LOAD
AND POSITION LIMITS OF THIS CHART.

MANUFACTURE'S RECOMMENDED CAPACITY
LIMITS FOR THIS LOADER ARE BASED IN
ACCORDANCE WITH ANSI B56.6 STABILITY
TESTS USING A STANDARD HOMOGENEOUS
CUBE 4'x4'x4'.

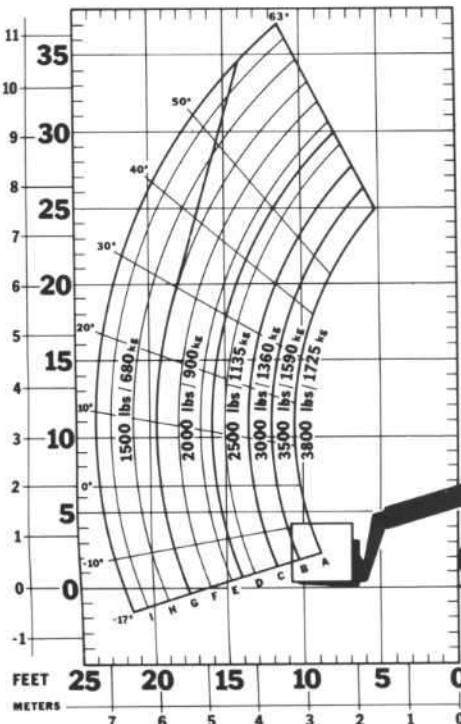

EXTENDED TRANSFER

WITHOUT STABILIZERS

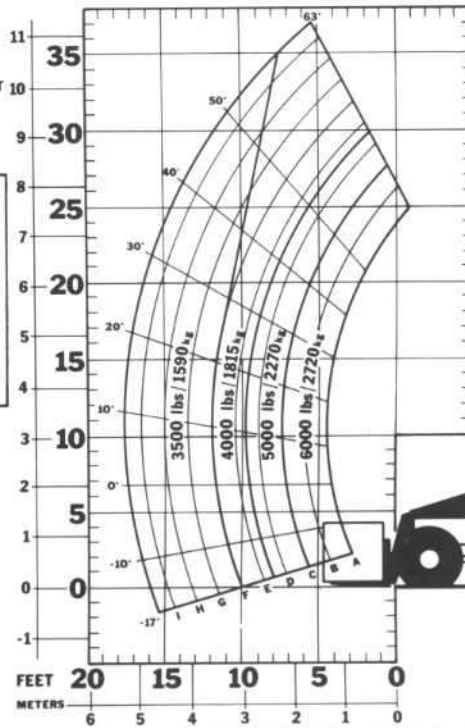

RETRACTED TRANSFER

LOAD CHARTS

844 Load Chart

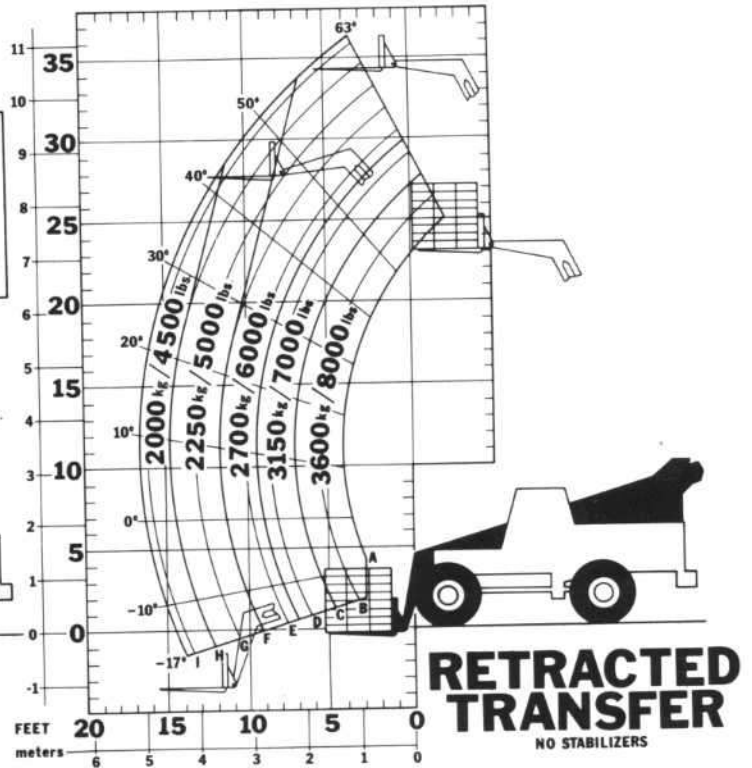
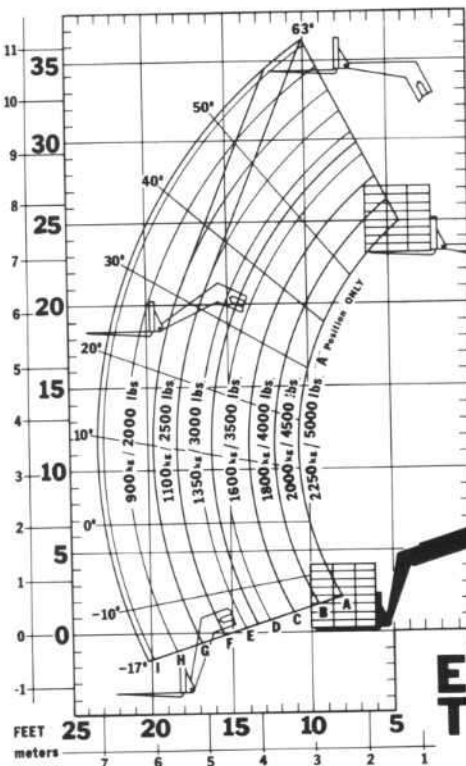

844 Load Chart With Truss Boom

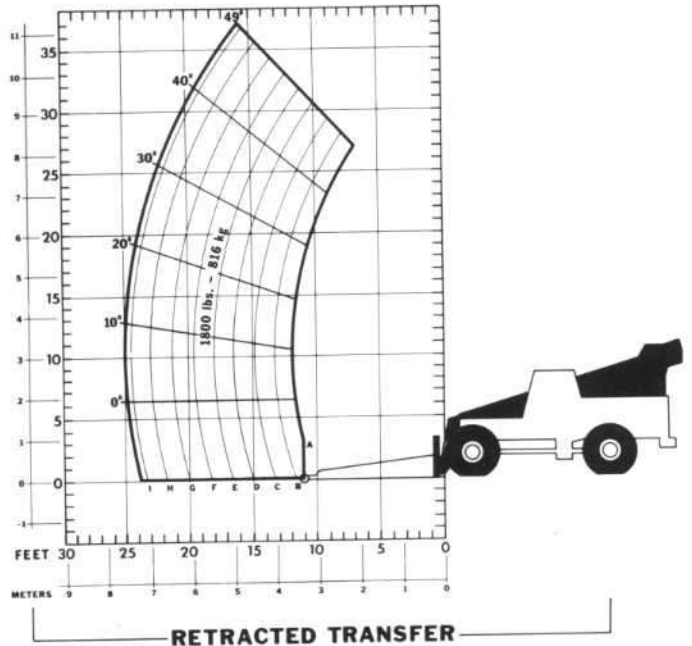
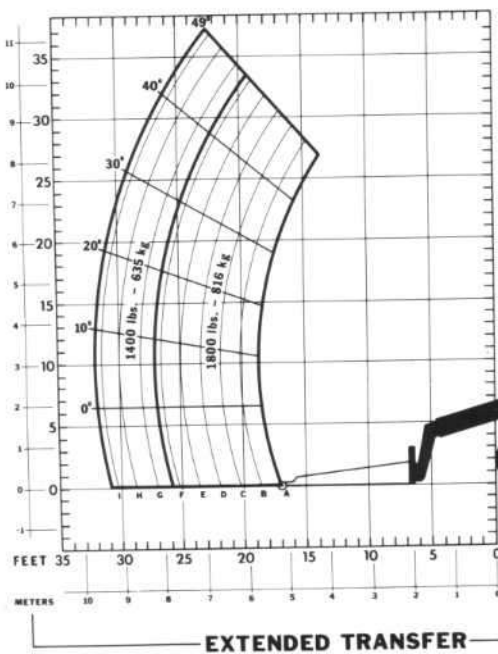

LOAD CHARTS

844 Load Chart With Tower

MODEL 844 WITH 42' TOWER

MAXIMUM BOOM LOAD CAPACITIES AT 24" LOAD CENTER. FOR LIFT AND REACH POSITIONS IN POUNDS/FEET WITH METRIC CONVERSIONS

BOOM ANGLE AND REACH INDICATORS ON THIS CHART REPRESENT THE CENTER OF GRAVITY OF ANY LOAD AS SHOWN WITH INDICATOR POSITION "A". VARIATIONS OF LOAD SIZES AND EXTENDED LOAD CENTERS MUST HAVE THEIR CENTER OF GRAVITY CORRESPOND TO THE LOAD AND POSITION LIMITS OF THIS CHART.

MANUFACTURER'S RECOMMENDED CAPACITY LIMITS FOR THIS LOADER ARE BASED IN ACCORDANCE WITH ANSI B56.6 STABILITY TESTS USING A STANDARD HOMOGENEOUS CUBE 4'x4'x4' (1.2m x 1.2m x 1.2m)

LULL CORPORATION

ST. PAUL, MINNESOTA 55121

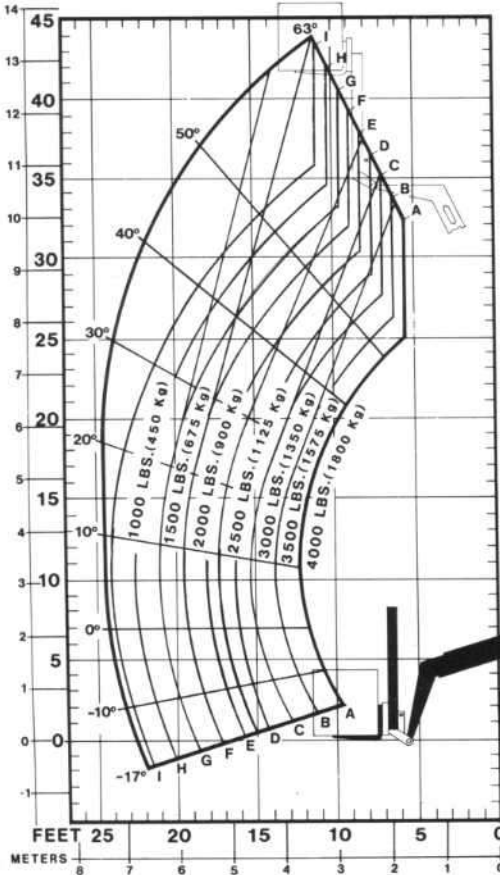

EXTENDED TRANSFER

WITH DUAL WHEELS OR OUTRIGGERS

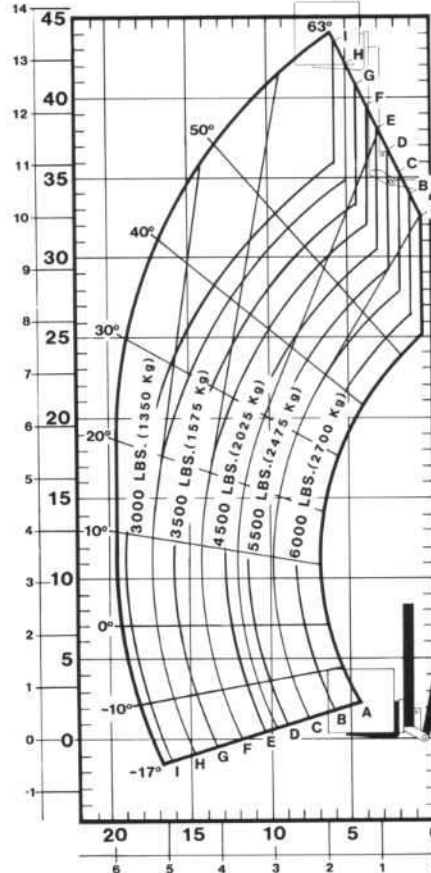

RETRACTED TRANSFER

WITH DUAL WHEELS OR OUTRIGGERS

WARNING

1. LOAD MUST NOT EXCEED 4500 LBS. (2000 KG) WITH FORKS ELEVATED ANYWHERE ON TOWER.
2. THIS MACHINE MUST BE EQUIPPED WITH EITHER DUAL WHEELS OR OUTRIGGERS. OUTRIGGERS MUST BE DOWN AND PLANTED WHEN HANDLING LOADS AT HEIGHTS OF 25 FEET OR MORE.
3. DO NOT TILT TOWER MORE THAN 20° FORWARD OR 20° BACKWARD WITH LOAD ON FORKS.
4. ALWAYS TRAVEL WITH TOWER AND FORK CARRIAGE LOWERED.
5. BE THOROUGHLY FAMILIAR WITH OPERATORS MANUAL AND WARNING DECALS BEFORE OPERATING THIS MACHINE.

MAINTENANCE

Transmission

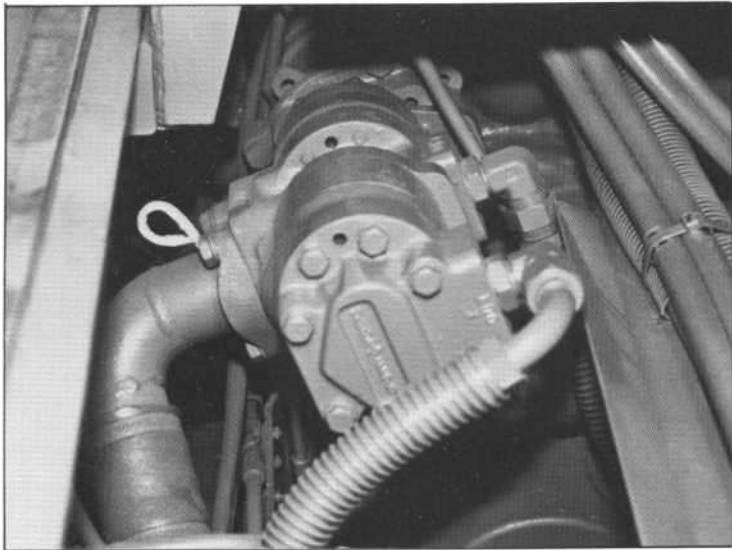

Trans Oil Check

1. The Powershift should always be in the neutral position before starting the engine, or when the vehicle is parked and the engine is running.
2. If the vehicle is to be towed, it will be necessary to run the engine at idle speed to lubricate the clutches.
3. If the oil temperature gauge, which is the converter oil out temperature, rises above 250°F. (121.1°C.) or the warning light comes on, stop the vehicle immediately. Shift to neutral and run the engine at 1000-1200 RPM. The temperature should drop rapidly to the engine water temperature. If the temperature does not drop, trouble is indicated. The trouble should be determined before the vehicle is operated again. Overheating generally occurs due to working in too high of a gear ratio.
4. Do not shut off engine when unit is overheating.

Transmission Oil Fill

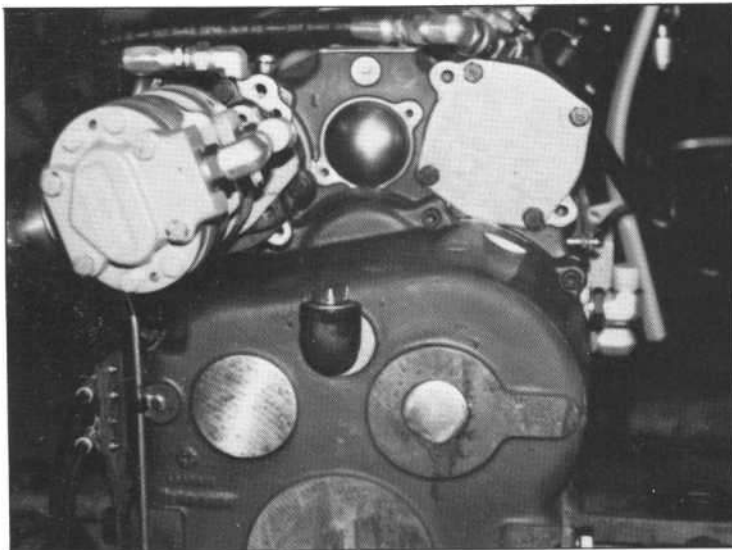

Trans Oil Check and Fill

1. The oil level is always checked daily with the engine running at idle and at operating temperature and the powershift™ in neutral. Note dipstick top picture.
2. When servicing the unit for the first time after vehicle installation and/or after repair, the unit is filled as follows:
 - A. Fill the unit with recommended lubricant. (Check Lube Chart)
 - B. Start engine and run at idle speed to let the hydraulic system charge.
 - C. With the engine at idle speed, finish filling unit to full level. This will take approximately 3 quarts (2.84 liters), but will vary with each application.

Air Cleaner Dirt Indicator

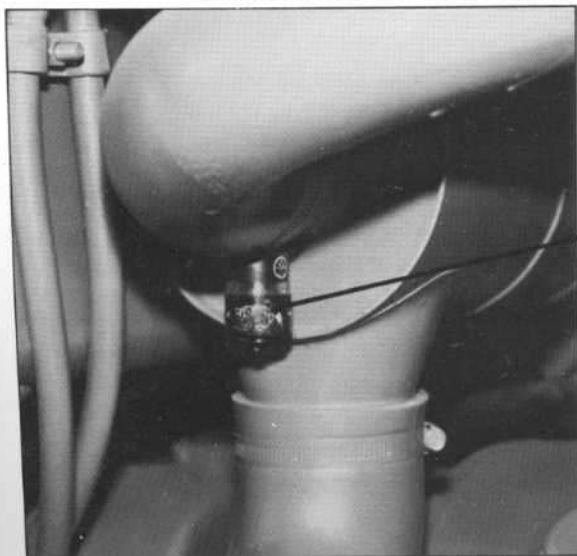

Filter Dirt Indicator
Change When
Red Is Showing

Battery Location and Check

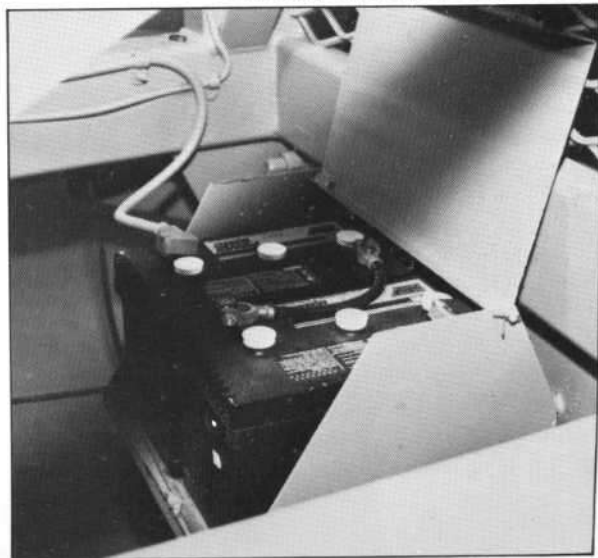

1. Battery located behind engine compartment.
2. Check fluid level every 100 hrs.

MAINTENANCE

Oil Check

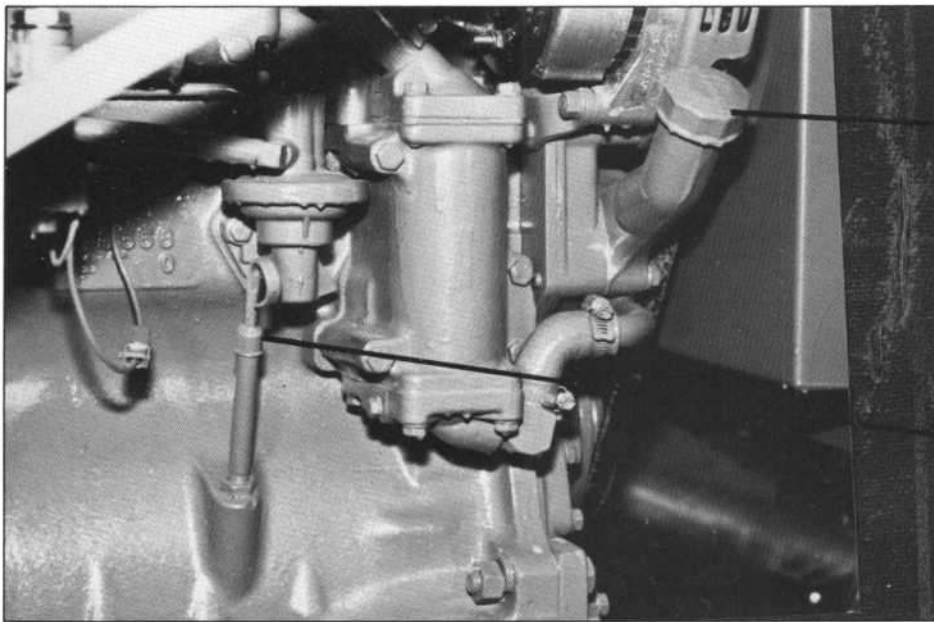

Oil Add

Dipstick
Check Daily

Oil Drain

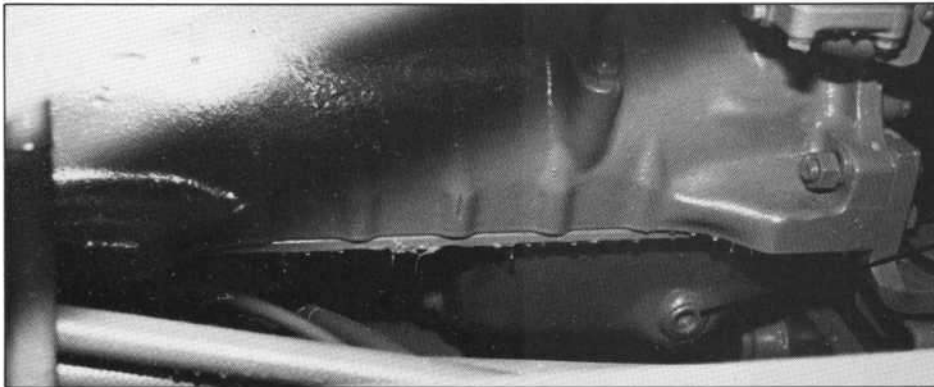

Drain Plug

Fuel & Oil Filters

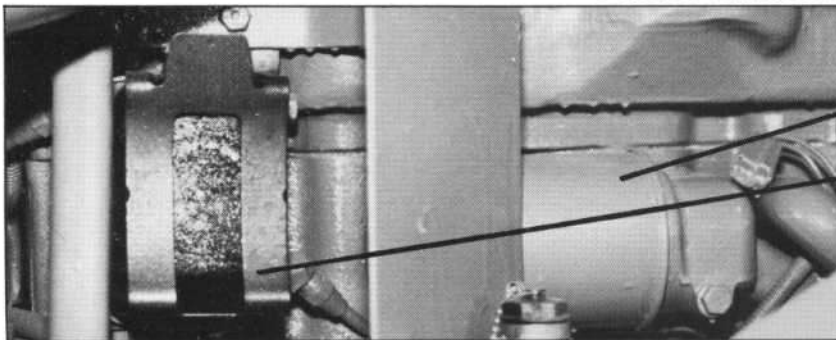

Oil Filter

Fuel Filter

Install a new fuel filter element.

NOTE: Change the element at 500 hours or once a year. If you operate the engine under difficult conditions, change the element more often.

1. Push tab (A) and pull tab (B) to disengage hook (C).
2. Disengage hook (D).
3. Remove spring (E).
4. Remove element (F).
5. Clean the filter body (G) and fuel tube (J).
6. Install new element. Install spring.
7. Loosen bleed screw (H).
8. Pump the primer lever until fuel without bubbles flows from around the bleed screw.
9. Tighten Bleed Screw.

