

assembly and operating instructions

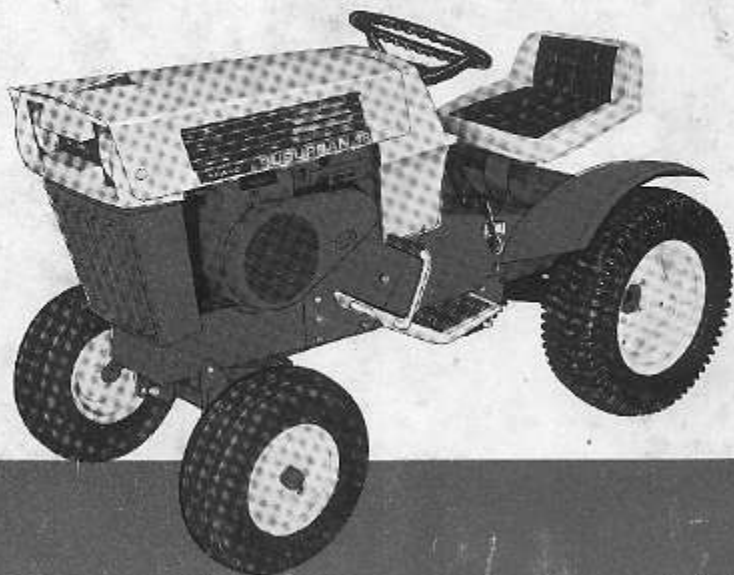

Sears

Suburban 12 Tractor

SEARS, ROEBUCK AND CO. U.S.A.
SIMPSONS-SEARS LIMITED CANADA

INDEX

DESCRIPTION	PAGE NO.	DESCRIPTION	PAGE NO.
Parts Identification and Features	2 and 3	Lubrication Chart	11
Rules of Safety	4	Belt Adjustment	12
Setting Up Instructions	5 and 6	Brake Adjustment	12
Fill and Charge Battery	5	Park Brake Lock Adjustment	12
Battery Installation	5 and 6	Weights—Rear Wheel, Front and	
Belt Guard	6	Rear End	13
Before Starting the Engine	6 and 7	Battery Care — Important	13
How to Start and Stop Tractor	7 and 8	Trouble Shooting	14
To Operate Tractor	8	Maintenance and Service	15
Safe Operation	9	Starter—Generator Belt Adjustment	15
Seat Position	9	How to Start if Battery is Low	15
Towing Tractor	9	Tires	16
Engine Pulley Grooves to Use for		Winter Care	17
Your Various Attachments	9	Storage Instructions	17
Starter Air Screen	9	General	17
Air Cleaner	10	Guarantee	Back Page
Engine Lubrication	10		
Transaxle Lubrication	10		

TO THE SUBURBAN OWNER

Please accept our congratulations on your investment in a Sears Suburban Tractor. We feel you will obtain from your Suburban the economical and superior performance it is designed to give. It is certain that you will derive a large measure of personal satisfaction from its operation.

Years of tractor manufacturing experience and contact with the actual customer have been combined with advancements in engineering to produce all the features and refinements built into your tractor.

Properly adjusted, operated and maintained, this tractor will respond to every reasonable demand you make upon it and give you reliable service for years to come.

MODEL NUMBER 917.25550

PARTS IDENTIFICATION

ENGINE:

CHECK OIL LEVEL AFTER EVERY 5 HOURS OF OPERATION.
CHANGE OIL LATER (FIRST) EACH 25 HOURS OF OPERATION.

TRANSMISSION:

CHECK OIL EVERY 50 HOURS OF OPERATION.
CHANGE OIL AFTER EACH 300 HOURS OF OPERATION.

AIR CLEANER:

CLEAN CARTRIDGE AIR CLEANER PERIODICALLY.
ON RECOIL START ENGINE, KEEP POSITION CLEAN.
ON ELECTRIC START ENGINE, KEEP SCREEN CLEAN.

LUBRICATION:

FRONT SPINDLES EVERY 5 HOURS OF OPERATION.
FRONT WHEELS EVERY 2 HOURS OF OPERATION.
STEERING MECHANISM EVERY 5 HOURS OF OPERATION.

TIRE PRESSURE:

4.0/4.00 X 9-15 120 14 X 5.50 X 9-17 175
22 X 7.50 X 17-8 185 22 X 8.50 X 13-8 185

BRAKE:

KEEP WEDGE AND PARKING BRAKE LOCK IN ADJUSTMENT.

BATTERY:

CHECK SOLUTION LEVEL EACH WEEK. ADD DISTILLED WATER
IF NECESSARY.

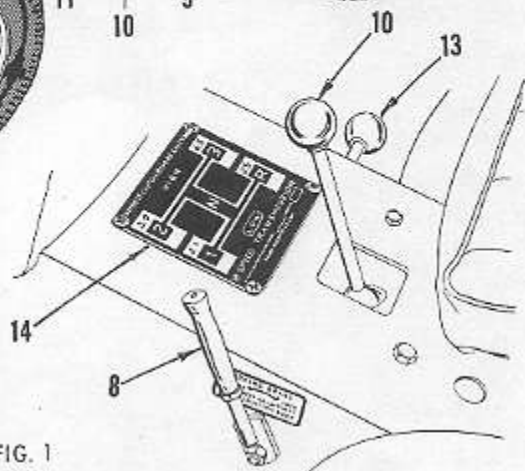
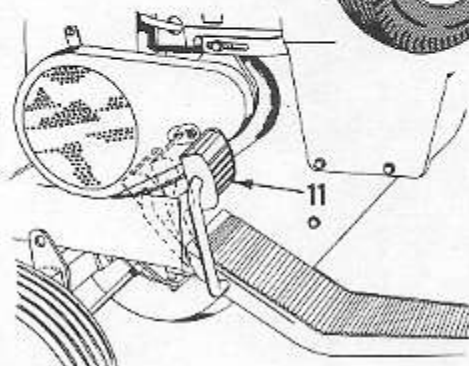
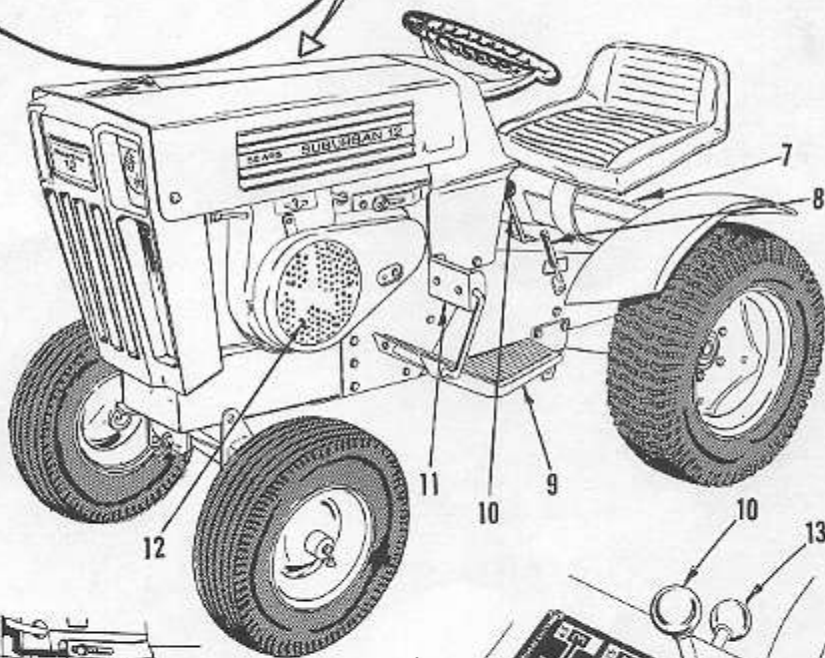
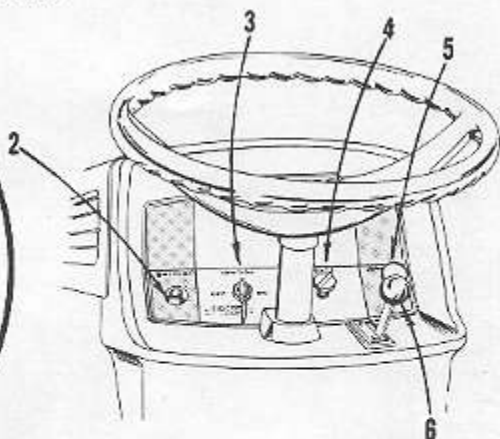
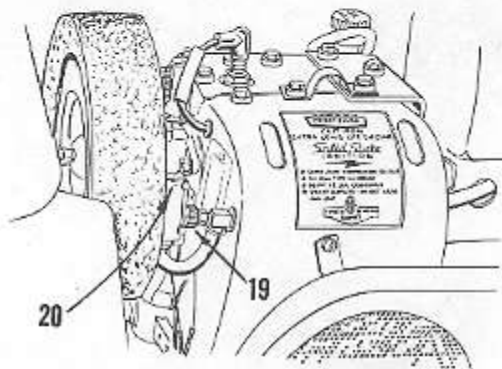
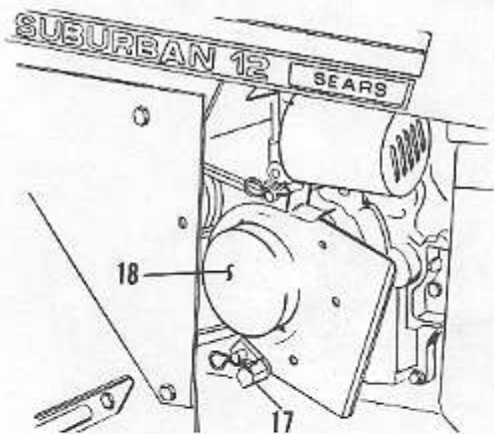
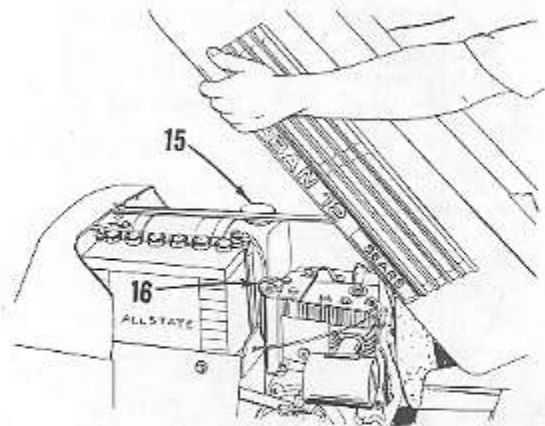

FIG. 1

PARTS IDENTIFICATION

1. MAINTENANCE REMINDER
(Located on Underside of Hood)
2. BATTERY WARNING LIGHT
3. IGNITION SWITCH
4. LIGHT SWITCH – Headlights and Tail Light
5. CHOKE
6. THROTTLE CONTROL LEVER
7. TOOL BOX
8. PARKING BRAKE
9. FOOT REST
10. GEAR SHIFT LEVER
11. DRIVE, CLUTCH AND BRAKE PEDAL
12. STARTER AIR SCREEN
13. RANGE SHIFT LEVER (High-Low Range)
14. MODEL NUMBER PLATE
15. FUEL TANK CAP AND GAUGE
16. OIL FILLER CAP AND DIP STICK
17. ENGINE OIL DRAIN PLUG
18. BELT GUARD
19. FUEL TANK SHUT-OFF VALVE
20. CARBURETOR DRAIN
(Located on Right Hand Side)



YOU CAN DO MANY JOBS EASILY WITH THE WIDE VARIETY OF ATTACHMENTS BUT, FIRST OF ALL BE CAREFUL!

DO NOT START, RUN OR REFUEL IN A CLOSED BUILDING.

ONLY ONE PERSON ON THE TRACTOR AT A TIME.

FIG. 2

RULES OF SAFETY

YOU CAN DO
MANY JOBS
EASILY WITH THE
WIDE VARIETY OF
ATTACHMENTS
FIRST
BE CAREFUL!

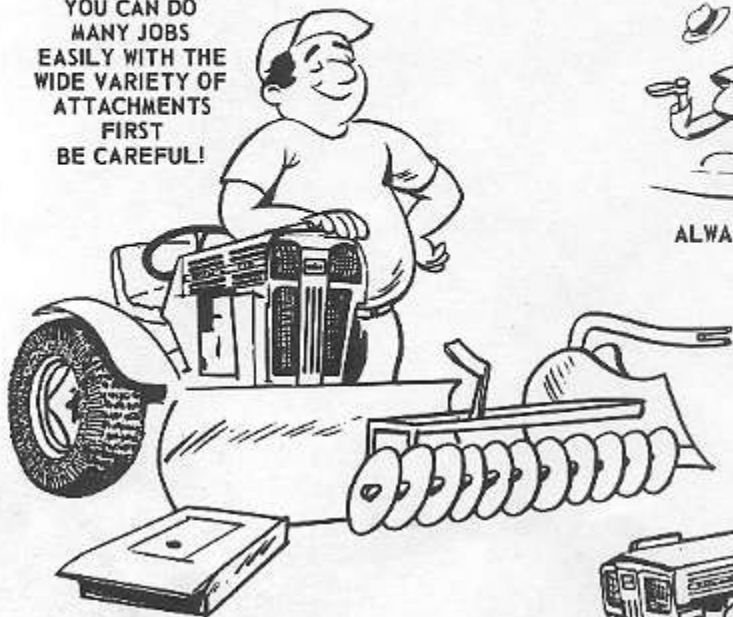

ALWAYS START IN NEUTRAL!

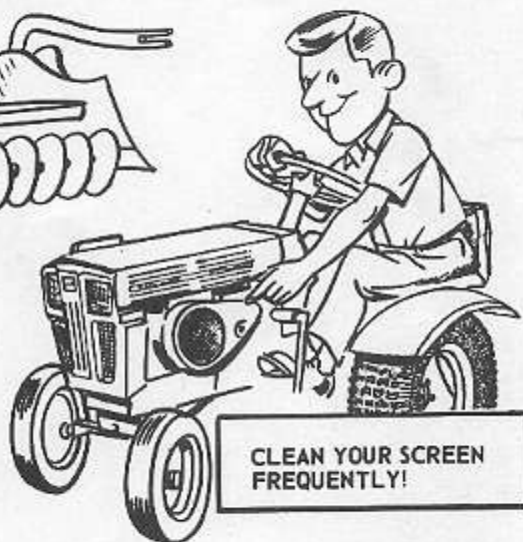

CLEAN YOUR SCREEN
FREQUENTLY!

DO NOT - START, RUN
OR REFUEL IN A
CLOSED BUILDING

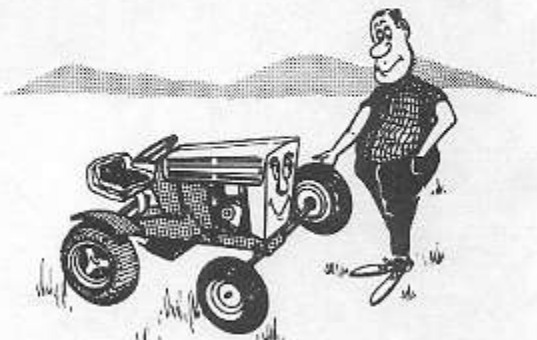
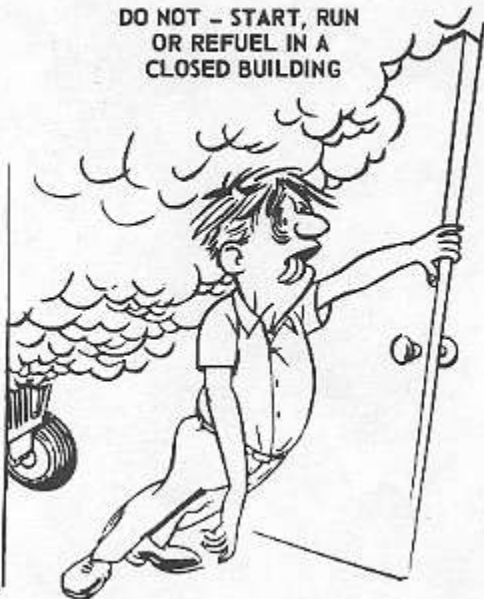

GET TO KNOW THE TRACTOR
AND ITS CONTROLS THOROUGHLY.

SETTING UP INSTRUCTIONS

A number at the beginning of a paragraph in the following instructions refers to an arrow in the adjoining figure except when otherwise stated. When R.H. (Right Hand) and L.H. (Left Hand) are used, it should be understood to mean from a position behind and facing the tractor (or direction of travel). Reference to "front" indicates the engine and hood end of tractor, and the "rear" the transmission.

1. Remove carton from around tractor. You have an electric start tractor, remove battery from crate bottom and prepare for operation as given below. This will require about 2½ to 3 hours of time.
2. Cut banding holding tractor to crate bottom.
3. Tires were over-inflated for shipping purposes. Reduce air pressure to 12 lbs. in front tires and 8 lbs. in rear tires.
4. This tractor has been completely assembled at the factory, except for battery installation. The battery was shipped dry. Below are instructions for filling and installing battery.
5. Lubricate the tractor, refer to Lub Chart page 11.
6. Add fuel. Use a good grade of regular, clean, fresh gasoline. Do NOT mix oil with gasoline. Refer to page 7.

FILL AND CHARGE BATTERY

CAUTION: DO NOT ASSEMBLE BATTERY TO TRACTOR UNTIL BATTERY HAS BEEN FILLED AND CHARGED.

1. Fill battery with electrolyte and charge battery as outlined in instructions in battery container.
- NOTE: After filling cells, let battery stand for thirty minutes. Then charge battery at a rate not exceeding three (3) amperes for about 2½ hours.

FILL BATTERY AS SHOWN

WARNING DO NOT OVERFILL!
CORRECT LEVEL IS
BOTTOM OF TUBES IN CELLS



CUT-AWAY VIEW
OF BATTERY

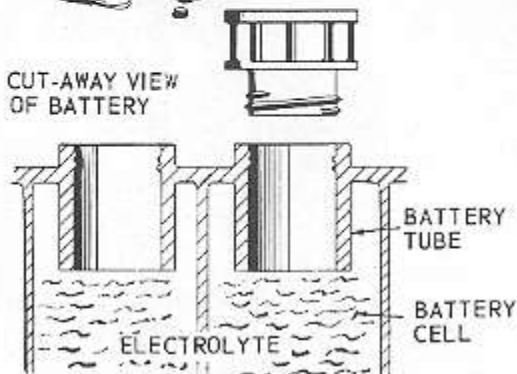

BATTERY INSTALLATION

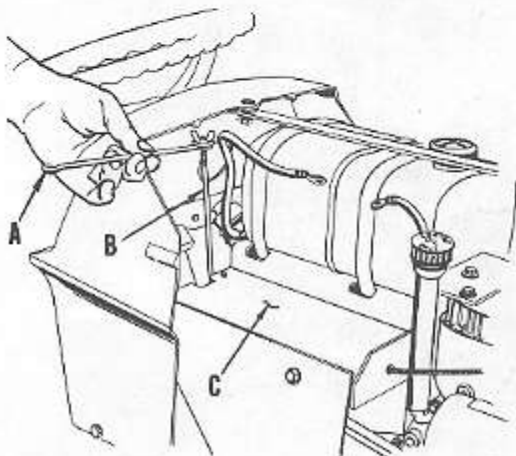

FIG. 3

2. Lift cowl, refer to Fig. 8. Assemble clamp (A), to one of two battery bolts (B). Flat washer and wing nut above clamp as shown in Fig. 3. Hook the bolt into rear of battery support (C), and turn clamp to the side as shown to allow positioning of battery. Bolt, clamp, washer and wing nut shipped in plastic bag located beneath cowl. Battery installation continued on page 6.

READ CAREFULLY ALL SETTING-UP, OPERATING AND MAINTENANCE INSTRUCTIONS IN THIS MANUAL. YOU WILL FIND MANY HELPFUL POINTERS WHICH WILL NOT ONLY SAVE YOU TIME BUT WILL HELP YOU OPERATE THE TRACTOR MOST EFFICIENTLY.

BATTERY INSTALLATION - Continued

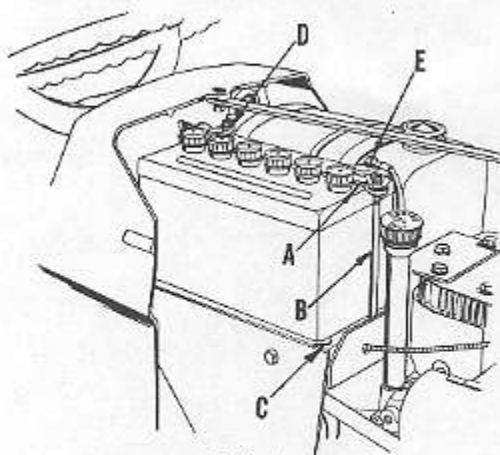

FIG. 4

- Slide battery into position with terminals to center of tractor as shown in Fig. 4.
- Hook the other battery bolt (B), into the front of the battery support (C). Assemble clamp (A), to bolt (B), with the remaining washer and wing nut as shown in Fig. 4. Tighten both wing nuts securely.
- Refer to Fig. 4. Connect starter switch cable (D), (red cover), to plus (+) terminal. Tighten nut securely. Nut shipped in plastic bag.
- Refer to Fig. 4. Connect ground cable (E), (black cover), to negative (-) terminal. Tighten nut securely. Nut shipped in plastic bag.

BELT GUARD

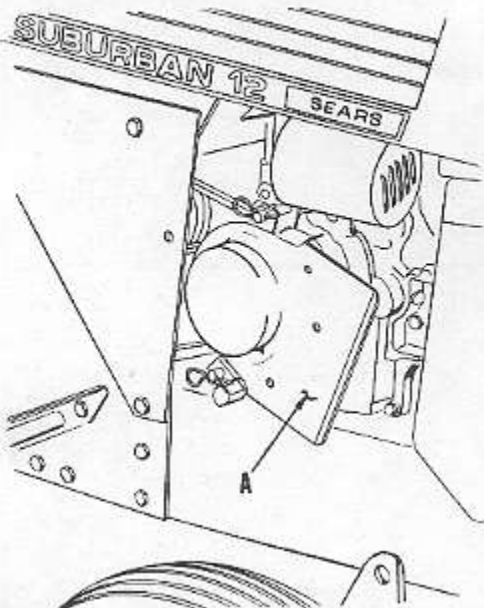

FIG. 5

- The belt guard (A, Fig. 5), is used for the Rotary Mower, Cutter Bar Mower and Rotary Snowplow. However, this belt guard can be left in place for normal tractor operation even when one of the above attachments are not being used. The machine screws, bushings and nuts shipped with guard should be stored in a safe place or positioned in the guard for safe keeping. Instructions for the placement of the screws, bushings and nuts were shipped in same plastic bag.

BEFORE STARTING THE ENGINE

KNOW THE CONTROLS AND HOW TO STOP QUICKLY. Become thoroughly familiar with the operating controls before starting the engine.

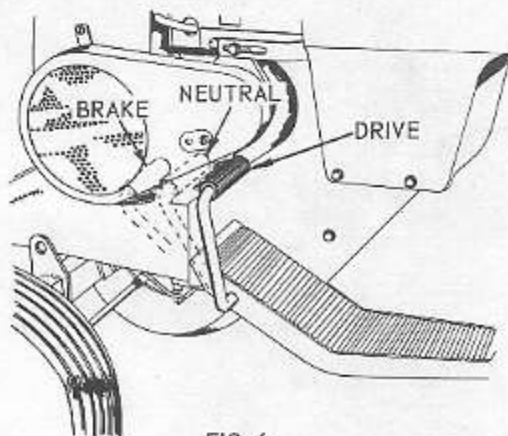

FIG. 6

The following controls are used to operate the tractor:

- Clutch and brake foot pedal is located on the left side foot rest. The foot pedal operates a combination brake and drive clutch. There are three positions of operation on the foot pedal.
 - The clutch is in DRIVE position when the pedal is all the way out (i.e. when the foot is removed from the pedal).
 - The clutch is in NEUTRAL when the pedal is depressed half way or more.
 - The BRAKE is on when the pedal is pressed all the way forward.

KNOW THE CONTROLS AND HOW TO STOP QUICKLY--READ THE OWNERS MANUAL.

DO NOT ALLOW CHILDREN TO OPERATE MACHINE; NOR ADULTS TO OPERATE IT WITHOUT PROPER INSTRUCTION.

ALWAYS START IN NEUTRAL.

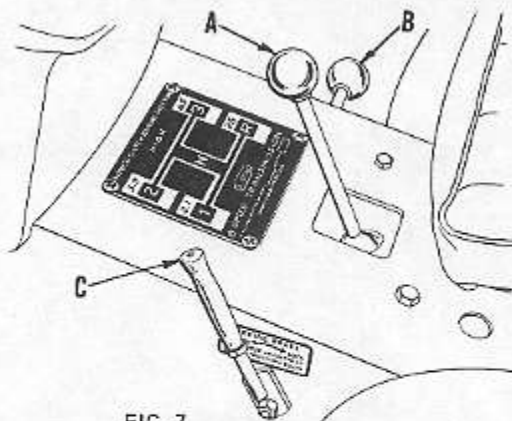

FIG. 7

2. The transmission (transaxle) gear shift lever (A), is located at front, center of seat.
 - a. The gear shift level selects the FORWARD speeds, the NEUTRAL and REVERSE speeds. Refer to Fig. 7.
3. The high-low range (B), is located on R.H. frame side just forward of R.H. rear fender. The high-low range lever has 3 positions, up for high-range, center for neutral, and down for low range. There are two neutral positions in transmission, one on the gear shift lever, and one on the high-low range lever. Both levers must be engaged for tractor to operate. Place gear shift lever in neutral position for starting tractor. Place high-low range lever in neutral for easier pushing of tractor or when tractor is being towed.
4. To engage park brake (C), push foot pedal all the way down, pull backward on park brake lever and release foot pedal. Push lever forward to release brake

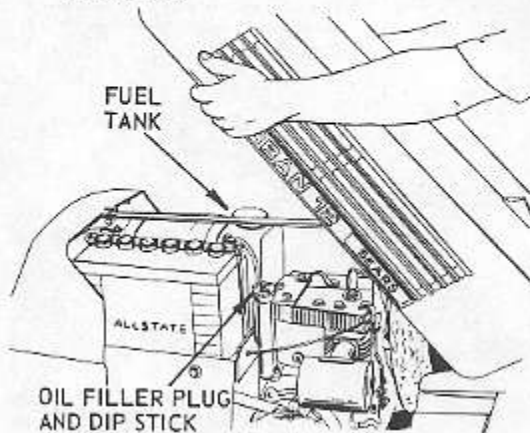

FIG. 8

Steps 5, 6 and 7 refer to Fig. 8.

5. To lift cowling, grasp each side of cowling at rear and pull outward and upward. Lift cowling to its extreme position.
6. Engine crankcase is shipped with oil ready for use. However, check oil level before starting. If necessary, add oil to bring oil level up to the full oil mark on the dipstick. Dipstick must be screwed in tight for checking oil level, and tractor should be level. NOTE: Do not fill above full mark on dipstick. Use Allstate Regular M.S. S.A.E. #30 oil or equivalent. If not available, use Allstate Multi-grade all weather oil S.A.E. 10W-20W-30W or equivalent. NOTE: Use S.A.E. 10W oil below 32 degrees.
7. Fill fuel tank with a good grade of fresh, CLEAN, regular gasoline. Wipe off all spilled fuel and oil. Do not mix oil with gasoline.

HOW TO START AND STOP TRACTOR

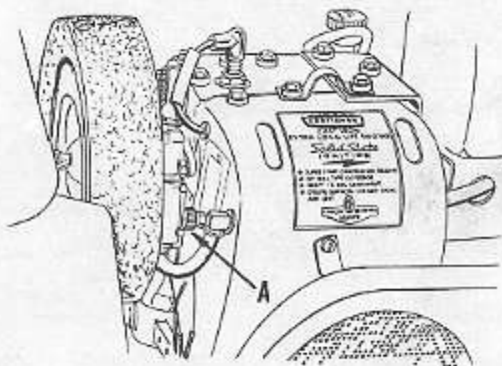

FIG. 9

1. Open gasoline shut-off valve (A, Fig. 9). Close gasoline shut-off valve after each days use.
2. CAUTION: Before starting the engine, check to be sure that controls are as follows:
 - a. Transmission gear shift lever (A, Fig. 7), is in NEUTRAL.
 - b. The high-low range lever (B, Fig. 7), is in NEUTRAL.
3. Depress foot pedal, refer to Fig. 6, to neutral position. THIS IS ESPECIALLY HELPFUL IN COLD WEATHER. Release park brake (C, Fig. 7). Continued on page 8.

HOW TO START AND STOP TRACTOR—

Continued

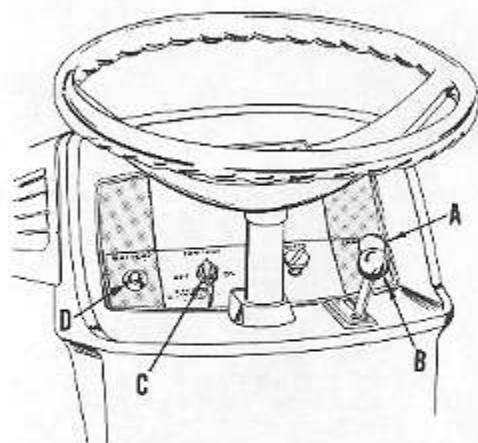

FIG. 10

4. Pull out choke control (A, Fig. 10), to full choke position to start in cold weather.
5. Advance throttle control lever (B, Fig. 10), to about $\frac{1}{2}$ throttle.
6. Turn ignition-starter key (C, Fig. 10), clockwise to engage starter. When engine starts, release key. After engine starts, push in choke control (A, Fig. 10), as engine warms up. Let engine warm up before applying load.

CAUTION: Do not run starter continuously for more than 30 seconds at a time. If after several attempts, engine does not start, move throttle control lever (B, Fig. 10), to FAST position. Wait for two minutes and try again.

7. Warning light (D, Fig. 10), will flash on when battery is not charging and ignition switch is on.
8. To stop engine, turn key (C, Fig. 10), in a counter-clockwise direction to off position. Key should be removed so children can not start tractor.



CAUTION: AFTER OPERATING THE TRACTOR OR ENGINE, NEVER TOUCH THE MUFFLER UNTIL IT HAS HAD SUFFICIENT TIME TO COOL.

TO OPERATE TRACTOR

1. Try your tractor in a large, open space. Learn to start, stop and reverse.
2. Start the engine and put the throttle lever at about $\frac{1}{2}$ throttle. Push down on foot pedal, move gear shift lever and range shift lever to speed desired. Release foot pedal slowly, and tractor will start to move. After foot pedal is fully released (clutch engaged), move throttle lever to fast position. If ground travel is too fast, depress foot pedal and shift to a slower ground travel speed. Always select a ground travel speed so that engine is not overloaded.
3. Do not shift gears while tractor is moving.
4. To stop tractor, push foot pedal all the way down, move gear shift lever to neutral, set park brake lock and release foot pedal. Always check to make sure brake lock will hold tractor secure. Shut-off and remove key from switch. This will prevent unauthorized operation. Never leave engine running with tractor unattended.

STORE YOUR TRACTOR IN A DRY AND PROTECTED PLACE. LEAVING YOUR TRACTOR OUTDOORS, EXPOSED TO THE ELEMENTS, WILL RESULT IN MATERIALLY SHORTENING ITS LIFE.

FILL THE FUEL TANK WITH CLEAN, FRESH, REGULAR GRADE GASOLINE, PREFERABLY AT THE END OF EACH DAY'S USE. THIS WILL FORCE OUT ANY MOISTURE LADEN AIR AND PREVENT CONDENSATION IN THE FUEL TANK. DO NOT MIX OIL WITH THE GASOLINE.



DO NOT DECLUTCH GOING UP OR DOWN HILLS—

SAFE OPERATION

1. Do not operate the tractor in high gear going down hill, and do not turn sharp corners while going down hill. If it is necessary to stop tractor while going down hill, do so quickly to prevent tractor from picking up speed during the declutching to brake position.

NOTE: The engine produces considerable braking action when throttled back to idling speed without declutching, and this procedure is recommended before applying brake.

2. **CAUTION:** Do not operate tractor crossways on slopes of more than a 25 percent slope, or up or down slopes with more than a 35 percent slope.
3. Do not shift gears while going up steep hills. Choose a low enough gear to climb hill without stopping and shifting gears. If it is necessary to stop while going up hill, do so quickly to prevent tractor rolling backward. Before starting tractor in motion going uphill, use one of the lowest gears, reduce engine speed and engage clutch gradually to prevent tractor from "rearing up".
4. Sideways upsets happen easily in ditches. Be alert for holes or other hidden hazards.
5. If tractor becomes mired in a hole, try to back out rather than driving forward.

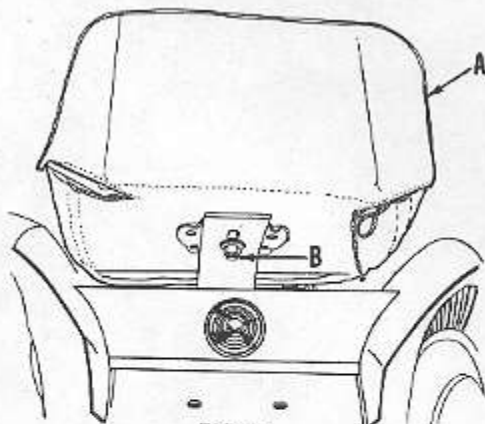

FIG. 11

SEAT POSITION

The seat (A), may be moved towards the front or rear to give the most comfortable riding position. To move the seat, loosen the nut (B), beneath the seat spring and slide the seat to the position desired. Tighten the nut, making sure that the seat has not twisted out of alignment with the seat spring.

TOWING TRACTOR

Place gear shift lever and range lever in neutral position. Tractor can then be towed at a reasonable safe speed.

ENGINE PULLEY GROOVES TO USE FOR YOUR VARIOUS ATTACHMENTS

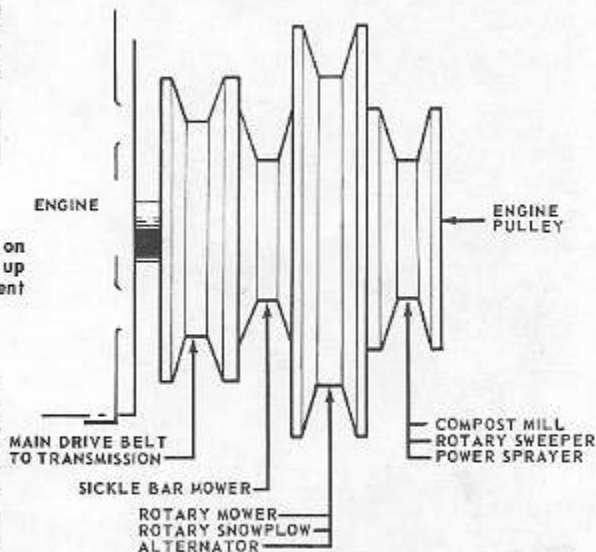

FIG. 12

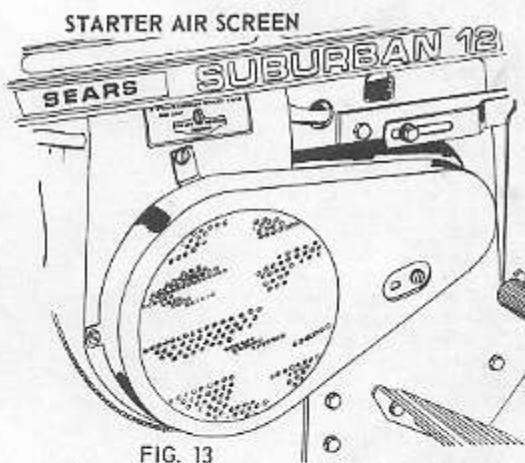

FIG. 13

The starter air screen, illustrated in Fig. 13, is designed to keep grass, chaff and large leaves from entering the cooling system and must be cleaned periodically. The cleaning of this starter air screen will vary with the conditions in which the tractor is used. The starter air screen should not be allowed to become too plugged or dirty which would interfere with the cooling of the engine.

KEEP ENGINE CLEAN. THIS ENGINE IS AIR COOLED, IF COOLING SYSTEM BECOMES CLOGGED, SERIOUS DAMAGE MAY RESULT. THEREFORE, KEEP THE BLOWER SCREEN, FINS ON FLYWHEEL, CYLINDER HEAD AND BLOCK FREE FROM GRASS OR DIRT.

AIR CLEANER

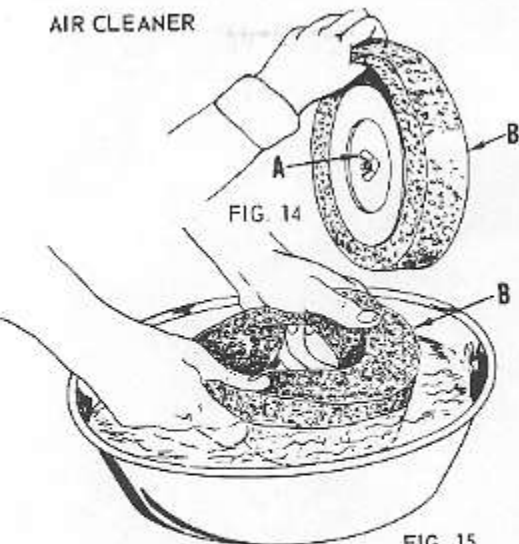

FIG. 15



FIG. 16

NOTE: If air cleaner becomes too dirty, engine will not receive sufficient air to run properly. Symptoms: Loss of power, flooding, hard to start and overheating.

Your engine is equipped with a polyurethane pre-cleaner (B, Fig's. 14 and 15), that must be removed, cleaned and oiled every 25 hours of operation, or more often under dusty conditions.

1. To service the pre-cleaner, carefully stretch pre-cleaner over the outer metal cover and wash in water and detergent, refer to Fig. 15. Remove excess water by squeezing as a sponge and allow to dry thoroughly. Distribute three tablespoons of S.A.E. No. 30 engine oil evenly around pre-cleaner. Knead into and wring excess oil from pre-cleaner.
2. Depending on conditions in which the tractor is operating, the inner paper element (C, Fig. 16), should be replaced whenever it becomes excessively dirty. To service inner paper element, loosen wing nut (A, Fig. 14), that holds outer metal cover to bracket, and remove complete air cleaner assembly. Slip pre-cleaner from inner paper element. Handle inner paper element with care to avoid perforations or distortion of shape.
3. To reassemble, slip pre-cleaner (B), over inner paper element (C). Carefully hold complete air cleaner assembly in place on bracket and replace outer metal cover and secure with wing nut. Recheck to see that air cleaner assembly is in proper position.

NEVER RUN YOUR ENGINE WITHOUT AIR CLEANER COMPLETELY ASSEMBLED.

ENGINE LUBRICATION

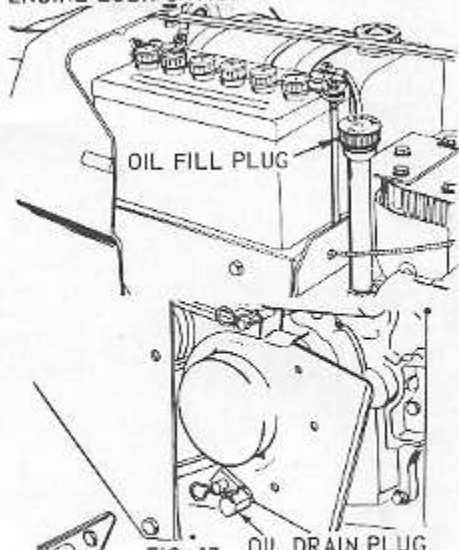

FIG. 17 OIL DRAIN PLUG

1. Change oil in crankcase after first 2 hours of operation. Engine should be warm when oil is changed.
2. To drain oil, unscrew oil drain plug at lower R.H. side of engine, see Fig. 17. Catch oil in suitable container.
3. Refill engine crankcase with oil as instructed under "Before Starting the Engine", page 7. Capacity 2½ pints. Check oil level after each five hours of operation and add oil, if necessary, to bring to correct level on dipstick.
4. After first oil change, oil should be changed after each 25 hours of operation.

TRANSAXLE (TRANSMISSION) LUBRICATION

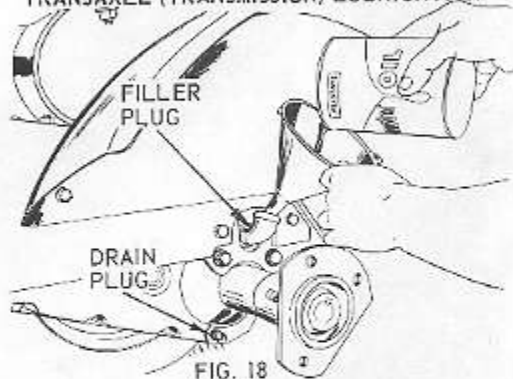

FIG. 18

Rear wheel is removed for illustrating.

1. Check oil in transaxle every 50 hours of operation. To check oil level, remove filler plug (Fig. 18), from transaxle. Oil level should be even with this plug.
2. Change oil in transaxle after 500 hours of operation. To drain, remove drain plug and catch oil in suitable container.
3. To fill transaxle, use 5 qts. of Allstate S.A.E. 30 motor oil for service MM or MS or equivalent. Fill through filler plug as shown.

LUBRICATION CHART

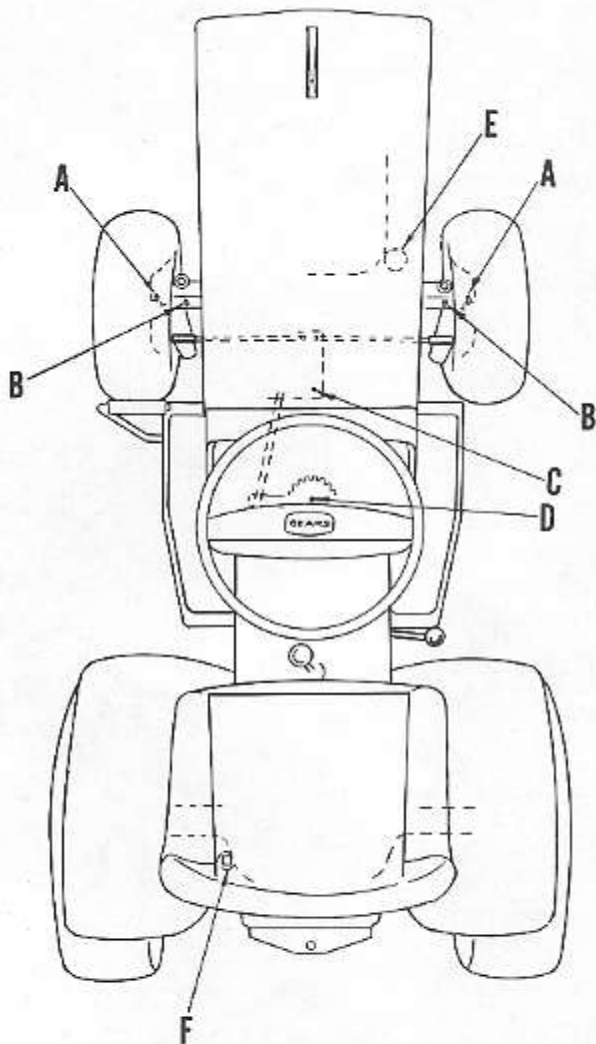

FIG. 19

There are only 6 grease fittings on your tractor. Give each grease fitting 2 shots of grease every 5 hours of operation.

Use Sears All-purpose Lithium gun grease or equivalent.

A - Front Wheels (2 fittings, both sides)

B - Front Spindles (2 fittings, both sides)

C - Steering Bell Crank

D - Steering Gear Sector and Arm

E - Check oil in engine crankcase at least every 5 hours of operation. Change oil every 25 hours of normal operation.

In extremely dirty or dusty conditions change oil every 15 or 20 hours of operation.

F - Check oil in transaxle (transmission) every 50 hours of operation. Change oil in transaxle every 500 hours of operation.

-- Apply several drops of oil to all pivot points every 5 hours of operation.

BELT ADJUSTMENT

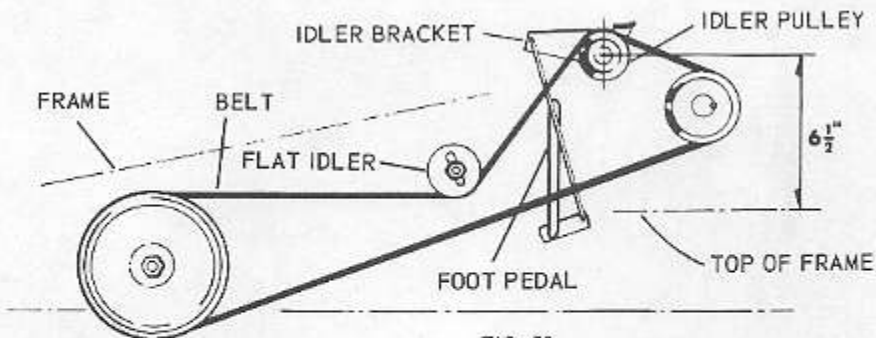

FIG. 20

1. Loosen bolt in flat idler and frame, and push idler and belt down in slot of frame until center of idler pulley on idler bracket (just back of engine) is 6 1/2 inches above frame as shown. Tighten bolt in flat idler and frame securely.

NOTE; Foot pedal should be in vertical or just back of vertical position with clutch engaged. New belts will stretch after a few hours of operation, then after initial stretch, adjustment is seldom necessary, so adjust belt after first 10 hours of operation.

BRAKE ADJUSTMENT

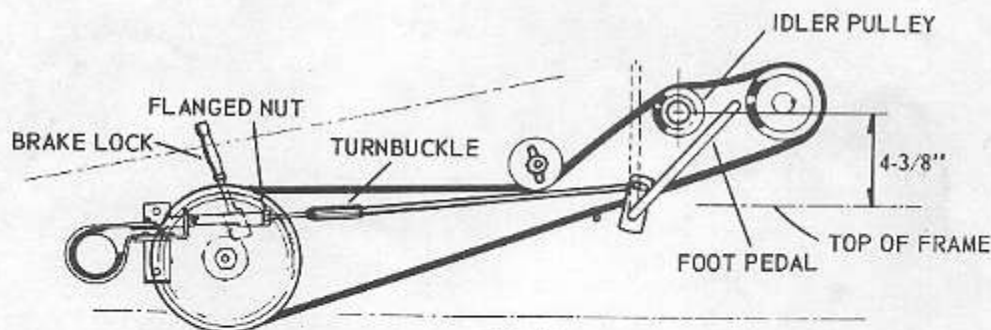

FIG. 21

To adjust brake, loosen nut back of turnbuckle and turn turnbuckle (clockwise when standing in front of tractor) one turn at a time until foot pedal has about 4 inches of travel from clutch engaged to full brake position, or center of idler is about 4-3/8 above frame as shown.

Tab on idler bracket will deflect belt slightly. Tighten jam nut against turnbuckle to lock turnbuckle in position. Keep brake properly adjusted especially in hilly terrain.

PARK BRAKE LOCK ADJUSTMENT

The flanged nut is adjustable forward or backward on rear brake rod so that lock assembly will hold brake full on when parking lock is pulled up (lock position). Tighten jam nut against flanged nut to lock flange nut in position. As brake band wears, flanged nut will have to be readjusted.

WEIGHTS (Optional Equipment)

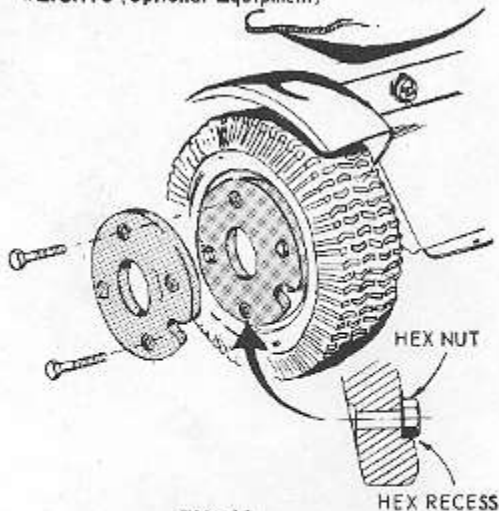

FIG. 22

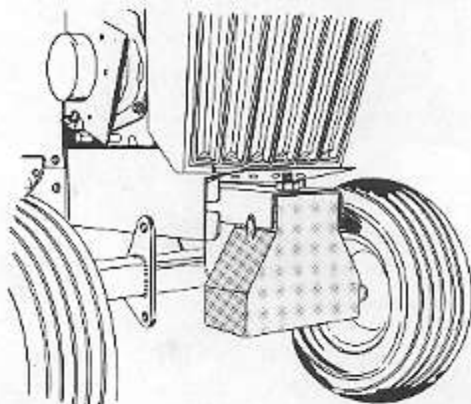

FIG. 23

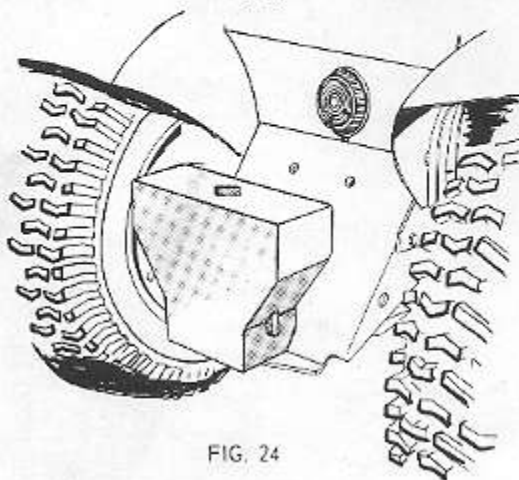
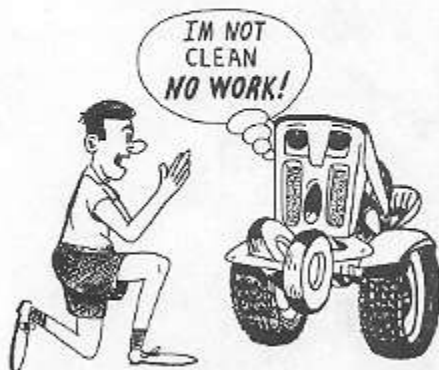

FIG. 24

Rear wheel weights (Fig. 22), are very essential for added traction. This is especially true for attachments such as the plow, disc harrow, leveler blade, rotary snowplow, bulldozer, etc. Front or rear end weight (Fig's. 23 and 24), will act as a counter-weight for heavy front or rear loads or attachments. Especially helpful with rotary snowplow.



IMPORTANT BATTERY CARE

Proper attention to the battery on units so equipped is of the utmost importance.

Your battery is of the same high standard as is used in automobiles. Unfortunately it does not have the advantage of automatic attention by the service station attendant as the one in your car.

The following points are recorded to help remind you to provide attention to the battery and gain full advantage of the usable life built into the battery and avoid costly replacements.

1. Check solution level in battery at least once each week. Add distilled water when required. Correct level is bottom of tubes in cells, refer to page 5. After adding water, run the engine so that the generator charge will mix the solution. **DO NOT OVER FILL.**
2. Keep the battery clean. Remove any collection of grease or other substance from the top of the battery.
3. Keep top of battery clean and dry at all times.
4. Keep battery snug in its cradle or holder.
5. Keep vent caps tight and small vent holes in caps open.
6. If battery should become discharged or fall below a specific gravity of 1.225 remove battery and have it recharged.
7. When recharging, request service station to **SLOW CHARGE** the battery at a rate of 3 amperes. **FAST CHARGING IS NOT RECOMMENDED.**

TROUBLE SHOOTING

Possible Cause

Possible Remedy

HARD TO START

No gasoline in fuel tank or carburetor.....	Fill the tank with gasoline; open fuel shut-off valve. Check fuel line and carburetor.
Water in gasoline or old fuel.....	Drain fuel tank and carburetor. Use new fuel and dry spark plug.
Choked improperly. Flooded engine.....	Push in choke, open throttle control and crank engine several times to clear out the gas.
Dirty carburetor air filter.....	Remove and clean, see page 10.
Spark plug dirty or improper gap.....	Clean, adjust the gap or replace. Refer to engine manual.
Defective battery.....	Service or replace.
Defective ignition or loose wiring.....	Check the wiring and spark plug.

ENGINE MISSES OR LACKS POWER

Dirty starter air screen.....	Clean screen over starter, see page 9. Be sure fins on cylinder head and around cylinder are clean.
Partially plugged air cleaner.....	Remove and clean, See page 10.
Low oil level or dirty oil.....	Check or change oil, see page 10.
Improper carburetor adjustment.....	Refer to engine manual.
Spark plug dirty, wrong gap or wrong type.....	Clean, reset the gap or replace.
Engine overloaded.....	Shift to a lower gear or reduce load.
Faulty ignition.....	Check spark plug and for loose wires. If trouble cannot be corrected, contact Sears.
Belt slips.....	Tighten belt. Refer to page 15.
Oil in gasoline.....	Drain and refill gasoline tank and carburetor. Oil reduces the efficiency of the engine.
Poor compression.....	Contact Sears.

ENGINE OVERHEATS

Dirty starter air screen.....	Clean screen over starter, see page 9.
Low oil level or dirty oil.....	Check or change oil, see page 10.
Partially plugged muffler.....	Remove muffler from engine and clean.
Poor fuel or too lean a mixture.....	Refer to engine manual.
Partially plugged air cleaner.....	Remove and clean, see page 10.
Dirty engine.....	Clean fins on cylinder head and around cylinder.

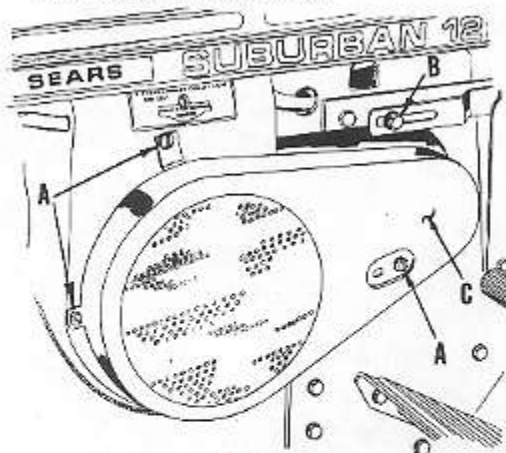

FIG. 25

STARTER-GENERATOR BELT ADJUSTMENT

1. Remove 3 screws (A) holding belt guard to engine.
2. Loosen bolt (B) in generator adjusting strap and generator, move starter generator back to tighten belt and tighten bolt (B) securely. Belt should be tight enough to prevent belt slippage when starting tractor.

NOTE: Belt can be tightened at bolt (B), without removing belt guard. However, belt tension will be easier to check with guard removed.

HOW TO START IF BATTERY IS LOW

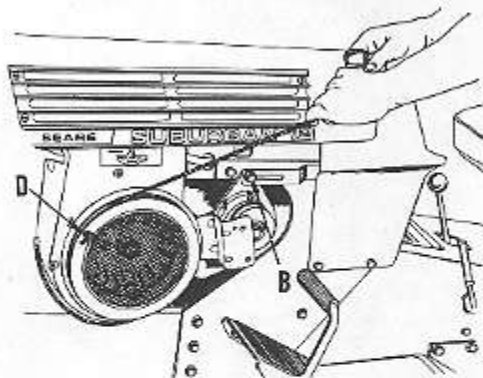

FIG. 26

1. The quickest method would be to connect quick-start battery cables or "jumpers" from your automobile 12 volt battery to the tractor battery.

CAUTION: Connect positive (+) terminal to positive (+) terminal.

2. Method number two will NOT charge battery, but is strictly emergency starting only.

- a. Remove the three screws (A, Fig. 25). This will allow removal of belt guard assembly (C, Fig. 25).
- b. Loosen nut (B, Fig. 26), and push motor-generator forward. This will take tension from V-belts. Remove belt.
- c. Secure a piece of rope and tie a knot in one end. Place this knot into notch (D), in engine pulley, refer to Fig. 26.
- d. Wrap rope around engine pulley using grooves provided.
- e. Pull rope sharply to start engine.

DO NOT REPLACE V-BELT OR GUARD WHILE ENGINE IS RUNNING. The above method of starting is only a means to get unit to nearest source of battery charging. **DO NOT** operate tractor any longer than necessary with V-belt and guard removed. Stop engine and replace as soon as possible. Be sure to have proper tension on belt, retighten nut (B, Fig. 26).

DISCONNECT SPARK PLUG WIRE AT SPARK PLUG BEFORE PERFORMING ANY MAINTENANCE TO PREVENT ACCIDENTAL STARTING OF ENGINE.

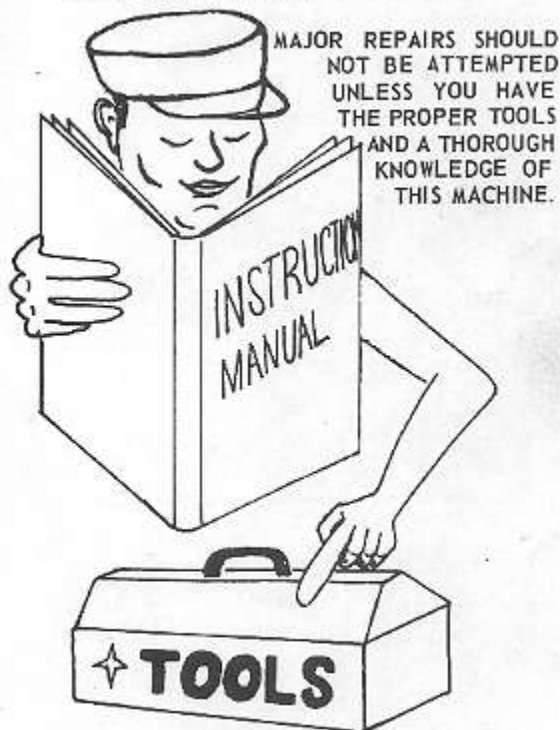

TIRES

Keep tires inflated to 12 pounds of air in front; 8 pounds in rear.

To repair a punctured FRONT tire:

1. Block wheel up on a solid object high enough for the tire to clear floor.

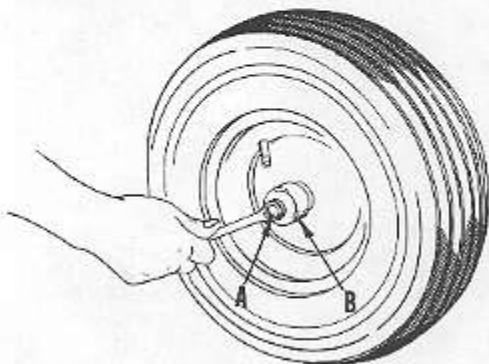

FIG. 27

2. Remove hex bolt (A), and dust cap (B).

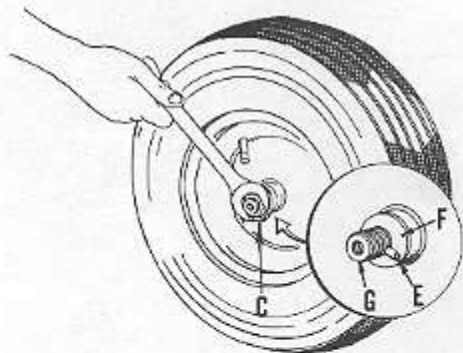

FIG. 28

3. Remove grip nut (C), wear washer (D), pin (E), and washer (F), from spindle shaft assembly (G). Refer to Fig's. 28 and 29.

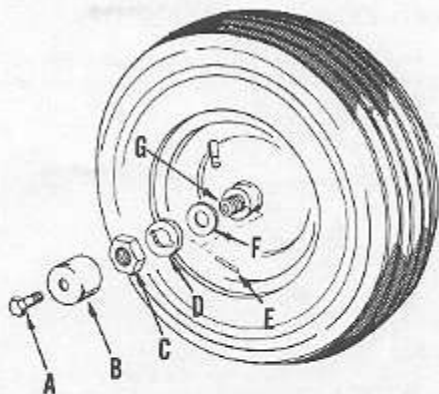

FIG. 29

4. Reverse procedure for reassembly, refer to Fig. 29.

To repair a punctured REAR tire:

5. Remove rear wheel by unscrewing five hub bolts from wheel and hub.

NOTE: Tire can be repaired at your local Sears automotive center or service station. They are repaired in same manner as an automobile tire.



STOP ENGINE AND WAIT SEVERAL MINUTES BEFORE CHECKING OIL LEVEL.

NOTE: THE BEST TIME TO DRAIN OIL IS AT THE END OF A DAY'S OPERATION AT WHICH TIME THE OIL IS HOT AND ALL DIRT AND FOREIGN MATERIAL IS SUSPENDED IN THE OIL.

Safety 1st

WINTER CARE - BATTERY

1. If unit is not used regularly during winter months it should be removed and stored in a cool, dry place.
2. If unit is used only infrequently during winter months check at least once each thirty days to be sure a full charge is maintained.
3. A battery not fully charged can freeze, resulting in the necessity to replace.
4. A safe rule is to charge the battery monthly or at least test and recharge if below 1.225 specific gravity.

Please remember the necessity of proper winter care for the battery. Batteries not in use for several months and not kept fully charged produce a sulphation of the plates which cannot be removed by recharging.

Your guarantee is intended to provide you adequate protection. It does not, however, cover recharging or damage resulting from lack of care, freezing or inability to perform after winter or long storage periods without proper attention.

STORAGE INSTRUCTIONS

In the event your tractor is to be inoperative for periods in excess of 30 days - prepare for storage as outlined below:

1. Drain gas tank.
2. Drain carburetor by allowing engine to run out of gasoline. Then push in drain valve (A, Fig. 30), to remove all gasoline from carburetor. Evaporating gasoline will leave gum deposits if not drained completely. These deposits make fuel systems inoperative resulting in a hard or nonstarting engine when again used.
3. Do not save or store gasoline over winter.

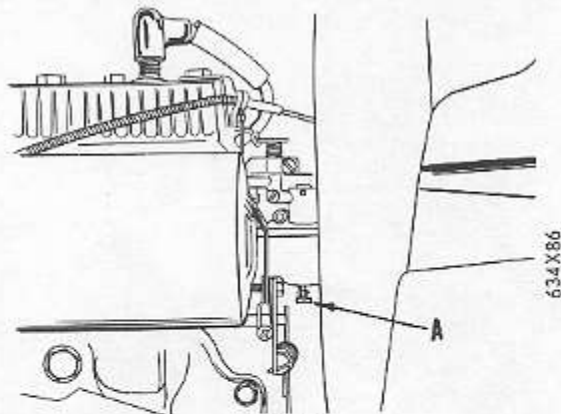

FIG. 30

GENERAL

1. Just as your automobile needs professional mechanical maintenance from time to time, so does your air cooled engine. Cleaning and adjustment of the carburetor and periodic replacement of the spark plug and ignition points is made necessary by NORMAL use.
2. Professional air cooled engine service is as close as your nearest Sears Store.
3. A yearly check-up or tune-up by Sears is a good idea to avoid breakdowns or delays -- Do it each fall, then you're ready for spring. We even prepare it for storage for you.



Sears, Roebuck and Co. or Simpsons-Sears Limited in Canada reserves the right to make any changes in design or improvements without imposing any obligation to install the same upon its items heretofore manufactured.



Sears

TRACTOR GUARANTEE

Your tractor is guaranteed for one full year. If any defect in material or workmanship should appear during this time, simply contact our nearest store or service center throughout the United States or Canada. We will make all necessary repairs, including parts and labor, at no charge to you.

Tractors equipped with batteries: If battery proves defective and will not hold a charge, in exchange for the battery, we will:

During the first 90 days – replace battery at no charge.

After 90 days – replace battery, charging customer 1/12th of the price of the new battery for each full month from date of sale.

If the tractor is used for commercial or rental purposes, this guarantee applies for thirty days.

SEARS, ROEBUCK AND CO.
SIMPSONS-SEARS LTD.



NO. 1... WHERE THE TRRR-ACTION IS!

