



Branson 20C series

Operator's manual





TABLE OF CONTENTS

GENERAL PRECAUTIONS	8
ABOUT WARRANTY	50
OVERVIEW OF THE TRACTOR	52
FUNCTIONS	56
SWITCHES AND LEVERS	57
1. MAIN KEY SWITCH	58
2. ACCELERATOR LEVER	59
3. F/R SHUTTLE LEVER	59
4. DIRECTION LAMP S/W	60
5. HEAD LAMP & HORN S/W	60
6. STEERING WHEEL TILT LEVER	61
7. PTO SHIFT SWITCH	61
8. EMERGENCY LAMP SWITCH	62
9. DASH METER	63
PEDALS	67
1. CLUTCH PEDAL	68
2. BRAKE PEDALS AND CONNECTOR	68
3. ACCELERATION PEDAL	69
LEVER OPERATION (A)	70
1. MID REMOTE VALVE JOYSTICK	71
2. MAIN GEAR SHIFT LEVER	71
3. 3PT POSITION CONTROL LEVER	72





4. RANGE SHIFT LEVER	72
5. PARK BRAKE LEVER	73
6,7. REAR REMOTE CONTROL LEVER	73
LEVER OPERATION (B)	74
1. STOP/SLOW RETURN VALVE	75
2. MFWD LEVER	75
3. PTO LEVER	76
4. DIFFERENTIAL LOCK PEDAL	76
OTHERS.....	77
1. WORKLAMP SWITCH	78
2. POWER OUTLET	78
3. WIPER SWITCH	78
4. CLIMATE CONTROL	80
5. SEAT	81
OPERATION & WORK	82
CHECKING BEFORE OPERATION	83
STARTING/STOPPING THE ENGINE	90
1. TO START THE ENGINE	91
2. TO STOP THE ENGINE	93
DRIVING ON THE ROAD	94
DRIVING ON THE SLOPE	95
ENTERING AND LEAVING THE PAVEMENT	96
TURNING ON THE PAVEMENT	97





DIFFERENTIAL GEAR LOCK	98
TRACTOR LOADING / UNLOADING	99
INSTALLING 3POINT LINK	100
PRECAUTIONS FOR CONNECTING THE IMPLEMENT	103
ADJUSTING WHEEL TREAD	104
POWER STEERING	105
MAINTENANCE AFTER WORK	106
MAINTENANCE AFTER WORK	107
MAINTENANCE FOR PROLONGED STORAGE	108
PERIODIC MAINTENANCE AND ADJUSTMENT	112
PERIODIC MAINTENANCE SCHEDULE	113
OIL, GREASE, AND ANTI-FREEZE CHART	115
FUEL, OIL, AND COOLANT CHART	115
CHECKING AND CHANGING OF OIL	116
1. ENGINE OIL	117
2. TRANSMISSION / HYD FLUID	118
3. FRONT AXLE FLUID	120
FILTERS / COOLANT REPLACEMENT	122
1. ENGINE OIL FILTER	122
2. TRANSMISSION / HYD FLUID	123
3. FUEL FILTER	124
4. COOLANT	124





OTHERS	127
1. RADIATOR SCREEN / AIR CLEANER	127
2. BATTERY	129
3. ADJUSTING PARKING BRAKE	130
4. FUEL PIPES AND HOSES	131
5. ELECTRICAL CABLES	132
6. GREASING	133
7. STEERING WHEEL	134
8. BRAKE	135
9. FAN BELT	136
10. AIR COMPRESSOR BELT	137
11. TOE-IN	138
12. FRONT AXLE SWING	139
13. FUSE AND FUSIBLE LINK	138
14. COLOR OF EXHAUST GAS	139
TROUBLESHOOTING	142
ENGINE	143
CLUTCH & BRAKE	146
HYDRAULIC SYSTEM	147
ELECTRICAL SYSTEM	148
SPECIFICATIONS	151





THANK YOU FOR PURCHASING A BRANSON TRACTOR.

Before use, read and understand this manual complete.

- After reading this manual, keep it close to the tractor for immediate reference
- Any one operating this tractor should review this manual.
- In case this manual is lost or damaged, please contact your nearest authorized dealer for a copy.
- Some parts of this product may have been changed for the improvement of quality or for safety reason.
- In this case, the photographs or drawings of such parts in this booklet may not be the same as the actual parts installed on this product.
- If you find anything in this manual unclear or in need of further explanation, please contact your authorized dealer for inquiry.



The instructions given with the following marks are very important for your safety



DANGER

Failure to observe the instruction given with this mark may result in death or injury.



WARNING

Failure to observe the instruction given with this mark may expose you to the risk of death or injury.



CAUTION

Failure to observe the instruction given with this mark may expose you to injury.

- The section, “ To Ensure Safe Operation,” on the following pages details safety points to be observed to ensure safe operation of your tractor
- Please make sure you read it carefully before operating the tractor.



Read this Manual for correct and safe use of the product. Failure to use the product properly may result in an accident. Keep this Manual close to the tractor after you have read it.





GENERAL PRECAUTIONS

(TO ENSURE SAFE OPERATION)



GENERAL PRECAUTIONS

- Make sure to observe the instruction given in this section to avoid equipment failure or personal injury or death.

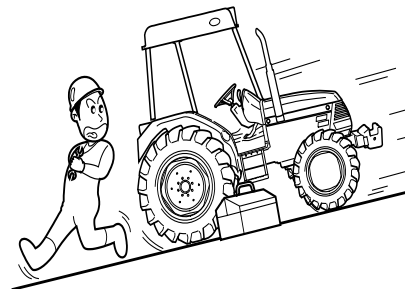

 WARNING	<p>Beware of exhaust gas. Start engine in a well ventilated area.</p>
---	---

[Otherwise]

The exhaust gas can cause intoxication and lead to fatal consequences.

 WARNING	<p>Select a flat and safe location to secure the tractor in place so it will not cause a risk to people passing by. Before carrying out the maintenance, block the front and rear tires to prevent moving while servicing.</p>
--	--

[Otherwise]

An unexpected accident may occur, such as overturning of the tractor.





GENERAL PRECAUTIONS

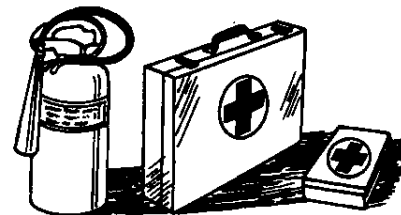
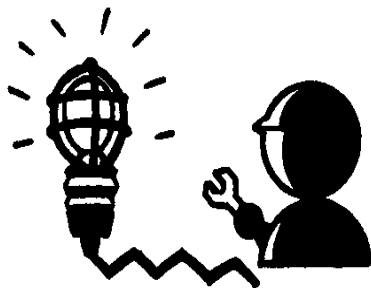

WARNING

Make sure work area is properly lit. Use safety work lights with protection covering.



WARNING

Keep a first aid kit and fire extinguisher handy at all times while operating equipment.

[Otherwise]

An unexpected accident may occur, possibly fire or explosion.





GENERAL PRECAUTIONS



WARNING

Do not operate tractor or any implement attached to tractor while under the influence of alcohol, medication, controlled substances or while fatigued.



WARNING

Never wear loose, torn or bulky clothing around tractor.

[Otherwise]

You will be exposed to a risk of being entangled in the equipment resulting in injury.





GENERAL PRECAUTIONS



WARNING

Fasten your seat belt at all times.

[Otherwise]

You will be exposed to a risk of death or serious injury if the tractor overturns.



WARNING

Before allowing other people to use your tractor, explain how to operate and have them read this manual.

[Otherwise]

There is a danger of death, serious injury, or damage to the tractor.





GENERAL PRECAUTIONS

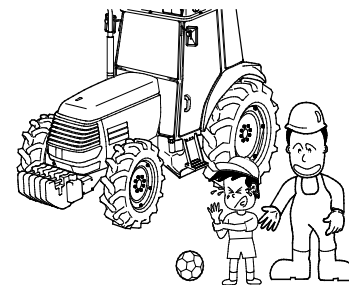
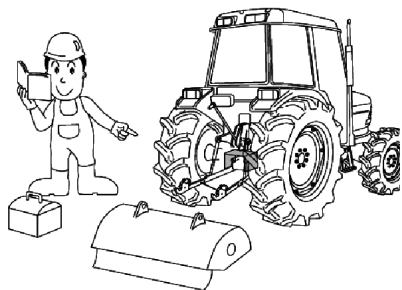

WARNING

Be sure to use only implements which are recommended by manufacturer.

[Otherwise]

An un expected accident may occur or tractor may not perform properly.



WARNING

Fully warn children and keep them away from the tractor at all times.

[Otherwise]

There is a risk of injury.





GENERAL PRECAUTIONS

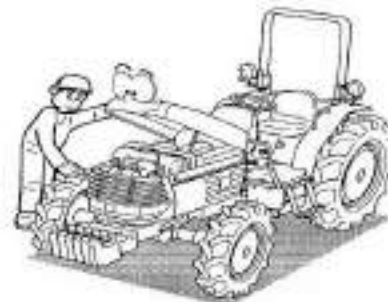

DANGER

Absolutely no lit cigarettes, matches, or lighters anywhere near when fueling the tank.

[Otherwise]

Fire or explosion may occur.



WARNING

Inspect electrical wiring contact insulation to avoid shorting or spark.

[Otherwise]

There is a risk of fire due to short circuit.





GENERAL PRECAUTIONS



 WARNING	When filling tires with air, do not inflate it beyond the maximum pressure stated in this booklet.
---	--

[Otherwise]

The tire may blow out, causing an injury.

 WARNING	When starting the engine, make sure that you are seated in the driver's seat with your seat belt fastened and the safety inspection has been performed.
--	---

[Otherwise]

An unexpected accident may occur.





GENERAL PRECAUTIONS



CAUTION

During operation and right after the engine is turned off, the muffler is very hot. Avoid touching it, as you may get burnt.

[Otherwise]

There is a risk of getting burnt.



CAUTION

Use only the genuine parts or other approved parts. Do not modify the tractor

[Otherwise]

There is a danger of accident or injury or equipment failure. Please remember that the failure due to modification may not be covered by warranty.





GENERAL PRECAUTIONS



WARNING

Perform periodic maintenance, keep each part of the tractor in normal condition. Make sure to replace all hydraulic hoses and brake hoses once every two years.

[Otherwise]

There is danger of accident or equipment failure due to poor maintenance.



WARNING

Check carefully that the various safety lamps such as direction indication lamp before driving the tractor

[Otherwise]

Because signal cannot be seen by nearby workers, agricultural equipment, automobiles, etc. It may result in a cause of accident.





GENERAL PRECAUTIONS

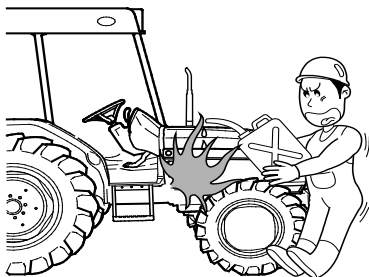

DANGER

Never fill the fuel tank while the engine is running or when the engine is hot.

[Otherwise]

The fuel may ignite and fire may break out.



DANGER

If fuel pipe is damaged, fuel will leak. Make sure that you check for any leakage.

[Otherwise]

There is a danger of fire.





GENERAL PRECAUTIONS



DANGER

After filling the fuel tank, close the fuel filler cap completely and wipe off the excess fuel thoroughly.

[Otherwise]

It may result in a fire accident or environmental pollution.



WARNING

Every day before operating the tractor, check for straws, dust, fuel, or other residue on and around the muffler and the engine and remove them.

[Otherwise]

It may result in a fire.





GENERAL PRECAUTIONS

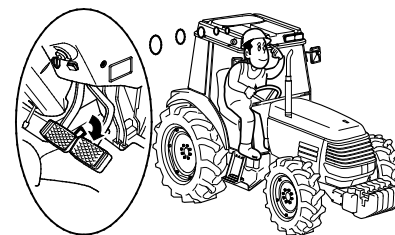

 WARNING	<p>Except when you adjust the steering wheel, make sure that the tilt lever is placed in the <Lock> position.</p>
---	---

[Otherwise]

The tractor may not turn to the direction you want and may cause an accident.

 WARNING	<p>Check if the brakes work properly and evenly on both sides or if the steering wheel is loose.</p>
--	--

[Otherwise]

There is a risk of accident..





GENERAL PRECAUTIONS

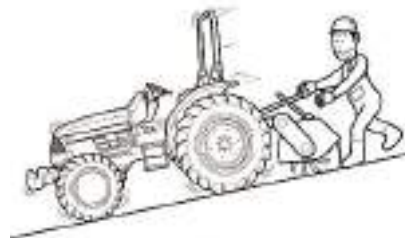
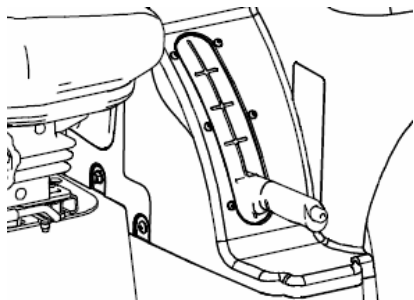

WARNING

Engage the parking brake during warming of engine.

[Otherwise]

The tractor may move and cause an accident or injury.



WARNING

Engage or disengage the implement on a flat and safe place. Supply proper lighting at all times and especially night.

[Otherwise]

There is a danger of accident.





Treatment of hazardous materials

- Properly discard hazardous materials.
- Hazardous materials from tractor are the following: Coolant, brake oil, oil, filter elements, battery and so on.
- When draining fuel, oil or other liquids, use a container without holes. Do not dispose of chemicals on the ground or in rivers or waterways



DANGER

Be careful that your body or your clothes do not come in contact with the battery solution. If you come in contact with the battery solution, rinse it off with water immediately.

[Otherwise]

You may get burnt or your clothes may be damaged.





GENERAL PRECAUTIONS



WARNING

Avoid fire when checking or charging the battery.

[Otherwise]

You may get burnt due to ignition or explosion of the battery.



CAUTION

Connect the (+) terminal first when installing the battery, and disconnect the (-) terminal first when removing it.

[Otherwise]

There is a risk of burn or fire due to short circuit.





GENERAL PRECAUTIONS

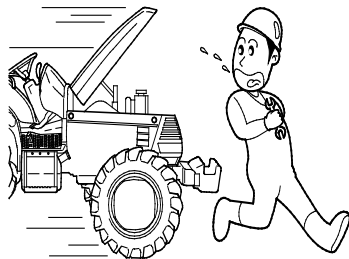

 CAUTION	When checking, repairing, maintaining, or cleaning the tractor, make sure to stop the engine.
---	---

[Otherwise]

There is a danger of injury.

 CAUTION	Make sure that the hydraulic coupling or the hose is not loose or damaged. Before separating the hydraulic coupling or the hose, eliminate the high pressure inside the hydraulic system.
--	---

[Otherwise]

The oil under high pressure may cause damage to the skin or injury.





GENERAL PRECAUTIONS

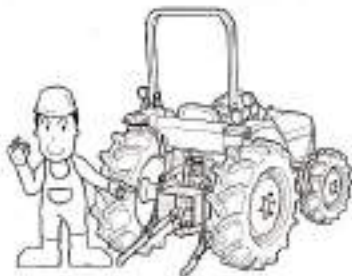

 CAUTION	When the PTO shaft is not in use, apply grease to it and keep it covered.
---	---

[Otherwise]

There is a risk that you may get entangled or get injured.

 CAUTION	Manage the maintenance tools properly, and use the correct tools for the type of maintenance. Also, always keep the tools for repairs and minor adjustment available on the tractor.
--	--

[Otherwise]

There is a danger of accident due to poor maintenance.



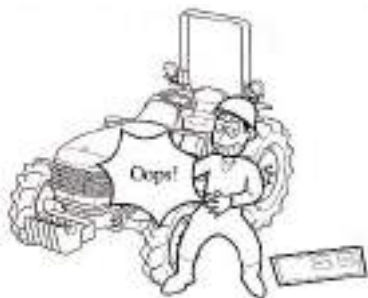

 CAUTION	After opening the hood for checking or maintenance, make sure to put them in their place.
---	---

[Otherwise]

There is a risk that you may get entangled in the tractor or get injured.





GENERAL PRECAUTIONS

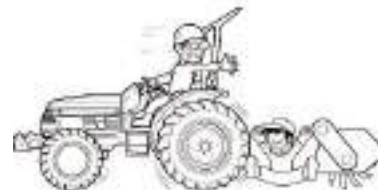

WARNING

Do not use a person on anything else in place of the balance weight. Use only recommended balance weight for the work.

[Otherwise]

There is a danger of accident or injury.



WARNING

When engaging or disengaging the implement by moving the tractor, make sure that no one is allowed around the tractor or between the implement or attachment and the tractor.

[Otherwise]

There is a danger of accident or injury.





 WARNING	When engaging a heavy implement or attachment, load the weight on the front to keep the balance of the tractor.
---	---

[Otherwise]

There is a danger of accident or injury due to loss of balance.

 WARNING	Do not get under implement or put your feet under it.
--	---

[Otherwise]

The implement unit may fall down and there is a risk of injury





GENERAL PRECAUTIONS



 WARNING	Adjust the wheel tread (width between left and right tires) on a slope or when towing.
---	--

[Otherwise]

There is a danger of turning over.

 WARNING	Depending on implements, the overall length may become very long. Pay particular attention to people or objects nearby when making a turn.
--	--

[Otherwise]

There is a danger of person injury or a collision of the implement.





GENERAL PRECAUTIONS

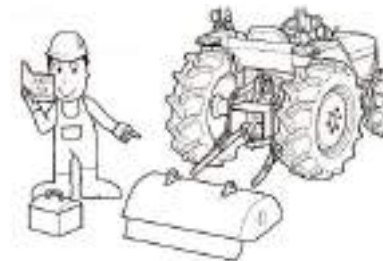

WARNING

Link the brake of the trailer with the brake of the tractor. Do not shift gear when driving on a hill.

[Otherwise]

There is a risk of accident or injury.



WARNING

When engaging an implement to the tractor, follow the instruction manual for the implement.

[Otherwise]

There is a risk of personal injury or damage to the tractor.





GENERAL PRECAUTIONS

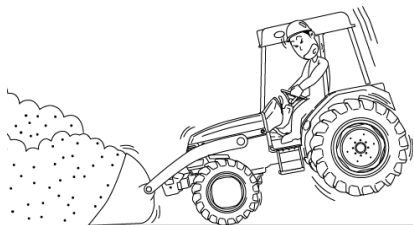

WARNING

During loader operation, apply weights or an implement to avoid losing balance between the front and the rear side of tractor.

[Otherwise]

There is a risk of overturning accident due to loss of balance.



WARNING

Do not use a low-revolution implement at high revolution. Be sure to know the designated PTO requirements for the implements.

[Otherwise]

The performance of the implement may not properly work and there is a risk of accident or injury or damage to the tractor.





GENERAL PRECAUTIONS

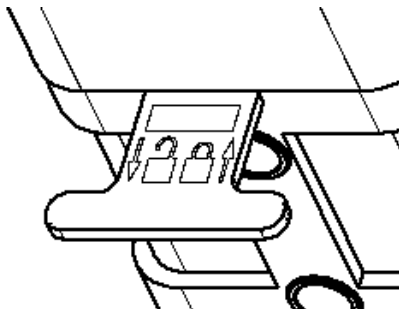

WARNING

Check and perform maintenance to loader after lifting it. And fix the joystick safety lever when dismantling

[Otherwise]

There is a danger of an unexpected death accident.



WARNING

Make sure to use the drawbar when towing. Never tow anything with the top link or the lower link.

[Otherwise]

Tractor may turn over.





GENERAL PRECAUTIONS

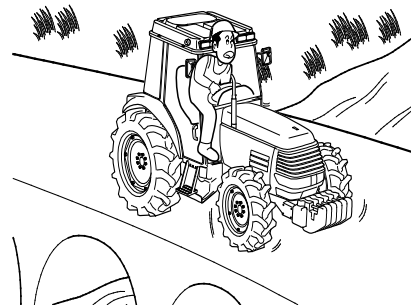
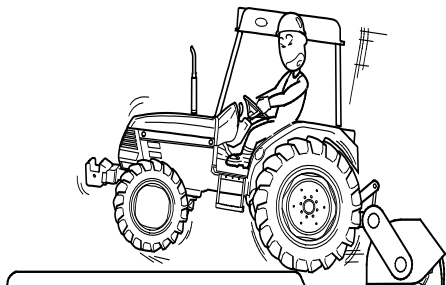

WARNING

When working with the rotary, put the rotary slowly on soft or rocky ground. The tractor may be pushed in an unexpected direction by the rotating force of the rotary.

[Otherwise]

There is a risk of accident or injury.



WARNING

Make sure to release the differential gear lock when making a turn.

[Otherwise]

The tractor may not turn to the direction you want and cause an accident and damage the tractor.





GENERAL PRECAUTIONS

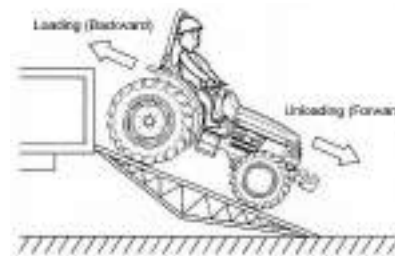
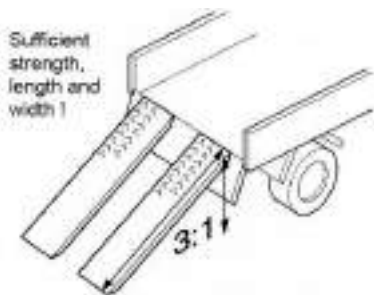

 WARNING	<p>Loading or unloading must be done on a flat and safe place, the tractor engine switched off, and the parking brake engaged. The loading ramps must be non-slip and have sufficient strength, length, and width for the tractor.</p>
---	--

[Otherwise]

The tractor may roll backward or fall off causing accident or injury.

 WARNING	<p>Move the tractor backward when loading it on the truck, and forward when unloading from the truck</p>
--	--

[Otherwise]

The tractor may roll backward or fall off causing accident or injury.



GENERAL PRECAUTIONS

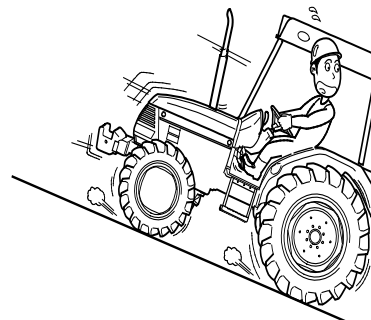
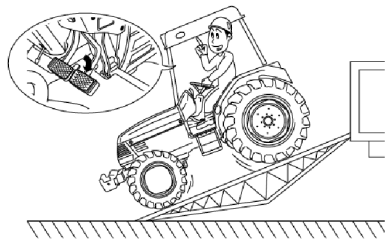

DANGER

Make sure to connect the brakes on both sides when loading or unloading the tractor.

[Otherwise]

The tractor may overturn due to one-sided braking when the brake pedal is depressed in an emergency.



WARNING

Pay particular attention to driving on the loading ramp. Do not operate the tractor as you do with normal use, such as stepping on the clutch, or putting the main gear or range gear or shuttle lever to "Neutral".

[Otherwise]

The tractor may roll backward or fall off causing accident or injury.





GENERAL PRECAUTIONS

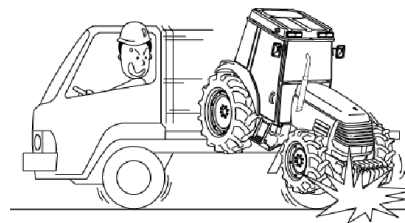
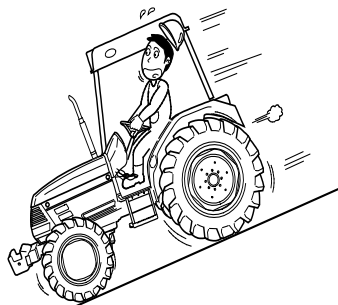

WARNING

When driving on slopes or on the loading ramps, select the proper gear and then do not shift the gear.

[Otherwise]

There is a risk of slipping, rolling, or overturning.



WARNING

When transporting the tractor, apply the parking brake with gear engaged and fasten the tractor to the truck securely with sufficient strength.

[Otherwise]

There is a risk of accident that the tractor may fall off the truck.





GENERAL PRECAUTIONS

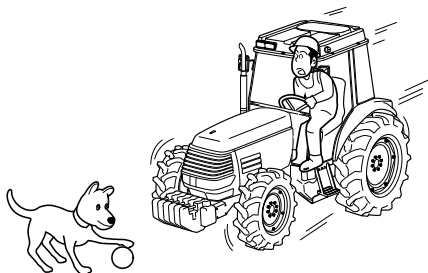

WARNING

Only operate tractor while people or animals are at safe distance away. Check around the tractor, start the engine, and move slowly

[Otherwise]

There is a risk of injury.



WARNING

Do not allow passengers to ride on any part of the tractor at any time. (Especially, children)
The operator must remain in the seat at all time.

[Otherwise]

An un expected accident may occur.





GENERAL PRECAUTIONS

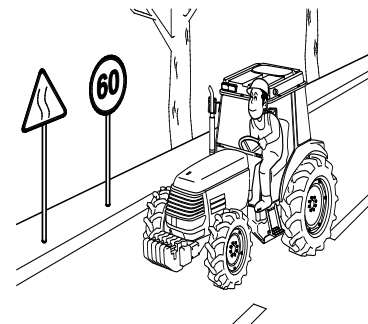
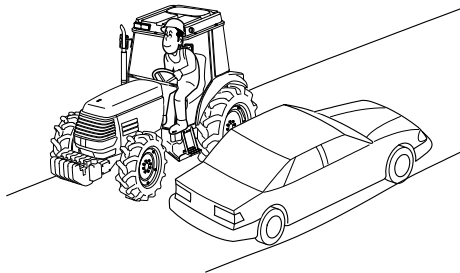

 WARNING	<p>When moving along the unpaved road with ditches or slanted sides, pay attention to the shoulders</p>
---	---

[Otherwise]

There is a risk of falling over.

 WARNING	<p>When driving on the road, observe the traffic regulations.</p>
--	---

[Otherwise]

There is a danger of accident or injury.





GENERAL PRECAUTIONS



WARNING

Make sure to connect the brake pedals when driving on a road.

[Otherwise]

There is a danger of abrupt turning or overturning due to one-sided braking when the brake pedal is depressed.



WARNING

Reduce throttle speed when making a turn, apply brake when driving on hilly or curved roads.

[Otherwise]

There is a risk of overturning.



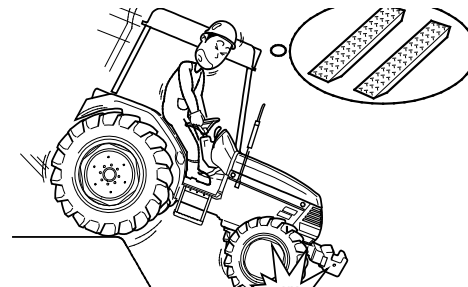

 WARNING	Check if the brakes work properly and evenly on both sides or if the steering wheel is loose.
--------------------	---

[Otherwise]
There is a risk of overturning.

 WARNING	Be sure to use the loading ramps when crossing a ditch or dike, or when passing through soft land. The loading ramps must be suitable for the tractor in width, length and strength.
--------------------	--

[Otherwise]
There is a risk of accident that the tractor may slip or turn over..



GENERAL PRECAUTIONS

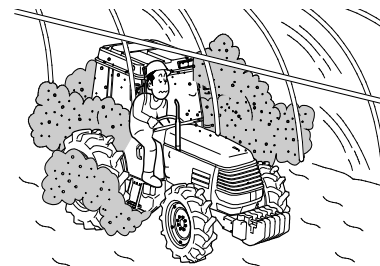
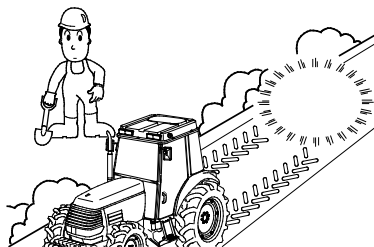

WARNING

When leaving the tractor, park the tractor on a flat and safe area, turn off the engine, and apply the parking brake. Also, let the implement rest on the ground.

[Otherwise]

The tractor may move and cause an accident.



WARNING

Ventilate the area to let out the exhaust gas.

[Otherwise]

The exhaust gas can cause intoxication and lead to fatal consequences.





GENERAL PRECAUTIONS

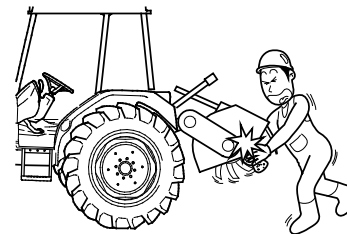
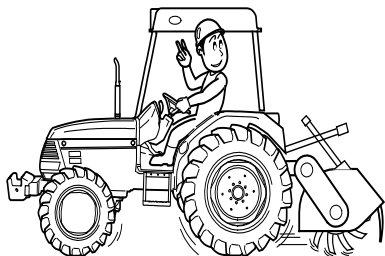

WARNING

Pay attention and keep hands on the steering wheel while driving.

[Otherwise]

There is a risk of accident to injury.



WARNING

Stop the engine when removing grass, etc. from the blades of the cultivator

[Otherwise]

There is a danger that you will get entangled in the cultivator or sustain a serious injury.





GENERAL PRECAUTIONS

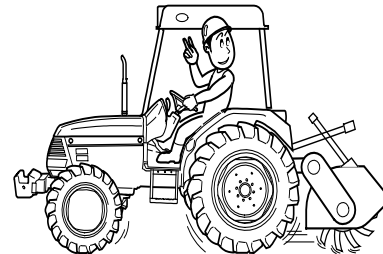
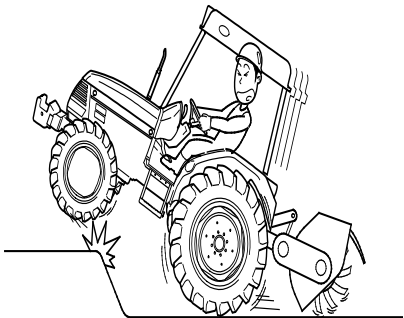

WARNING

Do not look away or take hands off the steering wheel while driving.

[Otherwise]

There is a danger of accident or injury.



WARNING

When entering or leaving the farming field, or moving across a dike or a raised ground, use the loading ramp and lower the implement as much as possible but that it does not touch the ground.

[Otherwise]

There is a danger that the tractor may turn over due to loss of balance.





GENERAL PRECAUTIONS

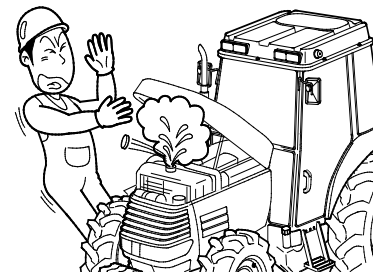
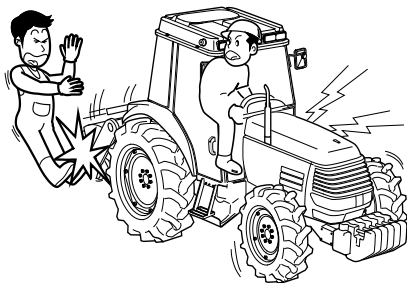

WARNING

When starting the engine, confirm that the implement is down on ground.

[Otherwise]

The implement may come down suddenly and cause an injury.



WARNING

Never open the radiator cap when the radiator is heated.

[Otherwise]

Hot water may splash, causing burns or damage.





GENERAL PRECAUTIONS

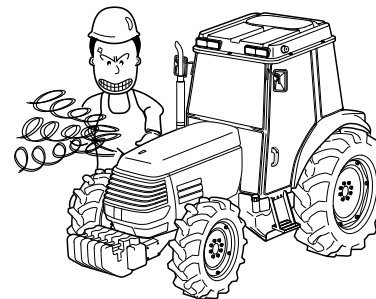
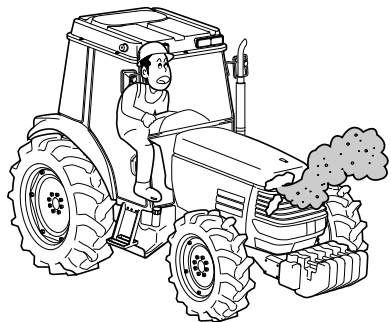

WARNING

Every day before operating the tractor, check if the electrical wiring is contact with other parts, or if the insulation is peeling off, or the contact points are loose.

[Otherwise]

There is a danger of fire due to short circuit.



WARNING

Every day before operating the tractor, check for straw, dust, fuel, or other residue on and around the muffler and the engine and remove them.

[Otherwise]

There is a danger of fire.





GENERAL PRECAUTIONS

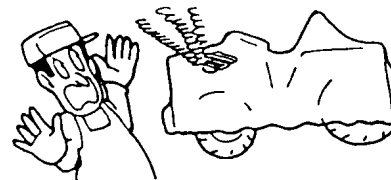
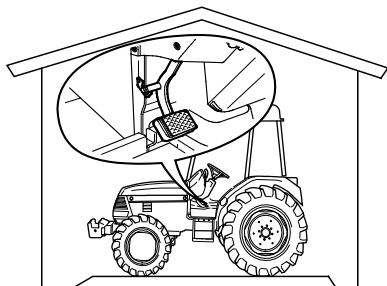

WARNING

When storing the tractor for a long period of time, make sure to put the clutch pedal in the "Disconnect" position.

[Otherwise]

The tractor may move and cause injury or an accident.



WARNING

Put tractor cover on only after parts such as the engine and muffler cooled down.

[Otherwise]

There is a risk of fire.





GENERAL PRECAUTIONS

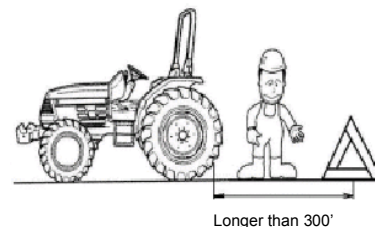
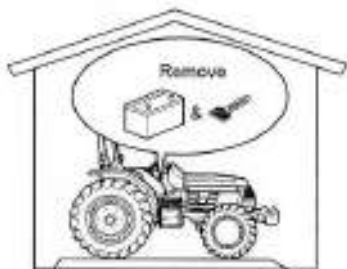

 WARNING	<p>When storing the tractor without use for a long period of time, remove the battery and keep the key in a safe place.</p>
---	---

[Otherwise]

There is a risk of an accident.

 WARNING	<p>Install the indication of disable car in accordance with the local regulation at the rear of the tractor when a failure occurs during travelling.</p>
--	--

[Otherwise]

It may cause a danger of rear-end accident.



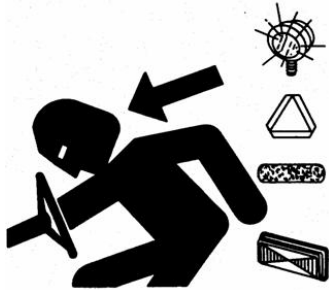

CAUTION

Item regarding lighting devices (alarm lamp and safety device)

- When the tractor has an implement attached or is moving slowly, you must often watch the rear side traffic status to avoid a collision accident when travelling on the road. In particular, be careful when you change directions. If necessary, the signal must be given by hand or direction indication lamp must be used.
- Always turn on the head light, and/or emergency lamp at night and day as requested by the local traffic regulation
- Maintain the light and indication plate so it can be visible always. Immediately repair or attach the broken or missed light and indicating plates.





GENERAL PRECAUTIONS

The following items, maintenance and adjustment should not be attempted, but contact the nearest authorized dealer, if necessary.

- Adjustment of injection pump without pre-approval. May cause components to deteriorate the durability and performance of the engine and may cause a fatal malfunction.
- Adjustment of hydraulic pressure set at shipment. May cause a fatal failure of related components and a subsequent accident.
- If you intend to adjust the components that may deteriorate durability and performance, always contact your nearest authorized dealer or service department of the head office.

[Otherwise]

Be careful it may cause a fatal error or may not be covered by the warranty.

Use agricultural chemicals in a safe manner.

Agricultural chemicals must be sprayed properly. Spraying of agricultural chemicals needs to be planned in advanced and be aware of potential damage to surroundings.

Do wear the protective clothing(mask, glove) for agricultural chemicals before spray work.

Clean the equipment and tractor just after spraying work.

[Otherwise]

You may be exposed to agricultural chemicals spray.





ABOUT WARRANTY





ABOUT WARRANTY

WARRANTY

You will need the “Warranty paper work” when your tractor requires warranty service. Read it and keep in a safe place.

TROUBLE SHOOTING

In case of mechanical trouble, refer to “Trouble shooting” at the end of this manual. If the problem cannot be corrected, please contact your nearest authorized dealer.

<Information you will need when contacting the dealer for service>

- Type of model and tractor s/n number.
- In case of engine, the engine s/n number.
- Circumstances of breakdown. (what kind of work, gear position, etc)
- Amount of work done. (square footage or number of hours)
- Other information in as much detail as possible surrounding the circumstances of the breakdown.

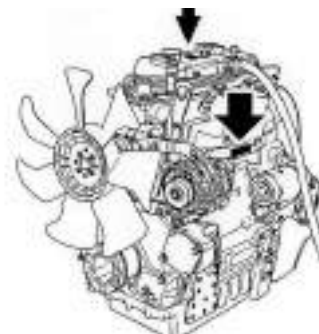
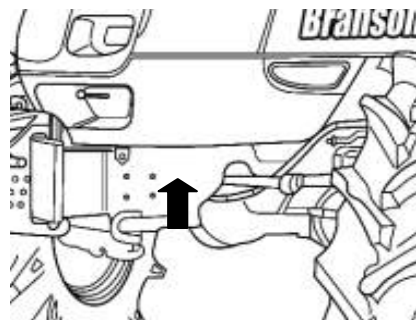



OVERVIEW OF THE TRACTOR





OVERVIEW OF THE TRACTOR

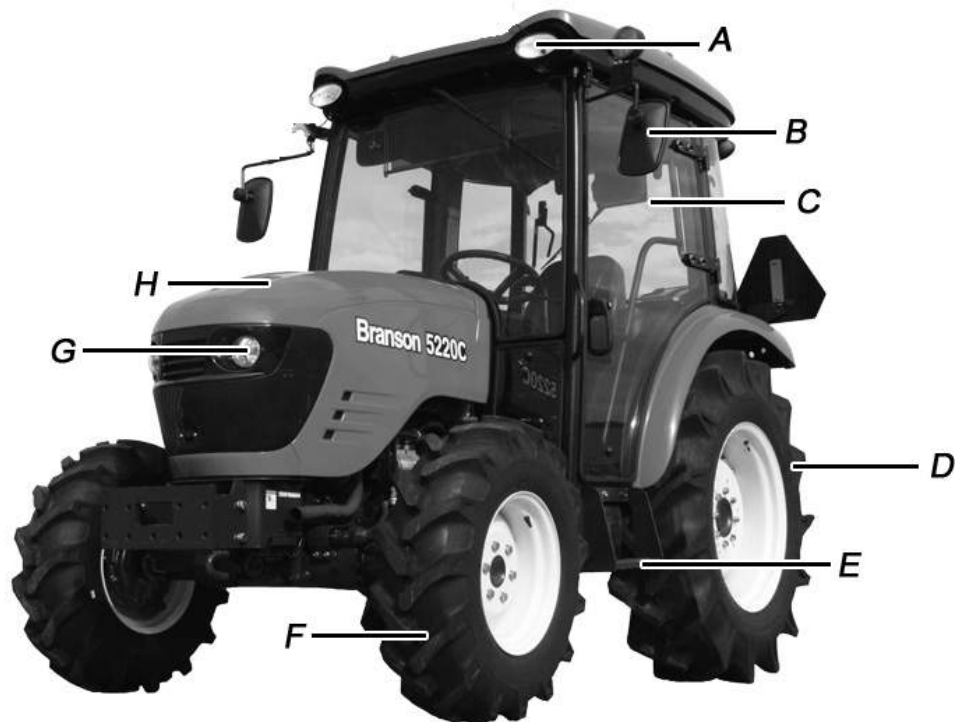

A: WORK LAMP (F)

B: SIDE MIRROR

C: DOOR GLASS

D: REAR TIRE

E: STEP

F: FRONT TIRE

G: HEAD LAMP

H: HOOD





OVERVIEW OF THE TRACTOR



A: WORK LAMP (R)

B: REAR WINDOW

C: REAR REMOTE VALVE

D: TOP LINK

E: LOWER LINK

F: SMV SIGN

G: REAR COMBINATION LAMP





OVERVIEW OF THE TRACTOR

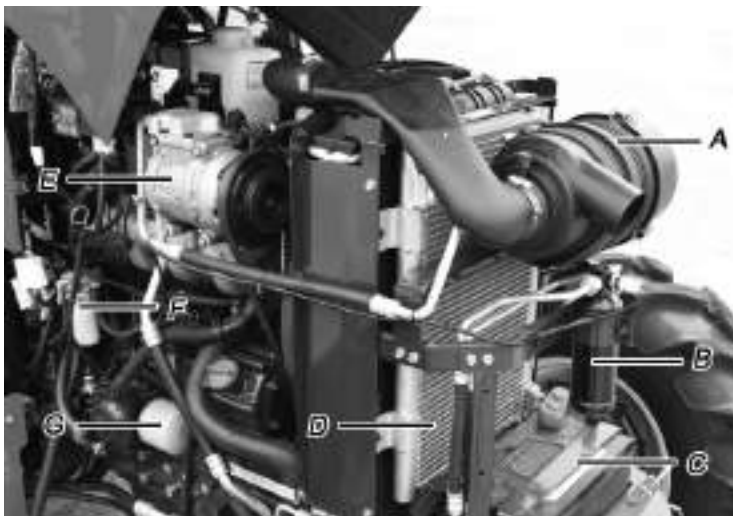

A: AIR CLEANER

B: RECEIVER DRYER

C: ENGINE OIL FILTER

D: CONDENSOR

E: COMPRESSOR





FUNCTIONS





SWITCHES AND LEVERS

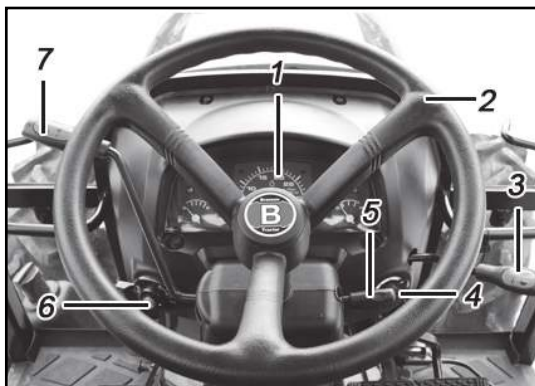

- 1: STEERING WHEEL
- 2: DASH METER
- 3: ACCELATOR LEVER
- 4: MAIN KEY SWITCH
- 5: STEERING COLUMN TILT LEVER
- 6: COMBINATION LAMP SWITCH
- 7: F/R SHUTTLE LEVER
- 8: PTO SHIFT SWITCH
- 9: EMERGENCY LAMP SWITH



1. MAIN KEY SWITCH



CAUTION

When the tractor is not in use, take out the key and keep it in a safe place.

[Otherwise]

Children may start the tractor and cause an accident.



It is used to start the engine.

“OFF” The engine is stopped, and current does not flow. (The key can be taken out)

“ON” Electric current flows to the switches of all electrical parts. If the engine is stopped, the engine oil pressure pilot lamp and the battery charge pilot lamp are lit. Depending on the outside temperature, the thermostat pilot lamp may also be lit.

“START” Starting motor turns and the engine is started. Once the engine is started, take your hand off the key. The key will return to the “ON” position automatically and the engine will keep running.

Turn engine off before performing any maintenance on tractor





FUNCTIONS

2. ACCELERATOR LEVER



It is used to make the engine run faster or slower. It is also used when working at a constant speed.

3. F/R SHUTTLE LEVER



It is used for shifting between “forward” and “reverse” drive. When shifting the gear, depress the clutch fully.

[Precaution]

For safety, when shifting from “forward” to “reverse” or from “reverse” to “forward”, put the lever in the “neutral” position and wait for the tractor to stop moving before shifting the gear to the opposite direction. To ensure safety, the lever must first be pulled upward for shifting to another position.





4. DIRECTION LAMP S/W



With the key switch in the “ON” position, turn the direction indicator switch to the right to turn on the direction indicator lamp in the right side, and turn the indicator switch to the left to turn on the lamp on the left.

5. HEAD LAMP & HORN S/W



HEAD LAMP S/W :

With the main switch in the “ON” position, turn the light switch one click to the right for high beam and two clicks to the right for low beam.

HORN S/W:

With the main switch in the “ON” position, press the horn button to sound the horn.



6. STEERING WHEEL TILT LEVER



Confirm that the steering wheel is firmly fixed.

7. PTO SHIFT SWITCH



It is used for turning on or off the PTO clutch.

- **PTO clutch switch [IND]**
PTO gets independent, and even when the lift arm is lifted, PTO continues to rotate and PTO lamp lights on the instrument panel.
- **PTO clutch switch [LINK]**
PTO gets connected, and when the lift arm is lifted, PTO stops to rotate. And when the lift arm is lowered, PTO rotates and PTO lamp lights on the instrument panel.
- **PTO clutch switch [OFF]**
PTO does not rotate. When not working, put to this position. The engine does not start up, when the PTO clutch is in [IND] or [LINK]. Put to [OFF] position for starting up the engine.



8. EMERGENCY LAMP SWITCH



Used to prevent accidents in an emergency. Activate by pressing switch as to warn other vehicles. Emergency lamp operates regardless of main switch and every direction lamp will cease at once. Press once again to cancel.





FUNCTIONS

9. DASH METER

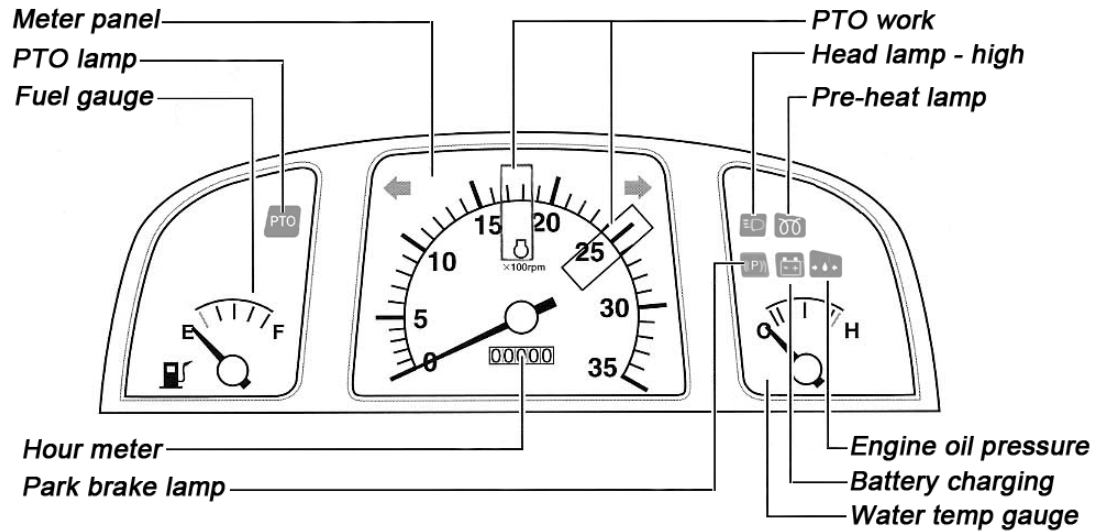



1) ENGINE RPM INDICATOR

The needle indicates the number of engine RPM

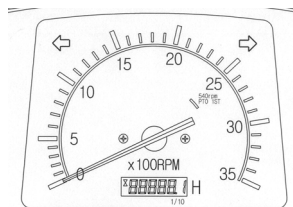

2) ENGINE HOUR METER

It indicates the tractor's running hours. By multiplying the digit in the far right position by 6, you will get the time in minute.

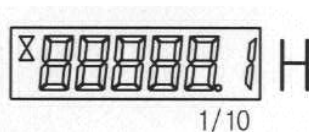

3) PTO WORK

It indicates the position where PTO achieves 540rpm when engine rpm is 2600rpm at PTO 1st stage.
It indicates the position where PTO achieves 1000rpm when engine rpm is 2600rpm or where PTO achieves 540rpm when engine rpm is 1000rpm at PTO 2nd stage.(econo-position).

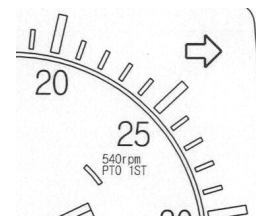

4) PTO LAMP

Lamp will come on when PTO is engaged. On the contrary, if PTO is disengaged, lamp will be turned off.



5) PRE-HEAT LAMP

Lamp will come on when the ignition switch is put into the “ON” position with outside temperature of around 40°F, indicating that electricity is supplied to the heater or glow plugs. Turn the ignition switch to “START” after the lamp has been turned off (it is turned off automatically) then it will start the engine.

Note) The length of time the thermostat stays on will depend on the temperature of the engine coolant.

Coolant temp : 32°F ~ 60°F 10sec
 32°F ~ 5°F 20sec



6) BATTERY CHARGING LAMP

It will be turned on when the key switch is put into the “ON” position, and will be turned off when the battery starts being charged after engine is started and the engine revolution increases. The battery will not be charged with the engine below 1,000 rpm. (The rpm should be 1,500 rpm or higher)

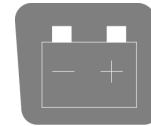

7) ENGINE OIL PRESSURE LAMP

Lamp will come on when the ignition switch is put into the “ON” position. It will turn off when the engine is started. If this lamp comes on while the engine is running, it indicates a problem in the engine oil system. Stop the engine immediately and check for problems.





8) FUEL GAUGE

Indicates the quantity of fuel remaining in the tank. If the needle is in the red zone, refill immediately.

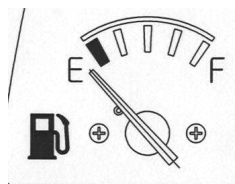

10) HEAD LAMP (HIGH BEAM)

Indicates the head lamps beam's position. It will come on when the head lamps are on Hi beam. On the contrary, if the head lamps are in the low beam, this indicator will not be lit.

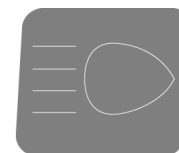

9) WATER TEMP GAUGE

The needle indicates the temperature of the engine coolant during running. If the needle is in the red zone, stop running the engine and check for problems.

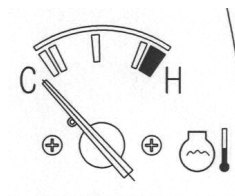



FUNCTIONS

PEDALS

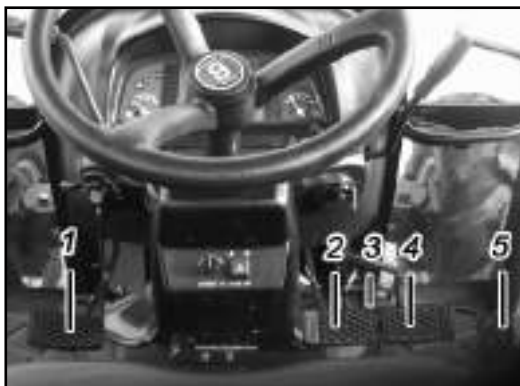

1: CLUTCH PEDAL

2: BRAKE PEDAL (LH)

3: BRAKE PEDAL CONNECTOR

4: BRAKE PEDAL (RH)

5: ACCELATOR PEDAL





1. CLUTCH PEDAL



It is used to transmit the engine power.

2. BRAKE PEDALS AND CONNECTOR



WARNING

Make sure to connect the brake pedals with the connector when driving on a road.



Brake pedals are independent of each other and can be used for making a small turn on the pavement. Depressing the brake pedal on the side to which to make a turn, the rear wheel on that side is stopped and the tractor can make a small turn.





FUNCTIONS

3. ACCELATOR PEDAL



It is used to make the engine run faster or slower. It is usually used when driving on a road.





LEVER OPERATION (A)

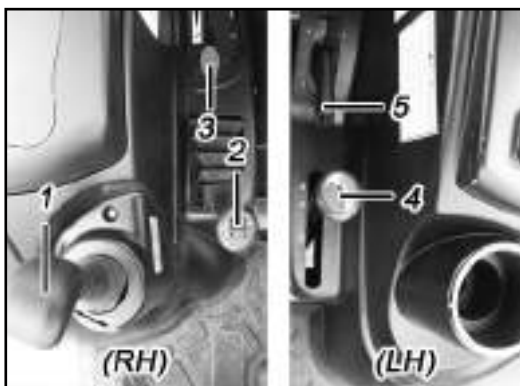

1: MID REMOTE VALVE JOYSTICK

2: MAIN GEAR SHIFT LEVER

3: 3PT POSITION LEVER

4: RANGE SHIFT

5: PARK BRAKE LEVER

6, 7: REAR REMOTE CONTROL LEVER (I,II)





FUNCTIONS

1. MID REMOTE VALVE JOYSTICK



Front-loader exclusive joystick valve is attached and control lever is attached on right-front side of driver's seat.

Loader will move up when pushed forward and move down when pulled backward. Bucket will move up when pushed to the left and move down when pushed to the right. Joystick lever must be locked when driving while loader is lifted. Otherwise it may cause accident.

2. MAIN GEAR SHIFT LEVER



The gear is shifted in four levels. When shifting the gears depress the clutch fully.





3. 3PT POSITION CONTROL LEVER



WARNING

Confirm that no one or a foot is under the implement before operating the system.

[Otherwise]

There is a danger of injury



It is used to keep the implement constantly at a certain position. When the lift lamp is on, the implement cannot be lowered with position control lever. A stopper is used to fix the position control lever in the “UP” position while driving on a road.

•When lowering the implement, set the position control lever, and the implement will go down to the set position.

4. RANGE SHIFT LEVER



The range gear is shifted in three levels(A-B-C). The combination with the main gear provides 12 levels of gear shifting.

When shifting the range gear, stop tractor and depress clutch pedal fully.





FUNCTIONS

5. PARK BRAKE LEVER



Pull the lever up while depressing the brake pedal fully to engage the parking brake. To release the parking brake, step on the brake pedal and push the lever down.

- Connect both brake pedals with the connector.

6, 7. REAR REMOTE CONTROL LEVER (I,II)



It is used to for the rear implement hyd-function.

LEVER#	I	II
DETENT	N/A	REAR





LEVER OPERATION (L)

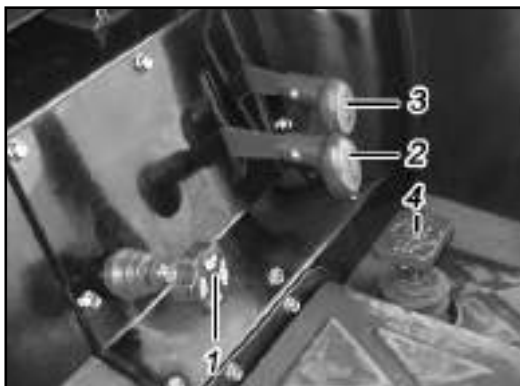

1: STOP / SLOW RETURN VALVE

2: MFWD LEVER

3: PTO LEVER

4: DIFFERENTIAL LOCK PEDAL





FUNCTIONS

1. STOP/SLOW RETURN VALVE



It is used to regulate the lowering speed of the implement (slow return function). Also, if you wind the valve fully to the right, the hydraulic pressure to the device raising the implement is stopped.

2. MFWD LEVER



It is used to shift between 2-wheel drive and 4-wheel drive. Depress the clutch pedal when shifting the lever.



3. PTO LEVER



CAUTION

Observe the PTO speed designated on the implement. Otherwise, the implement may be damaged and cause an accident.



The revolution of the PTO shaft can be shifted in two levels. When shifting level, shift PTO switch to 'OFF' position.

PTO 1	540 RPM
PTO 2	760 RPM (540E)

4. DIFFERENTIAL LOCK PEDAL



WARNING

Release the differential gear lock when making a turn. Otherwise, the tractor may not turn in the direction you want and cause an accident.



It is used to transmit the same power to both rear wheels and serves to prevent slipping when one of the rear wheels is idling.





FUNCTIONS

OTHERS

1: WORK LAMP SWITCH

2: POWER OUTLET 12V

3: WIPER SWITCH

4: CLIMATE CONTROL

5: SEAT





1. WORK LAMP SWITCH



It is used to turn on work lamps on the top roof.

2. POWER OUTLET 12V



Accessory 12-volt electrical outlet is used when connecting auxiliary equipment.





FUNCTIONS

3. WIPER SWITCH



CAUTION

Do not use the washers when the washer fluid reservoir is empty, otherwise you will damage the washer pump.

Do not use the washers if there is any danger that the fluid will freeze on the windshield. If you do, your vision could be obscured. For this reason, use antifreeze



Wiper blades will operate when upper buttons of wiper switch are pressed.

Washer fluid is sprayed on to windshield and the wipers are operated when buttons are pressed once more.

Lower buttons will only spout wash liquid.

Wash liquid tank for cleaning is located on rear left side of cab exterior.





4. CLIMATE CONTROL

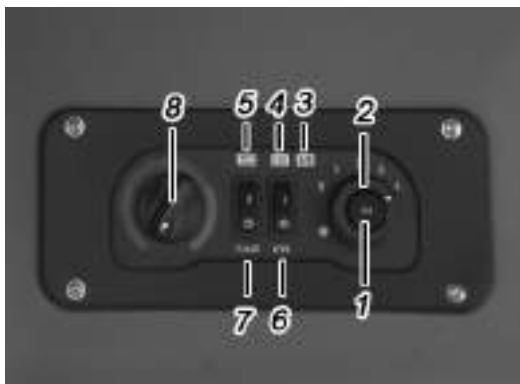

1: COOLING FUNCTION :

When the cooling function is on, the air compressor is worked then reheated according to the temperature setting.

2: AIR FLOW RATE :

Adjust the air flow rate. The higher the rate, the more effective the heating or cooling will be

3: AIRCONDITIONING INDICATOR

4: HEATER INDICATOR

5: AIR CIRCULATE INDICATOR

6: HEATER CONTROL

7: AIR CIRCULATE CONTROL:

Used to shift the supply of outside air and re-circulates the inside air

8: TEMPERATURE :

Red, to increase the temperature.

Blue, to decrease the temperature.





FUNCTIONS

5. SEAT



CAUTION

Never attempt to adjust your seat while the tractor is moving. The seat could respond with unexpected movement, and the ensuing loss of tractor control could lead to an accident.

Fore and Aft positioning : Lift handle and move the seat forward or rearward. Release the handle at one of several positions.

Back cushion angle adjustment : Lift the handle and let the back cushion spring forward, or lean backward into the cushion. Release the handle at desired position

Weight adjustment : With seat in mid-position, extend the crank lever from knob and rotate minus(-) direction for less support or Plus(+) for more support. Use the indicator for approximate weight setting. Release crank lever







OPERATION & WORK



CHECKING BEFORE OPERATION

 DANGER	<ul style="list-style-type: none"> Do not provide illumination with a lit cigarette or a lighter when fueling. Never fill the fuel tank while the engine is running or hot. After filling the fuel tank, close the fuel filler cap completely and wipe off the excess fuel thoroughly. If the fuel hoses are damaged, fuel will leak. Make sure that you check for any leakage.
--	---

 WARNING	<p>Perform the maintenance on a flat and safe location that will keep the tractor in place and will not cause a risk to people passing by. Before carrying out the maintenance, place blocks at the front tires to prevent movement.</p>
---	--

[Otherwise]

An unexpected accident may occur, such as overturning of the tractor.

- When going under the implement, fully close the slow/stop valve.

[Otherwise]

There is a risk of injury due to implement falling.

- If the fuel hoses are damaged, fuel will leak. Make sure that you check for any leakage.

 CAUTION	<p>Stop the engine during checking, maintenance, or repair</p> <p>Carry out the maintenance work after heated area such as the muffler or the engine have fully cooled down.</p>
--	--

[Otherwise]

There is risk of burn.

 CAUTION	<p>After detaching the covers for checking or maintenance, make sure to put them back in their place.</p>
--	---

[Otherwise]

There is a risk that you may get entangled in the tractor or get injured.

 CAUTION	<p>If the fuel hoses are damaged, fuel will leak. Make sure that you check for any leakage.</p>
--	---





To ensure a safe and comfortable operation, please carry out the routine check-up everyday before starting work. Correct any problem immediately, and also check for problems after work. This checking should be done in the following sequence.

a) Check the suspicious parts of the previous day.

Check the parts that you thought were not normal during the work of previous day.

b) Check around the tractor.

- Parking deformation, damage or stains
- Tire pressure and abrasion
- Damage to the tractor, or loosened bolts
- Loosening of wheel bolts
- Fuel quantity, fuel leaks, or damage to the fuel hose

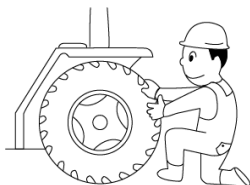

c) Open the engine hood.

- Engine oil level, contamination, or leakage



- Engine coolant level, leakage, or damage to the hose





OPERATIONS & WORK

- Battery solution level

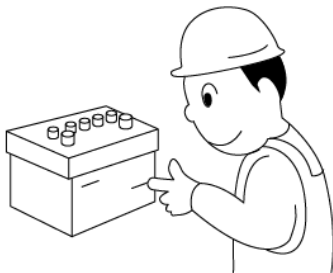

- Cooling fan belt tension, damage

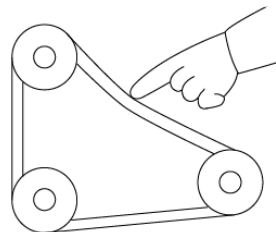

- Air cleaner

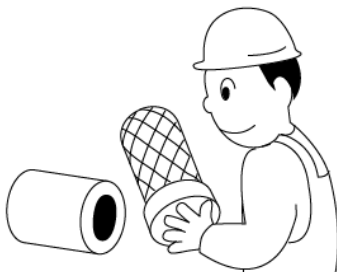

- Dust or straw on the radiator grill or the engine

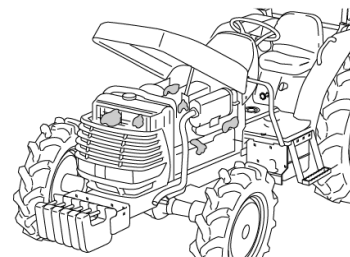



- Damage to the coating of the cables, or loose connection.



- d) Check around the implement

- Condition of the locking pin of the universal joint inserted in the PTO shaft
- Condition of R pins in each part
- Loosening of the bolts holding the blade
- Quantity of oil in each part. For more details, please refer to the implement manufacturer's instructions.

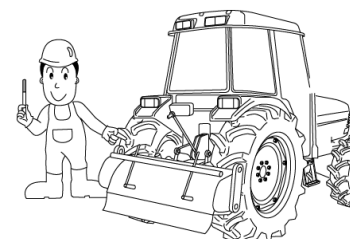



OPERATIONS & WORK

- e) Check on the driver seat.
 - Operational condition and free play of the brake (0.2~0.4in)

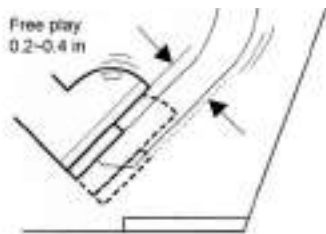

- Operational condition and free play of the clutch pedal

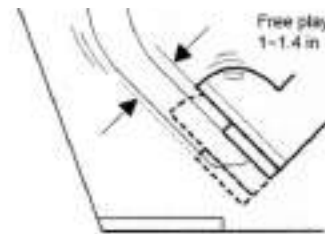

- Free play of the steering wheel (0.8~2.0in)

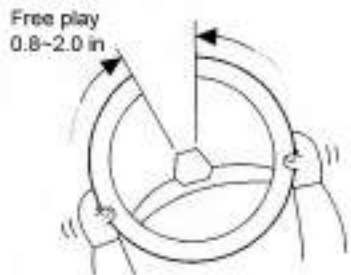



f) Start the engine.

- Abnormal noise from the engine



- Operation of lamps and gauges



- Color of the exhaust gas





Note) *BREAKING IN YOUR TRACTOR* (FIRST 50 HOURS)

The operation of a new tractor during the first 50 hours is very important, as it will greatly influence the life and performance of the tractor.

Pay attention to the following precautions during the break-in period.

1. Avoid rapid accelerating and abrupt stopping.
2. Avoid over-speeding and overloads.
3. Drive the tractor after the engine has been warmed up.
4. Reduce the speed while driving on a rough road or a slope.
5. At the first 50th hour, carry out inspections of each part and replace the engine oil.



STARTING/STOPPING THE ENGINE



DANGER

When starting the engine, make sure that you are seated in the driver's seat and check position of the levers and the safety around the tractor.

[Otherwise]

There is a risk of injury.



DANGER

Do not start the engine in an enclosed space. You must start the engine outside where there is open air. If you should have to start the engine inside a building, make sure that the space is well ventilated.

[Otherwise]

The exhaust gas can cause intoxication and can lead to fatal consequences.



CAUTION

Make sure to carry out checking and maintenance before and after the use of the tractor, particularly the operating devices such as the clutch and the brake lever.

[Otherwise]

There is a risk of injury or machinery breakdown.

Engage the parking brake during warming-up. Otherwise, the tractor may move and cause an accident.



CAUTION

Don't crank engine unless position control lever is in the lowest position.

[Otherwise]

Implement might rise quickly and there is a risk of injury or machinery breakdown.





OPERATIONS & WORK

1. TO START THE ENGINE

a) Check fuel.

Check if there is enough fuel by observing fuel gauge.

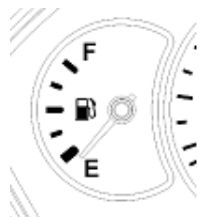

b) F/R shuttle lever into "Neutral" position.

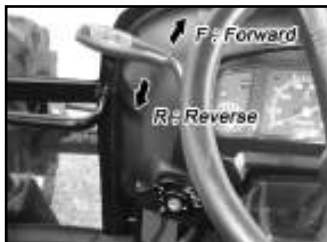

c) Put the position control lever into the "lowest" position and PTO switch turn to OFF position.



WARNING

Don't crank engine unless position control lever is in the lowest position.

[Otherwise]

Implement might rise quickly and there is a risk of injury or machinery breakdown



WARNING

Check the safety around the tractor and start to move slowly.

[Otherwise]

There is a risk of injury.





d) Put the acceleration lever to Min.



f) After the thermostat lamp has turned off, depress the clutch pedal fully and turn the MAIN KEY SWITCH to START

g) Once the engine has started, take your hand off the MAIN KEY SWITCH.

h) Increase the engine to about 1,500rpm and warm it up for about five minutes without a load.

e) Main shift lever / range shift lever into "NEUTRAL" position.



2. TO STOP THE ENGINE

- a) Put the acceleration lever on LOW, and turn the main switch to “OFF”.
- b) Put shuttle lever, main gearshift lever and PTO shift lever to “N”. Put PTO clutch switch in to the “OFF” position and front wheel lever to the “OFF”.
- c) Put the position control lever on “DOWN”.

 WARNING	<ul style="list-style-type: none">• When stopping the engine, never stop it with the reducer lever.• After stopping the engine, make sure to apply the parking brake.
---	--

(Note) for warming-up operation, strongly step on the brake pedal and pull your parking brake.



When leaving the tractor, park the tractor in a flat and safe place, put the shuttle lever and the main shift lever to “N”, and block the tires.

[Otherwise]

The tractor may move and cause an accident. **ALWAYS SET THE PARKING BRAKE**

DRIVING ON THE ROAD



WARNING

- When driving on a road or crossing a dike, make sure to connect the brake pedals. Otherwise, the tractor may turn abruptly or turn over due to one-sided braking.
- Observe the traffic regulations when driving on the road. Otherwise, you may be involved in an accident.
- This tractor is designed to accommodate only one person. Do not allow anyone on the tractor other than the driver. Otherwise, you will be exposed to a risk of accident.
- Put the PTO lever into "N" and connect the brake pedals.
- When making a turn, turn in the direction indicator lamp to inform other vehicles of your intention.
- Pay particular cautions to narrow farm roads, slopes, and grassy shoulders, and reduce the speed.

- Put the position control lever to UP and lock it with the stopper. Otherwise, you will be exposed to a risk of an accident.
- Connect the brake pedals when driving on a road. Otherwise, there is a risk of abrupt turning or overturning due to one-sided braking.
- Before every operation, make sure that operator wears safety belt.

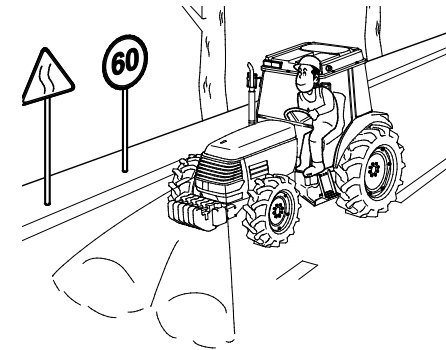



DRIVING ON THE SLOPE



WARNING

- Select a proper speed, and do not shift the gear.
- Do not park on a slope. Otherwise, the tractor may slip or overturn and cause an accident.
- Reduce speed and pay special attention to the speed.
- Do not depress the clutch pedal when driving on a slope. The tractor may slide down and lead to a serious situation.
- When starting the tractor upwards on a slope, start slowly in low gear with low engine rpm. Otherwise, the front of the tractor may be lifted and cause a very dangerous situation.
- You may shift the gear when you are no longer on the slope. If you stop on a slope, apply the parking brake. Otherwise, you may be exposed to a risk of accident.

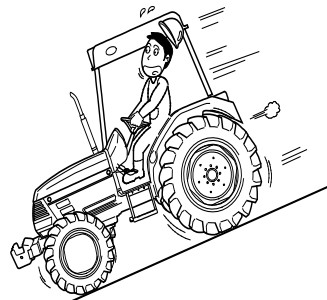



ENTERING AND LEAVING THE PAVEMENT



WARNING

- Make sure to connect the brake pedal. Otherwise, the tractor may turnover due to one-sided braking.
- When you cross a dike or raised ground to enter or leave the pavement, use loading ramps with sufficient strength, and lower the implement to achieve a lower center of gravity.
- Drive backward when climbing up a steep slope, and drive forward when climbing down.



<NOTE>

Enter or leave the pavement in a perpendicular direction. When climbing onto the pavement, lower the implement to achieve a lower center of gravity. Once all wheels of the tractor are on the pavement, raise the implement.





TURNING ON THE PAVEMENT



Make sure to release the differential gear lock before making a turn.

[Otherwise]

The tractor will not turn in the intended direction but may cause an accident.



When making a turn, reduce the engine rpm and make a slow turn. When making a turn on the pavement, remove the connector of the brake pedals. Depress the brake pedal on the side to which to make a turn, while steering the wheel, this will allow the tractor to make the turn without moving ahead. Make sure to keep the implement in the up position when making a turn.





DIFFERENTIAL GEAR LOCK



WARNING

Make sure to release the differential gear lock when making a turn.

[Otherwise]

The tractor will not turn in the intended direction and may cause an accident



CAUTION

Never lock the differential gear when driving on a road.

[Otherwise]

Driving will be unstable and the tractor may cause an accident

Depressing the differential gear lock pedal will make both rear wheels roll at the same speed. Releasing the pedal will automatically unlock the differential gear.



TRACTOR LOADING / UNLOADING

 DANGER	<ul style="list-style-type: none">• Fix the direction so that the tractor will not have to modify its direction on the loading bridge, and proceed at the lowest speed.• Never depress the clutch pedal to change direction or stop.
--	---

[Otherwise]

There is a danger that the tractor may turn over.

 WARNING	<ul style="list-style-type: none">• The loading ramp must be non-slippery and have sufficient strength, length, and width for the tractor. To avoid slipping of the loading ramp, latch it securely onto the truck.• Move the tractor backward when loading, and forward when unloading.• Fasten the tractor to the truck securely with rope.
---	---

[Otherwise]

The tractor may fall off the truck and cause an accident.



INSTALLING 3POINT LINK



- 1: LOWER LINK
- 2: DRAW BAR
- 3: LIFT LINK
- 4: CENTER LINK
- 5: STABILIZER LINK

- a) Attach the lower link to the link hook and insert pin into hook.
- b) Connect Check chain to bracket & Lift link mounting hole and adjust length.

Refer to instruction of implement for adjusting swing clearance.





OPERATIONS & WORK

c) There are 3- holes in top link mounting bracket
Top link needs to be moved from (A) to (C) as followed.

- The Position 'A' allows the minimum pressure.
- The Position 'B' is standard.
- The Position 'C' allows the maximum pressure.

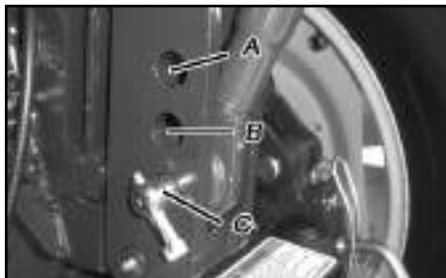

d) Adjusting for vertical float

Depending on the position of the steel plate, lift links can be adjusted to allow for vertical float or to lock out float.

Note: May be damage to the screw thread when center link is excessively, turned over the adjustment range.





e) Turn the A-lever clockwise to rise up lift links. On the contrary, turn the A-lever counter clockwise to lower down lift links.



CAUTION

After adjusting, turn down the lever for locking.



PRECAUTIONS FOR CONNECTING THE IMPLEMENT

 WARNING	When the PTO shaft is not in use, affix the safety cover on it.
---	---

[Otherwise]

There is a risk of getting entangled in the tractor or injured.

- When engaging or disengaging the implement by moving the tractor, make sure that no one is allowed around the tractor or between the implement and the tractor.
 - Engage or disengage the implement on a flat and safe place. Supply proper lighting at all times and especially at night.
 - When engaging a heavy implement, load the weight on the front to keep the balance of the tractor.
 - When adjusting the implement, apply the parking brake, switch off the engine, and confirm that the PTO lever is on the “N” position.
 - When towing something, make sure to use the draw-bar.
- Increase the wheel tread on a slope or when towing.
 - Depending on the implement, the overall length may become very long. Pay particular attention to people or objects nearby when making a turn.
 - Do not substitute the balance weight with a person or anything else. Always use the recommended balance weight.
 - For front loader work, mount an implement on the rear to keep the balance of the tractor.
 - Read the instruction manual of the implement mounted to the tractor.



ADJUSTING WHEEL TREAD

Adjust the wheel tread depending on the type and condition of the work. Also, increase the wheel tread when working on a slope or towing.

 WARNING	When changing tires, please use a hoist or strong support and make sure the tractor does not move.
---	--

[Otherwise]

There is a risk of death or injury.

- a) Pull the parking brake, block the front wheels, and raise the body with a jack to make the rear wheel lift from the ground.
- b) To make sure adjustments alternatively between the left and right wheel.

<FRONT / REAR WHEEL>

DESCRIPTION	TIGHTENING TORQUE
Bolts on wheels and axle	280 lbf-ft (40 kgf.m)
Bolts on rim and disk of wheels	250 lbf-ft (35 kgf.m)

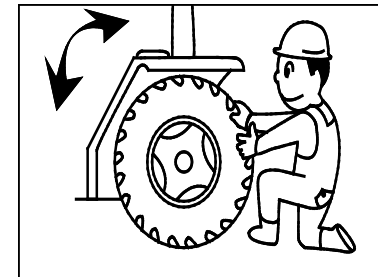

POWER STEERING



WARNING

- Pay attention to the steering wheel while driving, because it can be very lightly manipulated when the engine is running.
- Power steering will run only when engine is running. When engine is idling, power steering may feel a little heavy.
- If the wheel is steered to the maximum, the relief valve is opened and a warning sound will be made. Do not continue to operate the tractor with the warning sound.
- Do not steer the wheel unnecessarily, because steering the wheel without moving will attribute to early wear of tires and rims.





MAINTENANCE AFTER WORK



 WARNING	When covering the tractor, make sure that the engine or the muffler has fully cooled down.
---	--

[Otherwise]

There is a risk of fire

After work, clean the tractor. After cleaning, dry the moisture and supply grease into each grease nipple.



 CAUTION	When carrying out checking, maintenance, or repair, make sure to turn off the engine.
---	---

[Otherwise]

There is a risk that you may be entangled in the tractor or get injured

Avoid water on electrical parts whenever possible, as it will cause equipment breakdown.



MAINTENANCE FOR PROLONGED STORAGE



CAUTION

When storing the tractor for a long time, take out the key and keep it in a safe place. Otherwise, there is a risk of accident.



WARNING

Carry out maintenance on a flat and safe place where the tractor will not fall or move and there is no traffic danger. Also, block the front tires to prevent moving of the tractor. Otherwise, there is a risk of accident, such as overturning of the tractor.



WARNING

- Carry out checking and maintenance for each part every year.
- In particular, replace the fuel pipe and the steering wheel hose every two years. Otherwise, there is a risk of accident or machinery breakdown due to poor maintenance.
- When carrying out checking or maintenance, make sure to stop the engine.
- Replace the covers that have been detached for checking or maintenance.

[Otherwise]

There is a risk of getting entangled in the tractor or injured.

- Carry out checking or maintenance after heated parts, such as muffler, engine or transmission, have fully cooled down.

[Otherwise]

There is a risk of getting burnt.

If you carry out maintenance during the off season, you can ensure optimum condition of the tractor as well as safe and comfortable working conditions during the busy season. Also, in order to secure the safety of each part of the tractor and to prevent an accident that may occur due to poor maintenance, arrange with your authorized dealer for periodic maintenance once a year.

In particular, we recommend that the electrical cables and the rubber hoses, such as fuel hose, steering wheel hoses and radiator hoses, be replaced every two years.





MAINTENANCE AFTER WORK

- When the tractor will not be used for a long time, store it in the following manner.

(1) For long storage, put the ignition switch to “OFF”

(2) Select a dry and well-drained place for storage. Remove the weights & implement or put it down onto the ground.

(3) Apply the anti-corrosion oil or engine oil and grease on the parts that are subject to rust.

(4) Fill up the fuel tank. Empty space in the fuel tank will produce dewdrops that will produce condensation that will be the cause of rust formation. And lock the fuel shut off valve to “C” (closed).

(5) Disconnect the battery completely and store it away from the tractor in a well-ventilated, dry, dark place if possible. When the battery is attached to the tractor, make sure to connect the (+) terminal first.

[Precaution] The battery will be discharged even if it is not in use. Recharge it fully every 12 months.

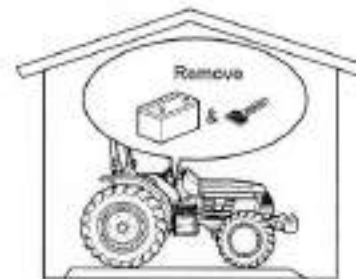



- (6) Drain the coolant.
- (7) Cover the air cleaner, muffler, and engine oil inlet with plastic sheets to keep moisture away.
- (8) Keep the clutch pedal in a depressed position to avoid rust on the clutch.

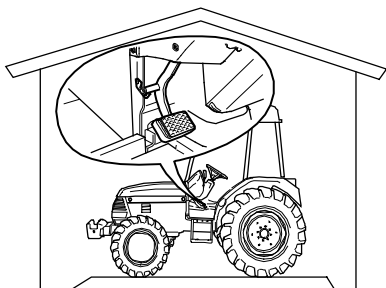

- (9) Maintain the air pressure in the tires.





MAINTENANCE AFTER WORK

<MEMO>





PERIODIC MAINTENANCE AND ADJUSTMENT



PERIODIC MAINTENANCE SCHEDULE

Check items \ Running Hour	50	100	150	200	250	300	350	400	450	500	550	600
Engine oil	R	R		R		R		R		R		R
Transmission fluid	R	o	o	o	o	R	o	o	o	o	o	R
Front axle fluid	R	o	o	o	o	R	o	o	o	o	o	R
Engine oil filter	R					R						R
Transmission fluid filter	R					R						R
Radiator cleaning	At the time the coolant is replaced											
Fuel oil filter and element		o		o		R		o		o		R
Coolant	Check before every work (Replace every year)											
Air cleaner element	o	o	o	o	o	o	o	o	o	R	o	o
Air filter cleaning	o	o	o	o	o	o	o	o	o	o	o	o
Fan and radiator cleaning	o	o	o	o	o	o	o	o	o	o	o	o
Battery solution	Replace every two years											
Battery (specific gravity)		o		o		o		o		o		o
Fuel pipe and connection	o	o	o	o	o	o	o	o	o	o	o	o
Steering wheel hose	o	o	o	o	o	o	o	o	o	o	o	o
Radiator hose	o	o	o	o	o	o	o	o	o	o	o	o
Hydraulic fluid hose	o	o	o	o	o	o	o	o	o	o	o	o
Fuel hose, electric cables	o	o	o	o	o	o	o	o	o	o	o	o
Electric cables	o	o	o	o	o	o	o	o	o	o	o	o
Greasing	o	o	o	o	o	o	o	o	o	o	o	o

Check items \ Running Hour	50	100	150	200	250	300	350	400	450	500	550	600
Greasing	○	○	○	○	○	○	○	○	○	○	○	○
Tightening handles		○		○		○		○		○		○
Tightening bolts	○	○		○		○		○		○		○
Cooling fan belt	○	○		○		○		○		○		○
Engine breathe pipe	○	○		○		○		○		○		○
Engine crankcase cleaning						○						○
Intake/exhaust gas valves												○
Fuel injection valve												○
Alternator	○	○				○				○		
Hydraulic system	○	○				○				○		

- Inspection should be done every 50 hours. If the tractor is not used much, inspect every year.
- Replace parts every two years regardless of running hours.
- Replace the steering wheel hose every two years.

OIL, GREASE, AND ANTI-FREEZE CHART

Item	Type
Fuel	Diesel (Summer : S Winter :W) <i>Note) Use winter diesel when temperature is below 50°F</i>
Engine oil	SAE 10W-40
Grease	Arctic Grease Below 14°F [-10°C] SAE (NLGI) #0, #1 32~ -22°F [0~ -30°C] SAE (NLGI) #2 32~122°F [0~50°C]
Coolant Anti - Freeze	ASTM D4985 Extended Lift antifreeze
Transmission / Hyd oil	Branson Origin Oil Texaco TDH oil, 1893
Front axle oil	SAE80W-90

FUEL, OIL, AND COOLANT CHART

Item	Capacity
Fuel	8.7 gal [33L]
Engine oil	1.4 gal [5.3L]
Coolant	1.58 gal [6L]
Transmission / Hyd oil	9.7 gal [37L]
Front axle	1.84 gal [7L]

Note) Above listed fuel, oil and coolant table is only for initial filling, and may be reduced at the time of replace.



CHECKING AND CHANGING OF OIL / FLUID

Do not dispose of waste oils in waterways or in sewage system, but take appropriate measures such as contacting waste oil disposal specialists.



DANGER

Never fill the fuel tank when the engine is running or hot.

[Otherwise]

There is a danger of fire.



CAUTION

Do not change oil just after stopping the engine.

[Otherwise]

There is a danger of getting burnt.





PERIODIC MAINTENANCE & ADJUSTMENT

1. ENGINE OIL

CHECKING OIL

Pull out the dipstick, clean the tip of dipstick, put it back into the engine, and pull it out again to see if the oil level is between the upper and lower limit. If the oil level is below the lower limit, add oil.

[Precaution]

Check the oil level before the engine is started or after the engine is cooled down.

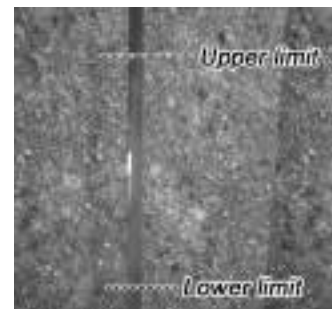
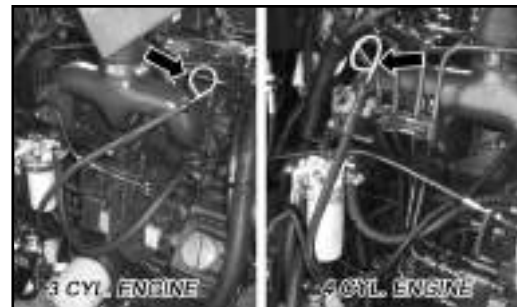



CHANGING OIL

Drain the oil by removing the plug under the engine. Put new oil through the engine oil filler hole. Change the oil periodically, and select the right type of oil depending on the temperature and usage.



CAUTION

Drain the oil when oil is warm but be careful. If oil is hot, there is a risk of getting burnt.



2. TRANSMISSION / HYD OIL

CHECKING OIL

Check the fluid level through the inspection window at the rear side of the transmission compartment.

The level should be 1/3 above in upper window. If the fluid level is below proper level, add fluid.

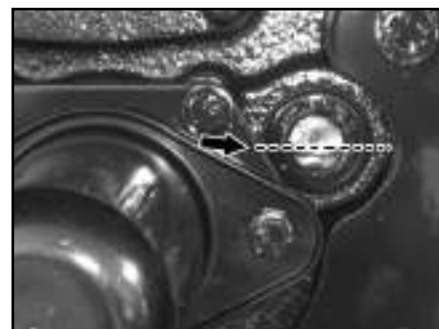



PERIODIC MAINTENANCE & ADJUSTMENT

CHANGING OIL

Drain the fluid through the drain holes under the rear axle case and rear axle housing. Supply the fluid through the filler hole behind the hydraulic case.

*Transmission oil can be used for the hydraulic system and for the power steering unit.

* Make sure to use the genuine Branson transmission fluid.



CAUTION

Drain the oil when oil is warm but be careful. If oil is hot, there is a risk of getting burnt.





3. FRONT AXLE OIL

CHECKING OIL

Open the fluid filler cap at the upper right side of the front axle, clean the tip of the gauge, dip the cap without screwing in, and take it out again to read the fluid level. Refill the fluid as necessary, and also check for leaks.





PERIODIC MAINTENANCE & ADJUSTMENT

CHANGING OIL

Drain the fluid through three drain holes under the front axle.

Refill the fluid from the upper right side of the front axle.





FILTERS / COOLANT REPLACEMENT

1. ENGINE OIL FILTER

Replace it every 300 hours or when engine oil is changed.

Note: First 50hr filter has to be changed.

Replacement

- (1) After draining the engine oil, turn the cartridge to the left with the filter wrench.
- (2) Apply a thin film of oil over the rubber ring on the bottom of the new cartridge and attach the new filter securely.
- (3) After changing the engine oil, start the engine and run it until the engine oil pressure warning lamp is turned off
- (4) After the oil pressure warning lamp is turned off, check the oil level again. Add oil as necessary.





PERIODIC MAINTENANCE & ADJUSTMENT

2. TRANSMISSION / HYD FLUID FILTER

The filter is a cartridge type,

[Note]: First 50hr, filter has to be changed.

Replacement

(1) After draining the transmission fluid, turn the cartridge to the left to take it out.

(2) Apply a thin film of fluid over the rubber ring on the bottom of the new cartridge and attach the new filter securely.

(3) After changing the transmission fluid, start the engine to circulate the fluid and then stop the engine. Check the fluid level at dipstick on left axle housing and add fluid as necessary.







3. FUEL FILTER

Cleaning and replacement of fuel filter element:

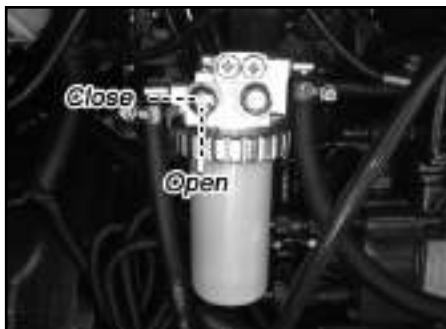
- (1) Put the fuel shut off valve to “C” (closed) position
- (2) Take out the filter and remove water and dust inside the filter.
- (3) After cleaning the filter, replace it and put the fuel shut off valve to “O” (Open) position. Remove the air.
- (4) Replace the filter element.



4. COOLANT

 DANGER	Do not open the radiator cap while the engine is running or right after the engine is stopped. Open the radiator cap only after the engine is stopped and fully cooled down.
---	--

[Otherwise]
Hot water will splash and may cause burn injury.





PERIODIC MAINTENANCE & ADJUSTMENT

CHECKING

Open the engine hood and see if the water level in the reservoir is between the upper and lower limit. Add clean water as necessary.



Replacement

- (1) Open the radiator cap and the drain plug to completely drain the water from the radiator.
- (2) Rinse the radiator with tap water until no dirt or rust comes out.
For better results, fill the radiator with water mixed with radiator flush, run the engine for over 15 minutes, and drain the water solution.
- (3) Replace the drain plug, add anti-freeze and fill the radiator with tap water.
- (4) Replace the radiator cap and run the engine to mix the anti-freeze and water.



[Handling of Anti-Freeze]

Anti-freeze has an effect of lowering the freezing point of water. This tractor is filled with international genuine anti-freeze when delivered from the factory. As the freezing point may differ depending on the mixture ratio, refer to the following table in very cold weather to ensure safety.

Anti-Freeze Mixture Ratio

Outdoor Temp (°F)	23	14	5	-4	-13	-22
Ratio (%)	82	73	66	61	55	49
Anti-Freeze (%)	18	27	34	39	45	51

[Precaution]

- When replacing the coolant, add anti-corrosive solution and run the engine for about five minutes to mix it with the water.
- For correct mixture ratio, refer to the manufacturer's instructions.
- When refilling the coolant, add only tap water.
- As anti-freeze expires in one year, replace the coolant every year.





OTHERS

1. RADIATOR SCREEN / AIR CLEANER

The Air cleaner removes the dust mixed in the intake air, thereby preventing abrasion of cylinder liners and piston rings to keep the engine in good condition. When working in dusty environments clean the air filter every 50 hours and replace it every 400 hours.

In normal working environments, clean the air filter every 100 hours and replace it every 1,000 hours. If the running hours are shorter, replace the element after one year.

Cleaning of Air Cleaner

Open the cover and take out the element. Blow air inside the element or shake it to take the dust off the element. Be careful to avoid damage to the pins.





Cleaning of radiator screen

Pull out the air cleaner fixing band for radiator disassembly. Pull up the radiator cleaner in the direction of arrow mark and unfold it upward and pull out upward.

Remove straw and dust. Clean it before and after work.



2. BATTERY

 DANGER	Avoid heat when checking or charging the battery.
--	---

[Otherwise]

The battery may explode and cause burns or other injury.

 CAUTION	When connecting the battery cable, connect the (+) terminal first. When disconnecting the cable, disconnect the (-) terminal first.
---	---

[Otherwise]

There is a risk of getting burnt due to shorting of the battery.

[Precaution]

- When replacing the battery, make sure to install the battery of the same capacity as designated.
- To preserve the environment and to recycle resources, do not discard the old battery but hand it over to the battery dealer for proper disposal.



3. ADJUSTING PARKING BRAKE

- 1) Unscrew fixing nuts of parking brake cable with parking brake released.
- 2) Tighten fixing nuts of parking brake cable and fix them at position where clearance amount is 0.8~ 1 in [20-25mm] from the end of parking brake lever.

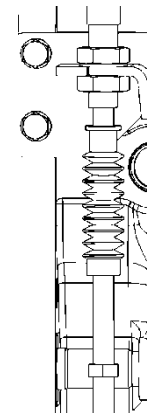
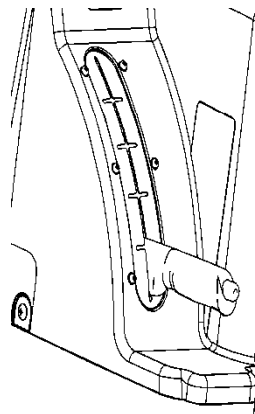



4. FUEL PIPES AND HOSES



DANGER

Inspect the condition of the fuel hoses and check for fuel leakage from any damaged parts of the hoses.

[Otherwise]

There is a risk of fire.

Check for damage to fuel hoses, steering wheel hoses (pipe), and radiator hoses, and see if there is any leakage or loose bolts.

Replace the pipes and hoses every two years even though they are not damaged

[Precaution]

- When replacing the fuel hose, drain air.





5. ELECTRICAL CABLES



DANGER

- Before starting to work everyday, check if any cable is in contact with other parts, or if any insulation is peeled off or damaged, or any contact is loosened.
- Before and after work, remove any straw or dust on the battery or cables.

[Otherwise]

There is a risk of fire due to short circuit.

Open the hood of the engine and check if any cable is in contact with other parts, or if any insulation is peeled off or damaged, or any contact is loosened.

Damaged cables must be repaired by an authorized dealer. Arrange for periodic maintenance for cables every 50 hours or once a year even though the cables are not damaged.





PERIODIC MAINTENANCE & ADJUSTMENT

6. GREASING

Apply grease every 50 hours. Check the relevant parts before starting work everyday and add grease as necessary. After working on wet areas, make sure to apply grease to the tractor.





7. STEERING WHEEL



WARNING

Check if the steering wheel vibrates severely or has no free play. Otherwise, there is a risk of accident.

When the steering wheel is turned lightly, there should be free play 0.8 ~ 2.0 in. If the extent of the free play exceeds this range, the steering wheel may feel heavy or the tractor may not move straight. If the free play is not normal, have it fixed at your nearest authorized dealer.

Free Play of 0.8~2.0 in.

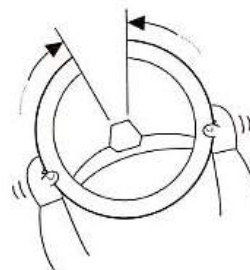



8. BRAKE



WARNING

- Check the brakes to avoid one-sided braking. Otherwise, there is a risk of accident.
- If the extent of free play is different between the two brake pedals, one-sided braking will occur. Make sure that the free play of both brake pedals is the same.

- In this case, the free play of the brake pedal is 0.2~0.4 in [5~10mm]
- Adjust both of the brake pedals

[How to adjust brake free play]

- 1) Remove dashboard
- 2) Loosen fixing nut.
- 3) Adjust stopper bolt so that the gap between bolt head and brake pedal arm is 0~0.02in [0~0.5mm].
- 4) Tighten the fixing nut.



9. FAN BELT



WARNING

Carry out inspection or maintenance after the engine if fully cooled down.

[Otherwise]

There is a risk of getting burnt.

After removing right side of dashboard, loosen fixing nut and adjust stopper bolt so that the gap between stopper bolt head and brake pedal arm is 0 ~ 0.02in [0~0.5mm] and tighten the fixing nut again.

Open the engine hood and press the middle of fan belt with finger to see if the belt sags about 0.4 ~ 0.6in [10 ~15mm] or if there is any damage to the belt. If the sagging is not correct, loosen the alternator bolt and move the alternator to adjust the tension of the fan belt. If the fan belt still slips after the alternator is moved to the maximum, replace the belt with a new one. New belts must be inspected after 50 hours of use.

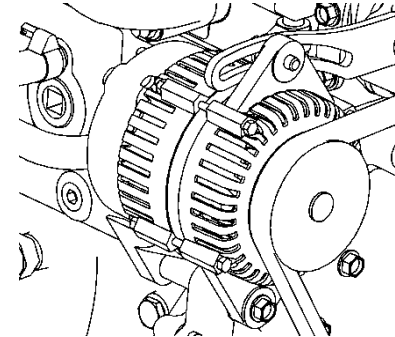



PERIODIC MAINTENANCE & ADJUSTMENT

10. AIR COMPRESSOR BELT



CAUTION

Carry out inspection or maintenance after the engine if fully cooled down.

[Otherwise]

There is a risk of getting burnt.

Check if belt is sagging for about 0.39~0.6in [10~15mm] or check for any damage to the belt by opening bonnet and engine side cover and pressing the middle of fan belt.

When it is not sagging enough, adjust tension by using adjusting bolt at the front of compressor.

Change the belt when tension cannot be adjusted even when the bolt is tightened as much as possible.





11. TOE-IN

Checking

If the toe-in is not properly aligned, the steering wheel may be uncontrollable or the tractor may produce an abnormal vibration. Measure the distance A and the distance B of the front wheels and see if the difference between the two measurements is 0.16 ~ 0.3 in[4-8mm].

Adjusting

If not, loosen nuts at the end of the cylinder rod on both sides and adjust the length of the screws. Tighten the nuts when the toe-in is 0.16 ~ 0.3 in[4-8mm].

- Left and right adjustment of screw length must be same.





12. FUSE AND FUSIBLE LINK



WARNING

When replacing the fuse, use only one of the same capacity.

Stop the engine and check the main fuse(fusible link).

Open the fuse box cover and check the fuses. Replace any burnt-out fuses with new ones of required capacity.

A fusible link is a type of fuse, which burns and disconnects the current in the event of excessive current flowing in the circuit , if plastic coating is discolored when it is cut off, it should be inspected by a authorized dealer.

If the fuse burns immediately after being replaced, it must be checked by the authorized dealer.





13. COLOR OF EXHAUST GAS

The exhaust gas may be a little black at the time of starting the engine, but normally its color is clear.

Black – incomplete combustion due to too much fuel intake.

White – misfiring or cold temperature.

Blue – burning of engine oil

If the color of the exhaust gas remains black or white during operation, have the tractor inspected at your nearest authorized dealer.





<MEMO>





TROUBLESHOOTING



TROUBLESHOOTING

- If the tractor is not working properly, stop the engine and carry out an inspection based on the following table.

ENGINE

Situation	Inspection item	Solution
The motor does not start when the main switch is turned to START.	Are you depressing the clutch?	Depress the clutch fully and turn the main switch to START
	Is the battery solution low? Is the battery discharged?	Fill the battery solution and fully charge the battery.
	Is the PTO ON/OFF switch is turned on?	Turn off PTO ON/OFF switch.
	Is the battery terminal loosened or corroded?	Clean and tighten the terminals. Apply grease to avoid rust
	Is the main fuse burnt out?	Replace the fuse
	Is the key switch broken?	Contact the dealer for repair or replacement.
	Is the starting motor defective?	Contact the dealer for repair or replacement.
The motor starts, but the engine does not start.	Is the fuel tank empty?	Fill up the fuel tank and drain the air.
	Is the fuel mixed with air?	Drain the air from the fuel.
	Does the engine run only when the reducer lever is pulled?	Charge the battery.



Situation	Inspection item	Solution
The engine revolution is irregular.	Is the air mixed in the fuel system?	Bleed the air in the fuel system and replace the fuel.
	Is the injection nozzle clogged?	Have the injection nozzle repaired or replaced
	Is the fuel filter clogged?	Have the fuel filter washed or replaced.
The engine is over heated	Is the coolant level low?	Refill the coolant.
	Is the fan belt loose or damaged?	Adjust or replace the fan belt.
	Is the radiator core clogged?	Clean the radiator core.
	Is the engine oil level low?	Refill the engine oil.
	Is the engine running under too much load?	Reduce the load.
The engine power is too weak.	Is the air cleaner clogged?	Inspect the air cleaner
	Is the nozzle stained with carbon?	Contact the dealer for repair
	Is the compression force weak?	
	Is the valve clearance adjusted properly?	
	Is the injection timing bad?	



TROUBLESHOOTING

Situation	Inspection item	Solution
Coolant warning lamp is on during operation.	Is the coolant level in the reservoir low?	Refill the coolant
Engine oil warning lamp is on during operation.	Is the engine oil level low?	Refill the engine oil
	Is the viscosity of the engine oil low?	Replace the engine oil with the one with proper viscosity.
	Is the pressure switch defective?	Replace the switch
	Is the oil pump defective?	Contact dealer for repair
The engine power is too weak.	Is the air cleaner clogged?	Inspect the air cleaner
Thermostat lamp is not turned on.	Is the fuse burnt out?	Replace the fuse
Battery warning lamp is on during operation.	Is the regulator (current limit) defective?	Contact dealer for repair
	Is the fan belt loose or damaged?	Adjust or replace the fan belt



CLUTCH & BRAKE

Situation	Inspection item	Solution
The clutch slips or cannot be disconnected	Is the extent of free play of the clutch pedal proper?	Adjust the free play of the pedal
The brake does not work or works on one side.	Is the extent of free play of the brake pedal proper?	Adjust the free play of the pedal
The brake pedal squeaks and does not return well	Is the brake pedal return spring damaged?	Replace the spring
	Is each part well greased?	Remove the rust and apply grease.



HYDRAULIC SYSTEM

Situation	Inspection item	Solution
The implement cannot be lifted	Is the hydraulic stop/slow return control dial in all the way right?	Turn the hydraulic stop/slow return control dial to left
	Is the transmission fluid level low?	Refill the transmission fluid.
	Is the air taken in the intake pipe system?	Tighten the filter case or connection parts. Replace the pipe or O-ring if damaged.
	Is the oil filter clogged?	Clean or replace it.
	Is the hydraulic pump defective?	Contact the dealer for repair.
	Is the control valve dusty or is the O-ring damaged?	Contact the dealer for repair.
The implement cannot be lowered.	Is the cylinder damaged?	Contact the dealer for repair.
	Is the hydraulic stop/slow return valve put to "Close"?	Put the hydraulic stop/slow return valve to "Open."
	Is the control valve dusty or clogged with foreign substance?	Consult the dealer for repair.
	Is the cylinder damaged?	Consult the dealer for repair.
	Is the position control lever on the shallowest position?	Move the position control lever to the releasing direction.



ELECTRICAL SYSTEM

Situation	Inspection item	Solution
The headlamp will not turn on.	Is the bulb burnt out?	Replace the bulb.
	Is the fuse burnt out?	Replace the fuse.
	Is the cable separated from the socket?	Inspect cable.
The direction indicator lamp will not operate.	Is the bulb burnt out?	Replace the bulb.
	Is the fuse burnt out?	Replace the fuse.
	Is the flasher unit defective?	Replace the flasher unit.
	Is the contact in bad condition?	Inspect and clean the grounding and terminals.
The lamps will not turn on.	Is the bulb burnt out?	Replace the bulb.
	Is the fuse burnt out?	Replace the fuse.
	Is the contact of the cable in bad condition?	Inspect the cable and secure the contact.
	Is the switch defective?	Replace the switch.
	Is the grounding in bad condition?	Connect the grounding cable securely to the body.
	Is the battery discharged?	Charge the battery.
The horn does not sound.	Is the fuse burnt out?	Replace the fuse.
	Is the horn switch contact in bad condition?	Inspect the horn switch.



TROUBLESHOOTING

<MEMO>





SPECIFICATIONS



SPECIFICATION

Specifications are subject to change without notice. Contact your local Branson dealer for more information.

Model			4520C	5220C
Drive System			4 Wheel Drive	
Dimensions	Overall Length	in [mm]	130.6 [3,316]	
	Overall Width	in [mm]	64~72 [1,625~1,828]	
	Overall Height	in [mm]	93 [2,361]	
	Wheel Base	in [mm]	70.9 [1,800]	
	Ground Clearance	in [mm]	13.1 [334]	
	Weight	lbs [kg]	4442 [2,015]	



Model		4520C	5220C	
Engine	Engine model	A2300N2-ATC	A2300T3-ATC	
	Type	Vertical, 4 Cycle, Water Cooled, Diesel, EPA TIER CERTIFIED		
	Combusion system	Swirl chamber		
	Aspiration	Naturally	Turbo Charged	
	Engine output	HP [kw]	47 [35]	55 [40.5]
	Engine RPM	RPM	2600	
	No of Cylinder		4	
	Bore x Stroke	In [mm]	3.46 x 3.7 [88 X 94]	
	Displacement	cu.in [cc]	139.5 [2286]	
	Type of air cleaner		Dry, Double Filter Elements	
Fuel tank Capacity	gal [L]	8.7 [33]		
Electronic	Alternator	Amps	70	
	Battery	Volt	12	
Steering		Hydrostatic		
Clutch		Dry, Single		



SPECIFICATION

Model		4520C	5220C
Brake		Wet Disc, Band Brake	
Transmission	Main shifting	Fully Synchronized (4 speed)	
	Forward / Reverse Method	Synchroshuttle	
	Gear Shifting (Front x Rear)	F12 X R12	
	Travel Speed	mph [km/h]	F : 1.14~14.8 [1.83~23.8] / R :1.09~14.2 [1.75~22.9]
PTO	Type	Independent P.T.O (6 Spline shaft)	
	Speed	RPM	540 / 760
Hydraulic System	Type	Position control	
	3 point hitch link	Telescopic lower link / Telescopic stabilizers	
	Category	Category I	
	Pump Flow @ 2500 rpm	Steering	5 GPM (7.2cc/rev)
Main		11.1 GPM (16cc/rev)	



<MEMO>





*Branson Machinery LLC
2100 Cedartown hwy Rome, GA, 30161
Tel: 877-734-2022 Fax : 877-734-0637
www.bransontractor.com
Dec, 2011*

