

# *T680 & T880*

## OPERATOR'S MANUAL





# Contents

---

**Safety**

1

**Emergency**

2

**Controls**

3

**Driving**

4

**Maintenance**

5

**Information**

6

**Index**

7

# Contents

---

## ©2013 Paccar Inc - All Rights Reserved

This manual illustrates and describes the operation of features or equipment which may be either standard or optional on this vehicle. This manual may also include a description of features and equipment which are no longer available or were not ordered on this vehicle. Please disregard any illustrations or descriptions relating to features or equipment which are not on this vehicle.

PACCAR reserves the right to discontinue, change specifications, or change the design of its vehicles at any time without notice and without incurring any obligation.

The information contained in this manual is proprietary to PACCAR. Reproduction, in whole or in part, by any means is strictly prohibited without prior written authorization from PACCAR Inc.





## INTRODUCTION

About the Manual . . . . .	1-3
Safety Alerts . . . . .	1-3
Vehicle Safety . . . . .	1-5
A Special Word About Repairs . . . . .	1-7
Additional Sources of Information . . . . .	1-8

## CAB AND FRAME ACCESS

Safety . . . . .	1-10
Door Lock and Keys. . . . .	1-11
Remote Keyless Entry (RKE). . . . .	1-12
Climbing onto the Deck Plate . . . . .	1-13

## GETTING TO YOUR ENGINE

Hood Hold Downs. . . . .	1-15
Hood Tilt. . . . .	1-16
Hood Hold-Open Device . . . . .	1-17

**SEATS AND RESTRAINTS**

Introduction . . . . . 1-19  
Safety Restraint Belts . . . . . 1-22  
Tether Belts . . . . . 1-25  
Komfort-Latch® Feature . . . . . 1-26  
During Pregnancy. . . . . 1-28  
Belt Damage and Repair. . . . . 1-28  
Sleeper Bunks and Restraints . . . . . 1-29  
Safety Restraint Tips . . . . . 1-31

**START-UP**

Introduction . . . . . 1-33  
Safe Vehicle Operation . . . . . 1-33  
Vehicle Loading. . . . . 1-34  
Emergency Equipment . . . . . 1-36  
Driver's Check List . . . . . 1-36



## INTRODUCTION

### About the Manual

Congratulations! Your selection of a Kenworth truck was a wise investment. Kenworth trucks are recognized as the industry standard for quality and reliability.

Please take the time to get acquainted with your vehicle by reading this Operator's Manual. We recommend that you read and understand this manual from beginning to end before you operate your truck. This manual explains the safe, efficient operation and maintenance of your Kenworth.



#### NOTE

After you've read this manual, it should be stored in the cab for convenient reference and remain with this truck when sold.

Your Kenworth may not have all the features or options mentioned in this manual. Therefore, you should pay careful attention to the instructions that pertain to just your vehicle. In addition, if your vehicle is equipped with special equipment or options not discussed in this manual, consult your dealer or the manufacturer of the equipment.

All information contained in this manual is based on the latest production information available at the time of publication. Kenworth Truck Company reserves the right to make changes at any time without notice.

### Safety Alerts

Please read and follow all of the safety alerts contained in this manual. They are there for your protection and information. These alerts can help you avoid injury to yourself, your passengers, and help prevent costly damage to the vehicle. Safety alerts are highlighted by safety alert symbols and signal words such as "WARNING", "CAUTION", or "NOTE". Please do not ignore any of these alerts.

# INTRODUCTION

1

## WARNING

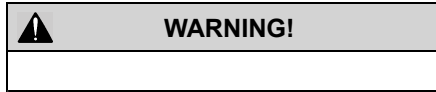

The safety message following this symbol and signal word provides a warning against operating procedures which could cause death or personal injury. They could also cause equipment or property damage. The alert will identify the hazard, how to avoid it, and the probable consequence of not avoiding the hazard.

### Example:

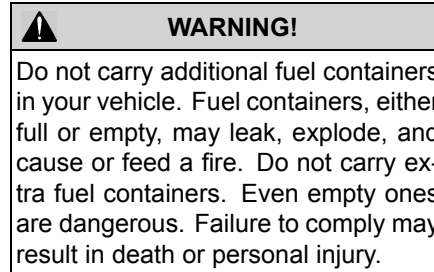

## CAUTION

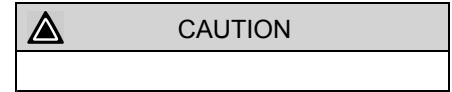

The safety alert following this symbol and signal word provides a caution against operating procedures which could cause equipment or property damage. The alert will identify the hazard, how to avoid it, and the probable consequence of not avoiding the hazard.

### Example:

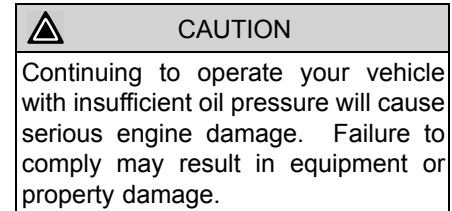

**NOTE**

	NOTE

The alert following this symbol and signal word provides important information that is not safety related but should be followed. The alert will highlight things that may not be obvious and is useful to your efficient operation of the vehicle.

**Example:**

	NOTE
Pumping the accelerator will not assist in starting the engine.	

**Vehicle Safety**

	<b>WARNING!</b>
Do not drink alcohol and drive. Your reflexes, perceptions, and judgment can be affected by even a small amount of alcohol. You could have a serious or even fatal accident, if you drive after drinking. Please do not drink and drive or ride with a driver who has been drinking. Failure to comply may result in death, personal injury, equipment or property damage.	

	<b>WARNING!</b>
Do not text and drive. Your reaction time, perceptions and judgment can be affected while texting or using any other form of mobile messaging while driving. Failure to comply may result in death, personal injury, equipment or property damage.	

Make sure your vehicle is in top working condition before heading

out on the road, it is the responsible driver's duty to do so. Inspect the vehicle according to the Driver's Check List beginning on page 1-36.

Every new vehicle is designed to conform to all Federal Motor Vehicle Safety Standards applicable at the time of manufacture. Even with these safety features, continued safe and reliable operation depends greatly upon regular vehicle maintenance. Follow the maintenance recommendations found in Preventive Maintenance on page 5-9. This will help preserve your investment.

Keep in mind that even a well maintained vehicle must be operated within the range of its mechanical capabilities and the limits of its load ratings. See the Weight Ratings label on the driver's door edge.

Safe driving is only possible with the proper concentration on the driving

# INTRODUCTION

---

1

task. Keep distraction to a minimum to improve your concentration. Examples of distractions may include radio controls, GPS navigation controls, cellular telephone calls, cellular text messages, reading or reaching for something on the floor. Minimizing your distractions will improve safe driving and will help avoid an accident involving death or personal injury.

Be aware of local regulations that may prohibit the use of cellular telephones while driving. In addition to being an unsafe practice, it may be against local or federal ordinances to use cellular devices while operating the vehicle.

This manual is not a training manual. It cannot tell you everything you need to know about driving your vehicle. For that you need a good training program or truck driving school. If you have not been trained, get the proper training before you drive. Only qualified drivers should drive this vehicle.

## California Proposition 65 Warning

- Diesel engine exhaust and some of its constituents are known to the State of California to cause cancer, birth defects, and other reproductive harm.
- Other chemicals in this vehicle are also known to the State of California to cause cancer, birth defects or other reproductive harm.
- Battery posts, terminals, and related accessories contain lead and lead compounds, chemicals known to the State of California to cause cancer and reproductive harm. Wash hands after handling.

## Data Recorder

California Vehicle Code - Section 9951- Disclosure of Recording Device

Your vehicle may be equipped with one or more recording devices commonly referred to as “event data recorders (EDR)” or “sensing and diagnostic modules (SDM)”. If you are involved in an accident, the device(s) may have the ability to record vehicle data that occurred just prior to and/or during the accident. For additional information on your rights associated with the use of this data, contact

- the California Department of Motor Vehicles - Licensing Operations Division  
– or –
- <http://www.dmv.ca.gov/>

**Environmental Protection**

 <b>WARNING!</b>
<p>Diesel engine exhaust and some of its constituents are known to the State of California to cause cancer, birth defects, and other reproductive harm. Other chemicals in this vehicle are also known to the State of California to cause cancer, birth defects or other reproductive harm. This warning requirement is mandated by California law (Proposition 65) and does not result from any change in the manner in which vehicles are manufactured.</p>

Some of the ingredients in engine oil, hydraulic oil, transmission and axle oil, engine coolant, diesel fuel, air conditioning refrigerant (R12, R134a, and PAG oil), batteries, etc., may contaminate the environment if spilled or not disposed of properly. Contact your local government agency

for information concerning proper disposal.

**A Special Word About Repairs**

 <b>WARNING!</b>
<p>Do not attempt repair work without sufficient training, service manuals, and the proper tools. You could be killed or injured, or you could make your vehicle unsafe. Do only those tasks you are fully qualified to do.</p>

Your dealer's service center is the best place to have your vehicle repaired. You can find dealers all over the country with the equipment and trained personnel to get you back on the road quickly—and keep you there.

Your vehicle is a complex machine. Anyone attempting repairs on it needs good mechanical training and the proper tools. If you are sure you have these requirements, then you can probably perform some repairs yourself. However, all warranty repairs

# INTRODUCTION

---

1

must be performed by an authorized service facility. If you aren't an experienced mechanic, or don't have the right equipment, please leave all repairs to an authorized service facility. They are the ones equipped to do the job safely and correctly.

**Maintenance Manuals.** If you do decide to do any complex repair work, you'll need the maintenance manuals. Order them from your authorized dealer. Please provide your Chassis Serial Number when you order, to be sure you get the correct manuals for your vehicle. Allow about four weeks for delivery. There will be a charge for these manuals.

**Final Chassis Bill of Material.** A complete, non-illustrated computer printout listing of the parts used to custom-build your vehicle is available through the dealer from whom you purchased your vehicle.

 <b>WARNING!</b>
Modifying your vehicle can make it unsafe. Some modifications can affect your vehicle's electrical system, stability, or other important functions. Before modifying your vehicle, check with your dealer to make sure it can be done safely. Improper modifications can cause death or personal injury.

## Additional Sources of Information

### Installed Equipment - Operator's Manuals

Major component suppliers also supply operation manuals specific to their products. Additional manuals and other pieces of literature are included in the glove box literature package. Look for information on products such as the engine, driver's seat, transmission, axles, wheels, tires, ABS/ESP (if applicable), radio, 5th wheel, lane departure and adaptive cruise control. If you are missing these pieces of literature, ask your Dealer for copies.

## Other Sources

Another place to learn more about trucking is from local truck driving schools. Contact one near you to learn about courses they offer.

Federal and state agencies such as the department of licensing also have information. The Interstate Commerce Commission can give you information about regulations governing transportation across state lines.

## CAB AND FRAME ACCESS

1

### CAB AND FRAME ACCESS

#### Safety



#### WARNING!

Always reinstall steps before entering the cab or accessing the deck plate. Without steps you could slip and fall. Failure to comply may result in death or personal injury.

Be careful whenever you get into or out of your vehicle's cab. Always maintain at least three points of contact with your hands on the grab handles and your feet on the steps.



#### WARNING!

Jumping out of the cab or getting into the cab without proper caution is dangerous. You could slip and fall, which could lead to death or personal injury. Keep steps clean. Clean any fuel, oil, or grease off of the steps before entering the cab. Use the steps and grab handles provided, and always keep at least three points of contact between your hands and feet and the truck. Always face toward the vehicle when entering or exiting the cab and look where you are going.

The following picture shows the best way to enter and exit a Conventional Cab.

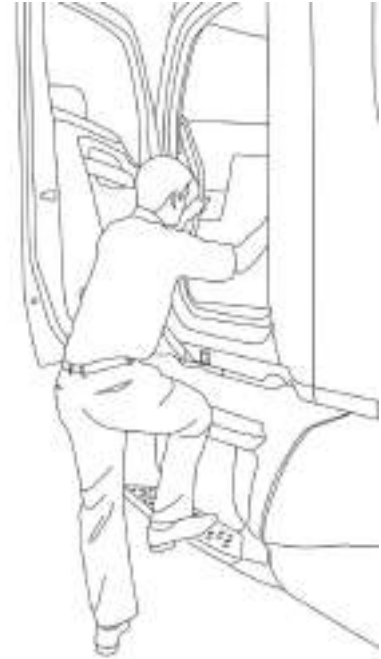



### Door Lock and Keys

#### Door Lock

Doors can be locked from the inside by using the lock button. Close the door then push the button down to lock. Doors automatically unlock when you open them from inside, and can be locked from the outside with the key or the optional remote keyless entry key fob.



#### **WARNING!**

To reduce the chance of death or personal injury, always lock the doors while driving. Along with using the lap shoulder belts properly, locking the doors helps prevent doors from inadvertently opening and occupants from being ejected from the vehicle.

To lock or unlock the doors from outside the cab, insert the key in the lock. Turn the key toward the rear to lock; forward to unlock.

#### Keys

The same key fits your ignition, doors, and sleeper luggage compartment.

Frame-mounted tool box locks and locking fuel tank caps each have individual keys.

## CAB AND FRAME ACCESS

1

### Remote Keyless Entry (RKE) (Optional)

This vehicle may be equipped with a Remote Keyless Entry (RKE) system that adds security and convenience to your vehicle. The system will lock or unlock the driver's door and passenger's door with the key fob and alert you with parking lights when the selected doors are locked or unlocked. The system includes two key fobs that provide secure rolling code technology that prevents someone from recording the entry signal.

i	NOTE
	FCC ID: L2C0031T IC: 3432A-0031T FCC ID: L2C0032R IC: 3432A-0032R This device complies with Part 15 of the FCC Rules and with RSS-210 of Industry Canada. Operation is subject to the following two conditions: (1) This device may not cause harmful interference, and (2) This device must accept any interference received, including interference that may cause undesired operation. Changes or modifications not expressly approved by the party responsible for compliance could void the user's authority to operate the equipment. The term "IC:" before the radio certification number only signifies that Industry Canada technical specifications were met.

#### Operation

##### To Unlock the Driver's Door

Press the UNLOCK button once. The driver's door will unlock and the parking lights will come on for 40 seconds.

##### To Unlock the Passenger's Door

Press the UNLOCK button once and press again within 5 seconds. The passenger door will unlock.

##### To Lock All Doors

Press the LOCK button. The doors will lock and the parking lights will come on for 2 seconds. If the doors are open they will not lock. The range of the RKE system should be approximately 30 ft. This will be reduced if it is operated close to other RF sources such as TV/radio transmitters and cell towers.

## Batteries

The key fob uses one CR2032, 3V battery. Batteries should last approximately three years, depending on use. Consistently reduced range is an indicator that the battery needs replacement. Batteries are available at most discount, hardware, and drug stores.

The battery can be accessed by removing the cover of the key fob. After a new battery is installed, the key fob must be synchronized with the vehicle.

## Synchronization

The key fob may need to be synchronized to the truck when the battery is replaced or when the key fob has not been used for an extended period of time.

### To Synchronize A Key Fob:

1. Hold the key fob near the receiver which is located behind the speedometer and tachometer.
2. Press and hold both the Lock and Unlock buttons at the same time for approximately 7 seconds.
3. When the key fob is resynchronized, the doors will lock then immediately unlock.
4. If the fob fails to synchronize, it could be programmed to a different truck or could have failed. Contact your dealer to re-program your key fob.

## Climbing onto the Deck Plate

 <b>WARNING!</b>
When you are climbing onto and off the deck plate, maintain at least three points of contact with your hands on the grab handles and your feet on the steps. Always face toward the vehicle when entering or exiting the cab and look where you are going. Failure to comply may result in death or personal injury.

 <b>WARNING!</b>
When stepping onto a surface to enter the cab or access the deck plate, only use the steps and grab handles installed and designed for that purpose. Failure to use the proper steps and grabhandles could cause a fall which may result in death or personal injury.

## CAB AND FRAME ACCESS

1



### WARNING!

Keep steps clean. Clean any fuel, oil, or grease off the steps before entering the cab or accessing the deck plate. Stepping on a slippery surface can cause a fall which may result in death or personal injury.



### WARNING!

Always reinstall steps before entering the cab or accessing the deck plate. Without steps you could slip and fall. Failure to comply may result in death or personal injury.



### NOTE

Any alteration (adding bulkheads, headache racks, tool boxes, etc.) behind the cab that affects the utilization of installed grab handles, deck plates, or frame access steps should comply with Federal Motor Carrier Safety Regulation 399.

The following pictures show you the right way to get on and off the area behind your cab.

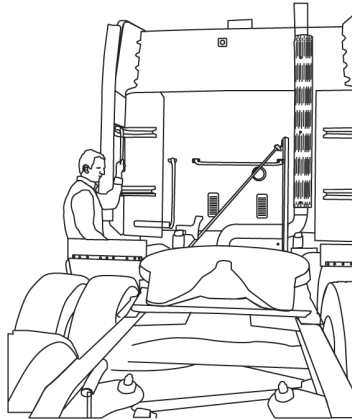

Hold handles as you step up.

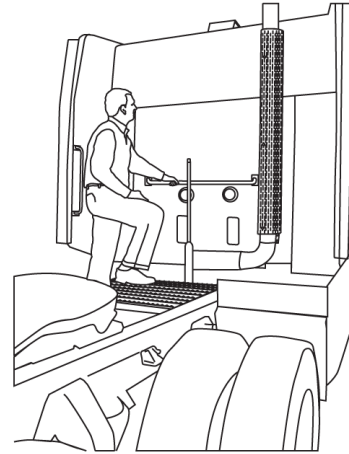

Maintain three points of contact.

# GETTING TO YOUR ENGINE

## Hood Hold Downs

Hood hold downs keep a hood from opening unexpectedly.



### CAUTION

A hood not latched securely could open during operation and cause vehicle damage. Be sure to latch the hood securely.



### 1. Hood Latch in the Closed Position

1

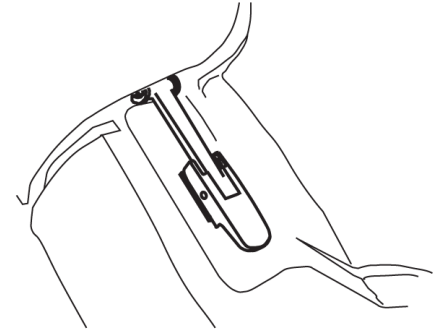

# GETTING TO YOUR ENGINE

1

## 2. Pull Latch to Open



## 3. Pull Up to Separate

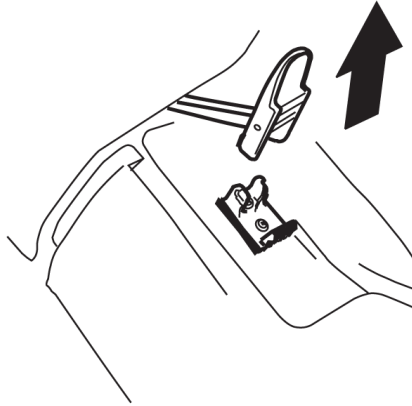

## Hood Tilt

To open your hood, unlock the hood hold downs by unlatching them. Put one or both hands on the top of the hood front. Tilt the hood forward by pulling at the top of the hood, pivoting on the foot placed on the bumper and using the foot on the ground for stability. Keep pulling on the hood until you are certain that the hood hold open device is engaged. When closing the hood, be sure that you maintain the same points of contact (top of hood and bumper) to control the movement of the hood as it closes.



### WARNING!

A pivoting hood could hurt someone or be damaged itself. Before opening or closing the hood, be sure there are no people or objects in the way. Failure to stand in a position of safety can cause death or personal injury.

### Hood Hold-Open Device

The hood is equipped with a hood hold-open device. In order for the hood hold-open device to become engaged, the vehicle hood must be fully open. Once the vehicle hood is fully open, the hold-open latch will automatically engage and will need to be disengaged by the operator.

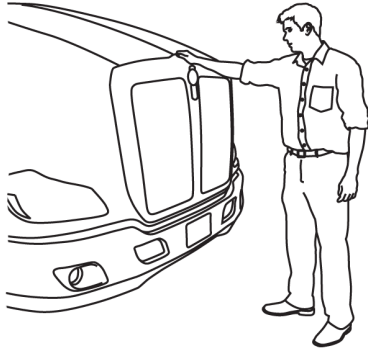

Pull with hand from here

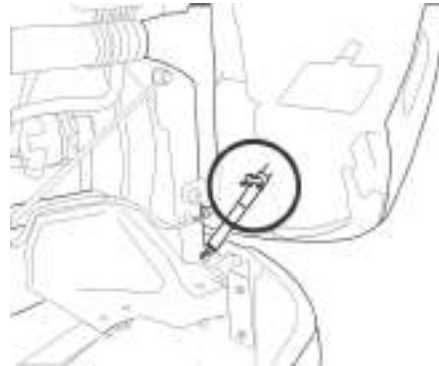

The release lever for the hood hold open device is located near the front hinge of the hood. Press the lever in to disengage the hood hold open device.

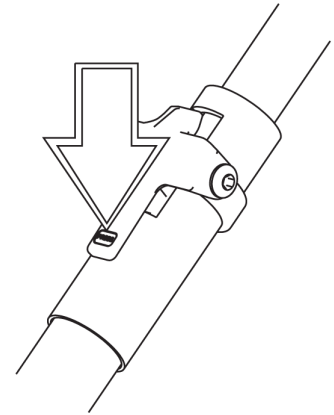

Press in to disengage

## GETTING TO YOUR ENGINE

---

1



### WARNING!

Before opening or closing the hood, make sure your footing is secure and stable. Failure to do so may cause the hood to close uncontrollably which may result in death or personal injury.



### WARNING!

Always ensure the hood hold-open latch is engaged to keep the hood fully open any time anyone gets under the hood for any reason. Failure to do so may cause the hood to close uncontrollably which may result in death or personal injury.



### WARNING!

Before closing the hood, be sure the area is clear—no people or objects are in the way. Failure to do so may result in death or personal injury.





## SEATS AND RESTRAINTS

### Introduction

This section covers the operation and safe use of your seats. For further information on features and adjustment of the seat, see the manufacturer's Service and Operation Manual included with the vehicle.

### Seat Adjustment

 <b>WARNING!</b>
Do not adjust the driver's seat while the vehicle is moving. The seat could move suddenly and unexpectedly and can cause the driver to lose control of the vehicle. Make all adjustments to the seat while the vehicle is stopped. After adjusting the seat and before driving off, always check to ensure that the seat is firmly latched in position. Failure to comply may result in death, personal injury or property damage.

 <b>WARNING!</b>
Before driving or riding in vehicle, ensure that there is adequate head clearance at maximum upward travel of seat. Injury may occur if head clearance is not adequate. Failure to comply may result in death or personal injury.

### Suggested Control Setting Order:

1. Seat fore/aft position
2. Seat height
3. Thigh support
4. Seat bottom angle
5. Seat back recline angle
6. Lumbar
7. Adjust steering wheel
8. Adjust mirrors

The suspension seat in this vehicle will have the following controls to adjust the seat to the operator's specific needs.

# SEATS AND RESTRAINTS

1



1. Seat heater/cooler
2. Seat thigh support up/down
3. Seat bottom angle adjustment

	<b>WARNING!</b>
Seat heaters should not be used if the operator or passenger has difficulty in sensing and reacting to an increased temperature of the seat. The heater function may result in personal injury.	

	<b>CAUTION</b>
Do not use the seat heater for more than 10 minutes at one time. Always turn off the seat heaters when they are not needed. Overuse of the seat heater may decrease the capacity of the vehicle's batteries and may result in poor starting and potential equipment damage.	



1. Seat fore/aft
  2. Express down
  3. Suspension stiffness
  4. Seat height up/down
  5. Lumbar and bolster\* controls
  6. Recline adjustment
  7. Armrest angle adjustment
- \*This is an optional feature and may vary depending on the vehicle.

**⚠ WARNING!**  
Do not drive or ride with your seat back in the reclined position. You could be injured by sliding under the seat belts in a collision. Failure to comply may result in death or personal injury.

Lumbar (and bolster support if available) are provided for superior support to the back during operation. Lower support is standard and the optional functions include upper lumbar and bolster functions. Pressing on the “+” symbol of the button will add support in the area. Pressing the opposite side of the button will release pressure and will reduce support in the area.



- 1. Lower and Upper\* lumbar adjustment
- 2. Bolster\* adjustment

\*This is an optional feature and may vary depending on the vehicle.



The seats in this vehicle are equipped with a switch that locks out the fore-aft isolator function in the seat. When locked, the seat will not move back and forth. It will be rigidly fixed and only allowed to move up and down with the vehicle's movements.

# SEATS AND RESTRAINTS

1

## Passenger Seat Swivel (Optional)

This vehicle may be equipped with a swivel function on the passenger seat. This function allows the passenger seat to rotate and face towards the inside of the cab.



### WARNING!

Always ensure that the passenger seat is locked into the forward-facing position when the vehicle is in motion. Locking the swivel seat into the forward facing position maximizes visibility to the surrounding area. Failure to comply creates a safety hazard that may result in death or personal injury.



### WARNING!

Do not use the swivel function while a passenger is in the seat and the vehicle is in motion. The seat belt will not provide proper protection if the passenger is not facing forward and the vehicle is in an accident. Failure to comply may result in death or personal injury.

## Safety Restraint Belts

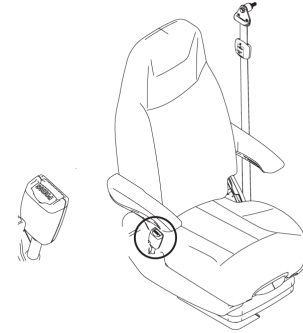

Safety belts have proven to be the single most effective means available for reducing the potential for either death or personal injury in motor vehicle accidents. Unbelted riders could be thrown into the windshield or other parts of the cab or could be thrown out of the cab. They could strike another person. Injuries can be

much worse when riders are unbelted. Always fasten your seat belt and be sure anyone riding with you does the same. Therefore, read the following instructions and always observe user warnings pertaining to safety belts.

above the speedometer/tachometer (see “Seat Belt, Fasten” on page 3-41).

## Lap/Shoulder Belt

The combination lap-shoulder belt is equipped with a locking mechanism. The system adjusts automatically to a person's size and movements as long as the pull on the belt is slow.

Hard braking or a collision locks the belt. The belt will also lock when driving up or down a steep hill or in a sharp curve.

### To fasten the belt:

1. Grasp the belt tongue.
2. Pull belt in a continuous slow motion across your chest and lap.
3. Insert belt tongue into buckle on inboard side of seat.
4. Push down until the tongue is securely locked with an audible click.

 <b>WARNING!</b>
Do not drive vehicle without your seat belt and your riders belts fastened. Riding without a safety belt properly fastened can lead to death or personal injury in an emergency.

 <b>WARNING!</b>
In vehicles equipped with passenger seat swivel function, the seat belts will only perform their intended function when the seat is facing forward. Failure to comply can lead to death or personal injury in an emergency.

Your vehicle is equipped with a seat belt indicator in the warning light display

## SEATS AND RESTRAINTS

---

1

5. Pull belt to check for proper fastening and adjustment, as follows:
  - Pull shoulder section to make sure belt fits snugly across the chest and pelvis.
  - There should be less than 1 inch (25 mm) gap between the body and the belt.
  - The shoulder belt must be positioned over the shoulder, it must never rest against the neck or be worn under the arm.
  - Make sure any slack is wound up on the retractor and that the belt is not twisted.

### **To unfasten the belt:**

1. Push in the release button on the buckle.
2. The belt will spring out of the buckle.

If the belt is locked, lean the body back to remove any tension in the belt. After releasing the belt, allow the belt to retract completely by guiding the belt tongue until the belt comes to a stop.

## Safety Restraint Belts

### Lap Belt

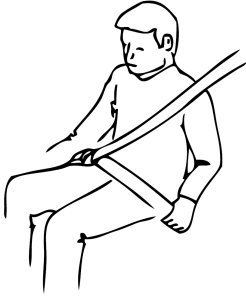

Correct



Incorrect (too high on hips)



Correct (over arm)

### Shoulder Belt



Incorrect (under arm)



Incorrect (twisted)

 <b>WARNING!</b>
<p>Proper seat belt adjustment and use is important to maximize occupant safety. Failure to wear or adjust the safety belt properly may result in death or personal injury.</p>

## Tether Belts

This vehicle may have an external tether belt installed with a seat, instead of the internal tethering device. Tether belts are designed to restrain the seat in the event of a sudden stop or an accident.

Internal tether belts do not require adjustment.

# SEATS AND RESTRAINTS

1



## WARNING!

Do not remove, modify, or replace the tether belt system with a different tether system. A failed or missing tether belt could allow the seat base to fully extend in the event of an accident. Failure to comply may result in death or personal injury.



## WARNING!

Failure to adjust tether belts properly can cause excessive movement of the seat in an accident. Tether belts should be adjusted so that they are taut when the seat is in its most upward and forward position. Failure to comply may result in death or personal injury.

### To adjust an external tether belt:

- Make sure that the tether belt is attached to the cab floor and seat frame. It should be routed through the buckle on each side.
- Often the attachments are made using a split-type hook. Make sure both halves of the hook are around the anchor bracket.
- To lengthen the tether, turn the buckle to a right angle to the webbing. Then pull the buckle. To shorten the tether, pull on the strap.

### Komfort-Latch® Feature

Your vehicle includes a feature designed to eliminate cinching and provide improved safety and comfort. Cinching is the condition where a belt becomes continually tighter around you during a rough, bouncy ride. The need for this feature increases with rough road conditions, particularly over long distances.

To eliminate cinching, simply activate the Komfort-Latch feature located on the seat belt webbing at the appropriate time:

1. Adjust the seat to its proper driving position.
2. Latch the seat belt.
3. If available, adjust the seat belt height adjuster to a comfortable driving position.



4. While seated appropriately, push the "on" button to engage the Komfort Latch.
5. Lean forward in the seat until you hear a "click."
6. Return to normal driving position, and the Komfort Latch maintains the preset amount of tension relief.

To disengage the mechanism:

1. Unbuckle the seat belt
2. Press the "OFF" button of the Komfort Latch or tug on the shoulder strap.

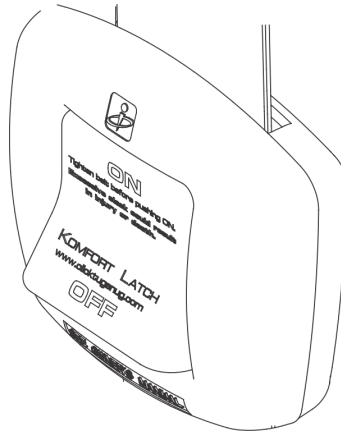

Komfort-Latch®

More information and video tutorials can be found at:  
<http://www.clicktugsnug.com/> .



### WARNING!

Do not set the Komfort Latch with too much slack. Too much slack may reduce the effectiveness of the seat belt. Failure to comply may result in death or personal injury.

## SEATS AND RESTRAINTS

---

1

### During Pregnancy

Pregnant women should always wear combination lap/shoulder belts. The lap belt portion must be worn snugly and as low as possible across the pelvis. To avoid pressure on the abdomen, the belt must never pass over the waist. A properly worn seat belt may significantly reduce the risks to woman and baby in the event of a crash.



Pregnant Woman with Belt Properly Worn

### Belt Damage and Repair

Damaged belts in the cab must be replaced. Belts that have been stretched, cut, or worn out may not protect you in an accident.

If any seat belt is not working properly, see an Authorized Service Center for repair or replacement.

For further information on seat belts and seat belt maintenance, see Safety Restraint System - Inspection on page 5-68.

## Sleeper Bunks and Restraints

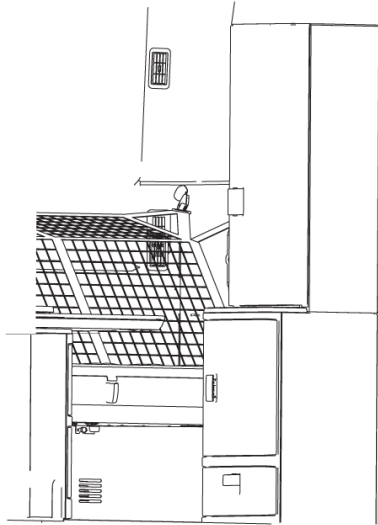

For cabs equipped with a sleeper, be sure to use the restraint devices when the vehicle is in motion. Your vehicle

may have belts and/or a net restraint system which are over the bunk or cover the opening.

If your vehicle has an upper and lower bunk, the upper bunk can be folded up out of the way to provide you with more room in the sleeper. Fold the upper bunk up and insert the metal end of the bunk retaining belts into the buckles.

	<b>WARNING!</b>
<p>Be sure the restraint system is used when anyone is occupying the sleeper while the vehicle is moving. In an accident, an unrestrained person lying in a sleeper bunk could be seriously injured. He or she could be thrown from the bunk. Failure to comply may result in death, personal injury, equipment or property damage.</p>	

### Lower

	<b>WARNING!</b>
<p>Always keep the lower bunk in its down position while the vehicle is moving. If left in the up position, stored items could become loose during an accident and strike you, causing death or personal injury.</p>	

Before you move the vehicle, check to be sure the lower bunk is in the down position.

# SEATS AND RESTRAINTS

1

## Upper

 <b>WARNING!</b>
Be sure the latch that holds the upper bunk in the folded position is working properly so the bunk will not fall down. Pull on the bunk to be sure it is latched securely. If the bunk falls, you could be injured. Failure to comply may result in death, personal injury, equipment or property damage.

Per FMCSR 392.60 - Unauthorized Persons Not to be Transported. Federal law prohibits the transportation of persons in commercial vehicles unless they are specifically authorized in writing by the motor carrier. See the cited FMCSR for a complete description of the regulation and exemptions.

 <b>WARNING!</b>
Any loose items on the upper or lower bunk should be moved to a secured place before driving the vehicle. Failure to comply may result in death, personal injury, equipment or property damage.

## Upper Rear Sleeper Storage

Your vehicle may be equipped with an upper storage shelf that extends over the lower bunk and across the rear of the sleeper. The following warning applies:

 <b>WARNING!</b>
Overhead compartments are not intended for items exceeding their designed weight limits. Exceeding the weight limits may cause the shelf to collapse and or items may fall out in a sudden stop which may lead to death or personal injury.

Compartments in the cab and sleeper are provided for storage of necessary items used during operation. The storage areas above the door are designed to hold a combined total not exceeding 14 lbs (6 kg) per compartment and the other overhead compartments (including those in

the optional sleeper) should hold a combined total not exceeding 5 lbs (2.2 kg) per compartment.

### Safety Restraint Tips

- Do not wear a belt over rigid or breakable objects in or on your clothing, such as eye glasses, pens, keys, etc., as these may cause injury in an accident.
- Any authorized person sleeping in your vehicle while it is moving should use the bunk restraint.
- Any authorized person sitting in the sleeper area on the sofa bed (if equipped) while it is moving should wear a seat belt.
- A responsible operator sees to it that everyone in the vehicle rides or sleeps safely. The operator is responsible to inform any passengers or co-drivers how to properly use the seat belts and bunk restraint in the vehicle.
- Do not strap in more than one person with each belt.
- Keep seat belt and bunk restraint buckles free of any obstruction that may prevent secure locking.
- Damaged or worn belts in the cab or sleeper, subjected to excessive stretch forces from normal wear, must be replaced. They may not protect you if you have an accident.
- Any belts or restraints that have been subjected to an accident should be inspected for any loose (attaching) hardware or damaged buckles.
- If belts show damage to any part of assembly, such as webbing, bindings, buckles or retractors, they must be replaced.
- Do not allow safety belts (seat or bunk) to become damaged by getting caught in door, bunk or seat hardware, or rubbing against sharp objects.

## SEATS AND RESTRAINTS

---

1

- All belts must be kept clean or the retractors may not work properly.
- Never bleach or dye seat or bunk restraint belts: chemicals can weaken them. Do, however, keep them clean by following the care label on the belts. Let them dry completely before allowing them to retract or be stowed away.
- Make sure the seat belts and bunk restraint of the unoccupied passenger seat or bunk is fully wound up on its retractor or is stowed, so that the belt or restraint tongue is in its properly stowed position. This reduces the possibility of the tongue becoming a striking object in case of a sudden stop.
- Do not modify or disassemble the seat belts or bunk restraint in your vehicle. They will not be available to keep you and your passengers safe.
- If any seat belt or bunk restraint is not working properly, see an authorized dealer for repair or replacement.

## START-UP

### Introduction

The following section covers start-up procedures for getting your vehicle ready for the road.

### Safe Vehicle Operation

For your safety, as well as those around you, be a responsible driver:

- If you drink alcohol, do not drive.
- Do not drive if you are tired, ill, or under emotional stress.

Safe driving is only possible with the proper concentration on the driving task. Keep distraction to a minimum to improve your concentration. Examples of distractions may include radio controls, GPS navigation controls, cellular telephone calls, cellular text messages, reading or reaching for something on the floor. Minimizing your distractions will improve safe driving and will help avoid an accident involving death or personal injury.

Be aware of local regulations that may prohibit the use of cellular telephones while driving. In addition to being an unsafe practice, it may be against local

or federal ordinances to use cellular devices while operating the vehicle.

Much has gone into the manufacturing of your vehicle including advanced engineering techniques, rigid quality control, and demanding inspections. These manufacturing processes will be enhanced by you, the safe driver, who observes the following:

- Knows and understands how to operate the vehicle and all its controls.
- Maintains the vehicle properly.
- Uses driving skills wisely.

For more information, refer to Department of Transportation Regulation 392.7, which states that interstate commercial motor vehicles are not to be driven unless the driver is sure that certain parts and accessories are in working order.

 <b>WARNING!</b>
The use of alcohol, drugs, and certain medications will seriously impair perception, reactions, and driving ability. These circumstances can substantially increase the risk of an accident. Failure to comply may result in death, personal injury, equipment or property damage.

Do not drink alcohol and drive. Your reflexes, perceptions, and judgment can be affected by even a small amount of alcohol. You could have a serious or even fatal accident, if you drive after drinking. Please do not drink and drive or ride with a driver who has been drinking.

 <b>WARNING!</b>
Do not text and drive. Your reaction time, perceptions and judgment can be affected while texting or using any other form of mobile messaging while driving. Failure to comply may result in death, personal injury, equipment or property damage.

## Vehicle Loading

Compare your vehicle's load capacity with the total load you are carrying. If adjustments need to be made, make them, do not drive an overloaded vehicle. If you are overloaded or your load has shifted, your vehicle may be unsafe to drive.

 <b>WARNING!</b>
Do not exceed the specified load rating. Overloading can result in loss of vehicle control, either by causing component failures or by affecting vehicle handling. Exceeding load ratings can also shorten the service life of the vehicle. Failure to comply may result in death or personal injury.

The gross vehicle weight rating (GVWR), or the maximum front and rear gross axle weight ratings (GAWRs) are determined by the components installed from the factory



on to the vehicle and their designed specifications. (Axle weight ratings are listed on the driver's door edge.)

The following are some definitions of weight you should know:

**GVWR:** is the Gross Vehicle Weight Rating. This is the **MAXIMUM WEIGHT** your vehicle is allowed to carry, including the weight of the empty vehicle, loading platform, occupants, fuel, and any load. Never exceed the GVWR of your vehicle.

**GCW:** is the actual combined weight, or Gross Combination Weight (GCW), of your vehicle and its load: vehicle, plus trailer(s), plus cargo.

**GAWR:** is the Gross Axle Weight Rating. This is the total weight that one axle is designed to transmit to the ground. You will find this number listed on the driver's door edge.

**Load Distribution:** be sure any load you carry is distributed so that no axle has to support more than its GAWR.

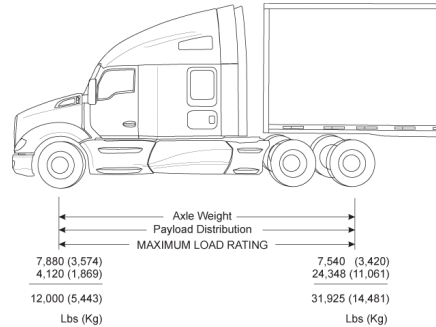

**WARNING!**

An unevenly distributed load or a load too heavy over one axle can affect the braking and handling of your vehicle, which could result in an accident. Even if your load is under the legal limits, be sure it is distributed evenly. Failure to comply may result in death, personal injury, equipment or property damage.

### Emergency Equipment

It is good practice to carry an emergency equipment kit in your vehicle. One day, if you have a roadside emergency, you will be glad the following items are with you:

- window scraper
- snow brush
- container or bag of sand or salt
- emergency light
- warning triangles
- small shovel
- first aid kit
- fire extinguisher
- vehicle recovery hitches (see Vehicle Recovery Guidelines on page 2-12 for details).

### Driver's Check List

To keep your vehicle in top shape and maintain a high level of safety for you, your passengers, and your load, make a thorough inspection every day before you drive. You will save maintenance time later, and the safety checks could help prevent a serious accident. Please remember, too, that Federal Motor Carrier Safety Regulation 392.7 requires a pre-trip inspection and so do commercial trucking companies.

You are not expected to become a professional mechanic. The purpose of your inspections is to find anything that might interfere with the safe and efficient transportation of yourself, any passengers, and your load. If you do find something wrong and cannot fix it yourself, have an authorized dealer or qualified mechanic repair your vehicle right away.

The following operations are to be performed by the driver. Performing these checks and following the maintenance procedures in this manual will help keep your vehicle running properly.

**Approaching Your Vehicle**

- Check the overall appearance and condition. Are windows, mirrors, and lights clean and unobstructed?
- Check beneath the vehicle. Are there signs of fuel, oil, or water leaks?
- Check for damaged, loose, or missing parts. Are there parts showing signs of excessive wear or lack of lubrication? Have a qualified mechanic examine any questionable items and repair them without delay.
- Check your load. Is it secured properly?

**Daily Checks**

**Engine Compartment Checks - Daily**

1. Engine Fluid Levels - add more if necessary.
  - a. Engine oil
  - b. Coolant (check while engine is cold)
  - c. Power steering fluid level
2. Engine Belt - check tension and condition of belts.
  - a. See Accessory Drive Belts on page 5-97 for further information on checking belt tension.

	<b>NOTE</b>
Deflection should be one belt thickness for each foot distance between the pulley centers.	

- b. Replace belts that are cracked torn or broken.
3. Fuel Filter/Water Separator Draining - check and drain. Depending on the fuel storage facility, more frequent draining may be required.
4. Windshield washer reservoir fluid level - fill if necessary.
5. Battery Cables - check the condition of the battery and alternator cables for signs of chafing or rubbing. Make sure that all clamps (straps) holding the cables are present and in good working order.
6. Hood closed before entering cab. Is it latched properly?
7. Check brake lines and hoses.
8. Check the steering components (pitman arm, draglink, power steering hoses, etc.).

# START-UP

1

9. Check clutch hydraulic fluid.

## Chassis and Cab Checks - Daily

Before entering the cab and operating the vehicle, check the following equipment for proper maintenance:

1. Lights - are any exterior lights cracked or damaged?  
Perform an exterior light test using the dash mounted switch next to the steering wheel. See Exterior Lighting Self-Test on page 3-64.
2. Windows and Mirrors - are they clean and adjusted properly?
3. Tires and Wheels - are they inflated properly? Are all wheel cap nuts in place and torqued properly - tighten if necessary. Check front wheel bearing oil levels. Inspect all tires and wheels for damage - correct if found.
4. Suspension - check for loose or missing fasteners. Check damage

to springs or other suspension parts such as cracks, gouges, distortions, bulges or chafing.

5. Brake Components - check lines, linkages, chambers, parking and service brake operation.
6. Air System - are there leaks?  
Air Tanks - drain water from all air tanks. Make sure the drain cocks are closed. This procedure is also required for air suspension tanks equipped with automatic drain valves.  
For further details See Using the Brake System on page 4-21.
7. Steps and Handholds - check for worn surfaces and loose or missing fasteners (which includes any fuel tank steps).
8. Fluid Tanks (Fuel, DEF, etc.) - check underneath the vehicle for signs of fluid leaks. If any are found, correct before operating the vehicle.

9. Fuel Tank Hardware - is the tank fill cap secure? Are the tank straps tight? Is the strap webbing in place?



### WARNING!

Diesel fuel in the presence of an ignition source (such as a cigarette) could cause an explosion. Do not remove a fuel tank cap near an open flame. Use only the fuel and/or additives recommended for your engine. A mixture of gasoline or alcohol with diesel fuel increases this risk of explosion. Failure to comply may result in death, personal injury, equipment or property damage. See Refueling on page 4-60, for more information.

10. Trailer Connections - are they secure and the lines clear? If they are not being used, are they stored properly?

- a. Is the trailer spare wheel secure and inflated?
  - b. Is the landing gear up and the handle secured?
11. Check the fifth wheel. Is the kingpin locked?
- a. Is the sliding fifth wheel locked?

**Cab Interior - Daily**

- 1. Seat - adjust the seat for easy reach of controls and visibility.
- 2. Seat Belts - fasten and adjust safety restraint belts (which may include restraints in the sleeper).
- 3. Steering Column - adjust for easy reach and visibility.
- 4. Mirrors - check and readjust mirrors if necessary.
- 5. Lights - turn ignition key to the ON position and check for warning lights and buzzer. Check operation

- of turn signals and emergency lights.
- 6. Instruments - check all instruments.
- 7. Windshield - check operation of windshield wipers and washers.
- 8. Horn - check operation of horn.
- 9. Fuel - check fuel. Is there enough fuel?
- 10. Diesel Exhaust Fluid (DEF) - check level. Is there enough fluid?
- 11. Sleeper Air Conditioning Air Filter - check the condition of the sleeper air conditioning air filter. Keep the sleeper floor area behind the passenger front seat clear of debris and pet hair. The sleeper air conditioner draws air from this area and excessive dirt or pet hair may shorten the service life of the sleeper air conditioning air filter.

The above items should be checked daily, as a minimum. They are in addition to, not in place of, Federal Motor Carrier Safety Regulations. These regulations may be purchased by writing to:

Superintendent of Documents

U.S. Government Printing Office

Washington, DC 20402

# START-UP

---

## 1

### Weekly Operations

1. Battery - check battery and terminals.
2. Wheel Cap Nuts - are they all in place and torqued properly - tighten if necessary. See Wheel Cap Nut Torque on page 5-142.
3. Other Controls and Wiring - check for condition and adjustment
4. Steering Components - check pitman arm, draglink, and power steering hoses, etc., for loose, broken, or missing parts.
5. HVAC Fresh Air Filter - check for condition and cleanliness.
6. Other Engine Compartment Checks:
  - a. Check condition and fastening of engine belt, hoses, clamps, and radiator.
  - b. Check the air cleaner, muffler, and exhaust pipes. Are they tight and secure?
  - c. For vocational vehicles with optional engine air pre-cleaner, check the purge valve at the bottom of the hood mounted engine air precleaner for any obstructions. Make sure the purge valve will open and close as needed to purge dirt and water from the engine intake air.
  - d. Automatic Transmission Fluid (when applicable) - Check level, after the engine has warmed up to operating temperature.

**WHAT TO DO IF...**

You Need Roadside Assistance . . . . . 2-3  
Low Air Alarm Turns On . . . . . 2-3  
Stop Engine Lamp Turns On . . . . . 2-4  
Engine Oil Pressure Lamp Turns On. . . . . 2-4  
Engine is Overheating . . . . . 2-5  
Fuse or Relay Blows . . . . . 2-6

**JUMP STARTING VEHICLES**

Introduction . . . . . 2-8

**VEHICLE RECOVERY AND SPRING BRAKES**

Vehicle Recovery Guidelines . . . . . 2-12  
Returning Vehicle to Service . . . . . 2-20  
Spring Brakes—Manual Release . . . . . 2-20  
Sand, Mud, Snow and Ice . . . . . 2-22  
Towing the Vehicle . . . . . 2-23





## WHAT TO DO IF...

### You Need Roadside Assistance



Call toll-FREE 1-800-KW-ASSIST (1-800-592-7747) to talk to someone at the PACCAR Customer Center.

- Open 24-7-365 days a year
- They can help you get roadside assistance.
- They have a custom mapping system which locates Kenworth Dealers and Independent Service Providers (ISPs) near you and lists types of services offered, hours of operation and contact information.
- They can assist with jump and pull starts, tires, trailers, fines and

permits, chains, towing, hazardous clean-up, out of fuel (roadside), mechanical repairs and preventive maintenance services.

- They have bilingual agents and access to a translation service to ensure quality assistance for customers who speak any language.
- They can't answer your warranty questions but can get you in contact with a Kenworth dealer who can.
- The PACCAR Customer Center service is FREE even if you don't drive a Kenworth.

### Low Air Alarm Turns On



1. Slow down carefully.
2. Move a safe distance off the road and stop.
3. Place the transmission in neutral (park with automatic transmissions, if equipped) and set the parking brake. (Refer to Parking Brake Valve on page 4-23 and Operating the Transmission on page 4-19, for transmission shifting and parking brake information.)
4. Turn OFF the engine.
5. Turn ON the emergency flasher and use other warning devices to alert other motorists.

 <b>WARNING!</b>	
If the air pressure falls below 60 psi (414 kPa) the spring brakes may stop the vehicle abruptly, which could cause an accident resulting in death or personal injury. Observe the red warning lamps on the gauges. If one comes on, do not continue to drive the vehicle until it has been properly repaired or serviced.	

If the light and alarm do not turn off at startup, do not try to drive the vehicle until the problem is found and fixed. (Refer to Using the Brake System on page 4-21, for more brake information.)

### Stop Engine Lamp Turns On



**Stop Engine Lamp** - If the Stop Engine warning lamp illuminates, it means you have a serious engine system problem.

 <b>WARNING!</b>	
This should be considered an emergency. You should stop the vehicle as safely as possible and turn OFF the ignition. The vehicle must be serviced and the problem corrected before driving again. Failure to do so may cause severe engine or DPF damage, or cause an accident which may result in death or personal injury.	

### Engine Oil Pressure Lamp Turns On



**Engine Oil Pressure Lamp** - If the oil pressure suddenly drops, or the audible alarm and engine oil pressure warning light come on while driving, do the following:

1. Slow down carefully.
2. Move a safe distance off the road and stop.
3. Place the transmission in park and set the parking brake. (See Parking Brake Valve on page 4-23 and Operating the Transmission on page 4-19, for transmission shifting and parking brake information.)
4. Turn OFF the engine.
5. Turn ON the emergency flasher and use other warning devices to alert other motorists.

6. Wait a few minutes to allow oil to drain into the engine oil pan, and then check the oil level. (See Oil Level Check on page 5-94, for details on checking oil level.)
7. Add oil if necessary. If the problem persists, contact an authorized dealer as soon as possible.

	<b>CAUTION</b>
Continuing to operate your vehicle with insufficient oil pressure may cause severe engine damage or cause an accident which may result in equipment or property damage.	

It is important to maintain oil pressure within acceptable limits. If oil pressure drops below the minimum psi (kPa) a Red Warning Lamp on the oil pressure gauge will illuminate and the Stop Engine Lamp will come ON.

## Engine is Overheating

The cooling system may overheat if the coolant level is below normal or if there is sudden loss of coolant, such as a split hose. The system may also temporarily overheat during severe operating conditions such as:

- Climbing a long hill on a hot day
- Stopping after high-speed driving

If either one of the above occurs, **DO NOT TURN OFF THE ENGINE** unless:

- a)** the Low Water warning device indicates a loss of coolant, **b)** the Red Warning lamp (on the gauge) and Check Engine lamp comes ON, **c)** the Buzzer sounds showing an overheat condition, or **d)** if you have any other reason to suspect the engine may be overheating - follow these steps.
1. Reduce engine speed and stop. When stopped, place the transmission in Neutral and set the

parking brake. (See Parking Brake Valve on page 4-23 and Putting the Vehicle in Motion on page 4-16, for transmission shifting and parking brake information.) Keep the engine running.

2. Check to ensure the Oil Pressure Gauge reads normal. (See Engine Oil Pressure Gauge on page 3-11, for further information.)
3. Make sure the engine fan is turning by switching the Engine Fan Switch from AUTO to MAN (Manual).
4. Increase the engine speed to about one-half of full operating speed, or 1,100 to 1,200 rpm, maximum.
5. Return the engine speed to normal idle after 2 or 3 minutes.
6. Monitor the engine temperature. After the temperature returns to normal, allow the engine to idle

## WHAT TO DO IF...

2

- 3 to 5 minutes before shutting it off. This allows the engine to cool gradually and uniformly.
7. If overheating came from severe operating conditions, the temperature should have cooled by this time. If it has not, stop the engine and let it cool before checking to see if the coolant is low.

For further information on engine temperature and operating engines properly, see the Engine Operation and Maintenance Manual and Starting and Operating the Vehicle on page 4-5. Check the coolant level after each trip when the engine has cooled. The coolant level should be visible within the surge tank—add coolant if necessary. See Topping Off in Engine Cooling System on page 5-72, for instructions on checking and filling the coolant expansion tank.

 <b>WARNING!</b>
To reduce the chance of death, personal injury and/or vehicle damage from overheated engines, which can result in a fire, never leave the engine idling without an alert driver present. If the engine should overheat, as indicated by the engine coolant temperature light, immediate action is required to correct the condition. Continued unattended operation of the engine, even for a short time, may result in serious engine damage or a fire.

 <b>WARNING!</b>
Do not remove the radiator fill cap while the engine is hot. Scalding steam and fluid under pressure may escape. You could be badly burned. Failure to comply may result in death or personal injury.

## Fuse or Relay Blows

Fuses are located behind the drivers side kick panel, below the ignition switch, and accessible by a door panel. See Power Distribution Box on page 5-84.

The vehicle main power relays are located in the engine compartment. See Power Distribution Center (PDC) on page 5-81.

 <b>WARNING!</b>
Do not replace a fuse with a fuse of a higher rating. Doing so may damage the electrical system and cause a fire. Failure to comply may result in death, personal injury, equipment or property damage.

**CAUTION**

Before replacing a fuse, turn OFF all lights and accessories and remove the ignition key to avoid damaging the electrical system.

**CAUTION**

Never patch fuses with tin foil or wire. This may cause serious damage elsewhere in the electrical circuit, and it may cause a fire.

**CAUTION**

If a circuit keeps blowing fuses, have the electrical system inspected for a short circuit or overload by an authorized dealer as soon as possible. Failure to do so could cause serious damage to the electrical system and/or vehicle.

### Fuse Inspection and Replacement

All the electrical circuits have fuses to protect them from a short circuit or overload. If something electrical on your chassis stops working, the first thing you should check for is a blown fuse.

1. Turn OFF all lights and accessories and remove the ignition key to avoid damaging the electrical system.
2. Determine from the chart on the fuse panel which fuse controls that component.
3. Remove that fuse and see if it is blown.



1 Blown

If it is blown, replace it with a fuse of the same rating.

If a fuse of the same rating is not available, a fuse of a lower rating may be temporarily substituted. You can also use a fuse from a circuit you can do temporarily without (for example an accessory circuit or radio).

**CAUTION**

When replacing a failed circuit breaker, always use an approved circuit breaker with a current rating equal to or less than the circuit breaker being replaced. Only use the approved Type II modified reset circuit breakers. NEVER use a Type I (automatic reset) or Type III (manual reset) circuit breaker. A fuse with a current rating equal to or less than the circuit breaker being replaced can also be used.

# JUMP STARTING VEHICLES

## JUMP STARTING VEHICLES

2

### Introduction

Jump starting a vehicle is not a recommended practice due to the various battery installations and electrical options.

However, if your battery is discharged (dead), you may be able to start it by using energy from a good battery in another vehicle. This is termed jump starting. Be sure to follow the precautions and instructions below.

 <b>WARNING!</b>
Batteries contain acid that can burn and gasses that can explode. Ignoring safety procedures may result in death, personal injury, equipment or property damage.

 <b>WARNING!</b>
Never jump start a battery near fire, flames, or electrical sparks. Batteries generate explosive gases that could explode. Keep sparks, flame, and lighted cigarettes away from batteries. Failure to comply may result in death, personal injury, equipment or property damage.

 <b>WARNING!</b>
Never remove or tamper with battery caps. Ignoring this could allow battery acid to contact eyes, skin, fabrics, or painted surfaces. Failure to comply may result in death, personal injury, equipment or property damage.

Be careful that metal tools (or any metal in contact with the positive terminal) do not contact the positive battery terminal and any other metal on the vehicle at the same time. Remove

metal jewelry and avoid leaning over the battery.

## To Jump Start your Vehicle

 <b>WARNING!</b>
When jump starting using a battery booster, it is best to jump start with an equivalently powered vehicle. Verify that the booster battery has the same volt and CCA specifications as the dead battery before attempting to jump start. Failure to comply may cause an explosion resulting in death, personal injury, equipment or property damage.

 <b>CAUTION</b>
Applying a higher voltage booster battery may cause expensive damage to sensitive electronic components, such as relays, Electronic Control units or electronics in general. Failure to comply may result in equipment damage.

 <b>CAUTION</b>
Improper hook-up of jumper cables or not following these procedures can damage the alternator or cause serious damage to both vehicles.

 <b>WARNING!</b>
Heed all warnings and instructions of the jumper cable manufacturer. Failure to comply may result in death, personal injury, equipment or property damage.

## Preparing the vehicles:

1. Remove any personal jewelry that may come in contact with the battery terminals.
2. Select a jumper cable that is long enough to attach to both vehicles in a way that ensures neither vehicle touches each other.
3. Position the two vehicles together, but do not allow them to touch.
4. Turn OFF all lights, heater, radio, and any other accessory on both vehicles.
5. Set the parking brakes: pull out the Yellow button located on the dash.
6. Shift the transmission into park position or neutral for manual transmissions. (See Operating the Transmission on page 4-19 and Parking Brake Valve on page 4-23, for transmission shifting and parking brake information.)

## JUMP STARTING VEHICLES

---

2

7. If either vehicle is equipped with battery disconnects ensure they are in the **"OFF"** position prior to connecting the two vehicles.

### Connect the batteries:

1. Attach one end of a jumper cable to the **positive (+)** terminal of the discharged (dead) battery. This will have a large **red +** or **P** on the battery case, post, or clamp.
2. Attach the other end of the same cable to the **positive (+)** terminal of the good (booster) battery.
3. Attach the remaining jumper cable **FIRST** to the **negative (-)** terminal (**black or N**) of the good battery.
4. Attach the other end of the negative cable to a bare metal part not bolted to the engine block.

	NOTE
<b>Always connect positive (+) to positive (+) and negative (-) to negative (-).</b>	

5. If either vehicle is equipped with battery disconnects, ensure that they are in the **"ON"** position.

6. Start the vehicle that has the good battery first. Let it run for 5 minutes.
7. Start the vehicle that has the discharged (dead) battery.

If the engine fails to start, do not continue to crank the starter but contact the nearest authorized dealer.



### Remove jumper cables:



#### **WARNING!**

When disconnecting jumper cables, make sure they do not get caught in any moving parts in the engine compartment. Failure to comply may result in death, personal injury, equipment or property damage.

Reverse the above procedure exactly when removing the jumper cables. With engine running, disconnect jumper cables from both vehicles in the exact reverse order, making sure to first remove the negative cable from the vehicle with the discharged battery.

### VEHICLE RECOVERY AND SPRING BRAKES

2

#### Vehicle Recovery Guidelines

Your vehicle is equipped with removable Recovery Hitches, designed for short distance recovery purposes only. Use only the provided hitches, according the following instructions. When using this connection, do not transport your vehicle over long distances. (If your vehicle does not have the proper hitches, contact your dealer.)

All lubricating and clutch application oil pressure is provided by an engine-driven pump, which will not work when the engine is stopped. You could seriously damage your vehicle by towing it with the driveline connected and the drive wheels on the ground. Worse, when vehicles are towed, either by wrecker or piggyback,

the lubricant in the top front of the drive axle will drain to the rear. This will leave the top components dry. The resulting friction may damage them. Always remove the main drive axle shafts before towing your vehicle.



#### CAUTION

Remove the drive axle shafts or lift the driving wheels off the ground before towing the vehicle. Towing the vehicle with either the wheels on the ground or the axle shafts in the axles will cause damage to the axle gears.



#### CAUTION

If your vehicle has a Meritor axle with a driver-controlled main differential lock, install the caging bolt before removing the axles for towing, see Driver Controlled Main Differential Lock on page 2-16. Installing the caging bolt prevents damage by locking internal axle components in position.



#### CAUTION

Connect only to the Recovery Hitches, see Vehicle Recovery Guidelines on page 2-12. Connections to other structural parts could damage the vehicle. Do not attach to bumpers or brackets. Use only equipment designed for this purpose. Failure to comply may result in equipment damage.

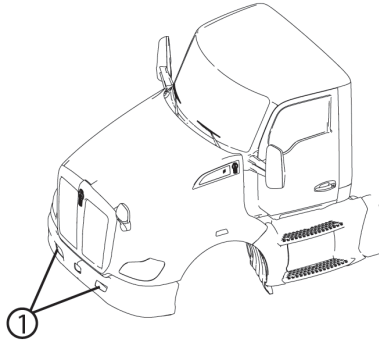

1 Recovery Hitch Sockets

### Recovery Procedure

1. Review and understand all the cautions and warnings of this section, see Vehicle Recovery Guidelines on page 2-12.
2. Install the recovery hitches, see Recovery Hitch Installation on page 2-15.
3. Disconnect the drive axle shafts and cover the open hubs. This is necessary because if the transmission is driven by the driveshaft (rear wheels on the ground), no lubricant will reach the gears and bearings, causing damage to the transmission.
4. Install the recovery rigging using a safety chain system, see Recovery Rigging on page 2-19.
5. Make sure the recovered vehicle's parking brakes are released.
6. If you desire to use the recovered vehicle's brakes, ensure that

the vehicle's air system is connected to that of the recovery vehicle. Ensure that any air line that has been removed from a driver-controlled main differential lock is firmly capped to prevent loss of air pressure from the recovery vehicle if it is supplying air pressure.

If you don't desire to use the recovered vehicle's brakes, ensure that you cage the spring brakes before attempting to move the vehicle, see Driver Controlled Main Differential Lock on page 2-16.

	<b>WARNING!</b>
<p>Before towing a vehicle, test your air brakes to ensure that you have properly connected and inspected the recovery vehicle's brake system. Failure to do so could lead to a loss of vehicle control which may result in an accident involving death or personal injury.</p>	

## VEHICLE RECOVERY AND SPRING BRAKES

2

7. Follow state/provincial and local laws that apply to vehicles in tow.
8. Do not tow vehicles at speeds in excess of 55 mph (90 km/h).

For additional information concerning heavy duty truck recovery, refer to the following Technology & Maintenance Council (TMC) literature.

- Recommended Practice #602–A — “Front Towing Devices For Trucks and Tractors.”
- Recommended Practice #602–B — “Recovery Attachment Points For Trucks, Tractors, and Combination Vehicles.”
- Recommended Practice #626 — “Heavy Duty Truck Towing Procedures.”

Copies of these can be obtained from the following address:

Technology & Maintenance Council  
950 N. Glebe Road  
(703) 838-1763  
Arlington, VA 22203  
Email: [tmc@trucking.org](mailto:tmc@trucking.org)  
<http://tmc.truckline.com>

### Recovery Hitch Connection

Specially designed hitches are required to recover your vehicle. The recovery hitches attach to the frame, see Recovery Hitch Assembly on page 2-15.

Two hitch assemblies, made up of the following parts, are recommended for the proper recovery of your vehicle: see Recovery Hitch Assembly on page 2-15.



#### WARNING!

Do not use parts from other trucks or materials from other sources to repair a hitch or to replace a missing hitch. The parts provided for recovery are made of high strength steel specifically designed for vehicle recovery. Failure to use the correct factory equipment may result in an accident involving death or personal injury.

If your vehicle is not equipped with the proper recovery hitch assembly, contact an authorized dealer to obtain the proper equipment.

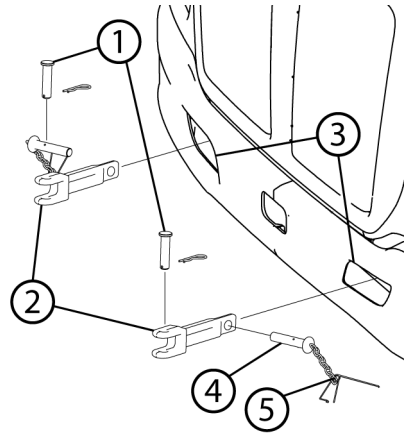

### Recovery Hitch Assembly

- 1 Tow Pin
- 2 Tow Hitch
- 3 Square Hitch Socket
- 4 Lock Pin
- 5 Lock Tab

### Recovery Hitch Installation

Use the following procedure to install the Vehicle Recovery Hitches. See Recovery Hitch Assembly illustration for part identification.

1. Check square sockets behind lower bumper for obstructions, clear if necessary.
2. With lock pins removed, insert hitches through bumper and into the square hitch socket.
3. Align the hole in the tow hitch with the square hitch socket hole.
4. Insert the lock pin into the square hitch socket hole and through the hole in the tow hitch until the lock tab is within the square hitch socket.
5. Rotate the lock pin 90 degrees to secure the pin in place.
6. Remove the hitches and store all parts after recovering the vehicle.

## VEHICLE RECOVERY AND SPRING BRAKES

### Driver Controlled Main Differential

Follow these steps to lock a driver-controlled main differential.

2



#### WARNING!

An open air line on the recovered vehicle will cause a leak in the air system of the recovery vehicle if both vehicles' brake systems are connected. This could cause a loss of system air, which can cause the service brakes not to function, resulting in the sudden application of the spring brakes causing wheel lock-up, loss of control, or overtake by following vehicles. You could be in an accident involving death or personal injury. Ensure that any air line that has been removed from a driver-controlled main differential lock is firmly capped to prevent loss of air pressure from the recovery vehicle if it is supplying air pressure.

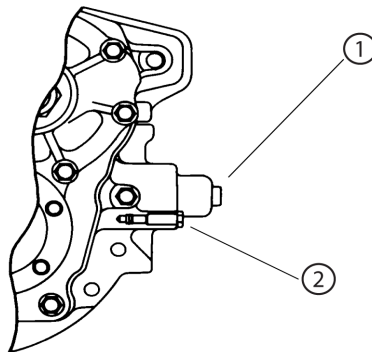

#### Driver Controlled Main Differential Lock

1. Air Line (remove to install Caging Bolt)
  2. Caging Bolt (in storage location)
1. Lift driving wheels off the ground or remove the driveline and axle shafts before towing the vehicle.



#### CAUTION

Failure to lift the driving wheels off the ground or remove the driveline and axle shafts before towing the vehicle could seriously damage your vehicle. All lubricating and clutch application oil pressure is provided by an engine-driven pump, which does not work when the engine is stopped. When vehicles are towed either by wrecker or piggyback, lubricant in the top front of the drive axle will drain to the rear. This will leave the top components dry, resulting in friction that will seriously damage these components.

2. Cover open hubs when removing drive axle shafts.

 <b>CAUTION</b>
Water, dirt and other material can enter an open hub or axle. This can contaminate the axle fluid and cause possible damage to components. Ensure that the hubs are covered with plastic whenever a drive axle shaft is removed.

3. For vehicles with driver-controlled main differential lock, install the caging bolt before removing the axle shafts for towing.
  - a. Remove the air line and firmly cap.
  - b. Remove the caging bolt from its storage hole.
  - c. Screw the caging bolt into the air line hole. When fully engaged, a 0.25 - 0.5 in. (6.35-12.7 mm) space will remain between the air cylinder and the bolt head.

This action will lock the differential by pushing a piston into a "lock" position.

 <b>CAUTION</b>
Failure to install the caging bolt when towing vehicles with driver-control main differential lock can result in damage by failing to lock internal components in position.

 <b>WARNING!</b>
Ensure there are no open air lines on the recovered vehicle if the recovery vehicle and recovered vehicle brake systems are connected. An open air line on the recovered vehicle will cause a leak in the air brake system of the recovery vehicle possibly causing death, personal injury, equipment or property damage.

 <b>CAUTION</b>
A recovered vehicle will have no operational brake system. Additionally, the rear axle spring brakes will probably be applied. <ul style="list-style-type: none"><li>• If you desire to use the recovered vehicle's brakes, ensure that the vehicles air system is connected to that of the recovery vehicle. Also ensure that any air line that has been removed from a driver-controlled main differential lock is firmly capped to prevent loss of air pressure from the recovery vehicle.</li><li>• If you don't desire to use the recovered vehicle's brakes, ensure that you cage the spring brakes before attempting to move the vehicle.</li></ul>

4. Install recovery hitches and rigging.

## VEHICLE RECOVERY AND SPRING BRAKES

2



### CAUTION

Connect recovery rigging only to hitches intended for that purpose. Do not attach to bumpers or brackets. Connections to other structural parts could damage the vehicle.

### Recovery Hitch Capacities

The maximum rated loads for vehicle recovery varies depending on the direction or angle of pull. These capacities are listed in the table below and are for the two hitches working together, simultaneously.

#### Hitch Capacities

DIRECTION OF PULL	MAXIMUM CAPACITY (Lb) *
Directly Forward	80,000
Directly Vertical or Horizontally to the Side	14,600
45° in any Direction	20,000
* Both hitches pulled simultaneously.	



### CAUTION

Recovery pull maximums assume the tow rigging evenly distributes the load between both recovery hitches. See examples in Recovery Rigging on page 2-19 for details. Serious damage to the vehicle may occur if rigging is not connected properly.



### CAUTION

When recovering ditched or bogged vehicles, stay well below Maximum Capacities. Even at loads below maximum, the physical strain of recovering a vehicle could damage axles, suspensions, fifth wheels, etc.



## VEHICLE RECOVERY AND SPRING BRAKES

### Recovery Rigging

To connect to the vehicle, follow the suggested rigging methods below.

- Use a double chain or cable setup that distributes the load equally to both hitches. See 1 or 2 in Recovery Rigging illustration.

- Never loop a single chain or cable through both hitches (3).
- Use a spreader or equalizer bar to distribute the load on both hitches (1).
- If no spreader bar is available, connect the main tow chain or

cable no closer than 6 ft. from the vehicle (2).

2

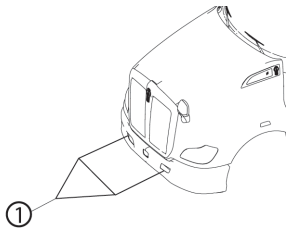

1. Spreader Bar or Equalizer  
**Preferred**

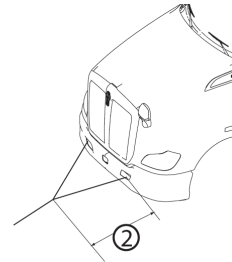

2. Minimum 6 FT.  
**Acceptable**

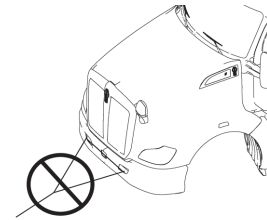

3. **NEVER USE SINGLE CHAIN OR CABLE  
LOOPED THROUGH TOW DEVICES**

## VEHICLE RECOVERY AND SPRING BRAKES

2

### Returning Vehicle to Service

You will have to add lubricant to prevent damage after your vehicle has been towed.

1. Into the pinion cage, add 1 pint (.47 liter) of lubricant or into the interaxle differential, add 2 pints (.94 liter) of approved lubricant.
2. After adding the specified type and amount of lubricant, drive the vehicle. It should be unloaded. Drive 1 to 2 miles (1.5 to 3 km) at a speed lower than 25 mph (40 km/h). This will thoroughly circulate the lubricant through the assembly.

### Spring Brakes—Manual Release

Recovering a vehicle requires that you release the parking brakes. There may be times when there is not enough air pressure to release the parking brakes. In such cases, the parking brakes (or Spring Brakes) can be manually released.



#### WARNING!

Do not drive vehicle with malfunctioning brakes. If one of the brake circuits should become inoperative, braking distances will increase substantially and handling characteristics while braking will be affected. You could lose control of your vehicle or cause an accident. Have it towed to the nearest dealer or qualified repair facility for repair. Failure to comply may result in death, personal injury, equipment or property damage.



#### WARNING!

Do not disassemble a spring brake chamber. These chambers contain a powerful spring that is compressed. Sudden release of this spring may result in death or personal injury.



#### WARNING!

Do not operate a vehicle when the spring brakes have been manually released. Driving a vehicle after its spring brakes are manually released is extremely dangerous. The brakes may not function. Failure to comply may result in death, personal injury, equipment or property damage.



## WARNING!

Always secure the vehicle with wheel chocks, chains, or other safe means to prevent rolling before manually releasing the spring brakes. Releasing the spring brakes on an unsecured vehicle could lead to an accident. The vehicle could roll, which may result in death, personal injury, equipment or property damage.

To move a vehicle immobilized by the spring brakes due to loss of air pressure in the brake system, perform the following procedure:

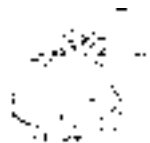

1. Remove the cap from the spring chamber.



2. Remove the release stud assembly from the side pocket, and remove the release nut and washer from the release stud.

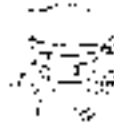

3. Slide out the release stud.

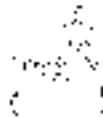

4. Insert the release stud through the opening in the spring chamber where the cap was removed. Insert it into the pressure plate. Turn the release stud 1/4 turn clockwise in the pressure plate. This secures the cross pin into the cross pin area of the pressure plate and locks it into the manual release position.



5. Assemble the release stud washer and nut on the release stud.



6. With a wrench, turn the release stud assembly nut until the compression spring is 90-95 percent caged. While doing this, check to make sure the push rod (adapter push rod or service push rod) is retracting. Do not over-torque the release stud assembly. (S-Cam type maximum: 50 lb-ft, Wedge type maximum: 30 lb-ft). The spring brake is now mechanically released.

## VEHICLE RECOVERY AND SPRING BRAKES

2

### Sand, Mud, Snow and Ice

If the vehicle gets stuck in sand, mud, snow, or ice:

- Move the gearshift lever or selector from First to Reverse.
- Apply light pressure on the accelerator pedal while the transmission is in gear.
- Remove your foot from the accelerator while shifting.
- Do not race the engine.
- For best traction and safety, avoid spinning the wheels.

 <b>WARNING!</b>
Do not spin the wheels faster than 35 mph (55 km/h). Spinning a tire at speedometer readings faster than 35 mph (55 km/h) can be dangerous. Tires can explode from spinning too fast. Under some conditions, a tire may be spinning at a speed twice that shown on the speedometer. Any resulting tire explosion could cause death or personal injury to a bystander or passenger, as well as extensive vehicle damage: including tire, transmission and/or rear axle malfunction.

**Comply with the following instructions to avoid transmission damage:**

- Always start vehicle in motion with the shift lever in first gear.
- Be sure that transmission is fully engaged in gear before releasing the clutch pedal (manual only).

- Do not shift into reverse while the vehicle is moving.
- If the vehicle needs to be recovered from being stuck, do not permit the vehicle to be towed for long distances without removing the driveshaft.

### Tire Chains

If you need tire chains, install them on both sides of the driving axle.

 <b>CAUTION</b>
Chains on the tires of only one tandem axle can damage the driveline U-joints and the interaxle differential. Repairs could be costly and time-consuming. Failure to comply may result in equipment damage.

## Towing the Vehicle

Towing the vehicle should be done by either an authorized dealer or a commercial vehicle towing service. The dealer or commercial towing service will have the necessary equipment to safely tow the vehicle and should be able to make arrangements to limit any damage to the vehicle. The towing service and the dealer should be aware of towing regulations and safety precautions.

The towing service will ensure that the following precautions are taken:

- Use of a safety chain system.
- Abide by all local towing regulations.
- Ensure that the towing device does not contact any surfaces that could be damaged while in transit.

- If towing from the front, ensure that the rear axles are prepared for towing.
- If towing from the rear, ensure that all body components such as roof, side and chassis fairings are secured properly to avoid damage while in transit.

	<b>WARNING!</b>
Secure the roof, side and chassis fairings while towing from the rear. An unsecured fairing may come off of the vehicle during transit. Failure to secure the fairings while towing may cause an injury accident resulting in death or personal injury.	



**INSTRUMENT PANEL**

Getting to know your Instrument Panel . . . . . 3-5  
Instrument Cluster . . . . . 3-7  
Instrument Cluster Description . . . . . 3-8  
Driver Performance Center . . . . . 3-14  
Driver Performance Center Description . . . . . 3-15  
How to Navigate the Functions in the Driver  
Performance Center . . . . . 3-19

**WARNING SYMBOLS**

Guide to the Warning Symbols . . . . . 3-29  
Description of Warning Symbols . . . . . 3-37

**OPTIONAL GAUGES**

Introduction . . . . . 3-43  
Axle, Pusher Air Pressure . . . . . 3-43  
Axle, Tag Air Pressure . . . . . 3-43  
Fuel Filter Restriction Pressure . . . . . 3-44  
Air Filter Restriction Indicator or Gauge . . . . . 3-44

Engine, Oil Pressure . . . . .	3-45
Engine, Oil Temperature . . . . .	3-45
Manifold Pressure Gauge . . . . .	3-45
Fuel Pressure Gauge . . . . .	3-46
Transmission Temperature Gauge. . . . .	3-46
Drive Axle Temperature Gauge (Forward and Rear)	3-46
Suspension Load Air Pressure, #1, #2 . . . . .	3-47
Tractor Brake Application Air Pressure. . . . .	3-47
Trailer Brake Application Air Pressure . . . . .	3-48
Trailer Air Tank Air Pressure . . . . .	3-48
Transfer Case Oil Temperature . . . . .	3-48
Transmission Oil Temperature, Auxiliary . . . . .	3-49
Transmission Retarder Oil Temperature . . . . .	3-49

## SWITCHES

Dash Switches . . . . .	3-50
Steering Column Controls . . . . .	3-67
Steering Wheel Controls (Optional) . . . . .	3-73
Door Mounted Controls . . . . .	3-75



Exterior Lights Self Test . . . . . 3-77

**HEATING AND AIR CONDITIONING**

Cab Controls . . . . . 3-79  
Introduction . . . . . 3-80  
Manual Control Mode . . . . . 3-82  
Automatic Control Mode . . . . . 3-83  
MAX Defrost Mode . . . . . 3-84  
Buttons and Dials . . . . . 3-85  
Operating Tips . . . . . 3-86  
Sleeper Heater - A/C Controls (optional) . . . . . 3-89

**ACCESSORIES**

Sleeper Alarm Clock . . . . . 3-91  
Radio (Option) . . . . . 3-94  
Cigarette Lighter and Ashtray (Option) . . . . . 3-94  
Cab Storage . . . . . 3-95  
Ignition Key Switch . . . . . 3-96  
Vehicle Telematic System . . . . . 3-97  
Passenger Side 'down' Mirror . . . . . 3-99



## **INSTRUMENT PANEL**

### **Getting to know your Instrument Panel**

This part explains the location of the various features on your vehicle and describes their function. For information on using these features in driving, see the paragraphs that follow. Please remember that each vehicle is custom-made. Your instrument panel may not look exactly like the one in the pictures that follow. We have tried to describe the most common features and controls available. You can pick out the parts that apply to you and read them to be fully informed on how your particular vehicle operates.

## INSTRUMENT PANEL

3

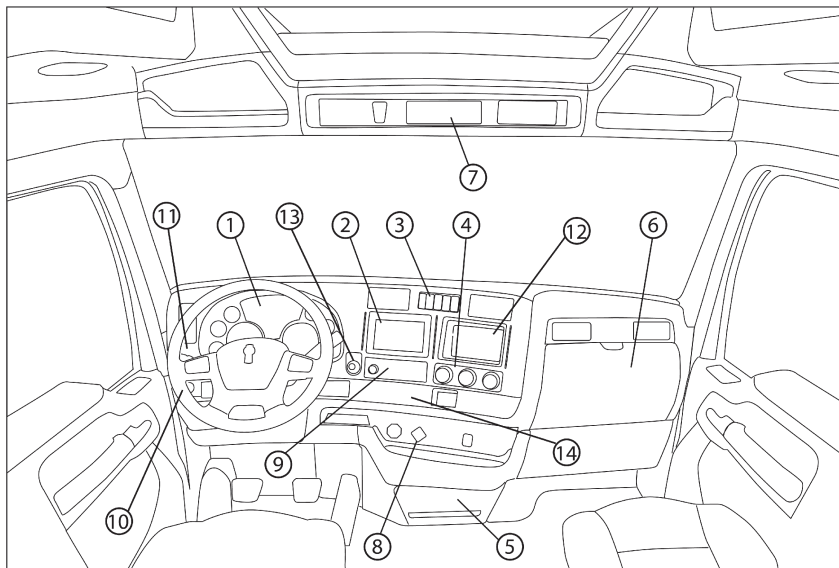

- |                                 |                        |                               |
|---------------------------------|------------------------|-------------------------------|
| 1. Instrument Cluster           | 6. Glove Box           | 12. Optional Gauge            |
| 2. PACCAR Navigation (optional) | 7. Overhead Storage    | 13. Menu Control Switch (MCS) |
| 3. Switches                     | 8. Park Brake Controls | 14. Switches                  |
| 4. Air Conditioning             | 9. Radio               |                               |
| 5. Cup Holder                   | 10. Ignition Switch    |                               |
|                                 | 11. Headlight Switch   |                               |

Instrument Cluster

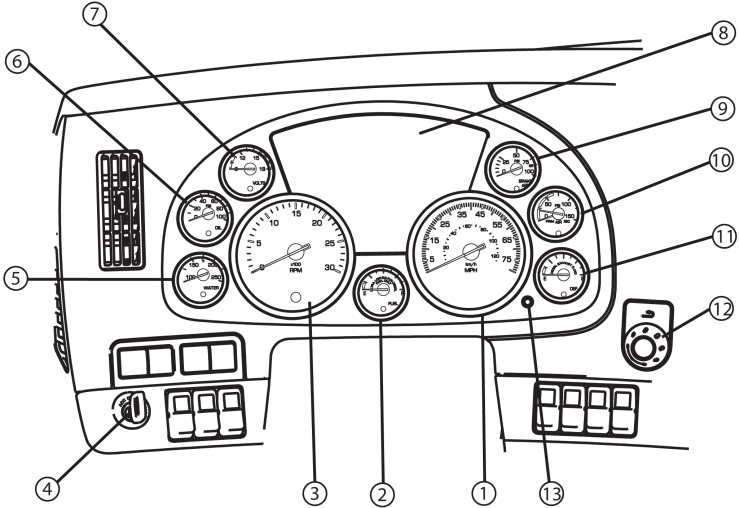

- 1. Speedometer
- 2. Fuel Level (primary)
- 3. Tachometer
- 4. Ignition Switch
- 5. Engine Coolant Temperature
- 6. Engine Oil Pressure
- 7. Voltmeter
- 8. Driver Performance Center
- 9. Brake Application Pressure
- 10. Primary/Secondary Air Pressure
- 11. Diesel Exhaust Fluid (DEF)
- 12. Menu Control Switch (MCS)
- 13. Trip Reset Button

# INSTRUMENT PANEL

---

## Instrument Cluster Description

### Instrument System Self Test

When the ignition switch is turned on the instrumentation system will undergo a Self Test. This test will verify the operation of the gauges and warnings.

During the Instrumentation System Self Test, multiple warning icons will be displayed in a sequence. The total sequence should only take no more than 10 seconds to complete.

Refer to Warning Light/Indicator Symbols on page 3-30 for information on each symbol.

Completing this sequence will indicate a successful Self Test. Have your instrumentation system checked by a qualified service technician if does not successfully complete.

### Audible Alarm

The audible alarm will sound during the Instrumentation System Self Test. The audible alarm will also sound in conjunction with most warning lights. These events include but are not limited to headlight on, fifth wheel, stop engine, primary/secondary air, and driver door open warnings.

### Optional Icon

Additional icon may be operational depending on individual vehicle specifications. These will be included in the Instrument System Self Test.

	<b>NOTE</b>
Some optional lights may illuminate even though your vehicle is not equipped with that particular feature.	

## Check Messages

Check messages are provided to give the operator additional information regarding systems that require attention due to a system malfunction and/or operating conditions that may hinder safe and proper performance for the vehicle. Some messages can be managed by the operator while others may require an authorized dealer repair.

### 1. Speedometer

The Speedometer indicates the vehicle speed in miles per hour (mph) and in kilometers per hour (km/h). The Speedometer cluster also includes several warning and indicator lamps (see Audible Alerts on page 3-29).

### 2. Fuel Level, Primary

The Primary Fuel gauge indicates the total (approximate) amount of fuel in the fuel tank. In addition to indicating empty and full, the gauge(s) also indicate the fuel level in graduated increments. When the fuel level for the tank is below 1/4 full, a red warning light in the gauge will come on.





Primary





Secondary

# INSTRUMENT PANEL

	<b>NOTE</b>
For Export vehicles, the fuel gauges will not state: ULTRA LOW SULFUR DIESEL FUEL ONLY.	

	<b>NOTE</b>
This vehicle may be manufactured with different fuel systems and different draw tube locations. Because of this and the amount of road crown, it is recommended that you do not operate your vehicle with less than one-quarter of your truck's fuel capacity. Allowing the fuel level to go below one-quarter of capacity could result in the lack of fuel to keep the engine running. In addition, you will want to keep the fuel tanks at least half-full to reduce condensation of moisture in the tanks. This moisture can damage the engine.	

	<b>WARNING!</b>
Do not carry fuel containers or any container used to store combustible liquids. Failure to comply may result in death, personal injury, equipment or property damage.	

	<b>WARNING!</b>
Do not remove a fuel tank cap near an open flame. Fuel vapors may be hot and combustible and can cause an explosion or fire. Failure to comply may result in death, personal injury, equipment or property damage.	

Refer to Refueling on page 4-60 for more information.

### 3. Tachometer

The Tachometer measures the engine speed in revolutions per minute (RPM).

The RPM Detail is also available as a viewable screen in the Driver Performance Center. Viewing the RPM detail is accomplished by using the MCS dial to rotate to the [VIRTUAL GAUGES].

The tachometer is a useful gauge when attempting to drive efficiently. It will let you match driving speed and gear selection to the operating range of your engine. If the engine speed gets too high, you can select a higher gear to lower the RPM's. If the engine speed drops too low, you can select a lower gear to raise the RPM's. (Refer to Driving Tips and Techniques on page 4-52 for further instructions on driving techniques and using the tachometer.) To avoid engine damage, do not let the pointer exceed maximum



governed speed. (See your *Engine Operation and Maintenance Manual* for RPM recommendations.)

The tachometer will illuminate a small green light just below the numbers of the gauge. This is to indicate the engine speed for optimal fuel economy. See Optimal Engine Speed on page 4-54 for more information on how to use this indicator during normal operation.

## 5. Engine, Coolant Temperature



The water temperature gauge shows the temperature of the engine coolant. Under normal operating conditions the water temperature gauge should register between 165° and 205°F (74° and 90°C). Under certain conditions, somewhat higher temperatures may be acceptable. But the maximum allowable temperature is 210°F (99°C), except for certain special engines. Check your engine manual to be sure.

Please refer to Engine is Overheating on page 2-5 for instructions on what to do if the engine is overheating.

## 6. Engine, Oil Pressure



It is important to maintain oil pressure within acceptable limits. If oil pressure drops below the minimum psi a red warning light in the gauge will turn on, the Stop Engine light will come on and an audible alarm tone will sound.

For further information on engine oil and normal operating pressures, see the *Engine Operation and Maintenance Manual*.



### CAUTION

Operating your vehicle with insufficient oil pressure will cause serious engine damage.

If the oil pressure fails to rise within 10 seconds after the engine starts, stop the engine and determine the cause.

Check the engine manufacturer's manual for the correct oil pressure ranges for your vehicle's engine.

If the oil pressure suddenly drops, or the audible alarm and engine oil pressure warning light come on while driving, please refer to Engine Oil Pressure Lamp Turns On on page 2-4 regarding what to do if oil pressure is insufficient.

For further information on engine gauges and operating your engine properly, refer to Engine Maintenance on page 5-93.

### 8. Driver Performance Center

The display can show multiple warning lights. Warning information will appear momentarily and then will minimize in the screen. Reviewing the warnings can be done by navigating the menu via the Menu Control Switch.

### 10. Primary and Secondary Air Pressure



Primary Air Pressure





Secondary Air Pressure

The air gauge indicates the air pressure in the brake system. There are two dial indicators, the primary indicator and icon is for the rear brake system while the secondary dial and icon is for the front brake system. The gauge indicates the amount of air pressure in each system in pounds per square inch (psi).

On vehicles equipped with metric air pressure gauges, the gauge face plate includes a kPa (major) scale and psi (minor) scale.

Please refer to Low Air Alarm Turns On on page 2-3 for instructions on what to do if the air system becomes inoperative.

	<b>NOTE</b>
Be sure the air pressure registers more than 100 psi (690 kPa) in both service systems before you move the vehicle.	

	<b>NOTE</b>
If the pressure in either or both circuits falls below 65 psi (448 kPa), a red warning light in the gauge will turn on and an audible alarm tone will sound when the engine is running.	

	<b>WARNING!</b>
If the air pressure falls below 60 psi (414 kPa), the spring brakes may stop the vehicle abruptly which could cause an accident resulting in death or personal injury. Observe the red warning lamps on the gauges. If one comes on, do not continue to drive the vehicle until it has been properly repaired or serviced. If the light and alarm do not turn off at start-up, do not try to drive the vehicle until the problem is found and fixed.	

	<b>WARNING!</b>
The air pressure warning light and the audible alarm tone indicate a dangerous situation: there is not enough air pressure in the air tanks for repeated braking and the brake system has failed. Without the use of your service brakes your spring brakes could suddenly apply causing a wheel lock-up, loss of control, or over-take by following vehicles. This may cause an accident resulting in death or personal injury. Bring the vehicle to a safe stop right away, while you still have control of the vehicle.	

## INSTRUMENT PANEL

### 11. Diesel Exhaust Fluid (DEF)



The diesel exhaust fluid gauge shows the approximate amount of DEF fluid in the DEF tank. Besides empty and full, the gauge also indicates 1/4, 1/2, and 3/4 of total capacity. DEF fluid is required to meet certain emission requirements. Do not allow your DEF tank to remain empty. Please refer to your Engine Aftertreatment Controls Operator's Manual for more details about DEF fluid.



#### CAUTION

Use Diesel Exhaust Fluid only. Failure to do so may damage components of the Diesel Particulate Filter (DPF).

### 13. Trip Reset

The cluster mounted trip reset button is the only way to zero trip data. After toggling the trip ODO (short pushes to select Trip A, B, C, or D) to the desired trip, HOLD the trip reset button, that resets the displayed trip data.

## Driver Performance Center

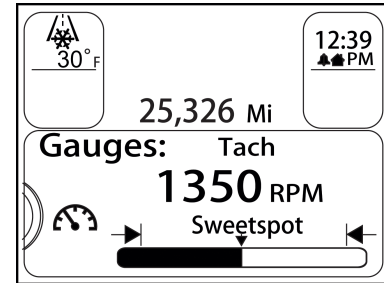

- 1 Odometer/Trip Odometer
- 2 Outside Air Temperature
- 3 Clock
- 4 Active Warnings
- 5 Cruise Control Indicator
- 6 Automated Transmission and Shift Indicator Area
- 7 Header
- 8 MCS Knob Cue
- 9 Main Content Window

## Driver Performance Center Description

	<b>WARNING!</b>
<p>Do not look at the Driver Performance Center for prolonged periods while the vehicle is moving. Only glance at the monitor briefly while driving. Failure to do so can result in the driver not being attentive to the vehicle's road position or situation, which could lead to an accident and possible death, personal injury or equipment damage.</p>	

The Driver Performance Center, located at the top of the instrument cluster, displays important vehicle information through a constant monitoring of systems when any of the following conditions are met:

- ignition key in ON or ACC positions
- ignition timer is active

- MCS button is pushed or spun (independent of ignition key switch position)
- clock alarm sounds
- driver or passenger door is opened
- hazard warning lamp switch is on
- Service brake switch is on
- Tractor marker lamp switch is on
- Trailer marker lamp switch is on
- Low Voltage Display not active
- and the screen has not been put into "Display Off Mode"

In addition to a blank screen, the following are menu items and the information available within each menu selections.

	<b>NOTE</b>
<p>Some Driver Performance Center functions are only accessible when the vehicle is parked. Other functions are accessible while the vehicle is moving or when parked. Each function is identified in the following descriptions:</p>	

# INSTRUMENT PANEL

---

3

## 1. Odometer/Trip Odometer

The Odometer/Trip Meter comes on when the door is opened and when the ignition key is in the ACC or ON position.

The odometer displays the distance your vehicle has traveled. The display can be configured to display Metric units or English units.

The current trip odometer displays how far the vehicle has gone on a particular trip and can display in increments of a tenth of a unit.

Please refer to Trip Information on page 3-24 for more information.

## 2. Outside Air Temperature

Used to display outside air temperature information and a warning of low temperatures.

The display will also alert the driver when the outside temperature approaches freezing (32° F or 0° C) by displaying a snowflake symbol. The symbol will turn on when the temperature drops below 34° F or 11° C and flash for the first 3 seconds, then stay on until the temperature goes above 37° F or 28° C.

The systems unit of measure (Fahrenheit or Celsius) can be changed by navigating to the settings menu.

The outside air temperature display will come on when the door is open and when the ignition key is in the ACC or ON position and turn off when the ignition switch is turned off.

The outside air temperature display uses a sensor (located at the bottom of the driver's side mirror assembly) to measure outside air temperature only. It is not capable of displaying the temperature of the road surface on either the temperature display or the snowflake icon. Additionally, the outside air temperature reading may be affected by exposure to direct sunlight.

### 3. Clock

The clock presents either the home time or the local time when the clock is set. If the clock is not set, the words "SET CLOCK" will appear when the ignition is turned ON. If the clock does not get set, the message will disappear and no time will be displayed. The time can be set while the "SET CLOCK" prompt is showing or it can be set by navigating to the settings menu via the Menu Control Switch.

The clock will display either the local or the home time of day.

Set the Home time to the current time at the base of operation. Set the local time according to a time zone of destination. Reset the local time anytime the destination location changes and you need to use this function.

Please refer to Settings on page 3-27 to read more about how to set the clock.

### 4. Active Warnings

Active warnings will appear in this area in addition to areas around the center of the display. Active Warnings are those pop-up messages that have come up on the screen and/or been suppressed with an MCS button push. If there are warning icons active while the cruise control is enabled, icons will appear on each side of the cruise control icon. If there are multiple warnings, the display will show how many are active. The numbers may change without user interaction if individual warnings are intermittent, time based, self correcting, or the situation is rectified.

# INSTRUMENT PANEL

---

3

## 5. Cruise Control Indicator

This area is used to provide the driver with a dedicated location for cruise control set speed and if so equipped, adaptive cruise control with it's following distance information. Vehicles with adaptive cruise control will display many different icons in this area to alert the operator to take specific actions.

	NOTE
If there are secondary telltales active while the cruise control is enabled, icons will appear on each side of the cruise control icon.	

## 6. Automated Transmission and Shift Indicator Area

This area will provide the operator with feedback from the transmission. The display may reflect the transmission gear being operated, may provide Progressive Shift Cues (for vehicles built with PACCAR MX Engines with Progressive Shift option) or fault indicators specific for the transmission.

## 7. Header

This area displays the function category in which the MCS knob and display software are currently set. Depending on the display operation, the text color may change to indicate a user selection.



## 8. MCS Knob Cue

Used to provide the driver with screen navigation feedback. Cues are provided regarding when a user can push or spin the input control, shows in icon format which function is active, and which function will come up next if the knob is rotated either clockwise or counter clockwise.

## 9. Main Content Area

There are 5 functions allowed when driving, and 7 when the vehicle is parked. Some functions are available in both modes, but have different content available dependent on the mode

## How to Navigate the Functions in the Driver Performance Center Menu Control Switch (MCS)

The MCS is used to navigate the instrument display. It comprises of a back button and a push and spin knob. The Menu Control Switch is located on the right side panel.

The MCS knob can perform two functions. It can select and set values when spun and enter your settings when pushed.

The indicator image on the left lets you know whether to spin or push is available. The back button is always available even if there is no indicator image being displayed.

# INSTRUMENT PANEL

3

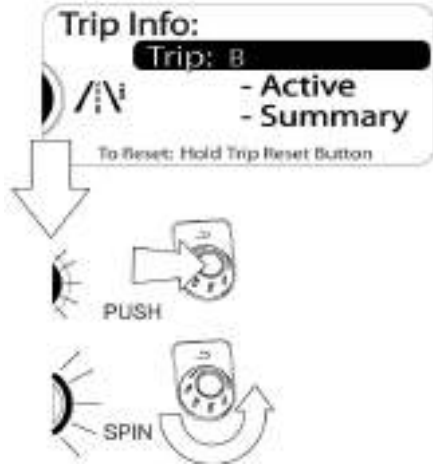

In addition to the prompts for spin and push, this area will show the current menu item as a larger icon and the available menus before and after as smaller icons.

The MCS button has a BACK button located above the knob. Pressing this

button will go back to the previous menu.

	NOTE
If the button is held for 2 seconds, it will turn off the display screen.	

PUSH → TO GO BACK

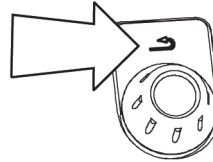

Here is a list of the available menu items:

- Blank screen - Use this menu item to minimize information on the screen.

- Virtual gauges - This menu item provides dynamic information to the operator.
- Ignition timer - Use this menu to set the time to idle the engine after removing the ignition key.
- Trip Information - Use this information to get trip summary details.
- Truck Information - Provides information about the vehicle.
- Active Warnings - Use this menu to view vehicle fault codes and messages.
- Settings - Use this menu to change preferences.
- Fuel Economy - Use this display to view the fuel economy performance of the vehicle. (available in driving mode)

Navigation of the system is organized into 3 levels of functions. The first level of organization is identified as "Trunk" level functions. The second level is identified as "Branch" level functions. The lowest level of functions are identified as the "Leaf" level functions. Some screens will appear differently depending if the vehicle is moving or parked. The following images provide an example of a screen to get familiarized with the interface.

### Trunk Level

At this level, you can navigate between functions by turning the MCS knob. You can enter a function by pushing the knob; at which you would then be going to what is termed the "branch" level of the software.

#### Display of a trunk level option

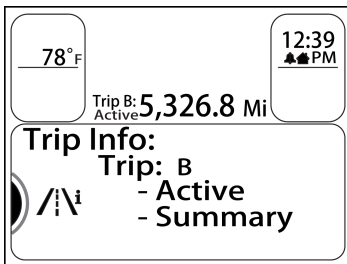

### Branch Level

In the branch level of functions, the MCS knob rotation controls a cursor highlight. When something is highlighted, an MCS Push will select that item or toggle its contents. Toggle fields typically use a darker colored text to distinguish them from fields that take the user to the "Leaf level".

#### Display of a branch level option

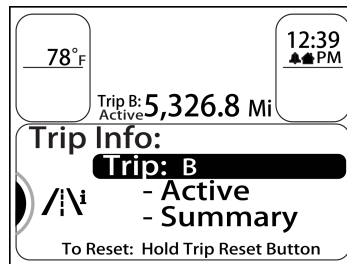

# INSTRUMENT PANEL

## Leaf Level

At this level, there are no more options to choose from. The MCS can be used to scroll through various information and the back button can be used to revert up to the branch (1 push) or the trunk (2 pushes) levels of the system.

3

## Display of a leaf level option

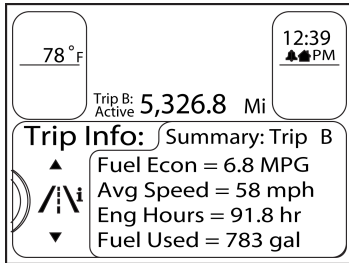

## Description of Menu Screens

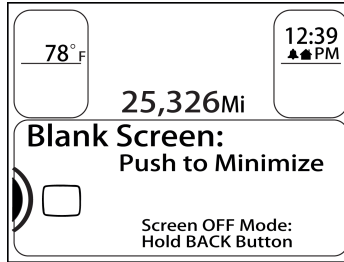

The blank screen mode is selected through the rotary MCS knob. The Display OFF Mode is selected by pressing the button above the MCS knob for more than 2 seconds.

## Blank Screen

This screen is available in both parked and driving modes.

The blank screen mode is to allow for minimized screen content, while still maintaining some of the more permanent screen elements such as the odometer, outside air temperature, warning cue, etc. This is different from the Display OFF Mode where the entire display shuts off.

## Tire Pressure Monitoring System

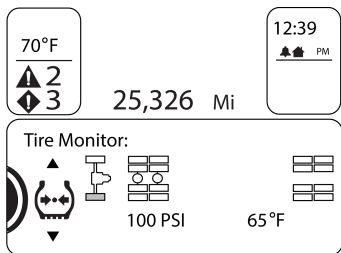

The tire pressure monitor menu provides individual tire pressure and temperature information for each tire identified on the vehicle when the vehicle is parked only. A push on the MCS knob will open the menu item. Spinning the MCS knob will scroll through the tires and display the information accordingly. When scrolling through each tire's information, the relevant tire will appear highlighted in the menu screen. A warning message will appear if the system detects a tire temperature or pressure that is outside of normal

parameters. This information is only available when parked.

## Virtual Gauges

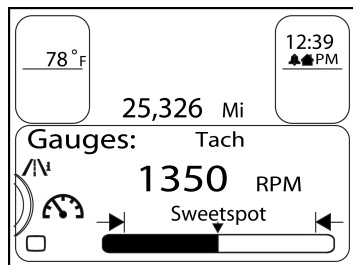

The virtual gauges function is selected through the rotary MCS knob and is available in both parked and driving modes.

Virtual gauges provide dynamic information about the vehicle's performance. Spin the MCS button to scroll through the available gauges and push to select the desired gauge to view.

# INSTRUMENT PANEL

## Ignition Timer

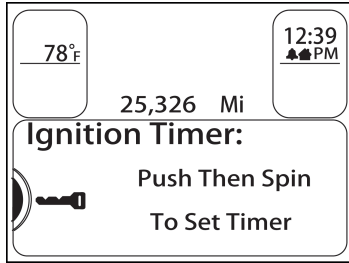

This function allows the driver to set a timer to shut off the truck. This feature is only available when the vehicle is parked. After the timer is set, the ignition key may be turned to the off position and removed. The engine will continue to run for the programmed time, then will shut off automatically.

## Fuel Economy

This function displays the dynamic fuel economy performance of the vehicle. It shows Average Speed, Average Fuel Economy, and a dynamic instantaneous indication of fuel economy above or below the current average. The screen is available when driving. Average fuel economy is computed by the fuel consumed during the trip (see the next section for Trip information). The fuel economy for a trip will be reset when that trip odometer is reset.

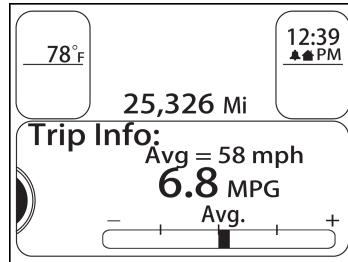

## Trip Information

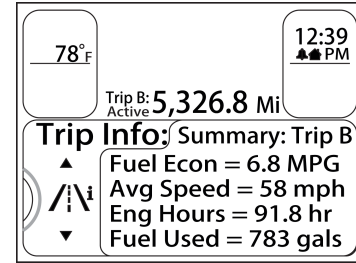

This function allows you to keep trip information data on up to 4 separate trips – labeled A, B, C, and D. Trips are also selectable as “Active” or “Inactive” so you can use the data logging function to treat trips separate from each other, or as segments of a combined trip. When driving, the screen only allows you to toggle which trip is viewed in the trip odometer and set the active/inactive status. When parked you can select and view a variety of data collected for each trip, as seen in the list below:

- Fuel Economy
- Average Speed
- Engine Hours
- Idle Hours
- % Idle Hours
- Fuel Used
- Idle Fuel Used
- % Idle Fuel Used
- Sweetspot Hours
- Cruise Control Hours
- Average Engine % Load
- Drive Hours
- PTO Hours
- % PTO Hours
- PTO Fuel Used

- % PTO Fuel Used
- PTO Economy

The cluster mounted trip reset button is used to zero and clear accumulated trip data. Short presses toggle between the odometer view, and the 4 trips. Holding the button when on a particular trip will zero the stored data and also automatically set the cleared trip to “active” status.

Using the MCS knob while in this screen will only activate or deactivate a trip function.

	<b>NOTE</b>
PTO options in the display will only be shown if the vehicle is equipped with a PTO.	

## Truck Information

	<b>NOTE</b>
Only available truck information will be shown (e.g., manual transmissions do not have a software version).	

This information is available when the vehicle is parked.

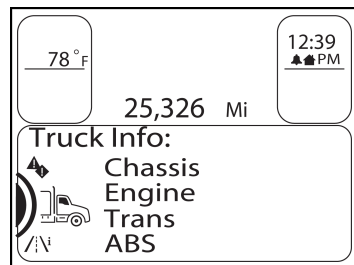

The screenshot shows a digital instrument panel display. At the top left, it displays '78 °F'. At the top right, it shows the time '12:39' and 'PM' with a sun icon. In the center, it displays '25,326 Mi'. Below this, there is a section titled 'Truck Info:' with a truck icon and a list of vehicle components: Chassis, Engine, Trans, and ABS.

1. Chassis Information
  - a. Chassis Number
  - b. Fleet ID
  - c. CECU Software Version #

# INSTRUMENT PANEL

## Warning and Faults

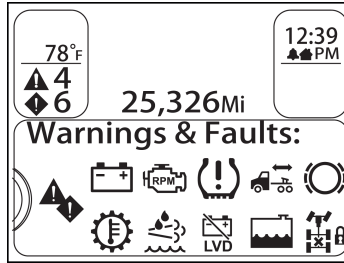

The display has a message alerting function that overrides the normal viewing and navigation of functions when an issue occurs on the truck. These alert messages are called “pop-ups” because they take over the screen. Some messages are low enough priority that they can be “suppressed”, which is done by pushing the MCS button. There will be a screen indicator showing which messages are suppressible. If multiple pop-ups are present at the same time, they are viewed in a stack format, and

a spin of the MCS knob will allow you to see the different warnings. The highest priority warning defaults to the top of the stack.

When the vehicle is parked, the “Warnings and Faults” function will access suppressed pop-ups that are counted and presented in the upper left corner of the screen.

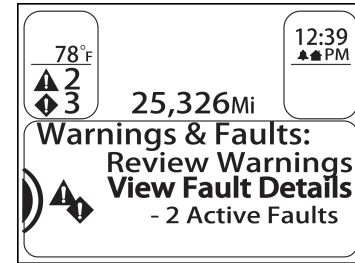

By selecting “Review Warnings” the pop-up messages are recalled, and if multiple are active, the stack can be navigated by spinning the MCS knob. The warning description can be viewed when driving or when parked, but

2. Engine Information
  - a. Engine Make
  - b. Engine Model
  - c. Engine Software Version
  - d. Governed Speed Limit
  - e. Engine Power
3. Transmission Information
  - a. Transmission Make
  - b. Transmission Model
  - c. Transmission Software Version #
4. ABS Information
  - a. ABS Make
  - b. ABS Model
  - c. ABS Software Version #



the fault details are visible only when parked. The menu selection shown in the image above simply won't be there if the truck is driving, though the warnings and tell-tale indicators on the cluster will still be available as indicators if the problem is serious.

Fault details screens include:

1. how many faults, shown in a scrollable stack format
2. which ECU the fault is being generated from
3. a text description of the issue
4. it's actual fault code
5. action instructions telling you what to do (e.g. seek service soon vs. correct at next scheduled service visit)

An example of a Fault Details screen is shown below:

### Fault Details Example

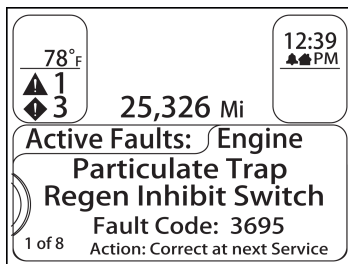

### Settings

This function is available only when the vehicle is parked.

Various settings may be changed using this function. The operator can change the time format (12hr/24hr), the time of day, alarm settings, units of measure for the display (mile/kilometer), and the language being displayed. Changing settings functions are typically done one of two ways. Items can be toggled straight from the highlighted selection (at the branch level); these cases use dark blue text that changes to the set value. Others are menu selections that bring up new “leaf level” screens. The following shows examples of turning the alarm on/off vs. screens that are navigated to in order to set the clock time.

# INSTRUMENT PANEL

## To turn alarm ON/OFF:

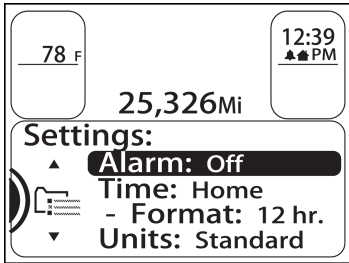

1. When in the Settings Menu, scroll through the list of menu items to “Alarm”. Press the MCS.
2. Press the MCS to turn the alarm ON or OFF.

## To set clock display format:

1. When in the Settings Menu, scroll through the list of menu items to “Format”.
2. Press the MCS to display either 12 hour (AM/PM) or 24 hour (military) time.

## To set home, local or alarm time:

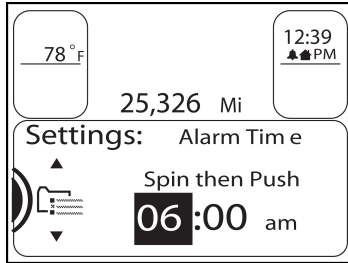

1. When in the Settings Menu, scroll through the list of menu items.
2. Press the MCS to select the item to change.
3. Rotate the MCS knob to change the hour. Press the MCS.
4. Rotate the MCS knob to change the minutes. Press the MCS.
5. Rotate the MCS to toggle AM/PM. Press the MCS.
6. Press the button above the MCS to Exit.

## Display Mode

The display off mode is available at any time in menu navigation, but the screen minimize mode can only be done when on this screen.

i	NOTE
There are times when the “Display Off” mode is not allowed or over-ridden by the system, for example if a “pop-up” message appears, the screen will turn back on, or if the truck is equipped with an adaptive cruise control system, the screen cannot be turned off when it is active.	

## WARNING SYMBOLS

### Guide to the Warning Symbols

The warning lights and audible alarm may indicate a system malfunction. Check the lights frequently, and respond properly as soon as you see one go on. These lights could save you from a serious accident.

When multiple warning icons are shown on the instrument cluster, they will appear at first and then minimize. When minimized they will be represented in the active warnings area of the display (see Driver Performance Center on page 3-14 for details). A triangle represents a warning registered and a diamond represents a check message.

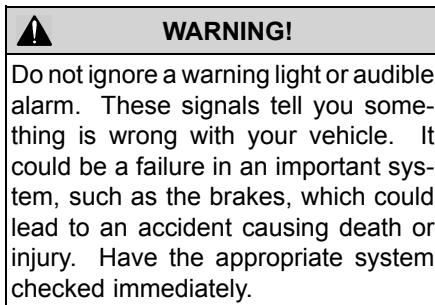

Check messages are provided to give the operator additional information regarding systems that require attention due to a system malfunction and/or operating conditions that may hinder safe and proper performance for the vehicle. The system will emit a chime to alert the operator that a message is appearing on the cluster. Some messages can be managed by the operator while others may require an authorized dealer repair.

The following is a list of Warning Light/Indicator Symbols that appear

in the instrument cluster and Driver Performance Center.





- the Symbol Name
- the appearance of the Symbol
- the Symbol Color when it is illuminated
- whether the symbol is standard (Std) or optional (Opt)
- whether the symbol has an associated check message
- the Page Number reference for additional information

Symbols are listed by major component sections.







*Example: Engine, and then in alphabetical order.*

# WARNING SYMBOLS







## Warning Light/Indicator Symbols

Symbol Name	Symbol	Color	Std/Opt	Msg	Page
1. Axle, Traction Control		Yellow	OPT		on page 3-37
2. Brakes, Anti-Lock Brake System (ABS)		Yellow	STD		on page 3-37
3. Brakes, Low Air		Red	STD		on page 2-3
4. Brake, Park Brake		Red	STD		on page 3-37
5. Brake, Service Brakes		Red	OPT		on page 3-37







# WARNING SYMBOLS

Symbol Name	Symbol	Color	Std/Opt	Msg	Page
6. Brakes, Trailer Anti-Lock Brake System (ABS)		Yellow	STD		on page 3-38
7. Differential, Inter Axle Diff Lock		Yellow	OPT		on page 3-60.
8. Dump Truck, Body Up		Red	OPT		on page 3-38
9. Dump Truck, Gate		Yellow	OPT		on page 3-38
10. Dump Truck, Trailer Body Up		Red	OPT		on page 3-38
11. Emissions, Diesel Particulate Filter (DPF)		Yellow	STD		on page 3-38





## WARNING SYMBOLS

Symbol Name	Symbol	Color	Std/Opt	Msg	Page
12. Emissions, High Exhaust System Temperature (HEST)		Yellow	STD		on page 3-39
13. Emissions, Malfunction Indicator Lamp (MIL)		Yellow	STD		on page 3-39
14. Engine, Check Engine		Yellow	STD		on page 3-40
15. Engine, Ether Start		Green	OPT		on page 3-40
16. Engine, Engine Fan		Green	STD		on page 3-40
17. Engine, Heater		Yellow	OPT		on page 3-40

# WARNING SYMBOLS







Symbol Name	Symbol	Color	Std/Opt	Msg	Page
18. Engine, Low Coolant Level		Yellow	STD		on page 3-40
19. Engine, Overspeed Air Shutdown		Red	OPT		on page 3-40
20. Engine, Retarder (Brake)		Green	OPT		on page 3-40
21. Engine, Stop Engine		Red	STD		on page 3-40
22. Engine, Wait To Start		Yellow	OPT		on page 3-41
23. Fuel, Water In Fuel (WIF)		Yellow	OPT		on page 3-41

## WARNING SYMBOLS



Symbol Name	Symbol	Color	Std/Opt	Msg	Page
24. Lane Departure Warning (LDW)		Yellow	OPT		on page 3-41
25. Lights, High Beam		Blue	STD		on page 3-41
26. Power Take-off (PTO)		Yellow	OPT		on page 3-41
27. Power Take-off (PTO), Pump Mode	<b>PUMP MODE</b>	Green	OPT		on page 3-41
28. Refrigerator		Green	OPT		on page 3-41
29. Seat Belt, Fasten		Red	STD		on page 3-41



## WARNING SYMBOLS

Symbol Name	Symbol	Color	Std/Opt	Msg	Page
30. Suspension Dump		Yellow	STD		on page 3-41
31. Tire Inflation		Yellow	OPT		on page 3-41
32. Transmission, Auxiliary		Yellow	OPT		on page 3-42
33. Transmission, Check		Red	OPT		on page 3-42
34. Transmission, Retarder (may include BrakeSaver when applicable)		Yellow	OPT	•	on page 3-42
35. Transmission, Service Transmission (Allison only)		Yellow	OPT	•	on page 3-42

## WARNING SYMBOLS

Symbol Name	Symbol	Color	Std/Opt	Msg	Page
36. Turn Signal, Left		Green	STD		on page 3-42
37. Turn Signal, Right		Green	STD		on page 3-42

3

### Description of Warning Symbols



#### 1. Axle, Traction Control (ATC or Automatic Traction Control)

**A.** Illuminates during the power-on self test when the ignition is turned ON. It turns off after a few seconds if no system problems are detected. If an ATC problem is detected, the ATC Warning lamp will turn on and stay on.

**B.** Flashes when the ATC is regulating wheel spin. (Refer to Automatic Traction Control for more information.)

**C.** It blinks continuously when the Deep Snow and Mud switch is turned on, indicating that this feature is active. (Refer to Deep Snow and Mud Switch and Anti-Lock Braking System on page 4-21 for more information.)

	<b>NOTE</b>
For vehicles equipped with Electronic Stability Program, please refer to additional material supplied with this operator manual, included in your glove box informational packet.	

	<b>WARNING!</b>
If this chassis is equipped with an electronic stability program (ESP) and is modified (e.g. adding or removing an axle, converting from a truck to a tractor, converting from a tractor to a truck, changing the body, lengthening of the wheelbase and/or frame, relocating frame components, or modifying pneumatic or electrical ABS/ESP harnesses) the ESP must be disabled by a qualified technician. If you have any questions, contact your authorized dealer. Failure to comply may result in death, personal injury, equipment or property damage.	



#### 2. Brakes, Anti-Lock Brake System (ABS)

Illuminates during the Instrumentation System Self Test. Have the ABS system checked by an authorized dealer if the ABS Warning Lamp stays on for more than 3 seconds.

Illuminates during normal operating conditions to indicate a problem with the ABS System. See ABS Warning Lamps on page 4-21 for more information.

Illuminates when a problem exists with the optional Wheel Spin Control feature. See Advanced ABS with Stability Control on page 4-21 for more information.



#### 4. Brake, Park Brake

Illuminates in the status indicator when parking brakes are applied.

## WARNING SYMBOLS



### 5. Brake, Service Brake

Indicates that a fault exists in the brake system. This should be checked by an authorized dealer as soon as possible.



### 6. Brakes, Trailer Anti-Lock Brake System (ABS)

Illuminates during the Instrumentation System Self Test and the tractor/truck is connected with a ABS equipped trailer.

Illuminates during normal operating conditions to indicate a problem with the Trailer ABS System. This should be checked by an authorized dealer as soon as possible. See ABS Warning Lamps on page 4-21 for more information.



### NOTE

Tractors/Trucks and trailers built after 3/1/01 must be able to turn on an In-Cab Trailer ABS Warning Lamp (per U.S. FMVSS121). The industry chose Power Line Communication (PLC) as the standard method to turn it on. See Trailer ABS Warning Lamp on page 4-21 for more information.

On trailers built prior to 3/1/01 verify trailer ABS system status via the required external warning lamp mounted on the trailer. The indicator lamp on the trailer should be yellow and identified with the letters "ABS".



### 7. Differential, Inter Axle Diff Lock

Illuminates when the inter-axle differential switch is ON thus locking the inter-axle differential. This powers the forward rear and the rear rear differentials equally. When the switch



### 8. Dump Truck, Body Up

Illuminates when Truck Dump Body is up.



### 9. Dump Truck, Gate

Illuminates when Truck Dump gate is open.



### 10. Dump Truck, Trailer Body Up

Illuminates when Trailer Dump Body is up.



### 11. Emissions, Diesel Particulate Filter (DPF)

Illuminates when diesel particulate filter is plugged. This warning will also illuminate when regeneration operation is disabled.



**12. Emissions, High Exhaust System Temperature (HEST)**

Illuminates when the exhaust gas temperature and exhaust components become extremely hot.

Refer to the Engine Aftertreatment control operator manual for complete instructions and warnings.

	<b>WARNING!</b>
<p>If this light is on, do not park in an area of combustible vapors or materials. You must keep combustibles at least five (5) feet away from the exhaust (outlet) stream (as it exits the tail pipe) while the HEST lamp is illuminated. Always park your vehicle outside. Failure to do so could ignite an explosion or harm bystanders which could result in serious injury.</p>	

	<b>WARNING!</b>
<p>If this light is on, do not park in an area where people are close by. You must keep combustibles at least five (5) feet away from the exhaust outlet while the HEST lamp is illuminated. Failure to do so could result in serious injury.</p>	

	<b>WARNING!</b>
<p>If this light is on, temperature of the tail pipe, exhaust pipes, diesel particulate filter (DPF), selective catalytic reduction (SCR) device and surrounding components including enclosures and steps becomes elevated during engine operation or any regeneration event and can cause serious burns to the skin. Allow adequate cooling time before approaching, working on or near any part of the exhaust system or surrounding components.</p>	



**13. Emissions, Malfunction Indicator Lamp (MIL)**

Illuminates when an engine emissions failure has occurred. The vehicle can be safely driven but should be serviced to correct the problem. The situation should not be considered an emergency. In some cases, the Malfunction Indicator Lamp will activate

## WARNING SYMBOLS

in conjunction with the High Exhaust Temperature, Diesel Particulate Filter (DPF) and Diesel Exhaust Fluid (DEF) Warning Lights.



### 14. Engine, Check Engine

Illuminates when a non emissions related problem exists, but the vehicle can still be safely driven. Vehicle should be serviced to correct the problem but the situation should not be considered an emergency.



### 15. Engine, Ether Start

Illuminates when ether start switch is on.



### 16. Engine, Engine Fan

Illuminates when fan is active.



### 17. Engine, Heater

Illuminates when Engine Heater switch is on.



### 18. Engine, Low Coolant Level

Illuminates with an audible alarm indicating critically low coolant level. The vehicle must be serviced to correct the problem but the situation should not be considered an emergency.



### 19. Engine, Overspeed Air Shutdown (EOAS)

Illuminates when the Engine Overspeed Air Shutdown system is activated.



### 20. Engine, Retarder (Brake)

Illuminates when the engine retarder (compression brake or exhaust brake)

switch is turned on. (Engine retarders are an option.)



### 21. Engine, Stop Engine

Illuminates and an audible alarm tone will sound when a major engine system problem exists.



### WARNING!

The illumination of the Stop Engine Light should be considered an emergency. You should stop the vehicle as safely as possible and turn OFF the ignition. The vehicle must be serviced and the problem corrected before driving again. Failure to do so may cause severe engine damage or cause an accident involving death or personal injury.



**22. Engine, Wait To Start**

Illuminates when engine grid heater is on. (Cummins ISL engines)



**23. Fuel, Water In Fuel (WIF)**

Illuminates when water has been detected in the fuel.



**24. Lane Departure Warning (LDW)**

Illuminates when optional LDW system is not able to track the vehicle's position within the lane.

	<b>NOTE</b>
For vehicles equipped with Lane Departure Warning, please refer to Lane Departure Warning Driver's Guide for additional information.	



**25. Lights, High Beam**

Illuminates when the high beams are on. This icon will flash with audible alarm if the headlamps are left on when the door is open. In addition, this icon will flash, but without an audible alarm, if there is a problem with the low beam headlights or the low beam headlight wiring. In such event, the high beam headlights will turn on at 50% normal brightness.



**26. Power Take-off (PTO)**

Illuminates when the PTO is engaged.

	<b>NOTE</b>
Do not drive vehicle with PTO engaged.	



**27. Power Take-off (PTO), Pump Mode**

Illuminates with remote throttle application. Indicates pump mode is active.



**28. Refrigerator**

Illuminates to indicate that the refrigerator is on and ignition is off.



**29. Seat Belt, Fasten**

Illuminates when the ignition key is turned on as a reminder to fasten your seat belt.



**30. Suspension Dump**

Illuminates when suspension air bags are deflated.

## WARNING SYMBOLS

---



### 31. Tire Inflation

Illuminates when tire pressures need to be checked. (Tire Pressure Monitoring System is an option.)



### 32. Transmission, Auxiliary

Illuminates to indicate auxiliary transmission is in neutral.



### 33. Transmission, Check

Illuminates when transmission has recorded a fault code. This icon may also appear in the Transmission Display menu of the Driver Performance Center. If the user is in this display menu, the icon does not indicate a fault code.



### 34. Transmission, Retarder (may include BrakeSaver when applicable)

Illuminates when BrakeSaver (export only) or Transmission Retarder is active.



### 35. Transmission, Service Transmission (Allison only)

Illuminates when Allison 1000/2000 transmission requires service.



### 36. Turn Signal, Left

Blinks when the left turn signal or the hazard light function is operating.



### 37. Turn Signal, Right

Blinks when the right turn signal or the hazard light function is operating.



## OPTIONAL GAUGES

### Introduction

Listed here are gauges that may or may not be on your dashboard or the center instrument cluster. For vehicles with a telematic navigation screen, optional gauges will be part of the screen functions. Please refer to the navigation system supplement for further details about its functions and how it works.

### Axle, Pusher Air Pressure



The Pusher Axle Air Pressure gauge(s) indicate the air pressure in the pusher axle(s) suspension air bags. This icon may have a numeral above the image of the wheel to indicate which pusher axle if there are multiple pusher axles on the vehicle.

### Axle, Tag Air Pressure



The Tag Axle Air Pressure gauge indicates the amount of air pressure in the tag axle suspension air bags. This icon may have a numeral above the image of the wheel to indicate which pusher axle if there are multiple pusher axles on the vehicle.

## OPTIONAL GAUGES

### Fuel Filter Restriction Pressure



3

This gauge tells you the condition of the fuel filter by indicating the restriction from the fuel filter to the fuel pump. Check the engine manual for proper restriction. Replace the filter with an approved filter only. Do not substitute the wrong micron element.



#### NOTE

The maximum allowable restriction could vary according to the type or make of engine. Consult the engine manufacturers manual or engine dealer for fuel restriction specifications.

### Air Filter Restriction Indicator or Gauge



This gauge indicates the condition of the engine air cleaner and is measured by inches of water (H<sub>2</sub>O). A clean filter should register 7 in. H<sub>2</sub>O (may vary with system design) and a filter whose life is over will register approximately 25 in. H<sub>2</sub>O.



#### CAUTION

Continued operation with the Air Filter Restriction Gauge reading 25 in. H<sub>2</sub>O may cause damage to the engine. Inspect the filter and replace if necessary. Holes in the paper element render an air cleaner useless and may cause the Air Filter Restriction Gauge to give a false reading, even if the element is clogged. Replace the element if it is damaged.

### Engine, Oil Pressure



It is important to maintain oil pressure within acceptable limits. If oil pressure drops below the minimum psi a red warning light in the gauge will turn on, the Stop Engine light will come on and an audible alarm tone will sound.

### Engine, Oil Temperature



The Engine Oil Temperature gauge indicates the engine oil temperature. If the oil temperature exceeds the maximum limits, a red warning light in the gauge will turn on. Do not exceed maximum engine oil temperature recommended by the engine manufacturer. (See the *Engine Operation and Maintenance Manual* for details.)

### Manifold Pressure Gauge



Your manifold pressure gauge indicates the power your engine is putting out by showing the amount of turbo boost. If the pressure indicated by your manifold pressure gauge goes down, there may be something wrong with your engine. Have it checked by a qualified service person.

## OPTIONAL GAUGES

### Fuel Pressure Gauge



Your vehicle may also have a fuel pressure gauge.

3



#### **WARNING!**

Do not carry additional fuel containers in your vehicle. Fuel containers, either full or empty, may leak, explode, and cause or feed a fire, possibly causing death or personal injury. Do not carry extra fuel containers, even empty ones are dangerous.

### Transmission Temperature Gauge



Your Transmission Temperature Gauge indicates the temperature of the oil in your transmission. Watch this gauge to know when your transmission is overheating. If it is, have it checked by an authorized service representative.

Maximum transmission temperature may vary, depending upon the transmission and type of lubricant. Check your transmission's owner's manual.

### Drive Axle Temperature Gauge (Forward and Rear)

These gauges indicate the temperature of the lubricant in your vehicle's axle(s). These temperatures will vary with the kind of load you are carrying and the driving conditions you encounter. Maximum axle temperature may vary, depending upon the axle and type of lubricant. Very high temperatures signal a need to have your axle(s) lubrication checked.



Depending on the vehicle configuration, there may be a drive axle temperature gauge for more than just the forward and rear

driver. The icon will have an X over the representative axle to indicate which axle the temperature is being displayed in the gauge.

	<b>CAUTION</b>
<p>Driving with very hot temperatures in your rear drive axles can cause serious damage to axle bearings and seals. Have your axle lubrication checked if you notice a sign of overheating.</p>	

### Suspension Load Air Pressure, #1, #2

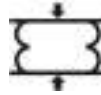

Suspension Load Air Pressure #1

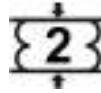

Suspension Load Air Pressure #2

The Suspension Load Air Pressure gauge indicates the amount of air pressure in the air suspension air bags.

When the vehicle is equipped with dual leveling valves, the #1 gauge indicates the air pressure in the driver's side air bags. The #2 gauge indicates the air pressure in the passenger's side air bags.

### Tractor Brake Application Air Pressure



The Tractor Brake Application Air Pressure gauge indicates the amount of air pressure applied to the tractor brakes.

## OPTIONAL GAUGES

---

### Trailer Brake Application Air Pressure



The Trailer Brake Application Air Pressure gauge indicates the amount of air pressure applied to the trailer brakes during brake foot valve and/or hand brake control valve applications.

### Trailer Air Tank Air Pressure



The Trailer Air Tank Air Pressure gauge indicates the amount of air pressure in the trailer brake air tank.

### Transfer Case Oil Temperature



The Transfer Case Oil Temperature gauge indicates the temperature of the oil in the transfer case. If the oil temperature exceeds maximum limits, a red warning light in the gauge will turn on. Do not exceed maximum oil temperature recommended by the manufacturer. (See the *Transfer Case Operation and Maintenance Manual* for details.)

### Transmission Oil Temperature, Auxiliary



The Auxiliary Transmission Oil Temperature gauge indicates the temperature of the oil in the auxiliary transmission.

	NOTE
Watch this gauge to know when the transmission is overheating.	

Do not exceed maximum oil temperature recommended by the manufacturer. (See the *Transmission Operation and Maintenance Manual* for details.)

### Transmission Retarder Oil Temperature



The Transmission Retarder Oil Temperature gauge indicates the temperature of the oil in the transmission retarder.

	NOTE
Watch this gauge to know when the transmission is overheating.	

Do not exceed maximum oil temperature recommended by the manufacturer. (See the *Transmission Operation and Maintenance Manual* for details.)

# SWITCHES

## SWITCHES

### Dash Switches

This custom vehicle will have a wide variety of switch controlled equipment. However, this particular vehicle may not have every switch identified in this section of the operator manual.

Some air device switches on the dash may require that the vehicle either be at a specific speed, park brakes set or another device to be on or off for the air device to operate.

The instrument display will display information regarding what needs to change in order for the air device to operate as expected.

Some of these switches control air system functions and may require the vehicle's ignition to be in the ACC or ON position for switch to maintain control via air pressure. If the switch requires ignition power, it will allow that air circuit to lose pressure (deactivate) once the ignition is turned off. To activate that function again, the ignition needs to be turned to the ACC or ON







position and the switch needs to be re-engaged. Some of the switches that control air functions will not disengage when the vehicle ignition is turned off. If the ignition is turned off, air pressure will be maintained in the circuit for that control switch. The few switches that do not require ignition power are described accordingly after the Dash Switch table.

The Dash Switch table provides a complete list of icons that may be found on the switch.







### Dash Switches







Symbol Name	Symbol	Color	Standard	Option	Page
1. Axle, Diff-Lock - Dual		Amber		•	See Axle, Diff-Lock - Dual on page 3-60.
2. Axle, Diff-Lock - Forward Rear		Amber		•	See Axle, Diff-Lock - Forward Rear on page 3-60.









Symbol Name	Symbol	Color	Standard	Option	Page
3. Axle, Diff-Lock - Steer		Amber		•	See Axle, Diff-Lock - Front on page 3-60.
4. Axle, Diff-Lock - Rear Rear		Amber		•	See Axle, Diff-Lock - Rear Rear on page 3-60.
5. Axle, Diff-Lock - Single Rear		Amber		•	See Axle, Diff-Lock - Single Rear on page 3-60.
6. Axle, Inter-Axle Differential Locked (Tandem)		Amber		•	See Axle, Inter-Axle Differential Locked (Tandem) on page 3-60.
7. Axle, Two Speed		Green		•	See Axle, Two Speed on page 3-60.
8. Back Up Alarm Mute		Amber		•	See Back Up Alarm Mute on page 3-60.
9. Batteries, Low Voltage Disconnect (LVD)		None	•		See Batteries, Low Voltage Disconnect (LVD) on page 3-60.







## SWITCHES

Symbol Name	Symbol	Color	Standard	Option	Page
10. Brakes, ABS Off-Road		Amber		•	See Brakes, ABS Off-Road on page 3-60.
11. Brakes, Parking Brake Valve		Red	•		See Brakes, Parking Brake Valve on page 3-60.
12. Cab Dimmer Switch		None	•		See Cab Dimmer Switch on page 3-60.
13. Dump Truck Gate		Red		•	See Dump Truck Gate on page 3-60.
14. Engine, Brake Level		None		•	See Engine, Brake Level on page 3-60.
15. Engine, Brake On/Off		Green		•	See Engine, Brake On/Off on page 3-61.
16. Engine, Cruise Control On/Off		Green	•		See Engine, Cruise Control On/Off on page 3-61.







Symbol Name	Symbol	Color	Standard	Option	Page
17. Engine, Cruise Control Set/Resume		None	•		See Engine, Cruise Control Set/Resume on page 3-61.
18. Engine, Ether Start (Optional)		None		•	See Engine, Ether Start on page 3-61.
19. Engine, Fan Override		Green		•	See Engine, Fan Override on page 3-61.
20. Engine, Heater		Green		•	See Engine, Heater on page 3-62.
21. Engine, Overspeed Air Shutdown (Manual)		None		•	See Engine, Overspeed Air Shutdown on page 3-62.
22. Engine, Overspeed Air Shutdown (Test)		Amber		•	See Engine, Overspeed Air Shutdown (Test) on page 3-62.
23. Engine, Remote Throttle		Amber		•	See Engine, Remote Throttle on page 3-62.







## SWITCHES

Symbol Name	Symbol	Color	Standard	Option	Page
24. Engine, Under Hood Air Intake		None		•	See Engine, Under Hood Air Intake on page 3-62.
25. Exhaust, Diesel Particulate Filter (DPF) Regeneration		None	•		See Exhaust, Diesel Particulate Filter (DPF) Regeneration on page 3-62.
26. Fifth Wheel Slide		Red		•	See Fifth Wheel Slide on page 3-62.
27. Fuel Heater		Amber		•	See Fuel Heater on page 3-63.
28. Generic Air, Accessory		Green		•	See Generic Air, Accessory on page 3-63.
29. Generic, Spare	<b>SPARE</b>	Green		•	See Generic, Spare on page 3-63.
30. Lights, Auxiliary		Green		•	See Lights, Auxiliary on page 3-63.







Symbol Name	Symbol	Color	Standard	Option	Page
31. Lights, Beacon		Green		•	See Lights, Beacon on page 3-63.
32. Lights, Daytime Running (Override)		Green		•	See Lights, Daytime Running on page 3-63.
33. Lights, Dome		None	•		See Lights, Dome on page 3-63.
34. Lights, Lights, Exterior Lights Self Test		None	•		See Lights, Exterior Lights Self Test on page 3-64.
35. Lights, Flood		Amber		•	See Lights, Flood on page 3-64.
36. Lights, Flood ISO 3732 Spare		Amber		•	See Lights, Flood ISO 3732 Spare on page 3-64.
37. Lights, Fog		Green		•	See Lights, Fog on page 3-64.

## SWITCHES







Symbol Name	Symbol	Color	Standard	Option	Page
38. Lights, Hazard		Red	•		See Lights, Hazard on page 3-64.
39. Lights, Headlight and Parking Lights		None	•		See Lights, Headlight on page 3-64.
40. Lights, Marker/Clearance		None	•		See Lights, Marker/Clearance on page 3-65.
41. Lights, Marker/Clearance/Cab		None		•	See Lights, Marker/Clearance/Cab on page 3-65.
42. Lights, Marker/Clearance/Trailer		None		•	See Lights, Marker/Clearance/Trailer on page 3-65.
43. Lights, Spot		Green		•	See Lights, Spot on page 3-65.
44. Mud and Snow Traction Control		None		•	See Mud and Snow Traction Control on page 3-65.

Symbol Name	Symbol	Color	Standard	Option	Page
45. Power Take-off (PTO)		Amber		•	See Power Take-off (PTO) on page 3-65.
46. Power Take-off (PTO), Forward		Amber		•	See Power Take-off (PTO), Forward on page 3-66.
47. Power Take-off (PTO), Rear		Amber		•	See Power Take-off (PTO), Rear on page 3-66.
48. Roofdenser		Green		•	See Roofdenser on page 3-66.
49. Suspension, Axle, Pusher		Green		•	See Suspension, Axle, Pusher on page 3-66.
50. Suspension, Axle, Tag		Green		•	See Suspension, Axle, Tag on page 3-66.
51. Suspension, Dump		Amber		•	See Suspension, Dump on page 3-66.

## SWITCHES

Symbol Name	Symbol	Color	Standard	Option	Page
52. Suspension, Lift		Amber		•	See Suspension, Lift on page 3-66.
53. Suspension, Third Axle Lift		Green		•	See Suspension, Third Axle Lift on page 3-66.
54. Pintle Hook		Green		•	See Tow Hook on page 3-66.
55. Trailer, Axle (3rd Axle) Lift		Green		•	See Trailer, Axle (3rd Axle) Lift on page 3-66.
56. Trailer, Axle Lift Forward		Green		•	See Trailer, Axle Lift Forward on page 3-66.
57. Trailer, Axle Lift Rear		Green		•	See Trailer, Axle Lift Rear on page 3-66.
58. Trailer, Belly Dump		Red		•	See Trailer, Belly Dump on page 3-67.



Symbol Name	Symbol	Color	Standard	Option	Page
59. Trailer, Dump Gate		Red		•	See Trailer, Dump Gate on page 3-67.
60. Trailer, Hotline		Green		•	See Trailer, Hotline on page 3-67.
61. Trailer, Suspension Air Dump		Amber		•	See Trailer, Suspension Air Dump on page 3-67.
62. Transmission, Transfer Case		Amber		•	See Transmission, Transfer Case on page 3-67.
63. Transmission, Transfer Case 2 Speed		Amber		•	See Transmission, Transfer Case 2 Speed on page 3-67.
64. Winch Clutch		Green		•	See Winch Clutch on page 3-67.

# SWITCHES

3



## 1. Axle Diff-Lock - Dual

Turn switch on to engage Front and Rear Axle Diff Lock.



## 2. Axle Diff-Lock - Forward Rear

Turn switch on to engage Forward Rear Axle Diff Lock.



## 3. Axle Diff Lock - Steer

Turn switch on to engage Front Axle Diff Lock.



## 4. Axle Diff-Lock Rear Rear

Turn switch on to engage Rear Rear Axle Diff Lock.



## 5. Axle Diff Lock - Single Rear

Turn switch on to engage Single Rear Axle Diff Lock.



## 6. Axle, Inter-Axle Differential Locked (Tandem)

Turn switch on to engage Inter-Axle Differential Lock.



## 7. Axle, Two Speed

If equipped, the two speed axle switch allows you to select axle high and low ranges. The low range (Off) provides maximum torque for operating off-highway. The high range (On) is a faster ratio for highway speeds. This switch does not require ignition power to maintain the desired switch setting.



## 8. Back Up Alarm Mute

Turn switch on to mute Back Up Alarm.



### NOTE

The mute function use is discouraged. Only use mute when legally required.



## 9. Batteries, Low Voltage Disconnect (LVD)

If your vehicle is equipped with a Low Voltage Disconnect (LVD) feature, the LVD module is located inside the driver's side kick panel.



## 10. Brakes, ABS Off-Road

Turn switch on to engage ABS Off-Road mode. See Anti-Lock Braking System on page 4-21.



## 11. Brakes, Parking Brake Valve

Pull yellow knob to activate parking brakes. See Parking Brake Valve on page 4-23.



## 12. Cab Dimmer Switch

This switch is used to alter the brightness of the instrument panel lights.



### NOTE

The Headlamp Switch is an "ON" or "OFF" switch. The panel lights are on full intensity during the day and go to Dimmer mode when headlamps are on.



## 13. Dump Truck Gate

Turn switch on to open Dump Truck Gate.

**14. Engine, Brake Level**

In the up position there will be 100% engine retarding. In the middle position there will be 60% engine retarding. In the down position there will be 33% engine retarding.

For more information on when and how to use the engine brake in your vehicle, see the engine brake owner's manual for additional engine brake information.

**15. Engine, Brake On/Off**

Turn switch on to activate Engine Brake system.

For more information on when and how to use the engine brake in your vehicle, see the engine brake owner's manual for additional engine brake information.

**16. Engine, Cruise Control On/Off**

Turn switch on to activate Cruise Control System.

**17. Engine, Cruise Control Set/Resume**

The Cruise Control Set/Resume switch allows you to SET the desired speed or RESUME the desired speed after the cruise control function has been interrupted.

**WARNING!**

Do not operate the cruise control when operating on road surfaces with poor traction (wet, icy, or snow covered roads) or in heavy traffic. Accelerations caused by the normal operation of the cruise control could cause you to lose control of the vehicle resulting in an injury accident.

**18. Engine, Ether Start (optional)**

Momentarily push switch in to activate the Ether Start system.

**19. Engine Fan Override**

The engine fan switch allows you to control the engine fan manually or automatically. Please refer to Engine Fan Control on page 4-12 for more information on how to operate this switch.

**WARNING!**

Do not work on or near the fan with the engine running. Anyone near the engine fan when it turns on could be seriously injured. If it is set at MANUAL, the fan will turn on any time the ignition key switch is turned to the ON position. In AUTO, it could engage suddenly without warning. Before turning on the ignition or switching from AUTO to MANUAL, be sure no workers are near the fan.

# SWITCHES

3

	<b>CAUTION</b>
The fan or equipment near it could be damaged if the fan turns on suddenly when you do not expect it. Keep all tools and equipment away from the fan.	

	<b>CAUTION</b>
Do not operate the engine fan in the <b>MANUAL</b> position for extended periods of time. The fan hub was designed for intermittent operation. Sustained operation will shorten the fan hub's service life as well as reduce fuel economy.	



### 20. Engine Heater

Turn switch on to activate the Engine Heater.



### 21. Engine, Overspeed Air Shutdown (Manual)

Turn switch on to engage the Engine Overspeed Air Shutdown system. A system reset will be required before re-starting engine. See EOAS system manufacturer's instruction manual for details.



### 22. Engine, Overspeed Air Shutdown (Test)

Hold down switch and increase engine RPM to test that Engine Overspeed Air Shutdown system functions correctly. A system reset will be required before restarting engine. See EOAS system manufacturer's instruction manual for details.



### 23. Engine, Remote Throttle

Turn switch on to activate Remote Throttle Control.



### 24. Engine, Under Hood Air Intake

Operate this switch to control whether the engine intake is from under the hood or fresh air from the air inlet grille.



### 25. Exhaust, Diesel Particulate Filter (DPF) Regeneration Switch

Manually controls the diesel particulate filter regeneration process. Refer to Engine Aftertreatment Controls Operator's Manual for additional information.





### 26. Fifth Wheel Slide

Turn switch on to "Unlock" Fifth Wheel Slide mechanism. The switch is guarded to protect you from accidentally activating or releasing the lock.

	<b>NOTE</b>
Vehicles having an air slide fifth wheel have a fifth wheel slider lock controlled by a switch on the instrument panel. By placing the switch in the unlock position you can slide the fifth wheel to various positions to adjust weight distribution.	



**⚠ WARNING!**

Do not move the fifth wheel while the tractor-trailer is in motion. Your load could shift suddenly, causing you to lose control of the vehicle. Never operate the vehicle with the switch in the UNLOCK position. Always inspect the fifth wheel after you lock the switch to be sure the fifth wheel slide lock is engaged. Failure to comply may result in death, personal injury, equipment or property damage.

-  **27. Fuel Heater**  
Turn switch on to activate Fuel Heater.
-  **28. Generic, Air, Accessory**  
Provides accessory air to the end of frame connection when switch is turned on.

**i NOTE**

The generic air accessory switch is designed by the original equipment manufacturer to reset when the ignition power is turned off. When ignition is turned off, this circuit will exhaust air pressure.

- SPARE 29. Generic, Spare**  
Turn switch on to power customer installed accessory.
-  **30. Lights, Auxiliary**  
Turn switch on for Auxiliary Lights.
-  **31. Lights, Beacon**  
Turn switch on for Beacon Light(s).

-  **32. Lights, Daytime Running Lights (DRL) (with optional over-ride switch)**  
Three controls (or conditions) will affect whether the system is ON or OFF:
  - headlight (master) switch
  - engine cranking
  - parking brake
 If the headlight switch is turned OFF, the DRL system engages automatically after the engine starts and you release the parking brake. If the headlight switch is ON, the DRL system is overridden, and headlights operate normally. Also, during engine cranking the DRL is temporarily turned off.

**⚠ WARNING!**

Do not use daytime running lights (DRL) during periods of darkness or reduced visibility. Do not use DRL as a substitute for headlights or other lights during operations that require lighting of your vehicle. Failure to comply may result in death, personal injury, equipment or property damage.

# SWITCHES

3



### 33. Lights, Dome

Turn switch on for Cab Dome Lights.



### 34. Lights, Exterior Lights Self Test

This switch will engage a program which will illuminate exterior light for the operator to verify functionality. Please refer to Exterior Lights Self Test on page 3-77 for more detail on how to use the program.



### 35. Lights, Flood

Turn switch on for cab mounted Flood Lights.



### 36. Lights, Flood ISO 3732 Spare

Turn switch on for trailer mounted Flood Lights.



### 37. Lights, Fog

Turn switch on for Fog Lights.



## NOTE

Across the U.S.A. and Canada, State/Provincial requirements vary as to when high beams and fog lights can and cannot be used together. Some states allow only four lights to be used together, while some allow more. How your lights are arranged will affect whether you can operate headlights and fog lights concurrently—always comply with the state or provincial requirements where you are driving.



### 38. Lights, Hazard

With the switch in the ON position, the emergency flasher makes all four turn signals (front and rear) flash simultaneously. The flasher works independently of the ignition switch. You should always use the flasher if the vehicle is disabled or parked under emergency conditions.



## WARNING!

Use your Hazard Warning Light System any time you have to stop off the road or on the side of the road, day or night. A hard-to-see vehicle can result in an injury accident. Another vehicle could run into you if you do not set your flashers and follow the placement of emergency signals per FMCSR 392.22.





### 39. Lights, Headlight and Parking Lights

Turn switch on for headlights. When the Headlights are ON, side, and tail lights are also on. This switch also controls the park lights.

 **CAUTION**

If you have confirmed there is a problem in the low beam wiring circuit, proceed with caution to the next available exit/turnoff and safely pull your vehicle completely off the road and call for assistance. Driving your vehicle with the headlamps on high beam (at reduced intensity) for a prolonged period could lead to an injury accident. Contact your nearest dealer to have the problem corrected as soon as possible.

 **40. Lights, Marker/Clearance**  
Turn switch on to control Cab and Vehicle Marker/Clearance lights.

 **NOTE**

An interrupt switch for the trailer marker lights is mounted on the end of the turn signal lever.

 **41. Lights, Marker/Clearance/Cab**  
Turn switch on to control Cab Marker/Clearance lights separately from the trailer.

 **42. Lights, Marker/Clearance/Trailer**  
Turn switch on to control Trailer Marker/Clearance lights separately from the vehicle marker/clearance lights.

 **43. Lights, Spot**  
Turn switch on for Spot Light.

 **44. Mud and Snow Traction Control**  
Momentarily push switch in to engage Traction Control (TC).

 **45. Power Take-off (PTO)**  
Turn switch on to engage PTO. Your vehicle may be equipped with a dash mounted switch that controls PTO engagement/disengagement. When the operator activates the switch for the PTO, the status indicator lamp (located on the switch) will immediately illuminate even though PTO engagement may not have occurred. If the PTO is engaged and the operator turns the switch OFF, the PTO status indicator lamp (located on the switch) will go out immediately even though PTO disengagement may not have occurred.

 **NOTE**

Actual PTO engagement/ disengagement may be delayed momentarily since it is controlled by the air system and mechanical movement.

# SWITCHES



## CAUTION

Increasing engine RPM before the PTO is actually engaged could prevent the PTO from engaging and/or cause PTO damage.

3



### 46. Power Take-off (PTO), Forward

Turn switch on to engage Forward PTO.



### 47. Power Take-off (PTO), Rear

Turn switch on to engage Rear PTO.



### 48. Roofdenser

Turn switch on for roof mounted condenser fan.



### 49. Suspension, Axle, Pusher

Turn switch on to lower Single or Forward Pusher Axle. This switch does not require ignition power to maintain the desired switch setting.



### 50. Suspension, Axle, Tag

Turn switch on to lower Tag Axle. This switch does not require ignition power to maintain the desired switch setting.



### 51. Suspension, Dump

Turn switch on to deflate Suspension Air Bags. The switch is guarded to protect you from accidentally deflating the suspension. This switch does not require ignition power to maintain the desired switch setting.



## WARNING!

Do not operate the Air Suspension Deflate Switch (Dump Valve) while driving. Sudden deflation while your vehicle is moving can affect handling and control and could lead to an accident. Use this switch only when your vehicle is not moving.



## CAUTION

Operating a vehicle with air suspension bags either overinflated or underinflated may cause damage to driveline components. If a vehicle must be operated under such conditions, do not exceed 5 mph (8 km/h).



### 52. Suspension, Lift

Turn switch on to over-inflate Suspension Air Bags. Turn switch off for normal suspension height.



### 53. Suspension, Third Axle Lift

Turn switch on to raise Third Axle. This switch does not require ignition power to maintain the desired switch setting.



### 54. Pintle Hook

Turn switch on to remove the slack from the Tow Hook.



### 55. Trailer, Axle (3rd Axle) Lift

Turn switch on to lift 3rd Trailer Axle. This switch does not require ignition power to maintain the desired switch setting.



### 56. Trailer, Axle Lift Forward

Turn switch on to lift Forward Trailer Axle. This switch does not require ignition power to maintain the desired switch setting.





**57. Trailer, Axle Lift Rear**  
Turn switch on to lift Rear Trailer Axle. This switch does not require ignition power to maintain the desired switch setting.



**58. Trailer, Belly Dump**  
Turn switch on to open Trailer Belly Dump.



**59. Trailer, Dump Gate**  
Turn switch on to open Trailer Dump Gate.



**60. Trailer Hotline**  
Turn switch on to supply electrical power to trailer accessories.



**61. Trailer, Suspension Air Dump**  
Turn switch on to deflate Trailer Air Suspension. This switch does not require ignition power to maintain the desired switch setting.



**62. Transmission, Transfer Case**  
Turn switch on to shift the Transfer Case.



**63. Transmission, Transfer Case 2 Speed**  
Turn switch on to shift the 2 Speed Transfer Case.



**64. Winch Clutch**  
Turn switch on to engage Winch Clutch.

## Steering Column Controls Introduction

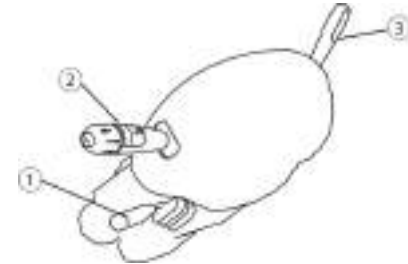

1. Tilt Telescoping Lever
2. Turn Signal Lever
3. Trailer Hand Brake

	<b>NOTE</b>
The ignition key must be turned to ON for the signal/switch to operate.	

The turn signal lever is mounted on the left side of the steering column. The lever controls several functions: turn

## SWITCHES

signal, ID Clearance lights, high beam and windshield wiper control.

### 1. Tilt/Telescoping Steering Column

Depending on your vehicle's configuration, you may have either a Tilt/Telescoping or a fixed steering column.

- The tilt feature allows forward and rearward movement of the wheel.
- The telescoping feature allows you to move the wheel up and down.

To activate these features, locate the Tilt/Telescoping lever.



#### WARNING!

Make all adjustments to the steering mechanism while the vehicle is stopped. Adjusting the Tilt-Telescoping Steering Wheel while the vehicle is in motion could cause loss of control. You wouldn't be able to steer properly and could have an accident resulting in death or personal injury.

To adjust the steering wheel, PUSH and HOLD the lever down fully. Push or pull the wheel to the desired height and angle, then PUSH the lever back into the locked position.

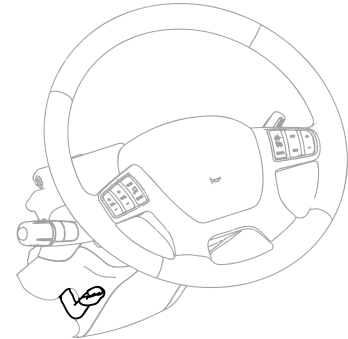

Steering Column Locked

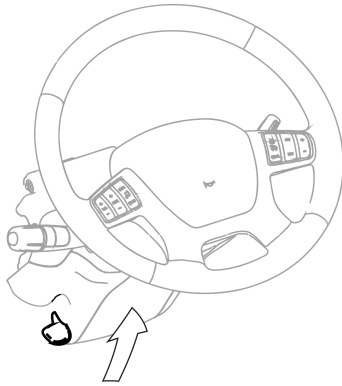

Steering Column Unlocked

**2. Turn Signal/High Beam Switch**

	<b>NOTE</b>
The ignition key must be turned to ON for the signal/switch to operate.	

The lever-action turn signal/high beam switch is located on the left side of the steering column. Each time a turn indicator is activated the buzzer emits a short beep.

**Turn Signals**

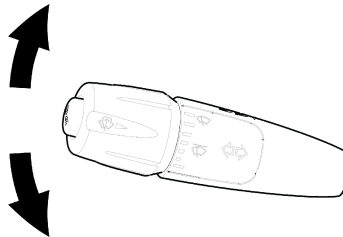

**Turn Signal**

- To signal a right turn, push the lever forward (clockwise).

- To signal a left turn, pull the lever back (counterclockwise).
- Each time the turn indicator is activated the audible warning emits a short beep.

	<b>NOTE</b>
If the vehicle turn signals and turn signal indicators in the dash gauge cluster ever begin flashing at an accelerated rate (115 cycles per minute) when the turn signal lever is in the OFF (center) position, or when a Right/Left turn has been selected, the problem may be related to a failed turn signal switch or turn signal module. In either case, the problem is not a failed bulb. Contact your nearest authorized dealer to have the problem corrected as soon as possible.	

# SWITCHES

3

 <b>WARNING!</b>
After you complete a turn, shut the system off by returning the lever to the “OFF” (center) position. Failure to shut off a turn signal could confuse other drivers and result in an injury accident. An indicator light in the instrument panel will flash until the turn signal is turned off.

## High Beam

 <b>NOTE</b>
The headlights must be ON for the high beam switch to operate.

- To switch your headlights to lower or higher beam, gently pull the turn signal lever, toward the steering wheel, until you hear the switch click and the beam changes. The blue indicator light in the instrument panel will be ON when the high beam is being used.

- To return to previous beam: pull the lever towards the steering wheel again.
- The high beams can be momentarily flashed with or without the headlights being on. To flash the high beams, gently push the headlight lever away from the steering wheel to momentarily turn on the lights.

 <b>NOTE</b>
Continued pressing of the high beam flash will not keep the high beams on.

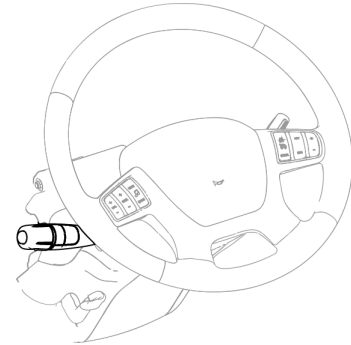

 <b>NOTE</b>
The “flash to pass” functionality of the headlight switch is not available for vehicles manufactured with High Intensity Discharge (HID) headlamps. Please check with local regulations regarding restrictions on using high beam flashing.

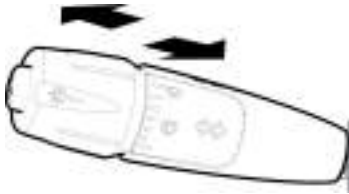

Flash to pass

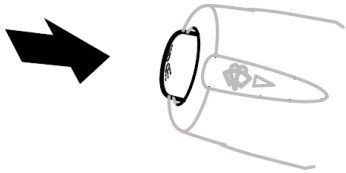

ID and Clearance Lights Flash

### Windshield Wipers/Washer

Your vehicle is equipped with a two-speed, intermittent windshield wiper system. The windshield wiper system is integrated with the exterior lights so that the low beam headlights will turn on when the windshield wipers turn on.

To override this function, turn the headlights on and then off again and the low beams will turn off. Permanently overriding this functionality is attainable via the Settings Menu in the instrument cluster display. Go to Settings - > Wiper Interlock and turn this value to OFF.

A seven-position rotary wiper switch (located on the turn signal lever) operates the windshield wipers and washer. Rotate the end of the turn signal lever to change the wiper mode.

i	NOTE
The ignition key must be turned to ON or ACC for the wiper/washer switches to operate.	



Wiper/Washer

The first position after OFF is the intermittent #1 cycle. The next positions are intermittent #2, #3, and #4. The last two positions are wiper low speed and wiper high speed.

#### To wash the windshield:

Push the rotary wash/wipe knob in (towards steering column), hold for more than 0.8 seconds and then release. hold the knob in to extend

## SWITCHES

3

the washing cycle. After the lever is released, the wipers will shut off automatically or resume the wiper's setting speed.

To activate the wipers for one swipe without activating the washer ("mist" function), push the turn signal lever in (towards the steering column) and release in less than 0.5 seconds. The wipers will perform a single swipe and then resume the wiper's setting speed.



### WARNING!

Clean blades regularly with a damp cloth to remove road film and wax build-up. Do not drive with worn or dirty wiper blades. They can reduce visibility, making driving hazardous which may lead to an injury accident resulting in death or personal injury.



### CAUTION

Do not use antifreeze or engine coolant in the windshield washer reservoir - damage to seals and other components will result.



### CAUTION

If the electric pump is operated for a long period (more than 15 seconds) with a dry reservoir, the pump motor may be damaged.

Check the windshield washing fluid level daily. If necessary, fill to top.

Clean all inside and outside windows regularly. Use an alcohol-based cleaning solution and wipe dry with either a lint-free or a chamois cloth. Avoid running the wiper blades over a dry windshield to prevent scratching the glass. Spray on washer fluid first. A scratched windshield will reduce visibility.

### 3. Trailer Brake Hand Valve

This hand valve, mounted on the steering wheel column, provides air pressure to apply the trailer brakes only. It operates independently of the foot treadle valve. See Using the Brake System on page 4-21, for more instructions on proper use of the Trailer Brake Hand Valve.

## Steering Wheel Controls (Optional)



### CAUTION

Under no circumstances should you attempt to service the steering wheel, clockspring, or any of the electrical wiring in the multiplex system, or any steering components (steering column, steering driveline or steering gear). Tampering with these components may result in an inoperable multiplex system.

This vehicle may be equipped with an optional steering wheel with audio and cruise control button mounted on the spokes of the steering wheel.

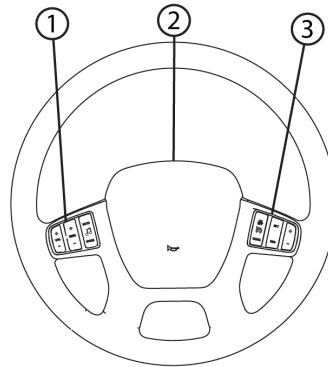

1. Left Switch Pod
2. Horn
3. Right Switch Pod

### System Description

The steering wheel contains controls for commonly used functions so that the operator does not have to take their hands off of the steering wheel to operate.

# SWITCHES

## Operating the System

**Horn** - Depressing the bottom center bar activates the electric horn.

**Cruise Control** - Vehicles with steering wheel controls will have cruise control options on the right hand of the wheel instead of the switches on the dashboard. These optional switches for cruise control include a third switch to allow the operator to accelerate or coast while maintaining cruise control operation. For complete operating instructions, see Cruise Control on page 4-35.

3

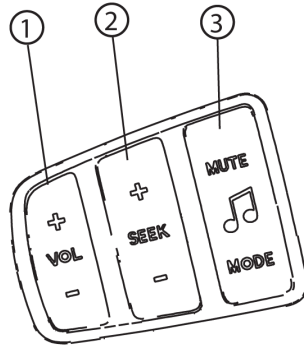

### Left Switch Pod

1. Audio Volume +/-
2. Audio Seek +/-
3. Audio Mute/Mode

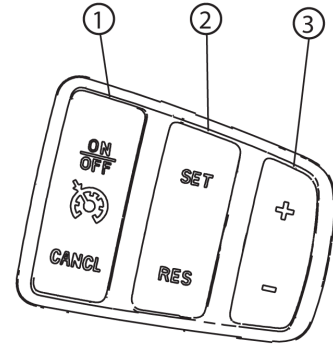

### Right Switch Pod

1. Cruise Control On/Off/Cancel
2. Cruise Control Set/Resume
3. Cruise Control Accelerate/Coast



**WARNING!**

Do not operate the cruise control when operating on road surfaces with poor traction (wet, icy, or snow covered roads) or in heavy traffic. Accelerations caused by the normal operation of the cruise control could cause you to lose control of the vehicle resulting in an injury accident.

**Horn**

To use the electric horn, press the button in the center of the steering wheel, which is the standard location for electric horns. Your vehicle may be equipped with air horns. To operate, pull on the lanyard extending from the overhead header panel.

**Door Mounted Controls****Introduction**

If your vehicle is equipped with power mirrors, the mirror controls will be located on the driver side door pad. Mirrors can be adjusted in 4 directions.

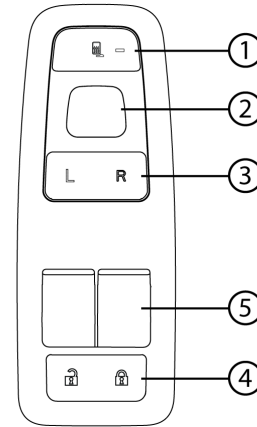

1. Mirror Heat Switch
2. Power Mirror Switch
3. Mirror Selector Switch
4. Power Door Lock Switch
5. Power Window Switch

# SWITCHES

3

 <b>WARNING!</b>
Adjust all mirrors before driving. Adjusting the mirrors while driving can cause you to take your eyes off the road, which could result in an accident. Failure to do so could lead to serious injury or equipment damage.

To provide good visibility, adjust the mirror so the side of your vehicle appears in the inboard part of the mirror.

 <b>WARNING!</b>
Convex mirrors can distort images and make objects appear smaller and farther away than they really are. You could have an accident if you are too close to another vehicle or other object. Keep plenty of space between your vehicle and others when you turn or change lanes. Remember that other objects are closer than they may appear.

## 1. Mirror Heat Switch

Your vehicle may be equipped with optional heated mirrors. Mirror heat is controlled by the mirror heat switch button, which is part of the mirror switch module located on the driver side door pad.

 <b>NOTE</b>
The Mirror Heat switch also controls the optional hood mounted mirror heat.

## 2. Power Mirror Switch

If your vehicle is equipped with power mirrors, the directional controls for both mirrors are located near the top of the driver side door trim pad.

1. Move the mirror selector switch (3) to the right or left from the neutral center position to select the desired mirror for adjustment.
2. Depress the mirror directional control pad (2) in one of its four arrow directions to adjust the mirror in/out or up/down.

 <b>NOTE</b>
After mirror adjustments have been completed, return the mirror selector switch back (3) to the center (neutral) position to prevent unintentional adjustments to the mirrors.

#### **4. Power Door Lock Switch**

Power door lock rocker switches are located on the door pads. To lock or unlock both cab doors as well as a sleeper door, depress any door lock switch at the end that displays a closed or open padlock symbol, respectively, on the switch face.

#### **5. Power Window Switch**

Power window rocker switches are located on the door pads. Depress the switch to open the window or pull up on the switch to close the window. Release the switch to stop window movement. The drivers side window has an express down feature. Pushing on the switch all the way down until the switch bumps will activate the express down feature. Release the button and the window will continue to open until it is completely open.

#### **Exterior Lights Self Test**

To start the Exterior Light Self-Test (ELST) feature:

1. Park the vehicle and set the parking brakes.
2. Insert the key into the ignition, start the engine and allow the vehicle to run through its own Power On Self Test.
3. Press the momentary switch on the dash to start the ELST.

This feature allows the operator to verify and inspect exterior lighting operation typically performed during a pre-trip inspection. When the feature is engaged, via a switch on the dash, it will illuminate the:

- Park lights
- Side marker lights
- Hazard/turn signals

## SWITCHES

---

- Lo beam headlamps
- First set of fog/driving lights

The test will turn those lights off and then illuminate the:

- Park lights
- Side marker lights
- Hi beam headlamps
- Stop/Brake lights

After turning these lights off, the system will resume testing the first set of lights. The light test will eventually stop on its own. The operator may interrupt the test by turning the vehicle off or pressing the switch a second time while the test is running. The operator can verify the light functionality by visibly watching the light from outside the vehicle during the test or can read the instrument cluster for any faults displayed that are lighting related.

## HEATING AND AIR CONDITIONING

### Cab Controls

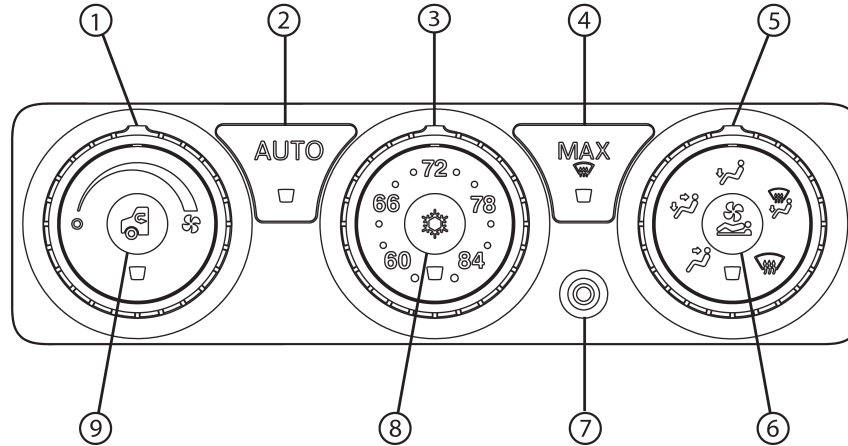

- 1. Fan Control Dial
- 2. AUTO Mode Button
- 3. Temperature Control Dial

- 4. MAX Defrost Button
- 5. Air Distribution Dial
- 6. Sleeper Override Button (for vehicles with a sleeper)

- 7. Temperature Sensor
- 8. Air Conditioner Button
- 9. Outside Air / Recirculation Air Button

# HEATING AND AIR CONDITIONING

## Introduction

Your vehicles heating and air conditioning system operates in three distinct modes; manual, automatic, and maximum defrost. Each mode provides the driver with the greatest level of comfort and convenience while maintaining the flexibility of traditional systems.

The recommended mode for all conditions that do not require windshield defrosting is the automatic mode on page 3-83. This mode is capable of maintaining cab comfort under various driving conditions without driver interaction.

The cab heater and A/C controls are located together in the center of the dash just to the right of the steering column. The sleeper heater and A/C controls are located in the sleeper cabinet.

 <b>WARNING!</b>
Do not drive with visibility reduced by fog, condensation, or frost on the windshield. Your view may be obscured, which may result in death, personal injury, equipment or property damage. For clear visibility and safe driving it is extremely important for you to follow the instructions pertaining to the function and use of the ventilation/heating and defogging/defrosting system. If in doubt, consult your dealer. Maximum heating output and fast defrosting can be obtained only after the engine has reached operating temperature.

 <b>WARNING!</b>
Exhaust fumes from the engine contain carbon monoxide, a colorless and odorless gas. Do not breathe the engine exhaust gas. A poorly maintained, damaged or corroded exhaust system can allow carbon monoxide to enter the cab. Entry of carbon monoxide into the cab is also possible from other vehicles nearby. Failure to properly maintain your vehicle could cause carbon monoxide to enter the cab, resulting in death or personal injury.

**⚠ WARNING!**

Never idle your vehicle for prolonged periods of time if you sense that exhaust fumes are entering the cab. Investigate the cause of the fumes and correct it as soon as possible. If the vehicle must be driven under these conditions, drive only with the windows open. Failure to repair the source of the exhaust fumes may result in death, personal injury, equipment or property damage.

**i NOTE**

Keep the engine exhaust system and the vehicles cab ventilation system properly maintained. It is recommended that the vehicles exhaust system and cab be inspected:

- By a competent technician every 15,000 miles,
- Whenever a change is noticed in the sound of the exhaust system,
- Whenever the exhaust system, underbody, or cab is damaged.

**i NOTE**

To allow for proper operation of the vehicle ventilation system, keep the inlet grille at the base of the windshield clear of snow, ice, leaves and other obstructions at all times.

**⚠ CAUTION**

Do not stay in the vehicle with the engine running or idling for more than 10 minutes with the vehicle's Heater and A/C ventilation system in RECIRC or at LOW FAN SPEED. Even with the ventilation system on, running the engine while parked or stopped for prolonged periods of time is not recommended.

**i NOTE**

When idling for short periods of time:

- Set the heating or cooling system to Heat or A/C
- Set the fan to Medium or High speed
- Set the controls to FRESH AIR

 NOTE
If you are required to idle your vehicle for long periods of time, install an auxiliary heater or automatic idle control. These auxiliary devices can reduce fuel consumption and save you money.

 NOTE
If you are parked next to idling vehicles, move your vehicle or do not stay in your vehicle for prolonged periods of time.

## Manual Control Mode

The manual mode is the default mode when the heating and air conditioning system is turned on. The fan speed, air temperature, and air outlets are selected using the dials on the controller.

### Adjusting the settings:

**Step 1:** To adjust the fan speed, turn the fan control dial clockwise to increase speed or counterclockwise to decrease speed. Setting the fan dial to “O” turns the HVAC system off.

**Step 2:** To adjust the temperature setting, turn the temperature control dial to the desired temperature. The system automatically adjusts the outlet air temperature to achieve the desired cab temperature.

**Step 3:** To adjust the air distribution, turn the air distribution dial to the desired position as indicated by the graphics.

For vehicles with a sleeper, the cab control can be used to activate/deactivate the sleeper HVAC using the button inside the mode dial.

The temperature of the air from the vents will fluctuate as the vehicle works to achieve the chosen cab temperature. Note that in manual mode the system does not engage the A/C compressor automatically. To engage the air conditioning, press the button inside the temperature dial. To engage recirculation of cab air, press the button inside the fan speed dial.



## Automatic Control Mode

Your vehicle's air conditioning system is equipped with an automatic button that provides complete cab climate control without driver interaction. When selected, the system will manipulate the air distribution, air temperature, fan speed, A/C compressor, and cab air recirculation to achieve the comfort level selected on the temperature dial. The button that enables automatic mode is labeled AUTO. The system will remain in automatic mode until the driver adjusts the dials on the control.

AUTO

Adjust the temperature knob and the system will respond to obtain the selected comfort level as quickly as possible.

### Using the automatic mode:

**Step 1:** Turn on HVAC by rotating fan speed control clockwise.

**Step 2:** To engage automatic mode, press the AUTO button.

**Step 3:** To adjust cab temperature, rotate the temperature dial to the desired temperature. The system automatically adjusts to achieve the desired cab temperature.

The system will achieve the comfort level associated with the selected temperature on the temperature dial. Therefore, depending on the specific environmental conditions, the air temperature can be slightly higher or lower than the set point. This is a normal function of the AUTO mode and is not to be mistaken for a malfunctioning system.

The AUTO function uses a sun light sensor to measure the amount of sunlight entering the cab. This sensor

is located at the base of the windshield on the driver's side of the instrument panel. Do not block this sensor.

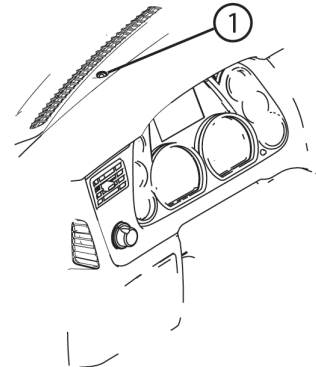

1 Sunlight Sensor

### Partial Automatic

During AUTO mode the operator may override any setting and operate in a partial automatic mode. This can be done via the dials and/or buttons

# HEATING AND AIR CONDITIONING

3

on the HVAC control. In the partial automatic mode, the AUTO button indicator will cease to be illuminated. Instead, the indicator of the adjusted setting will illuminate.

For example, if the driver adjusts the fan dial while in AUTO mode, the fan dial indicator will illuminate and fan speed will adjust to the setting of the dial. However, the temperature and air outlet settings will continue to function automatically. Similarly, if user adjusts the air distribution setting while in AUTO mode, the air distribution dial indicator will illuminate and the distribution will adjust to the setting of the dial. The fan and temperature settings will continue to function automatically.

## Economy Function

An economy function is also available in partial automatic mode. In this mode the system will operate in AUTO mode

without the use of the A/C compressor. The operator may select economy by initiating AUTO mode and then pressing the A/C button to disengage the compressor. The indicators for A/C compressor and AUTO mode do not illuminate while operating in economy mode.

## MAX Defrost Mode

The heating and air conditioning system provides for one touch windshield defrosting. Certain driving conditions will cause fog or ice to form on the windshield. By pressing the MAX defrost button, the HVAC system will automatically adjust the blower speed, air temperature, and air outlet distribution to maximize clearing of the windshield. The system will remain in this mode until the driver presses the button again or adjusts the dials.



Note that the air temperature in MAX defrost mode will be set to the warmest temperature setting. This setting helps to clear the windshield of ice and fog more quickly. Outside air mode and A/C compressor are also active to maximize performance.

## Buttons and Dials

### Fan Speed Control Dial

The fan speed is adjusted by rotating the dial clockwise to increase speed or counterclockwise to decrease speed. Setting the fan dial to “O” turns the HVAC system off.



#### Fan Speed Adjustment

The source of air entering the cab can be set to either outside air or recirculation air using the button inside the fan speed control dial. Recirculated air is automatically selected in defrost modes.



#### Outside Air/Recirculation Air Button

### Air Distribution Dial

The mode of air distribution inside the cab is set using the air distribution dial. Five icons on the dial indicate the primary mode options. The driver may also select a secondary mode in between the primary modes indicated by points on the dial. Airflow is provided to the side windows in all modes.



#### Panel Vents



#### Panel and Floor Vents



#### Floor Vents



#### Floor and \*Defrost Vents



#### \*Defrost Vents

\*Automatically engages outside air and A/C compressor.

Power to the sleeper HVAC unit can be toggled using the button inside the air distribution dial. When activated, the indicator on the button illuminates. The sleeper HVAC unit will function to the settings of the sleeper control.



#### Sleeper Override Button (for vehicles with a sleeper)

# HEATING AND AIR CONDITIONING

## Temperature Control Dial

The cab temperature is set using the temperature control dial. The operating range is 60°F (16°C) and 84°F (28°C). Adjustments of 2° increments.



**Temperature Control Set Point**

The button inside the temperature control dial engages the A/C compressor. When activated the indicator on the button will illuminate. During AUTO mode, the A/C button indicator will remain illuminated at all times even though the compressor may be cycling.



**Air Conditioner Button**



### NOTE

Fan control dial must also be in the ON position to engage the A/C compressor. A/C engages automatically in AUTO, defrost and floor/defrost.

## Operating Tips Defrosting and Defogging the Windshield

The cab windshield and side windows can be cleared of ice and fog in two ways. The first is to use the MAX defrost mode (See MAX defrost section). The second is to manually adjust the air distribution dial to the defrost position.



### CAUTION

During extreme cold weather, do not blow hot defroster air onto cold windshields. This could crack the glass. Turn the Air Flow Control Dial to Defrost and adjust the fan speed accordingly while the engine warms. If the engine is already warm, move the Temperature Control Dial to cool, then gradually increase the temperature when you see that the windshield is starting to warm up. Failure to comply may result in equipment damage.

### Manual Windshield Defrosting/Defogging

The manual defrost/defogging mode differs from the MAX defrost mode by allowing the driver to select an air temperature other than full heat. This allows the driver to maintain a constant cab temperature while defrosting the windshield. Note however that performance may be reduced.

**Step 1:** Adjust the fan speed to high by rotating the fan control dial clockwise.

**Step 2:** Set the air distribution dial to the defrost mode setting. This automatically engages the outside air and A/C compressor.

**Step 3:** Adjust the temperature dial to add heat as needed. For maximum performance, adjust the temperature to maximum heat by rotating the temperature dial clockwise.

The driver may also use the floor/defrost setting on the air control

dial to maintain a clear windshield while providing heat to the floor. This setting may be helpful in conditions where the windshield re-fogs. To increase the effectiveness of the defroster, engage the A/C compressor.

# HEATING AND AIR CONDITIONING

3

## For Maximum Cooling

**Step 1:** Adjust the fan speed to high by rotating the fan control dial clockwise.

**Step 2:** Set the air distribution dial to the panel setting.

**Step 3:** Adjust the air temperature to maximum cool by rotating the temperature dial counterclockwise.

**Step 4:** Engage the A/C compressor by pressing the air conditioner button.

**Step 5:** Set the air source to recirculation mode by pressing the outside air / recirculation air button. The button indicator light should be illuminated.

## For Maximum Heating

**Step 1:** Adjust the fan speed to high by rotating the fan control dial clockwise.

**Step 2:** Set the air distribution dial to the floor setting.

**Step 3:** Adjust the air temperature to maximum heat by rotating the temperature dial clockwise.

i	NOTE
The engine must be at operating temperature for maximum heating. If operating in AUTO mode, heating airflow is not allowed until the engine warms sufficiently to provide required coolant temperatures.	

## Air Dehumidification

The HVAC system can be used to reduce the humidity level of the cab and clear fog from the windshield.

**Step 1:** Adjust fan speed to the desired airflow setting.

**Step 2:** Engage the A/C compressor by pressing the air conditioner button.

**Step 3:** Set the air source to outside air mode by pressing the outside air / recirculation air button. The button indicator light should NOT be illuminated.

i	NOTE
That the A/C compressor may not engage when the outside temperature is below 34°F (1°C).	

## Cab Air Distribution

Equal distribution of air is important in maintaining a constant cab interior temperature. For best performance, all vents should remain open to allow the AUTO mode to function properly.

To maintain the selected cab temperature the AUTO mode may provide an air temperature from the vents that differs from the temperature set point. To ensure proper operation, it is recommended that the driver redirects the air instead of adjusting the temperature set point or closing the vent. The system may have difficulties in obtaining the desired cabin temperature if the temperature setting is repeatedly changed.

## Outside Air / Recirculation Air

Selecting air recirculation mode completely isolates the cab interior from the outside air. This mode is helpful in preventing dust, pollen, and odors from entering the cab. Additionally, recirculation mode can reduce the amount of time needed to cool down the vehicle while in maximum cool down. Note that the mode may increase fogging on the windshield. A coarse air filter is provided for recirculation air and is located under the IP.

The outside air mode provides for 100% outside air into the cab. This mode is helpful with windshield defogging. A pleated air filter located under hood provides filtration for dust, pollen, and debris. If equipped, your vehicle may also provide for ember filtration or fine particulate filtration.

## Sleeper Heater - A/C Controls (optional)

### Sleeper Controls

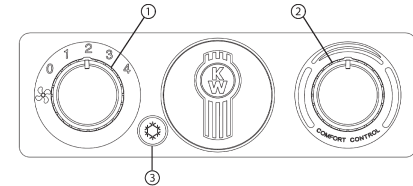

1. Fan Control Dial
2. Temperature Control Dial
3. Air Conditioner Button

Unlike the cabin air temperature controls, the sleeper temperature control will alter the air temperature based on the knob setting. The temperature control is not keyed to specific temperatures. Turning counterclockwise means cooler than it is now. Clockwise means warmer than it is now. Once the desired

## HEATING AND AIR CONDITIONING

---

temperature is reached, the system will maintain it automatically.

A separate switch on the dash HVAC unit will send power to the “bunk” or sleeper control unit. The button on the cab HVAC unit must be pressed and in the mode to use the sleeper controls.

3

The sleeper control unit has three controls:

1. Air Speed Control
2. Air Conditioner Compressor On/Off
3. Air Temperature Control

i	NOTE
	The sensor is located on the sleeper heater - A/C control panel and measures the sleeper air temperature at the panel. There will be a time delay between temperature control adjustment and sleeper air temperature change. Also, be careful of any heat source, which could affect the air temperature by the sensor. Avoid hanging items (e.g. shirt, jacket, etc.) which could block the air flow to the sensor.



## ACCESSORIES

## Sleeper Alarm Clock

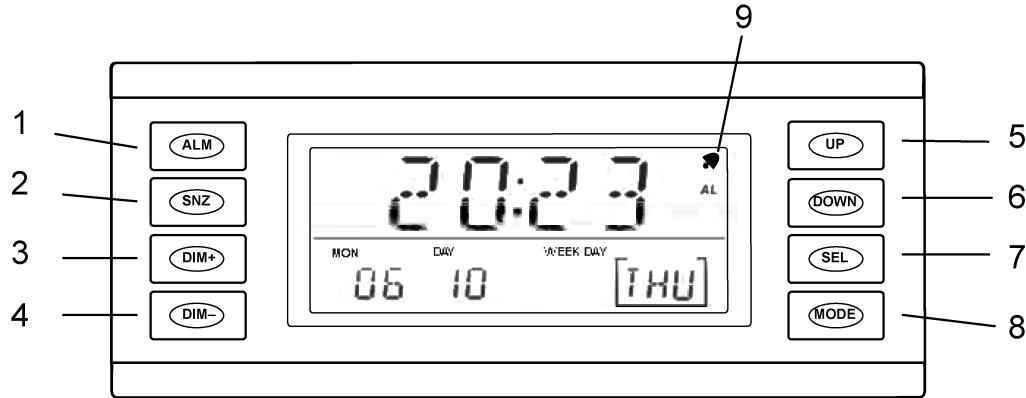

- |  |  |  |
|--|--|--|
| 1. Alarm - press to turn on the alarm                | 5. Increase value of setting   | time/date and or alarm setting                                   |
| 2. Snooze - press to snooze the alarm bell           | 6. Decrease value of setting   | setting  |
| 3. Dimmer/brighter - press to make display brighter  | 7. Select - press to choose the setting being changed while adjusting the either the time or the alarm | 9. Active alarm icon - alarm is activated when this icon appears |
| 4. Dimmer/darker - press to make display less bright | 8. Time and Alarm value setting - press to change  |  |

## ACCESSORIES

---

### Setting System Time

i	NOTE
The year “2010” will display when setting the clock for the first time or if battery power had been lost.	

1. Press the MODE button until the screen begins flashing.
2. Use the UP and DOWN buttons to adjust the value.
3. Press the SEL button to adjust the next setting and use the UP and DOWN buttons to change the value.
4. Repeat this for all settings. The alarm clock will scroll in the following order each time you press the SEL button.
  - a. Year
  - b. Month
  - c. Day

- d. Hours
  - e. Minutes
5. To exit and save your settings, press the MODE button once you have set the minutes.

### Setting System Alarm

1. Press the MODE button twice until the screen displays the AL icon.
2. Use the UP and DOWN buttons to adjust the setting.
3. Press the SEL button to adjust the next setting and use the UP and DOWN buttons to change the setting.
4. Repeat this for all areas. The alarm clock will scroll in the following order each time you press the SEL button.
  - a. Hours
  - b. Minutes
5. To exit and save your settings, press the MODE button once you have set the minutes.

### Turning the Alarm On/Off

Press the ALM button to turn the alarm on and off. The icon (9) will illuminate when the alarm is active.

When time reaches the set time the alarm will ring. If the snooze button is not pressed, the alarm will continue ringing for 15 minutes then will automatically stop. Pressing any other button except SNZ (2) will turn the alarm off.

### Snooze Operation

When the alarm is ringing press the SNZ button (2) to silence the alarm for 9 minutes. The small bell icon (9) will flash until the alarm is shut off. The snooze button can be used as many times as desired.

### Dim Control Operation

Press the DIM+ or DIM- buttons (3, 4) to change the brightness of the display.

## ACCESSORIES

### Radio (Option)

As an option, your vehicle has either an AM/FM Stereo Receiver, which may or may not have a CD, or may have the stereo system integrated with your Navigation and telematics unit.

3

Other radio options include a bluetooth or satellite receiver.

For instructions on how to operate your particular radio, see the supplemental operating manual for those units.

### Cigarette Lighter and Ashtray (Option)

	<b>NOTE</b>
The cigarette lighter will operate with the ignition key in either the OFF, ACC (accessory), or ON position.	

This vehicle comes standard with two cupholders and power ports located in the center of the dashboard. This vehicle may have the optional ashtray insert (for the cupholder) and the optional cigarette lighter in a power port.

To operate, push in on the knob end of the lighter. After a few moments, the lighter will automatically pop out, glowing hot and ready to use. After use, insert the lighter back into the socket without pushing all the way in.

The socket of the cigarette lighter may be used to operate 12 volt, 15 ampere

appliances, such as a hand spotlight or small vacuum cleaner.

	<b>WARNING!</b>
Do not place paper or other combustible substances in an ashtray, it could cause a fire. Keep all burnable materials, besides smoking materials, out of the ashtray. Failure to comply may result in death, personal injury, equipment or property damage.	

	<b>WARNING!</b>
Do not exceed the voltage/amperage capacity of the cigarette lighter. It could result in a fire. Follow all warnings and instructions in the operator's manual for the appliance you are using. Failure to comply may result in death, personal injury, equipment or property damage.	

## Cab Storage

### Glove Box

A glove box is provided to store important documents, the vehicle literature set (including this Operator's Manual) and other related materials.

 <b>WARNING!</b>
<p>Do not drive with the glove box open, it can be dangerous. In an accident or sudden stop, you or a passenger could be thrown against the cover and be injured. To reduce the risk of personal injury during an accident or sudden stop, keep the glove box closed when the vehicle is in motion.</p>

You can choose from a variety of other interior storage options to store your personal supplies or small tools:

- center console
- map pocket on the door
- overhead storage compartments

 <b>WARNING!</b>
<p>Do not carry loose objects in your cab, it can be dangerous. In a sudden stop, or even going over a bump in the road, they could fly through the air and strike you or a passenger. You could be injured or even killed. Secure all loose objects in the cab before moving the vehicle. Carry any heavy objects such as luggage in the exterior storage compartment and close it securely.</p>

## Appliances

If your vehicle is equipped with a television, or other appliance, be sure they are compatible with your vehicle's electrical system. Secure them in the cab so they cannot come loose in a sudden stop.

 <b>WARNING!</b>
<p>In a sudden stop or collision a heavy object in your cab could strike you or anyone with you. You could be injured or even killed. Secure any appliance (such as a radio, or TV) you add to your sleeper or cab.</p>

## ACCESSORIES

### Ignition Key Switch

The ignition key switch (located to the left of the steering column) has four positions: ACC (Accessories), OFF, ON, and START.



**OFF:** In this position all accessories are OFF (except those listed below) and you can remove the key.

The following lights and accessories have power when the key is in the OFF position:

- brake lights
- emergency hazard flasher
- dome and courtesy lamps (on doors)
- electric horn
- cigarette lighter
- tail lights
- marker lamps
- headlights
- radio station memory
- instrument lights
- auxiliary power
- instrument panel memory settings

**ACC (Accessory):** With the key in this position you can play the radio, defrost mirrors (if equipped with mirror heat) or use other accessories.

**ON:** In the ON position all circuits are energized. Panel warning lights will light and the buzzer will sound until (1) the engine is started, (2) normal oil operating pressure is reached, and (3) air brake system pressure is above 65 psi (441 kPa). In this position, the ignition key cannot be removed.

**START:** Turn the key to this position to start your engine. Release the key after the engine has started. For complete engine starting procedures, see Operating The Engine on page 4-5.

## Vehicle Telematic System

Your vehicle may be equipped with an onboard telematics system. This system is a Global Positioning Satellite (GPS)-linked computer. It receives input from multiple sources to locate your vehicle. Read and understand the Supplemental Telematics and Navigation System Owner's Manual and observe the Warnings, Cautions, and Notes that follow before using the system.



### WARNING!

Verify legal weight and height restrictions for the route suggested by the telematic system. Failure to verify height restrictions could lead to causing death, personal injury or property damage. Failure to verify weight restrictions could result in a traffic infraction.



### WARNING!

Only glance at the system monitor while driving. Prolonged periods of viewing while driving could result in an accident involving death or personal injury.



### WARNING!

Do not program the telematic system while driving. Always stop your vehicle when programming or changing the settings on the telematic system. Programming the system while driving can cause you to take your eyes off the road, which could result in an accident involving death, personal injury or equipment damage.



### WARNING!

Regardless of how and where the navigation system directs you, it is your responsibility to operate the vehicle in a safe and legal manner. Failure to comply may result in death, personal injury, equipment or property damage.



### WARNING!

Ensure the volume level of all audio devices is set to a level that still allows you to hear outside traffic and emergency vehicles. Failure to comply may result in death, personal injury, equipment or property damage.



### CAUTION

Do not rely on the telematic system to route you to the closest emergency services. Not all emergency services are in the database.

i	NOTE
<p>The map database is the most current available at the time of production. The database is designed to provide you with route suggestions and does not take into account the relative safety of a suggested route or of factors that may affect the time required to reach your destination. See the Supplemental Navigation System Owner's Manual for more information.</p>	

### Care of the Display Screen

From time to time it may be necessary to clean the display screen. To clean the screen, dampen a clean, soft, lint-free cloth with water only. A mild glass cleaner **that does not contain alcohol or ammonia** may also be used. Cleaners that contain alcohol and/or ammonia will eventually dry-out, crack and "yellow" the screen. Wipe the screen gently back and forth. You can also use a commercial cleaner especially designed for LCD screens.

### Screen Display On/Off

1. Press and hold the POWER/LIGHT button for approximately 1 second.
2. After the display has been turned on, the following Warning/Informational screen will appear:



## Warning/Informational Screen

**WARNING**

**Do not let this device distract you while driving. Always concentrate on you driving. Distractions could cause an accident resulting in injuries to you or others.**

**IMPORTANT**

Disclaimer: Map data may be inaccurate and navigation routes may not be available for larger size vehicles.

Regardless of how and where the navigation system directs you, it is your responsibility to operate the vehicle in a safe and legal manner.

**Note: Before using this system, read the Owner's Manual and learn how it operates. Some functions of this system will not operate when the truck is moving.**

3. After reading the information, touch the **T** in the upper right corner of the screen with your finger indicating you acknowledge and understand the

information. The MENU screen will automatically appear next.

4. To turn the system off, press and hold the POWER/LIGHT button for 3 seconds.

**Disclaimer**

The vehicle manufacturer is not responsible for erroneous map data, misrouting or any downtime or other damages associated with or arising out of the use of the Navigation System.

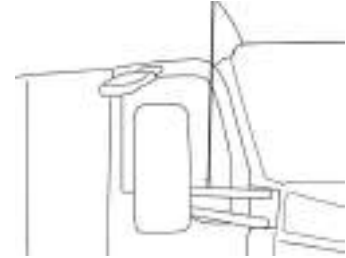
**Passenger Side 'down' Mirror**

A mirror is located above the passenger door that provides a quick view of the blind spot created by the passenger door.

## ACCESSORIES

---

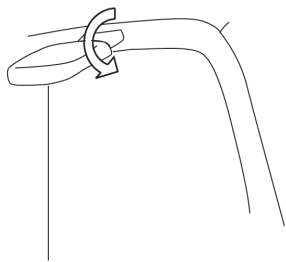

3

Rotate the mirror up or down to get the desired view.

## STARTING AND OPERATING

Introduction . . . . .	4-5
Normal Weather . . . . .	4-5
Cold Weather . . . . .	4-6
Engine Block Heater (Option). . . . .	4-6
Engine Warm-up . . . . .	4-7
Ether Metering Equipment . . . . .	4-10

## OPERATING THE ENGINE

Stationary PTO Operation . . . . .	4-12
Engine Fan Control . . . . .	4-12
Winterfronts . . . . .	4-13
Engine Control Display . . . . .	4-14

## OPERATING THE TRANSMISSION

Operating Hydraulic Clutch (Manual Transmission)	4-15
Operating Manual Transmissions . . . . .	4-15
Putting the Vehicle in Motion . . . . .	4-16
Automatic and Automated Transmissions . . . . .	4-19

Auxiliary Transmission . . . . .	4-20
More Transmission Tips . . . . .	4-20

## **OPERATING THE BRAKE SYSTEM**

Introduction . . . . .	4-21
Retarders . . . . .	4-33

## **CRUISE CONTROL**

Cruise Control Switch . . . . .	4-35
Adaptive Cruise Control (Optional) . . . . .	4-37

## **AXLE**

Differential Lock . . . . .	4-40
Dual Range (Two-Speed) Rear Axle . . . . .	4-41
Auxiliary Axles - Pusher or Tag . . . . .	4-43

## **SUSPENSION**

Air Suspension Height/Air Pressure . . . . .	4-49
Driving with Deflated Air Springs . . . . .	4-50

## **AFTER-TREATMENT SYSTEM**

Introduction . . . . .	4-51
------------------------	------

**DRIVING TIPS AND TECHNIQUES**

Introduction . . . . . 4-52  
Coasting . . . . . 4-52  
Descending a Grade . . . . . 4-53  
Engine Overspeed . . . . . 4-53  
Fuel - Excess Consumption . . . . . 4-55

**SLEEPER BUNKS**

Sleeper Bunk. . . . . 4-58

**STOPPING THE ENGINE**

Before Stopping the Engine . . . . . 4-60  
Refueling . . . . . 4-60  
Refuel Before the Final Stop . . . . . 4-61  
Final Stop . . . . . 4-62



## STARTING AND OPERATING

### Introduction

Since each vehicle is custom-equipped, all engine operation instructions in this manual are general. You will want to consult the manual for your engine to find out details about your specific engine's needs. You may need to use a slightly different procedure from the one outlined here.

Below are instructions for both normal-temperature starting and cold-weather starting.

### Normal Weather

When the outside temperature is above 50° F (10° C), you can use the following procedure:

1. Set the parking brake.
2. Put your main transmission in Neutral.
3. Disengage (depress) the clutch (with manual transmission).
4. Turn the key switch to ON.

	<b>CAUTION</b>
Never operate the starter motor while the engine is running. The starter and flywheel gears could clash or jam, severely damaging them.	

	<b>NOTE</b>
Some starters are equipped with over-crank protection. Check the "Engine Operation and Maintenance Manual" for details.	

5. Turn the ignition key to the START position. If the engine does not start within 30 seconds, release the ignition switch. To avoid overtaxing the starter motor or the batteries, don't use the starter for more than 30 seconds. Let the starter motor cool and the batteries recover for two minutes before trying again. If the engine still won't start after a couple of tries, check the fuel lines for possible fuel starvation or air leaks. Starting failure may mean fuel isn't reaching the injectors.
6. As soon as the engine starts, begin to watch the oil pressure gauge. Check your engine manufacturer's

## STARTING AND OPERATING

4

manual for the right pressure for your engine. If the oil pressure doesn't rise within a few seconds, stop the engine. Find out what is wrong before restarting the engine.

7. Slowly engage (release) the clutch after the engine has started.
8. Wait for the oil pressure gauge to reach normal operating pressure before operating the vehicle or idling faster than 1000 rpm.

### Cold Weather

In cold weather, fast engine starting helps relieve the loads on the electrical system and cranking motor. Using the special cold starting equipment will help starting. If you follow a few simple guidelines, you will extend the service life of your engine:

- Keep the electrical system in top condition.
- Use the best quality fuel of the recommended grade.
- Use recommended engine lubricating oil.
- For manual transmissions and auxiliary transmissions, leave the transmission in neutral and allow the transmission lubricating oil to warm up (approximately 3-5 minutes) before operating vehicle.

### Engine Block Heater (Option)

To preheat the engine before starting, plug the optional engine block heater into a properly grounded AC electrical source. Do not start the engine with the heater plugged in.



#### WARNING!

Engine block heaters can cause fires which may result in death, injury and/or property damage if not properly maintained and operated. Regularly inspect the engine block heater wiring and connector for damaged or frayed wires. Do not use the heater if there are any signs of problems. Contact your authorized dealer or the manufacturer of the heater if you are in need of repairs or information.



	<b>CAUTION</b>
<p>Always unplug heater before starting the engine. Damage to the cooling system could occur if the heater is not turned OFF (unplugged).</p>	

Depending on engine make, when the temperature falls below -10° F (-24° C), the block heater is required.

- Use a solution of half ethylene glycol antifreeze and half water for best heater performance. Do not exceed 65 percent concentration of antifreeze, as a shortened heater life will result. See Engine Cooling System on page 5-72, for more information.
- After servicing the cooling system, operate the vehicle for a day or two before using the heater. Trapped air inside the engine needs time to escape.

## Engine Warm-up Engine

The purpose of engine warm-up is to allow oil film to be established between pistons and liners, shafts and bearings while your engine gradually reaches operating temperature.

### Warm-up Procedure

1. After you've started your engine, idle it at approximately 600 RPM while you check:
  - a. oil pressure
  - b. air pressure
  - c. alternator output
2. After a few minutes of idling at 600 RPM, increase your idle speed to 900 or 1000 RPM. Continue your warm-up. This procedure allows oil to warm and flow freely while pistons, liners, shafts, and bearings expand

slowly and evenly. In extremely cold temperatures, you may have to increase idle speed.

	<b>NOTE</b>
<p>In colder climates where the temperature is often below freezing, the warm-up for turbocharged engines is especially important. Chilled external oil lines leading to the turbocharger will slow the oil flow until the oil warms, reducing oil available for the bearings. Watch the engine oil temperature or pressure gauge for a warming trend before increasing engine idle speed (RPM).</p>	

3. Continue the engine warm-up until the coolant temperature reaches at least 130° F (54° C). At this temperature, you can use partial throttle. Wait until the coolant temperature is at least 160° F (71° C) before operating at full throttle.

## STARTING AND OPERATING

4

 <b>WARNING!</b>
Exhaust fumes from the engine contain carbon monoxide, a colorless and odorless gas. A poorly maintained, damaged, or corroded exhaust system can allow carbon monoxide to enter the cab or sleeper. Failure to properly maintain your vehicle could cause carbon monoxide to enter the cab and cause death or personal injury.

 <b>WARNING!</b>
Never idle your vehicle for prolonged periods of time if you sense that exhaust fumes are entering the cab. Investigate the cause of the fumes and correct it as soon as possible. If the vehicle must be driven under these conditions, drive only with the windows slightly open. Failure to repair the source of the exhaust fumes may lead to death or personal injury.

 <b>CAUTION</b>
The use of a winterfront can result in excessive engine coolant, oil, and charge air (intake) temperatures, which can lead to overheating and possible engine damage. If you must use a winterfront: <ul style="list-style-type: none"><li>• Refer to the “Engine Operation and Maintenance Manual” for operating restrictions and recommendations.</li><li>• Use only a winterfront available from your dealer that is compatible with an EPA-compliant engine cooling system. These winterfronts are specifically designed for use with new grill snap patterns.</li></ul>

 <b>NOTE</b>
Keep the engine exhaust system and the vehicle’s cab/sleeper ventilation system properly maintained. It is recommended that the vehicle’s exhaust system and cab/sleeper be inspected: <ul style="list-style-type: none"><li>• By a competent technician every 15,000 miles,</li><li>• Whenever a change is noticed in the sound of the exhaust system,</li><li>• Whenever the exhaust system, underbody, cab or sleeper is damaged.</li></ul>

	NOTE
	<ul style="list-style-type: none"><li>• Do not stay in the vehicle with the engine running or idling for more than 10 minutes with the vehicle's Heater and A/C ventilation system in RECIRC or at LOW FAN SPEED. Even with the ventilation system On, running the engine while parked or stopped for prolonged periods of time is not recommended.</li><li>• If other vehicles are parked next to you idling, move your vehicle or do not stay in your vehicle for prolonged periods of time.</li></ul>

	WARNING!
	<p>To reduce the chance of death or personal injury and/or vehicle damage from overheated engines, which can result in a fire, never leave the engine idling without an alert driver present. If the engine should overheat, as indicated by the engine coolant temperature light, immediate action is required to correct the condition. Continued unattended operation of the engine, even for a short time, may result in serious engine damage or a fire.</p>

	CAUTION
	<p>Do not allow your engine to idle, at low rpm's (400–600 rpm), longer than five minutes. Long periods of idling after the engine has reached operating temperatures can decrease engine temperature and cause gummed piston rings, clogged injectors, and possible engine damage from lack of lubrication. The normal torsional vibrations generated can also cause transmission wear.</p>

## Idling the Engine

Under most circumstances, idling your engine for long periods merely wastes fuel. In severe arctic weather conditions, however, you may need longer idling to be sure all parts of your engine are fully lubricated.

# STARTING AND OPERATING

## Transmission

In cold weather [below 32° F (0° C)], you may find shifting sluggish when you first start up. Transmission warm-up is especially important at this time, but it is always a good idea to warm-up your transmission before starting out on the road. To warm-up the transmission, follow these procedures.

4

To warm-up the transmission lubricating oil during engine warm-up, with a single transmission (manual and automatic):

1. Put the transmission in Neutral.
2. Release the clutch pedal (manual only) and operate the transmission in neutral for 3 to 5 minutes prior to operating the transmission in either forward or reverse range.
3. If you have a two-transmission combination:

- a. Put the main transmission in gear.
- b. Put the auxiliary transmission in Neutral. This will allow the transmission countershaft to turn, agitating the oil and warming it.

## Ether Metering Equipment



### WARNING!

Ether starting fluid is flammable and poisonous. Do not smoke near ether or ether equipment, do not ingest ether fluid and wear safety goggles when handling ether fluid. Follow all safety literature provided with your ether equipment. Failure to take these precautions may result in death, personal injury.



### WARNING!

Do not move or relocate the ether cylinder or tubing from its original installation. It must be mounted to protect it from engine exhaust heat and from moving parts which could damage it. Failure to comply may result in death, personal injury, equipment or property damage.



### WARNING!

Do not store the spare cylinder in the cab. Failure to comply may result in death, personal injury, equipment or property damage.

Do not smoke when testing, installing, or servicing an ether starting unit. Service it in a well-ventilated area away from heat, open flames, or sparks.

If swallowed, do not induce vomiting. Call a physician immediately.

Wear goggles to avoid getting fluid in your eyes. Avoid getting it on your skin and avoid breathing the fumes. If fluid does get in your eyes or fumes irritate your eyes, flush for 15 minutes with large amounts of clean water. Contact an eye specialist.

In warm weather, when you will not need the ether starting system, remove the ether bottle from your truck and

store it safely. Return the protective cap to the bottle mounting connector.

For more helpful starting information, refer to the engine manual that came with your vehicle.

Ether injected into the engine cylinder during cold weather startup will help the engine start faster. Using ether during cold weather startup will result in reduced demands on the batteries and the starter motor.

When you turn the ignition switch to the START position, the cranking motor and the ether system are engaged. When needed, starting fluid is released from a pressurized cylinder, flows through a valve and tubing, and sprays from a nozzle in you engine's air intake system.

## OPERATING THE ENGINE

### OPERATING THE ENGINE

#### Stationary PTO Operation

The cruise control buttons for this vehicle may be used to control the engine rpm when the vehicle is stationary and the operator wants to use the PTO on the engine. Use the cruise control options in the same manner as with the vehicle in motion, but instead of setting vehicle speed, the engine speed (RPM) is set instead.

#### Setting Idle Speed

1. Ensure parking brakes are applied.
2. Ensure transmission is in Neutral.
3. Engage PTO per the manufacturer's operating instructions.
4. Move the ON/OFF switch to the "ON" position.

5. Toggle the SET/RESUME switch to obtain the desired engine rpm.

#### Cancelling Cruise Control

You can cancel cruise control in any of these ways:

- Tap the brake pedal.
- Tap the clutch pedal.
- Move the ON/OFF switch to the "OFF" position.

#### Engine Fan Control



The engine fan can be turned ON using a switch that is mounted on the accessory switch panel. This lets you set the fan to manual or automatic operation.

- With the ignition key turned ON and the fan switch in the MANUAL position, the engine fan will be ON regardless of engine temperature.
- With the engine fan switch in the AUTO position, the engine fan will automatically turn ON when the engine computer sends a signal requiring the engine fan to be on.



## WARNING!

Do not work on or near the fan with the engine running. Anyone near the engine fan when it turns on could be injured. If it is set at MANUAL, the fan will turn on any time the ignition key switch is turned to the ON position. In AUTO, it could engage suddenly without warning. Before turning on the ignition or switching from AUTO to MANUAL, be sure no workers are near the fan.



## CAUTION

The fan or equipment near it could be damaged if the fan turns on suddenly when you do not expect it. Keep all tools and equipment away from the fan.



## NOTE

Do not operate the engine fan in the MANUAL position for extended periods of time. The fan hub was designed for intermittent operation. Sustained operation will shorten the fan hub's service life as well as reduce fuel economy.

## Winterfronts

A winterfront or other air flow restriction device may be mounted in front of the radiator to increase cab heater temperature in cold climates.



## CAUTION

A winterfront should only be used at temperatures below 40°F (4°C). Use of a winterfront above 40°F (4°C) can decrease life of cooling module components. Remove winterfront as soon as the ambient temp reaches 41°F (5°C). The use of a winterfront above 40°F (4°C) can result in excessive engine coolant, oil, and charge air (intake) temperatures, which can lead to overheating and possible engine or coolant module damage and emissions non-compliance.

i	NOTE
<p>The winterfront is designed to minimize the temperature differences across the radiator and reduce the possibility of cooling module damage. Aftermarket winterfronts may not provide the proper airflow distribution and could cause cooling module damage.</p>	

### Engine Control Display

Your vehicle may come with an optional Engine and Driver Information Display. This instrument records information on engine diagnostics, scheduled maintenance, driving conditions, and general trip information. The specific features of your display may vary depending on engine make.



## OPERATING THE TRANSMISSION

### Operating Hydraulic Clutch (Manual Transmission)

Manual transmissions will also have a clutch pedal situated to the left of the brake pedal. Pressing down on the clutch pedal will disengage the clutch and will allow the transmission gears to be shifted.

At the beginning of the pedal stroke, there will be about ½ inch (13 mm) of movement before any resistance is felt. As the pedal is pressed further, the operator will feel increased resistance as the clutch is disengaged. After the clutch has been fully disengaged, there will be another 1 - 1 1/2 inches (25 -40 mm) of pedal travel which will engage the clutch brake. At this full stroke, the pedal will feel like it cannot be pressed anymore.

If the transmission is not shifting smoothly into gear while the clutch pedal is completely pressed to the floor, then it is time to have the clutch and hydraulic system inspected and serviced.

 CAUTION
Do not push the clutch pedal completely to the floor when shifting while the vehicle is in motion. using the clutch brake while shifting a vehicle in motion will damage the clutch brake. A non functioning clutch brake will make shifting very difficult when the vehicle is stationary.

If the clutch pedal is pressed completely to the floor and the transmission is not shifting, then it is time to have the clutch adjusted or serviced.

### Operating Manual Transmissions

The transmission shift pattern for your vehicle may be located on the shift control knob. In addition to understanding the shift pattern and its location, you should read the transmission manufacturer's manual provided with your vehicle before operating the vehicle.

# OPERATING THE TRANSMISSION

## Putting the Vehicle in Motion

After making sure the vehicle's oil and air pressure are correct and all other parts and systems are in proper working condition:

1. Fully depress the clutch pedal (for manual transmission) until the clutch brake makes contact.
  - a. The total stroke of the clutch pedal is about 6 inches (152 mm). The first ½ inch (13 mm) is free travel. After the free travel comes the release stroke, which is the part that fully releases the clutch. The last ½ inch (13 mm) engages the clutch brake.
  - b. Always start out in a low gear. Starting in higher gears, even with a light load, will cause a very jumpy start and excessive wear.

 CAUTION
Always use first gear or a low speed range to start the vehicle in motion. The use of a higher gear or speed range forces undue strain on the engine, clutch, other transmission components, and may cause damage.

2. Evaluate the road surface conditions and terrain your vehicle is on. Select a gear low enough to let your vehicle start forward with the throttle at idle.
3. Push the parking brake valve handle (Yellow) against the dash panel to release the brakes.
4. Release the clutch pedal (manual only), then gradually accelerate to permit smooth starting.
5. Do not allow your vehicle to roll (even a little) in the opposite direction during clutch engagement. If you need to

start up on an incline, apply your service brakes before you release the parking brake. Then release your service brakes as you engage the clutch and apply throttle.

For further instructions on operating your transmission, see the transmission manufacturer's Driver/Operator's Instruction Manual.

If you have a misaligned gear condition in your vehicle's transmission and cannot start, gradually release the clutch, allowing the drive gear teeth to line up properly. Then the drive gear can roll enough to allow the teeth to line up properly and complete the shift.

The best engine performance and maximum economy is obtained if gears are properly selected. This efficiency is achieved by always selecting gears within optimum engine RPM, which is where maximum torque and power are obtained. For further information, see

More Driving Tips and Techniques on page 4-52.

### Shifting Gears in a New Vehicle

Shift carefully in a new vehicle. The transmission may be a little stiff at first. Avoid gear clashing, by closely following these procedures.

When you are operating a new vehicle or one that has been exposed to cold weather, you want the transmission lubricant (fluid) to circulate and coat the contacting surfaces of the gears. Metal contacting metal in moving parts may seriously damage your transmission, do not drive in one gear for long periods of time until the transmission lubricant has a chance to coat all contacting surfaces.

### Clutch Brake and Travel

The clutch brake is used for stopping transmission gears, allowing you to easily shift into first gear or reverse without grinding gears. Approximately the last ½ inch (13 mm) of clutch pedal travel activates the clutch brake.

To apply the clutch brake (while the vehicle is stopped) fully depress the clutch pedal to stop the gears. With the throttle at idle, select first gear then release the clutch pedal to let the vehicle start forward, until the clutch is fully engaged. See the transmission manufacturer's Driver/Operator's Instruction Manual for further details.

If the transmission has a butt-tooth condition and you cannot engage a gear, gradually release the clutch. Then the drive gear can roll enough to allow the teeth to line up properly and complete the shift.

# OPERATING THE TRANSMISSION

---

## During Normal Driving

If you want to shift directly into any gear other than first or reverse, depress the clutch pedal only far enough to release the clutch. Fully depressing the pedal applies the clutch brake and could cause gear hang-up.

	<b>CAUTION</b>
Be careful not to apply the clutch brake while the vehicle is moving. The purpose of the clutch brake is to stop the transmission so that you can shift into a starting gear without grinding gears. Applying the clutch brake when the vehicle is moving will render the clutch inoperative.	

## Double Clutching

Whether you are upshifting or downshifting, it is best to double clutch. Double clutching is easier on the transmission and on the engine, helping your vehicle match engine speed with driveline speed and achieving clash-free shifts.

### To double clutch:

1. Push the clutch pedal down to disengage the clutch.
2. Move the gear shift lever to neutral.
3. Release the pedal to engage the clutch. This lets you control the RPM of the mainshaft gears, allowing you to match the RPM of the mainshaft gears to those of the output shaft.
  - a. Upshifts: let the engine and gears slow down to the RPM required for the next gear.

- b. Downshifts: press accelerator, increase engine and gear speed to the RPM required in the lower gear.
4. Now quickly press the pedal to disengage the clutch and move the gear shift lever to the next gear speed position.
5. Release the pedal to engage the clutch.

## Automatic and Automated Transmissions

An automatic or automated transmission makes shifting much easier. It remains important to completely understand how to operate the transmission to optimize its efficiency. Please read the manual for your automatic or automated transmission included with your vehicle.

For automated transmissions, there is no “park” position. So you will need to apply the parking brake before leaving the cab.

### Hill Hold



The hill hold feature is available as an option with certain automated transmissions. This feature holds the vehicle while on a hill to allow the operator to release the service brakes and press the accelerator. This feature will hold the vehicle if the vehicle is attempting to go up a hill from a stop in either drive or reverse.

 <b>WARNING!</b>	
Do not leave the cab of your vehicle without applying the parking brake. The truck could roll and cause an accident resulting in death or personal injury. Always apply the parking brake before you leave the cab.	

 <b>WARNING!</b>	
If your vehicle has an automated transmission, be aware that it can roll backwards when stopped on a hill or grade, or when starting from a stop on a hill or grade. Failure to comply may result in death, personal injury, equipment or property damage. Observe the following guidelines:	
<ul style="list-style-type: none"><li>• When stopped on a hill or grade, press the brake pedal.</li><li>• When starting from a stop on a hill or grade, quickly remove your foot from the brake pedal and firmly press on the accelerator pedal.</li></ul>	

# OPERATING THE TRANSMISSION

---

## Auxiliary Transmission

If you have an auxiliary transmission, see your transmission manufacturer's manual for its proper operation.

## More Transmission Tips Riding the Clutch

The clutch is not a footrest. Do not drive with your foot resting on the clutch pedal. It will allow your clutch to slip, causing excessive heat and wear, damage could result.

## Release Bearing Wear

When you must idle your engine for any period of time, shift your transmission to neutral and disengage the clutch (take your foot OFF of the pedal). This helps prevent unnecessary wear to your clutch release bearing, and it is less tiring for you, too.

## Tips

- Always use the clutch when making upshifts or downshifts.
- Always select a starting gear that will provide sufficient gear reduction for the load and terrain.

- Never downshift when the vehicle is moving too fast.
- Never slam or jerk the shift lever to complete gear engagement.
- Never coast with the transmission in neutral and the clutch disengaged.
- To provide smooth gear engagements while shifting, use proper coordination between shift lever and clutch.

Double clutching is a very effective means to increase the service life of your transmission. Double clutching refers to a technique where the clutch pedal is used twice per shift instead of once. It also requires that you adjust the engine rpm in the middle of the shift which ultimately synchronizes the gears during shifting. Synchronizing reduces wear on the gears. See Double Clutching on page 4-18.

# OPERATING THE BRAKE SYSTEM

## Introduction

This vehicle's brake system functions with the use of compressed air generated from the engine's air compressor. The compressed air is stored in various air tanks to ensure that air pressure is available whenever the driver needs it.

Compressed air is delivered to the brake system through the valve at the brake pedal and is controlled with various valves and braking circuits. The brake system is designed with separate front, rear and (when applicable) trailer circuits so that if one circuit is compromised and loses air, the other circuits will not be affected. Safety valves in each circuit will protect the other circuits in the event that a circuit loses air.

The air compressor on the engine will typically provide 100-130 psi (690-896 kPa) to the air tanks. The vehicle is also designed with an air dryer, which removes moisture from the compressed air in order to protect all components in the air system.

The brake system may be further enhanced by additional devices such as brake proportioning valves, Anti-lock braking systems or sensors designed to let you know if your brake pads need to be serviced.

Certain conditions may result in the brake surfaces getting wet. Brake surfaces that are wet do not perform as well as when they are dry. There may be situations where wet brake surfaces cannot be avoided. In such situations, apply the brakes while in motion, to dry the brake surfaces.

Certain conditions may result in your brake surfaces becoming overheated (above 800° F or 427° C). Overheated brakes will damage linings and drum surfaces, ultimately decreasing braking performance. Refer to Retarders and Descending a grade to avoid overheating the brakes.

This vehicle may be equipped with an anti-lock braking system (ABS). This ABS reduces the possibility of wheel lock-up. If a wheel is about to lock during braking, the ABS will automatically adjust air pressure to the brake chambers on the appropriate wheel(s) to prevent wheel lock-up. The ABS is automatically turned on when the ignition switch is turned on.

## OPERATING THE BRAKE SYSTEM

---

4



### WARNING!

The Anti-Lock Brake System is a critical vehicle safety system. For the safety of you and others around you, have the vehicle submitted for periodic preventive maintenance checks as well as having any suspected problems immediately checked by an authorized dealer. Failure to properly maintain your brake system can lead to serious accidents. Failure to comply may result in death, personal injury, equipment or property damage.



### WARNING!

Do not drive through water deep enough to wet brake components, as it may cause the brakes to work less efficiently than normal. The vehicle's stopping distance may be longer than expected, and the vehicle may pull to the left or right when brakes are applied, which could contribute to an accident involving death or personal injury.



### WARNING!

Do not rely on an anti-lock brake system that is functioning improperly. You could lose control of the vehicle resulting in a severe accident, causing death or personal injury. If your ABS lamp goes on while you are driving or stays on after the self-check, your anti-lock system might not be working. The ABS may not function in an emergency. You will still have conventional brakes, but not anti-lock brakes. If the lamp indicates a problem, have the ABS checked.

Vehicles without anti-lock brake systems (ABS) are typically equipped with a bobtail brake proportioning system. When a trailer is not connected, the drive axle brake application pressure will automatically be limited by the proportioning system. When driven in a bobtail mode, these tractors will require greater



brake pedal application to provide the equivalent braking to a bobtail tractor not equipped with a proportioning system.

## Parking Brake

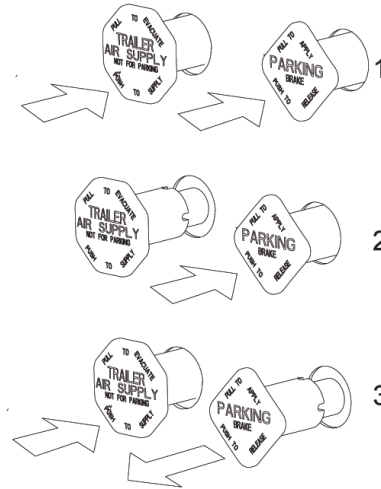

1. Normal Run Position
2. Trailer Park with Vehicle Released
3. System Park or Trailer Charge with Vehicle Parked

Parking brakes work in reverse action of the regular brakes. When the parking brakes are engaged, air is exhausted from the spring chambers, which allows the spring to engage the brakes. This design also provides a safety function if a brake circuit has a leak and loses air. In such a scenario, the parking brakes will apply.

The vehicle's parking brake controls are the yellow diamond shaped knob on your dash board. If the vehicle is equipped to tow a trailer, then there will be an additional red octagon shaped knob for the trailer parking brakes. Parking brakes will be engaged when either of these knobs are pulled OUT. (If one knob is pulled out, the other knob will automatically pop out.)

Pushing IN a knob will disengage the respective parking brakes. If you push in the yellow knob only, you will disengage the vehicle's parking

## OPERATING THE BRAKE SYSTEM

brakes but will not disengage the trailer parking brakes (if applicable). Either knob will pop back out if the system pressure is not above 60 psi (414 kPa).

The instrument panel display will provide a message any time the parking brakes (vehicle or the trailer) are set and the vehicle is put into motion.

### Trailer ABS Power Line Communication (PLC)

North American on-highway vehicles are equipped with a separate electrical circuit to power the anti-lock brake system (ABS) on towed vehicle(s). In most cases, the ABS power will be supplied through the Auxiliary circuit on the primary 7-way trailer light line connector. If the vehicle was manufactured with a switchable Auxiliary circuit for trailer accessories, an additional 7-way connector would have been provided for trailer ABS power. In either case, the ABS power line on the vehicle will be PLC equipped.

	CAUTION
Do not splice into the non-switchable Auxiliary circuit on the primary 7-way trailer light line. Doing so may cause the trailer ABS to malfunction. This circuit is dedicated for trailer ABS power. To add a switchable auxiliary circuit, contact a dealership.	

Vehicles and trailers built after 3/1/01 must be able to turn on an In-Cab Trailer ABS Warning Lamp (per Federal Motor Vehicle Safety Standards (FMVSS) 121). The industry chose Power Line Communication (PLC) as the standard method to turn it on.

	NOTE
Trailers not equipped with PLC can not turn on the In-Cab Trailer ABS Warning Lamp.	

	NOTE
<p>For doubles or triples, the lamp does not distinguish between trailers. An ABS problem in any of the trailers will activate the Trailer ABS Warning Lamp.</p>	

	NOTE
<p>If you change the intended service in any way (i.e. number of axles, multiple trailers, add switchable trailer accessories, etc.) from the date the vehicle was manufactured, you should contact your trailer manufacturer and/or trailer anti-lock brake manufacturer to determine if the power available at the 7-way trailer light line is adequate. Failure to do so might result in insufficient power to the trailer ABS system, which may affect its operation.</p>	

	CAUTION
<p>The center pin of the 7-way trailer light line may be constantly powered for ABS. Make sure it will not accidentally turn on trailer equipment.</p>	

**Special Trailer ABS (Without PLC) Option**

If a trailer does not have PLC, **but** it does have ABS that is powered through an optional second trailer connector (ISO 3731) and that trailer ABS is designed to control the Trailer ABS Warning Lamp in the cab **and** the vehicle has been ordered with the option to turn on this lamp for these types of trailers, **then** this lamp will turn on when that trailer ABS has a system problem. This should be checked by a dealer as soon as possible. The Trailer ABS Warning Lamp will not turn on for the power-on test when connected to these types of trailers.

	NOTE
<p>Very few trailers built before 3/1/01 have this option. Trailers built after 3/1/01 are built with PLC technology.</p>	

# OPERATING THE BRAKE SYSTEM

## Advanced ABS with Stability Control

This vehicle may be equipped with an optional Electronic Stability Program (ESP). ESP is a feature for ABS-equipped vehicles that reduces the risk of rollovers, jackknifing, and other loss of control situations. ESP features include Roll Stability Program (RSP) and Yaw Control.

4

During operation, the ECU of the Bendix® Advanced ABS system constantly compares performance models to the vehicle's actual movement, using the wheel speed sensors of the ABS system, as well as lateral, yaw, and steering angle sensors. If the vehicle shows a tendency to leave an appropriate travel path, or if critical threshold values are approached, the system will intervene to assist the driver.

## Roll Stability Program

Bendix® Roll Stability Program (RSP), an element of the overall ESP system, addresses rollover conditions. In the case of a potential roll event, the ECU will override the throttle and quickly apply brake pressure at all wheel ends to slow the vehicle combination. The level of braking application during an RSP event will be proportional to roll risk.

## A Real World Example of How the RSP System Operates

Excessive speed for road conditions creates forces that exceed the threshold at which a vehicle is likely to rollover on a higher-friction surface.

The system automatically reduces engine torque and applies the service brakes (based on the projected rollover risk) to reduce the vehicle speed,

thereby reducing the tendency to roll over.

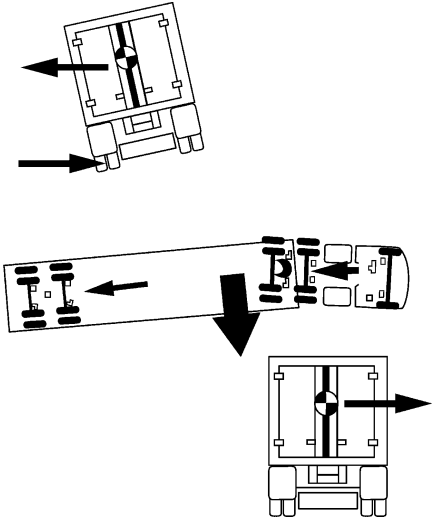

RSP Example

## Yaw Stability

Yaw stability counteracts the tendency of a vehicle to spin about its vertical axis. During operation, if the friction between the road surface and the tires is not sufficient to oppose lateral (side) forces, one or more of the tires can slide, causing the truck/tractor to spin.

These yaw events are referred to as either “under-steer” (where there is a lack of vehicle response to steering input due to tire slide on the steer axle) or “over-steer” (where the tractor’s rear end slides out due to tire slide on the rear axle) situation. Generally, shorter wheelbase vehicles (tractors, for instance) have less natural yaw stability, while longer wheelbase vehicles (straight trucks, for instance) have greater natural yaw stability. Factors that influence yaw stability are: wheelbase, suspension, steering geometry, weight distribution front to rear, and vehicle track width.

## Yaw Control

Yaw Control responds to a wide range of low- to high-friction surface scenarios including rollover, jackknife and loss of control. In the case of vehicle slide (over-steer or under-steer situations), the system will reduce the throttle and then brake one or more of the “four corners” of the vehicle (in addition to potentially applying the trailer brakes), thus applying a counter-force to better align the vehicle with an appropriate path of travel. For example, in an over-steer situation, the system applies the “outside” front brake; while in an under-steer condition, the “inside” rear brake is applied.

### A Real World Example of How Yaw Control Operates

Excessive speed exceeds the threshold, creating a situation where a vehicle is likely to spin and jackknife.

The Bendix® Yaw Control system reduces engine throttle and selectively applies brakes to reduce the vehicle speed, thereby reducing the tendency to jackknife.

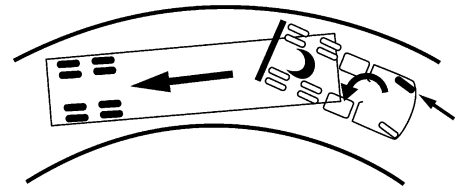
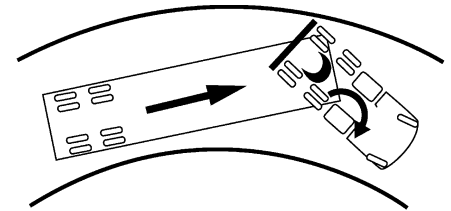

Yaw Control Example

# OPERATING THE BRAKE SYSTEM

## ESP May Reduce the Vehicle Speed Automatically

To minimize unexpected deceleration and reduce the risk of a collision the operator must:

- Avoid aggressive driving maneuvers, such as sharp turns or abrupt lane changes at high speeds, which might trigger the stability system.
- Always operate the vehicle safely, drive defensively, anticipate obstacles and pay attention to road, weather, and traffic conditions. ABS, ATC, and ESP stability systems are no substitute for prudent, careful driving.

## Towing Doubles or Triples May Reduce the Effectiveness of Stability Systems

ESP is designed and optimized for trucks and for tractors that tow single trailers. If a tractor equipped with ESP is used to power multiple trailer combinations (known as “doubles” or “triples”) the effectiveness of the ESP system may be greatly reduced.

 <b>WARNING!</b>
Exercise extreme care when towing doubles or triples with a vehicle equipped with Electronic Stability Program. Excessive speed and aggressive maneuvers, such as sharp turns, sudden steering inputs or abrupt lane changes should be avoided because these maneuvers could cause loss of vehicle control possibly resulting in an accident involving death or personal injury.

## Limitations of Stability Systems

The ESP stability system's effectiveness may be greatly reduced if:

- The load shifts due to improper retention, accident damage or the inherently mobile nature of some loads (for example, hanging meat, live animals or partially laden tankers).
- The vehicle has an unusually high or off-set center of gravity (CG).
- One side of the vehicle drops off the pavement at an angle that is too large to be counteracted by a reduction in speed.
- The vehicle is used to haul double or triple trailer combinations.
- If very rapidly winding steering inputs are inputted at high speeds.

- There are mechanical problems with suspension leveling of the tractor or trailer resulting in uneven loads.
- The vehicle is maneuvering on a high banked road creating either additional side forces due to the weight (mass) of the vehicle or a deviation between expected and actual yaw rates.
- Gusty winds are strong enough to cause significant side forces on the vehicle and any towed vehicles.

## To Maximize the Effectiveness of ESP

- Loads must be properly secured and evenly distributed at all times.
- Drivers need to exercise extreme caution at all times, and avoid sharp turns, sudden steering inputs or abrupt lane changes at high speeds, particularly if:
  - a. the vehicle hauls loads that could shift,
  - b. the vehicle or load has a high or off-set center of gravity (CG) when loaded, or
  - c. the vehicle tows doubles or triples.

## Truck Chassis Modifications

The ESP system was specifically calibrated and validated only for your vehicle's original factory-built configuration. If your vehicle's chassis components are altered (for example; a wheelbase extension or reduction, tag axle addition or removal, tractor to truck conversion or steering system component change) the ESP system must be disabled immediately by a qualified mechanic.



### **WARNING!**

Failure to disable ESP "Electronic Stability Program" when modifying a vehicle could result in a loss of vehicle control possibly resulting in an accident involving death or personal injury.

## OPERATING THE BRAKE SYSTEM

4



### WARNING!

For vehicles equipped with ESP “Electronic Stability Program” do not replace the vehicle’s steering wheel with an aftermarket or different part number than originally supplied. Using a different steering wheel could cause ESP to malfunction causing a loss of vehicle control possibly resulting in an accident involving death or personal injury.

### Steering Angle Sensor Re-Calibration

Whenever maintenance or repair work is performed to the steering mechanism, linkage, gear, adjustment of the wheel track, or if the steering angle sensor is replaced or the steering wheel is changed or re-centered, the Steering Angle Sensor must be re-calibrated.



### WARNING!

If the Steering Angle Sensor is not re-calibrated, the Yaw Control system will not function properly. A uncalibrated sensor could result in a loss of control of your vehicle which can lead to an accident involving death or personal injury.

### Optional ATC Functions Wheel Spin Control (option)

Your truck/tractor ABS may have an acceleration slip regulation (ASR) or automatic traction control (ATC) feature. This feature is controlled by a switch as shown in the next illustration. Either of these features is monitored by a warning lamp located on the switch.



### Wheel Spin Control Warning Lamp

The Traction Control warning lamp on page 3-37 will briefly illuminate and then go out when the ignition switch is first turned on. The traction control warning lamp will illuminate whenever the ASR or ATC system detects drive wheel spin. The lamp will remain illuminated as long as wheel spin is



detected and the ASR or ATC system is applying the drive wheel brakes or reducing engine torque. Engine torque or vehicle speed should be reduced to eliminate wheel spin and prevent excessive application of the ASR/ATC system. Except for checking for proper illumination of the ABS and traction control warning lamps when first starting the vehicle, and for monitoring these lamps while driving, no special operating procedures are required. For detailed system description, see literature for your specific ABS that was provided with your vehicle.

This feature helps improve traction when vehicles are on slippery surfaces or surfaces with poor traction (i.e. mud or snow) by reducing drive wheel overspin. Wheel spin control works automatically in two different ways:

- If a drive wheel starts to spin, wheel spin control applies air pressure to brake the wheel. This

transfers engine torque to the wheels with better traction.

- If all drive wheels spin, wheel spin control reduces engine torque to provide improved traction.

Wheel spin control turns itself on and off, you do not have to select this feature. If drive wheels spin during acceleration, the ASR Warning Lamp comes on, indicating wheel spin control is active.

Do not allow the ASR Warning Lamp to remain on continuously for an extended length of time. Extended, continuous use of the ASR/ATC can cause overheating of the drive wheel brakes.

### **Deep Snow and Mud Switch (option)**

A deep snow and mud switch is included with Wheel Spin Control. The Deep Snow and Mud feature is helpful during acceleration. This function

increases available traction on extra soft surfaces like snow, mud or gravel, by slightly increasing the permissible wheel spin. When this function is in use, the ASR Warning Lamp blinks continuously.

### **Off-Road ABS Function Switch (option)**

Your vehicle may be equipped with a separate switch to activate an Off-Road ABS function. This function is NOT to be used for On-Highway driving but is intended to be used to improve stopping performance in Off-Highway conditions (e.g. loose gravel and mud). The Off-Road ABS function is accomplished by allowing a “wedge” of material to build-up in front of momentarily locked wheels.

### **Features and Benefits**

- Changes the ABS control limits to allow for a more aggressive ABS function while off-road.

# OPERATING THE BRAKE SYSTEM

4

- Improves vehicle control and helps reduce stopping distances in off-road conditions or on poor traction surfaces such as loose gravel, sand, and dirt.
- Allows retarders to function independently of the ABS function.
- If your vehicle does not have an engine retarder, the Off- Road ABS switch will function the same.

 **CAUTION**

Never drive your vehicle on improved roads/highways with the Off-Road ABS function turned on. When you drive your vehicle onto an improved road surface or highway, immediately turn off the Off-Road ABS switch. Failure to do so will cause the ABS system to not function properly in an ABS event under 25 mph and could result in an accident or personal injury.

 **WARNING!**

While the off-road mode can improve vehicle control and shorten stopping distances, some steering ability may be reduced on certain surfaces resulting from the momentarily sliding tires. Always operate your vehicle at safe operating speeds. Failure to do so may cause you to lose control of the vehicle and could result in an accident or personal injury.

## How the Off-Road ABS Function Works

- The ABS lamp flashes slowly during off-road mode engagement. This is done to alert you of a modification to the ABS control software.
- At speeds above 25 mph, the ABS controller operates in the normal on-highway mode.

- At speeds between 10 and 25 mph, the ABS control software is modified to allow short periods (0.25 seconds) of locked-wheel cycles.
- At speeds below 10 mph, the ABS control software is turned off to allow locked wheels.
- When the Off-Road ABS function is enabled, the Retarder Disable output is turned off. That is, the engine retarders are left to function without ABS intervention. For additional information, see the Off-Road ABS pamphlet in your vehicle's glove box.

**Retarders**

Various retarders are available, which function against the engine, driveline, or transmission. These are devices that use your engine’s power to slow down your vehicle. They save wear and tear on your service brakes and can be a safety feature, too, because they can keep your brakes from overheating.

Ideally, you should always slow your vehicle with your retarder (where permitted by law) and use your service brakes only for stopping completely. Operating this way will greatly prolong the life of your brakes.

	<b>WARNING!</b>
Do not use any of the vehicle’s retarders in any situation that requires an immediate stop and/or in situations of poor traction (such as wet, icy or snow covered roads). Trying to use the retarder instead of the service brakes may cause a loss of vehicle control, which may result in an accident involving death or personal injury.	

	<b>WARNING!</b>
The service brakes must be used in an emergency. The retarder alone might not stop you fast enough to prevent an accident. Failure to comply may result in death, personal injury, equipment or property damage.	

The retarder is NOT intended as the primary brake for the vehicle, nor is it an emergency brake. The retarder only helps the service brakes by using

pressure to slow the drivetrain. Use the service brakes for quick stops.

Do not use the retarder when operating on road surfaces with poor traction (such as wet, icy, or snow covered roads or gravel). Retarders can cause the wheels to skid on a slippery surface.

## OPERATING THE BRAKE SYSTEM

### Driving Bobtail or with an Unloaded Trailer

We recommend that you do not use your engine retarder to slow down when you are bobtailing or pulling an empty trailer.



#### WARNING!

Using an engine retarder can cause a wheel lockup. The trailer is not loading the tires enough to give the traction you may need. When you are bobtail or unloaded, you can have a serious accident if your wheels lock suddenly during braking. You could be killed or injured. Don't use your retarder when you are driving bobtail or with an unloaded trailer.

### Transmission Retarder



If you have this option, it will act like a brake to slow your vehicle without using the brakes. Take your foot off the throttle and operate the retarder switch. When you do not need full retarder effect, you can apply it intermittently (off and on) to cause gradual or partial slowing. Continuous application of your retarder will cause your hydraulic fluid to get hotter. Intermittent application will help prevent overheating.



#### WARNING!

Do not rely on your automatic transmission hydraulic retarder to stop your vehicle. If your engine shuts down, the vehicle's retarder will cease to operate which, may lead to an accident involving death or personal injury. Always be ready to suddenly apply the service brakes.

# CRUISE CONTROL

## Cruise Control Switch

This vehicle may have cruise control switches located on the steering wheel instead of the switches on the dash board. The instructions are still the same. See Steering Wheel Controls on page 3-73 to determine where the cruise control switches are located.

For information about the Adaptive Cruise Control, see Adaptive Cruise Control on page 4-37.

**To Turn On:**

Press the ON/OFF button.

**To Turn Off:**

Press the ON/OFF button. Any previous speed settings are cleared.

## Using Cruise Control While Driving

### Setting Cruise Speed

1. Ensure that the vehicle speed is above the minimum cruise control speed (19 mph (30 km/h) for PACCAR MX engine and 30 mph (48 km/h) for Cummins engines) and the engine speed is above 1100 rpm.
2. Press the "ON/OFF" button.
3. Accelerate the vehicle to the desired cruise speed.
4. Press the "SET" button to set the cruise speed.

	<b>NOTE</b>
Cruise Control may not hold the set speed going down hills. If the speed increases going down a hill, use the brakes to slow down. This will cancel Cruise Control.	

## Changing the Cruise Set Speed

For vehicles with cruise control buttons on the steering wheel, the cruise speed may be changed by using the +/- button. The pressing and holding the + button will increase speed while pressing and holding the - button will decrease speed. For vehicles with dash mounted cruise control switches, changing the speed is done through the "Set/Resume" button. To increase the speed, press and hold the Set button. To decrease the speed, press and hold the "Resume" button.

## Cancelling Cruise Control

You can cancel cruise control in any of these ways:

- Tap the brake pedal.
- Tap the clutch pedal.

# CRUISE CONTROL

- Press the ON/OFF button if the vehicle has dash board mounted cruise control switches or the CANCEL button if the vehicle has cruise control switches on the steering wheel.

## Resuming Cruise Control

1. If you tapped the brake or clutch pedal, the cruise control remembered the previously set cruise speed. To resume that set speed, accelerate above the minimum cruise control speed and press the "RESUME" button.
2. If you pressed the "OFF" button (or the steering wheel mounted "CANCEL" button) or turned the ignition key OFF, this cleared the system memory and you will need to set a new cruise speed.

## Using Cruise Control for Stationary PTO Operation

### Setting Idle Speed

1. Ensure parking brakes are applied.
2. Ensure transmission is in Neutral.
3. Engage PTO per the manufacturer's operating instructions.
4. Press the "ON" button.
5. Press the "SET" button to obtain the desired engine rpm.

### Cancelling Cruise Control

You can cancel cruise control in any of these ways:

- Tap the brake pedal.
- Tap the clutch pedal.

- Press the "OFF" button (or the steering wheel mounted "CANCEL" button).

	<b>NOTE</b>
Cruise control functions and features may vary depending upon which engine you have. For specific explanation of your cruise control, see the cruise control or engine manual included with your vehicle.	

This vehicles electronic system will perform a 'rationality check' every time the vehicle is started. This check is to ensure that the service brakes are working before allowing cruise control to function. This safety feature is designed to ensure that a driver is able to cancel the cruise set speed by using the service brake pedal. The system will not allow cruise control operation if it does not pass the 'rationality check.' The instrument cluster will prompt you to press the service brake pedal if it

has not been pressed since the vehicle has been started.

In vehicles with Eaton transmissions, the cruise control switches may be located on the shift control knob.

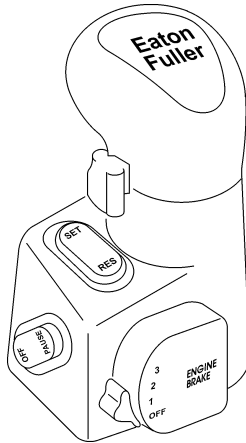

## Adaptive Cruise Control (Optional)

This vehicle may have an Adaptive Cruise Control with Braking (ACB) system that enhances the cruise control function. The adaptive cruise control system uses a radar sensor to detect the following distance to vehicles in front. The system will attempt to maintain either a safe distance or the vehicle speed depending on what is selected by the driver. If a following distance conflict occurs the system will alter the vehicles throttle position, apply engine braking, and even apply vehicle foundation brakes in attempt to maintain the following distance. The driver should always remain alert and ultimately is the one still responsible for safe vehicle control.

When the system is active and controlling the speed and distance, the screen will show the following display.



The information in the instrument cluster will provide various visual and audible information. The audible sounds may be a steady beep or a repeating beep depending on the situation. The following illustrations are provided with the beeping characteristics.

### Level 3 (Green) Following Distance Alert



This warning is active when the following distance is less than what is set in the system. This is the least severe of all the warning tones. The system will emit a single beep

## CRUISE CONTROL

repeating at a rate of 42 tones per minute.

### Level 2 (Amber) Following Distance Alert



This warning is active when the following distance is less than what is set in the system. This warning is more severe than the Level 3 Following Distance Alert. The system will emit a double beep repeating at a rate of 80 tones per minute (40 double beeps per minute).

### Level 1 (Red) Following Distance Alert



This warning is active when the following distance is less than what is set in the system. This warning tone is the most severe following distance alert. The system will emit a continuous beep repeating at a rate of 188 tones per minute and a popup "WARNING Following Distance: Increase Gap to Vehicle Ahead."

### Brake Command Warning

Collision Alert  
 **BRAKE!**



This is the most severe warning issued. When the system uses the foundation brakes the level 1 warning will appear on the screen accompanied with a "Collision Alert BRAKE" message. The warning is active when the driver must take immediate evasive action by

applying more braking power and/or steering clear of the vehicle ahead to avoid a potential collision. The system will emit a solid beep for a 3 second duration.

### Stationary Object Alert



The system can also detect stationary objects in the vehicles path. The operator needs to take control of the vehicle to avoid the stationary object. The icon will be accompanied with a pop-up message but no audible sound.





## WARNING!

The Wingman® ACB sensor may not be able to detect vehicles and objects with limited metal surfaces (such as recreational vehicles, horse-drawn buggies, motorcycles, logging trailers, etc.). Failure to understand the system limitation may result in death, serious injury, and/or property damage.

### Fault Alert



This warning is presented to alert the operator that the ACB system is malfunctioning and will be disabled. The operator will need to resume control of the vehicle's throttle and brakes. The system will remain disabled until the fault is corrected.

### AXLE

#### Differential Lock



The vehicle may be equipped with switches to lock the either of the rear axle differentials. Depending on how the vehicle is specified, a combination individual switches may be available that can lock the interaxle driveline and/or any combination of the forward rear or rear-rear driving axles.

The interaxle differential switch allows each axle to turn independently. In certain situations, engaging the interaxle differential lock relieves stress on the rear axles and reduces tire wear. Engaging this switch will also provide better traction in slippery or loose gravel conditions.

In the LOCK position, continuous operation on paved, dry surfaces, put stress on the axles, and can possibly damage the internal gears. The switch has a guard to prevent accidental operation of the switch.

Locking the differentials is typically used during ice or snow conditions and without tire chains, unpaved roads that have loose sand, mud or uneven surfaces. Look ahead and predict when the differential needs to be locked. Stop the vehicle and lock the differentials before approaching.

While using the differential in the locked position, do not exceed 25 mph (40 km/h). When disengaging the differential lock, reduce the throttle to prevent drivetrain damage.



#### WARNING!

Do not put the differential lock in the LOCK position while the wheels are spinning freely (slipping), you could lose control of the vehicle or cause axle damage. Switch to LOCK only when the wheels are not spinning. Failure to comply may result in death, personal injury, equipment or property damage.

## Dual Range (Two-Speed) Rear Axle



Your vehicle may be equipped with a two-speed or dual range axle (option). You can select two rear axle ratios for operating under heavy loads or rough terrain as well as for over the road hauling.

The Low Range provides maximum torque for hauling heavy loads or traveling over rough terrain. The High Range is a faster ratio for highway speeds and general over the road conditions. A switch on the accessory switch panel controls the Dual Range Rear Axle. You will notice that the switch has a guard to protect you from activating it accidentally. Always park your vehicle with the range selector in LOW.

### Dual Range Axle Operation

Important tips on operating a Dual Range Axle with Interaxle Differential:

- Shift the axle with the inter-axle differential in the unlocked position only.
- When you are driving with poor traction, lock the differential. When you have the differential locked, drive with the axle in LOW range only.
- When you are driving on a surface with good traction, keep the interaxle differential unlocked. You can drive with the axle in the LOW or HIGH range.
- Always UNLOCK the inter-axle differential before shifting the axle speed range.



#### CAUTION

If you shift the axle range with the inter-axle differential in LOCK, you could seriously damage the axles. Never shift the axle range with the differential locked.

# AXLE

## Starting-Up

1. Unlock the inter-axle differential before starting.
2. Put the Range Selector in the LOW range. Shift the transmission to start the vehicle moving.
3. When you are driving on rough terrain and secondary roads, or under a very heavy load, keep the axle in the LOW range. Shift the transmission to maintain proper road speed.

Proper shifting of the axle depends on the synchronization of engine/driveline and wheel speed. When you shift the axle, the connection between the engine and wheels is momentarily disengaged while the gearing is synchronized. Normally when the axle is shifted the speed of the engine, axle, and wheels adjust, allowing for proper gear engagement.

When going downhill the wheels will not slow down, but will tend to speed up, which makes gear synchronization almost impossible. As a result, the axle is neither in HIGH nor LOW range and all engine/driveline retardation is lost. Without engine retardation it is more difficult to slow the vehicle down and greater stress is put on the brake system.



### CAUTION

To avoid damaging your vehicle shift the axle at slower travel speeds until you are used to driving with a dual range axle.

4



### WARNING!

Never shift the axle when moving downhill. Engine driveline disengagement may occur, eliminating engine retardation and allowing the wheels to spin faster than the current speed of the engine. This may require severe braking to slow the vehicle down and can result in an accident. Failure to comply may result in death, personal injury, equipment or property damage.

### LOW to HIGH (Cruising)

When you go from rough terrain to highway driving, shift the axle to the HIGH range following this procedure:

1. Be sure the differential is **UNLOCKED**.
2. Maintain your vehicle speed (accelerator depressed) and move the Range Selector lever to **HIGH**.
3. Keep driving with the accelerator depressed until you want the axle to shift.
4. To make the axle shift, release the accelerator until the axle shifts. You are now in the HIGH axle range for highway speeds. Shift the transmission normally to reach your desired cruising speed.

### HIGH to LOW (Rough Terrain)

If you need to downshift the axle for more power or you are driving on rough terrain:

1. Maintain your vehicle speed (accelerator depressed) and move the Range Selector lever to **LOW**.
2. Keep driving with the accelerator depressed until you want the axle to downshift.
3. To make the axle downshift, release and depress the accelerator quickly to increase the engine RPM. The axle will shift to LOW range.
4. You are now in the LOW axle range for rough terrain and heavy loads. Shift the transmission normally to maintain the desired speed.

### Auxiliary Axles - Pusher or Tag



Adjustable auxiliary axles (commonly known as Pusher or Tag axles) can add to the productivity of the vehicle by increasing the load capabilities of the vehicle when they are in the deployed (down) position. There are different configurations of axles with different functionality (liftable versus steerable). Without the extra axle, the excessive weight can reduce the service life of vehicle components such as, but not limited to, the frame rail, axles, suspension and brakes.

Operation of the auxiliary axles includes the proper maintenance of the system and calibration of its controls. Operating the auxiliary axles will also require a firm understanding of the

## AXLE

Gross Axle Weight Rating (GAWR) and the load that is being carried. See Vehicle Loading on page 1-34.

The vehicle will have switches on the dash to control the position of the auxiliary axles. In certain situations, however, the system will override the controls to protect the axle system. Any liftable and steerable auxiliary axles will rise off of the ground when the parking brakes are engaged or when the vehicle is put in reverse. If the liftable auxiliary axle is not a steerable axle, then it will remain in the down position when activated by the dash mounted switch.

Operating the auxiliary liftable axles must be performed in a manner that does not exceed the axle creep rating. Axle creep ratings are weight and speed limits that are allowed while the vehicle is fully loaded (in excess of the vehicle's standard GAWR) and the axle is in its up position. Axle

creep ratings are assigned by the axle manufacturer and are based on axle model and intended service of the vehicle. Contact an authorized dealership if you are unable to identify the axle creep rating of this vehicle.

- Liftable/steerable (axle lift calibration required)
- Liftable/non-steerable (axle lift calibration required)
- Non-liftable (some suspensions require dump valve calibration)



### WARNING!

Do not operate or park the vehicle with auxiliary axles in the down/loaded position when vehicle is unladen, or is being unloaded. Raise or dump air into driver-controlled auxiliary axle(s) prior to unloading vehicle. Failure to do so can result in loss of vehicle control or rollaway that may result in death, personal injury, equipment or property damage.

**Axle Creep Rating Definition  
Creep Ratings**

Low speed, off-highway (work site) axle loads, which exceed the standard gross axle weight rating (GAWR) of a particular axle.

Operator's using vehicles equipped with liftable auxiliary axles must consider creep ratings when any liftable axle is unloaded or in the raised position. Liftable auxiliary axles should only be raised (or unloaded) to improve maneuverability in an off-road use or when vehicle is unloaded.

	<b>NOTE</b>
Axle Creep ratings <b>MUST NOT</b> be exceeded.	

Contact your dealer or axle manufacturer to determine what the creep rating is for your particular axle(s) and configuration. Creep

ratings are generally limited to the following:

- Tandem rear axles only
- Straight trucks only
- Maximum spring mount centers per axle manufacturers specifications
- Maximum tire static loaded radius (SLR) per axle manufacturers specifications

	<b>CAUTION</b>
Always lower the axles as soon as possible after receiving a load. Never exceed 5 miles per hour when driving with a load with the auxiliary axle(s) raised/unloaded. Failure to lower the axle(s) can overload the frame and remaining axles, and could cause equipment damage.	

	<b>WARNING!</b>
Never operate the vehicle with more pressure in the lift axles than is necessary to carry the load, as determined by the calibration procedure described. Failure to do so can result in loss of traction and stability at the steer and/or drive axles and can result in increased braking distance, which could cause loss of vehicle control resulting in an accident. Failure to comply may result in death, personal injury, equipment or property damage.	

	<b>CAUTION</b>
Do not modify the air system and/or control functionality on a factory installed auxiliary axle(s). Modifying the factory operation of the pusher and/or tag axle(s) will void your warranty, and can cause equipment damage.	



## CAUTION

A change in tire size on either the auxiliary axles or the drive/steer axles can change the calibration of the auxiliary axles. If tires are installed with a different loaded radius, the calibration procedure must be repeated. Failure to do so can cause equipment damage.

## Liftable/Steerable or Liftable/Non-Steerable Pusher and/or Tag Axle Calibration Procedure

Below are some general instructions on how to adjust and calibrate the air control valve for the auxiliary axles to obtain the proper load distribution of the axle(s). For additional operating and maintenance instructions, see the pusher or tag suspension manufacturer literature in the glove box or contact them directly.



## NOTE

This procedure must be performed prior to placing the vehicle into service.

## Setting the Pressure-to-Load Ratio

To obtain the desired axle load distribution, you must correlate the suspension air gauge pressure to the actual axle load by scaling the axle weight(s) and adjusting the pressure to obtain the desired load. Once the desired load or load range is achieved, document the pressure-to-load ratio or setting for future use.



**General Calibration Guidelines**

These instructions are general in nature. For more specific instructions, review the pusher or tag suspension manufacturers maintenance manual or contact the nearest authorized dealer.

	<b>NOTE</b>
Perform this procedure at or near a weight scale. Procedure can be performed while parked on the weight scale if scale is available.	

1. Park loaded vehicle on level surface with wheels blocked.
2. Release vehicles spring brakes. (Do not release for Lifiable/Non-Steerable pusher or tag axles).
3. Lower the pusher/tag axles with the axle lift control flip valve. (For some non-lifiable axles, inflate air suspension).

4. Adjust the amount of load on each axle by turning the pressure regulator clockwise to increase the load or counterclockwise to decrease the load. (The suspension manufacturer may publish pre-established Pressure-to-Load Ratio Pressure Settings to assist you in achieving an estimated ground load).
5. After setting the pressure to obtain the desired axle load, verify proper ground loading with the weight scale.

	<b>NOTE</b>
Exceeding local, state or federal weight limits may result in citations. Contact your local commercial weight enforcement office for limits in your area.	

**Operation guidelines**

	<b>NOTE</b>
Steerable-pusher and/or tag axle(s) will raise when the transmission is shifted into reverse or when the parking brakes are applied.	

**Maximizing Drive Axle Traction**

Adjust the pressure regulator control knob to a lower pressure until desired traction is obtained. By reducing air pressure at pusher or tag axle, load will be transferred to drive axles. Do not overload drive axles.

**Coupling to a Loaded Trailer**

Inflate air springs of the auxiliary axles to the desired pressure after coupling to a loaded trailer while still maintaining proper traction of the drive axles.

**Unloading Operation**

## AXLE

---

Always deflate air springs of the auxiliary axles before attempting to unload vehicle. This allows maximum traction of the drive axles to control the vehicle.

### **Non-liftable (Non-steerable) Axles**

Some suspensions require dump valve calibration.

4

Example: Neway dead axles do not lift, but the air can be dumped out of them to unload them when empty. Air pressure is controlled via an adjustable regulator. These axles need to be calibrated for load.

Contact your authorized dealer or axle/suspension manufacturer for dump valve calibration procedures.

## SUSPENSION

### Air Suspension Height/Air Pressure



Your vehicle may have an air suspension and a deflation switch which allows the air in the suspension to be exhausted from a switch on the dash. The normal purpose of this feature is to allow you to lower the vehicle for loading.

A guard on the switch prevents you from accidentally deflating the suspension.

	CAUTION
Operating a vehicle with air suspension bags either overinflated or underinflated may cause damage to drive-line components. If a vehicle must be operated under such conditions, do not exceed 5 mph (8 km/h). Failure to comply may result in equipment damage.	

### Suspension Air Pressure Gauge

The Suspension Air Pressure gauge (option), see Optional Gauges on page 3-43, which indicates the amount of air pressure in the air suspension springs in pounds per square inch (psi). Air pressure in the spring is related to the rear axle load. The greater the rear axle load, the greater the air pressure in the air bags. Therefore, the air pressure displayed will vary, depending upon the rear axle load.

# SUSPENSION

## Driving with Deflated Air Springs

If an air spring is ruptured, there will be enough air pressure to drive the vehicle to a safe stop off the highway to investigate the problem.

 <b>WARNING!</b>
Do not continue to drive with ruptured air springs. The air loss can cause the spring brakes to apply allowing your brakes to drag and burn up the linings, which could lead to an accident causing death or personal injury. Do not continue to operate the vehicle in this condition.

You can get to a repair facility if you do the following:

1. Remove the height control link connected to the axle and to the suspension air valve control arm. This will cause the air valve

control arm to center in the closed position.

2. The air system can then be pumped up to normal pressure for continued operation.

 <b>WARNING!</b>
Do not drive the vehicle if the air pressure is less than 100 psi (690 kPa). Driving the vehicle with less than 100 psi (690 kPa) could make the brakes unsafe to use which could cause an accident involving death or personal injury.

 <b>CAUTION</b>
Operating a vehicle with air suspension bags either overinflated or underinflated may cause damage to drive-line components. If a vehicle must be operated under such conditions, do not exceed 5 mph (8 km/h).

# AFTER-TREATMENT SYSTEM

## Introduction

This vehicle will have an exhaust After-Treatment System (ATS), to control vehicle exhaust emissions, which consist of a Diesel Particulate Filter (DPF), Selective Catalyst Reduction (SCR), Regeneration Switch and warning lights. The DPF will trap soot from the engine exhaust gases. The SCR uses Diesel Exhaust Fluid to reduce the levels of NOx in the engine exhaust. The ATS will periodically clean (regenerate) the DPF. Please refer to the Exhaust Aftertreatment System Supplement provided with the vehicle for more detailed description of functionality and warnings.

### DRIVING TIPS AND TECHNIQUES

#### Introduction

This section covers additional driving tips and techniques on how to drive your vehicle more efficiently.

#### Coasting



#### WARNING!

Do not coast with the transmission in neutral or with the clutch pedal depressed - it is a dangerous practice. Coasting in neutral may result in damage to your drivetrain when you try to re-engage the transmission. You could lose control of the vehicle which can lead to an accident involving death or personal injury.

Coasting with the transmission in neutral also prevents proper transmission component lubrication. During coasting the transmission is driven by the rear wheels, and the countershaft gear (which lubricates the transmission components by oil splash) will only be turning at idle speed.

Do not coast with the transmission in neutral or with the clutch pedal depressed. Besides being illegal and dangerous, coasting is also expensive. It causes premature failure or damage to the clutch and transmission and overloads the brake system.

## Descending a Grade

 <b>WARNING!</b>
Do not hold the brake pedal down too long or too often while going down a steep or long grade. This could cause the brakes to overheat and reduce their effectiveness. As a result, the vehicle will not slow down at the usual rate. To reduce the risk of an accident which could cause death or personal injury, before going down a steep or long grade, reduce speed and shift the transmission into a lower gear to help control your vehicle speed. Failure to follow procedures for proper downhill operation could result in loss of vehicle control.

## Engine Overspeed

 <b>CAUTION</b>
To avoid engine damage, do not let the engine rpm go beyond the maximum governed rpm—valve damage could result if overspeed conditions occur.

 <b>NOTE</b>
Often these recommendations are secondary to maintaining an adequate and safe speed relative to the surrounding traffic and road conditions.

Under normal load and road conditions operate the engine in the lower end of the range.

Operate the engine within the optimum engine rpm range and do not allow the rpm's to exceed the maximum governed speed. See your Engine Operation and Maintenance manual for information regarding engine rpm. When the engine is used as a brake to control vehicle speed (e.g., while driving down a grade), do not allow the engine rpm to exceed maximum governed speed.

## DRIVING TIPS AND TECHNIQUES

### Use of Tachometer

The tachometer is an instrument that aids in obtaining the best performance of the engine and manual transmission, serving as a guide for shifting gears.

Refer to the Engine Operation and Maintenance manual for optimum engine rpm.

- If the engine rpm moves beyond the maximum governed speed, indicating an overspeed condition, apply the service brake or shift to a higher gear to bring engine rpm within the optimum speed range.
- When driving downhill: shift to a lower gear, use the engine brake (if so equipped), and use the service brake, keeping the engine speed below 2,100 rpm.

When the engine speed reaches its maximum governed speed, the injection pump governor cuts off fuel

to the engine. However, the governor has no control over the engine rpm when it is being driven by the vehicle's transmission, for example, on steep downgrades. Apply service brakes or shift to a higher gear.

Fuel economy and engine performance are also directly related to driving habits:

- The best results in trip time and fuel economy are obtained while driving the vehicle at a steady speed.
- Shift into higher or lower gears (or apply the service brake) to keep engine rpm near the lower end of the optimum operating range.
- Avoid rapid acceleration and braking.

### Optimal Engine Speed



#### WARNING!

Do not look at the Instrument Cluster Display for prolonged periods or at it repeatedly in a short period of time while the vehicle is moving. Extended glance durations to instrument cluster and or overly frequent glances inside the vehicle can cause a loss of attention to the situations on the roadway and vehicle's road position, which could lead to an accident and possible death or personal injury or equipment damage.

The tachometer displays a green bar just below the most efficient engine speed for the vehicle. The placement and size of this bar is dependent on the engine as installed at the factory. The driver's general goal should be to select a gear that keeps the tachometer needle positioned over the green light as much as possible



during steady state driving. In addition to proper maintenance and good driving habits, this visual cue can help minimize the fuel consumption.

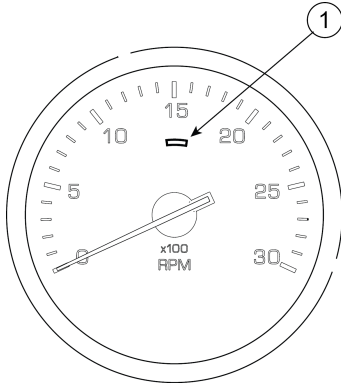

1. Optimal Engine Speed Indicator

### Use of Instrument Cluster Display

The Instrument cluster display provides information to help the driver optimize vehicle efficiency. Refer to Instrumentation Cluster Information on page 3-14 for details. A driver will find the section describing Trip Information and the RPM Detail useful.

### Fuel - Excess Consumption

The vehicle's fuel consumption is connected to three important factors: maintenance, driving habits, and general condition of the road, traffic conditions, and vehicle load.

# DRIVING TIPS AND TECHNIQUES

---

## Maintenance

Proper maintenance will keep the vehicle running like new even after long periods of use. The driver must perform the daily and weekly checks of the vehicle.

## Maintenance factors affecting fuel consumption:

- air and/or fuel filters partially clogged
- engine valves out of adjustment
- injection pump improperly synchronized
- injection nozzles defective or uncalibrated
- improperly inflated tires
- wheel bearings improperly adjusted
- clutch improperly adjusted or worn (slipping)
- fuel leaks

## Driving Habits

Wrong driving habits must be corrected and the recommendations on economic driving should be followed.

## Driving factors affecting fuel consumption:

- excessive speed and unnecessary fast acceleration
- long periods of idling
- driving with foot resting on the (manual transmission) clutch pedal

### General Condition

Other factors affecting fuel consumption are related to loads and type of roads on which the vehicle operates. It is not always possible to choose the most adequate road, but it must be kept in mind that the ideal road is the one that allows a steady speed in high gear, without requiring frequent braking and acceleration.

#### **The following general conditions can affect fuel consumption:**

- overload
- unbalanced load
- very high load
- inadequate roads
- traffic conditions

## SLEEPER BUNKS

### SLEEPER BUNKS

#### Sleeper Bunk

If your vehicle has an upper and lower bunk, the upper bunk can be folded up out of the way to provide you with more dressing area in the sleeper cab. The lower bunk has storage underneath it to stow your luggage and other belongings. The upper bunk weight limit is 320 lb. (145 kg).

4



#### WARNING!

Be sure the restraint system is used when anyone is occupying the sleeper while the vehicle is moving. In an accident, an unrestrained person lying in a sleeper bunk could be injured. He or she could be thrown from the bunk.



#### WARNING!

Always keep the lower bunk in its down (latched) position while the vehicle is moving. If left open, stored items could become loose during an accident and strike you. Before you move the vehicle, check to be sure the lower bunk is latched securely. Failure to comply may result in death or personal injury.

- **Before you move the vehicle, check to be sure the lower bunk is latched securely.**

**To Lower Upper Bunk:** pull on the lanyard in the upper left corner of the bunk to release the bunk. This will free it from the anchored position and allow you to lower the bunk.

**To Raise Upper Bunk:** fold the upper bunk up and push it against the retaining latch until you hear a click. Pull on the bunk to be sure it is latched securely.



#### WARNING!

Be sure the latch that holds the upper bunk in the folded position is working properly so the bunk will not fall down. If the bunk falls, you could be injured.



#### WARNING!

Be sure to stow away all loose belongings before you move your vehicle. Do not store objects on the bunks, they could cause damage or injury in an accident. Failure to comply may result in death, personal injury, equipment or property damage.

 **WARNING!**

Be sure the restraint system is used when anyone is occupying the sleeper while the vehicle is moving. In an accident, an unrestrained person lying in a sleeper bunk could be injured. He or she could be thrown from the bunk. Failure to comply may result in death or personal injury.

 **WARNING!**

Be sure no one ever rides unsecured in the upper bunk. That person could be thrown out in an accident and could be injured. Do not use the upper bunk while you are moving. Failure to comply may result in death or personal injury.

## Sleeper Occupant Restraint

The sleeper restraint is stored in a compartment on the rear sleeper cab wall.

 **WARNING!**

Failure to properly use the sleeper restraint when an individual is located in the sleeper bunk and the vehicle is moving can result in death or personal injury.

See Sleeper Bunks and Restraints on page 1-29, for more information on cab/seat restraint systems.

## STOPPING THE ENGINE

---

### STOPPING THE ENGINE

#### Before Stopping the Engine

A hot engine stores a great amount of heat. It doesn't cool down immediately after you shut it off. Always cool your engine down before shutting it off. You will greatly increase its service life.

Idle the engine at 1000 RPM for five minutes. Then low idle for thirty seconds before shutdown. This will allow circulating coolant and lubricating oil to carry away heat from the cylinder head, valves, pistons, cylinder liners, turbocharger, and bearings. This way you can prevent serious engine damage that may result from uneven cooling.

#### Turbochargers

This cooling-down practice is especially important on a turbocharged engine. The turbocharger contains bearings and seals that are subjected to hot exhaust gases. While the engine is operating, heat is carried away by circulating oil. If you stop the engine suddenly, the temperature of the turbocharger could rise as much as 100°F (55°C) above the temperature reached during operation. A sudden rise in temperature like this could cause the bearings to seize or the oil seals to loosen.

#### Refueling

Air inside the fuel tanks allows water to condense in the tank. To prevent this condensation while the vehicle is parked for extended periods of time, fill the tanks to 95 percent of capacity. Never fill to more than 95 percent capacity as this provides room for expansion resulting from temperature extremes. When refueling, add approximately the same amount to each fuel tank on vehicles with more than one tank.



#### **WARNING!**

Do not carry additional fuel containers in your vehicle. Fuel containers, either full or empty, may leak, explode, and cause or feed a fire. Do not carry extra fuel containers, even empty ones are dangerous. Failure to comply may result in death, personal injury, equipment or property damage.



### WARNING!

Diesel fuel in the presence of an ignition source (such as a cigarette) could cause an explosion. A mixture of gasoline or alcohol with diesel fuel increases this risk of explosion. Do not remove a fuel tank cap near an open flame. Use only the fuel and/or additives recommended for your engine. Failure to comply may result in death, personal injury, equipment or property damage.

**Specification:** Use only Ultra Low Sulfur Diesel (ULSD) Fuel, as recommended by engine manufacturers. If you need further information on fuel specifications, consult the Engine Operation and Maintenance Manual.

### Location of Fuel Shut-Off Valves

If your vehicle is equipped with shut-off valves for the take-off and return lines, they are located on the fuel lines entering the top of the fuel tank. Fuel shut-off valves for the fuel crossover line are on the bottom of the fuel tank, at the crossover line connection.

### Refuel Before the Final Stop

Air space in your fuel tanks allows water to condense there. To prevent this condensation while you are stopped, fill your tanks to 95% of capacity.

# STOPPING THE ENGINE

## Final Stop

To make sure your vehicle is ready to go after a long stop (such as over night), please follow the suggestions below. Your vehicle will be easier to get going when you are ready, and it will be safer for anyone who might be around it. Please remember, too, that in some states it is illegal to leave the engine running and the vehicle unattended.

## Final Stopping Procedures

1. Set the parking brake before leaving the driver's seat. To hold your vehicle while it is parked, don't rely on:

- Air Brakes
- Hand Control Valve for Trailer Brakes
- Engine Compression

 <b>WARNING!</b>	
Using the trailer hand brake or air brakes to hold a parked vehicle is dangerous. Because they work with air pressure, these brakes could come loose. Your vehicle could roll, causing an accident involving death or personal injury. Always set the parking brakes. Never rely on the trailer hand brake or truck air brakes to hold a parked vehicle.	

2. If you are parked on a steep grade, block the wheels.

Suitable wheel chocks are at a minimum an 18-inch (46 cm) long 4x4.

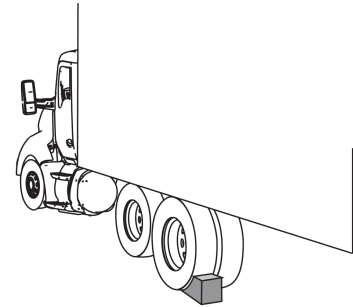

## Blocked Wheels

3. Drain water from the air reservoirs. While the engine and air supply system are still warm, drain moisture from the air reservoirs. Open the reservoir drains just enough to drain the moisture. Don't deplete the entire



air supply. Be sure to close the drains before leaving the vehicle.

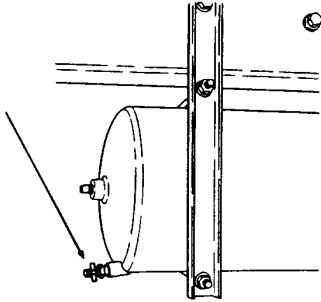

### Opening Drains

4. Secure the vehicle. Close all the windows and lock all the doors.



**PREVENTIVE MAINTENANCE SCHEDULE**

Introduction . . . . . 5-9  
Maintenance Schedule . . . . . 5-12

**LUBRICANT SPECIFICATIONS**

Introduction . . . . . 5-35  
Engine . . . . . 5-35  
Master Lubrication Index . . . . . 5-38  
Fuller Transmission Lubrication . . . . . 5-41  
Allison Transmission Lubrication . . . . . 5-43  
Spicer Transmission Lubrication . . . . . 5-43  
Oil Changes . . . . . 5-44  
Meritor Axle Lubrication . . . . . 5-45  
Eaton/Dana Axle Lubrication . . . . . 5-46  
Wheel Bearing Lubrication . . . . . 5-47  
Universal Joint Lubrication . . . . . 5-47  
Steering Gear Lubrication . . . . . 5-48

**AIR SYSTEM**

Introduction . . . . . 5-49  
Air Dryer . . . . . 5-52  
Air Tanks . . . . . 5-54  
Air Gauges and Air Leaks . . . . . 5-55  
Air Compressor . . . . . 5-56

**BRAKE SYSTEM**

Brake Adjustment . . . . . 5-58

**CAB**

Exterior Maintenance . . . . . 5-63  
Cleaning, Protecting and Weather Stripping . . . . . 5-64  
Safety Restraint System - Inspection . . . . . 5-68  
Windshield Wiper/Washer . . . . . 5-71

**COOLING SYSTEM**

Cooling system maintenance . . . . . 5-72  
Engine (Block) Heater . . . . . 5-75

**ELECTRICAL**

Electrical System . . . . . 5-77  
Light Bulbs . . . . . 5-78  
Bulb Specifications . . . . . 5-79  
Fuses, Circuit Breakers and Relays . . . . . 5-80  
Fuse Inspection and Replacement . . . . . 5-84  
Adding Electrical Options . . . . . 5-84  
Batteries . . . . . 5-85  
Battery Care . . . . . 5-89  
Battery Charging . . . . . 5-89  
Electrical and Alternator Precautions . . . . . 5-91  
Remote Keyless Entry . . . . . 5-92

**ENGINE**

Engine Maintenance . . . . . 5-93  
Engine Lubrication . . . . . 5-94  
Accessory Drive Belts . . . . . 5-97  
Engine Fan . . . . . 5-98  
Air Intake System . . . . . 5-99

Turbocharger . . . . . 5-99  
Air Cleaners . . . . . 5-100  
ServiSignal™ Mini Indicator . . . . . 5-101  
Exhaust System . . . . . 5-101  
Engine Mounting . . . . . 5-101

**FUEL SYSTEM**

Location of Fuel Shut-off Valves. . . . . 5-103  
Specification . . . . . 5-103  
Fuel Filters . . . . . 5-103

**FRAME**

Introduction . . . . . 5-104

**FRONT AXLE AND SUSPENSION**

Axle Lubrication . . . . . 5-108  
Inspection . . . . . 5-109  
Wheel Alignment . . . . . 5-109  
U-Bolt Torque . . . . . 5-110

**HEATER AND AIR CONDITIONER**

Introduction . . . . . 5-112  
Air Filters . . . . . 5-113  
Heater. . . . . 5-115  
Air Conditioner . . . . . 5-116

**NOISE AND EMISSION CONTROL**

Noise Emission Warranty . . . . . 5-117  
Inspection and Maintenance Instructions . . . . . 5-118  
Noise Control System - Maintenance Log . . . . . 5-124

**REAR AXLE AND SUSPENSION**

General Maintenance . . . . . 5-125  
Visual Inspection . . . . . 5-126  
Rear Suspension Fasteners . . . . . 5-127  
Rear Axle Lubrication . . . . . 5-128  
Rear Axle Alignment . . . . . 5-130

**STEERING SYSTEM**

Power Steering . . . . . 5-131

Fluid Level and Refill . . . . . 5-132  
Steering Shaft . . . . . 5-133

**DRIVELINE**

Driveshaft Maintenance . . . . . 5-135  
U-Joints . . . . . 5-135

**TIRES AND WHEEL**

Tires . . . . . 5-136  
Wheel Mounting and Fastening . . . . . 5-142  
Wheel Replacement with Disc Brake Option . . . . . 5-144  
Disc Wheels . . . . . 5-145

**WHEEL BEARING**

Wheel Bearing Adjustment . . . . . 5-146

**TRANSMISSION MAINTENANCE**

Introduction . . . . . 5-147  
Transmission Lubricants . . . . . 5-148  
Automatic Transmissions . . . . . 5-149



**CLUTCH**

Introduction . . . . . 5-150  
Clutch Hydraulic Fluid . . . . . 5-150  
Clutch Adjustment . . . . . 5-151  
Clutch Adjustment – Normal Wear . . . . . 5-151





## PREVENTIVE MAINTENANCE SCHEDULE

### Introduction

Preventive maintenance program begins with the daily checks. See Driver's Check List on page 1-36 for these routine checks. Routine vehicle checks can help avoid many large, expensive, and time consuming repairs. The vehicle will operate better, be safer, and last longer. Neglect of recommended maintenance can void your vehicle's warranty. Some maintenance operations demand skills and equipment you may not have. For such situations, please take your vehicle to an authorized Service Center.

 <b>WARNING!</b>
Before attempting any procedures in the engine compartment, stop the engine and let it cool down. Hot components can burn skin on contact. Failure to comply may result in death, personal injury, equipment or property damage.

 <b>WARNING!</b>
If the engine must be operating to inspect, be alert and cautious around the engine at all times. Failure to comply may result in death, personal injury, equipment or property damage.

 <b>WARNING!</b>
If work has to be done with the engine running, always (1) set the parking brake, (2) block the wheels, and (3) ensure that the shift lever or selector is in Neutral. Failure to comply may result in death, personal injury, equipment or property damage.

 <b>WARNING!</b>
Exercise extreme caution to prevent neckties, jewelry, long hair, or loose clothing from getting caught in the fan blades or any other moving engine parts. Failure to comply may result in death, personal injury, equipment or property damage.

# PREVENTIVE MAINTENANCE SCHEDULE

---



## WARNING!

Disconnect the battery ground strap whenever you work on the fuel system or the electrical system. When you work around fuel, do not smoke or work near heaters or other fire hazards. Keep an approved fire extinguisher handy. Failure to comply may result in death, personal injury, equipment or property damage.



## WARNING!

Always support the vehicle with appropriate safety stands if it is necessary to work underneath the vehicle. A jack is not adequate for this purpose. Failure to comply may result in death, personal injury, equipment or property damage.



## WARNING!

When working underneath the vehicle without appropriate safety stands but with the wheels on the ground (not supported), make sure that (1) the vehicle is on hard level ground, (2) the parking brake is applied, (3) all wheels are blocked (front and rear) and (4) remove the ignition key so that the engine cannot be started. Failure to comply may result in death, personal injury, equipment or property damage.



## WARNING!

Never start or let the engine run in an enclosed, unventilated area. Exhaust fumes from the engine contain carbon monoxide, a colorless and odorless gas. Carbon monoxide can be fatal if inhaled. Failure to comply may result in death, personal injury, equipment or property damage.

The following pages contain a table of maintenance tasks with the related intervals for each task on the right side of the table. The top of the table displays a guide to a maintenance interval and its schedule. Some tasks are dependent on the vehicle application. These tasks will be shown as separate tasks and will have the words “ON HIGHWAY”, “CITY DELIVERY” or “OFF-HIGHWAY” after the description. These tasks are differentiated because they are dependent on the vehicle’s operating environment.

On highway is defined for applications where the vehicle is NOT used off of a paved road during normal operation.

City Delivery is defined for applications where frequent start and stopping is required during normal operation and the highway is used infrequently and for short periods of time.

Off highway is defined for applications where the vehicle may be driven off the pavement on a regular basis, even if it is an infrequent basis and/or for a brief time period.

Please contact an authorized service dealership if there are questions regarding which interval to follow. Consult the supplier for specific recommendations where discrepancies develop between these recommendations in this table and component supplier recommendations.

- Engine lubricating oil change intervals aren't listed here. Refer to your engine's operating manual for recommendations. For specific information on maintenance procedures consult your vehicle maintenance manual.
- The initial fill of drive axle lubricant must be changed before the end of the first scheduled maintenance

interval. Refer to Oil Changes on page 5-44 before you put a new vehicle into service.

- The initial fill of lubricant in manual transmissions must be changed before the end of the first maintenance interval. See Fuller Transmission Lubrication on page 5-41 for specific information.
- If your vehicle is equipped with an automatic transmission, consult the owner's manual for it that came with your vehicle to obtain lubricant check and change intervals.

# PREVENTIVE MAINTENANCE SCHEDULE

## Maintenance Schedule

### New Vehicle Maintenance Schedule

New Vehicle Maintenance Schedule					
Operation\Frequency	First Day	After First Miles (km)			
		50 – 100 (80 – 160)	500 (800)	2,000 (3218)	3,000 –5,000 (4800 –8000)
Steering Shaft U-Bolts. (OFF-HIGHWAY) See Steering System on page 5-131.	X				
Wheel Mounting. See Wheel Mounting and Fastening on page 5-142.		X			
Front Axle U-Bolt Torque. See Front Spring Suspension U-Bolts on page 5-110.			X		
Charge Air Cooler and Air Intake Pipe Clamps, re- torque fasteners.			X		
Rear Suspension Fasteners. See Rear Suspension Fasteners on page 5-127.				X	
Transmission Lubrication. 1. For Fuller transmission, see Fuller Transmission Lubrication on page 5-41. 2. For Allison transmission, see Allison Transmission Lubrication on page 5-43. 3. For Spicer transmission, see Spicer Transmission Lubrication on page 5-43.					X
Axle Lubrication. 1. For Meritor axle, see Meritor Axle Lubrication on page 5-45. 2. For Eaton/Dana axle, see Eaton/Dana Axle Lubrication on page 5-46.					X

# PREVENTIVE MAINTENANCE SCHEDULE

PREVENTIVE MAINTENANCE (PM) INTERVALS										
		I	A	B	C	D	E			
		At first 15,000 mi/ 24,000 km or at the first PM	15,000 mi/ 24,000 km/ Monthly	30,000 mi/ 48,000 km	60,000 mi/ 96,000 km/ 6 Months	120,000 mi/ 192,000 km/ Annually	240,000 mi/ 384,000 km			
SYSTEM	COMPONENT	MAINTENANCE TASK			Recommended PM Interval					
					I	A	B	C	D	E
Frame	Fifth Wheel	Check the kingpin lock and plate for wear and function; lubricate (NLGI #2 grease).			X					
		Inspect fifth wheel operation (shown on page 5-127)						X		
	Frame Fasteners	Check for tightness; tighten to the specified torque value as required (shown on page 5-104).							X	
	Crossmembers and Mounting Brackets	Inspect for cracks and loose fasteners. Replace or tighten to the specified torque value as required (shown on page 5-104).							X	
	Engine Mounting	Inspect engine mounts every 60,000 miles (96,560 km) (shown on page 5-101). Contact an authorized vehicle OEM dealership if engine mounts need servicing.						X		

# PREVENTIVE MAINTENANCE SCHEDULE

PREVENTIVE MAINTENANCE (PM) INTERVALS								
	I	A	B	C	D	E		
	At first 15,000 mi/ 24,000 km or at the first PM	15,000 mi/ 24,000 km/ Monthly	30,000 mi/ 48,000 km	60,000 mi/ 96,000 km/ 6 Months	120,000 mi/ 192,000 km/ Annually	240,000 mi/ 384,000 km		
SYSTEM	COMPONENT	MAINTENANCE TASK	Recommended PM Interval					
			I	A	B	C	D	E
Front Axle (Meritor)	Total Vehicle Alignment	Check and adjust as required.	X				X	
	Steering knuckle spindles, thrust bearings, kingpins, drawkeys, tie rod ends, steering stops, and bushings	Inspect for wear and damage and endplay. Shim or replace as required (shown on page 5-131).					X	
	Kingpin bushings, thrust bearings, and tie rod ball ends	Lubricate with approved grease.				X		
	Drawkeys	Tighten nuts	X		X			

5



# PREVENTIVE MAINTENANCE SCHEDULE

<b>PREVENTIVE MAINTENANCE (PM) INTERVALS</b>								
		I	A	B	C	D	E	
		At first 15,000 mi/ 24,000 km or at the first PM	15,000 mi/ 24,000 km/ Monthly	30,000 mi/ 48,000 km	60,000 mi/ 96,000 km/ 6 Months	120,000 mi/ 192,000 km/ Annually	240,000 mi/ 384,000 km	
SYSTEM	COMPONENT	MAINTENANCE TASK	Recommended PM Interval					
			I	A	B	C	D	E
Front Axle (Dana)	Total Vehicle Alignment	Check and adjust as required.	X				X	
	Kingpin bushings, thrust bearings, and tie rod ball ends (ON HIGHWAY)	Lubricate with approved grease.					X	
	Kingpin bushings, thrust bearings, and tie rod ball ends (OFF-HIGHWAY)	Lubricate with approved grease.				X		
	Steering knuckle spindles, thrust bearings, kingpins, drawkeys, tie rod ends, steering stops, and bushings (ON HIGHWAY)	Inspect for wear and damage and for endplay. Shim or replace as required.					X	
	Steering knuckle spindles, thrust bearings, kingpins, drawkeys, tie rod ends, steering stops, and bushings (OFF-HIGHWAY)	Inspect for wear and damage and for endplay. Shim or replace as required.				X		

# PREVENTIVE MAINTENANCE SCHEDULE

PREVENTIVE MAINTENANCE (PM) INTERVALS								
	I	A	B	C	D	E		
	At first 15,000 mi/ 24,000 km or at the first PM	15,000 mi/ 24,000 km/ Monthly	30,000 mi/ 48,000 km	60,000 mi/ 96,000 km/ 6 Months	120,000 mi/ 192,000 km/ Annually	240,000 mi/ 384,000 km		
SYSTEM	COMPONENT	MAINTENANCE TASK	Recommended PM Interval					
			I	A	B	C	D	E
Front Suspension	Front Spring	Inspect for cracked leaves, worn bushings, and excessive corrosion.				X		
	Spring Pins and Shackles	Inspect for worn parts and excessive joint clearance. Shim or replace as required.				X		
	Shock Absorbers	Inspect for leaking, body damage, and damaged or worn bushings. Replace as required. Check the shock mounting stud torque.				X		
	Spring Pins	Lubricate with approved grease.			X			
		Check for proper function.		X				
	U-bolts (ON HIGHWAY)	Check the general condition and the tightness of the nuts. Tighten the nuts to the specified torque value as required (shown on page 5-111).	X			X		
U-bolts (OFF HIGHWAY)	Check the general condition and the tightness of the nuts. Tighten the U-bolts after the first day or two of operation. Then tighten the nuts to the specified torque value as required (shown on page 5-111).		X					

# PREVENTIVE MAINTENANCE SCHEDULE

<b>PREVENTIVE MAINTENANCE (PM) INTERVALS</b>						
	I	A	B	C	D	E
	At first 15,000 mi/ 24,000 km or at the first PM	15,000 mi/ 24,000 km/ Monthly	30,000 mi/ 48,000 km	60,000 mi/ 96,000 km/ 6 Months	120,000 mi/ 192,000 km/ Annually	240,000 mi/ 384,000 km

SYSTEM	COMPONENT	MAINTENANCE TASK	Recommended PM Interval					
			I	A	B	C	D	E
Drive Axle (Dana)	Axle Housing	Visually inspect for damage or leaks.				X		
		Check oil level. Check "cold." Torque the drain plug.				X		
		Drain the lubricant while warm. Flush each unit with clean flushing oil. Change the lubricant.	See information on page 5-45					
	Air Shift Unit	Check the lubricant level.				X		
		Remove the housing cover and drain the lubricant. Wash the parts thoroughly and dry in air.					X	
	Breather	Clean or replace.					X	
	Lube Pump (ON HIGHWAY)	Remove the magnetic strainer and inspect for wear particles. Wash in solvent and dry in air.					X	
	Lube Pump (OFF HIGHWAY)	Remove the magnetic strainer and inspect for wear particles. Wash in solvent and dry in air.					X	
	Lube Filter (ON HIGHWAY)	Change.					X	
	Lube Filter (OFF HIGHWAY)	Change.					X	
	Magnetic drain plug and breather (ON HIGHWAY)	Clean or replace.					X	
	Magnetic drain plug and breather (OFF HIGHWAY)	Clean or replace.					X	

# PREVENTIVE MAINTENANCE SCHEDULE

PREVENTIVE MAINTENANCE (PM) INTERVALS								
	I	A	B	C	D	E		
	At first 15,000 mi/ 24,000 km or at the first PM	15,000 mi/ 24,000 km/ Monthly	30,000 mi/ 48,000 km	60,000 mi/ 96,000 km/ 6 Months	120,000 mi/ 192,000 km/ Annually	240,000 mi/ 384,000 km		
SYSTEM	COMPONENT	MAINTENANCE TASK	Recommended PM Interval					
			I	A	B	C	D	E
Drive Axle (Meritor)	Axle Housing	Check the "cold" fill level at the differential carrier plug for a pinion angle of less than 7 degrees, or at the axle bowl plug for a pinion angle of greater than 7 degrees. Tighten the plug to 35-50 Lb. ft. (47-68 N.m.)				X		
		Visually inspect for damage or leaks.				X		
		Drain and replace the lubricant.	See information on page 5-44					
	Lubricant filter	Change the filter.					X	
	Breather	Check the operation. If the cap doesn't rotate freely, replace.				X		
	Input shaft and pinion shaft	Check and adjust the endplay.					X	
	Axle shaft	Tighten the rear axle flange nuts to the specified torque value.					X	
Interaxle differential	Check the operation.					X		
Drive Axle (SISU)	Axle Housing	Change the oil in the differential carrier and the hubs, and clean the magnetic oil drain plugs.	X				X	
		Check the wheel bearing hubs and adjust if necessary.	X			X		
		Visually inspect for damage or leaks.	X			X		
		Check the oil level in the differential carrier and hubs.				X		
	Breather	Check the breather for proper operation.				X		
	Lube Filter	Clean the suction filter for the optional pressure lubrication system.					X	
	S-cam brakes	Overhaul the brakes; degrease all moving parts; check the bushings and seals for wear.				X		

# PREVENTIVE MAINTENANCE SCHEDULE

<b>PREVENTIVE MAINTENANCE (PM) INTERVALS</b>								
	I	A	B	C	D	E		
	At first 15,000 mi/ 24,000 km or at the first PM	15,000 mi/ 24,000 km/ Monthly	30,000 mi/ 48,000 km	60,000 mi/ 96,000 km/ 6 Months	120,000 mi/ 192,000 km/ Annually	240,000 mi/ 384,000 km		
SYSTEM	COMPONENT	MAINTENANCE TASK	Recommended PM Interval					
			I	A	B	C	D	E
Rear Suspension	U-bolts	Check the torque. Tighten to specified torque value as required (shown on page 5-128).	X			X		
	Frame and crossmember bolts	Check the torque. Tighten to specified torque value as required (shown on page 5-106).					X	
	Mounting brackets and fasteners	Check the condition and the fastener torque. Tighten to the specified torque value as required (shown on page 5-106).	X				X	

# PREVENTIVE MAINTENANCE SCHEDULE

PREVENTIVE MAINTENANCE (PM) INTERVALS						
	I	A	B	C	D	E
	At first 15,000 mi/ 24,000 km or at the first PM	15,000 mi/ 24,000 km/ Monthly	30,000 mi/ 48,000 km	60,000 mi/ 96,000 km/ 6 Months	120,000 mi/ 192,000 km/ Annually	240,000 mi/ 384,000 km

SYSTEM	COMPONENT	MAINTENANCE TASK	Recommended PM Interval					
			I	A	B	C	D	E
Drum Brakes (All)	Slack adjusters	Check the push rod travel and check the control arm for cracks. Adjust at reline (shown on page 5-61).		X				
		Lubricate (NLGI #2 grease).		X				
	Brake camshaft bearing	Check for excessive camshaft paly in the axial and radial directions. Max allowable play is 0.003 in. Lubricate (NLGI #2 grease).				X		
	Brake treadle valve	Clean the area around the treadle, boot, and mounting plate. Check the pivot and mounting plate for integrity. Check the plunger boot for cracks. Lubricate roller pin, pivot pin, and plunger (NLGI #2 grease).			X			
	Brake air system	Check air lines and fittings for leaks (shown on page 5-49). Adjust routing as required to prevent chafing. Check tank mounting and condition.		X				
		Clean or replace the inline filters.				X		
	Brake lining	Inspect; replace as required.			X			

# PREVENTIVE MAINTENANCE SCHEDULE

<b>PREVENTIVE MAINTENANCE (PM) INTERVALS</b>							
	I	A	B	C	D	E	
	At first 15,000 mi/ 24,000 km or at the first PM	15,000 mi/ 24,000 km/ Monthly	30,000 mi/ 48,000 km	60,000 mi/ 96,000 km/ 6 Months	120,000 mi/ 192,000 km/ Annually	240,000 mi/ 384,000 km	
SYSTEM	COMPONENT	MAINTENANCE TASK	Recommended PM Interval				
			I	A	B	C	D
Disc Brakes (Bendix®)	Brake pads	Inspect; replace as required.				X	
	Brake disc/rotor	Inspect for visible cracks, heat checking, galling, or scoring of surface. Check for runout (max allowable is 0.002 in.).				X	
	Caliper sliding function	Ensure caliper slides freely with no obstructions or excessive play.				X	
	Caliper slide pins	Inspect protective caps of the guide pins for damage or cracking.				X	
	System operation	Check operation; inspect as per manufacturer's service literature.				X	

# PREVENTIVE MAINTENANCE SCHEDULE

## PREVENTIVE MAINTENANCE (PM) INTERVALS

I	A	B	C	D	E
At first 15,000 mi/ 24,000 km or at the first PM	15,000 mi/ 24,000 km/ Monthly	30,000 mi/ 48,000 km	60,000 mi/ 96,000 km/ 6 Months	120,000 mi/ 192,000 km/ Annually	240,000 mi/ 384,000 km

SYSTEM	COMPONENT	MAINTENANCE TASK	Recommended PM Interval					
			I	A	B	C	D	E
Hub, Drum, and Hubcap	Hubs (non-LMS)	Check the bearing endplay and adjust as required (shown on page 5-47).			X			
	Hubs (non-LMS) with outrunner seals	Clean the components and check for excessive wear or damage. Change the oil and seal (shown on page 5-47).						X
	Hubs (non-LMS) with standard seals	Clean the components and check for excessive wear or damage. Change the oil and seal (shown on page 5-47).					X	
	Hub seals (all)	Check for leaks; replace as required.			X			
	LMS Hubs (Dana)	Inspect for leaks. Check the bearing endplay and adjust as required (shown on page 5-47).				X		
	LMS Hubs (Dana) with Synthetic Lubricant	Service the bearings, seals and oil. This interval may be different depending on the results of the regular inspection. (shown on page 5-47).	500,000 miles/ 800,000 km					
	LMS Hubs (Dana) with Mineral Lubricant	Service the bearings, seals and oil. This interval may be different depending on the results of the regular inspection. (shown on page 5-47).	350,000 miles/ 560,000 km					
	Brake drums	Inspect for visible cracks, heat checking, galling or scoring of the braking surface, and for severe corrosion on the outside surface. Check for out-of-round or oversize condition [0.080 in. (2 mm) more than the original diameter]. Replace as required.			X			
Hubcaps	Clean the sight window. Check the center plug, mounting flange, and fill plug for leaks and for proper installation. Replace broken or damaged parts. Check the lubricant level and add as required.		X					



# PREVENTIVE MAINTENANCE SCHEDULE

PREVENTIVE MAINTENANCE (PM) INTERVALS								
	I	A	B	C	D	E		
	At first 15,000 mi/ 24,000 km or at the first PM	15,000 mi/ 24,000 km/ Monthly	30,000 mi/ 48,000 km	60,000 mi/ 96,000 km/ 6 Months	120,000 mi/ 192,000 km/ Annually	240,000 mi/ 384,000 km		
SYSTEM	COMPONENT	MAINTENANCE TASK	Recommended PM Interval					
			I	A	B	C	D	E
Main and auxiliary transmission	Main and auxiliary transmission and transfer case	Inspect for visible damage, signs of overheating, and leaks. Check the drain plugs for tightness.	X	X	X			
		Mounting Brackets and Fasteners	Check the condition of the fasteners and their torque. Tighten to the specified torque value as required.			X		
	Oil cooler	Clean the fins (air-to-oil type) and body. Check the hose condition and for leaks; replace as required.				X		
	Main and aux. transmission	Check the oil level; refill as required.			X			
	Main and auxiliary transmission (ON HIGHWAY)	Drain lubricant while warm. Flush each unit with clean flushing oil.	500,000 miles/ 800,000 km					
	Main and auxiliary transmission (OFF HIGHWAY)	Drain lubricant while warm. Flush each unit with clean flushing oil.	X			X		
Auxiliary transmission	Cotta Transfer Case TR2205	Inspect: Check oil level; inspect for leaks and any visible damage.		X				
	Fabco Transfer Case TC142/TC143/TC170/TC270	Initial oil change: Drain oil while warm; flush case with gear oil-compatible fluid; clean magnetic drain plug; refill. Do not flush the case with any solvent.	X			X		
	Marmon-Harrington Transfer Case MVG2000/MVG2000SD	Change oil.				X		

# PREVENTIVE MAINTENANCE SCHEDULE

PREVENTIVE MAINTENANCE (PM) INTERVALS								
	I	A	B	C	D	E		
	At first 15,000 mi/ 24,000 km or at the first PM	15,000 mi/ 24,000 km/ Monthly	30,000 mi/ 48,000 km	60,000 mi/ 96,000 km/ 6 Months	120,000 mi/ 192,000 km/ Annually	240,000 mi/ 384,000 km		
SYSTEM	COMPONENT	MAINTENANCE TASK	Recommended PM Interval					
			I	A	B	C	D	E
Air Intake	Air intake piping, mounting, and charge air cooler	Check the system for broken pipes, leaks, joint integrity, cleanliness, and proper support (shown on page 5-99).				X		
	Cold starting aids	Check for leaks and proper operation (shown on page 4-10).					X	
	Air cleaner	Replace the engine intake air cleaner element (shown on page 5-100).	When required by air restriction indicator or required by the engine manufacturers operator manual.					
Clutch	Clutch hydraulic fluid	Replace fluid and bleed system.						X
	Clutch release bearing	Lubricate.			X			
		Inspect and adjust when necessary (no adjustment required for SOLO type clutches)			X			

# PREVENTIVE MAINTENANCE SCHEDULE

PREVENTIVE MAINTENANCE (PM) INTERVALS										
		I	A	B	C	D	E			
		At first 15,000 mi/ 24,000 km or at the first PM	15,000 mi/ 24,000 km/ Monthly	30,000 mi/ 48,000 km	60,000 mi/ 96,000 km/ 6 Months	120,000 mi/ 192,000 km/ Annually	240,000 mi/ 384,000 km			
SYSTEM	COMPONENT	MAINTENANCE TASK			Recommended PM Interval					
					I	A	B	C	D	E
Cooling	Hoses	Check the radiator and heater hoses for leaks.			X			X		
	Extended Life Coolant (ELC)	Check the freeze point (shown on page 5-73).					X			
		Check for contamination using test strips (shown on page 5-72).					X			
		Replace blank water filter if applicable.							X	
		Perform lab analysis (shown on page 5-72).							X	
		If lab analysis shows coolant is unsuitable for continued use: Flush, drain, and refill (shown on page 5-72).							X	
		Add ELC Extender (shown on page 5-72).								
	Flush, drain, and refill with new coolant (shown on page 5-72).								X	
Fan clutch	Check for air leaks. (shown on page 5-98). Check the fan drive bearings (turn the sheave in both directions to check for worn hub bearings).			X			X			
Solenoid valve	Check the fan drive for proper engagement and disengagement.			X			X			

# PREVENTIVE MAINTENANCE SCHEDULE

PREVENTIVE MAINTENANCE (PM) INTERVALS							
	I	A	B	C	D	E	
	At first 15,000 mi/ 24,000 km or at the first PM	15,000 mi/ 24,000 km/ Monthly	30,000 mi/ 48,000 km	60,000 mi/ 96,000 km/ 6 Months	120,000 mi/ 192,000 km/ Annually	240,000 mi/ 384,000 km	
SYSTEM	COMPONENT	MAINTENANCE TASK	Recommended PM Interval				
			I	A	B	C	D
Tires and Wheels	Tires	Check inflation pressure (shown on page 5-136).	Weekly "cold" using calibrated gauge				
		Inspect for cuts, irregular wear, missing lugs, sidewall damage, etc.		X			
	Disc wheels	Inspect the wheel disc for any cracks or surface irregularities. Inspect the rim edge and bead seat area for damage. Replace any damaged wheels - DO NOT ATTEMPT TO REPAIR.		X			
	Demountable rims	Inspect the mounting ring, rim gutter, side ring, and lock ring for damage; replace as required.		X			
	Wheel nuts and studs	Check the tightness of the fasteners and tighten the fasteners to the specified torque as required (shown on page 5-142).		X			
Inspect for damaged hex corners, stripped or damaged threads, and excessive corrosion; clean or replace as required.			X				

# PREVENTIVE MAINTENANCE SCHEDULE

PREVENTIVE MAINTENANCE (PM) INTERVALS						
	I	A	B	C	D	E
	At first 15,000 mi/ 24,000 km or at the first PM	15,000 mi/ 24,000 km/ Monthly	30,000 mi/ 48,000 km	60,000 mi/ 96,000 km/ 6 Months	120,000 mi/ 192,000 km/ Annually	240,000 mi/ 384,000 km

SYSTEM	COMPONENT	MAINTENANCE TASK	Recommended PM Interval					
			I	A	B	C	D	E
Power Steering	Reservoir	Check the fluid level (shown on page 5-48).		X				
	Reservoir (ON HIGHWAY)	Drain, replace the filter, and refill (shown on page 5-48).	X				X	
	Reservoir (OFF HIGHWAY)	Drain, replace the filter, and refill (shown on page 5-48).	X			X		
	Steering gear	Check the lash of the sector shaft; adjust as required.				X		
		Grease the trunion bearing (EP NLGI #2 lithium-based, moly-filled, HD grease).				X		
		Grease the input shaft seal (EP NLGI #2 lithium-based, moly-filled, HD grease).				X		
	Power assist cylinder	Lubricate the ball joints. Inspect for leaking rod seals, damaged ball joint boots, and damage to cylinder rod or barrel.		X				
	Hoses and tubes	Check for leaks and chafing.				X		
	Steering linkage	Check all joints for excessive lash; replace as required (shown on page 5-131).					X	
	Draglink tube clamp and ball socket	Check the torque; tighten to specified torque value as required.	X			X		
Pitman arm clamp bolt and nut	Check the torque; tighten to specified torque value as required.	X			X			
Steering intermediate shaft	Check the torque on the pinch bolt and nut.	X			X			

# PREVENTIVE MAINTENANCE SCHEDULE

PREVENTIVE MAINTENANCE (PM) INTERVALS								
	I	A	B	C	D	E		
	At first 15,000 mi/ 24,000 km or at the first PM	15,000 mi/ 24,000 km/ Monthly	30,000 mi/ 48,000 km	60,000 mi/ 96,000 km/ 6 Months	120,000 mi/ 192,000 km/ Annually	240,000 mi/ 384,000 km		
SYSTEM	COMPONENT	MAINTENANCE TASK	Recommended PM Interval					
			I	A	B	C	D	E
Power Steering	Steering intermediate shaft U-joints (ON HIGHWAY)	Lubricate [EP NLGI #2 HD grease, +325° F to -10° F (+163° C to -23° C) range].	X			X		
	Steering intermediate shaft U-joints (OFF HIGHWAY or CITY DELIVERY)	Lubricate [EP NLGI #2 HD grease, +325° F to -10° F (+163° C to -23° C) range].	X		X			
	Draglink and tie rod arm ball sockets (ON HIGHWAY)	Lubricate (EP NLGI #2 lithium-based, moly-filled, HD grease).	X		X			
	Draglink and tie rod arm ball sockets (OFF HIGHWAY or CITY DELIVERY)	Lubricate (EP NLGI #2 lithium-based, moly-filled, HD grease).	X	X				
Fuel and Tanks	Fuel tanks	Inspect tanks, brackets, hoses, and fittings for correct location, tightness, abrasion damage, and leaks; repair or replace as required.				X		
	Fuel tank breathers	Check for proper function; clean the drain hoses.					X	
	Fuel tank straps	Check the strap tightness; tighten to proper torque value as required: Aluminum tank: 30 Lb. ft. (41 N.m.) Cylindrical Steel tank: 8 Lb. ft. (11 N.m.)	X		X			

5

# PREVENTIVE MAINTENANCE SCHEDULE

PREVENTIVE MAINTENANCE (PM) INTERVALS						
	I	A	B	C	D	E
	At first 15,000 mi/ 24,000 km or at the first PM	15,000 mi/ 24,000 km/ Monthly	30,000 mi/ 48,000 km	60,000 mi/ 96,000 km/ 6 Months	120,000 mi/ 192,000 km/ Annually	240,000 mi/ 384,000 km

SYSTEM	COMPONENT	MAINTENANCE TASK	Recommended PM Interval					
			I	A	B	C	D	E
Driveshafts	Models SPL-90, 1710 and 1810 slip member and U-joints	Lubricate*.	X	X				
		Inspect.	U-joint inspections should be performed every time a vehicle comes in for scheduled maintenance.**					
	Model SPL-100 slip member and U-joints	Lubricate*.	X					
		Inspect.	U-joint inspections should be performed every time a vehicle comes in for scheduled maintenance.**					
	Models SPL-140/140HD/170/170HD/250/250HD slip members and U-joints (ON HIGHWAY and LINEHAUL)	Lubricate*.				X		
		Inspect.	U-joint inspections should be performed every time a vehicle comes in for scheduled maintenance.**					

# PREVENTIVE MAINTENANCE SCHEDULE

PREVENTIVE MAINTENANCE (PM) INTERVALS						
I	A	B	C	D	E	
At first 15,000 mi/ 24,000 km or at the first PM	15,000 mi/ 24,000 km/ Monthly	30,000 mi/ 48,000 km	60,000 mi/ 96,000 km/ 6 Months	120,000 mi/ 192,000 km/ Annually	240,000 mi/ 384,000 km	

SYSTEM	COMPONENT	MAINTENANCE TASK	Recommended PM Interval						
			I	A	B	C	D	E	
Driveshafts	Models SPL-140/140HD/170/ 170HD/250/250HD slip members and U-joints (OFF HIGHWAY)	Lubricate*.	X						
		Inspect.	U-joint inspections should be performed every time a vehicle comes in for scheduled maintenance.**						
	Models SPL-140XL/170XL/250XL slip members and U-joints (ON HIGHWAY and LINE HAUL)	Lubricate*.	350,000 mi (560,000 km) 1st interval and then every 100,000 mi (160,000 km) after that.						
		Inspect.	U-joint inspections should be performed every time a vehicle comes in for scheduled maintenance.**						
	Models SPL-140XL/170XL/250XL slip members and U-joints (OFF HIGHWAY and CITY)	Lubricate*.					X		
		Inspect.	U-joint inspections should be performed every time a vehicle comes in for scheduled maintenance.**						
*Use only Spicer Driveshaft approved lubricants when greasing Spicer U-joints.									
**Refer to Spicer Driveshaft service manual DSSM-0100 (3264-SPL) for detailed instructions.									



# PREVENTIVE MAINTENANCE SCHEDULE

PREVENTIVE MAINTENANCE (PM) INTERVALS						
	I	A	B	C	D	E
	At first 15,000 mi/ 24,000 km or at the first PM	15,000 mi/ 24,000 km/ Monthly	30,000 mi/ 48,000 km	60,000 mi/ 96,000 km/ 6 Months	120,000 mi/ 192,000 km/ Annually	240,000 mi/ 384,000 km

SYSTEM	COMPONENT	MAINTENANCE TASK	Recommended PM Interval					
			I	A	B	C	D	E
Battery Boxes, Tool Boxes, and Steps	Battery cables	Check the condition of the cables, cushion clamps, nylon tie straps, and routing. Replace a cushion clamp if the rubber has deteriorated. Repair or tighten terminals, and secure cables to prevent chafing. Replace damaged cables (cuts, cracks, or excessive wear) (shown on page 5-77).		X				
	Batteries (ON HIGHWAY and LINE HAUL)	Check for cracks and damage, electrolyte level, condition of terminals, and tightness of holddowns (shown on page 5-77).				X		
	Batteries (OFF-HIGHWAY)	Check for cracks and damage, electrolyte level, condition of terminals, and tightness of holddowns (shown on page 5-77).		X				
	Battery box and tray (ON HIGHWAY and LINE HAUL)	Check the box integrity. Clean the drain tube and check for acid leaks. Check condition of all equipment mounted under the box.				X		
	Battery box and tray (OFF-HIGHWAY)	Check the box integrity. Clean the drain tube and check for acid leaks. Check condition of all equipment mounted under the box.		X				
	Battery Cable Fasteners	Check battery cable fasteners and tighten as necessary to 10-15 Lb. ft. (13.6-20.3 N.m.) as specified on the battery label.		X				

# PREVENTIVE MAINTENANCE SCHEDULE

PREVENTIVE MAINTENANCE (PM) INTERVALS								
I	A	B	C	D	E			
At first 15,000 mi/ 24,000 km or at the first PM	15,000 mi/ 24,000 km/ Monthly	30,000 mi/ 48,000 km	60,000 mi/ 96,000 km/ 6 Months	120,000 mi/ 192,000 km/ Annually	240,000 mi/ 384,000 km			
SYSTEM	COMPONENT	MAINTENANCE TASK	Recommended PM Interval					
			I	A	B	C	D	E
Electrical and lights	Headlamps	Check the aim and adjust as required.				X		
	Warning lights in light bar	Check at the ignition start position to verify bulbs and driver information display function (shown on page 3-30).		X				
	Turn, Stop, Reverse lights and signals	Visual check.		X				
	Alternator		Check operation and output.				X	
			Check tightness of the pulley nut.				X	
			Check the tension of the drive belt (shown on page 5-97).				X	
			Check tightness of the terminal hex nuts.				X	
	Starter	Check torque on hex nuts.				X		
	ECM connector	Check the tightness of the ECM connector.				X		
	Wheel sensors	Check for damaged sensors and connectors, and worn or frayed wires.				X		
Fuel and diesel exhaust fluid tank sending unit	Check the mounting screws and electrical connections for worn or damaged wires and connectors.	X		X				
Power supply harnesses (engine, transmission, etc.)	Check for worn or damaged insulation, corroded terminals, frayed wires, and oil or fluid leaks on the connectors or wiring. Wash to remove excess grease.		X					
Cab structure, doors and hoods	Hood	Lubricate the lower hood pivot (only if lube fittings are present).				X		
	Hinges and latch	Lubricate with silicone spray.				X		
	Body and cab holddown bolts	Check the condition and tightness.					X	

# PREVENTIVE MAINTENANCE SCHEDULE

<b>PREVENTIVE MAINTENANCE (PM) INTERVALS</b>						
	I	A	B	C	D	E
	At first 15,000 mi/ 24,000 km or at the first PM	15,000 mi/ 24,000 km/ Monthly	30,000 mi/ 48,000 km	60,000 mi/ 96,000 km/ 6 Months	120,000 mi/ 192,000 km/ Annually	240,000 mi/ 384,000 km

SYSTEM	COMPONENT	MAINTENANCE TASK	Recommended PM Interval					
			I	A	B	C	D	E
Heating and Air Conditioning	Air conditioner	Operate the system.		X				
	Heater and air conditioner	Perform the checks listed shown on page 5-112.			X			
		Full operational and diagnostic check.					X	
	Cabin fresh air filter (ON HIGHWAY)	Inspect and clean, replace if necessary, as shown on page 5-113.		X				
	Cabin fresh air filter (OFF-HIGHWAY)	Inspect and clean, replace if necessary, as shown on page 5-113.		X				
	Condenser	Clear any debris from the front of the condenser.				X		
	Sleeper air filter	Inspect and clean, replace if necessary, as shown on page 5-114.					X	
	Recirc cab air filter (ON HIGHWAY)	Please contact an authorized dealer when the service interval is required to inspect the cabin recirculation air filter.					X	
Recirc cab air filter (OFF-HIGHWAY)	Please contact an authorized dealer when the service interval is required to inspect the cabin recirculation air filter.					X		
Aftertreatment System	System	Check for leaks and proper support (shown on page 5-117).		X				
	Diesel particulate filter	Clean filter.	Refer to the Engine Maintenance Manual.					
	Diesel exhaust fluid tank	Inspect the tank, straps, brackets, hoses and fittings for abrasion damage, leaks, tightness and fully engaged connectors.				X		
	Diesel exhaust fluid supply module	Replace filter.	Refer to the Engine Maintenance Manual.					

# PREVENTIVE MAINTENANCE SCHEDULE

PREVENTIVE MAINTENANCE (PM) INTERVALS							
	I	A	B	C	D	E	
	At first 15,000 mi/ 24,000 km or at the first PM	15,000 mi/ 24,000 km/ Monthly	30,000 mi/ 48,000 km	60,000 mi/ 96,000 km/ 6 Months	120,000 mi/ 192,000 km/ Annually	240,000 mi/ 384,000 km	
SYSTEM	COMPONENT	MAINTENANCE TASK	Recommended PM Interval				
			I	A	B	C	D
Air	Air compressor governor	Replace air strainer.			X		
	Air lines	Check condition and routing to prevent chafing.			X		
	System	Lubricate (shown on page 5-49).				X	
	Inline filters	Replace elements or clean with solvent.				X	
	Air dryer	Perform the checks listed (shown on page 5-49).			X		
	Air dryer (ON HIGHWAY)	Overhaul.	360,000 miles/576,000 km				
	Air dryer (OFF HIGHWAY)	Overhaul.					X
Engine	Basic Engine	Maintenance and service interval recommendations are detailed in the engine manufacturer's Operations and Maintenance Manual included with the vehicle. The engine manufacturer's recommendations vary depending engine model. Information is also available from authorized dealers, the engine manufacturer's authorized service centers, and the engine manufacturer's web site.					
Safety	Three-point Safety Belt System	Inspect.	20,000 miles/32,000km If the vehicle is exposed to severe environmental or working conditions, more frequent inspections may be necessary.				

# LUBRICANT SPECIFICATIONS

## Introduction

	<b>WARNING!</b>
Handle lubricants carefully. Vehicle lubricants (oil and grease) can be poisonous and cause death, personal injury or sickness. They can also damage the paint on the vehicle.	

In this section you will find the basic information you need to do the routine lubrication your vehicle requires. Of course you will want to schedule service more frequently if you are operating under severe conditions such as extreme heat or cold, with very heavy loads, off-road, etc. For any special service requirements, consult your service manuals and your lubricant supplier. Please remember: one key to keeping your truck running at top economy and in prolonging

its life is proper lubrication servicing. Neglecting this essential aspect of vehicle care can cost time and money in the long run.

	<b>CAUTION</b>
Do not mix different types of lubricants. Mixing lubricants (oil and grease) of different brands or types could damage vehicle components; therefore, drain (or remove) old lubricants from the unit before refilling it.	

## Engine

Proper engine lubrication depends on the outside temperatures where you will be driving. Use the oil recommended for the conditions you are most likely to be operating in. You will find a complete engine lubrication service guide in the Engine Operation Manual that came with your vehicle. The engine operator manual contains specific maintenance tasks that you or a qualified service technician need to perform to maintain the engine.

# LUBRICANT SPECIFICATIONS

5

 <b>WARNING!</b>
Exhaust fumes from the engine contain carbon monoxide, a colorless and odorless gas. A poorly maintained, damaged, or corroded exhaust system can allow carbon monoxide to enter the cab or sleeper. Failure to properly maintain your vehicle could cause carbon monoxide to enter the cab and cause death, personal injury or serious illness.

 <b>WARNING!</b>
Never idle your vehicle for prolonged periods of time if you sense that exhaust fumes are entering the cab. Investigate the cause of the fumes and correct it as soon as possible. If the vehicle must be driven under these conditions, drive only with the windows slightly open. Failure to repair the source of the exhaust fumes may lead to death, personal injury or serious illness.

 <b>NOTE</b>
Keep the engine exhaust system and the vehicle's cab ventilation system properly maintained. It is recommended that the vehicle's exhaust system and cab be inspected:
<ul style="list-style-type: none"><li>• By a competent technician every 15,000 miles/ 24,000 km,</li><li>• Whenever a change is noticed in the sound of the exhaust system,</li><li>• Whenever the exhaust system, underbody, cab or sleeper is damaged.</li></ul>

 <b>NOTE</b>
Use only an exact replacement parts in Aftertreatment exhaust system. Using a noncompliant replacement part could violate emissions requirements and also void the emission system's warranty.

## Pipe and Hose Clamps

Use the following table for torque specifications to check pipe and hose clamps.

### Pipe and Hose Clamp Torque Values

APPLICATION	APPROVED CLAMP	TORQUE	
		Nm	Lb-in
Radiator and Heat Exchanger Hoses	Constant-Torque CT-L	10.2-12.5	90-110
Heater Hoses	Constant Tension	not required	not required
Air Intake Pipes	Hi-Torque HTM-L	11.3-14.2	100-125
Plastic Air Intake Pipes	Constant- Torque CT-L	4.5	40 (maximum)
Charge Air Intake Hoses	Flex Seal 667	7.9-11.3	70-100
	B9296	6-7	50-60
Fuel, Oil and Water Heat Exchangers (for hoses less than 9/16 diameter)	Miniature 3600L	1.1-1.7	10-15

# LUBRICANT SPECIFICATIONS

## Master Lubrication Index

Lubricant Symbol Key	
ATF	MD3 or MERCON®-approved automatic transmission fluid
BB	High temperature ball bearing grease. Chevron SRI Mobile Grease HP, Texaco Multifax 2 or equivalent
CB	Engine oil for mild to moderate requirements
CC/CD	Engine oil for severe requirements (MIL-L-2104B /MIL-L-45199B w/ 1.85% max. sulfated ash content)
CD	Engine oil meeting API "Five engine test sequence"
CD50	SAE50W synthetic transmission fluid
CE	Engine oil meeting severe duty service requirements for direct-injection turbocharged engines
CJ-4	Engine oil for PACCAR MX and Cummins EGR engines
CL	Multipurpose chassis grease
EP	Extreme Pressure Lubricant (Lithium 12-hydroxystearate base NGLI 2)
GL	Straight mineral gear lubricant
HD	Hypoid Gear Oil, A.P.I. - GL-5, SAE 75W-90FE synthetic gear lubricant
HT	High Temperature grease (Timken Spec. 0-616)
MP	Multipurpose gear lubricant (MIL-L-2105B)
DOT3 or DOT4	Brake Fluid

5

i	NOTE
The responsibility for meeting these specifications, the quality of the product, and its performance in service rests with the lubricant supplier.	

For oil reservoir with side filler plugs (transmission, axles, steering gear

boxes, transfer cases, etc.) the oil must be level with the filler opening.

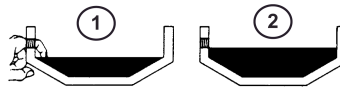

- 1 Improper Oil Level
- 2 Proper Oil Level

Use care when checking the oil level with a finger. Just because you can reach the oil level with a finger, does not mean the oil level is correct.



Component Lubrication Index	
Universal Joints	EP*
Drive Shaft Splines	CL*
Steering Column	CL
Alternator Bearing	BB*
Fan Hub	BB*
Power Steering Reservoir	ATF
Steering Drag Link	CL
Steering Knuckles	CL
Spring Pins	CL
Clutch Release Bearings	BB
Brake Shoe Anchor Pins	HT
Brake Cam Bearings	HT
Slack Adjusters	CL
Starter Bearings	CC
Turbocharger Aneroid	CC
Water Pump	BB*
Suspension Fittings (other than threaded pins and bushings)	EP
Steering Axle: Grease Fittings on Steering Arm; Tie Rod Ends; Drag Link; King Pins	EP
Steering Shaft Grease Fittings	EP
Brake Treadle Hinge and Roller	Engine oil
Lock Cylinders	Lock lubricant
Door Hinges	Not required - Teflon bushings
Door Latches and Striker Plates	Polyethylene grease stick
Door Weatherstrip	Silicone lubricant
Hub-piloted Aluminum Wheels	Coat the wheel pilot or hub pads with Freylube #3 lubricant (light colored) or Chevron Zinc lube. Do not get lubricant on the face of the wheel or the hub.

# LUBRICANT SPECIFICATIONS

---

<b>Component Lubrication Index</b>	
Manual Transmission Hydraulic Clutch	DOT3 or DOT4 (Brake Fluid)
*Consult manufacturer or lubricant supplier for special details.	

## Fuller Transmission Lubrication

Fuller transmissions are designed so that the internal parts operate in a bath of oil circulated by the motion of gears and shafts. Grey iron parts have built-in channels where needed to help lubricate bearings and shafts. All parts will be amply lubricated if these procedures are closely followed:

1. Maintain oil level; check it regularly.
2. Change oil regularly.
3. Use the correct grade and type of oil.
4. Buy oil from a reputable dealer.

## Lubrication Change and Inspection Off-Highway Use

Refer to the Eaton Fuller transmission manual for servicing information.

### Highway Use

- Refer to the Eaton Fuller transmission manual for servicing information.
- Refer to the oil change vs. temperature chart that follows for special oil change information. The “intermittent peak temperature” is the maximum temperature observed for a short time in a fully loaded vehicle performing normally.

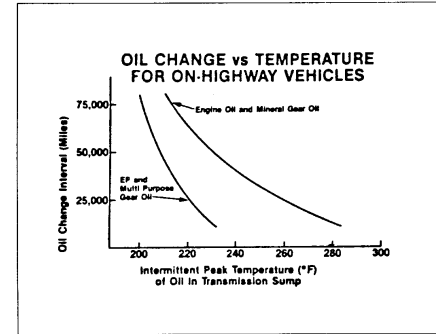

	<b>CAUTION</b>
Exceeding the recommended oil change intervals may be harmful to the life of the transmission and the transmission oil cooler.	

# LUBRICANT SPECIFICATIONS

---

## Recommended Lubricants

Type	Grade (SAE)	Ambient Temperature
Heavy Duty Engine Oil MIL-L-2104B, C, or D; API - SF, or API-CD	50	Above 10° F (-12° C)
	40	Above 10° F (-12° C)
	30	Below 10° F (-12° C)
Mineral gear oil with rust and oxidation inhibitor API-GL-1	90	Above 10° F (-12° C)
	80W	Below 10° F (-12° C)
Synthetic Lubricant*	50	All
*See your dealer for approved brands.		

## Allison Transmission Lubrication

### Lubrication Change and Inspection

- Refer to your transmission manual (furnished separately) for lubrication information.
- Refer to the Allison Transmission manual for servicing information.

## Spicer Transmission Lubrication

It is extremely important to use the proper lubricants and maintain the correct oil levels in Spicer units. This will ensure proper lubrication and operating temperatures in these units.

## Recommended Lubricants

The lubricants listed below are recommended, in order of preference, for use in all Spicer mechanical transmissions, auxiliaries, and transfer cases. Do not use extreme pressure additives such as those found in multipurpose or rear axle-type lubricants. These additives are not required in Spicer transmissions, and may in some cases create transmission problems. Multipurpose oils, as a group, have relatively poor oxidation stability, a high rate of sludge formation, and a greater tendency to react with or corrode the steel and bronze parts.

Type	Grade (SAE)	Ambient Temperature
Heavy Duty Engine Oil MIL-L-2104D or MIL-L-46152B, API-SF or API-CD (MIL-L-2104B or C or MIL-L-46152 designations are acceptable)	30, 40, or 50	Above 0° F (-18° C)
	30	Below 0° F (-18° C)
Mineral gear oil (R and O type) API-GL-1	90	Above 0° F (-18° C)
	80	Below 0° F (-18° C)
Synthetic Engine Oil meeting MIL-L-2104D or MIL-L-46152B, API-SF or API-CD	CD50	All
	CD30	

# LUBRICANT SPECIFICATIONS

Type	Grade (SAE)	Ambient Temperature
*Synthetic Gear Oil Meeting MIL-2105C or API-GL5	EP75W90 EP75W140	All
*EP Gear Oils are not recommended when lubricant operating temperatures are above 230° F (110° C).		

## Oil Changes

 CAUTION
When adding oil, types and brands of oil should not be intermixed because of possible incompatibility, which could decrease the effectiveness of the lubrication or cause component failure.

An initial oil change and flush should be performed after the transmission has been placed in actual service. This change should be made any time after 3000 miles (4800 km) but never longer than 5000 miles (8000 km) of over-the-road service. In off-highway use, the change should be made after 24 hours but before 100 hours of service have elapsed.

## Refilling

Remove all dirt around filler plug. Refill with new oil of the grade recommended for the existing season and prevailing service. Fill to the bottom of the level testing plug positioned on the side of the transmission. **Do not** overfill the transmission. Overfilling usually results in oil breakdown due to excessive heat and aeration from the churning action of the gears. Early breakdown of the oil will result in heavy varnish and sludge deposits that plug up oil ports and build up on the splines and bearings. Overflow of oil can also escape onto clutch or parking brakes. When adding oil, **do not** mix different types of oil.

## Meritor Axle Lubrication

<b>i</b>	<b>NOTE</b>
Axles utilized in 100% off-highway use are not eligible for Meritor's Advanced Lube Rear Drive Axle program.	

Under Meritor's Advanced Lube Rear Drive Axle program, the axles listed below are exempt from an initial lubricant change:

AVAILABLE ADVANCED LUBE AXLES			
RS-17-145	RS-23-180	RT-40-145	RT-44-145P
RS-19-145	RS-26-180	RT-40-145P	RT-46-160
RS-21-145	RS-30-180	SQ-100A	RT-46-160P
RS-23-160	RT-34-145	SQ-100AP	RT-52-160
RS-23-161	RT-34-145P	RT-44-145	RT-52-160P

Meritor rear axles that do not appear on the list above will continue to require an initial drain at 3000-5000 miles (4800-8000 km).

- Refer to the Meritor Field Maintenance Manual for a

particular axle for lubricant specifications.

- See your dealer for Meritor-approved lubricant brands.

- Refer to the following chart for lubricant change intervals:

Application	Type Of Lubricant	Mileage Interval
On Highway	Synthetic	240,000 mi. (384,000 km)
	Synthetic with Pump and Filter	500,000 mi. (800,000 km)
	Mineral Base	120,000 mi. (192,000 km)

# LUBRICANT SPECIFICATIONS

Application	Type Of Lubricant	Mileage Interval
City Delivery	Synthetic	120,000 mi. (192,000 km)
	Synthetic with Pump and Filter	240,000 mi. (384,000 km)
	Mineral Base	120,000 mi. (192,000 km)
Off Highway	Synthetic	120,000 mi. (192,000 km)
	Synthetic with Pump and Filter	120,000 mi. (192,000 km)
	Mineral Base	120,000 mi. (192,000 km)

- Change the lubricant filter every 120,000 miles (192,000 km). Top off the lubricant level with a similar lubricant.

## Eaton/Dana Axle Lubrication

- The original mineral-based lubricant must be drained within 3000-5000 miles (4800-8000 km) on all Eaton axles. This initial change is very important because it flushes out break-in contaminants that might otherwise cause premature wear.
- No initial drain is required on Eaton axles that are factory filled with an Eaton-approved synthetic lubricant.
- Mineral-based lubes must be drained within the first 5000 miles (8000 km) if converting to an Eaton-approved synthetic lube.

- Change the lubricant within the first 5000 miles (8000 km) of operation after a carrier head replacement, regardless of the lubricant type.
- Refer to the Eaton Field Maintenance Manual for a particular axle for lubricant specifications.
- See your dealer for Eaton-approved lubricant brands.
- Refer to the chart below for lubricant change interval.



Type of Lubricant	On-Highway Mi. (km)	Maximum Change Interval	On/Off Highway Severe Service Mi. (km)	Maximum Change Interval
Mineral-Based	120,000 (192,000)	Yearly	60,000 (96,000)	Yearly
Eaton-Approved Synthetic	240,000 (384,000)	2 Years	120,000 (192,000)	Yearly
Eaton-Approved Synthetic in axle with extended drain interval option	350,000 (560,000)			

## Wheel Bearing Lubrication Oil-lubricated Driven Hubs

Use hypoid oil, A.P.I.-GL-5 SAE 75W-90FE synthetic gear lubricant or equivalent. A minimum of 1 quart (921 ml) of oil is required for proper lubrication of each drive hub. Add oil through the filler hole in the hub; if none, add oil through the differential filler hole. (Note: Remember to replace vent plug or threaded filler plug when done.) Allow time for the oil to seep through the bearings when initially filling a hub. Maintain the differential oil level by adding oil until its surface is even with the bottom of the filler hole (see illustration on page 5-38).

## Oil-lubricated Nondriven Hubs

Use CD50 synthetic transmission fluid SAE 50W or equivalent. A minimum of 9 oz. (270 ml) of lubricant is required for proper lubrication of an LMS™ hub; 10-13 oz. (295-400 ml) is required for a non-LMS hub, depending on wheel design. Allow time for the fluid to seep through the bearings when initially filling a hub. When properly filled, the fluid level will lie between the fluid level line and 1/4" above the line.

	NOTE
Remember to replace vent plug when done.	

## Universal Joint Lubrication

Refer to the Spicer Universal Joints and Driveshafts service manual and lubrication specifications.

# LUBRICANT SPECIFICATIONS

## Steering Gear Lubrication

### Fluid Refill

The following recommendations are for general purpose steering systems (both TRW and Sheppard).

- For normal temperatures, use Automatic Transmission Fluid (ATF) Type E or F or Dexron® III.
- For cold temperatures of -22° F (-30° C) and above use ATF Type A.
- For extremely cold temperatures between -22° F (-30° C) and -40° F (-40° C) use ATF Type B.

### Inspection

	<b>NOTE</b>
Before removing reservoir cover, wipe outside of cover so that no dirt can fall into the reservoir.	

1. Check the fluid level; add fluid if required.
2. Check fluid for contamination, discoloration, or burnt smell; correct source of such problems before replacing fluid and filter.

	<b>CAUTION</b>
When adding fluid, be sure to use fluid of the same type. While many fluids have the same description and intended purpose, they should not be mixed due to incompatible additives. Mixing incompatible fluids may lead to equipment damage.	

If incompatible (insoluble) fluids are mixed in a power steering system, air bubbles can be produced at the interface of the two fluids. This can cause cavitation, which reduces the lubrication between moving parts in the gear. This could result in worn components.

The mixture of two different fluids, although harmless to individual internal components, may initiate a chemical reaction that produces a new compound that will attack seals and other internal components.

Do not mix different fluids.

# AIR SYSTEM

## Introduction

**WARNING!**

Do not attempt to modify, alter, repair or disconnect any component of the air system. Repairs or modifications to the air system, other than what is described in this section, should only be performed by an authorized dealer. Failure to comply may result in death or personal injury.

**WARNING!**

Prior to the removal of any air system component, always block and hold the vehicle by a secure means other than the vehicle's own brakes. Depleting air system pressure may cause the vehicle to roll unexpectedly resulting in an accident causing death or personal injuries. Keep hands away from chamber push rods and slack adjusters, they may apply as system pressure drops.

**WARNING!**

After completing any repairs to the air system, always test for air leaks, and check the brakes for safe operation before putting the vehicle in service. Failure to comply may result in death, personal injury, equipment or property damage.

**WARNING!**

Never connect or disconnect a hose or line containing air pressure. It may whip as air escapes. Never remove a component or pipe plug unless you are certain all system pressure has been depleted. Failure to comply may result in death, personal injury, equipment or property damage.

**WARNING!**

Never exceed recommended air pressure and always wear safety glasses when working with air pressure. Never look into air jets or direct them at anyone. Failure to comply may result in death, personal injury, equipment or property damage.



### WARNING!

Never attempt to disassemble a component until you have read and understood recommended procedures. Some components contain powerful springs and injury can result if not properly disassembled. Use only proper tools and observe all precautions pertaining to use of those tools. Failure to comply may result in death, personal injury, equipment or property damage.



### WARNING!

Completely bypassing a Bendix® AD-IS air dryer will bypass the system's pressure protection valves. This could lead to loss of air pressure or damage to the vehicle's air system, which could cause an accident involving death or personal injury. Always adhere to the manufacturer's procedure if it is necessary in an emergency to temporarily bypass an AD-IS-series air dryer. Failure to comply may result in death, personal injury, equipment or property damage.

The operation of the vehicle's braking system and many vehicle accessories depends upon the storage and application of a high-pressure air supply.

Your vehicle's compressor takes outside air and compresses it, usually to 100-120 psi (689-827 kPa). The compressed air then goes to the

reservoirs to be stored until needed. When you operate your air brakes, the stored compressed air flows into the chambers where it is used to apply your truck and trailer brakes. That is why, when you push down on your brake pedal, you don't feel the same amount of pressure on the pedal that you do when you apply the brakes on your car. All you are doing on your truck is opening an air valve to allow air to flow into the brake chambers.

Contamination of the air supply system is the major cause of problems in air-operated components such as brake valves, and suspension height control valves. To keep contaminants to the lowest possible level, follow these maintenance procedures.



### WARNING!

If the supply and service tanks are not drained at the recommended frequency, water could enter the air lines and valves. This could cause corrosion or blockage, which could compromise the brake system safety and potentially cause an accident involving death or personal injury.

### Daily

- Drain moisture from the supply and service air tanks.
- Operate air devices to circulate lubricants within the unit.

### Periodically

- Clean filter screens ahead of the valves by removing the screens and soaking them in solvent. Blow them dry with pressurized air before reinstalling them.

# AIR SYSTEM

## Twice a Year

- Maintain the air compressor to prevent excessive oil by-pass. See your maintenance manual for details.
- Replace worn seals in valves and air motors as they are needed.

## Air Dryer

The function of the air dryer is to collect and remove air system contaminants in solid, liquid and vapor form before they enter the brake system. It provides clean, dry air to the components of the brake system, which increases the life of the system and reduces maintenance costs.

i	NOTE
Because no two vehicles operate under identical conditions, maintenance and maintenance intervals will vary. Experience is a valuable guide in determining the best maintenance interval for any one particular operation.	

Every 900 operating hours or 25,000 miles (40,200 km) or every three (3) months check for moisture in the air brake system by opening air tanks, drain cocks, or valves and checking for presence of water.

i	NOTE
A small amount of oil in the system may be normal and should not, in itself, be considered a reason to replace the desiccant cartridge. Oil stained desiccant can function adequately.	

A tablespoon of water found in the air tank would point to the need for a desiccant cartridge change. However, the following conditions can also cause water accumulation and should be considered before replacing the desiccant cartridge.

- Air usage is exceptionally high and not normal for a highway vehicle. This may be due to accessory air demands or some unusual air requirement that does not allow the compressor to load and unload (compressing and non-compressing cycle) in a normal fashion or it may be due to excessive leaks in the air system.

- In areas where more than a 30° F (17° C) range of temperature occurs in one day, small amounts of water can accumulate in the air brake system due to condensation. Under these conditions, the presence of small amounts of moisture is normal and should not be considered as an indication that the dryer is not performing properly.
- An outside air source has been used to charge the air system. This air did not pass through the drying bed.

**Overhaul**

Maintenance intervals typical for on-highway operation would be 2 - 3 years, 350,000 miles or 10,800 hours.

Maintenance intervals typical for high duty cycle usage such as transit bus, refuse hauler, dump truck, cement mixers and off-highway operation would be 1 year, 100,000 miles or 3,600 hours.

	<b>NOTE</b>
Review the warranty policy before performing any maintenance procedures. An extended warranty may be voided if unauthorized maintenance is performed during this period.	

**Bendix® AD-IS Series Air Dryer**

Your vehicle may be equipped with a Bendix® AD-IS series air dryer. Any air dryer replacement should be made with an identical component.

	<b>WARNING!</b>
If a different air dryer brand or model is installed on the vehicle other than what was originally installed, it could cause the air system to not perform correctly unless the full air system design is reviewed and modifications made to comply with Federal Motor Vehicle Safety Standards (FMVSS) 121 - Air Brake Systems. Failure to abide by this warning and maintain compliance to FMVSS 121 could cause loss of vehicle control and may lead to death or serious personal injury.	

The AD-IS Series air dryer has incorporated into its design various components that have typically been

## AIR SYSTEM

installed separately on the vehicle (see below for components/areas affected):

- Pressure protection valves
- Safety valve
- Governor and plumbing
- Plumbing of the front and rear service air tanks
- Plumbing to accessory systems

These components are required to meet the Federal Motor Vehicle Safety Standards (FMVSS 121 - Air Brake Systems). As the Warning above states, any other type of air dryer installed in the place of an AD-IS Series will require changes, modifications and/or additions to your vehicle's air system to maintain compliance with FMVSS 121.

### Air Tanks

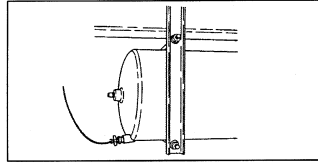

To eject moisture from the air system tanks, pull the line that is connected to the moisture ejection valve. Continue pulling until the air comes out free of water.

**Daily:** The supply and service air tanks, must be drained on a daily basis. Operate air devices daily to circulate lubricants within the unit.

**Periodically:** Clean filter screens ahead of the valves by removing the screens and soaking them in solvent. Blow them dry with pressurized air before reinstalling them.



#### WARNING!

If the supply and service air tanks are not drained at the recommended frequency, water could enter the air lines and valves. This could cause corrosion or blockage, which could compromise the brake system safety and potentially cause an accident. Failure to comply may result in death, personal injury, equipment or property damage.



#### CAUTION

Do not use penetrating oil, brake fluid, or wax-based oils in the air system. These fluids may cause severe damage to air system components.

- Maintain the air compressor to prevent excessive oil bypass.
- Replace worn seals in valves and air motors as they are needed. Your authorized dealer carries rebuild kits for most units.



### Air Gauges and Air Leaks

Your vehicle comes with air pressure gauges for two separate systems, Primary and Secondary: the Primary gauge indicates pressure in the rear braking system; the Secondary gauge indicates pressure in the front braking system. Each gauge indicates the amount of air pressure in pounds per square inch (psi).

	<b>WARNING!</b>
Do not operate the vehicle if leakage in the air system is detected. Conduct the following procedure and contact an authorized dealer (or any other properly equipped service center) if a leak is detected. Failure to check the brakes or follow these procedures could cause a system failure, increasing the risk of an accident and may result in death, personal injury, equipment or property damage.	

If the light and alarm do not turn off at start-up, do not try to drive the vehicle until the problem is found and fixed. If the pressure in either or both systems is too low for normal brake operation, i.e., the pointer of one gauge falls below 65 psi (448 kPa), a warning light on the gauge will glow and the audible alarm will sound.

	NOTE
Park brakes lock up at 60 psi (414 kPa), the audible alarm will sound at 65 psi (448 kPa).	



Primary Air Pressure Gauge



Secondary Air Pressure Gauge

**Follow the procedure below to check the compressed air system for leaks:**

1. Periodically, or after maintenance or replacement of air system components:
2. Build up air pressure in the system to the governor cutout point or until 120 psi (827 kPa) is reached.
3. Stop the engine and release the service brakes.
4. Without applying the brake pedal, observe the rate of air pressure drop. This rate should not exceed 2.0 psi (14 kPa) per minute.

5. Start the engine and build up the air pressure again.
6. Stop the engine, and apply the brakes fully. Apply the brake pedal and hold it down for five minutes. The pressure drop should not exceed 3.0 psi (21 kPa) per minute.
7. If you detect excessive leakage (air pressure loss greater than 3.0 psi (21 kPa) after five minutes of brake application), a leakage test should be made at the air line connections and at all air brake control units. These tests should determine where air is escaping.

### Air Compressor Operation

All compressors, regardless of make or model, run continuously while the engine is running. System pressure is controlled by the governor. The governor acts in conjunction with the unloading mechanism in the compressor cylinder block to start and stop compression of air. The compressor is unloaded when the system pressure reaches 120 psi (827 kPa) and compression is reestablished when system pressure falls to 100 psi (690 kPa).

### Preventive Maintenance

The following service checks are provided for your information only and should be performed by a certified mechanic. Contact your dealer or the engine manufacturer's Maintenance Manual for further information on servicing air compressors.

After completing any repairs to the air system, always test for air leaks, and check the brakes for safe operation before putting the vehicle in service.

Below is a list of areas to maintain for the air compressor:

- Inspect compressor air filter element, if so equipped, and replace element if clogged. Check compressor mounting and drive for alignment and belt tension. Adjust if necessary.
- Remove compressor discharge valve cap nuts and check for

presence of excessive carbon. If excessive carbon is found, clean or replace the compressor cylinder head. Also, check compressor discharge line for carbon, and clean or replace the discharge line if necessary.

- Disassemble compressor and thoroughly clean and inspect all parts. Repair or replace all worn or damaged parts, or replace compressor with a factory exchange unit.

	CAUTION
<p>When draining the engine cooling system is required, to prevent damage from freezing, the compressor must also be drained at the cylinder head and block. Engine damage could occur if the cooling system is not periodically drained and maintained. See Cooling System on page 5-72 for further information.</p>	

# BRAKE SYSTEM

## Brake Adjustment



### WARNING!

Do not work on the brake system without the parking brake set and wheels chocked securely. If the vehicle is not secured to prevent uncontrolled vehicle movement, it could roll and cause death, serious personal injury or damage to the vehicle.



### CAUTION

The air brake system of this vehicle was configured for ONE of the following operations: tractor or truck, and complies with the respective portions of FMVSS 121. A tractor shall not be operated or configured as a truck, nor shall a truck be operated or configured as a tractor, without significant modifications to the air brake system in order to retain compliance with FMVSS 121. Contact your dealer for instructions.

system. All of the following areas are interrelated and must conform to original specifications:

- Tire Size
- Drum brakes
  - a. Cam Radius
  - b. Wedge Angle
  - c. Drum Radius
  - d. Brake Linings
  - e. Brake Chambers
  - f. Slack Adjusters
- Disc Brakes
  - a. Disc Rotors

Once a brake system is set to specifications, changing any one of its components or any combination of components may cause the system to not work as well. All parts have to work together to perform as they should. Any replacement components in your brake system should be exactly equal to the original components. Any changes from the original specifications can affect the whole

To operate your vehicle safely and profitably, you need some understanding of its brake systems. For more on brakes, see the Index, under Brakes.

Brake adjustment and brake balance must be set carefully to (1) make the most efficient use of the forces available for braking and (2) allow equal stopping forces at all wheels.

 <b>WARNING!</b>
Do not use any replacement part in the brake system unless it conforms exactly to original specifications. A non-conforming part in your vehicle's brake system could cause a malfunction resulting in an accident causing death or personal injury. Sizes and types are so related to one another that a seemingly unimportant change in one may result in a change in how well the brakes work for you on the road. If parts do not work together properly, you could lose control of your vehicle, which could cause a serious accident.

All vehicle operators should check their brakes regularly.

 <b>WARNING!</b>
Do not use brake linings with a thickness below the specified minimum. Such linings will have lining rivets exposed that can damage the brake drum and reduce brake efficiency, which could cause death, personal injury or system failure.

## Air Disc Brakes

Have brake pads inspected by a qualified mechanic for wear at regular intervals according to the Preventive Maintenance Schedule on page 5-12. In severe service or off-highway applications inspect the linings more frequently.

Regularly inspect for pad/rotor wear:

- Park on level ground and chock the wheels.
- Temporarily release the parking brakes.
- Compare the relative position of two notches; one located on the caliper and the other on the carrier. See the illustration below to determine if the brakes require a detailed inspection by a qualified mechanic.

## BRAKE SYSTEM

- Have a qualified mechanic perform a detailed inspection if the notches are not found. The pads and rotors should be measured and compared against the manufacturers specifications located in the brake manufacturer's service manual.

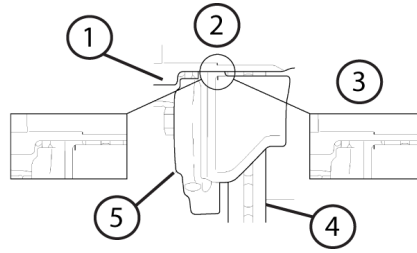

### Caliper Detail

1. Brake Caliper Assembly
2. Location of Inspection Grooves
3. Notches Line-Up (Time to schedule inspection of Pads and Rotors)
4. Brake Rotor
5. Brake Carrier Assembly

Regularly inspect caliper for Running Clearance:

- Stop the vehicle on level ground and let the brakes cool down. Hot brake calipers can burn skin on contact.

- Chock the wheels.
- Temporarily release the parking brakes.
- Grab the caliper and move it. This movement is Running Clearance.
- Proper Running Clearance is 0.08 inch (2 mm) of movement of the brake caliper (approximately the thickness of a nickel) in the inboard/outboard direction.
- Have a qualified mechanic provide further inspection if the caliper does not move or appears to move more than the specified clearance.

## Drum Brakes

Have brake drum linings and disc brake pads inspected by a qualified mechanic for wear at regular intervals according to the maintenance schedule. In severe service or off-highway applications inspect the linings more frequently.

## Automatic Slack Adjusters

Periodically check the Brake Chamber Stroke. Replace the slack adjuster if proper stroke cannot be maintained.

### Operational checks of automatic slack adjusters

- Measure brake chamber stroke with the spring brake released and the air pressure no less than 100 psi (690 kPa).
- Brake Chamber Stroke is the difference between the applied and the retracted position of the air chamber pushrod.
- A correctly installed and functioning auto slack adjuster will produce the following strokes:

Chamber Type	Stroke
36 (rear brakes)	1-1/2" - 2-1/4" (38 - 57 mm)
30 (rear brakes)	1-1/2" - 2" (38 - 51 mm)
16, 20 and 24 (front brakes)	1" - 1-3/4" (25.4 - 44.4 mm)

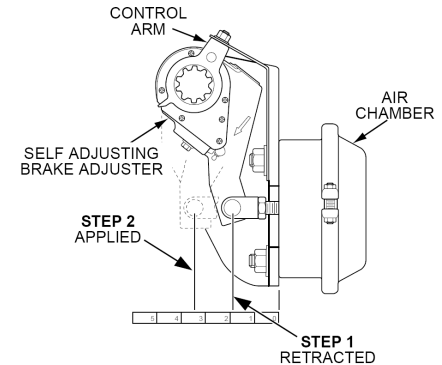

Brake Chamber Stroke

## BRAKE SYSTEM

---



### **WARNING!**

Manual adjustment of automatic slack adjusters is a dangerous practice that could have serious consequences. It gives the operator a false sense of security about the effectiveness of the brakes. Contact the Service Department at your dealership if the stroke exceeds the above specifications. A stroke exceeding these values may indicate a problem with the slack adjuster or the brake foundation.



## CAB

### Exterior Maintenance Painted Surfaces

Wash painted surfaces frequently to remove grime and caustic deposits which may stain the finish. See Cleaning, Protecting, and Weather Stripping on page 5-64.

### Chrome and Aluminum Surfaces

To prevent rust, keep chromed parts clean and protected with wax at all times, especially in winter conditions where the roads are salted.

- If necessary, use a commercial chrome cleaner to remove light rust.
- Chrome surfaces are best cleaned with fresh water. Wipe dry to preserve their luster. A commercial chrome cleaner will remove light rust. After cleaning, wax flat surfaces and apply a thin coat of rust preventive lubricant around bolts or other fasteners.
- Clean aluminum wheels and bumpers with warm water. Tar remover will get rid of heavy deposits of road grime. To prevent spotting, wipe aluminum surfaces dry after washing.

- Under corrosive conditions, such as driving on salted roads, clean aluminum parts with steam or high pressure water from a hose. A mild soap solution will help. Rinse thoroughly.

## Tail Pipe Surface Cleaning

	<b>WARNING!</b>
Always allow hot surfaces to cool down before attempting to work near them. Failure to comply may result in death or personal injury.	

To maintain your quality finish, wash with a soft cloth, mild soap and water or glass cleaner. A non-abrasive chrome polish can be used sparingly on hard to clean areas. Do Not clean your high heat chrome using scouring pads, abrasive chrome polish, highly acidic chemical cleaners or any other abrasive cleaners.

## Stainless Steel

Even high quality stainless steel parts can rust under prolonged exposure to salt water, especially when the salt-laden moisture is held against the metal surface by road grime. It is, therefore, important to frequently clean salty moisture and grime from stainless steel surfaces.

- If surface rust is encountered, wash the surface and use a commercial polishing compound to clean off the rust, followed by a coating of wax.
- Never use steel wool when cleaning stainless steel because minute particles of the steel wool can embed in the surface of the stainless steel and cause rust staining.

## Cleaning, Protecting and Weather Stripping

Frequent washings of the vehicle are required to remove grime and contaminants that can stain and oxidize paint and accelerate corrosion of plated and polished metal surfaces.

Waxing offers added protection against staining and oxidation. But to allow enough time for your truck's finish to cure, wait about 30 days after the date of manufacture before waxing. Do not apply wax in the hot sun and do not friction burn the paint with a buffing machine.

Occasionally spray weather-stripping on doors and windows with silicone compound to help preserve resiliency. This is especially useful in freezing weather to prevent doors and windows from sticking shut with ice.

**Vehicle Cleaning**

**Precautions**

 **WARNING!**  
 Handle cleaning agents carefully. Cleaning agents may be poisonous. Keep them out of the reach of children. Failure to comply may result in death, personal injury, equipment or property damage.

 **WARNING!**  
 Do not use gasoline, kerosene, naphtha, nail polish remover or other volatile cleaning fluids. They may be toxic, flammable or hazardous in other ways. Failure to comply may result in death, personal injury, equipment or property damage.

 **WARNING!**  
 Do not clean the underside of chassis, fenders wheel covers, etc. without protecting your hands and arms. You may cut yourself on sharp-edged metal parts. Failure to comply may result in death, personal injury, equipment or property damage.

 **WARNING!**  
 Moisture, ice, and road salt on brakes may affect braking efficiency. Test the brakes carefully after each vehicle wash. Failure to comply may result in death, personal injury, equipment or property damage.

- Observe all caution labels.
- Always read directions on the container before using any product.

- Do not use any solution that can damage the body paint.
- Most chemical cleaners are concentrates that require dilution.
- Only use spot removing fluids in well ventilated areas.
- Any vehicle is subjected to deterioration from industrial fumes, ice, snow, corrosive road salt, etc., to name just a few causes. A well-cared-for vehicle can look like new many years later. Regular and correct care will contribute to maintaining the beauty and the value of your vehicle.

Your dealer has a number of vehicle-care products and can advise you on which ones to use for cleaning the exterior and interior of your vehicle.



## CAUTION

Do not aim the water jet directly at door locks or latch. Tape the key holes to prevent water from seeping into the lock cylinders. Water in lock cylinders should be removed with compressed air. To prevent locks from freezing in the winter, squirt glycerin or lock deicer into the lock cylinders.

## Washing the Exterior

1. Begin by spraying water over the dry surface to remove all loose dirt before applying the car wash and wax solution.
  - Do not wash the vehicle in direct sunshine.
  - Do not spray water directly into the cab vents.
2. Using soapy water, wash the vehicle with a clean soft cloth or a soft brush made for automotive cleaning.
  - Use cool or warm water and a mild, household type soap. Strong industrial detergents and cleaning agents are not recommended.
  - Do not use stiff brushes, paper towels, steel wool, or abrasive cleaning compounds because they will scratch painted,
3. Rinse surfaces frequently while washing to flush away dirt that might scratch the finishes during the washing operation.
4. Wipe everything dry with a chamois to avoid water spots.
  - To prevent water spotting, dry off the cosmetic surfaces with a clean cloth or chamois.
5. Remove road tar with an automotive type tar remover or mineral spirits.
6. After cleaning and drying, apply a quality automotive wax.

plated, and polished metal surfaces.

i	NOTE
	<p>To allow enough time for your truck's finish to cure, wait at least thirty days after the date of manufacture before waxing.</p> <ul style="list-style-type: none"><li>• Do not apply wax in the hot sun.</li><li>• Never dust off dry surfaces with a cloth because it will scratch the finishes.</li></ul>

### Cleaning the Chassis

- Hose dirt and grime from the entire chassis. Then, if an oil leak develops, you will be able to detect it easier.
- Corrosive materials used for ice and snow removal and dust control can collect on the underbody. If these materials are not removed, accelerated corrosion (rust) can occur on underbody parts such as fuel lines, frames, floor pan, and exhaust system, even though they have been provided with corrosion protection.

At least every spring, flush these materials from the under body with plain water. Be sure to clean any area where mud and other debris can collect. Sediment packed in closed areas of the frame should be loosened before being flushed. If desired, your dealer can do this service for you.

### Cleaning Interior Vinyl and Upholstery

- Wipe vinyl upholstery and lining with a good commercial upholstery cleaner. Do not use acetone or lacquer thinner.
- Clean fabric upholstery with upholstery shampoo specially formulated for this purpose. Follow instructions on the container.

## Safety Restraint System - Inspection

The seat belt system, including webbing, buckles, latches, and mounting hardware, endures heavy use in heavy-duty vehicles, much more than seat belt systems in passenger cars. All users should be aware of the factors contributing to this heavy use and reduced belt life.



### WARNING!

Failure to properly inspect and maintain restraint systems can lead to injury or loss of life. Without periodic inspection and maintenance to detect unsafe conditions, seat restraint components can wear out or not protect you in an accident.

Factors contributing to reduced seat belt life:

Factors contributing to reduced seat belt life:

- Heavy trucks typically accumulate twice as many miles as the average passenger car in a given time period.
- Seat and cab movement in trucks causes constant movement of the belt due to ride characteristics and seat design. The constant movement of the belt inside the restraint hardware and the potential for the belt to come in contact with the cab and other vehicle parts, contributes to the wear of the entire system.
- Environmental conditions, such as dirt and ultraviolet rays from the sun, will reduce the life of the seat belt system.

Due to these factors, the three-point safety belt system installed in your vehicle requires thorough inspection every 20,000 miles (32,000 km). If the vehicle is exposed to severe environmental or working conditions, more frequent inspections may be necessary.

Any seat belt system that shows cuts, fraying, extreme or unusual wear, significant discoloration due to UV (ultraviolet) exposure, abrasion to the seat belt webbing, or damage to the buckle, latch plate, retractor hardware or any other obvious problem should be replaced immediately, regardless of mileage.

**⚠ WARNING!**

It is important to remember that any time a vehicle is involved in an accident, the entire seat belt system must be replaced. Unexposed damage caused by the stress of an accident could prevent the system from functioning properly the next time it is needed. Failure to comply may result in death or personal injury.

**Inspection Guidelines**

Follow these guidelines when inspecting for cuts, fraying, extreme or unusual wear of the webbing, and damage to the buckle, retractor, hardware, or other factors. Damage to these areas indicates that belt system replacement is necessary.

**⚠ WARNING!**

Replace the entire belt system (retractor and buckle side) if replacement of any one part is necessary. Unexposed damage to one or more components could prevent the system from functioning properly the next time it is needed. Failure to comply may result in death or personal injury.

1. Check the web wear in the system. The webbing must be closely examined to determine if it is coming into contact with any sharp or rough surfaces on the seat or other parts of the cab interior.

These areas are typical places where the web will experience cutting or abrasion. Cuts, fraying, or excessive wear would indicate the need for replacement of the seat belt system.

2. The pillar web guide (D-loop) is the area where almost constant movement of the seat belt webbing occurs because of relative movement between the seat and cab.
3. Check the Komfort-Latch for cracks or possible damage and check for proper operation.
4. Check buckle and latch for proper operation and to determine if latch plate is worn, deformed, or damaged.
5. Inspect the retractor web storage device, which is mounted on the floor of the vehicle, for damage. The retractor is the heart of the occupant restraint system and can

often be damaged if abused, even unintentionally. Check operation to ensure that it is not locked up and that it spools out and retracts properly.

6. If tethers are used, be sure they are properly attached to the seat and, if adjustable, that they are adjusted in accordance with installation instructions. Tethers must also be inspected for web wear and proper tightness of mounting hardware.
7. Mounting hardware should be evaluated for corrosion, and for tightness of bolts and nuts.
8. Check web in areas exposed to ultraviolet rays from the sun. If the color of the web in these areas is gray to light brown, the physical strength of the web may have deteriorated due to exposure to the sun's ultraviolet rays. Replace the system.



Seat Belt Inspection Points

- 1 Web cut or frayed or extremely worn at latch area.
- 2 Web cut or frayed at D-loop web guide.
- 3 Comfort Clip cracked or damaged.
- 4 Buckle casting broken.

- 5 Retractor Web Storage for damage. (located behind trim panel)
- 6 Tethers for web wear and proper tightness of mounting hardware.
- 7 Mounting hardware for corrosion, proper tightness of bolts and nuts.
- 8 Web for deterioration, due to exposure to the sun

	<p><b>WARNING!</b></p>
<p>Failure to adjust tether belts properly can cause excessive movement of the seat in an accident. Tether belts should be adjusted so that they are taut when the seat is in its most upward and forward position. Failure to comply may result in death or personal injury.</p>	

Once the need for replacement of the seat belt has been determined, be certain it is only replaced with



an authorized PACCAR Parts replacement seat belt.

If the inspection indicates that any part of the seat belt system requires replacement, the entire system must be replaced. An installation guide is attached to every replacement belt. Utilize the proper guide for your type of seat, and follow the instructions very closely. It is vitally important that all components be reinstalled in the same position as the original components that were removed and that the fasteners be torqued to specification. This will maintain the design integrity of the mounting points for the seat belt assembly. Contact your dealer if you have any questions concerning seat belt replacement.

### Windshield Wiper/Washer

The windshield wiper system is maintenance free. Check wiper blades annually or every 60,000 miles (96,000 km).

### Washer Reservoir

	CAUTION
Do not use antifreeze or engine coolant in the windshield washer reservoir, damage to seals and other components will result.	

**Daily:** Check reservoir water level, located in the engine compartment. If necessary, refill to the proper level.

## COOLING SYSTEM

### Cooling system maintenance

Your engine's cooling system is standard with Extended Life Coolant (ELC). ELC consists of a mixture of ethylene glycol, water, and organic acid technology chemical inhibitors. ELC prevents corrosion and scale formation as well as provides freezing and boiling point protection.

	CAUTION
<p>The engine cooling system has very specific maintenance and inspection requirements. Failure to follow requirements can damage the engine. Engine damage can include but is not limited to:</p> <ul style="list-style-type: none"><li>• Freezing</li><li>• Boiling</li><li>• Corrosion</li><li>• Pitted cylinder liners</li></ul>	
<p>This information is found in the engine manufacturers owner's manual. It is the owner's responsibility to follow all requirements listed in the engine manufacturers owner's manual.</p>	

### What to Check in an ELC-filled Cooling System ELC Concentration

Check the level of freeze/boilover protection, which is determined by the ELC concentration. Use a glycol refractometer to determine glycol level. Add ELC to obtain the ELC to water ratio required to provide the protection you need. Use the chart below to help determine how much ELC you need to add.

	NOTE
<p>Maximum recommended ELC concentration is 60% ELC and 40% water by volume (a 60/40 coolant mixture). The minimum recommended concentration is 40%.</p>	

In an ELC-filled cooling system, the freeze point should be maintained between -30° F and -45° F (-34° C and -43° C).

Desired ELC/ Water ratio:	0%	10%	15%	20%	25%	30%	35%	<b>40%</b>	<b>45%</b>	<b>50%</b>	<b>55%</b>	<b>60%</b>	65%	70%	75%	80%	85%	90%	100%
Freeze point °F (°C)	+32 (0)	+25 (-4)	+20 (-7)	+15 (-9)	+10 (-12)	+5 (-15)	-5 (-21)	-12 (-24)	-23 (-31)	-34 (-37)	-50 (-46)	-65 (-54)	-75 (-59)	-84 (-64)	-70 (-57)	-55 (-48)	-43 (-42)	-30 (-34)	-5 (-21)

Items in bold are the recommended levels of concentration.

## ELC Condition (Contamination and Inhibitor Concentration)

Perform a visual inspection of the ELC. It should have no cloudiness or floating debris. Determine the chemical inhibitor concentration level by using an ELC-specific test kit or test strips. Inhibitor concentration level determines corrosion protection. If you are concerned about possible coolant quality, contamination, or mechanical problems, submit a coolant sample for analysis. Improper maintenance may cause coolant degradation and could result in damage to the cooling system and engine components. Consult your dealer or the ELC manufacturer's representative for recommended ELC

test kits, test strips, and laboratory sample procedures.

## ELC Extender

Add ELC extender if necessary at the maintenance interval under "Cooling".

## Coolant Filter

If your vehicle came with a non-chemical filter ("blank filter"), replace it only with a blank filter at the interval specified in the Preventive Maintenance Schedule on page 5-12. Never use filters that contain SCAs in an ELC-filled system.

## Topping Off

	<b>WARNING!</b>
<p>Removing the fill cap on a hot engine can cause scalding coolant to spray out and burn you badly. If the engine has been in operation within the previous 30 minutes, be very careful in removing the fill cap. Protect face, hands, and arms against escaping fluid and steam by covering the cap with a large, thick rag. Do not try to remove it until the surge tank cools down or if you see any steam or coolant escaping. In any situation, remove the cap very slowly and carefully. Be ready to back off if any steam or coolant begins to escape.</p>	

# COOLING SYSTEM

	<b>NOTE</b>
If frequent topping off is necessary and there are no visible signs of coolant leaks when the engine is cold, check for leaks with the engine operating at normal temperature.	

Top off the cooling system when coolant does not rise to the level indicated as 'MIN' on the surge tank. The surge tank is translucent which allows the coolant level to be seen. Add coolant through the surge tank fill cap. Do not remove the pressure cap to fill the cooling system.

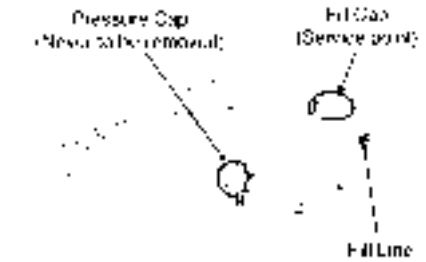

## Surge Tank

	<b>NOTE</b>
Do not use the pressure cap to fill the surge tank with fluid.	

## Proper Coolant Level

	<b>NOTE</b>
Do not overfill a cooling system. Excess coolant may result in overflow, loss of antifreeze, and reduced corrosion protection.	

- The minimum fluid level is determined by the line on the surge tank indicated by the letters "MIN". This indicator is located below the fill cap.
- The cooling system will need fluid if the surge tank level does not rise to the "MIN" line regardless if the system is hot or cold.

## Refilling Your Radiator

1. If your cooling system is built with drain valves in the upper engine coolant pipe, open them before filling the surge tank.
2. Close any open coolant drains in the system.
3. Remove the surge tank fill cap (do not remove the surge tank pressure cap).
4. Fill the system with premixed coolant through the surge tank fill cap. Pour coolant at a steady flow

- rate until the surge tank is full (to the base of the fill neck). It may be necessary to pause for 1 minute and then re-fill if the fluid level dropped.
5. Close any drain valves that were opened in Step 1.
  6. Start the engine and idle at low RPM.
  7. During low rpm idle, air will purge from the cooling system which will lower the coolant level in the surge tank. Continue to fill the surge tank until the coolant level remains approximately ½ in. above the "MIN" line. This may take up to 2 minutes, depending on the outside temperature.
  8. Operate the engine throttle until the operating temperature stabilizes (when the thermostat opens).

9. Fill the surge tank as necessary to raise the coolant level to ½ in. above the "MIN" level.
10. Operate the engine at high idle for another 10 minutes and then fill the surge tank again to ½" above the "MIN" level.
11. Replace the surge tank fill cap.

Check the coolant level after each trip. Add coolant as necessary. You may find your coolant level is not up to the correct level soon after you have filled the radiator. This may be because all of the trapped air in the system has not yet been purged. It takes a little time for all the air to leave the system after you fill your radiator.

**Engine (Block) Heater**

	<b>WARNING!</b>
Do not use the heater if there are any signs of problems. Engine block heaters can cause fires resulting in death, personal injury, equipment or property damage if not properly maintained and operated. Regularly inspect the engine block heater wiring and connector for damaged or frayed wires. Contact your authorized dealer or the manufacturer of the heater if you are in need of repairs or information. Failure to comply may result in death, personal injury, equipment or property damage.	

	<b>CAUTION</b>
Always unplug the block heater before starting your engine. Damage to the cooling system could occur if not turned OFF (unplugged).	

## COOLING SYSTEM

---

Use a solution of half ethylene glycol antifreeze and half water for best heater performance. Do not use more than 65 percent concentration of antifreeze, as a shortened heater life will result.

After servicing the cooling system, operate the vehicle for a day or two before using the heater. Trapped air inside the engine needs time to escape.

## ELECTRICAL

### Electrical System



#### WARNING!

Battery posts, terminals and related accessories contain lead and lead compounds, chemicals known to the State of California to cause cancer and reproductive harm. Wash hands after handling.



#### CAUTION

Do not modify or improperly repair the vehicles electrical system or power distribution box. All electrical repairs should be performed by an authorized dealer. Improper repair or modifications will void your warranty and/or cause serious damage to your vehicle.

### Low Voltage Disconnect (LVD)

#### Purpose

The LVD may increase battery life and prevent unnecessary jump start conditions by ensuring that an unattended load does not deplete the battery charge to a level that will prevent you from starting your vehicle.

#### Operation

The LVD will disconnect non-vital battery loads when battery voltage drops below 12.3V for 3 minutes and the key switch is in the ACC or OFF position. During the last 2 minutes the LVD will emit a slow audible beep. 30 seconds before disconnecting loads the alarm will change to a fast beep. The battery voltage must come back up above a certain voltage before the LVD will reset.

See an authorized dealer if the LVD fails to reconnect loads during normal operation.

#### Circuits Disconnected By LVD

- Cab Dome Lamps
- Cab Accessories
- Spare Battery A and B



#### NOTE

All LVD circuits are color-coded blue on the central electrical panel cover label.



## WARNING!

Do not use the Spare Battery A and B circuits or other circuits that are controlled by the LVD to power electronic engine controls, ABS circuits, or safety/work-related lighting. Before adding any device to the vehicle's electrical system, consult your nearest authorized dealer or read the contents of TMC RP-136. Failure to do so may cause equipment damage or lead to personal injury.



## NOTE

The determination of what circuits/loads that were connected to the LVD was based upon the recommendation from Technology and Maintenance Council (TMC) of the American Trucking Association. To review the recommended practice, see TMC RP-136.

## Light Bulbs Headlight Replacement

Replacing a headlight bulb is accomplished by accessing the rear of the headlight via an access panel in the front fender. Open the hood to get access to this panel.

Once the panel is open, the headlight bulb socket may be removed to replace the bulb.



## WARNING!

Optional HID headlights have high voltage circuits and should only be serviced by a trained technician. Attempting to service the HID ballast without proper training may result in severe electrical shock which could lead to death or personal injury.

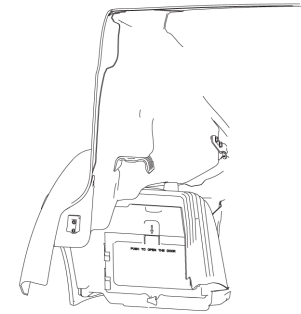

Access door



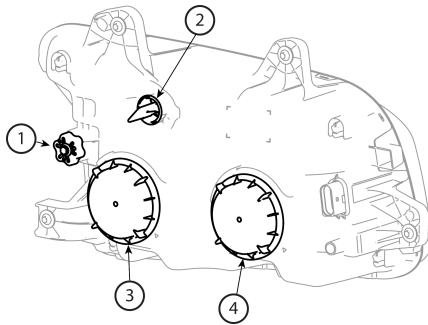

1. Adjustment knob
2. Park/turn lamp
3. Low beam
4. High beam

### Headlight Aiming

The headlights were properly aimed at the factory to meet safety specifications. If the headlights need to be adjusted, please have an authorized dealership aim the headlights.

### Bulb Specifications

Bulb Location	Type of Bulb
Low Beam Halogen	H11-LL (SAE), H7 (ECE) (long life version not required)
Low Beam HID	D1-S
High Beam Halogen	HB3A – LL (long life version not required)
Turn Signal/ Daytime Running Lamp	4157 NAK (SAE), PY27/7W (ECE)
Side Marker/Position Lamp/Park Lamp	168(SAE), W5W (ECE)
Rear tail light/ Turn Signal	Not applicable – LED lighting
Interior map/dome/indirect light	Not applicable – LED lighting

## **ELECTRICAL**

---

### **Fuses, Circuit Breakers and Relays**

Fuses, circuit breakers, and relays are located in the Power Distribution Box to the left of the steering column behind the clutch pedal. Additional fuses are located in the engine compartment (drivers side bulkhead) and also in the sleeper under bunk storage compartment.



Engine Area Fuse Label

# ELECTRICAL

5



In-Cab Fuse Label

SLEEPER LABEL

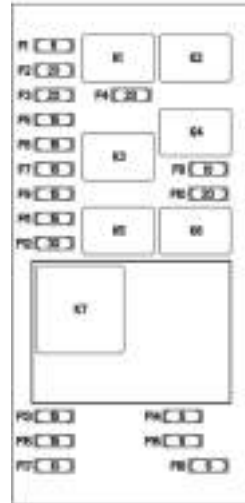

FUSE NUMBER	FUSE DESCRIPTION	AMP	FUSE TYPE
F1	WAC (2) FND	5A	W001
F2	SPARK LSV	10A	W001
F3	STAKE LPS	10A	W001
F4	SPARK SFTD	10A	W001
F5	LIGHTING OVER	10A	W001
F6	AUDIO	10A	W001
F7	ACC HEADPHONE LB	10A	W001
F8	SWALLOW	10A	W001
F9	REFrigerator SW	10A	W001
F10	AUX HEATED	10A	W001
F11	ACC UPPER SW	10A	W001
F12	WV TOLL	10A	W001
F13	CIGARETTE LIGHTER	10A	W001
F14	REAR CIGAR	5A	W001
F15	ACC LOWER SW	10A	W001
F16	SPARK SOLV CTL	5A	W001
F17	LIGHTING LOWER	10A	W001
F18	ACC SWITCHED POWER	5A	W001

RELAY NUMBER	RELAY DESCRIPTION	RELAY TYPE
R1	A/C OVERRIDE	RELAY - W120
R2	SPARK RELAY 1	RELAY - W120
R3	AUX HEATER LT	RELAY - W120
R4	SPARK CTL	RELAY - W120
R5	SPARK RELAY 2	RELAY - W120
R6	ACCESSORY	RELAY - W120
R7	SW	RELAY - 70 & 150

Sleeper Fuse Label

## Fuse Inspection and Replacement

If a fuse is blown, see What to do if fuse or relay blows on page 2-6 for more information.

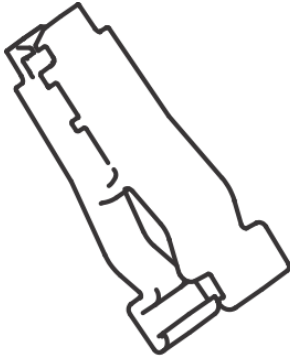

Fuse Puller

## Adding Electrical Options



### WARNING!

Do not add a fuse with a rating higher than 30 amps. Follow the circuit protection size/type recommended by the component manufacturer. Installing a fuse or circuit breaker greater than designated may damage the electrical system which could lead to equipment damage and/or personal injury.



### CAUTION

Follow all manufacturers' circuit protection recommendations for the components and wires being added. Failure to comply may result in equipment damage.

	<b>NOTE</b>
If you are unfamiliar with proper electrical repair practices and procedures, see your authorized dealer for assistance.	

	<b>NOTE</b>
Easy addition of circuits is provided by plug-in connectors that have a ground and a power wire.	

For proper electrical system performance, refer to a wiring diagram for your chassis before adding electrical options.

	<b>WARNING!</b>
Never install a circuit breaker in a circuit that is designated as “fuse-only” circuit(s). Fuse-only circuits are marked with an * on the reverse side of the Power Distribution Box cover. Using a circuit breaker in those fuse-only circuits may cause the circuit to overheat when a short exists which could lead to equipment damage and/or personal injury.	

## Batteries

### Battery Access

The vehicle is originally equipped with three or four batteries. Replacement batteries must meet the following specifications: maintenance-free, group 31 size, threaded stud, 12V/ 650 cold cranking ampere (CCA), and 160 minutes of reserve capacity.

The battery compartment is located on the left side of the vehicle, under the cab access steps.

1. Remove the 6 bolts that are located in the 2 cab access step plate.
2. Remove battery cover for access.

# ELECTRICAL

## In-Cab Battery Box

Your vehicle may be equipped with Absorbed Glass Mat (AGM) batteries located in the cab under the passenger's seat. The glass mat in AGM batteries are designed to absorb the battery acid inside the battery that can leak or spill out in conventional batteries. This design feature allows batteries to be positioned in any orientation without risk of leaking.

To access the batteries:

1. Remove 6 fasteners securing the passenger side seat base to the battery box assembly.
2. Remove the seat and seat base as one unit to gain access to the batteries.

 <b>WARNING!</b>
Replace only with AGM (Group 31) batteries. Use of other batteries could result in acid leaks causing personal injury in the event of a vehicle accident. Failure to comply may result in death, personal injury, equipment or property damage.

 <b>WARNING!</b>
Battery cables and air/electrical harnesses are mounted to the bottom of the floor. Do not drill or screw into floor pan without first checking the location of the cables, harnesses or any other component that might be damaged. Damaging any component could result in electrical shock which could cause personal injury and/or loss of a critical truck system. Failure to comply may result in death, personal injury, equipment or property damage.

 <b>WARNING!</b>
Electrical damage or battery explosion can occur when improperly charging batteries. Refer to the Charging System on page 5-89 for appropriate charging instructions. Failure to comply may result in death, personal injury, equipment or property damage.



 <b>WARNING!</b>
Batteries release gases that are flammable. Batteries are equipped with vent tubes and flash arrestors which vent battery gases out of the cab. Ensure all vent tubes, flash arrestors and grommets are properly installed and ensure they are clear and functioning properly. Failure to reinstall or keep the vent tubes and grommets clear or ensure the flash arrestor(s) are functioning properly could result in personal injury or equipment damage. Failure to comply may result in death, personal injury, equipment or property damage.

 <b>CAUTION</b>
Do not store other items in this battery box. Failure to comply could result in damage to the truck and/or batteries.

 <b>CAUTION</b>
Properly secure battery tie downs and battery box cover when reinstalling batteries after service. Do not over tighten. Over tightening can crack the battery case which can lead to equipment damage.

 <b>CAUTION</b>
The Diesel Exhaust Fluid (DEF) system purges to prevent damage from freezing. If your vehicle is equipped with battery disconnect switches, do NOT disconnect battery power within two minutes of switching the ignition key off. Failure to comply may result in vehicle or property damage.

## Removing and Installing Batteries:

1. Be sure all switches on the vehicle are turned OFF.
2. Wait 2 minutes after turning ignition off then disconnect negative ground cable first.
3. Disconnect positive cable.
4. Unscrew bolt of holding plate with open end wrench.

 <b>NOTE</b>
Always dispose of automotive batteries in a safe and responsible manner. Contact your authorized dealer for disposal standards. Call your local authorized recycling center for information on recycling automotive batteries.

# ELECTRICAL

Follow the procedure below to reinstall batteries on the vehicle:

	<b>NOTE</b>
Make sure to reconnect the ground (negative) cable last.	

1. Place batteries in vehicle and tighten bolt of holding plate.
2. Reconnect positive cable.
3. Reconnect ground (negative) ground cable.

	<b>WARNING!</b>
Battery replacement may alter or disturb battery cable routing. Check to insure battery cables are free from any point of chaffing. Failure to comply may result in death, personal injury, equipment or property damage.	

## Replacing Parts Removed for Access

1. Replace battery cover.
2. Install 2 bolts in step strut. Torque to 24-32 lb-ft (33-43 Nm).
3. Install fairing and install 4 bolts. Torque to 6-7 lb-ft (8-9 Nm).
4. Install steps by installing 2 bolts in each step. Torque to 24-32 lb-ft (33-43 Nm).

	<b>WARNING!</b>
Always reinstall the steps before entering the cab. Without the steps you could slip and fall, resulting in possible injury to yourself.	

	<b>WARNING!</b>
Fairings not installed properly could come loose and cause other motorists to have an injury accident. It is important that fairings be installed properly. Failure to comply may result in death, personal injury, equipment or property damage.	

	<b>WARNING!</b>
Before attempting any work on the batteries or electrical system, remove all jewelry. If metal jewelry or other metal comes in contact with electrical circuits, a short circuit may occur causing you to be injured, as well as electrical system failure and damage.	

## Battery Care

Regular attention to the charging system will help prolong the service life of the batteries. Here are some common causes of battery failure:

**Overcharge:** this condition results from improper voltage regulator adjustment. It results in overheating of the battery, warped plates, and evaporation of electrolyte.

**Undercharge:** the voltage regulator is malfunctioning, the drive belt is slipping, or your vehicle has undergone long periods of standing idle or short distance driving. These conditions result in battery plates becoming covered with a hard coating.

**Vibration:** loose battery hold-downs may cause battery plate failure.

**Short Circuits:** these discharge the battery by draining electricity.

### Dirty or Loose Connections:

improper connections may stop the flow of electrical power to and from the battery.

## Battery Charging

Except for using small trickle charges to maintain battery condition, you should have your vehicle's batteries charged by a qualified service facility.



### WARNING!

Batteries can injure you severely. They contain acid, produce poisonous and explosive gases, and supply levels of electric current high enough to cause burns. A spark or flame near a battery on charge may cause it to explode with great force. Never remove or tamper with the battery caps. Failure to comply may result in death, personal injury, equipment or property damage.

**To help reduce the risk of personal injuries, follow these guidelines carefully when recharging a battery:**

- Before attempting any service in the electrical installation,

disconnect the battery negative cable.

- Allow no sparks or open flame anywhere near the charging area.
- Charge a battery only in a well-ventilated area, such as outdoors or in a fully open garage which contains no pilot lights or other flames. Gases generated during the charging process must be allowed to escape.
- Always make sure the battery charger is OFF before connecting or disconnecting the cable clamps.
- To avoid short circuits, damage to the vehicle, or personal injury, never place metal tools or jumper cables on the battery or nearby. Metal that accidentally comes in contact with the positive battery terminal or any other metal on the vehicle (that is in contact with the

positive terminal), could cause a short circuit or an explosion.

### Charging Reminders

- Use protective eyewear.
- Keep all batteries away from children.
- Never reverse battery poles.
- Never attempt to place the vehicle in motion, or run the engine with batteries disconnected.
- Keep the battery clean and dry.
- Look for any signs of damage.
- Battery terminals should not be coated with improper grease. Use petroleum jelly or commercially available, noncorrosive, nonconductive terminal coatings.
- Never use a fast charger as a booster to start the engine. This

can seriously damage sensitive electronic components such as relays, radio, etc., as well as the battery charger. Fast charging a battery is dangerous and should only be attempted by a competent mechanic with the proper equipment.

## Slow Battery Charging

	<b>NOTE</b>
Follow the instructions that come with your battery charger.	

- It is not necessary to remove the battery from the compartment.

	<b>WARNING!</b>
Charger cables must be connected positive to positive (+ to +) and negative to negative (- to -). If connected improperly, batteries could explode. Failure to comply may result in death, personal injury, equipment or property damage.	

	<b>WARNING!</b>
Always make sure the battery charger is OFF before connecting or disconnecting the cable clamps. To reduce the danger of explosions and resulting death or personal injury, do not connect or disconnect charger cables while the charger is operating.	

1. Disconnect the battery cables.
2. Connect charger cables.
3. Start charging the battery at a rate not over 6 amperes. Normally, a battery should be charged at no more than 10 percent of its rated capacity.
4. After charging, turn OFF charger and disconnect charger cables.

## Electrical and Alternator Precautions

**Take the following precautions to avoid burning out alternator diodes:**

- Do not start the engine with alternator disconnected (connections removed) from the circuit.
- Before welding, disconnect all electronic connections to the vehicle batteries.
- Remove battery power cable and insulate it from the vehicle.
- Do not run the engine with the batteries disconnected.
- Do not disconnect the battery cables or alternator connection cables with the engine running.
- Never turn the ignition switch from the ON position to the START position with the engine running.

- When charging the battery (installed in the vehicle) disconnect the battery cables.
- Do not reverse the cables of the alternator, starter motor, or battery.
- Do not polarize the alternator. The alternator should not be polarized like a generator. To ensure correct polarity, use a test lamp or a voltmeter.

### Remote Keyless Entry

The remote keyless entry system may become inoperational due to a key fob battery. If you have issues with a key fob, replace the battery and re-synchronize the key fob. In some situations, the key fob may need to be replaced and in others, a fuse may have failed and may render both key fobs inoperative.

Contact your dealer for more help if a key fob does not work and it is not because of a bad battery.

## ENGINE

### Engine Maintenance

**WARNING!**

Exhaust fumes from the engine contain carbon monoxide, a colorless and odorless gas. Do not breathe the engine exhaust gas. A poorly maintained, damaged or corroded exhaust system can allow carbon monoxide to enter the cab. Entry of carbon monoxide into the cab is also possible from other vehicles nearby. Failure to properly maintain your vehicle could cause carbon monoxide to enter the cab and cause death or personal injury.

**WARNING!**

Never idle your vehicle for prolonged periods of time if you sense that exhaust fumes are entering the cab. Investigate the cause of the fumes and correct it as soon as possible. If the vehicle must be driven under these conditions, drive only with the windows open. Failure to repair the source of the exhaust fumes may result in death, personal injury, equipment or property damage.

**NOTE**

Keep the engine exhaust system and the vehicle's cab ventilation system properly maintained. It is recommended that the vehicle's exhaust system and cab be inspected:

- By a competent technician every 15,000 miles,
- Whenever a change is noticed in the sound of the exhaust system,
- Whenever the exhaust system, underbody or cab is damaged.

## Engine Lubrication

Refer to the engine manufacturer's Engine Operation and Maintenance Manual supplied with your vehicle for information about draining and refilling engine oil, engine crank case capacity, engine oil type, and changing oil filters, etc.



### WARNING!

Hot engine oil can be dangerous. You could be burned. Let the engine oil cool down before changing it. Failure to comply may result in death, personal injury, equipment or property damage.

## Inspection of the Engine Oil Level



### NOTE

It takes approximately 15 minutes for all the oil to run into the sump when the engine is 'warm.' If the level is checked immediately after switching off the engine, the dipstick will show a low oil level.

1. Make sure that the vehicle frame rail is standing on a flat and level surface.
2. Make sure that the vehicle is horizontal, both lengthwise and crosswise. Check this carefully on a vehicle with air suspension. Note that the engine may be inclined up to 4° depending on the vehicle model and wheelbase.
3. Twist the dipstick handle to unlock it, then pull the dipstick out of the holder.
4. Wipe the dipstick clean with a lint-free cloth.
5. Place the dipstick back into the holder.
6. Pull the dipstick out again and check the oil level. The oil level should always be between the 2 marks on the dipstick.



7. Reinstall the dipstick and twist to lock it in place.

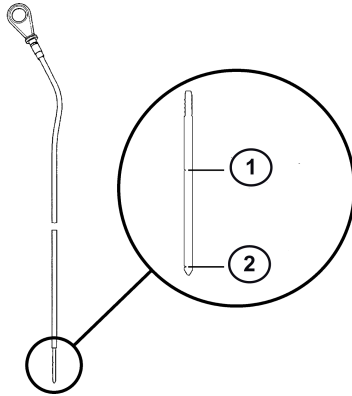

1. Engine Oil High Level
2. Engine Oil Low Level

## Topping Up the Engine Oil

1. Top up with oil, if necessary, via the filler opening. Use the correct grade in the correct quantity. For oil replacement, please see engine Operator's Manual included with this chassis.
2. After topping up, wait 1 minute and check the oil level again.
3. Reinstall the oil fill cap and twist to lock it in place.

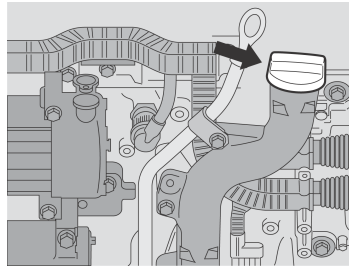

## Pipe and Hose Clamps

Use the following table for torque specifications to check pipe and hose clamps.

# ENGINE

---

## Pipe and Hose Clamp Torque Values

APPLICATION	APPROVED CLAMP	TORQUE	
		Nm	Lb-In
Radiator and Heat Exchanger Hoses	Constant-Torque CT-L	10.2-12.5	90-110
Heater Hoses	Constant Tension	not required	not required
Air Intake Pipes	Hi-Torque HTM-L	11.3-14.2	100-125
Charge Air Intake Hoses	Flex Seal 667	7.9-11.3	70-100
	B9296	6-7	50-60
Fuel, Oil and Water Heat Exchangers (for hoses less than 9/16 diameter)	Miniature 3600L	1.1-1.7	10-15
Exhaust Clamps	Breeze V-Band	54	480

## Accessory Drive Belts

You can extend the reliability and service life of your vehicle's drive belts with proper attention to installation, and maintenance. Neglect could cause belt failure. The result could be the loss of the electrical or air system as well as possible engine damage from overheating. So it's a very good idea to check your belts frequently and replace them as soon as you detect trouble.

Follow this procedure to install an accessory drive belt:

1. Route the new belt around the pulleys, and then rotate the automatic tensioner so that the idler pulley swings toward the belt routing. The following figure shows an example of the rotation direction to release the tensioner.

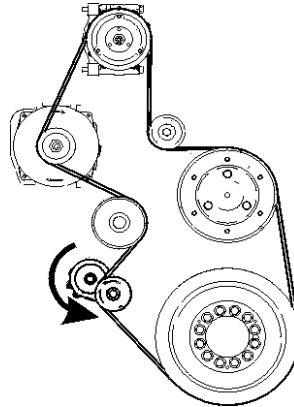

Cummins Belt Routing

2. Slip the belt around the idler pulley attached to the automatic tensioner.
3. Release the automatic tensioner.
4. Check the belt alignment on each pulley. The belt must fall between the flanges of each pulley.

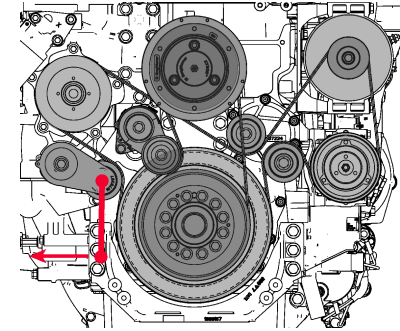

PACCAR MX Belt Routing

i	<b>NOTE</b>
See the engine manufacturer's operator's manual for further information on replacing engine drive belts.	

# ENGINE

## Engine Fan

 <b>WARNING!</b>
Do not work on the fan with the engine running. The engine fan can engage at any time without warning. Before turning on the ignition, be sure that no one is near the fan. Failure to comply may result in death or personal injury.

Your truck may be equipped with an On/Off or Viscous Fan Drive. Follow these guidelines to check your engine fan:

- Check the fan bearings for fan hub bearing looseness, loss of lubricant and any abnormal conditions. (For example, fan belt misaligned or excessive wear/damage.) Before starting the engine and with the engine off, look and feel for looseness in the fan hub.

- With the engine idling and the hood open, stand at the front of the vehicle. Listen for any noises coming from the fan hub. Bearings that have lost lubricant, and are dry, will typically emit a squeal or a growl when the engine is at operating temperature and the fan clutch is engaged. If noise is detected, have the fan bearings inspected by an authorized dealership.

## Fan Drive and Blade

 <b>WARNING!</b>
Do not work on the fan with the engine running. The engine fan can engage at any time without warning. Before turning on the ignition be sure that no one is near the fan. Failure to comply may result in death or personal injury.

**Fan Blade Clearance:** Around the fan shroud, the recommended distance is 1 in. (25 mm) from front edge of any fan blade-to-radiator side member. Minimum clearance is 3/4 in. (19 mm).

- Rear edge of any blade must be no closer than 3/8 in. (9 mm) to the nearest engine component. If this cannot be obtained, the fan spacer or fan is not correct.
- The leading edge of any fan blade must be 1 in. (25 mm) from the inside edge of the shroud.

## Air Intake System

Engine heat, vibration, and age combine to loosen air intake connections and cause cracks in the tubing and elbows. Leaks in the intake system allow abrasive dust to enter the engine and quickly cause expensive damage. During your daily walk-around inspection, carefully check all tubing, elbows, clamps, supports and fasteners for condition and tightness.

- Check the Charge-Air-Cooler for air leaks annually. The air leaks can be caused by cracked tubes or header. For service see your authorized dealer.



### CAUTION

Do not use air intake pipes and connections as a step or to pull yourself up. This could loosen the connections and open the system to unfiltered air which could damage the engine.

## Turbocharger

When servicing the air intake and exhaust systems on a turbocharged engine, check the items listed below.



### WARNING!

Do not operate engine with turbocharger intake piping disconnected. A suction is created when the engine is running. This suction could draw your hand or anything else near it into the impeller fan. You could be injured. Always keep the intake piping connected when you will be running the engine.

**Lubricating System:** Check the oil lines, housing, and connections. Look for leaks, damage, or deterioration. Leaks could mean you have damaged oil lines or oil seals.

**Manifold:** With the engine operating, check for leaking manifold or flange gaskets.

**High Frequency Vibration:** Vibration may indicate turbo rotor imbalance. Have your dealer investigate this immediately. If you detect any deficiencies, take the vehicle to an authorized dealer for servicing. Delay could lead to severe and expensive damage to your vehicle.

# ENGINE

## Air Cleaners

The following service information is basic to all air cleaner makes and models.

	<b>CAUTION</b>
Failure to replace air filter at proper intervals may result in passage of dirt/debris into the engine or the “dusting” of an engine resulting in significant engine damage.	

Service the air cleaner filter elements as specified in the Preventive Maintenance Schedule on page 5-12. Your vehicle is equipped with an air inlet restriction indicator. Service the filter elements when the air inlet restriction indicator locks in the extreme Up position. Paper elements require care and proper handling because they are critical to engine service life. If your vehicle has an external air cleaner and cab-mounted

mirrors, the mirror must be pivoted to provide access for servicing the filter element.

## Replacing the Engine Air Intake Filter

1. Open hood.
2. Loosen a total of 4 screws. (screws will not come out of the housing)
3. Remove lid.
4. Remove filter.

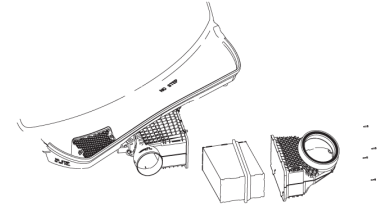

## ServiSignal™ Mini Indicator

The ServiSignal™ Mini Indicator is installed on the air cleaner or air induction piping so it has access to clean filtered air. As the filter plugs and restriction increases, a red flag appears in the window. When it reaches the red zone, the air filter should be replaced. The indicator can be reset by pressing the button at the end of the indicator.

## Exhaust System

The exhaust system is part of the noise and emission control system. Periodically check the exhaust for wear, exhaust leaks, and loose or missing parts. For details see Noise and Emission Control on page 5-117.

Please refer to the Engine Operator's Manual for more details on how to maintain the emission's components in the exhaust system.

## Engine Mounting

**Periodic Inspection:** Inspect engine mounts every 60,000 miles (96,560 km). Check for the following:

- Inspect both mount and leg fasteners. Check for loose or broken bolts. Replace as necessary.
- Check mount and leg for fractures, breaks or deformation. Replace as necessary.
- Check for complete insertion of motor mount. Replace as necessary.
- New leg to mount flange head bolts should be torqued to 210-230 Lb-Ft (284-311 Nm).

## ENGINE

---



### CAUTION

Do not re-torque or reuse existing flange head bolts. These bolts are factory set to the specified torque. If bolts are loose or damaged, they must be replaced with the new bolts. Failure to comply may result in equipment or property damage.



## FUEL SYSTEM

### Location of Fuel Shut-off Valves

Fuel shut-off valves for the fuel crossover line are on the bottom of the secondary fuel tank, at the crossover line connection. They are optional on the primary fuel tank.

### Specification

Use only diesel fuel as recommended by engine manufacturers.



#### **WARNING!**

A mixture of gasoline or alcohol with diesel fuel in the presence of an ignition source (such as a cigarette) could cause an explosion resulting in death or personal injury. Use only the recommended diesel fuel.



#### **CAUTION**

If anyone ever pours gasoline into your fuel tank, drain the entire system. Otherwise, the pump and engine will be damaged. Don't try to dilute the gasoline by adding diesel fuel (See Warning above).

### Fuel Filters

See Engine Manufacturer's Operator Manual provided with this chassis or the instructions provided with a Fleetguard filter.

## FRAME

### Introduction

 **WARNING!**

Do not cut, splice or weld frame rails or drill through the top or bottom flanges of the rails. These operations could affect frame rail strength leading to a failure resulting in an accident. Rail failures resulting from such modifications are not warrantable. Failure to comply may result in death, personal injury, equipment or property damage.

### Emergency Welding

 **WARNING!**

Frame welding is NOT recommended. The high heat of welding nullifies the special heat treatment of the rails, greatly reducing the tensile strength of the frame rail. If a frame member becomes cracked from overloading, fatigue, surface damage or a collision, the only permanent repair is to replace the damaged frame member with a new part.

In an emergency, a temporary repair may be performed. Observe the following precautions to protect electronic systems during welding operations. Emergency welding procedures are further explained in the maintenance manuals. Please refer to the ordering information on the back cover to obtain a maintenance manual.

### Welding Precautions

In the event of emergency welding of a frame rail and when welding any other part of your truck or any component attached to your truck, observe the following precautions before welding:

- Disconnect all electronic devices. It is not possible to list all of the electronics that could be affected, but a few examples include the following: alternator, engine Electronic Control Unit (ECU), transmission ECU, ABS ECU, navigation devices, diagnostic devices, and monitoring devices.
- Disconnect battery cables and insulate them from the vehicle.
- Do not use the ECU or engine ground stud for the ground of the welding probe.
- Ensure that the ground connection for the welder is as close to the

weld point as possible. This ensures maximum weld current and minimum risk to damage of electrical components on the vehicle.

### Painting

Do not electrostatically paint your truck or any component on your truck without first removing all of the electronic components from the truck. It is not possible to list all of the electronics that could be affected, but a few examples include the alternator, engine Electronic Control Unit (ECU), transmission ECU, ABS ECU, navigation devices, diagnostic devices, and monitoring devices.

### Fifth Wheel Maintenance

Proper preventive maintenance is essential to trouble-free service and safe operation of the fifth wheel.

#### Every 15,000 miles or monthly:

- Refer to specific manufacturer's literature for any special instructions.
- Steam clean the fifth wheel.
- Check lock guard operation using a commercial lock tester.
- Clean and oil all moving parts.
- Lubricate the lock mechanism with a lithium-base grease.
- All grease fittings (especially those which grease the top surface of the fifth wheel).

# FRAME

## Every 60,000 miles or 6 months:

- Refer to specific manufacturer's literature for any special instructions.
- Remove fifth wheel from vehicle. Refer to the Shop Manual, "Fifth Wheel Removal."
- Steam clean the fifth wheel and mounting brackets.
- Check all moving parts for excessive wear or damage. Replace all worn or broken parts.
- Complete two-month service procedure.
- Install fifth wheel. Refer to the Shop Manual, "Fifth Wheel Installation."

## Frame Fastener Torque Requirements

Tighten all frame fasteners with a torque wrench. Torque specifications apply to the following fasteners with lightly lubricated threads.

i	NOTE
Whenever possible, torque all frame fasteners on the nut end, not the bolt head.	

## Standard Grade 8 UNF or UNC and Metric

FASTENER SIZE	TORQUE *	
	Nm	Lb-Ft
5/16	22-30	16-22
3/8	41-54	30-40
7/16	75-88	55-65
1/2	109-122	80-90
9/16	156-190	115-140
5/8	224-265	165-195
3/4	394-462	290-340
7/8	517-626	380-460
1	952-1,129	700-830
1-1/8	1,346-1,591	990-1,170
1-1/4	1,877-2,217	1,380-1,630
METRIC WITH NYLON INSERT NUTS		
M5	8-12	6-9
M6	9-15	7-11
M8	23-31	17-23
M10	33-43	24-32
M12	75-101	55-75
M16	163-217	120-160
M20	352-460	260-340
* ESNA Style Lock Nut, with nylon insert. Lubricate nylon insert nut lightly with SAE 20/30 oil.		

## Sliding Fifth Wheels

Lubricate bearing surface of support bracket through the grease fittings on the side of the fifth wheel plate. Use a water resistant lithium-base grease.

i	NOTE
The plate must be lifted up slightly to relieve the weight of the bracket while applying grease.	

## FRONT AXLE AND SUSPENSION

### FRONT AXLE AND SUSPENSION

#### Axle Lubrication

Change bearing lubrication when seals are replaced, or brakes are relined. See Preventive Maintenance Schedule on page 5-12.

Thoroughly clean hubs and bearings with solvent and a stiff bristle brush, then dry and inspect components for wear or damage. Re-lubricate with approved axle lubricant.

#### Kingpin Lubrication

Lubricate with approved lubricant. Lubricate knuckle thrust bearings, knuckle pins, and tie rod ends. See Preventive Maintenance Schedule on page 5-12. Lack of lubrication causes premature wear and hard steering. Lubrication schedule may be shortened if necessary.

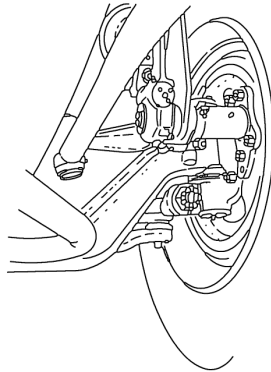

#### Suspension Lubrication

Each standard spring anchor pin has a grease fitting. Pressure lubricate spring pins as specified. See Preventive Maintenance Schedule on page 5-12.

At regular intervals, the spring leaves may be lubricated with a rust-inhibiting oil applied with a spray gun or brush.

Depending on your suspension, lubricate all spring pins until grease flows out of both ends of the bushing. Look for signs of rust or water in the flushed grease. If a pin will not accept grease, it should be removed, cleaned, and inspected.



#### CAUTION

Do not spray the suspension with chemical products or mineral oil; it can cause damage to the bushings.

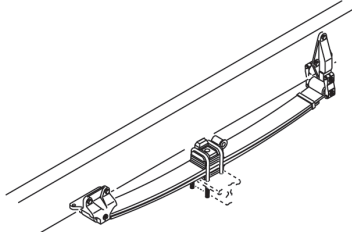

### Inspection

For all vehicles, mandatory maintenance procedures include retightening all U-bolts and inspecting the suspension for loose fasteners, abnormal wear, or damage. However, even with proper maintenance, the service life of leaf springs is affected by many factors, such as: fatigue, vehicle gross weight, type of load, road conditions, and vehicle speed.

Check for cracks, wear marks, splits, or other defects on the surface of the spring. Defective parts must be replaced. Because repaired springs cannot be fully restored to their original service life, replace the complete assembly if cracks or other defects are detected.

Visually inspect shock absorbers and rubber bushings.

### Wheel Alignment

For driving safety and comfort, and to prolong the life of your vehicle, it is important to have wheels correctly aligned. Check tire wear frequently. Uneven tire wear is a sign that the wheels may be misaligned.

If you see uneven wear, take your vehicle to an authorized dealer familiar with aligning wheels on your vehicle.

## FRONT AXLE AND SUSPENSION

### U-Bolt Torque

It is important that U-bolts remain tight. Severe use of your vehicle will cause them to loosen faster. But all vehicles need to have their U-bolts checked and tightened regularly. Be sure someone with the proper training and the right tools checks and tightens the U-bolts on your vehicle.

New springs can settle in after service, relieving the tension on the U-bolts. Loose U-bolts can cause leaf spring breakage, axle misalignment, hard steering and abnormal tire wear.

5

All vehicles should have suspension U-bolts tightened after the first 500 miles (800 km) of operation. Re-torque the front spring pinch bolts and shackle pinch bolts.

 <b>WARNING!</b>
Do not operate the vehicle if the U-bolts are not properly tightened. Loose U-bolts will cause the axle to not be properly secured to the suspension, which could cause loss of vehicle control and an accident. Loose U-bolts can also cause uneven tire wear and poor alignment. Failure to comply may result in death, personal injury, equipment or property damage.

U-bolts are difficult to tighten unless you have the right equipment. If you cannot tighten them correctly yourself, be sure to have them checked and tightened regularly by an authorized mechanic.

Tighten U-bolt nuts to the specified torque value with the vehicle loaded to its normal gross weight. The following torque values apply to U-bolts and nuts with clean threads lubricated with

Chevron zinc lubricant (SAE 20 or 30 oils acceptable but not preferred).

 <b>WARNING!</b>
Do not replace U-bolts and nuts with common U-bolts or standard nuts. These parts are critical to vehicle safety. If the wrong U-bolts or nuts are used, the axle could loosen or separate from the vehicle and cause a serious accident. Use only U-bolts and nuts of SAE Grade 8 specification or better. Failure to comply may result in death, personal injury, equipment or property damage.



## Front Spring Suspension U-Bolts, Grade 8

U-BOLT SIZE DIAMETER (Inch Dimensions)	TORQUE	
	Nm	Lb-Ft
3/4	333-408	245-300
7/8	598-734	440-540
1	925-1,060	680-780
1-1/8	1,470-1,660	1,080-1,220
1-1/4	1,890-2,120	1,390-1,560
1-1/2	3,130-3,860	2,300-2,840

# HEATER AND AIR CONDITIONER

## HEATER AND AIR CONDITIONER

### Introduction

The combination heater-air conditioner provides comfort for those in the cab through accurate control of the cab environment in all weather conditions. Regular attention to the items below will help you keep the heater-air conditioner unit running well.

Keep the vehicle's ventilation system, engine exhaust system and cab joints properly maintained. It is recommended that the vehicle's exhaust system and cab be serviced as follows:

- Inspected by a competent technician every 15,000 miles
- Whenever a change is noticed in the sound of the exhaust system

- Whenever the exhaust system, underbody or cab is damaged

To allow for proper operation of the vehicle ventilation system, proceed as follows:

- Keep the inlet grille at the base of the windshield clear of snow, ice, leaves and other obstructions at all times.
- Keep the exhaust pipe area clear to help reduce the buildup of exhaust gas under the vehicle.
- Check the drain tube of the fresh air inlet for trapped water before assuming that there is a leak in the heating system.

### Special Precautions



#### WARNING!

Excessive heat may cause the pressurized components of the air conditioning system to explode. Never weld, solder, steam clean, or use a blow torch near any part of the air conditioning system. Failure to comply may result in death, personal injury, equipment or property damage.



#### WARNING!

Air conditioning refrigerant can be hazardous to your health. Do not expose yourself to leaking refrigerant for prolonged periods near excessive heat, open flames, or without proper ventilation. Failure to do so may result in death or personal injury.

If a refrigerant leak develops in the presence of excessive heat or an open flame, hazardous gases may be generated. If you become aware of a

refrigerant leak on your vehicle have your system serviced immediately and observe the following precautions:

Stay away from the hot engine until the exhaust manifold has cooled.

Do not permit any open flame in the area. Even a match or a cigarette lighter may generate a hazardous quantity of poisonous gas.

Do not smoke in the area. Inhaling gaseous refrigerant through a cigarette may cause violent illness.

## **Air Filters**

### **Cab Recirculation Air Filter**

Please contact an authorized dealer when the service interval is required to inspect the cabin recirculation air filter.

### **Cabin Fresh Air Filter**

The fresh air filter for the cab HVAC is located in the air intake housing that is located in the passenger rear corner of the engine compartment. The filter can be replaced without using any tools.

Inspect and clean cab air filter element every 3 - 6 months of service. Depending on the operating environment, if air flow from the air conditioner and heater is less efficient or windows fog easier, you may need to replace the cab air filter.

1. Tilt the hood open.
2. Locate air intake housing at passenger rear corner of vehicle under the rain tray.

# HEATER AND AIR CONDITIONER

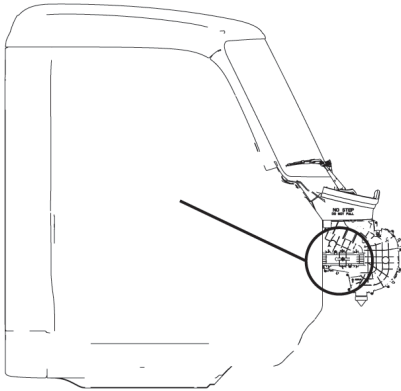

the side of the filter element with the airflow direction that is clearly marked on the air intake housing.

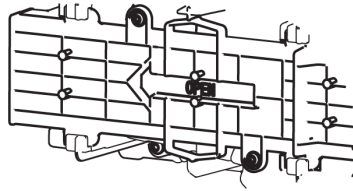

6. Replace the filter cover on the air intake housing and slide the cover forward in vehicle. An audible snap sound can be heard when the cover is correctly in place. If the snap feature is damaged there are two screw features that may be utilized to retain the cover in place.
7. Close and secure hood of vehicle.

## Sleeper HVAC Air Filter

The sleeper recirculation filter is located under the sleeper bunk on the passenger side of the vehicle. Lift the bottom bunk to access the unit. The filter can be replaced without using any tools.

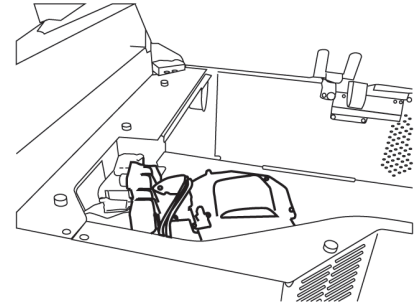

1. Lift the sleeper bunk to expose the sleeper HVAC module.
2. Find the retention tab at the side of the filter element and move it to release the filter. Moving this tab

will allow the filter to be removed in an upward direction.

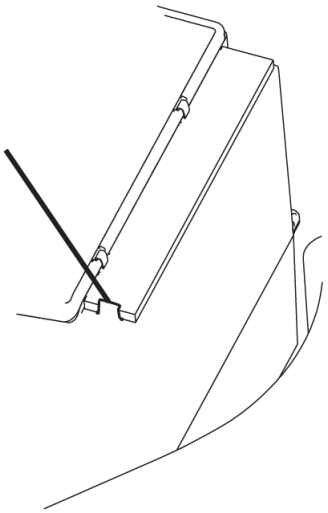

- element such that it points into the HVAC housing.
- 4. Insert the filter and make sure the retention tab has re-engaged to secure the filter.
- 5. Close the bunk.

3. Align the airflow direction that is indicated on the side of the filter

**Heater**

- Check all heater controls for full-range operation.
- Check hoses, connections, and heater core for condition and leaks.

	<b>CAUTION</b>
<p>During extreme cold weather, do not blow hot defroster air onto cold windshields. This could crack the glass. Turn the air direction lever to Defrost and adjust the fan speed accordingly while the engine warms. If the engine is already warm, move the temperature selector to Cool, then gradually increase the temperature when you see that the windshield is starting to warm-up.</p>	

# HEATER AND AIR CONDITIONER

## Air Conditioner

 <b>WARNING!</b>
The air conditioning system is under pressure. If not handled properly during servicing, it could explode. Any servicing that requires depressurizing and recharging the air conditioning system must be conducted by a qualified technician with the right facilities to do the job. Failure to comply may result in death, personal injury, equipment or property damage.

- Listen to the compressor and drive clutch for noise and vibration. If you find problems, have the system checked thoroughly. A malfunctioning clutch usually indicates trouble elsewhere in the system.
- Check the evaporator core, filter, and condenser core for debris restricting air flow. Clean if necessary. Small particles may

be removed with compressed air blown through the core in the opposite direction of normal air flow.

 <b>WARNING!</b>
Wear eye protection any time you blow compressed air. Small particles blown by compressed air could injure your eyes.

- Check the engine belt for condition and proper tension.
- Check all hoses for kinks, deterioration, chafing, and leaks. Adjust kinked or chafing hoses to eliminate restrictions and prevent further wear.
- Check all components and connections for refrigerant leaks. If you discover a leak, do not try to tighten a connection. Tightening a connection may cause a leak

to worsen. Have a qualified technician correct the problem.

 <b>NOTE</b>
A leaking evaporator or condenser core cannot be repaired; it must be replaced.

Have the air conditioning system fully serviced annually by your authorized dealer. Qualified service technicians will have to evacuate and recharge the system.

# NOISE AND EMISSION CONTROL

## Noise Emission Warranty

There are specific components on the vehicle that are designed to meet certain Environmental Protection Agency (EPA) emissions and noise regulations. To maintain conformance with the regulations, these components need to be functional and properly maintained.

### Tampering with Noise Control System

**Federal law prohibits the following acts or the causing thereof:**

(1) The removal or rendering inoperative by any person other than for purposes of maintenance, repair, or replacement, of any device or element of design incorporated into any new vehicle for the purpose of noise control prior to its sale or delivery to the ultimate purchaser or while it is in use, or (2) the use of the vehicle after such device or element of design has been removed or rendered inoperative by any person.

Among those acts presumed to constitute tampering are the acts listed below:

### Air Intake System

- Removing or rendering inoperative the air cleaner/silencers or intake piping.

### Engine Cooling System

- Removing or rendering inoperative the fan clutch.
- Removing the fan shroud.

### Engine

- Removing or rendering engine speed governor inoperative so as to allow engine speed to exceed manufacturer's specifications.
- Modifying ECU parameters.

### Exhaust System

- Removing or rendering inoperative exhaust system components.

# NOISE AND EMISSION CONTROL

---

## Fuel System

- Removing or rendering engine speed governor inoperative, allowing engine speed to exceed manufacturer's specifications.
- Removing of air signal attenuator on engines equipped with this device.
- Removing of diesel exhaust fluid tank and system.

## Inner Fender Shields and Cab Skirts

- Removing shield or skirts.
- Cutting away parts of shields, skirts or damaged or loose portions of shields or skirts.

## Noise Insulating Blankets

- Removing noise insulators from engine block or from around the oil pan.

- Cutting holes in, or cutting away part of noise insulators.
- Removing hood-mounted noise insulation.

## Inspection and Maintenance Instructions

The following instructions are based on inspection of the noise control system at regular intervals as indicated in the Noise Control System Maintenance Log on page 5-124.

If, during periodic inspection and maintenance of other systems and components, it is found that parts of the noise control system require attention, we recommend that those parts be inspected at more frequent intervals to assure adequate maintenance and performance.



## Air Intake System

- Do all checks and maintenance procedures listed in this manual under Engine Air Intake System and Air Cleaner. See Air Dryer on page 5-52.
- Check the induction tubing, elbow connections, clamps, brackets, and fasteners for deterioration, cracks, and security.
- If you find an air leak anywhere between the air cleaner and the engine, repair that leak immediately.

	<b>CAUTION</b>
Air leaks cause excessive noise and may result in serious damage to the engine. If you do not repair them the engine damage will not be covered by your warranty. Repair all air leaks as soon as you find them.	

## Engine Mounted Noise Insulators

- Check condition. Is the insulator secure? How you do this will depend on the method of attaching the noise insulators on the engine and around the oil pan (bolts, snap fasteners, or straps). Tighten loose fasteners and repair or replace any worn or damaged fasteners.
- Check insulators around fasteners and stress points, especially where they may be affected by engine vibration. Repair any cracked or damaged mounting points. Use suitable reinforcing plates to ensure that the insulators will remain in position.

## Exhaust System

- Check for exhaust leaks, which would indicate a leaking manifold gasket; replace gasket if necessary.
- Check cap screws for tightness, including those at the flanges. Refer to the engine manufacturer's service manual for proper tightening sequence and torque values.

# NOISE AND EMISSION CONTROL

---

## Joints and Clamps

- Check for leaks, and tighten as necessary. Check for deterioration or dents in pipes and clamps which could allow exhaust to escape.
- Replace any serviceable joints, flexible pipes and gaskets at the service intervals.

## Selective Catalyst Reduction (SCR)

- Check SCR canister filter, clamps and mounting brackets. Tighten if necessary. Inspect SCR canister for signs of rust or corrosion.

## Piping

- Check exhaust piping for rust, corrosion, or damage. Replace deteriorated piping before holes appear. If piping is perforated at any point, temporary patching or lagging is acceptable until you can have permanent repairs made. On turbocharged engines, check joints at flanges and mounting brackets for tightness.

## Diesel Particulate Filters (DPF)

- Check diesel particulate filter (DPF), clamps, and mounting brackets. Tighten if necessary. Inspect diesel particulate filter (DPF) for signs of rust or corrosion.
- Check internal baffling. You can do this by listening for rattling sounds while tapping on the diesel particulate filter (DPF) with a rubber mallet or revving the engine up and down through its normal operating range.

## Diesel Exhaust Fluid Tank

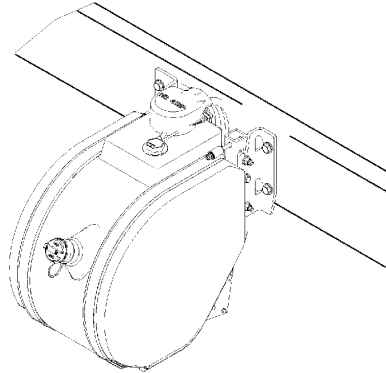

Vehicles that comply with 2013 EPA emission requirements will have a Diesel Exhaust Fluid (DEF) tank mounted to the vehicle frame.

CAUTION	
	The Diesel Exhaust Fluid (DEF) system purges to prevent damage from freezing. If your vehicle is equipped with battery disconnect switches, do NOT disconnect battery power within two minutes of switching the ignition key off. Failure to comply may result in vehicle or property damage.

## DEF Filter

The DEF system has a supply pump filter and this filter should be serviced according to the preventive maintenance schedule. Follow these steps to replace the DEF supply pump filter:

1. Turn off the vehicle and allow the vehicle to cool down. Take special precaution with hot exhaust piping.

# NOISE AND EMISSION CONTROL

	<b>WARNING!</b>
<p>The exhaust piping can become extremely hot during engine operation and can cause personal injury including serious burns to the skin. Allow adequate cooling time before working near any part of the exhaust system.</p>	

2. Remove the pump protective plate mounted on the bottom of the DEF tank.

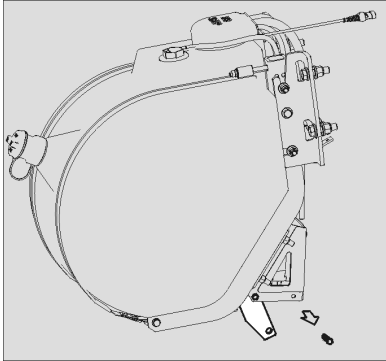

3. Using a 27 mm socket wrench (DIN3124), remove the filter cap that is screwed to the DEF Supply pump.

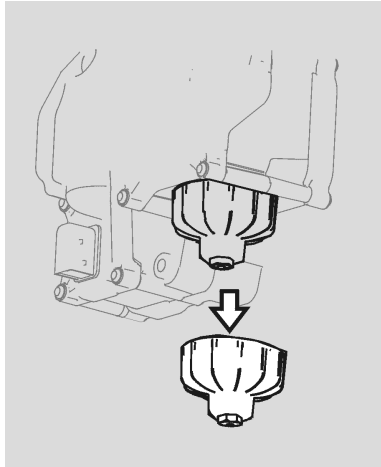

## Exhaust Tail Pipe

- Check the mounting. Tighten as necessary. The miter cut at the tip of the pipe must be facing the rear of the vehicle. Do not modify the end of the pipe in any way.

### Engine Fan and Shroud



#### WARNING!

Do not work on the fan with the engine running. The engine fan can engage at any time without warning. Anyone near the fan when it turns on could be injured. Before turning on the ignition, be sure that no one is near the fan.

- Check all fasteners for tightness. Check for stress cracks in the shroud. Make sure the shroud is adjusted so that it does not touch the fan blades.
- Check to verify that the fan is disengaged (not turning) with the engine running at normal operating temperatures (from cold to the point that the fan engages).
- Check fan blade mounting bolts. Inspect fan blades to be sure they are not cracked or bent.

### Hood Insulation Blanket

- Check all fasteners for condition and security. Repair or replace any broken or defective fasteners.
- Check for chafing or tears. Patch it if necessary. Find the cause of the damage. If any component or accessory is causing wear or damage and cannot be relocated, put reinforcing pads on the blanket at the site of wear.

### Inner Fender Shields and Cab Skirts

- Check all fasteners that hold the fender shields in place.
- Check fender shields for tire marks, worn spots, or damage from objects thrown from tire treads.
- Check cab skirts, sills, and brackets for overall condition and repair them as necessary. Damaged rubber fender shields or cab skirting cannot be repaired. You will need to replace it.

# NOISE AND EMISSION CONTROL

## Noise Control System - Maintenance Log

To ensure your vehicles noise control requirements are maintained, record

maintenance checks. Use the following log sheet and retain copies of documents regarding maintenance services performed and parts replaced on the vehicle.

### Noise Control System - Maintenance Log

Component	Recommended Interval (Miles)	Date & R.O. No.	Repair Facility & Location	Work Performed	Date & R.O. No.	Repair Facility & Location	Work Performed
Exhaust System Routing Integrity	25,000						
Shutters Shrouds	25,000						
Hood Insulation Blanket	10,000						
Engine Mounted Hose Insulators Fasteners	10,000						
Inner Fender Shields	50,000						
Cab Skirts Fasteners	50,000						
Air Intake System Integrity Element	5,000						
Clutch Type Fan Drive	10,000						

## REAR AXLE AND SUSPENSION

### General Maintenance

 <b>WARNING!</b>
Do not work on the vehicle without the parking brake set and wheels blocked securely. If the vehicle is not secured to prevent uncontrolled vehicle movement, it could roll and may result in death, personal injury, equipment or property damage.

Your vehicle's suspension, by design, requires a minimal amount of maintenance. However, suspensions in over-the-road operations require periodic inspection to ensure trouble-free performance.

 <b>WARNING!</b>
Do not operate the vehicle if the U-bolts are not properly tightened. Loose U-bolts will cause the axle to not be properly secured to the suspension, which could cause loss of vehicle control and an accident. Loose U-bolts can also cause uneven tire wear and poor alignment. Failure to comply may result in death, personal injury, equipment or property damage.

 <b>WARNING!</b>
Failure to maintain the specified torque values or to replace worn parts can cause component system failure, possibly resulting in an accident. Improperly tightened (loose) suspension U-bolts can lead to unsafe vehicle conditions, including: hard steering, axle misalignment, spring breakage or abnormal tire wear. See Front Spring Suspension U-bolts on page 5-111 for proper torque specifications. Failure to comply may result in death, personal injury, equipment or property damage.

 <b>CAUTION</b>
Do not spray the suspension with chemical products or mineral oil; it can cause damage to the bushings.

	NOTE
Failure to follow these recommendations could void warranty.	

### Visual Inspection

For all vehicles, mandatory maintenance procedures include retightening of U-bolts and complete inspection. However, even with proper maintenance, many factors affect the service life of springs and suspension components, such as: fatigue, vehicle gross weight, type of load, road conditions, and vehicle speed.

It is important that U-bolts remain tight. Severe use of your vehicle can cause them to loosen faster. But all vehicles need to have their U-bolts checked and tightened regularly. Be sure someone with the proper training and the right tools checks and tightens the U-bolts on your vehicle.

- After the first 500 miles (800 km) of operation, inspect the suspension periodically, as noted below:

- Visually check for loose or missing fasteners, cracks in hanger, or axle connection brackets.
- Check that springs are centered in hangers and in good condition.
- Check for cracks, wear marks, splits, or other defects on the surface of the spring.
- Replace defective parts. Because repaired springs cannot be fully restored to their original service life, replace the complete assembly if cracks or other defects are detected.
- After replacement of any part or discovery of loose components, check the torque of all fasteners.
- New springs settle-in after the vehicle's initial service, causing the U-bolts to become loose.



## Rear Suspension Fasteners

To maintain the performance of the air suspension, check fastener torque values after the first 2,000 miles (3,218 km) of service and every 60,000 miles (96,000 km) thereafter.

Torque recommendations apply to fasteners supplied and installed by vehicle manufacture. The values listed in the tables below, are for cadmium plated or phosphate and oil fasteners only.

U-bolts are difficult to tighten unless you have the right equipment. If you cannot tighten them correctly yourself, be sure to have them checked and tightened regularly by an authorized mechanic.

## U-Bolt Torque

	<b>NOTE</b>
To ensure an accurate torque reading, use properly maintained and calibrated torque wrenches. Clean the nut and bolt. No dirt, grit, or rust should be present.	

	<b>WARNING!</b>
Do not operate the vehicle if the U-bolts are not properly tightened. Loose U-bolts will cause the axle to not be properly secured to the suspension, which could cause loss of vehicle control and an accident. Loose U-bolts can also cause uneven tire wear and poor alignment. Failure to comply may result in death, personal injury, equipment or property damage.	

	<b>NOTE</b>
Whenever possible, torque all fasteners on the nut end, not the bolt head.	

## Rear Suspension Fasteners (Metric and Standard)

SIZE/TYPE	TORQUE *	
	Nm	Lb-Ft
M16 nylon-insert nuts	163-217	120-160
M20 nylon-insert nuts	352-460	260-340
M20 all-metal lock nuts	427-475	315-350
1/2 in. nut	109-122	80-90
3/4 in. nut	394-462	290-340
1-1/4 in. nut	1,877-2,217	1,380-1,630
* Torque requirements apply to manufacturer proprietary suspensions. All other suspensions must refer and adhere to original manufacturers shop manual.		

# REAR AXLE AND SUSPENSION

## Rear Suspension U-Bolts, Grade 8 (lubricated\*)

U-BOLT SIZE DIAMETER THREAD	TORQUE**	
	Nm	Lb-Ft
3/4	333-408	245-300
7/8	598-734	440-540
1	925-1,060	680-780
1-1/8	1,470-1,660	1,080-1,220
1-1/4	1,890-2,120	1,390-1,560
1-1/2	3,130-3,860	2,300-2,840

\*Chevron Zinc Lubricant or SAE 20/30 oil should be used on U-Bolt threads

\*\*Torque requirements apply to manufacturer proprietary suspensions. All other suspensions must refer and adhere to original manufacturers shop manual.



### WARNING!

Do not replace U-bolts and nuts with common U-bolts or standard nuts. These parts are critical to vehicle safety. If the wrong U-bolts or nuts are used, the axle could loosen or separate from the vehicle and cause a serious accident. Use only U-bolts and nuts of SAE Grade 8 specification or better. Failure to comply may result in death, personal injury, equipment or property damage.

## Rear Axle Lubrication

Check oil level with the vehicle parked on level ground and the fluid warm. The level should be even with the bottom of the filler hole.

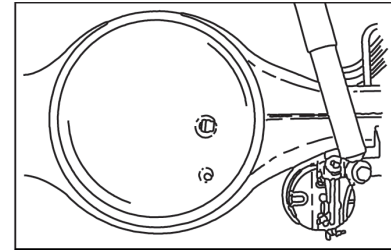

5

- Load the vehicle to its normal gross weight before tightening U-bolts. Loading the vehicle ensures proper adjustment of the U-bolt and spring assembly.

	<b>CAUTION</b>
<p>Do not mix lubricants of different grades; although, mixing different brands of the same grade lubricant (meeting MIL L2105C), is acceptable. Lubricants of different grades are not compatible and could damage the axle.</p>	

	<b>NOTE</b>
<p>In all cases, lubricant supplier assumes full responsibility for the performance of their product, and for product and patent liability.</p>	

For recommended types and brands of lubricants, contact your dealer.

### Dana Spicer and Fabco

No initial drain is required on Dana Spicer axles that are factory filled with an Dana Spicer-approved synthetic lubricant.

- Petroleum-based lubricants must be drained within the first 5,000 miles (8,000 km) if converting to an approved synthetic lubricant.

**Initial Change:** See Preventive Maintenance Schedule on page 5-12 for standard rear axle service intervals. Change mineral-based lubricant in other Dana Spicer and Fabco axle assemblies (new or rebuilt) within the first 3,000 to 5,000 miles (4,800 to 8,000 km).

- For petroleum-based axles, use lubricants meeting MIL L2105C/D grade specifications or approved synthetic lubrication. Do not use oil additives.

**All Vehicles with Dana Spicer and Fabco Axles:** See Preventive Maintenance Schedule on page 5-12. Contact your dealer for approved synthetic lubricant brands.

- Dana Spicer Axles with synthetic lubrication and Out Runner Seals: drain, flush, and refill at 500,000 miles (804,000 km).

### Axle Housing Breather Vent:

- Check and clean the axle housing breather vent at each oil level check.

### Meritor:

- See Meritor Lubrication Maintenance Manual (MM1).

# REAR AXLE AND SUSPENSION

---

## Rear Axle Alignment

Continual road shock and load stresses may force the rear axles out of alignment. If you detect rapid tire wear on the rear axles, you may have misaligned axles. If you suspect rapid tire wear, have your rear axle alignment checked and adjusted by an authorized dealer.

In addition to pre-delivery inspections, suspension alignment should be checked when any one of the following conditions exist:

5

- Discovery of loose suspension fasteners. (Loose, defined as any torque below the recommended torque value.)
- Discovery of elongated holes in a suspension component.
- Bushing replacement.
- Excessive or abnormal tire wear.

## STEERING SYSTEM

### Power Steering

Oil (under low pressure) provides the power to operate the steering gear. It also serves to lubricate moving parts and remove heat. A loss of steering efficiency will occur if too much heat builds up in the system.



#### WARNING!

Do not operate the vehicle if the steering system is not working properly. You could lose control of your vehicle if the steering system is not in good working condition, which could result in a serious accident. For driving safety, visually check the steering gear and components. Frequent checks are important for driving safety, especially after traveling over rough roads. Failure to comply may result in death, personal injury, equipment or property damage.

If the steering feels unbalanced from side-to-side while turning, check for the following possible causes:

- unequal tire pressures
- vehicle overloaded or unevenly distributed load
- wheels out of alignment
- wheel bearings improperly adjusted.

If you cannot correct the problem, check with an authorized dealer.

Your vehicle is equipped with integral power steering. The system includes an engine-driven fluid pump, a fluid reservoir, the steering gear, and connecting hoses. Because of the hydraulic power assist, little effort is required to turn the steering wheel. When no input is applied through the steering wheel, the steering gear will return to the neutral position. If, for

any reason, the power assist system goes out, steering the vehicle is still possible, yet it will require much greater effort.

Visually check the following parts:

- Crosstube: Is it straight?
- Draglink tube clamp: Check for looseness or interference.
- Ball joints and steering U-joints: Check for looseness.
- Steering wheel for excessive free-play. Check the simplest probable causes first:
  - a. unequal tire pressures
  - b. loose cap nuts
  - c. bent crosstube
  - d. lack of lubrication.
- If these checks do not reveal the problem, or if you correct them and still have a steering problem,

# STEERING SYSTEM

take your truck to an authorized dealer for evaluation.

## Fluid Level and Refill

Have the power steering fluid and filters changed at an authorized dealer.

	<b>CAUTION</b>
When adding fluid, be sure to use fluid of the same type. While many fluids have the same description and intended purpose, they should not be mixed due to incompatible additives. Mixing incompatible fluids may lead to equipment damage.	

- Check and completely change the fluid level according to Preventive Maintenance Schedule on page 5-12. Use the following procedure:

	<b>NOTE</b>
Before removing reservoir cover, wipe outside of cover so that no dirt can fall into the reservoir.	

- Maximum/Minimum level is indicated on the reservoir. These same levels are also indicated by two lines on the dipstick in the reservoir.
- There are two ways to check whether the power steering fluid is at its proper level. Both checks are with the engine NOT running.
  1. If you check the fluid with the engine and steering system COLD, the fluid level should be at/or above the Minimum indicator level and should generally not exceed the middle point between Maximum and Minimum level indicators.
  2. If you check the fluid with the engine and steering system WARM, the fluid should NOT exceed the Maximum level indicator and should generally not drop below the middle point

between the Maximum and Minimum level indicators.

## Fluid Filter Replacement

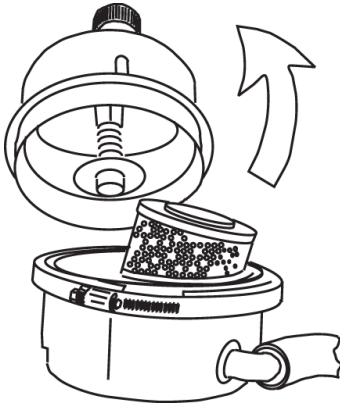

### CAUTION

Servicing the power steering system without bleeding it of trapped air may cause damage to the power steering pump.

1. Replace both fluid and filter.

2. Bleed the system if necessary.

## Steering Shaft

The following are common torque specifications for most steering shafts.

- Torque on U-joint pinch bolt and nut (7/16 in) 74–81 Nm (55 to 60 lb-ft), lubricated.
- Torque on Pitman arm clamp bolt and nut (3/4 in): 406–433 Nm (300 to 320 lb-ft), lubricated.
- For off-highway vehicles, tighten the U-bolts after the first day or two of operation. Then check weekly.

## STEERING SYSTEM

---



### WARNING!

If this chassis is equipped with an electronic stability system (ESP) and any part of the steering system (e.g. linkage, steering driveline, column, front-end alignment, etc) is repaired, removed, or disassembled in any way, or if the steering angle sensor is replaced, the steering angle sensor must be recalibrated. Any repairs or adjustments to any part of the steering system must be performed by an authorized dealer. Failure to comply may result in death, personal injury, equipment or property damage.

5



## DRIVELINE

### Driveshaft Maintenance

The slip joints and universal joints of the driveshaft should be lubricated periodically.

Use a good quality lithium-soap-base or equivalent extreme pressure (E.P.) grease: NLGI Grade 2.

Dana SPL U-joints and driveshafts should be inspected every time a vehicle comes in for scheduled maintenance (Refer to Spicer Driveshaft service manual DSSM-0100 (3264-SPL) for detailed instructions).

Use only Spicer Driveshaft approved lubricants when greasing Spicer SPL U-joints.

### U-Joints

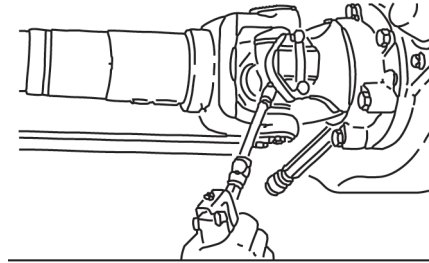

The slip joints and universal joints of the drive shaft should be lubricated according to Preventive Maintenance Schedule on page 5-12.

Use a good quality lithium-soap-base or equivalent extreme pressure (E.P.) grease: NLGI Grade 2.

Use only Spicer Driveshaft approved lubricants when greasing Spicer SPL U-joints.

For SPL170XL and SPL250XL, the U-joint lube interval changes after the initial lube at 350,000 miles. After the first lube interval, the U-joint needs lubrication every 150,000 miles. Inspection of the U-joints is the same regardless of when the U-joint grease interval occurs.



#### WARNING!

Improper lubrication of U-joints can cause them to fail prematurely. The driveshaft could separate from the vehicle and result in an accident. Make sure lubricant is purged at all four ends of each U-joint and loosen caps if necessary. Also, regularly inspect U-joints for excessive wear or movement, and repair or replace as necessary. Failure to comply may result in death, personal injury, equipment or property damage.

## TIRES AND WHEEL

---

### TIRES AND WHEEL

#### Tires



#### WARNING!

Do not repair damaged tires unless you are fully qualified and equipped to do so. Wheel and tire assemblies cannot be worked on without proper tools and equipment, such as: safety cages or restraining devices. Have all tire repairs performed by an expert. Stand away from the tire assembly while the expert is working. Failure to do this may result in death or injury.

right care will give you the assurance of safe and reliable tire operation. Here are some tips on maintaining your tires.

#### Checking Inflation Pressure

Give your tires a visual test every day, and check inflation **with a gauge** every week:

- When checking tire pressure, inspect each tire for damage to sidewalls, cuts, cracks, uneven wear, rocks between duals, etc. If a tire appears underinflated, check for damage to the wheel assembly. Don't forget to check between dual wheels. If you find wheel damage, have an expert tire service repair it.
- Maximum tire pressure will be indicated on the sidewall of a tire.
- Check pressure only when the tires are cool. Warm or hot tires cause pressure buildup and will give you an inaccurate reading. So never deflate a warm tire to the specified pressure.

5

Your tires are a very important part of your vehicle's whole braking system. How fast you can stop depends in large measure on how much friction you get between the road and your tires. In addition, keeping your tires in good condition is essential to the safe, efficient operation of your vehicle. Regular, frequent inspection and the

## Underinflated Tires

Low pressure is a tire's worst enemy. Underinflation allows tires to flex improperly, causing high temperatures to build up. Heat causes early tire damage such as flex break, radial cracks, and ply separation. Low pressure may affect control of your vehicle, especially at the front wheels. Most tire wear problems are caused by underinflation as the result of slow leaks, so you'll want to check tire pressure regularly. Lower tire pressure does not provide better traction on ice or snow.

 <b>WARNING!</b>
Do not operate a vehicle with underinflated tires. The extra heat caused by underinflation can cause sudden tire failure such as a tire fire or blow out, which can cause an accident resulting in death or personal injury. Low pressure may affect control at the front wheels, which could result in an accident involving death or personal injury. Keep your tires inflated to the manufacturer's recommended air pressure.

 <b>WARNING!</b>
Do not attempt to raise the vehicle to remove or install a damaged tire and wheel assembly if you are not fully qualified and not equipped with the proper tools and equipment. Do not attempt to re-inflate a tire that has been run flat. Obtain expert help. A person can be seriously injured or killed if using the wrong service methods. Truck tires and wheels should be serviced only by trained personnel using proper equipment. Follow OSHA regulations per section 1910.177.

 <b>NOTE</b>
Follow all warnings and cautions contained within the tire and wheel manufacturer's literature.

# TIRES AND WHEEL

1



TREAD CONTACT WITH ROAD

**Proper-Inflation:** the correct profile for full contact with the road.

2



TREAD CONTACT WITH ROAD

**Under-Inflation:** causes abnormal tire deflection, which builds up excessive heat, running the risk of failure. It also causes irregular wear.

3



TREAD CONTACT WITH ROAD

**Over-Inflation:** reduces the tread contact area with the road surface, concentrating all of the vehicle weight on the center of the tread. This causes premature wear of the tire.

## Overloaded Tires

Overloading your truck is as damaging to your tires as underinflation. The following chart shows how neglect or deliberate abuse can affect the life of your tires.

5

EFFECT OF LOAD PRESSURE ON TIRE LIFE						
Vehicle Load	Normal	20% Over	40% Over	60% Over	80% Over	100% Over
Tire Pressure	Normal	20% Low	30% Low	35% Low	45% Low	55% Low
Expected Total Tire Mileage	Normal	70%	50%	40%	30%	25%

## Overinflated Tires

Too much air pressure reduces the tire tread contact area and results in rapid wear in the center of the tread.



### WARNING!

Overinflated tires can cause accidents. They wear more quickly than properly inflated tires and are more subject to punctures, cracks, and other damage. They could fail and cause you to lose control of your vehicle resulting in an accident causing death or personal injury. Be sure all tires are inflated correctly according to the manufacturer's recommendations.

### Matching Tires

Be sure to buy matched tires for your vehicle, especially on the rear axles. Mismatched tires can cause stress between axles and cause the temperature of your axle lubricant to get too hot. Matched tires will help your driveline last longer and will give you better tire mileage.



### WARNING!

Do not mismatch tires, it can be dangerous. Never mix tires of different design such as steel belted radials and bias ply tires, etc. Mixing tire types and sizes will adversely affect the road-holding ability of both types of tires and can lead to loss of vehicle control and causing death or personal injury.



### WARNING!

Do not install regrooved or reinforcement-repaired tires on steering axles. They could fail unexpectedly and cause you to lose control of your vehicle resulting in an accident causing death or personal injury.

# TIRES AND WHEEL

## Replacing Tires

**Front:** Replace front tires when less than 4/32 in. of tread remains. Check at three places equally spaced around the tire.

**Drive Axles or Trailers:** Replace tires on drive axles or trailers when less than 2/32 in. of tread depth remains in any major groove. Check at three places equally spaced around the tire. See the next illustration for recommended measuring points for tread depth.

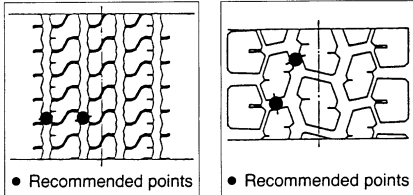

Steer Tire Points (left), Drive Tire Points (right)

	<b>WARNING!</b>
Do not replace original equipment tires with load ratings less than the original tires. Doing so could lead to unintentional overloading of the tire, which could cause a failure resulting in loss of vehicle control and an accident. Failure to comply may result in death, personal injury, equipment or property damage.	

	<b>NOTE</b>
To prolong your tires' life and make them safer, have their radial and lateral run-out checked at your dealer. And of course, you should have your tires balanced anytime you change a tire.	

## Greenhouse Gas Certified Tires

**Replacing a tire that is greenhouse gas certified.**

	<b>NOTE</b>
The tires installed on this vehicle at the factory as original equipment may be certified for Greenhouse Gas and Fuel Efficiency regulations. Replacement tires must be of equal or lower rolling resistance level (TRRL or $C_{rr}$ ). Consult with your tire supplier(s) for appropriate replacement tires.	

Verify if your vehicle is equipped with Greenhouse Gas certified tires by checking the Vehicle Emission Control label on the driver's side door frame. If these tires were installed at the factory, Lower Rolling Resistance codes (LRR) identify which tires are certified.

## Maintaining a greenhouse gas certified tire.

In order to limit the rolling resistance of the tires and optimize fuel economy, the maintenance procedures specified by the tire manufacture must be followed.

For warranty information, See Greenhouse Gas Tires on page 6-9.

## Tire Chains

If you need tire chains, install them on both sides of each driving axle.



### CAUTION

Chains on the tires of only one tandem axle can damage the driveline U-joints and the interaxle differential. Your repairs could be costly and time-consuming.

## Speed Restricted Tires



### WARNING!

This vehicle may be equipped with speed restricted tires. Check each tire's sidewall for maximum rated speed. The vehicle should not be operated at sustained speed in excess of maximum rated speed. Failure to comply with these speed restrictions could cause sudden tire failure which can result in death, personal injury or property damage.

## TIRES AND WHEEL

### Wheel Mounting and Fastening

After the vehicle travels about 50 to 100 miles (80 to 160 km), wheel mountings seat in and will lose some initial torque. Check hub/wheel mountings after this initial period and retighten.

 <b>WARNING!</b>
Never use oil or grease on studs or nuts; improper torque readings will result, which could cause improper wheel clamping and could lead to a wheel failure resulting in an accident. Failure to comply may result in death, personal injury, equipment or property damage.

### Wheel Cap Nut Torque

At the first scheduled lube interval, have all wheel cap nuts torqued to their specified value listed in Wheel Cap Nut Torque on page 5-142. After that, check wheel cap nuts at least once a week. Contact an authorized dealer for information on the proper installation procedure for the wheels on your truck. This is a job you may not be able to do yourself. You need the right torquing equipment to do it.

### Wheel Cap Nut Torque

WHEEL and NUT CONFIGURATION	STUD SIZE	TORQUE FOR INNER and OUTER CAP NUTS and RIM CLAMP NUTS	
		Nm	Lb-Ft
Steel or Aluminum Disc-Type Wheel; Double Cap Nut Mounting; Standard 7/8 Radius Ball Seat	3/4-16	610-680	450-500
	1-1/8-16	610-680	450-500
Heavy-Duty Steel Disc-Type Wheel; Double Cap Nut Mounting; 1-3/16 Radius Ball Seat:	15/16-12	1,020-1,220	750-900
	1-1/8-16	1,020-1,220	750-900
	1-15/16-12	1,020-1,220	750-900
Hub-Piloted Disc-Type Wheel w/Two Piece Flanged Cap Nuts: Steel or Aluminum Wheel PHP-10; Budd Uni-Mount-10; WDH-8	M22-1.5	610-680	450-500



WHEEL and NUT CONFIGURATION	STUD SIZE	TORQUE FOR INNER and OUTER CAP NUTS and RIM CLAMP NUTS	
		Nm	Lb-Ft
Stud Backnuts (when used)	3/4-16	240-270	175-200
	1-14	240-410	175-300
Cast Spoke Wheel Assembly	1/2" Dia. 5/8" Dia. 3/4" Dia.	Rim Clamp Nut Torque	
		110-120	80-90
		220-250	160-185
		305-335	225-245

Threads should be clean and dry. Do not lubricate wheel nuts or studs.

### Proper Torque and Sequence

Proper wheel torque can best be obtained on level ground. Install lug nuts and finger-tighten in the numerical sequence as shown below, see Nut Tightening Sequence for Hub Piloted Disc Wheels on page 5-143 or Nut Tightening Sequence for Stud Piloted Disc Wheels on page 5-144. This procedure will ensure that the wheel is drawn evenly against the hub. Torque each nut to the torque value listed in Wheel Cap Nut Torque on page 5-142.

**⚠ WARNING!**

Tighten wheel cap nuts properly. If they are not tightened properly, wheel nuts could eventually cause the wheel to become loose, to fail, and/or to come off while the vehicle is moving, possibly causing loss of control and may result in death, personal injury, equipment or property damage.

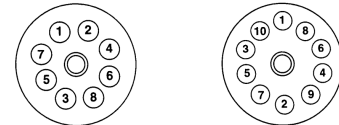

Nut Tightening Sequence for Hub Piloted Disc Wheels

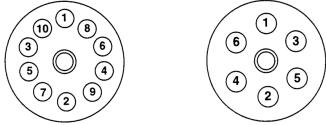

Nut Tightening Sequence for Stud Piloted Disc Wheels

### Wheel Replacement with Disc Brake Option



#### WARNING!

Use only the wheel brand, size and part number originally installed. Use of a different wheel brand or size could cause valve stem to interfere with a brake component which could lead to loss of vehicle control. Failure to comply may result in death, personal injury, equipment or property damage.

Vehicles equipped with front disc brakes are fitted with wheels designed specifically for disc brake applications. If it ever becomes necessary to replace an original equipment wheel, the replacement wheel must be the same brand and size as the take-off wheel. On vehicles equipped with 22.5 in. disc wheels, installing the wrong replacement wheel could result in the wheel valve stem making contact with the disc brake assembly. When

installing any replacement wheel, always inspect the tires/wheels to ensure there is adequate clearance between other vehicle components.

With the hood open, check for clearance between the wheel and disc brake assembly. Use a hydraulic jack to raise the front of the vehicle off the ground to allow the wheel to spin freely. While rotating the wheel, check to ensure there is adequate clearance between the wheel and disc brake assembly.



## WARNING!

If the hood falls, anyone under it could be injured. Always make sure that the hood hold open device engages when the hood is in its open position any time anyone gets under the hood for any reason.

- The hood could hurt someone that is in the way of its descent. Before lowering the hood, be sure no objects or people are in the way.



## WARNING!

Always support the vehicle with appropriate safety stands if it is necessary to work underneath the vehicle. A jack is not adequate for this purpose.



## WARNING!

Improperly mounting and demounting tire and rim assemblies is dangerous. Failure to observe proper precautions could cause the tire-rim assembly to burst explosively, causing death or personal injury. See the wheel manufacturer's literature for the proper way to mount and demount your tires and rims. Follow their precautions exactly.

## Disc Wheels



## WARNING!

Use the correct components and tools when working on wheels. Grooves in the wheel disc or other damage to the disc can weaken the wheel and cause it to eventually come off. This could cause you to lose control of your vehicle, and may result in an accident. Failure to comply may result in death, personal injury, equipment or property damage.

The end of the wheel wrench must be smooth. Burrs on the end of the wrench can tear grooves in the disc. These grooves may lead to cracks in the disc, and can cause it to fail.

## **WHEEL BEARING**

---

## **WHEEL BEARING**

### **Wheel Bearing Adjustment**

For safe, reliable operation and adequate service life, your wheel bearings must be adjusted properly at the recommended intervals. Contact your authorized dealer to make sure the wheel bearings are properly adjusted.

# TRANSMISSION MAINTENANCE

## Introduction

Proper maintenance of the transmission will ensure that the vehicle will operate efficiently.

To check the transmission fluid level, park the vehicle on level ground. For an automatic transmission the oil level should be checked with the engine idling and the transmission fluid at operating temperature. Checking the fluid of a manual transmission may be done with the engine off.

The recommended fluid replacement intervals contain an initial change and a separate interval for the changes after the initial drain. When the oil needs to be replaced, be sure to refer to the manufacturer’s literature on the correct grade and type of oil to purchase.

For more details, please refer to the maintenance section in the transmission manufacturer’s manual or service literature.

	<b>CAUTION</b>
When adding oil, types and brands of oil should not be intermixed because of possible incompatibility, which could decrease the effectiveness of the lubrication or cause component failure.	

**Initial Change:** drain and replace according to Preventive Maintenance Schedule on page 5-12; for some transmissions this may not be required.

## Oil Change

Change fluid according to change procedures specified in the Transmission Service Manual. Use the recommended types of oil as specified in the Operation and Service Manual (included with vehicle). Select from the appropriate lubricant for varying ambient (outside air) temperatures.

# TRANSMISSION MAINTENANCE

---

## Transmission Lubricants

### Manual Transmission

Manual transmissions are designed so that the internal parts operate in a bath of oil circulated by the motion of gears and shafts.

### Service Intervals

For recommended types and brands of all lubricants, see the transmission manufacturer's Service Manual and Preventive Maintenance Schedule on page 5-12.

Check all hoses for kinks, deterioration, chafing, and leaks. Adjust kinked or chafing hoses to eliminate restrictions and prevent further wear. To ensure proper inspection, it may be necessary to inspect under and inside frame rails and unclip harnesses, hoses and cable bundles.

### Standard Transmission Oil Level

i	NOTE
The vehicle must be parked on level ground.	

See the Transmission Operator's Manual for information on checking the transmission oil level.

**Automatic Transmissions  
Service Intervals**

Check daily with engine idling. See Preventive Maintenance Schedule on page 5-12 for service intervals.

**Automatic Transmission Oil Level**

i	NOTE
The vehicle must be parked on level ground.	

See the Transmission Operator's Manual for information on checking the transmission oil level.

# CLUTCH

## CLUTCH

### Introduction

The clutch pedal transmits force from the operator to the clutch via hydraulic and air assist action. The clutch pedal position is factory set and does not require adjustment.

### Clutch Hydraulic Fluid

Visually inspect the clutch fluid from the reservoir. There are molded lines with the letters MIN to indicate minimum fluid level and MAX to indicate the maximum fluid level recommended for proper operation. Be sure to maintain the fluid between the MIN and MAX levels indicated on the plastic reservoir. If the fluid level repeatedly goes below the MIN line, then it is time to have your clutch adjusted or the hydraulic system inspected for service.

To replace the fluid, locate the drain fitting on the air solenoid mounted to the transmission housing. Open this fitting and allow fluid to drain out of the system. Once all the fluid is drained out, close the fitting and fill the system through the master cylinder reservoir in the engine compartment. Once the system is full, then purge the system of air by simultaneously pressing on the pedal and opening the fitting to allow

air to escape. Close the fitting when fluid starts coming out. Then refill the reservoir. Repeat this until all air has been purged from the system.

Replace with the recommended fluid Component Lubrication Index on page 5-39.

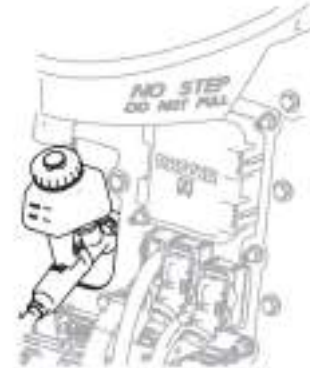



## **Clutch Adjustment**

Some clutches are self-adjusting, however; there are manually adjusted clutches that will require the operator to know when to adjust the clutch. The clutch will need adjustment when your clutch pedal stroke seems to get longer and its effectiveness at a seamless shift becomes less.

Another sign of the clutch needing adjustment is the level of the fluid in the reservoir. If the hydraulic fluid is not leaking, but the fluid level is getting lower, then the clutch may need to be adjusted. Please take the vehicle to an authorized dealership to have the clutch adjusted.

## **Clutch Adjustment – Normal Wear**

See the clutch manufacturer's Service Manual for the proper adjustment procedures.



**CONSUMER INFORMATION AND VEHICLE IDENTIFICATION**

Vehicle Identification . . . . . 6-3  
General VIN Information . . . . . 6-4  
Component Identification. . . . . 6-7

**CONSUMER INFORMATION**

Federal Safety Standard Certification Label . . . . . 6-8  
How to Order Parts . . . . . 6-8  
NHTSA Consumer Information . . . . . 6-8  
Canadian Consumer Information . . . . . 6-9  
Warranty. . . . . 6-9



## CONSUMER INFORMATION AND VEHICLE IDENTIFICATION

### Vehicle Identification

The 17-digit Vehicle Identification Number (VIN) is used to register your vehicle for warranty, license and insurance.

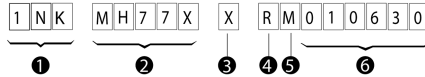

- 1 Manufacturer Identifier
- 2 Vehicle Attributes
- 3 Reserved Space
- 4 Model Year
- 5 Assembly Plant
- 6 Serial Number (Chassis Number)

### Model Year Designations

CODE	YEAR
9	2009
A	2010
B	2011
C	2012
D	2013
E	2014
F	2015
G	2016
H	2017
I	2018

### Assembly Plant Code

F = KENMEX

M = Ste. Therese

R = Renton

J = Chillicothe

# CONSUMER INFORMATION AND VEHICLE IDENTIFICATION

---

## General VIN Information

### VIN Locations

The full, 17-digit VIN is located on the Weight Rating Data Label. The label is located on the driver's side door edge or on the driver's side door frame.

## Chassis Number

The Chassis Number refers to the last six characters of the VIN. This number will allow your dealer to identify your vehicle. You will be asked for this number when you bring it in for service.

### Chassis Number Locations

- Right frame rail, top flange, about 3 ft. from the front end
- Cab back, left-hand rear panel, lower edge
- Tire, Rim, and Weight Rating Data label (truck)
- Components and Weights label
- Noise Emission label
- Paint Identification label

## Certification Labels

Your vehicle information and specifications are documented on labels. As noted below, each label contains specific information pertaining to vehicle capacities and specifications that you should be aware of.

# CONSUMER INFORMATION AND VEHICLE IDENTIFICATION

## Components and Weights Label

The Components and Chassis Weight Label is located on either the driver's side door edge or on the driver's side door frame. It includes chassis number, chassis weight and gross weight, plus model information for the vehicle, engine, transmission, and axles.

## Tire and Rim Data Label

The Tire, Rim and Weight Rating Data Label is located on the driver's side door edge or on the driver's side door frame. It contains the following information:

- GVWR - Gross Vehicle Weight Rating
- GAWR FRONT, INTERMEDIATE and REAR - Gross Axle Weight Ratings for Front, Intermediate and Rear Axle
- TIRE/RIM SIZES AND INFLATION PRESSURES - Tire/Rim Sizes and Cold Pressure Minimums
- VIN including CHASSIS NUMBER

 <b>WARNING!</b>	
Do not exceed the specified load rating. Overloading can result in loss of vehicle control and personal injury, either by causing component failures or by affecting vehicle handling. Exceeding load ratings can also shorten the service life of the vehicle.	

The components of your vehicle are designed to provide satisfactory service, if the vehicle is not loaded in excess of either the gross vehicle weight rating (GVWR), or the maximum front and rear gross axle weight ratings (GAWRs).

 <b>NOTE</b>	
GVW is the TOTAL SCALE WEIGHT the vehicle is designed to carry. This includes the weight of the empty vehicle, loading platform, occupants, fuel, and any load.	

## CONSUMER INFORMATION AND VEHICLE IDENTIFICATION

---

### Noise Emission Label

The Noise Emission Label is located in the driver's side door frame. It contains information regarding U.S. noise emission regulations, chassis number, and date of manufacture.

### Paint Identification Label

The Paint Identification Label contains the paint colors used by the factory to paint your vehicle. It lists frame, wheels, cab interior and exterior colors. This label is located inside the glove box.

### Federal Safety Standard Certification Label

The NHTSA regulations require a label certifying compliance with Federal Safety Standards, for United States and U.S. Territories, be affixed to each motor vehicle and prescribe where such label may be located. This certification label, which indicates the date of manufacture and other pertinent information, is located on the driver's side door edge or on the driver's side door frame.



### Component Identification

Each of the major components on your vehicle has an identification label or tag. For easy reference, record component numbers such as, model, serial, and assembly number.

**Engine:** For further information, please refer to the Engine Operation and Maintenance Manual.

**Transmission:** For both manual and automatic transmissions, the identification number is stamped on a tag affixed to the right rear side of the transmission case.

**Clutch:** Enclosed in clutch housing. Location depends on manufacturer.

**Steer Axle:** The front axle serial number is stamped on a plate located on the center of the axle beam.

**Drive Axles:** The drive axle numbering system includes three labels or stamps:

1. Axle Specification Number, usually stamped on the right rear side of the axle housing. This number identifies the complete axle.
2. Axle Housing Number Tag, usually located on the left forward side of the housing arm. This tag identifies the axle housing.
3. Axle Differential Carrier Identification, usually located on the top side of the differential carrier. The following information is either stamped, or marked with a metal tag: Model No., Production Assembly No., Serial No., Gear Ratio, and Part Number.

### CONSUMER INFORMATION

#### Federal Safety Standard Certification Label

The National Highway Traffic Safety Administration regulations require a label certifying compliance with Federal Safety Standards, for United States and U.S. Territories, be affixed to each motor vehicle and prescribe where such label may be located. This certification label, which indicates the date of manufacture and other pertinent information, is located on the left hand cab door post.

#### How to Order Parts

Replacement parts may be obtained from an authorized dealership.

When you order, it is IMPORTANT that you have the following information ready:



- Your name and address.
- Serial number of the truck.
- The name of the part you need.
- The name and number of the component for which the part is required.
- The quantity of parts you need.
- How you want your order shipped.

#### NHTSA Consumer Information

If you believe that your vehicle has a defect, which could cause a crash or could cause death or personal injury, you should immediately inform the National Highway Traffic Safety Administration (NHTSA) in addition to notifying the vehicle manufacturer.

If NHTSA receives similar complaints, it may open an investigation, and if it finds that a safety defect exists in a group of vehicles, it may order a recall and remedy campaign. However, NHTSA cannot get involved in individual problems between you, your dealer, and vehicle manufacturer.

Contacting NHTSA is possible through telephone, written mail and email. NHTSA also has a website where you can input your comments directly to them on the web. Please use any of the four ways to contact NHTSA:

	Toll Free 888-327-4236 (800-4249153 TTY) 8:00 am to 10:00 pm ET Monday-Friday
	Office of Defects Investigations/CRD NVS-216 1200 New Jersey Ave SE. Washington, D.C. 20590
<b>www</b>	<a href="http://www.safercar.gov">www.safercar.gov</a>
<b>@</b>	<a href="mailto:nhtsa.webmaster@dot.gov">nhtsa.webmaster@dot.gov</a>

**Canadian Consumer Information**

Canadian customers who wish to report a safety-related defect to Transport Canada, Defect Investigations and Recalls, may telephone the toll free hotline 1-800-333-0510, or contact Transport Canada by mail at:

Transport Canada, ASFAD  
Place de Ville Tower C  
330 Sparks Street  
Ottawa ON K1A 0N5

For additional road safety information, please visit the Road Safety website at:

<http://www.tc.gc.ca>

**Warranty  
Greenhouse Gas Tires**

The following warranty is for vehicles equipped with Greenhouse Gas certified tires:

**VEHICLE EMISSIONS LIMITED EXPRESS WARRANTY RELATED TO ORIGINAL EQUIPMENT TIRES**

PACCAR Inc warrants the tires installed as original equipment on this vehicle only against defects in materials and workmanship which cause the vehicle to fail to comply with applicable U.S. and Canadian greenhouse gas emission limits (“Warrantable Emissions Failures”). This vehicle emissions limited express warranty relating to original equipment tires is valid for two (2) years or 24,000 miles, whichever occurs first.

## CONSUMER INFORMATION

---

YOUR SOLE AND EXCLUSIVE REMEDY AGAINST PACCAR Inc IS LIMITED TO THE REPAIR OR REPLACEMENT OF ORIGINAL EQUIPMENT TIRES AT AUTHORIZED UNITED STATES AND CANADIAN PACCAR DEALERS, SUBJECT TO PACCAR'S TIME AND MILEAGE LIMITATIONS LISTED ABOVE. This Vehicle Emissions Limited Express Warranty relating to original equipment tires begins on the date of delivery of the vehicle to the first purchaser or lessee and accrued time and mileage is calculated when the vehicle is brought into an authorized dealer for correction of the Warrantable Emissions Failures relating to the original equipment tires.

6

PACCAR MAKES NO OTHER VEHICLE EMISSIONS WARRANTIES RELATING TO THE ORIGINAL EQUIPMENT TIRES, EXPRESS OR IMPLIED. WHERE PERMITTED

BY LAW, PACCAR EXPRESSLY DISCLAIMS ANY WARRANTY OF MERCHANTABILITY OR FITNESS FOR A PARTICULAR PURPOSE RELATING TO VEHICLE EMISSIONS. IT IS AGREED THAT PACCAR SHALL NOT BE LIABLE FOR INCIDENTAL OR CONSEQUENTIAL DAMAGES INCLUDING, BUT NOT LIMITED TO: LOSS OF INCOME OR LOST PROFITS; VEHICLE DOWNTIME; COMMUNICATION EXPENSES; LODGING AND/OR MEAL EXPENSES; FINES; APPLICABLE TAXES OR BUSINESS COSTS OR LOSSES; ATTORNEY'S FEES; AND ANY LIABILITY YOU MAY HAVE IN RESPECT TO ANY OTHER PERSON OR ENTITY RELATING TO WARRANTABLE EMISSIONS FAILURES.

**This Vehicle Emissions Limited Express Warranty relating to original equipment tires is limited to emissions compliance only.**

The tires are separately warranted by their manufacturer for defects in materials and workmanship other than those which cause non-compliance with U.S. and Canadian GHG regulations, subject to limitations and conditions contained within the tire manufacturer's warranty agreement. You are responsible for the safe operation and maintenance of the vehicle and its tires. PACCAR does not warrant wear and tear of the tires.

# Index

5th wheel  
 maintenance ..... 5-105

## A

About the Manual ..... 1-3  
 ABS off-road switch ..... 3-60  
 Accessories  
   cigarette lighter ..... 3-94  
   radio ..... 3-94  
   sleeper alarm clock ..... 3-91  
 Accessory drive belts ..... 5-97  
 Active warnings ..... 3-17  
 Adaptive cruise control ..... 4-37  
 Adding electrical options ..... 5-84  
 Additional sources of information... 1-8  
   California proposition 65 warning 1-6  
   data recorder ..... 1-6  
   installed equipment - operator's  
     manuals ..... 1-8  
   other sources ..... 1-9  
 Adjustable auxiliary axles ..... 4-43

liftable/non-steerable pusher  
   calibration ..... 4-46  
 liftable/steerable calibration .... 4-46  
 tag axle calibration ..... 4-46  
 After-treatment system  
   introduction ..... 4-51  
 Air cleaners ..... 5-100  
 Air compressor ..... 5-56  
 Air conditioner button ..... 3-86  
 Air dehumidification ..... 3-88  
 Air disc brakes  
   maintenance ..... 5-59  
 Air distribution dial ..... 3-85  
 Air dryer ..... 5-52  
 Air dryer (Bendix® AD-IS series) . 5-53  
 Air dryer overhaul ..... 5-53  
 Air filter restriction gauge ..... 3-44  
 Air gauges  
   air pressure - air suspension air  
     bags #1 & #2 ..... 3-47  
   tag axle air pressure ..... 3-43

tractor air brake pressure ..... 3-47  
 tractor air brake pressure -  
   primary/secondary ..... 3-12  
 trailer air brake pressure ..... 3-48  
 trailer air tank pressure ..... 3-48  
 Air intake system ..... 5-99  
 Air suspension height/air pressure 4-49  
 Air system  
   air cleaners ..... 5-100  
   air compressor ..... 5-56  
   air dryer ..... 5-52  
   air filter restriction gauge ..... 3-44  
   air gauges and air leaks ..... 5-55  
   air intake system ..... 5-99  
   draining air tanks ..... 5-54  
   primary air pressure gauge ..... 5-55  
   secondary air pressure gauge . 5-55  
   turbocharger ..... 5-99  
 Air system maintenance ..... 5-49  
 Air tanks ..... 5-54  
 Alarms

# Index

---

- engine overspeed air shutdown
  - alarm ..... 3-40
- headlight on alarm ..... 3-41
- low coolant level alarm..... 3-40
- stop engine alarm ..... 3-40
- Alert screens
  - fault alert ..... 4-39
  - impact alert ..... 4-38
  - level 1 following distance alert . 4-38
  - level 2 following distance alert . 4-38
  - level 3 following distance alert . 4-38
  - stationary object alert ..... 4-38
- Allison transmission lubrication... 5-43
- Anti-lock brake system warning
  - light ..... 3-37
- Anti-lock brakes
  - trailer ABS ..... 4-24
  - trailer ABS (without PLC)..... 4-25
  - wheel spin control ..... 4-30
- Anti-lock brakes (ABS)
  - electronic stability program (ESP)..... 4-26
  - roll stability program (RSP)..... 4-26
- Appliances..... 3-95
- Assembly plant code ..... 6-3
- Audible alarm..... 3-8
- Automated transmission and shift
  - indicator area ..... 3-18
- Automatic and automated transmissions ..... 4-19
- Automatic Slack Adjusters ..... 5-61
- Automatic transmissions
  - oil level ..... 5-149
  - service intervals ..... 5-149
- Auxiliary axles ..... 4-43
- Auxiliary lights switch ..... 3-63
- Auxiliary transmission ..... 4-20
- Auxiliary transmission oil temperature gauge ..... 3-49
- Auxiliary transmission warning
  - light ..... 3-42
- Axle creep rating ..... 4-45
- Axle lubrication..... 5-108
- B**
- Back up alarm mute switch ..... 3-60
- Batteries
  - battery access ..... 5-85
  - battery care ..... 5-89
  - battery charging ..... 5-89
  - jump starting vehicles ..... 2-8
  - removing and installing
    - batteries..... 5-87
- Battery access ..... 5-85
- Battery care ..... 5-89
- Battery charging ..... 5-89
- Beacon lights switch ..... 3-63
- Belt damage and repair ..... 1-28
- Bendix® AD-IS series air dryer ... 5-53
- Brake adjustment ..... 5-58
- Brake gauges
  - tractor air brake pressure..... 3-47
  - tractor primary/secondary air brake pressure..... 3-12
  - trailer air brake pressure..... 3-48
  - trailer air tank pressure ..... 3-48
- Brake Level Switch ..... 3-61
- Brake system
  - adjustment ..... 5-58
  - retarders ..... 4-33
  - roll stability program (RSP)..... 4-26
  - spring brakes ..... 2-20
  - yaw control..... 4-27
- Bulb replacement
  - headlight ..... 5-78
- Bulb specifications ..... 5-79

- C**
- Cab air distribution ..... 3-89
  - Cab and frame access ..... 1-10
  - Cab dimmer switch ..... 3-60
  - Cab recirculation air filter ..... 5-113
  - Cab storage ..... 3-95
    - glove box ..... 3-95
  - Cabin fresh air filter ..... 5-113
  - California Proposition 65 Warning .. 1-6
  - Canadian consumer information... 6-9
  - Certification labels ..... 6-4
    - components and weights label... 6-5
    - federal safety standard certification label ..... 6-6
    - noise emission label ..... 6-6
    - paint identification label ..... 6-6
    - tire and rim data label ..... 6-5
  - Chassis number ..... 6-4
  - Chassis number locations ..... 6-4
  - Check engine warning light ..... 3-40
  - Check messages ..... 3-9
  - Check transmission warning light 3-42
  - Checking tire inflation pressure.. 5-136
  - Chrome and aluminum surfaces.. 5-63
  - Cigarette lighter ..... 3-94
  - Cleaning vinyl and upholstery .... 5-67
  - Cleaning, protecting and weather stripping ..... 5-64
  - Climbing onto the deck plate..... 1-13
  - Clock ..... 3-17
    - to set alarm time ..... 3-28
    - to set clock display ..... 3-28
    - to set home/local time ..... 3-28
    - to turn alarm ON/OFF ..... 3-28
  - Clutch
    - clutch brake ..... 4-16
    - clutch linkage adjustment..... 5-151
    - clutch travel ..... 4-16
    - double clutching ..... 4-18
    - identification ..... 6-7
    - riding the clutch ..... 4-20
  - Clutch adjustment..... 5-151
  - Clutch brake ..... 4-17
  - Clutch hydraulic fluid ..... 5-150
  - Clutch maintenance ..... 5-150
  - Clutch travel ..... 4-17
  - Coasting ..... 4-52
  - Component identification reference 6-7
  - Components and weights label..... 6-5
  - Consumer information
    - Federal safety standards ..... 6-8
    - how to order parts ..... 6-8
  - Controls ..... 3-94
  - Coolant Level ..... 5-74
  - Cooling system
    - adding coolant ..... 5-73
    - fan ..... 5-98
    - fan clutch ..... 5-98
    - maintenance ..... 5-72
  - Cooling system maintenance .... 5-72
  - Cruise control indicator ..... 3-18
  - Cruise control on/off switch ..... 3-61
  - Cruise control set/resume switch . 3-61
- D**
- Daily checks ..... 1-37
  - Dash switches ..... 3-50
  - Data recorder ..... 1-6
  - Daytime running light (DRL) ..... 3-63
  - Deck plate access ..... 1-13
  - Deep snow and mud switch..... 4-31
  - DEF filter ..... 5-121
  - Defrost vents ..... 3-85
  - Defrosting and defogging the windshield ..... 3-86
  - Descending a grade ..... 4-53
  - Diesel exhaust fluid gauge ..... 3-14

## Index

---

- Diesel Exhaust Fluid Tank ..... 5-121
  - Diesel particulate filter (DPF)
    - regeneration switch..... 3-62
  - Diesel particulate filter (DPF) warning light ..... 3-38
  - Differential lock..... 4-40
  - Dim Control Operation..... 3-93
  - Disc wheels..... 5-145
  - Displays/menu screens
    - clock display ..... 3-28
    - driver performance center ..... 3-19
    - fuel economy ..... 3-24
    - ignition timer ..... 3-24
    - settings ..... 3-27
    - tire pressure monitoring system (TPMS)..... 3-23
    - to set time..... 3-28
    - trip information..... 3-24
    - truck information..... 3-25
    - virtual gauges..... 3-23
    - warning and faults..... 3-26
  - Dome lights switch..... 3-64
  - Door lock ..... 1-11
    - key fob synchronization..... 1-13
    - remote keyless entry (RKE) system ..... 1-12
  - Door mounted controls ..... 3-75
  - Double clutching ..... 4-18
  - Drive axle temperature gauge .... 3-46
  - Drive axles
    - identification ..... 6-7
  - Driver controlled main differential 2-16
  - Driver information display
    - tire pressure monitoring system (TPMS)..... 3-23
  - Driver performance center .. 3-12, 3-14
    - fuel economy ..... 3-24
    - ignition timer ..... 3-24
    - menu screens..... 3-19
    - settings ..... 3-27
    - trip information..... 3-24
    - truck information..... 3-25
    - virtual gauges..... 3-23
    - warning and faults..... 3-26
  - Driver's
    - daily checks..... 1-37
    - weekly checks ..... 1-40
  - Driver's check list ..... 1-36
  - Driveshaft Maintenance ..... 5-135
  - Driving tips
    - coasting ..... 4-52
    - descending a grade ..... 4-53
    - engine RPM..... 4-53
    - fuel economy ..... 4-55
    - optimal engine speed ..... 4-54
    - using the driver information display..... 4-55
    - using the driver performance center ..... 3-14
    - using the tachometer..... 4-54
  - Driving with deflated air springs .. 4-50
  - Drum brakes
    - maintenance ..... 5-61
  - Dual Axle Diff-Lock Switch..... 3-60
  - Dual range (two-speed) rear axle 4-41
  - Dump truck gate switch ..... 3-60
  - Dump truck, body up warning light 3-38
  - Dump truck, gate warning light ... 3-38
  - Dump truck, trailer body up warning light ..... 3-38
- ## E
- Eaton/Dana axle lubrication..... 5-46
  - Electrical and alternator
    - precautions..... 5-91
  - Electrical system
    - adding electrical options..... 5-84



- batteries ..... 5-85
  - battery care ..... 5-89
  - battery charging ..... 5-89
  - electrical and alternator
    - precautions ..... 5-91
  - fuses, circuit breakers and
    - relays ..... 5-80
  - jump starting vehicles ..... 2-8
  - removing and installing
    - batteries ..... 5-87
  - Electrical system maintenance ... 5-77
  - Electronic stability program (ESP) 4-26
  - Emergency
    - battery connections ..... 2-10
    - emergency equipment kit ..... 1-36
    - jump starting vehicles ..... 2-8
  - Emergency equipment ..... 1-36
  - Emergency welding ..... 5-104
  - Engine
    - air cleaners ..... 5-100
    - air intake system ..... 5-99
    - drive belts ..... 5-97
    - engine mounting ..... 5-101
    - exhaust system ..... 5-101
    - identification ..... 6-7
    - lubrication ..... 5-94
    - pipe and hose clamp torque
      - values ..... 5-37, 5-95
    - Engine (block) heater ..... 5-75
    - Engine block heater ..... 4-6
    - Engine brake on/off switch ..... 3-61
    - Engine control display ..... 4-14
    - Engine cool down ..... 4-60
    - Engine fan ..... 5-98
    - Engine fan control ..... 4-12
    - Engine fan override switch ..... 3-61
    - Engine fan warning light ..... 3-40
    - Engine heater switch ..... 3-62
    - Engine heater warning light ..... 3-40
    - Engine is overheating ..... 2-5
    - Engine lubrication ..... 5-94
    - Engine maintenance ..... 5-93
    - Engine mounted noise insulators 5-119
    - Engine Mounting ..... 5-101
    - Engine oil pressure gauge ..... 3-45
    - Engine oil pressure lamp turns on.. 2-4
    - Engine oil temperature gauge ... 3-45
    - Engine operation
      - engine block heater ..... 4-6
      - engine control display ..... 4-14
      - engine cool down ..... 4-60
      - engine fan control ..... 4-12
    - winterfronts ..... 4-13
  - Engine overspeed ..... 4-53
  - Engine overspeed air shutdown
    - (manual) ..... 3-62
  - Engine overspeed air shutdown
    - (test) ..... 3-62
  - Engine overspeed air shutdown
    - alarm ..... 3-40
  - Engine retarder warning light .... 3-40
  - Engine warm-up ..... 4-7
  - Environmental Protection ..... 1-7
  - Ether metering equipment ..... 4-10
  - Ether start switch ..... 3-61
  - Ether start warning light ..... 3-40
  - Exhaust system ..... 5-101
  - Extended life coolant (ELC)
    - What to Check in an ELC-filled
      - Cooling System ..... 5-72
  - Exterior lights self test ..... 3-64, 3-77
  - Exterior maintenance ..... 5-63
  - Exterior washing ..... 5-66
- ## F
- Fan control dial ..... 3-85
  - Fasten seat belt warning indicator 3-41

# Index

- Federal safety standard certification
    - label..... 6-6, 6-8
  - Fifth wheel
    - maintenance..... 5-105
  - Fifth wheel slide switch..... 3-62
  - Final stopping procedures..... 4-62
  - Flood lights switch..... 3-64
  - Floor and defrost vents..... 3-85
  - Floor vents..... 3-85
  - Fog lights switch..... 3-64
  - Forward PTO switch..... 3-66
  - Forward pusher axle switch..... 3-66
  - Forward Rear Axle Diff-Lock
    - Switch..... 3-60
  - Forward trailer axle lift switch..... 3-66
  - Frame fastener torque
    - requirements..... 5-106
  - Front axle and suspension
    - maintenance..... 5-108
  - Fuel economy..... 3-24, 4-55
  - Fuel filter restriction pressure
    - gauge..... 3-44
  - Fuel filters..... 5-103
  - Fuel gauges
    - fuel filter restriction pressure... 3-44
    - fuel tank(s) level..... 3-9
  - Fuel heater..... 3-63
  - Fuel pressure gauge..... 3-46
  - Fuel shut-off valve..... 4-61
  - Fuel shut-off valves..... 5-103
  - Fuel specification..... 4-60
  - Fuel system
    - fuel filters..... 5-103
    - shut-off valves..... 5-103
  - Fuller transmission lubrication.... 5-41
  - Fuse inspection and replacement . 2-7,  
5-84
  - Fuse or relay blows..... 2-6
  - Fuses, circuit breakers and relays 5-80
- ## G
- Gauges
    - air pressure - primary..... 3-12
    - air pressure - secondary..... 3-12
    - auxiliary transmission oil
      - temperature..... 3-49
    - diesel exhaust fluid (DEF)..... 3-14
    - engine coolant (water)
      - temperature..... 3-11
    - engine oil pressure..... 3-11, 3-45
    - engine oil temperature..... 3-45
  - fuel filter restriction pressure... 3-44
  - fuel tank(s) level..... 3-9
  - primary air pressure..... 5-55
  - pusher axle(s) air pressure..... 3-43
  - secondary air pressure..... 5-55
  - speedometer..... 3-9
  - suspension load air pressure
    - #1..... 3-47
    - #2..... 3-47
  - tachometer..... 3-10
  - tag axle air pressure..... 3-43
  - tractor brake application air
    - pressure..... 3-47
  - trailer air tank air pressure..... 3-48
  - trailer brake application air
    - pressure..... 3-48
  - transfer case oil temperature... 3-48
  - transmission retarder oil
    - temperature..... 3-49
- ## Gauges (optional)
- air filter restriction..... 3-44
  - drive axle temperature (forward and rear)..... 3-46
  - fuel pressure..... 3-46
  - manifold pressure..... 3-45

transmission temperature .....	3-46
Gauges (standard)	
tachometer .....	4-54
GAWR - Gross Axle Weight Rating	6-5, 1-35
GCW - Gross Combination	
Weight .....	1-35
Generic air accessory switch .....	3-63
Generic spare switch .....	3-63
Glove box .....	3-95
Greenhouse gas certified tires...	5-140
Greenhouse Gas Tires	
warranty .....	6-9
Guide to the Warning Symbols ...	3-29
GVWR - Gross Vehicle Weight	
Rating .....	6-5, 1-35

## H

Hazard lights switch .....	3-64
Header .....	3-18
Headlight aiming .....	5-79
Headlight on alarm .....	3-41
Headlight replacement .....	5-78
Headlight switch .....	3-64
Heater and air conditioner .....	5-112

air conditioner .....	5-116
heater .....	5-115
Heater and air conditioner	
maintenance .....	5-112
Heating and air conditioning	
air conditioner button .....	3-86
defrost vents .....	3-85
fan control dial .....	3-85
floor and defrost vents .....	3-85
floor vents .....	3-85
outside air/recirculation air	
button .....	3-85
panel and floor vents .....	3-85
panel vents .....	3-85
sleeper heater - A/C controls ...	3-89
sleeper override .....	3-85
temperature control set point ...	3-86
Heating and Air Conditioning	
automatic control mode .....	3-83
buttons and dials .....	3-85
cab controls .....	3-79
introduction .....	3-80
manual control mode .....	3-82
max defrost mode .....	3-84
High exhaust system temperature	
(HEST) warning light .....	3-39

Hill hold .....	4-19
Hood hold downs .....	1-15
Hood hold-open device .....	1-17
Hood latch .....	1-16
Hood tilting	
hood hold downs .....	1-15
hood hold-open device .....	1-17
hood latch .....	1-16
How to order parts .....	6-8

## I

Idling the engine .....	4-9
Ignition key switch .....	3-96
Ignition timer .....	3-24
In-cab battery box .....	5-86
Inspection of the engine oil level .	5-94
Installed Equipment - Operator's	
Manuals .....	1-8
Instrument cluster .....	3-7
Instrument panel .....	3-5
Instrument system self test .....	3-8
Instrumentation	
driver performance center .....	3-12
instrument cluster .....	3-7
instrument panel .....	3-5

# Index

---

instrument system self test ..... 3-8  
menu control switch (MCS)..... 3-19  
Inter axle diff lock warning light... 3-38  
Inter-Axle Differential Lock Switch 3-60

## J

Jump starting vehicles.....2-8

## K

Key fob operation ..... 1-12  
Key fob synchronization ..... 1-13  
Keys  
remote keyless entry (RKE) .... 1-11  
Kingpin lubrication ..... 5-108  
Komfort-Latch® Feature ..... 1-26

## L

Lane departure warning (LDW)  
light ..... 3-41  
Lap/shoulder belt ..... 1-23  
Left turn signal light indicator .... 3-42  
Load distribution ..... 1-35  
Low air alarm turns on.....2-3  
Low coolant level warning light ... 3-40

Low voltage disconnect (LVD) .... 3-60,  
5-77  
Lubricant specifications ..... 5-35  
Lubrication..... 5-38

## M

Main content area..... 3-19  
Maintenance  
5th wheel..... 5-105  
air cleaners ..... 5-100  
air conditioner..... 5-116  
air intake system ..... 5-99  
air system ..... 5-49  
Allison transmission lubrication 5-43  
brake adjustment ..... 5-58  
brake inspection ..... 5-59  
chrome and aluminum surfaces 5-63  
cleaning vinyl and upholstery .. 5-67  
clutch ..... 5-150  
cooling system..... 5-72  
driver's check list ..... 1-36  
Eaton/Dana axle lubrication ... 5-46  
electrical system..... 5-77  
emergency welding ..... 5-104  
engine ..... 5-93

exterior ..... 5-63  
frame fastener torque  
requirements ..... 5-106  
frame fastener torque table... 5-106  
front axle and suspension  
lubrication..... 5-108  
fuel system..... 5-103  
Fuller transmission lubrication . 5-41  
heater ..... 5-115  
inspection ..... 5-109  
lubricant specifications..... 5-35  
maintenance schedule ..... 5-12  
Meritor axle lubrication..... 5-45  
noise and emission control  
standards ..... 5-117  
oil changes..... 5-44  
painted surfaces ..... 5-63  
preventive maintenance ..... 5-9  
rear axle alignment..... 5-130  
rear axle and suspension ..... 5-125  
rear axle lubrication ..... 5-128  
rear suspension fasteners torque  
table ..... 5-127  
rear suspension U-bolt torque  
table ..... 5-128

- safety restraint system -  
inspection ..... 5-68
- safety restraint system - inspection  
guidelines ..... 5-69
- sliding fifth wheel ..... 5-107
- Spicer transmission lubrication. 5-43
- stainless steel ..... 5-64
- steering and driveline ..... 5-131
- steering gear lubrication ..... 5-48
- tail pipe surface cleaning ..... 5-64
- tires ..... 5-136
- transmission ..... 5-147
- U-bolt torque ..... 5-110
- U-bolt torque table ..... 5-111
- universal joint lubrication ..... 5-47
- vehicle cleaning ..... 5-65
- washing chassis ..... 5-67
- washing exterior ..... 5-66
- wheel alignment ..... 5-109
- wheel bearing lubrication ..... 5-47
- windshield wiper/washer ..... 5-71
- Maintenance Procedures  
inspection of the engine oil level 5-94  
topping up the engine oil ..... 5-95
- Maintenance schedule ..... 5-9
- Malfunction Indicator Lamp (MIL) 3-39
- Manifold pressure gauge ..... 3-45
- Manual transmission ..... 4-15  
clutch brake ..... 4-17  
clutch travel ..... 4-17  
double clutching ..... 4-18  
release bearing wear ..... 4-20  
riding the clutch ..... 4-20  
shifting gears ..... 4-17
- Manual windshield  
defrosting/defogging ..... 3-87
- Marker/clearance light switch ..... 3-65
- Marker/Clearance/Cab light  
switch ..... 3-65
- Marker/Clearance/Trailer light  
switch ..... 3-65
- Master lubrication index ..... 5-38
- Matching tires ..... 5-139
- MCS knob cue ..... 3-19
- Menu control switch (MCS) ..... 3-19
- Meritor axle lubrication ..... 5-45
- Mirror heat switch ..... 3-76
- Mirrors ..... 3-75  
mirror heat switch ..... 3-76  
power mirror switch ..... 3-76
- ## N
- NHTSA consumer information ..... 6-8
- Noise and emission control  
maintenance ..... 5-117
- Noise control inspections ..... 5-118  
air intake system ..... 5-119  
diesel particulate filters ..... 5-121  
engine fan and shroud ..... 5-123  
engine mounted noise  
insulators ..... 5-119  
exhaust system ..... 5-119  
exhaust tail pipe ..... 5-122  
hood insulation blanket ..... 5-123  
inner fender shields and cab  
skirt ..... 5-123  
joints and clamps ..... 5-120  
maintenance log ..... 5-124  
piping ..... 5-120
- Noise emission label ..... 6-6
- ## O
- Odometer/trip odometer ..... 3-16
- Off-road ABS function switch ..... 4-31
- Oil changes ..... 5-44
- Oil gauges

## Index

---

auxiliary transmission oil  
  temperature ..... 3-49  
engine oil pressure ..... 3-11, 3-45  
engine oil temperature ..... 3-45  
transfer case oil temperature... 3-48  
transmission retarder oil  
  temperature ..... 3-49  
Oil pressure gauge ..... 3-11  
Operating hydraulic clutch ..... 4-15  
Operating procedure  
  automatic and automated  
    transmissions ..... 4-19  
  refueling ..... 4-61  
  stopping procedures ..... 4-62  
  transmission retarder ..... 4-34  
Optimal engine speed ..... 4-54  
Outside air / recirculation air ..... 3-89  
Outside air temperature ..... 3-16  
Outside air/recirculation air button 3-85  
Overinflated tires ..... 5-138  
Overloaded tires ..... 5-138

## P

Paint identification label ..... 6-6  
Painted surfaces ..... 5-63

Painting ..... 5-105  
Panel and floor vents ..... 3-85  
Panel vents ..... 3-85  
Park brake warning light ..... 3-37  
Parking brake ..... 4-23  
Parking brake valve ..... 3-60  
Passenger seat swivel ..... 1-22  
Passenger side 'down' mirror ..... 3-99  
Pintle hook switch ..... 3-66  
Pipe and hose clamp torque  
  values ..... 5-37, 5-95  
Power door lock ..... 3-77  
Power line communication (PLC) 4-24  
Power mirror switch ..... 3-76  
Power Take-off (PTO) switch ..... 3-65  
Power take-off (PTO) warning  
  light ..... 3-41  
Power window ..... 3-77  
Pressure gauges  
  engine oil pressure ..... 3-11, 3-45  
Pump mode warning light ..... 3-41  
Pusher axle(s) air pressure gauge 3-43

## R

Radio ..... 3-94

Rear axle - dual range  
  (two-speed) ..... 4-41  
Rear axle alignment ..... 5-130  
Rear axle and suspension  
  maintenance ..... 5-125  
  rear suspension fasteners ..... 5-127  
  visual inspection ..... 5-126  
Rear axle lubrication ..... 5-128  
Rear PTO switch ..... 3-66  
Rear Rear Axle Diff-Lock Switch . 3-60  
Rear suspension fasteners ..... 5-127  
Rear suspension fasteners torque  
  table ..... 5-127  
Rear suspension U-bolt torque  
  table ..... 5-128  
Rear trailer axle lift switch ..... 3-67  
Recovery hitch capacities ..... 2-18  
Recovery hitch connection ..... 2-14  
Recovery hitch installation ..... 2-15  
Recovery procedure ..... 2-13  
Recovery rigging ..... 2-19  
Refilling your radiator ..... 5-74  
Refrigerator warning light ..... 3-41  
Refueling ..... 4-60  
  fuel specification ..... 4-61  
Release bearing wear ..... 4-20

- Remote keyless entry (RKE)..... 1-12
- Remote Keyless Entry (RKE)..... 5-92
- batteries ..... 1-13
  - key fob operation ..... 1-12
  - key fob synchronization..... 1-13
- Remote throttle control switch ... 3-62
- removing and installing batteries . 5-87
- Replacing tires ..... 5-140
- Returning vehicle to service ..... 2-20
- Riding the clutch ..... 4-20
- Right turn signal light indicator... 3-42
- Roll stability program (RSP) ..... 4-26
- Roof mounted condenser fan  
switch ..... 3-66
- S**
- Safe vehicle operation..... 1-33
- Safety
- about the manual..... 1-3
  - air suspension height/air  
pressure..... 4-49
  - cab and frame access ..... 1-10
  - deck plate access ..... 1-13
  - deflated air springs ..... 4-50
  - driver's check list ..... 1-36
  - emergency equipment kit ..... 1-36
  - introduction ..... 1-3
  - safe vehicle operation..... 1-33
  - safety alerts ..... 1-3
  - suspension air pressure gauge 4-49
  - vehicle loading..... 1-34
  - vehicle safety ..... 1-5
- Safety alerts ..... 1-3
- Safety restraint belts..... 1-22
- belt damage and repair ..... 1-28
  - during pregnancy..... 1-28
  - inspection ..... 5-68
  - safety restraint tips ..... 1-31
- Safety restraint system
- inspection ..... 5-68
- Seat adjustment..... 1-19
- passenger seat swivel ..... 1-22
- Seat belts ..... 1-19
- adjustments ..... 1-19
  - belt damage and repair ..... 1-28
  - during pregnancy..... 1-28
  - Komfort-Latch feature..... 1-26
  - lap/shoulder belt..... 1-23
  - safety restraint tips ..... 1-31
- Seats
- adjustments ..... 1-19
  - Komfort-Latch feature..... 1-26
  - tether belts ..... 1-25
  - To adjust an external tether belt 1-26
- Seats and restraints ..... 1-19
- Service brake warning light ..... 3-38
- Service transmission warning light 3-42
- ServiSignal Mini Indicator ..... 5-101
- Setting System Alarm ..... 3-92
- Setting System Time..... 3-92
- Shut-down
- fuel specification..... 4-61
  - location of fuel shut-off valves.. 4-61
  - refueling ..... 4-60
  - sleeper bunk ..... 4-58
- Single Rear Axle Diff Lock Switch 3-60
- Sleeper Alarm Clock..... 3-91
- dim control operation..... 3-93
  - setting system alarm ..... 3-92
  - setting system time..... 3-92
  - snooze operation ..... 3-93
  - turning the alarm on/off ..... 3-93
- Sleeper bunk ..... 4-58
- sleeper restraint ..... 4-59
- Sleeper bunks and restraints ..... 1-29
- Sleeper heater - A/C controls..... 3-89
- Sleeper HVAC air filter ..... 5-114

## Index

---

- Sleeper occupant restraint ..... 4-59
- Sliding 5th wheel
  - maintenance ..... 5-107
- Sliding Fifth wheel
  - maintenance ..... 5-107
- Snooze Operation ..... 3-93
- Speed restricted tires ..... 5-141
- Speedometer ..... 3-9
- Spicer transmission lubrication ... 5-43
- Spot light. switch ..... 3-65
- Spring brakes—manual release .. 2-20
- Stainless steel ..... 5-64
- Starting procedure
  - cold temperature ..... 4-6
  - engine warm-up ..... 4-7
  - ether metering ..... 4-10
  - normal temperature ..... 4-5
- Stationary PTO operation ..... 4-12
- Steer axle
  - identification ..... 6-7
- Steer Axle Diff Lock Switch ..... 3-60
- Steering and driveline
  - maintenance ..... 5-131
  - fluid level and refill ..... 5-132
- Steering column ..... 3-67
  - tilt/telescoping ..... 3-68
- trailer brake hand valve ..... 3-72
  - turn signal/high beam switch ... 3-69
- Steering gear lubrication ..... 5-48
- Steering system maintenance
  - steering shaft ..... 5-133
- Steering wheel controls ..... 3-73
- Stop engine lamp turns on ..... 2-4
- Stop engine warning light ..... 3-40
- Suspension air pressure gauge .. 4-49
- Suspension dump switch ..... 3-66
- Suspension dump warning light .. 3-41
- Suspension lift switch ..... 3-66
- Suspension load air pressure
  - gauges ..... 3-47
- Suspension lubrication ..... 5-108
- Switches
  - 2 speed transfer case ..... 3-59
  - ABS off-road switch ..... 3-52
  - accessory air switch ..... 3-54
  - air conditioner button ..... 3-86
  - auxiliary light switch ..... 3-54
  - axle switch, diff-lock - dual .... 3-50
  - axle switch, diff-lock - forward
    - rear ..... 3-50
  - axle switch, diff-lock - rear rear 3-51
  - axle switch, diff-lock - single
    - rear ..... 3-51
  - axle switch, diff-lock - steer .... 3-51
  - axle switch, inter axle differential
    - locked (tandem) ..... 3-51
  - axle switch, pusher ..... 3-57
  - axle switch, tag ..... 3-57
  - axle switch, two speed ..... 3-51
  - back up alarm mute switch .... 3-51
  - beacon light switch ..... 3-55
  - brake level switch ..... 3-52
  - brake on/off switch ..... 3-52
  - cab dimmer ..... 3-52
  - cruise control ..... 4-35
  - cruise control on/off switch .... 3-52
  - cruise control set/resume
    - switch ..... 3-53
  - dash switches ..... 3-50
  - daytime running light switch .... 3-55
  - diesel particulate filter (DPF)
    - regeneration switch ..... 3-54
  - dome light switch ..... 3-55
  - dual range rear axle switch .... 4-41
  - dump truck gate switch ..... 3-52
  - engine fan override switch ..... 3-53
  - engine fan switch ..... 4-12



- engine heater switch ..... 3-53  
 ether start switch ..... 3-53  
 exterior lights self test ..... 3-77  
 exterior lights self test switch... 3-55  
 fifth wheel slide switch ..... 3-54  
 flood light switch ..... 3-55  
 fog light switch ..... 3-55  
 forward power take-off (PTO)  
   switch ..... 3-57  
 forward trailer axle lift switch ... 3-58  
 fuel heater switch ..... 3-54  
 hazard light switch ..... 3-56  
 headlight switch ..... 3-64  
 headlight switch and parking  
   lights ..... 3-56  
 low voltage disconnect (LVD) .. 3-51,  
   3-60  
 marker light switch ..... 3-56  
 marker/clearance/cab light  
   switch ..... 3-56  
 marker/clearance/trailer light  
   switch ..... 3-56  
 mud and snow traction control . 3-56  
 off-road ABS function switch  
   (option) ..... 4-31  
 optional deep snow and mud  
   switch ..... 4-31  
 outside air/recirculation air  
   button ..... 3-85  
 overspeed air shutdown  
   (manual) ..... 3-53  
 overspeed air shutdown (test).. 3-53  
 parking brake valve ..... 3-52  
 pintle hook switch ..... 3-58  
 power door lock ..... 3-77  
 power take-off (PTO) switch... 3-57  
 power window ..... 3-77  
 rear power take-off (PTO)  
   switch ..... 3-57  
 rear trailer axle lift switch ..... 3-58  
 remote throttle switch ..... 3-53  
 roofdenser switch ..... 3-57  
 sleeper override ..... 3-85  
 spare switch ..... 3-54  
 spot light switch ..... 3-56  
 suspension dump switch ..... 3-57  
 suspension lift switch ..... 3-58  
 temperature control set point... 3-86  
 third axle lift switch ..... 3-58  
 trailer axle (3rd axle) lift switch . 3-58  
 trailer belly dump switch ..... 3-58  
 trailer dump gate switch ..... 3-59  
 trailer hotline switch ..... 3-59  
 trailer marker light interrupter  
   switch ..... 3-69  
 trailer suspension air dump.... 3-59  
 transfer case ..... 3-59  
 turn signal/high beam switch ... 3-69  
 under hood air intake ..... 3-54  
 winch clutch switch ..... 3-59  
 windshield wipers/washer ..... 3-71
- T**
- Tachometer ..... 3-10  
 Tag axle air pressure gauge ..... 3-43  
 Tag axle switch ..... 3-66  
 Tail pipe surface cleaning ..... 5-64  
 Telematic system  
   care and operation ..... 3-98  
   disclaimer ..... 3-99  
 Temperature control dial ..... 3-86  
 Temperature gauges  
   engine oil temperature ..... 3-45  
   transmission retarder oil  
     temperature ..... 3-49

## Index

- water temperature (engine coolant) ..... 3-11
  - Tether belts ..... 1-25
  - Third axle lift switch ..... 3-66
  - Third trailer axle lift switch ..... 3-66
  - Tilt/telescoping steering column .. 3-68
  - Tire and rim data label..... 6-5
    - GAWR..... 6-5
  - Tire chains ..... 5-141
  - Tire Chains ..... 2-22
  - Tire inflation warning light ..... 3-42
  - Tire Pressure Monitoring System (TPMS) ..... 3-23
  - Tires ..... 5-136
    - greenhouse gas certified tires 5-140
    - inflation check ..... 5-136
    - replacement..... 5-140
    - tire chains ..... 5-141
  - Tires and wheels
    - wheel cap nut torque sequence ..... 5-143
    - wheel cap nut torque table ... 5-142
    - wheel mounting and fastening 5-142
  - To jump start your vehicle ..... 2-9
  - Topping up the engine oil ..... 5-95
  - Towing the vehicle ..... 2-23
  - Traction control switch..... 3-65
  - Traction control warning light ..... 3-37
  - Tractor brake application air pressure gauge ..... 3-47
  - Trailer ABS ..... 4-24
  - Trailer air suspension switch..... 3-67
  - Trailer air tank air pressure gauge 3-48
  - Trailer anti-lock brake system warning light ..... 3-38
  - Trailer belly dump switch ..... 3-67
  - Trailer brake application air pressure gauge ..... 3-48
  - Trailer brake hand valve..... 3-72
  - Trailer dump gate switch ..... 3-67
  - Trailer hotline switch ..... 3-67
  - Transfer case oil temperature gauge ..... 3-48
  - Transfer case switch..... 3-67
  - Transmission
    - identification ..... 6-7
    - lubricants ..... 5-148
    - maintenance ..... 5-147
    - oil change ..... 5-147
    - shifting gears in a new vehicle . 4-17
    - transmission tips ..... 4-20
  - Transmission maintenance ..... 5-147
  - Transmission retarder ..... 4-34
  - Transmission retarder oil temperature gauge ..... 3-49
  - Transmission retarder warning light ..... 3-42
  - Transmission temperature gauge 3-46
  - Transmission temperature gauges
    - auxiliary transmission oil temperature..... 3-49
  - Transmissions
    - automatic and automated ..... 4-19
    - auxiliary transmission ..... 4-20
    - transmission retarder ..... 4-34
  - Trip information ..... 3-24
  - Trip reset..... 3-14
  - Truck information ..... 3-25
  - Turbocharger ..... 5-99
  - Turn signal/high beam switch..... 3-69
  - Turning the Alarm On/Off ..... 3-93
  - Two speed axle switch ..... 3-60
  - Two speed transfer case switch .. 3-67
- ## U
- U-bolt torque ..... 5-110
  - U-Joints ..... 5-135

Under hood air intake switch..... 3-62  
 Underinflated tires ..... 5-137  
 Universal joint lubrication..... 5-47  
 Use of instrument cluster display . 4-55  
 Using the tachometer..... 4-54

## V

Vehicle cleaning..... 5-65  
 Vehicle identification  
   assembly plant code ..... 6-3  
   chassis number..... 6-4  
   chassis number locations..... 6-4  
   model year designations table ... 6-3  
   VIN number ..... 6-3  
   VIN number locations ..... 6-4  
 Vehicle loading ..... 1-34  
   GAWR..... 1-35  
   GCW..... 1-35  
   GVWR..... 1-35  
   load distribution..... 1-35  
 Vehicle recovery  
   driver controlled main  
     differential..... 2-16  
   recovery guidelines ..... 2-12  
   recovery hitch capacities ..... 2-18

recovery hitch connection ..... 2-14  
 recovery hitch installation..... 2-15  
 recovery procedure ..... 2-13  
 recovery rigging ..... 2-19  
 returning vehicle to service..... 2-20  
 sand, mud, snow and ice ..... 2-22  
 spring brakes ..... 2-20  
 towing the vehicle ..... 2-23  
 Vehicle safety ..... 1-5  
 Vehicle telematic system ..... 3-97  
 VIN number location ..... 6-4  
 Vinyl and upholstery  
   cleaning ..... 5-67  
 Virtual gauges ..... 3-23

## W

Wait to start warning light ..... 3-41  
 Warning and faults ..... 3-26  
 Warning light/indicator symbols .. 3-30  
   anti-lock brake system (ABS) .. 3-37  
   anti-lock brake system (ABS),  
     trailer ..... 3-38  
   axle, inter-axle differential locked  
     (tandem axles) ..... 3-38  
   axle, traction control..... 3-37

dump truck, body up ..... 3-38  
 dump truck, gate ..... 3-38  
 dump truck, trailer body up ..... 3-38  
 emissions, diesel particulate filter  
   (DPF)..... 3-38  
 emissions, high exhaust system  
   temperature (HEST) ..... 3-39  
 engine brakesaver or transmission  
   retarder..... 3-42  
 engine, check engine ..... 3-40  
 engine, engine fan ..... 3-40  
 engine, ether start..... 3-40  
 engine, heater ..... 3-40  
 engine, low coolant level ..... 3-40  
 engine, overspeed air  
   shutdown..... 3-40  
 engine, retarder (brake) ..... 3-40  
 engine, stop engine ..... 3-40  
 engine, wait to start ..... 3-41  
 lane departure warning (LDW) . 3-41  
 lights, high beam ..... 3-41  
 malfunction indicator lamp..... 3-39  
 park brake..... 3-37  
 power take-off (PTO)..... 3-41  
 power take-off (PTO), pump  
   mode ..... 3-41

## Index

---

- rationality check ..... 3-38
  - refrigerator ..... 3-41
  - seat belt, fasten ..... 3-41
  - service transmission ..... 3-42
  - suspension dump ..... 3-41
  - tire inflation..... 3-42
  - transmission, auxiliary ..... 3-42
  - transmission, check ..... 3-42
  - turn signal, left ..... 3-42
  - turn signal, right ..... 3-42
  - water in fuel (WIF)..... 3-41
  - wheel spin control ..... 4-30
  - Warning/informational screen..... 3-99
  - Warranty ..... 6-9
    - greenhouse gas tires..... 6-9
  - Washing chassis ..... 5-67
  - Water in fuel (WIF) warning light . 3-41
  - Water temperature gauge ..... 3-11
  - Weekly checks ..... 1-40
  - Welding (emergency)..... 5-104
  - What to do if..... 2-3
    - engine is overheating ..... 2-5
    - engine oil pressure lamp turns on..... 2-4
    - fuse or relay blows ..... 2-6
    - low air alarm turns on ..... 2-3
    - stop engine lamp turns on ..... 2-4
    - you need roadside assistance ... 2-3
  - Wheel alignment ..... 5-109
  - Wheel bearing adjustment ..... 5-146
  - Wheel bearing lubrication ..... 5-47
  - Wheel cap nut torque..... 5-142
  - Wheel mounting and fastening .. 5-142
  - Wheel replacement with disc brake option ..... 5-144
  - Wheel spin control ..... 4-30
  - Wheel spin control warning lamp. 4-30
  - Winch clutch switch..... 3-67
  - Windshield wiper/washer..... 5-71
    - maintenance ..... 5-71
  - Windshield wipers/washer ..... 3-71
  - Winterfronts ..... 4-13
- ## Y
- Yaw control ..... 4-27
  - Yaw stability ..... 4-27



YOUR SERVICING DEALER IS:



NEED HELP? GIVE US A CALL -  
24 HOURS A DAY  
1-800-KW-ASSIST  
1-800-592-7747

DO NOT REMOVE THE MANUAL FROM VEHICLE.  
BEFORE OPERATING VEHICLE STUDY THE MANUAL CAREFULLY.  
READ AND UNDERSTAND ALL WARNINGS, CAUTIONS AND NOTES.

KENWORTH TRUCK COMPANY  
P.O. Box 1000  
Kirkland, Washington 98083-1000  
(425) 828-5000

CANADIAN KENWORTH COMPANY  
6711 Mississauga Road N.  
Mississauga, Ontario L5N 4J8  
(905) 858-7000

Y53-1200-1B1 © 2013 Kenworth Truck Company