

■ **EBS**
Electronically controlled
Brake system
in motor coaches

■ **System and functional**
description

■ **1. Edition**

■ © Copyright WABCO 2003

WABCO

Vehicle Control Systems
An American Standard Company

1. Introduction / Advantages of EBS	3
2. System structure in buses	
System structure 2-axle bus	4
WABCO EBS construction kit	5
System variants	6
Wiring diagram 2-axle bus	7
Wiring diagram 3-axle bus	8
3. Description of components	
Brake signal transmitter 480 00. ... 0	9
EBS central module 446 135 ... 0	10
Proportional relay valve 480 202 ... 0	11
3/2 relay valve 480 205 ... 0	12
Axle modulator 480 103 ... 0	13
4. Description of EBS function	
Function of the electro-pneumatic unit	14
Function of pneumatic redundancy	14
Additional redundancy on the front axle	14
Rear axle redundancy	15
Electrical / electronic structure	15
Control functions	16
Backup functions	17
Halt brake, brake hold and release aid	17
5. Error recognition and display	
Error recognition	18
Error display	19
6. EBS "emergency modes" / EBS test types	20
7. WABCO PC - Diagnosis	21
Diagnostic equipment for WABCO EBS	22
Diagnostic Software EBS Euro	23
8. Parameter Setting	
Parameter setting	30

Introduction

The demands made on braking systems are increasing steadily. Therefore, the development and introduction of an electronic braking system (EBS) is a logical step.

EBS increases traffic safety through reduced stopping distance and improved brake stability. The full diagnosis and surveillance functions as well as the display of brake lining wear offer an effective fleet logistics.

Advantages of EBS

EBS reduces service costs considerably.

- ❑ The electronic braking system has a lot of functions. The aim is to maximise braking safety at reduced costs, for instance by optimising wheel brake lining wear.
- ❑ Setting pressure, according to wear criteria, to the front and rear axle results in uniform lining wear. Overall wear is minimised by making the load on all wheel brakes uniform. Moreover, servicing and lining replacement are done at the same time. This reduces down-time costs.
- ❑ Depending on the vehicle utilisation profile and other factors, this also means considerable savings for the vehicle user. In terms of wheel brake service costs alone, a firsthand owner will save more money with an electronically braked bus than with a vehicle with a conventional braking system.

Increased brake safety

WABCO did not only take existing regulations into consideration while developing EBS. Top priority was given to safety and user advantages. This is why a vehicle with EBS can clearly do more than is required by law.

The high safety quality attributed to EBS is due to several factors:

- ❑ Braking time is reduced through shorter response time and pressure build-up time of the brakes on the front and rear axle(s).
- ❑ The improved ABS function increases vehicle stability when brakes are activated.
- ❑ The components of the front and rear axle braking system and brake lining wear are monitored permanently.
- ❑ The integrated ASR function also provides optimum vehicle stability and traction during start and acceleration.

EBS braking system for buses with no attachment (4S/4M system)

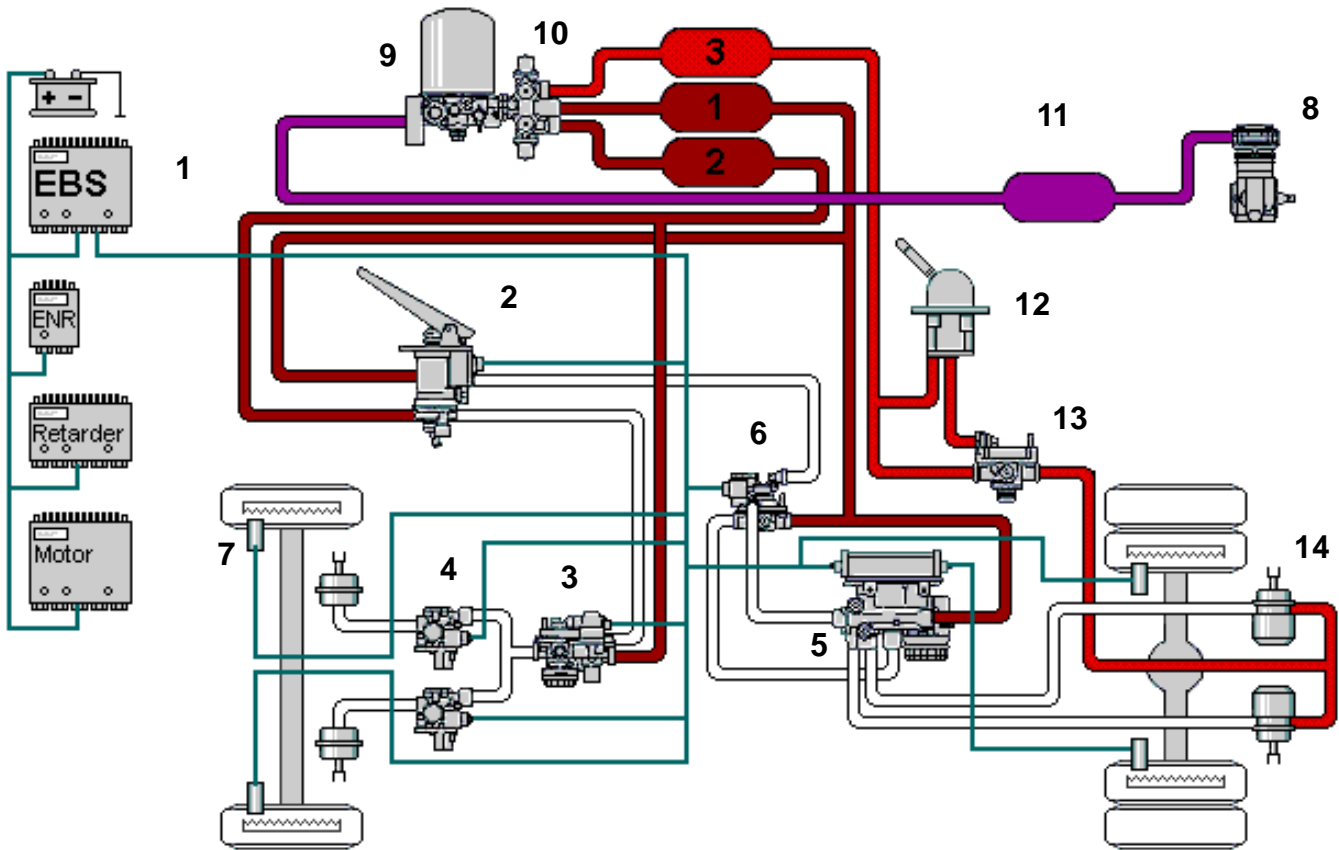

Legend:

EBS components:

- 1 EBS central module
- 2 Brake signal transmitter
- 3 Proportional relay valve
- 4 ABS solenoid valve
- 5 Axle modulator
- 6 3/2 relay valve
- 7 ABS sensors

Other components:

- 8 Compressor
- 9 Air dryer
- 10 Four-circuit protection valve
- 11 Air reservoir
- 12 Hand brake valve
- 13 Relay valve FBA
- 14 Brake cylinder

WABCO EBS construction kit

The design and structure of WABCO EBS allow high flexibility for vehicle manufacturers during system construction.

In terms of range

- ❑ subsystem or full system
- ❑ addition and cut-off redundancy

- ❑ electrical interfaces

the most complex demands can, therefore, be met. To meet the vital needs of the vehicle owner, WABCO recommends an EBS with an individual pressure control unit on the front and rear axle, and which provides for pneumatic redundancies in all brake circuits.

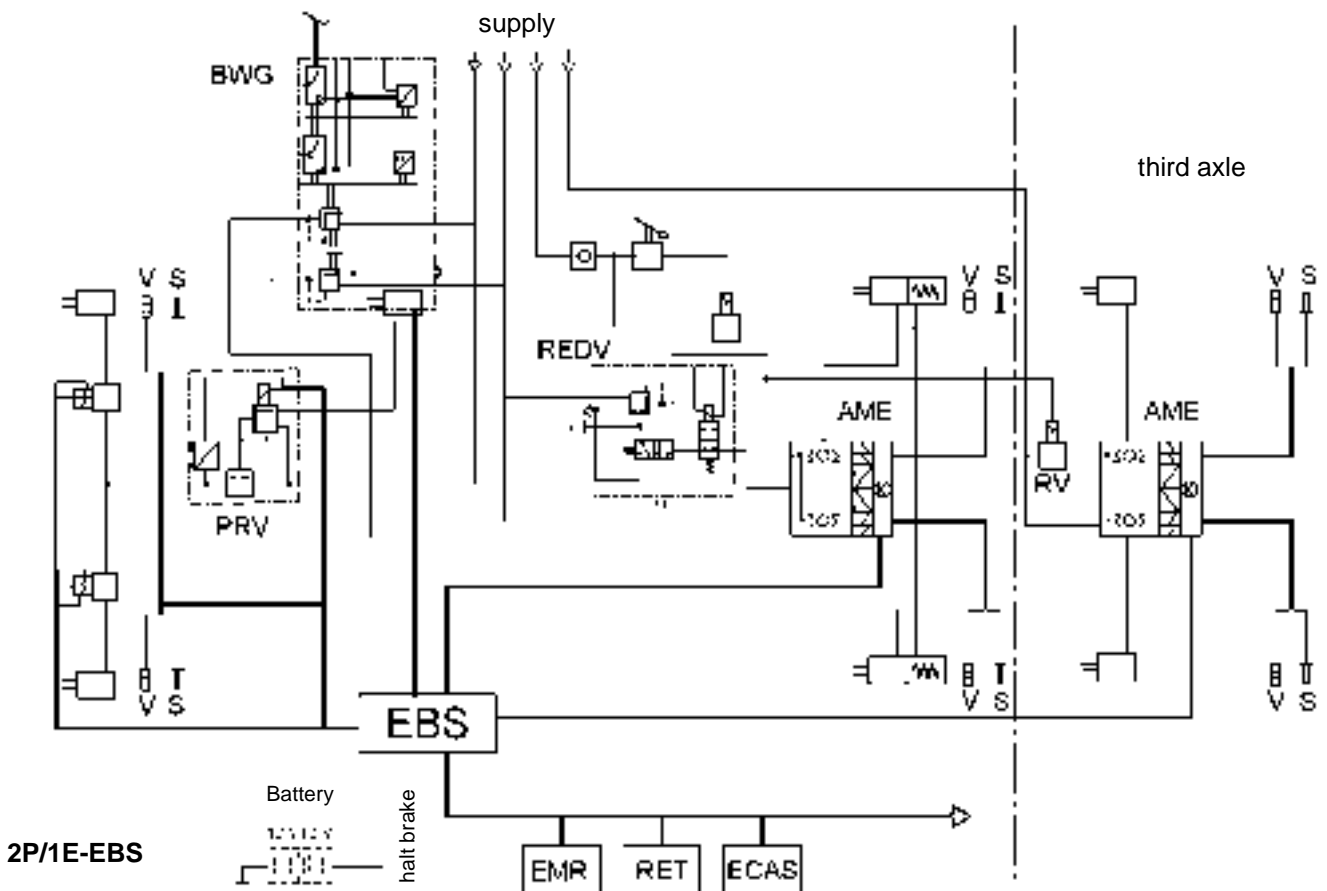

- AME = Axle modulator
- BWG = Brake signal transmitter
- ECAS = Electronically Air Suspension System
- EMR = Electronically engine control
- PRV = Proportional relay valve
- REDV = 3/2 relay valve (redundancy valve)
- RET = Retarder
- RV = Relay valve
- S = Speed sensor
- V = Wear indicator

The EBS described here consists of a dual-circuit, purely pneumatic unit and a superimposed single-circuit, electro-pneumatic unit. This configuration is described as 2P/1E system.

The single-circuit, electro-pneumatic unit comprises a central electronic control device (central module), the axle modulator with integrated electronic unit for the rear axle, and, if necessary, the axle modulator for the third axle, a brake signal transmitter with two integrated

desired value sensors and brake switches, as well as a proportional relay valve and two ABS valves for the front axle.

In terms of structure, the dual-circuit pneumatic unit basically corresponds to that of a conventional braking system. This unit serves as redundancy and only becomes active in case of electro-pneumatic circuit failure.

2. EBS

System structure in buses

EBS 4S/4M in buses with optional trailer control

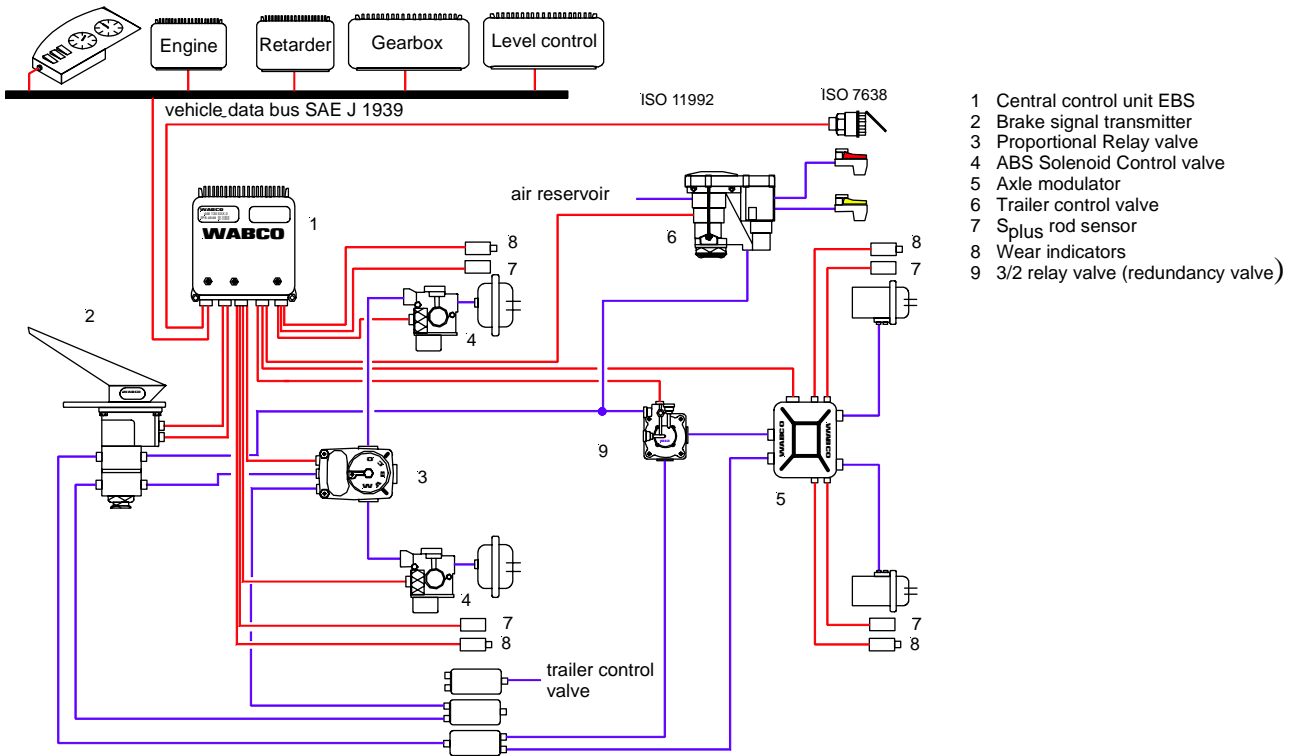

EBS 6S/6M in articulated buses

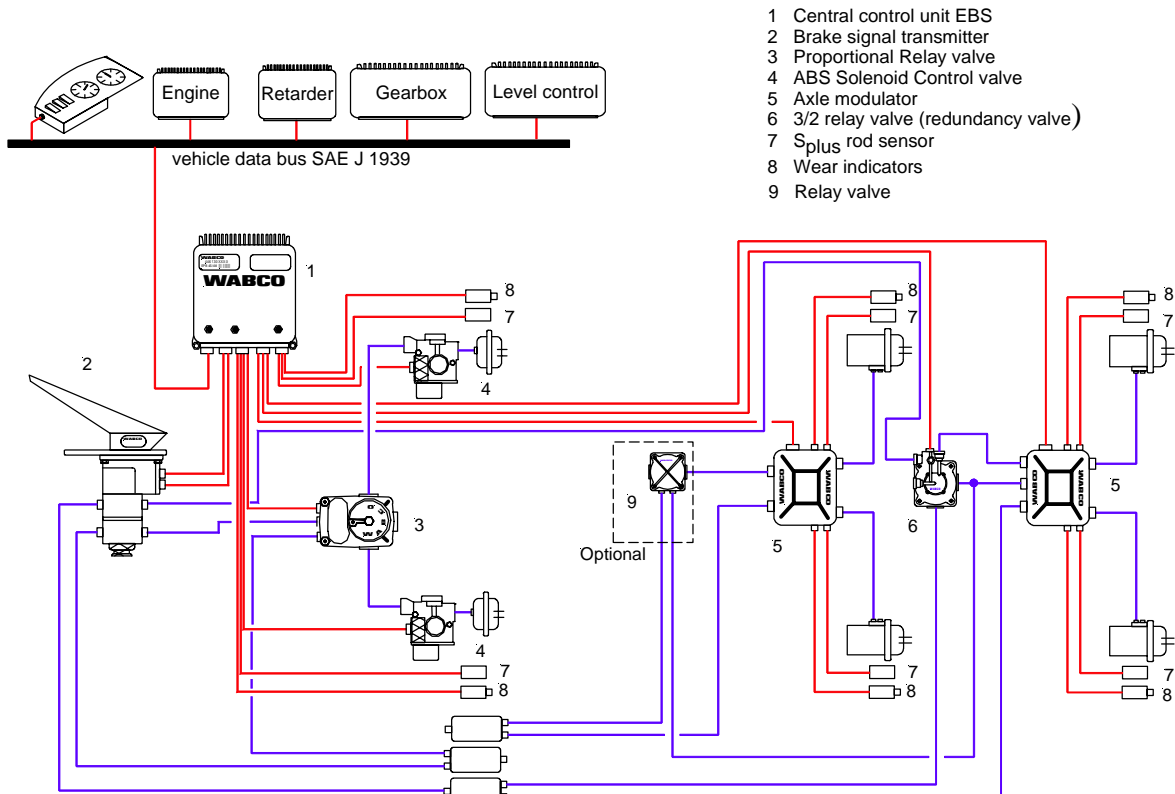

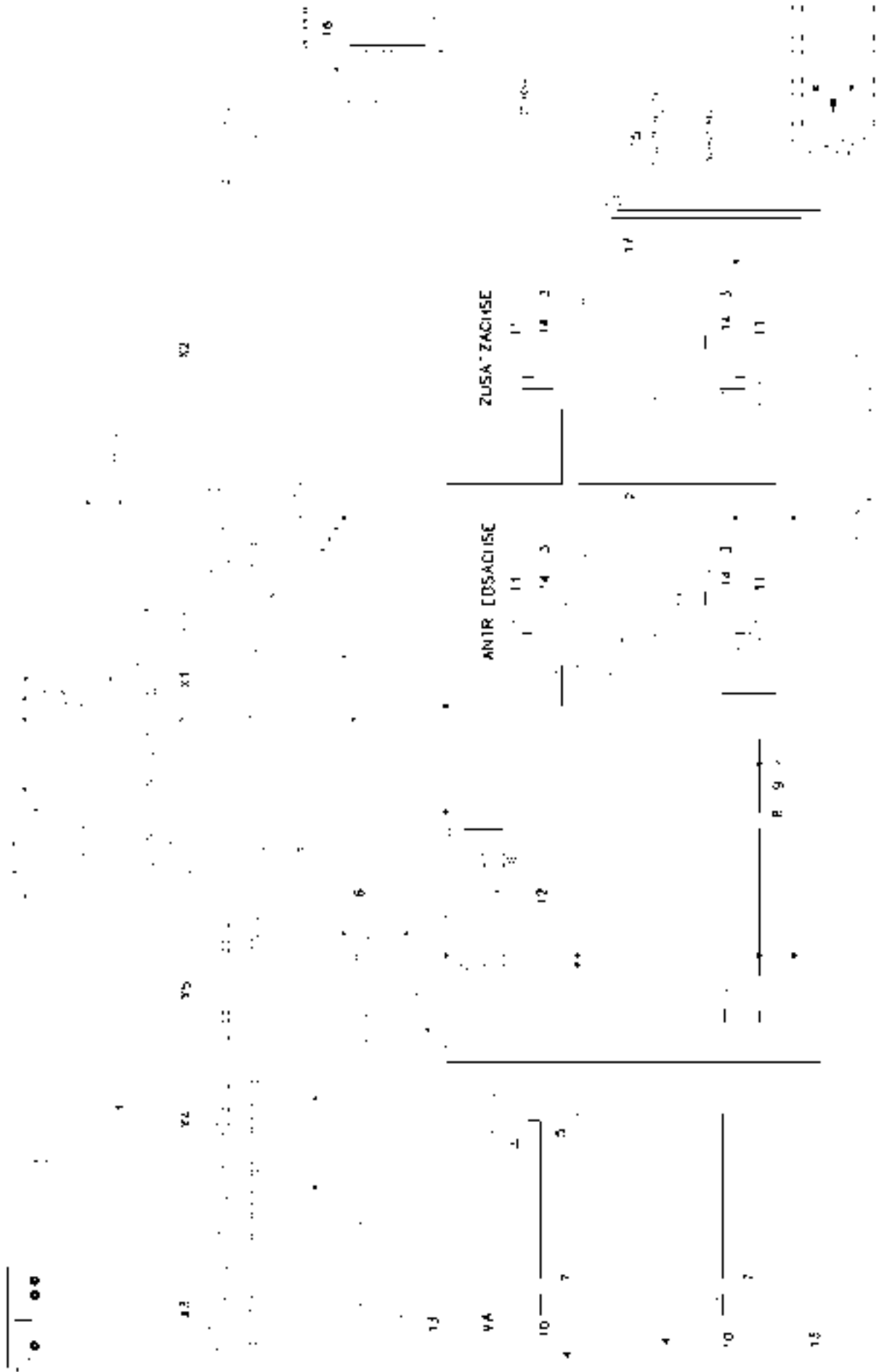

Brake signal transmitter 480 001/ 002 ... 0

The brake signal transmitter is used to produce electrical and pneumatic signals, and to increase and decrease the air pressure of the electronically controlled braking system. The device has a dual-circuit pneumatic and a dual-circuit electrical structure. Actuation start is recorded electronically by a double switch. The operating tappet's route is controlled and transmitted as pulse-width modulated electrical signal. Further pneumatic redundancy pressure is delivered in circuits 1 and 2. The pressure in the second circuit is retained slightly in the process. In case of (electrical or pneumatic) failure of a circuit, the other circuits remain functional.

Depending on bus type, the brake signal transmitter is actuated via a running plate (480 002 ... 0) 0) or via a push pedal using the tappet (480 001 ... 0).



How it works:

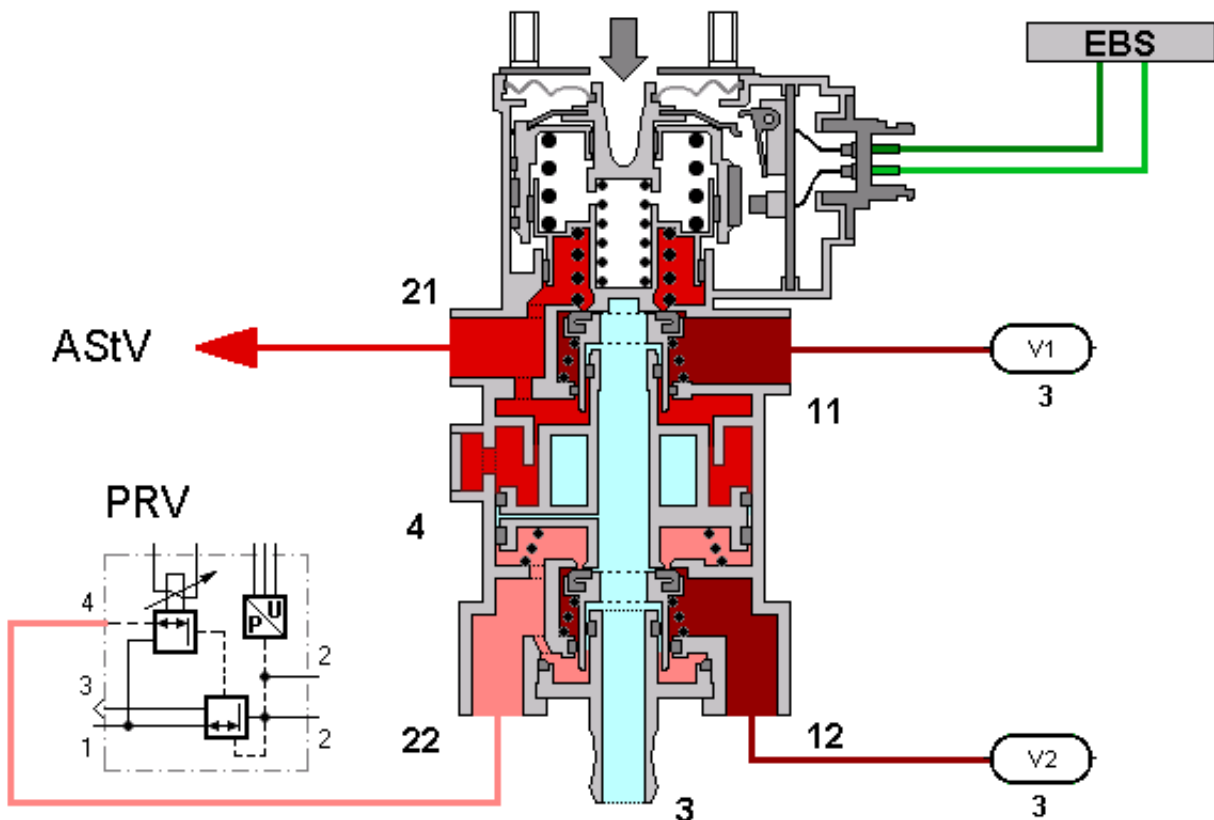

EBS central module 446 135 ... 0

The central module is used to control and monitor the electronically controlled braking system. It determines the vehicle's nominal delay from the signals received by the brake signal transmitter. The nominal delay and the wheel velocity measured by the speed sensors are input signal for the electro-pneumatic control unit, which uses it to calculate nominal pressure values for the front axle and rear axle(s). The front axle's nominal pressure value is then compared with the measured actual value, and any existing deviations corrected with the help of the proportional relay valve. Moreover, the wheel velocity is evaluated so that in case of locking, an ABS control can be carried out by modulating the braking pressure in the brake cylinders. The central module exchanges EBS system bus related data with the axle modulators.

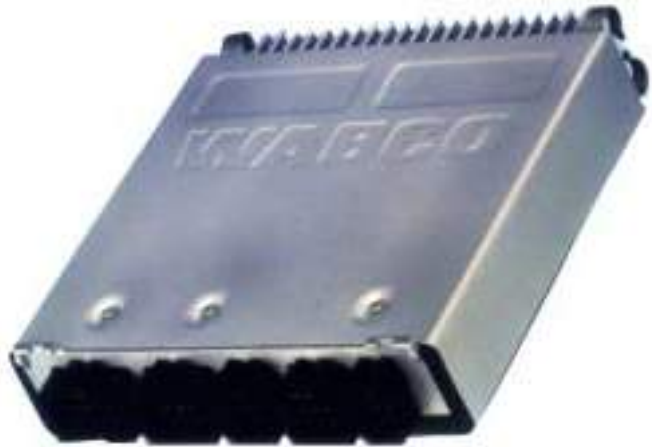

The central module communicates with other systems (engine control unit, retarder, display unit, etc.) via the vehicle data bus in accordance with SAE J 1939.

KOM-integrated central unit:

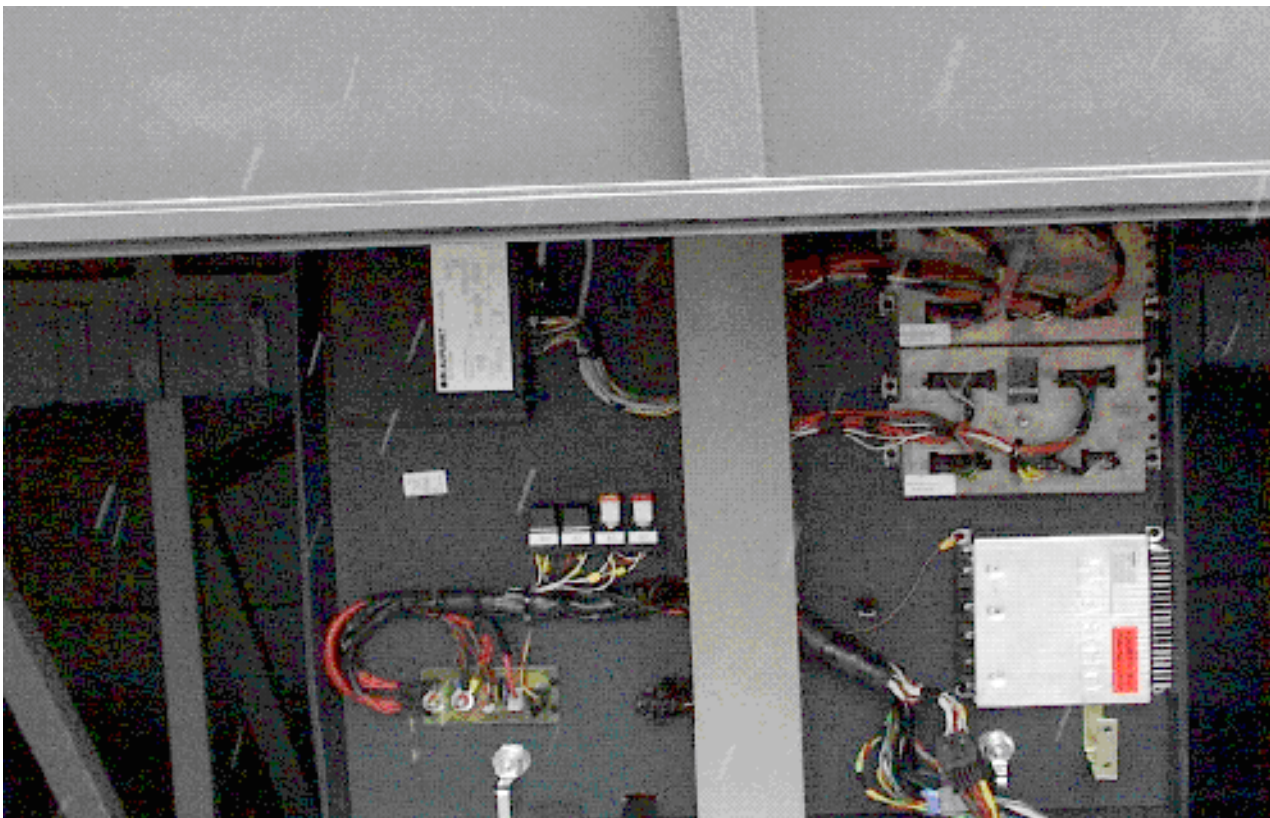

Proportional relay valve 480 202 ... 0

The proportional relay valve is used in the electronically controlled braking system to modulate the braking pressure on the front axle.

It comprises the proportional solenoid valve, relay valve and pressure sensor. Electrical drive and monitoring takes place via the central module of the hybrid system (electro-pneumatically / pneumatically).

The control current impressed by the electronic unit is transformed via the proportional solenoid valve into a control pressure for the relay valve. The proportional relay valve's output pressure is proportional to this pressure. The pneumatic drive on the relay valve takes place via the brake signal transmitter's redundant (back-up) pressure.



How it works:

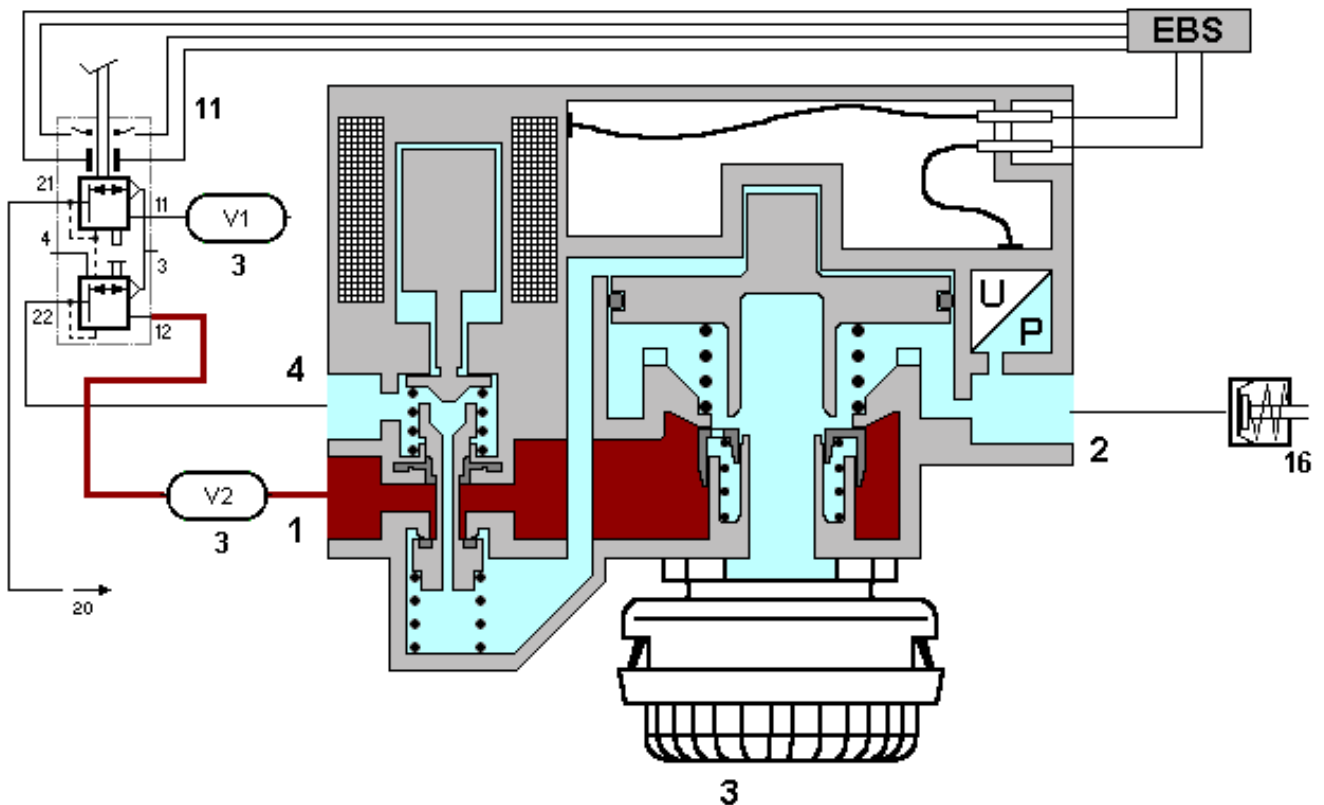

3/2 relay valve 480 205 ... 0

The 3/2 relay valve is used to supply air to and remove air quickly from the brake cylinder on the rear axle in case of redundancy, and comprises several valve units which must fulfil the following functions, among others:

- ❑ 2/2 solenoid valve for controlling redundancy in intact electro-pneumatic braking circuit
- ❑ Relay valve function, to improve the time behaviour of redundancy,
- ❑ Pressure retention, to synchronise the beginning of pressure level control on the front and rear axle, in case of redundancy .
- ❑ In case of redundancy, rear axle 1:1 is controlled.

The 3/2 relay valve also has a 3/2 directional control valve to which current is supplied in case of ABS and is thus meant to prevent an involuntary drive through of the rear axle redundancy pressure during ABS control.

How it works:

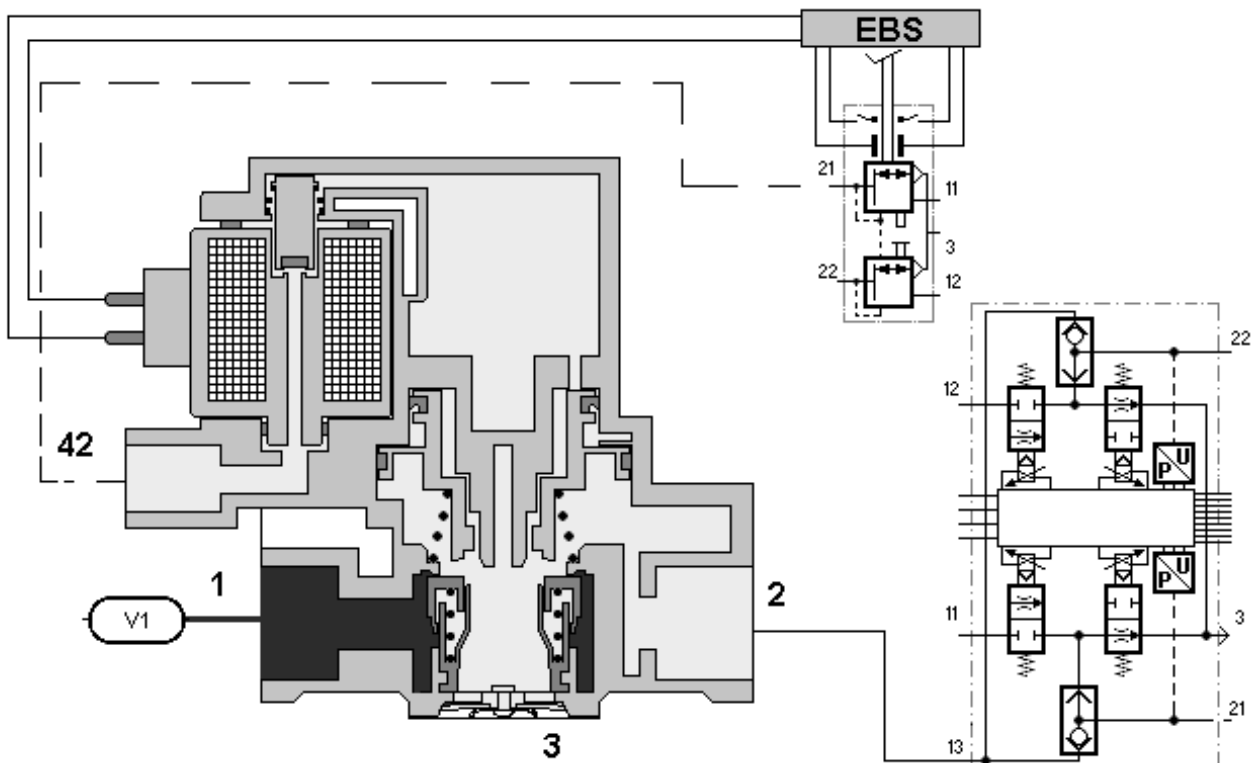

Axle modulator 480 103 ... 0

The axle modulator controls the brake cylinder pressure on the two sides of a single or dual axle. It has two pneumatically independent pressure control channels with an air admission and bleeder valve each, individual pressure sensors and a joint electronic control unit. Desired pressure definition and external surveillance take place via the central module.

Moreover, wheel rotation speed is measured and evaluated via two speed sensors. In case of wheel-lock or wheel-spin, the set nominal value is modified. Provision has been made for the connection of two sensors to detect brake lining wear.

The axle modulator for the driving axle has an additional connection for a redundant pneumatic braking circuit. A two-way check valve on each side drives the higher pressure (electro-pneumatic or redundant) through to the brake cylinder.

The axle modulator for the additional axle does not have three two-way valve.



How it works:

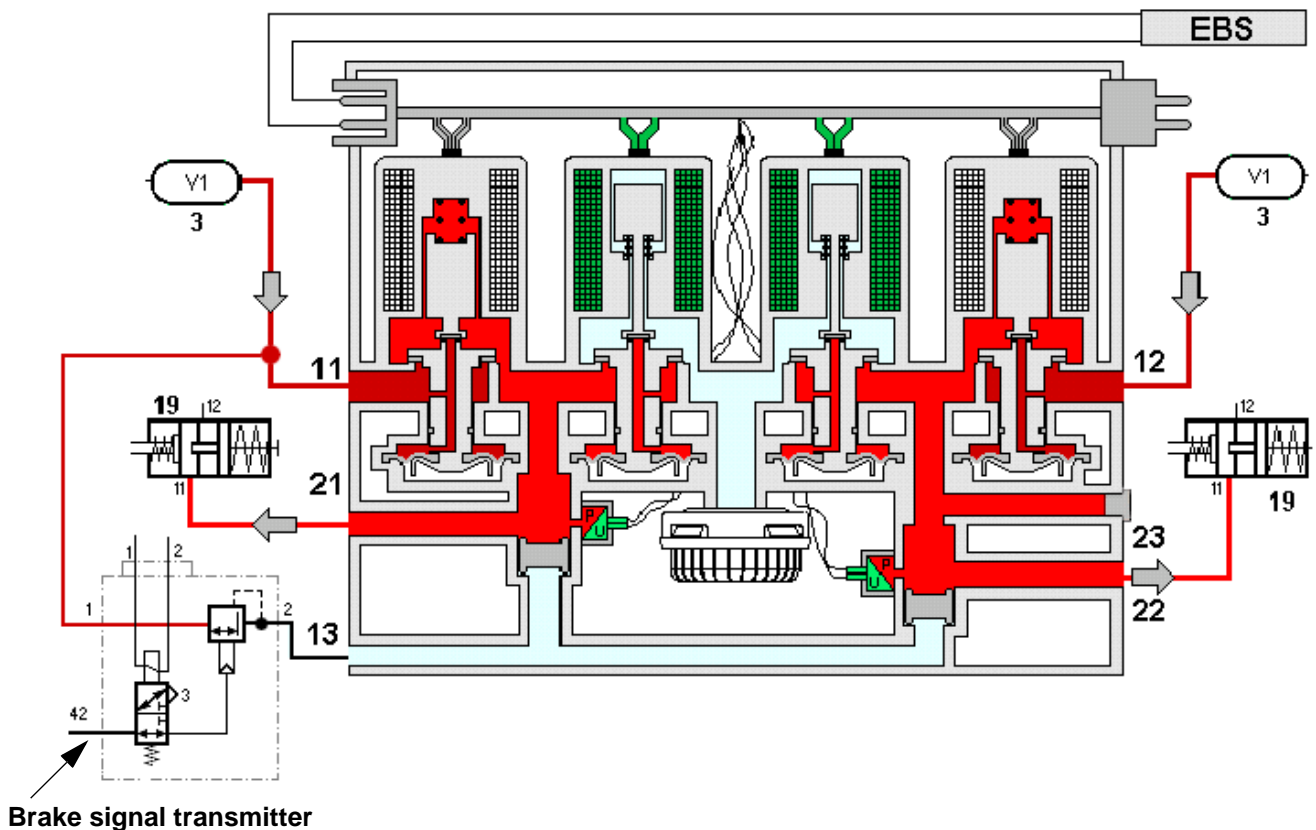

Function of the electro-pneumatic unit

The electro-pneumatic unit of the EBS system and its signal path work via

- ❑ **Brake signal transmitter**
two distance sensors determine the nominal value which is transmitted as pulse-width modulated signal; two integrated switches are used for nominal value confirmation, among others
- ❑ **EBS central module**
for determining the desired pressure for each axle, and system control
- ❑ **Proportional relay valve**
for pressure control on the front axle
- ❑ **ABS solenoid valves**
for the quick ABS pressure control cycles on the left and right wheel brakes of the front axle
- ❑ **3/2 relay valve**
for restraining the rear axle redundancy pressure
- ❑ **Axle modulators**
with integrated control unit for regulating brake pressures on each side of the rear axle(s).

EBS can be activated electrically via the driving switch (pin 15) or by actuating the brake signal transmitter via the integrated brake switches.

The measured brake pedal distance is interpreted as the desired delay and converted by the central module into desired pressure standards for the rear and front axle(s), using various criteria.

The nominal value standard for the axle modulators is transmitted by the central module via a central module. The axle modulators regulate and record the braking pressures of the rear axles' left and right wheel brake. The braking pressure of the front axle is regulated by the central module via the proportional relay valve with integrated pressure sensor.

The wheel rotation speeds are recorded via the sensors known to the ABS system and serve, among others, as input quality for the pressure control algorithms, for the ABS function and for the ASR function.

Before carrying out a wear control operation, the brake lining wear sensors analyse the brake lining wear on each wheel brake.

The sensor signals from the front axle are recorded by the central module whereas those from the rear axle are recorded by the axle modulators.

Signals are processed and errors monitored for the rear axles in the axle modulators, so that the sensor values can be subsequently transmitted to the central module via the data bus.

Function of pneumatic redundancy

Front and rear axle circuits work with different redundancy methods. The front axle circuit works according to the additional redundancy principle, the rear axle circuit is equipped with a redundancy unit which can be activated with a valve.

Additional redundancy on the front axle

The front axle circuit which functions pneumatically and serves as redundancy works via

- ❑ **Brake signal transmitter**
with 2 pneumatic circuits (front and rear axle)
- ❑ **Proportional relay valve**
relay valve with combined pre-control via pneumatic front axle circuit and the proportional solenoid valve

on the front axle brake cylinder.

Electro-pneumatic pressure is delivered via the proportional valve when the brake signal transmitter is activated. Depending on the control force, pressure is supplied to the proportional valve by the brake signal transmitter in a delayed, pneumatically redundant manner.

This is added to the pressure delivered already electro-pneumatically. The pressure delivered by the proportional valve is adjusted to the set desired pressure by varying the electro-pneumatic pressure.

In case of electro-pneumatic unit failure, the pneumatic pressure part alone affects the proportional valve which can be raised to p_{\max} by actuating the brake pedal further.

Due to the need to restrain the front axle redundant brake pressure vis-à-vis the electro-pneumatic pressure output (for instance, measures to optimise wear, or integration of endurance brake), the "electrical" nominal value predominates the pneumatic front axle pressure output on the brake signal transmitter (pneumatic dual circuit of the brake signal transmitter).

Rear axle redundancy

The pneumatic redundancy of the rear axle works via

- ❑ **Brake signal transmitter**
with 2 pneumatic circuits (front and rear axle)
- ❑ **3/2 relay valve**
with a 3/2 solenoid valve and a relay valve
- ❑ **Relay Valve**
for the additional axle
- ❑ **Shuttle valves**
integrated in the rear axle modulator

on the brake cylinder of the rear axle(s).

During hitch-free EBS operation, i.e. an electronic pressure control is possible on the rear axle, the 3/2 solenoid valve in the 3/2 relay valve is set to "switch off redundancy", due to the electronically controlled pressure.

Electrical / electronic structure

Power is supplied to the electronic braking system via two separate feed lines.

Clip 30a:

Power supply for the proportional relay valve and the ABS solenoid valve of the front axle and a brake signal transmitter circuit.

Clip 30b:

Power supply for the axle modulator(s), 3/2 relay valve, and the second circuit of the brake signal transmitter.

The central module has a data bus interface for communication with other vehicle systems (engine, gear system, retarder).

The axle modulator(s), ABS solenoid valve, and proportional relay valve of the front axle can be switched off individually via the short circuit-proof electronic switch in the central module.

The grounds for the external pressure and wear sensors are returned to the central module or axle modulator. Direct connection to the vehicle ground is not allowed.

Connection between the central module and the axle modulator(s) is established via an individual CAN system bus (brake bus).

The brake signal transmitter is separated electrically and has a dual circuit. The actuation process is recognised via two switches. The switches have the following functions:

- ❑ sensing the beginning of the braking process
- ❑ activating the EBS (if the driving switch is in the "off" position)
- ❑ the offset values of the nominal value sensors are calibrated and monitored without being activated

The inactivated distance sensors transmit the electrical brake nominal value as pulse-width modulated signals to the central module. Both signals of the redundant electrical transmitter are evaluated equally.

The braking pressure on the front axle is regulated with an electrically controlled proportional valve. The actual-pressure sensors are integrated into the valve subassemblies. The actual values are transmitted as analogue signals.

Axle load sensing is not required. The braking pressure on each axle is determined by a special braking force distribution function. The valves are actuated by the central module.

The EBS system status, for instance available errors, is transmitted by the EBS to a display unit via the vehicle bus (data line). Alternatively, the display can also take place via a red and a yellow warning light, as well as via an TCS light.

Potentiometers must be provided (or possibly alternative limit switches for drum brakes) for sensing brake lining wear, and which are read in for the front axle by the central module.

The activities of each rear axle wear sensor is recorded by the axle modulator; the results are transmitted via the system bus brake to the central module. The sensors are supplied individually and per axle with short circuit-proof 5V.

Control functions

Endurance brake integration

The braking system has an integrated brake management function which always regulates the endurance brake when the brake pedal is activated based on an optimum delay of the vehicle. Optimum service brake wear is attained through the distribution of endurance and service brake. This function is an important part of delay control. The integration of endurance brake can be deactivated via the switch.

Delay control

Delay control is used to adapt the braking pressure level to the driver's desired braking rate (def. As z in %).

When the same amount of pressure is applied on the pedal, the vehicle is often braked in the same manner, irrespective of the amount of load it is carrying.

If the coefficient of friction on a wheel brake changes (for instance when the vehicle is moving downhill), the delay control unit ends every adaptation process when a predefined, fixed maximum is attained, to enable the driver to also to feel the deterioration.

Adapting to the braking system hysteresis is also part of delay control. Each time the brake is released, the releasing process is chosen in such a way that an immediate braking force modification is adjusted. This function results in quick release of the brakes, i.e. car feeling.

Braking force distribution

The distribution of braking forces on the front and rear axles depends, among others, on the comparison made in the program range "Delay control" between the actual and nominal value of vehicle delay. The pressure on the front and rear axles is set in such a way that there is optimum braking pressure output on these axles.

Brake lining wear control

When the brake is applied partially, the braking pressure distribution is adjusted, notwithstanding the available wear signals, i.e. the detected wear difference. The pressure on the wheel brakes with more lining wear is reduced slightly, whereas the pressure on the wheel brakes with less lining wear is increased adequately, so that there is no change in the overall braking rate required by the driver.

The EBS contains the following renowned functions:

Anti-lock braking system (ABS)

The control logic determines from the wheel rotation speed whether one or more wheels can be blocked and decides whether to decrease, maintain, or increase the braking pressure on it. The rear axle wheels are controlled in their optimum area in a similar manner (individual control).

On roads with extremely different adhesion levels between the right and left sides, vehicles are uncontrollable or difficult to control using the different braking forces in ABS (yawing moment development).

As a result, the braking pressure on the front axle brakes is not adjusted independent of each other, so that the driver can have a steering reaction (modified individual control).

If the driving wheels are locked when the endurance brake is applied on low adhesion levels, possibly resulting in vehicle instability, the ABS endurance brake is deactivated via the vehicle's CAN bus to maintain vehicle stability.

Traction control system (TCS)

Just like in the ABS function, while the vehicle is in motion, the electronic control system determines whether the wheels are in the stable area of the μ slip curve. In case of wheel-spin, the engine output and/or driving axle wheel braking is adjusted by the axle modulator via the CAN bus and engine control system. An activated traction control system is displayed on the functions display.

Drag torque control

Drag torque occurs in the drive train due to actuation or change of gas. The resultant braking torque can lead to driving wheel locking and thus to vehicle instability. Drag torque control prevents this situation. When a slip state is exceeded, the engine torque increases and the brake torque is reduced, irrespective of the driving wheel velocity. The function of the traction control system ends when the driving wheel values become stable again.

Backup functions

Generating brake nominal value

The brake pedal distance measured by the sensors in the brake signal transmitter is transmitted to the central module where it is "processed". The distance is converted into a nominal delay, based on the characteristic curve described in the chart.

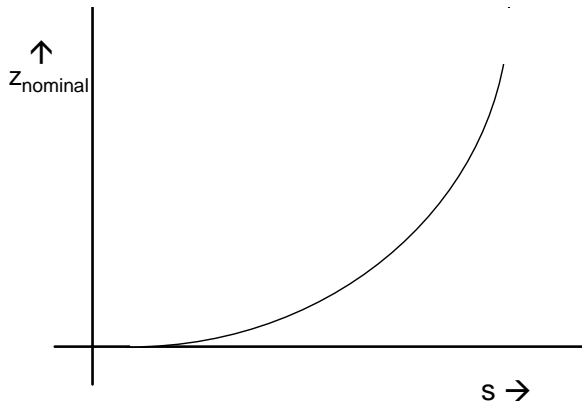

Determining the brake nominal value

Pressure control on the front and rear axles

The nominal pressure derived from the brake nominal value using the higher control algorithms is controlled in the front and rear axle's pressure control circuits. In order to improve the pressure control properties, the solenoid current in the solenoid valves are controlled.

Wheel speed sensing and wheel adjustment

Wheel speed sensing corresponds to the sensing function known to ABS. Automatic wheel adjustment makes up for the nominal wheel sizes and thus the rolling circumferences between the axles. If unacceptable wheel combinations are used, this is recognised as an error.

If the wheel sizes change, the system requires a change of parameters.

Halt brake, brake hold and release aid (Hill holder)

When the halt brake switch in the dashboard is activated, or if the door control unit so requires, the command "Activate halt brake" is transmitted to the central module via the CAN bus or the halt brake switch. This latter sends the command to the proportional relay valve and axle modulator(s), so that 2 bar braking pressure is exerted on the brake cylinder of the front and rear axle(s).

If the halt brake command is deactivated via the switch or via the door electronic unit, and then the driving pedal activated, the "halt brake" command is cancelled via the central module.

Failure diagnostics

Error recognition functions are used to avoid the effects of system failures and/or to inform the driver about functional problems. The error recognition principles correspond partly to those of a conventional ABS device (monitoring the ABS valves, the wheel speed sensors, the computer hardware).

On the other hand, a big part of the surveillance functions concerns EBS-specific functions (EBS-specific sensor analysis, EBS-specific solenoid control, braking pressure control, data transmission via CAN bus).

In addition to the wheel speed sensor signals, the EBS evaluates many other sensor signals and checks that these signals are error-free.

Nominal value sensing (sensors and switches)

The brake signal transmitter provides two sensor and two switch signals. The (pulse-width modulated) sensor signals are checked to see whether they conform with the authorised values, and for mutual deviations. The correctness of the (digital) switch signals are then tested.

Braking pressure sensing (on the front and rear axles)

The pressure sensor's (analogue) signals in the pressure control circuits are checked to see whether they correspond to the authorised values.

Note: The cabling for the two rear axle sensors is not accessible from outside, since it is an internal axle modulator cabling.

Wear sensing (on the front and rear axles)

The (analogue) signals from the wear sensors are checked to see whether they correspond to the admissible values.

The EBS monitors EBS-specific solenoid valve control.

Front axle proportional relay valve

The frequent solenoid (pressure proportional to the solenoid current) of the front axle proportional relay valve is checked to see whether control is carried out correctly.

Rear axle redundancy valve

The rear axle redundancy valve's solenoid switch is monitored to see that control takes place correctly.

Rear axle modulator's inlet and discharge valve

The rear axle's inlet and discharge valves are located inside the axle modulator. The solenoid cables are not accessible from outside.

The EBS monitors braking pressure control. The electrically controlled braking pressure and the pneumatically redundant pressure are also monitored.

Too low front axle braking pressure

The availability of minimum braking pressure (on the front axle at a certain solenoid current supply level) is checked.

Too high rear axle pressure deviation (from left to right)

In normal braking processes (neither ABS nor traction control system – TCS -controls) the measured braking pressure on the left and right sides of the rear axle must almost be equal. If the braking pressure deviation exceeds the admissible value, an error is reported.

Rear axle redundancy cannot be switched off

Normally, pneumatic redundancy pressure control in the rear axle is prevented by the redundancy valve. If an error makes this deactivation impossible, the rear axle braking pressure can no longer be reduced during ABS control, etc. (because there is inlet of non-ABS-compatible rear axle redundancy pressure into the rear axle brake cylinder). Error recognition takes place in this case.

EBS monitors data transmission

- between the EBS central module and the axle modulator (System bus)
- between the EBS and other system control devices (vehicle bus)

If communication is impossible or is suddenly cut, an error is reported.

Error display

Detected errors are transmitted by the EBS central module to the instrument panel display via the vehicle data bus, and displayed there.

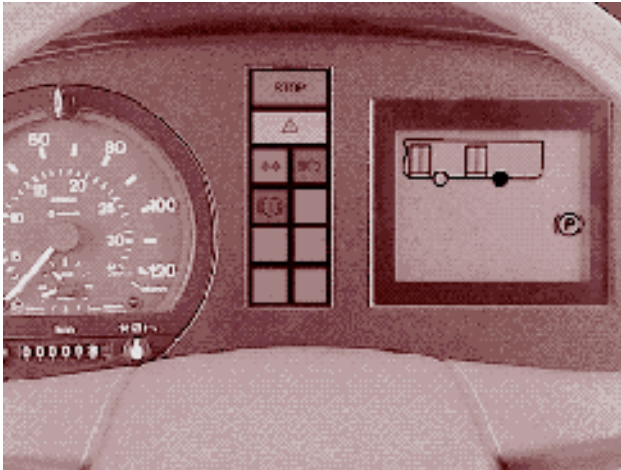

Alternatively, in vehicles without such a display, errors can also be reported via a red and a yellow warning light. A separate TCS light then indicates to the driver the on-going TCS control activities.

Red Wala: ⇨ system deactivated

Yellow Wala: ⇨ slight error:
e.g. sensor failure
(emergency mode)

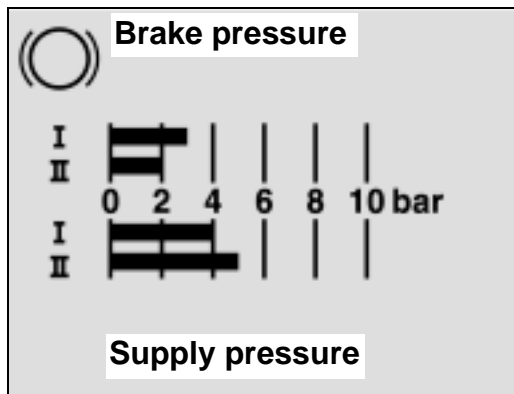

EBS "emergency modes"

As a rule, certain EBS functions are deactivated when an error is detected. Functions not impaired by the failure are maintained. For the EBS-drive with limited functions, the term emergency mode is used.

The following functions can be deactivated if an error occurs:

Operation without ABS function

The ABS function can be deactivated on a wheel, an axle, or the entire vehicle. Possible causes: faulty speed sensor signal, ABS valve error, etc.

Operation without ASR function

The traction control system can be switched off completely or partially. Complete deactivation means that both the braking system and the engine control unit are deactivated.

Partial deactivation means that only the braking system is deactivated. Possible causes: (faulty speed sensor signal, etc.)

Pressure control / auxiliary pressure control

Normally, braking pressure control requires braking pressure sensor signals. When these signals are no longer available, electrical braking pressure can be produced. In this case, we talk in terms of pressure control operation or auxiliary pressure control. However, the accuracy of this pressure production is limited, compared to hitch-free pressure control. Possible causes: Pressure sensor signal failure, etc.)

Redundancy operation

If electrical pressure control becomes impossible, the corresponding axle is braked with the help of the pneumatic redundancy pressure. Possible causes: damaged solenoid, or faulty solenoid cabling, etc.)

EBS test types

The following peculiarities must be observed while testing the electronically controlled braking system:

❑ Maximum pressure level control:

When the brake is applied > 80% of the pedal distance and ignition off, the full pressure works on the front and rear axles.

❑ Roller dynamometer test: (Roller dynamometer function)

A roller dynamometer function was integrated into the EBS electronic unit so that an electronically braked KOM can be tested on a roller dynamometer. This function is used to test the braking pressure at full load (permitted total weight).

The roller dynamometer function is activated if the EBS is not switched on via the ignition (class 15) when the vehicle is braked again, but rather through activation of the brake signal transmitter via the integrated brake switches. The front axle and/or rear axle speed must be < 3 km/h.

Special EBS controls such as endurance brake integration, delay control and brake lining wear control are not active when the roller dynamometer function is active.

The maximum braking pressure can now be measured. The EBS is working correctly if the measured braking pressure corresponds to the basic loaded vehicle design.

WABCO Diagnosis equipment - see: brochure 820 001 029 3



Diagnostic Software

In addition to the familiar diagnosis equipment like WABCO Compact Tester or the Diagnostic Controller with program cards, WABCO also offers PC diagnosis.

For all newly integrated WABCO systems such as EBS, the Diagnostic Software for diagnosis with PCs is offered in addition to the program card for the Diagnostic Controller.

The software offers comprehensive and convenient diagnosis. The program and interface are compatible with **any standard PC or Laptop** with the following characteristics:

Hardware Requirements

The following hardware is required:

- notebook / laptop wherever possible
- Pentium PC and higher
- 16 MB main memory, colour display 800x600
- approx. 10 MB free hard disk memory
- 3 ½" floppy disk drive
- 1 COM interface (9-pin) for the diagnostic interface
- Win95/98/2000, WIN NT

Diagnosis Interface

For establishing diagnosis with the control unit, WABCO Diagnostic Interface Set, Part No. 446 301 021 0 is required.

The set contains the interface and a connecting cable to the PC/laptop (for the COM interface, 9-pin connection).

The vehicle connection on the interface is similar to the connection for the Diagnostic Controller, permitting the continued use of connecting cables used in the past.



Diagnostic equipment - WABCO EBS

EBS "EPB" (DaimlerChrysler)



Diagnostic cable

Diagnostic software EPB "ACTROS / ATEGO"	446 301 517 0 for PC diagnosis
Diagnostic Interface	446 301 021 0 for PC-Diagnostic
Program card EPB "ACTROS / ATEGO"	446 300 760 0 (D)
Program card EBS CITARO	446 300 766 0 (D)
Diagnostic cable	446 300 340 0

EBS Euro (Motor Vehicle)



Diagnostic cable

Diagnostic software EBS	446 301 548 0 for PC diagnosis
Diagnostic Interface	446 301 021 0 for PC-Diagnostic
Program card EBS Euro	446 300 769 0 (D)
Diagnostic cable	446 300 344 0

Start monitor PC Diagnosis EBS Euro:

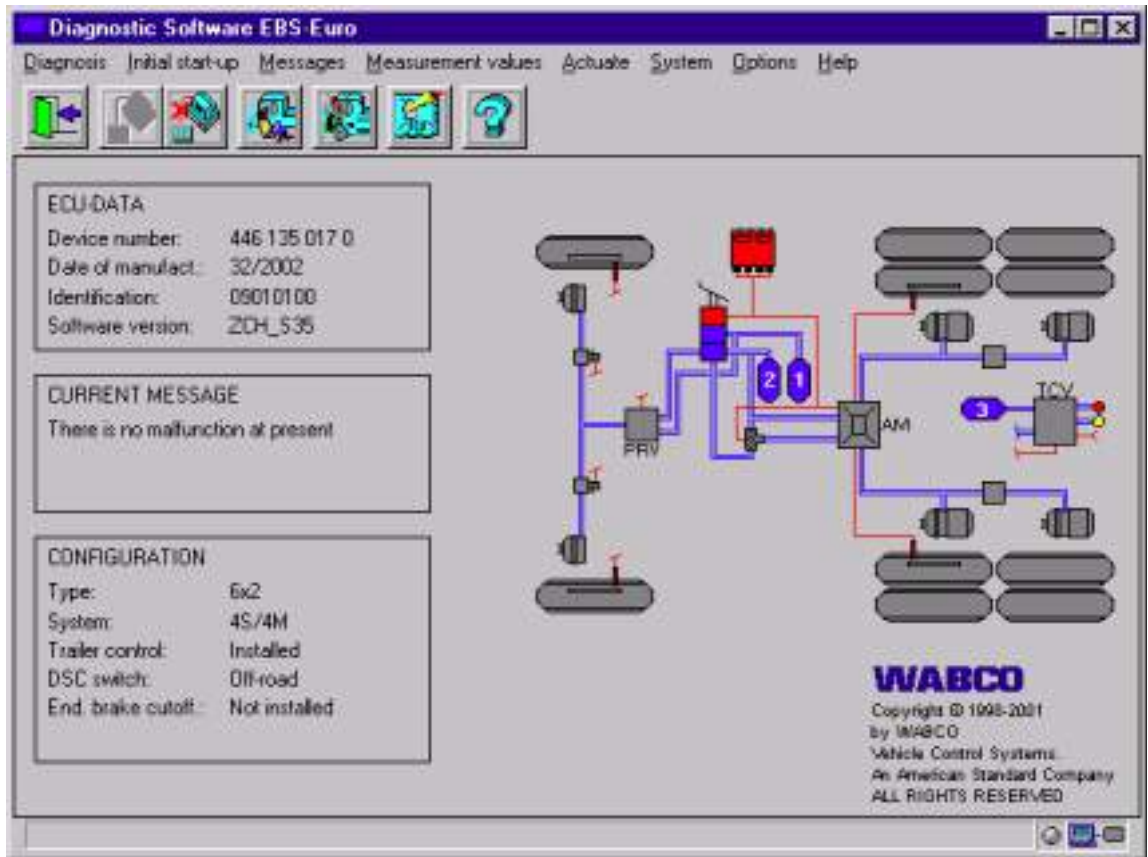

Read out diagnosis memory:

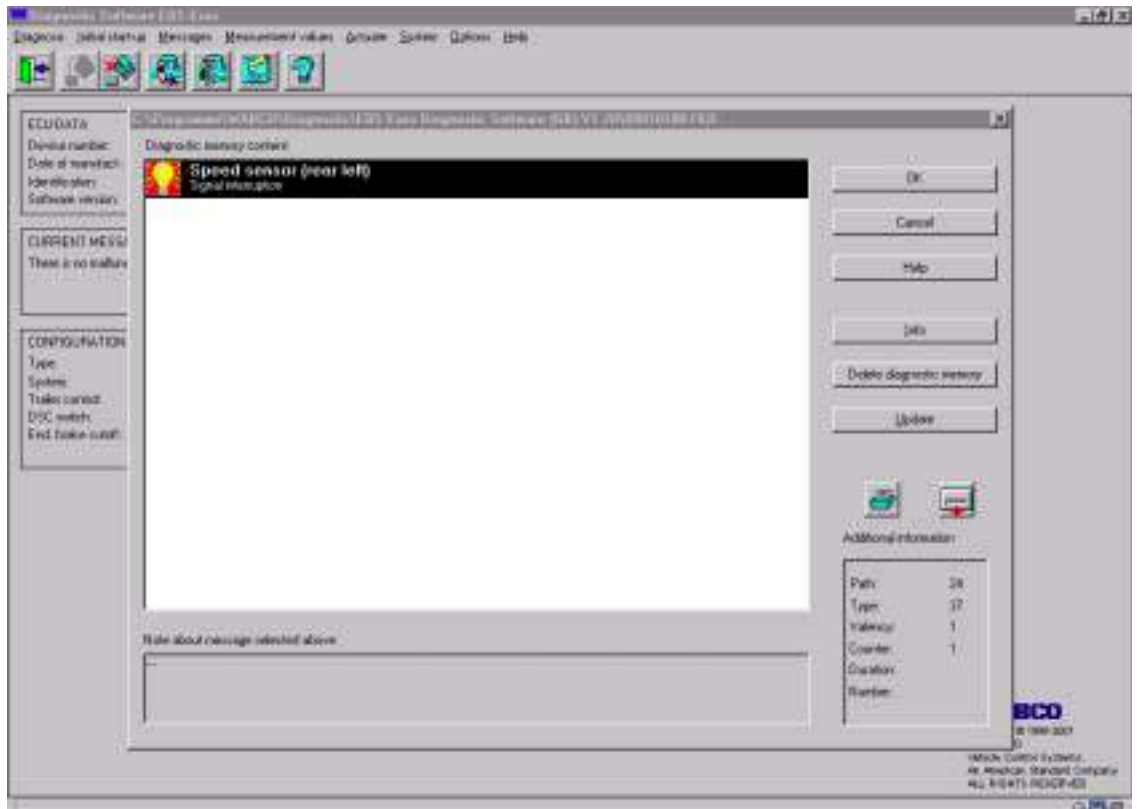

Reading out measured values: Pressure sensors

The 'Pressure sensors' window displays the following data:

Sensor	actual pressure	desired pressure
FA	6.88 bar	6.88 bar
RA right	4.85 bar	4.96 bar
AA right		
Trailer control valve	0.00 bar	0.00 bar
RA left	5.00 bar	4.96 bar
AA left		

Reading out measured values: Wear values

The 'Brake lining wear' window displays the following data:

Sensor	Wear value
Brake lining FA right	51.60 %
Brake lining RA right	52.00 %
Brake lining AA right	
Brake lining FA left	51.60 %
Brake lining RA left	51.60 %
Brake lining AA left	

Reading out measured values: Speed sensors

Wheel sensors [?] [X]

	Wheel sensor FA right	Wheel sensor RA right	Wheel sensor AA right
v	0 km/h	2.12 km/h	km/h
U V	0.50 V	V
Umax V V	V
Umin V V	V
Umax/Umin			

	Wheel sensor FA left	Wheel sensor RA left	Wheel sensor AA left
v	0 km/h	0 km/h	km/h
U V V	V
Umax V V	V
Umin V V	V
Umax/Umin			

OK Help

Reading out measured values: Brake signal transmitters

Brake signal transmitter [?] [X]

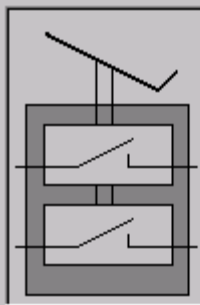

Signal 1	1507.18 uS
Signal 2	1521.92 uS
<hr/>	
Brake signal	49.49 %
Desired deceleration	26.98 %

OK Help

Selection menu Control:

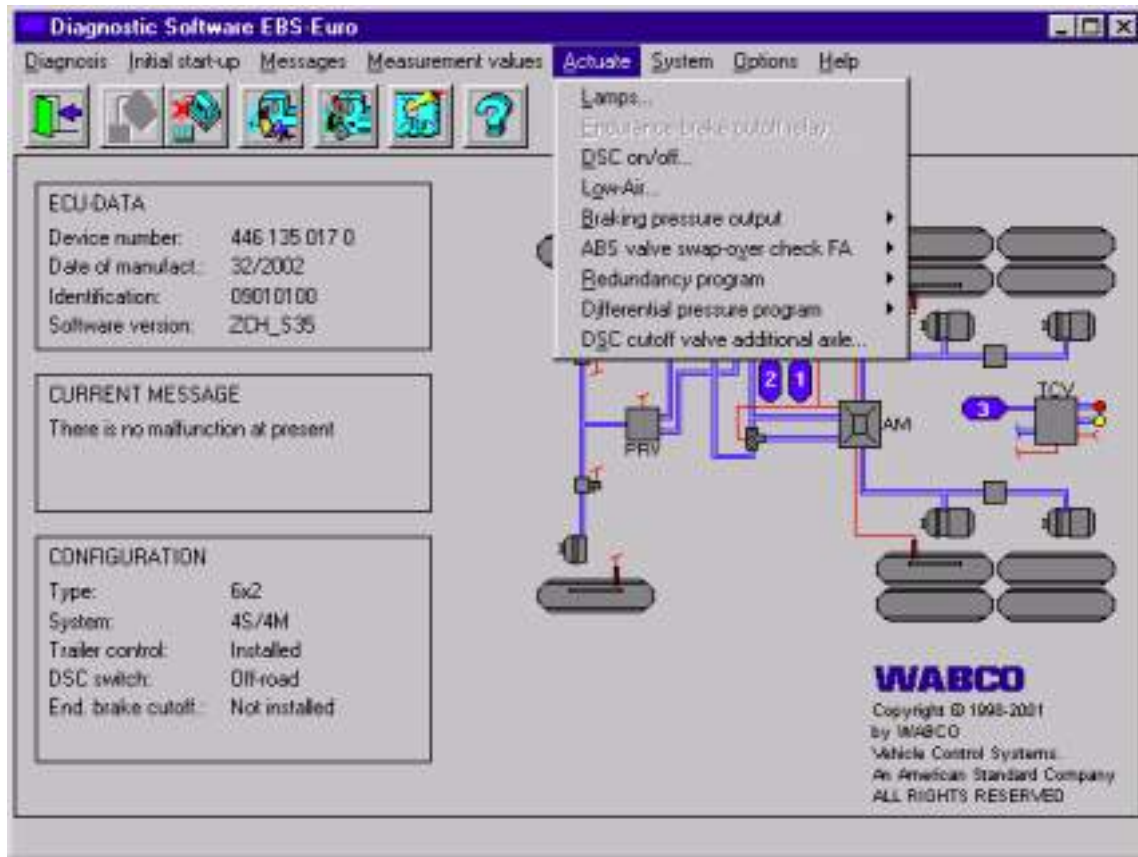

Control: Braking pressure control on front axle

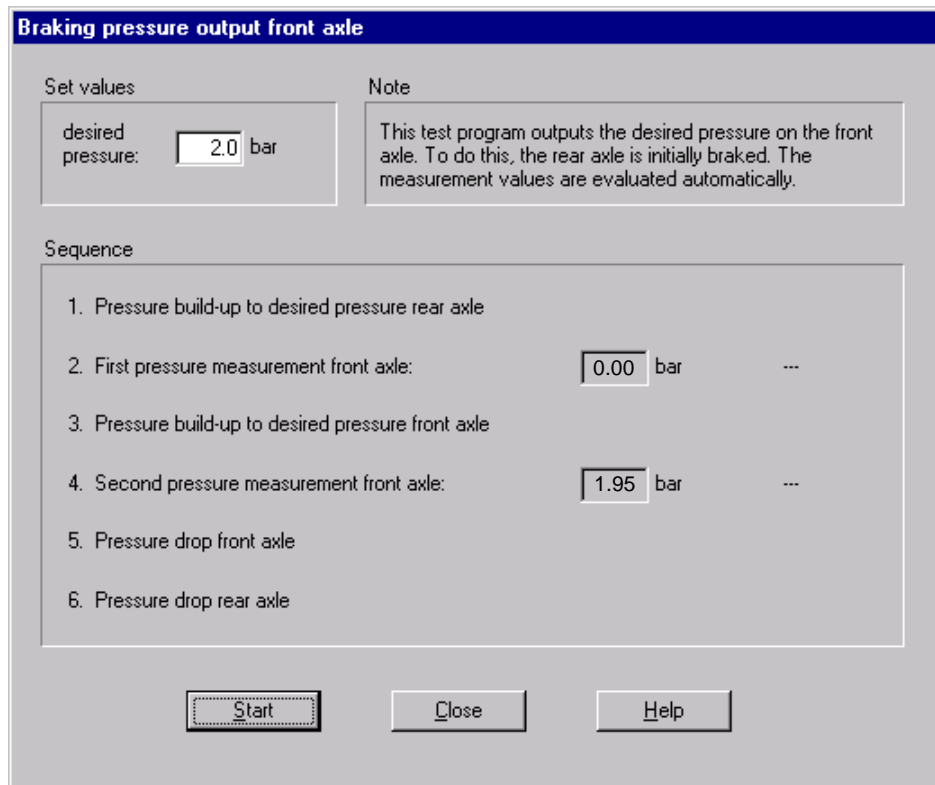

Start-up:

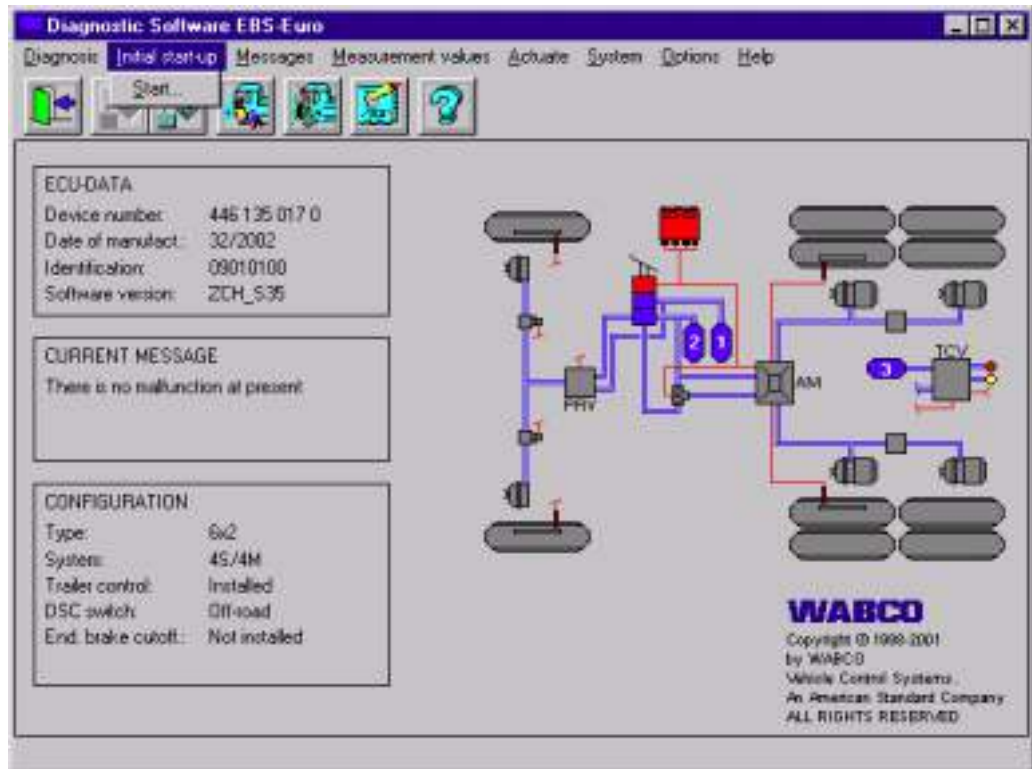

Pressure possibility Start-up protocol:

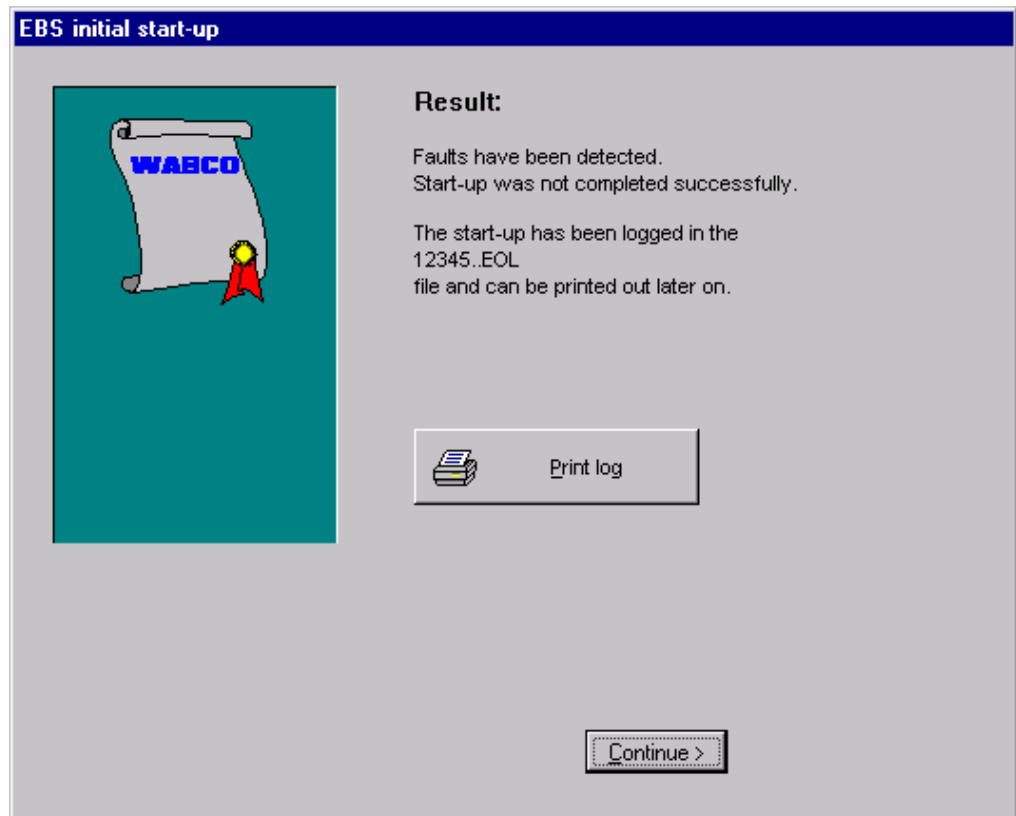

EBS parameter: Input mask No. 1

EBS parameter #1

Systems

1. Vehicle type: 6x2

2. EBS system: 4S/4M

DSC

3. DSC installed

4. DSC type of switch: DSC switch

5. DSC switch function: Diff-road

Wear sensing

6. Closed-loop wear control

7. Wear sensors installed

8. DV₁₅ / DV₁₅ * : 100 dec

9. DV₂ 15 * : dec

10. Control gain * : dec

11. Warning lamp, wear sensors installed

12. [Parameter description]

Other components

13. Endurance brake cutoff relay installed

14. Endurance brake integration

15. Endurance brake integration mode: [dropdown]

16. Trailer control

17. Pressure pulse: 200 dec

18. Pneumatic redundancy rear axle

19. [Parameter description]

20. Pressure supply AA: [dropdown]

Tire circumstances

21. Front axle: 3125 mm

22. Rear axle: 3125 mm

23. Auxiliary axle: mm

* Only change values to specifications issued by WABCO or the vehicle manufacturer

Buttons: Load from PC, Load from ECU, Continue >>, OK, Cancel, Help

EBS parameter: Input mask No. 2

EBS parameter #2

Settings

24. Display ECE-R 13 memory fault

25. Drag torque control enabled

26. Extended ABS control enabled

27. AZ 1 * : 127 dec

28. AZ 2 * : dec

29. AZ 3 * : dec

30. RBV / RBV1 * : 100 dec

31. RBV2 * : dec

32. AV / AV1 * : 100 dec

33. AV2 * : dec

34. Axle ratio: 3.20

35. Resp. pressure FA: 500 mbar

36. Resp. pressure RA: 500 mbar

37. Resp. pressure AA: mbar

SAE J1939

38. SAE J1939 monitoring enabled

39. Repeat rate EBC1: [dropdown] ms

40. Repeat rate EBC2: [dropdown] ms

No. of pole wheel teeth

41. Front axle: 100

42. Rear axle: 100

43. Auxiliary axle: [dropdown]

Warning lamps

44. DSC lamp installed

45. Yellow warning lamp installed

46. Red warning lamp installed

Bus-stop brake

47. [Parameter description]

48. Dec. pres. BSB FA: mbar

49. Dec. pres. BSB RA: mbar

50. Dec. pres. BSB AA/TCV: mbar

51. BSB limit speed: km/h

Retarder control

52. Retarder gain * : dec

53. Max. gear ratio * : dec

54. Z-Soll-Rück * : dec

55. V-Soll-Rück * : dec

* Only change values to specifications issued by WABCO or the vehicle manufacturer

Buttons: Save to PC, Save to ECU, Print parameters, Parameter sticker, << Back, OK, Cancel, Help

Pressure options

The screenshot displays the 'Diagnostic Software EBS-Euro' application window. The interface includes a menu bar with options: **Diagnosis**, **Initial start-up**, **Messages**, **Measurement values**, **Actuals**, **System**, **Options**, and **Help**. Below the menu bar are several icons, including a question mark. A dropdown menu is open under the 'Diagnosis' menu, showing options: **Interrupt**, **Print**, **End** (with **Alt+F4** shortcut), **Diagnostic messages...**, **Parameter...**, and **Initial start-up...**.

On the left side, there are three informational panels:

- Date of manufact.:** 32/2002
- Identification:** 09010100
- Software version:** ZDH_S35

The **CURRENT MESSAGE** panel displays: "There is no malfunction at present".

The **CONFIGURATION** panel lists the following settings:

Type:	6x2
System:	4S/4M
Trailer control:	Installed
DSC switch:	Off-road
End brake cutoff:	Not installed

The main area of the window features a detailed hydraulic system diagram. It shows a central hydraulic pump (red) connected to various components including a pressure relief valve (PRV), a control valve (AM), and a trailer control valve (TCV). The diagram also illustrates the hydraulic lines leading to the front and rear wheel cylinders. Three blue circles with numbers 1, 2, and 3 are overlaid on the diagram, indicating specific pressure measurement points. The WABCO logo and copyright information are visible in the bottom right corner of the diagram area.

WABCO
Copyright © 1999-2001
by WABCO
Vehicle Control Systems.
An American Standard Company
ALL RIGHTS RESERVED

Parameter meaning:**System****Vehicle type**

This parameter indicates vehicle type and affects system configuration.

EBS system:

Indicates the EBS system design.

ASR**ASR integrated:**

ASR function is permanently activated if this checkbox is ticked.

ASR switch type:

You can indicate here whether a switch (in both positions) or a push-button is fitted.

ASR switch function:

You can choose here whether the ASR off-road function should be activated, or the ASR function deactivated when the ASR off-road switch is activated.

Wear sensing**Wear control:**

If this parameter is not activated, only wear control will be possible, irrespective of whether or not sensors are integrated.

Wear sensors present:

If wear sensors are fitted on the front and rear axles and must be evaluated, this checkbox must be ticked. Standard setting: "Wear sensors present".

DV1_15 and DV2_15:

Basic braking pressure settings: VA to HA or HA to ZA in

the wear area. The value should only be changed according to the specifications of the vehicle manufacturer, or by WABCO. These parameters do not apply if sensors are integrated, and control is active.

Warning light fitted with wear sensors:

If this checkbox is ticked, a warning light or a relay for switching wear display is monitored.

Start check for warning light wear sensors:

If this checkbox is ticked, the warning light for wear display is activated during start check.

Other components**Endurance brake cut-off relay present:**

If this checkbox is ticked, an endurance brake cut-off relay is controlled and monitored.

Cut-off of Endurance Brake Integration (EBI):

Endurance brake integration is activated if the "Endurance Brake Integration" checkbox is ticked.

Endurance Brake Integration (EBI) mode:

This parameter is used to adjust the EBI to the city or tourist coach driving profile. The available vehicle type parameter settings should only be changed with the consent of the vehicle manufacturer, or by WABCO.

Trailer control valve present:

If this checkbox is ticked, a trailer control valve is controlled and monitored.

Tire circumferences:

The rolling circumference of the tire equipment must be entered here according to the vehicle manufacturer or tire equipment manufacturer's specifications. Permitted values for Pole wheel 100Z is 2550 to 3850, step size 25 mm. Difference between parameter value and tire circumference: maximum 5%.

Settings:**Display ECE R13 Memory error:**

If this checkbox is ticked, the error memory bit required in ECE R13 are displayed when certain errors occur.

Drag torque control released:

Drag torque control is released if this checkbox is ticked.

Extended ABS control released:

Extended ABS control is released if this checkbox is ticked.

AZ1:

This parameter is used to coordinate braking force distribution. The value should only be changed according to the specifications of the vehicle manufacturer, or by WABCO.

BV1 and RBV2:

This parameter is used to coordinate braking force distribution. The value should only be changed according to the specifications of the vehicle manufacturer, or by WABCO.

AV1 and AV2:

This parameter is used to coordinate braking force distribution. The value should only be changed according to the specifications of the vehicle manufacturer, or by WABCO.

Retarder inclination:

This parameter is used to coordinate braking force distribution. The value should only be changed according to the specifications of the vehicle manufacturer, or by WABCO.

I-Getriebe:

This parameter is used to coordinate braking force distribution. The value should only be changed according to the specifications of the vehicle manufacturer, or by WABCO.

Z-soll-Rück:

This parameter is used to coordinate braking force distribution. The value should only be changed according to the specifications of the vehicle manufacturer, or by WABCO.

V-Start-Rück

This parameter is used to coordinate braking force distribution. The value should only be changed according to the specifications of the vehicle manufacturer, or by WABCO.

Light ASR integrated:

This parameter indicates that the warning light is directly controlled by the EBS control device, and that the exit is monitored. Alternatively, the information can be evaluated on the SAE bus.

Yellow warning light present:

This parameter indicates that the warning light is directly controlled by the EBS control device, and that the exit is monitored. Alternatively, the warning light information can be evaluated on the SAE bus.

Red warning light present:

This parameter indicates that the warning light is directly controlled by the EBS control device, and that the exit is monitored. Alternatively, the information can be evaluated on the SAE bus.

Deactivate roller lock / halt brake:

This parameter is used to lock both functions.

Nominal pressure HSB VA, HA and ZA:

The nominal pressure for the halt brake and roller lock of the front axle, rear axle, and possibly of the additional axle is entered here. The value should only be changed according to the specifications of the vehicle manufacturer, or by WABCO.

Parameter value x 0.05 bar = nominal pressure.

Limit speed HSB:

The halt brake and roller lock are not activated by the EBS if the preset maximum speed is exceeded.

Axle ratio:

The ratio i of the driving axle control must be entered here as specified by the vehicle manufacturer. The value entered is ratio $i \times 25$.

Response pressure VA, HA, ZA:

The response pressure of the front axle, rear axle, and possibly additional axle must be entered here. The value should only be changed according to the specifications of the vehicle manufacturer, or by WABCO. Parameter value $\times 0.05$ bar = response pressure.

SAE J1939

SAE J1939 monitoring released:

Communication on the SAE J1939 data bus is monitored if this checkbox is ticked.

Repeat rate EBC1:

The repeat rate for EBC1 messages can be chosen here. Only the values 20ms or 100ms are supported. The value should only be changed according to the specifications of the vehicle manufacturer.

Repeat rate EBC2:

The repeat rate for EBC2 messages can be chosen here. The values 20 ms, 50ms or 100ms are supported. The value should only be changed according to the specifications of the vehicle manufacturer.

Pole wheel teeth number

Front axle, rear axle, and additional axle:

The Pole wheel teeth number can be entered here for speed sensing on the corresponding axle. At the moment only the value "100" is released.