

Mercedes-Benz Truck

Spare parts and accessories



Spare parts to fit:

- Actros
- Axor
- Atego



Vehicle identification

The model overview and the vehicle type designations given with the parts on the catalogue pages help in finding the specific vehicle application. For many items, the exact use depends on the model.

To uniquely identify a part, please contact your EUROPART subsidiary with the complete Vehicle Identification Number (VIN) or use the vehicle part search in our EWOS.

Breakdown of the Mercedes-Benz VIN

WDB 930205 1 L689656

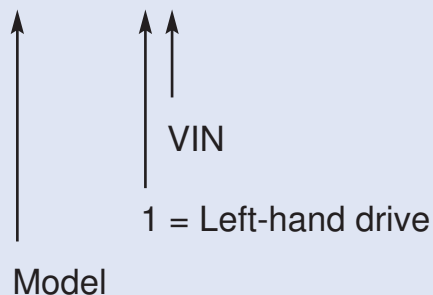

VIN



VIN plate



Classification of series and model

■ Actros I	(1996-)	950, 952, 953, 954
■ Actros MP2	(2003-)	930, 932, 933, 934, 950, 954
■ Actros MP3	(2008-)	930, 932, 933, 934, 950, 954

■ Axor I	(2001-)	375, 944
■ Axor II	(2004-)	374, 940, 942, 943, 944, 950, 958
■ Axor III	(2011-)	940, 942, 943, 944, 950, 958

■ Atego I	(1998-)	375, 957, 970, 972, 974, 975, 976
■ Atego II	(2004-)	375, 957, 958, 970, 972, 974, 975, 976
■ Atego III	(2011-)	375, 957, 958, 970, 972, 974, 975, 976

EUROPART® – a powerful brand

Alongside well-known manufacturer's brands, EUROPART also offers a strong assortment of its own-brand products with more than 5000 items from the various EUROPART ranges.

Top quality at a fair price.

Your advantages:

- Low-cost alternative for OE standard
- Maximum availability at 200 locations in 28 countries
- Increase your competitiveness
- Consistent service package



Commercial vehicle diagnosis? Best go straight to EUROPART!

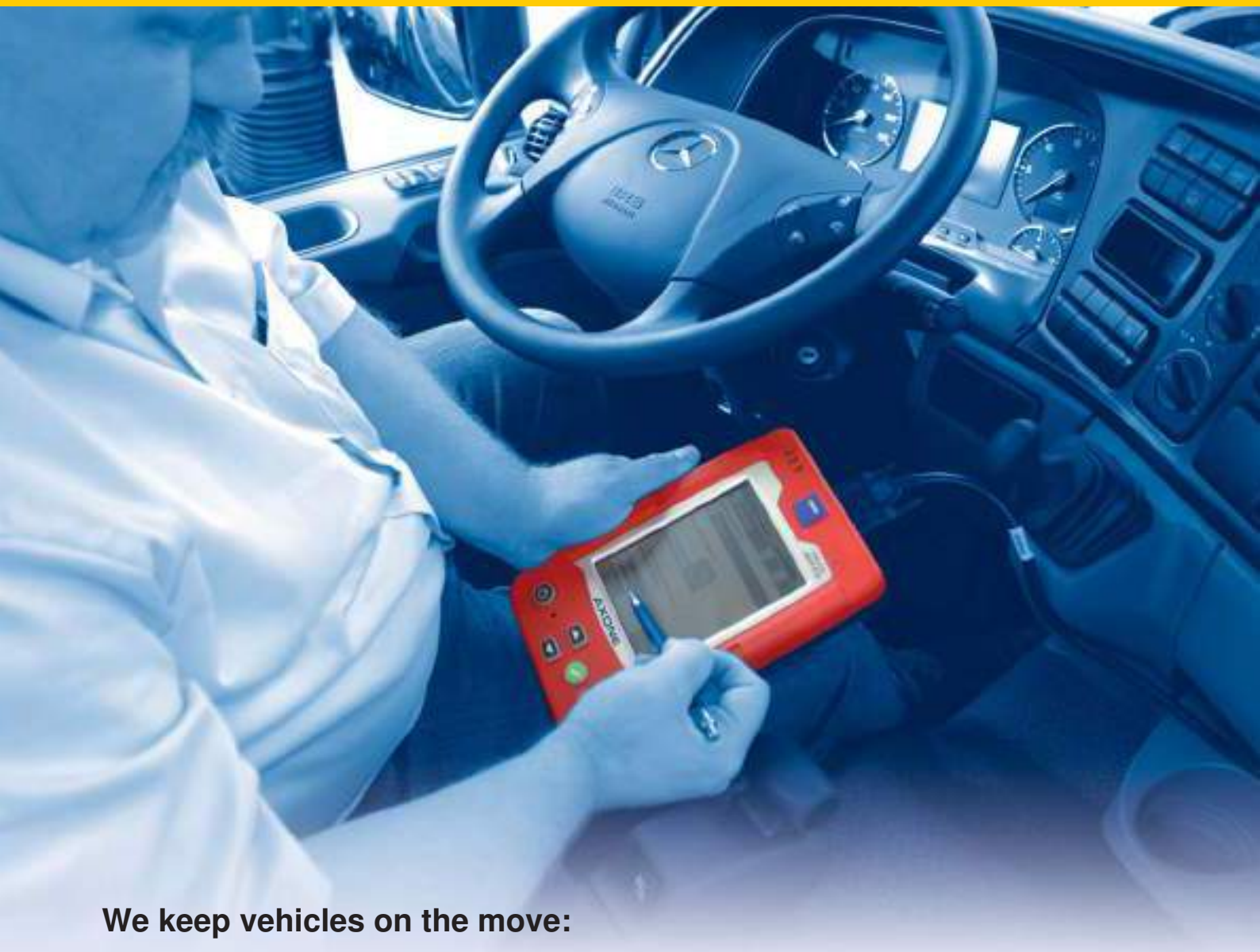

We keep vehicles on the move:

Across-brand diagnostic equipment for tractor units, trailers, semi-trailers, agricultural vehicles, vans, cars and buses

- Test and Diagnosis Technology
- Brakes/Axle Service
- Engines/Gearboxes
- Air suspension
and much more



More information from:

www.europart.net

Meet your objectives with the right technology!



The AXONE product line
Hand-held diagnostic unit for all vehicle categories

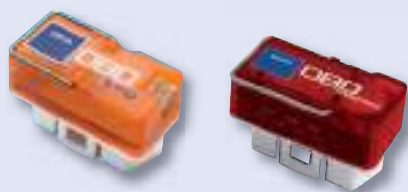

OBD Log and OBD MATRIX
Modern wireless exhaust gas measurement on petrol and diesel engines



TEXA IDC4 universal software for control of all TEXA workshop equipment



KONFORT
Air conditioning service units for R134a and R1234yf



AUTOPOWER exhaust gas measuring equipment
Modern wireless exhaust gas measurement on petrol and diesel engines



UNIPROBE
Measurement module with 4-channel oscilloscope, multimeter, CAN-BUS readings, etc.



The EUROPART partner for diagnosis in the workshop



NAVIGATOR TXT
Diagnostic interface for PC

Fly your banners. The workshop concept from EUROPART!



Become part of a country-wide specialist network.

Your advantages:

- Workshop network in Germany
- Effective marketing concepts!
- Technical information and Hotline
- Modern diagnostic equipment and assured parts supply
- ISO certification possible if required
- No system charges for low sales volume

Become a partner now!

info@trailer-station.net

info@truck-station.net

info@transporter-station.de

Actros

1

Axor

2

Atego

3

Technical equipment and accessories

4

Actros



Engine	4-19
Drive	20-27
Suspension	28-33
Axle and steering.....	34-45
Braking system	46-51
Pneumatic system	52-69
Lighting and electrics.....	70-87
Bodywork.....	88-101
Driver's cab.....	102-123
Truck styling.....	124-129



Engine bearing

Vehicle type	Actros I/MP2/MP3
Installation location	front and rear
Width	230 mm
Thickness	130 mm
Inner thread	M18 x 1.5

Order number	Comparative number
1911 045 199	Mercedes-Benz 941 241 51 13
1911 045 206	Mercedes-Benz 941 241 58 13
1911 045 205	Mercedes-Benz 941 241 77 13



Engine piston

other versions possible

Vehicle type	Motor type	Order number
Actros I/MP2/MP3	e.g. OM 501, OM 502 EURO 3	1911 001 042
Actros MP2	e.g. OM 501, OM 502 EURO 5	1910 037 336



Crankcase seal set

Vehicle type	Actros I/MP2/MP3
Motor type	e.g. OM 501, OM 502

Scope of supply

without oil pan seal and cylinder liner sealing rings

Order number
8002 045 984



Cylinder head gasket set

Vehicle type	Actros I/MP2/MP3
Version	for one cylinder head

Motor type	Order number
e.g. OM 501, OM 502 (up to engine no. 084423)	8022 341 900
e.g. OM 501, OM 502 (from engine no. 084424-155295)	8002 535 424
e.g. OM 501, OM 502 (from engine no. 155296-357748)	8002 000 118
e.g. OM 501, OM 502 (from engine no. 357749)	8002 290 400



Cylinder head repair kit

Vehicle type Actros I/MP2/MP3

Scope of supply

with cylinder head bolts and exhaust manifold bolts

Motor type

e.g. OM 501, OM 502 (up to engine no. 357748),
optionally with 8022341900, 8002535424, 8002000118
e.g. OM 501, OM 502 (from engine no. 357749),
optionally with 8002290400

Order number

8002 045 419

8002 043 163



Cylinder head screw set

Vehicle type Actros I/MP2/MP3

Motor type e.g. OM 501, OM 502

Version external multi-tooth

Thread M18 x 2

Length 210 mm

Contents

4-piece

Order number

8002 206 801



Dichtungssätze (Noll-, Zylinderkopf- und Spezialsätze) +++ Zylinderkopfschrauben +++ Ventiltrieb-dichtungssätze +++ Turbolader-
einbausätze +++ Radial-Wellendichtungen +++ Dichtungsmaterialien +++ Reparatur-Kits +++
Dichtmassen +++ Dichtungsentferner

VICTOR REINZ
Inside Mercedes-Benz



VICTOR REINZ

Sealing Products



Cylinder liner

Vehicle type Actros I/MP2/MP3

other versions possible

Motor type	Order number
e.g. OM 501, OM 502 EURO 3	1911 030 677
e.g. OM 501, OM 502 EURO 5	1910 034 700

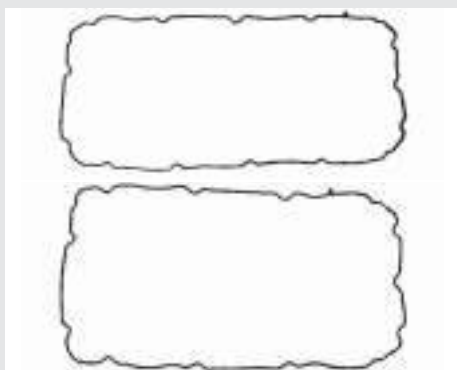

Oil pan gasket

Vehicle type Actros I/MP2/MP3

Version for plastic oil pan

Motor type	Order number
e.g. OM 501 (from engine no. 012091)	8002 532 585
e.g. OM 502 (from engine no. 012091)	8002 532 584



Oil pan gasket

Vehicle type Actros I/MP2

Version for aluminium oil pan

Motor type	Order number
e.g. OM 501 (up to engine no. 012090)	8002 534 671
e.g. OM 502 (up to engine no. 012090)	8002 534 672



Valve cover gasket

Vehicle type Actros I/MP2/MP3

Motor type	Order number
e.g. OM 501, OM 502 (up to engine no. 084423)	8022 500 132
e.g. OM 501, OM 502 (from engine no. 084424-155295)	8002 711 420
e.g. OM 501, OM 502 (from engine no. 155296), for plastic valve cover	8002 533 431



Oil pressure sensor

Vehicle type Actros I/MP2/MP3

Motor type e.g. OM 904 LA, OM 906 LA

Thread M16 x 1.5

Connection metric

Version	Order number
without warning contact	9465 420 517
with warning contact	(on request) 9461 534 928

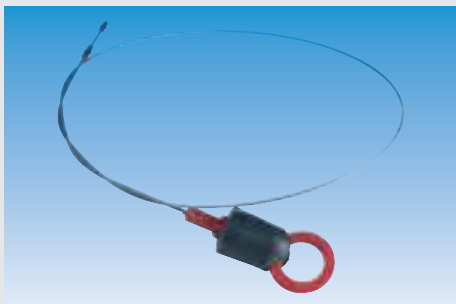

Dipstick

Vehicle type	Actros I/MP2/MP3
Motor type	e.g. OM 501, OM 502
Length	106 mm

Order number
9460 101 072



Repair kit

air compressor

Vehicle type	Actros I/MP2/MP3
Inner diameter	100 mm

Scope of supply

cylinder liner, seal, piston

Order number
1911 010 313

Accessories

Description

Gasket set for lamella valve

Order number
9460 006 669



Oil separator

for crankshaft housing ventilation

Vehicle type	Actros MP2/MP3
Version	with sealing ring

Order number
9750 050 005

Accessories

Description

Gasket set (from engine no. 089132)

Order number
9740 050 002



Fuel pump

Vehicle type	Actros I/MP2/MP3
Version	with fuel pre-filter

Order number
9020 100 350

Service parts

Description

Fuel filter housing

Order number
9460 000 400



Oil filter

Vehicle type	Actros I/MP2/MP3
External diameter	113 mm
Inner diameter	45.4 mm
Height	312.5 mm

Order number
9020 121 400

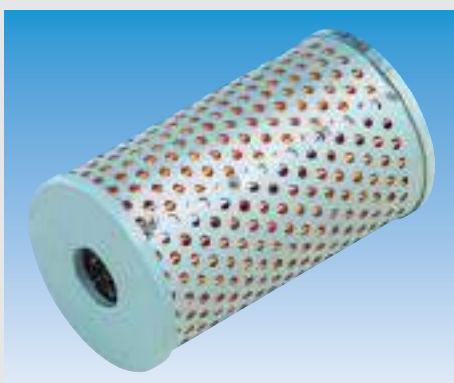

Hydraulic filter

Vehicle type	Actros I/MP2/MP3
External diameter	60 mm
Inner diameter	18/18 mm
Height	100.5 mm

Order number
9025 503 090



Fuel filter

Vehicle type	Actros I/MP2/MP3
External diameter	95 mm
Inner diameter	46 mm
Height	204.7 mm

Order number
9020 009 991



Air filter

Vehicle type	Actros I/MP2/MP3
--------------	------------------

Dimensions mm	Order number
Ø 420 x Height 263	9020 421 404
Ø 420 x Height 317	9024 217 290
Ø 267 x Height 533	9022 713 201
Ø 327 x Height 483	9020 331 840
Ø 281.5 x Height 406	9022 912 191
Length 626 x Width 564 x Height 78	9020 641 510
Ø 243 x Height 498	9020 007 030

(Illustration similar)



Oil filter

Vehicle type	Actros I
External diameter	200 mm
Inner diameter	27/27 mm
Height	255 mm

Order number
9750 103 901

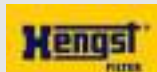

Oil filter

Vehicle type	Actros MP2/MP3
External diameter	120.5 mm
Inner diameter	50 mm
Height	271.5 mm

Order number
9750 103 657

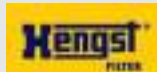

Hydraulic filter

Vehicle type	Actros I/MP2/MP3
External diameter	58 mm
Inner diameter	18/18 mm
Height	149 mm

Order number
9750 103 841

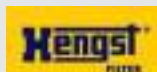
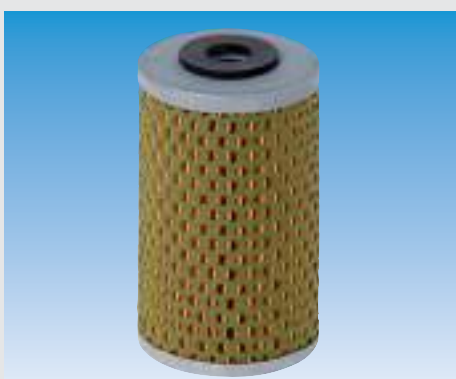

Hydraulic filter

Vehicle type	Actros I/MP2/MP3
External diameter	59 mm
Inner diameter	15.5 mm
Height	104 mm

Order number
9750 103 779



Fuel filter

Vehicle type	Actros I/MP2/MP3
External diameter	44 mm
Inner diameter	24 mm
Height	80 mm

Order number
9750 230 365

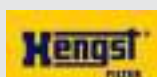

Fuel filter

Vehicle type	Actros I/MP2/MP3
External diameter	107.5 mm
Height	219 mm

Order number
9750 104 510

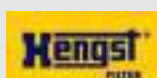

Fuel filter

Vehicle type	Actros I/MP2/MP3
External diameter	107.5 mm
Height	219 mm

Order number
3565 429 204

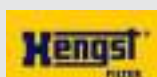

Urea filter

Vehicle type	Actros I/MP2/MP3/MP4
External diameter	43 mm
Height	85.5 mm

Order number
9750 103 044



Air filter

Vehicle type	Actros I/MP2/MP3
External diameter	64.6 mm
Inner diameter	31/46.5 mm
Height	120.3 mm

Order number
9750 104 112

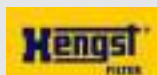
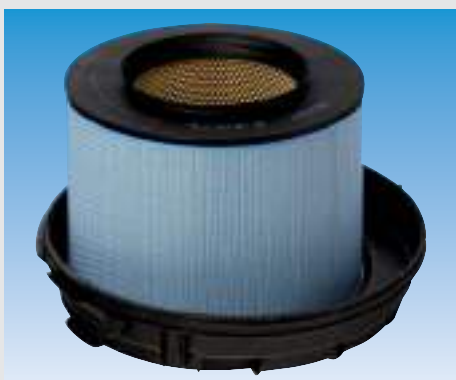

Air filter

Vehicle type	Actros I/MP2/MP3
External diameter	520.5 mm
Inner diameter	221.8 mm
Height	332.3 mm

Order number
9750 103 653

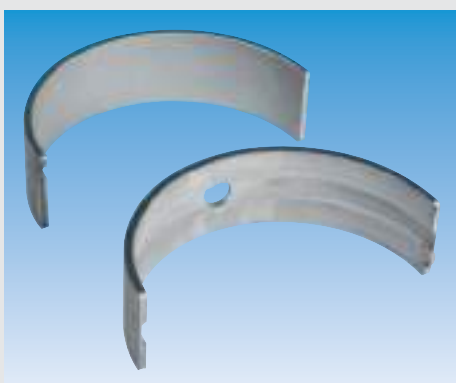

Main bearing set

Vehicle type	Actros I/MP2/MP3
Motor type	e.g. OM 501, OM 502

Order number
1911 037 842



Connecting rod bearing pair

Vehicle type	Actros I/MP2/MP3
--------------	------------------

Motor type	Order number
e.g. OM 501	1911 037 862
e.g. OM 502	1910 042 469



Inlet valve

Vehicle type	Actros I/MP2/MP3
Motor type	e.g. OM 501, OM 502
Length	145 mm
Valve stem diameter	9 mm
Valve disc diameter	45,7 mm
Valve seat angle	30°

Order number
1910 026 148



Output valve

Vehicle type	Actros I/MP2/MP3
Motor type	e.g. OM 501, OM 502
Length	145 mm
Valve stem diameter	9 mm
Valve disc diameter	41,1 mm
Valve seat angle	45°

Order number
1910 026 149



Exhaust turbocharger

Vehicle type	Actros I/MP2/MP3
Motor type	e.g. OM 501 LA (from engine no. 064476)
Special equipment	505127 01

engine type: 521.940/541.920-927/940-947/951/941.910/920/929/930/940/960/970/980/981/990

Order number
1902 431 000

Accessories

Description	Order number
Add-on set	1902 316 690



Exhaust turbocharger

in exchange

Vehicle type	Actros I/MP2
Motor type	e.g. OM 501 LA (up to engine no. 000293)

Order number
1902 024 442

Accessories

Description	Order number
Add-on set	1902 024 479



Exhaust turbocharger

in exchange

Vehicle type Actros I/MP2/MP3
 Motor type e.g. OM 501 LA (from engine no. 000294 to engine no. 064475)

Order number
 1902 316 756

Accessories

Description	Order number
Add-on set	1911 316 756



Exhaust turbocharger

in exchange

Vehicle type Actros I/MP2/MP3
 Motor type e.g. OM 501 LA (from engine no. 064476)
 Special equipment 505127 02/05/12
 engine type: 521.940/541.920-927/940-947/951/941.910(920/929/930/940/960/970/
 980/981/990

Order number
 1902 125 164

Accessories

Description	Order number
Add-on set	1911 125 164



Charging pressure sensor

Vehicle type Actros I/MP2/MP3

Order number
 3600 002 468



Charge air cooler

Vehicle type Actros I
 Motor type OM 501 LA, OM 502 LA
 Length 752 mm
 Width 652 mm
 Depth 52 mm

Order number
 9100 137 070



Charge air cooler

Vehicle type Actros I/MP2/MP3
 Motor type OM 501 LA, OM 502 LA
 Length 752 mm
 Width 852 mm
 Depth 66 mm

Order number
 9100 137 100



Charge air cooler

Vehicle type	Actros MP2/MP3
Motor type	OM 501 LA, OM 502 LA
Length	978 mm
Width	752 mm
Depth	68 mm

Order number
3563 298 868

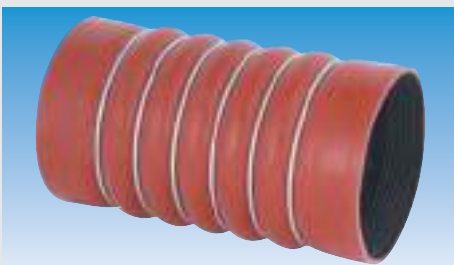

Charge air hose

Vehicle type	Actros I/MP2/MP3
Motor type	OM 501 LA, OM 502 LA
Inner diameter	115 mm
Length	210 mm
Material thickness	4 mm

Order number
5529 000 180



Water pump as replacement

Vehicle type	Actros I/MP2/MP3
Motor type	OM 501 LA to engine no. 019797, OM 502 LA
Type	220 880

Scope of supply
with seal

Order number
9150 000 240



Water pump in exchange

Vehicle type	Actros I/MP2/MP3
Motor type	OM 501 LA, OM 502 LA
Type	220 881
Version	with retarder connection

Scope of supply
with seal

Order number
9460 000 033



Water pump

Vehicle type	Actros I/MP2/MP3
Motor type	OM 501 LA

Scope of supply
with seals

Order number
6170 462 591



Water pump

Vehicle type Actros I/MP2/MP3
Motor type OM 502 LA

Scope of supply
with seals

	Order number
(on request)	5821 200 103



Water pump

Vehicle type Actros I/MP2/MP3
Motor type OM 502 LA
Version with retarder connection

	Order number
	1102 201 071



Engine radiator

Vehicle type Actros I/MP2/MP3
Width 808 mm

Length mm	Depth mm	Order number
902	42	9100 132 081
952	40	9100 132 101
1015	42	9100 134 301



Surge tank for coolant

Vehicle type Actros I/MP2/MP3
Colour black
Length 566 mm
Width 289 mm
Depth 444 mm
Volume 12,2 l

	Order number
	9100 134 070

Accessories

Description	Order number
Radiator cap, without valve	1325 461 594
Surge tank lid, 1 bar	(on request) 9465 000 206
Surge tank lid, 0,7 bar	1325 050 170



Thermostat

with seal

Vehicle type	Actros I/MP2/MP3
Diameter	67 mm
Opening temperature	83 °C

Order number
9100 000 007

Coolant temperature sensor

with seal

Vehicle type	Actros I/MP2/MP3
Outer thread	M14 x 1.5

Motor type	Spanner size	Order number
OM 904 LA	19	6170 462 920
OM 904 LA, OM 906 LA	22	9460 462 921



Radiator fan coupling

Visco clutch without fan

Vehicle type	Actros I/MP2/MP3
Diameter	233 mm

Order number
1888 000 016



Radiator fan coupling

Visco clutch without fan

Vehicle type	Actros I/MP2/MP3
Diameter	245 mm

Order number
1851 698 013

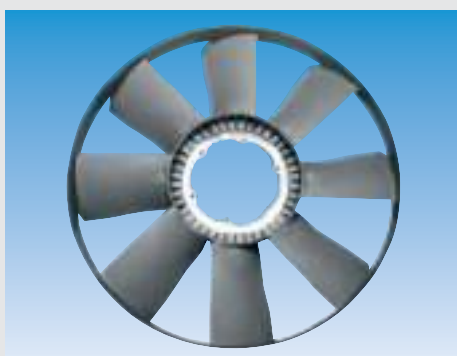

Fan wheel

Vehicle type	Actros I/MP2/MP3
Number of blades	8
External diameter	750 mm

Scope of supply without clutch

Width mm	Order number
78	9100 139 790
56	0376 756 081

This figure corresponds to 9100 139 790

MEHR ALS DIE SUMME ALLER TEILE ...

Komponenten · Originalteile · Zubehör





Rear silencer

Vehicle type Actros I/MP2/MP3

Special equipment	Order number
508108/09	8730 100 927
531391/01	
508108 07	8730 207 043

Accessories

Description	Order number
Front pipe	9464 903 019
Exhaust pipe clamp, Diameter 128.5 mm	8730 207 039
Exhaust pipe clamp, Diameter 135 mm	8730 207 037



Rear silencer

Vehicle type Actros I/MP2/MP3

Application range
for hazardous goods vehicles

Order number
8730 207 019

Accessories

Description	Order number
Front pipe	8730 207 028
Exhaust pipe clamp, Diameter 142 mm	8730 207 029
Exhaust pipe clamp, Diameter 130.5 mm	8730 156 100



Fuel tank

steel

Vehicle type Actros I/MP2/MP3
Form rectangular

(Illustration similar)

Volume l	Dimensions mm	Order number
300	640 x 560 x 950	9469 410 201
400	640 x 560 x 1250	9469 410 401
590	640 x 560 x 1860	9469 410 601

Accessories

Description	Order number
1 x Fuel cap, lockable, vented	9668 080 110
2 x Console	8730 122 493
1 x Console rubber	9660 022 455
2 x Tightening strap	9660 224 940
1 x Tightening strap rubber	9660 000 703
1 x Tank sensor	9660 022 481
1 x Connection set	8730 102 488
1 x Blind cover	9660 001 906
1 x Fuel Anti-syphon	9668 010 090



SAG

Fuel tank

aluminium

Vehicle type Actros I/MP2/MP3
Form rectangular

Volume l	Dimensions mm	Order number
230	640 x 560 x 720	9464 700 101
300	640 x 560 x 945	9469 420 301
400	640 x 560 x 1250	9469 420 401
500	640 x 560 x 1560	9469 420 501
600	640 x 560 x 1860	9469 420 601

Accessories

Description	Order number
1 x Fuel cap, lockable, vented	9668 080 110
2 x Console	9660 860 050
4 x Console rubber	9660 860 070
2 x Tightening strap	9660 860 060
2 x Tightening strap rubber	9660 860 080
1 x Tank sensor	9660 022 481
1 x Connection set	8730 102 488
1 x Blind cover	9660 001 906
1 x Fuel Anti-syphon	9668 010 090



SAG

Fuel tank

aluminium

Vehicle type Actros I/MP2/MP3
Form rectangular

Volume l	Dimensions mm	Order number
300	700 x 700 x 750	9464 701 001
400	700 x 700 x 910	9660 234 200
550	700 x 700 x 1230	9664 701 401
650	700 x 700 x 1550	9660 234 100

Accessories

Description	Order number
1 x Fuel cap, lockable, vented	9668 080 110
2 x Console	9660 860 330
4 x Console rubber	9660 860 070
2 x Tightening strap	9660 860 100
2 x Tightening strap rubber	9660 860 360
1 x Tank sensor	9660 022 481
1 x Connection set	8730 102 488
1 x Blind cover	9660 001 906
1 x Fuel Anti-syphon	9668 010 090

**CONTITECH®****Slim V-belt****XPB 1900**

Vehicle type	Actros I/MP2/MP3
Version	raw edge, cogged
Length	1900 mm

Order number

1865 774 070

**CONTITECH®****Ribbed V-belt**

Vehicle type	Actros I/MP2/MP3
--------------	------------------

Length mm	Number of ribs	Order number
2000	8	3564 664 942
1725	9	1100 282 514
1825	9	1865 091 826
2080	9	1867 520 240
2325	9	1800 000 151
1670	10	1851 016 700
1815	10	1100 282 365
1890	11	9461 997 269
2871	11	1865 000 000
1515	12	1865 487 070
2490	12	1867 122 500



(Illustration similar)

Ribbed V-belt

Vehicle type	Length mm	Number of ribs	Order number
Actros I/MP2/MP3	1215	8	1100 282 512
Actros I/MP2/MP3	1420	8	1100 219 670
Actros I/MP2/MP3	1480	8	9469 970 792
Actros I/MP2/MP3	1940	8	9050 289 190
Actros I/MP2/MP3	2085	8	3564 663 779
Actros I	1780	9	9465 997 219
Actros I/MP2/MP3	1890	9	1865 485 740
Actros I	2010	9	2300 000 379
Actros I/MP2/MP3	2295	9	1100 282 515
Actros I	2338	9	1325 000 748
Actros I/MP2/MP3	2835	9	1865 487 260
Actros I/MP2/MP3	2870	9	1100 211 715
Actros I/MP2/MP3	2020	11	3564 642 047
Actros I/MP3	2040	11	1100 282 464
Actros I/MP3	2044	11	2540 101 162
Actros I/MP2/MP3	2835	11	1100 282 465



www.contitech.de/aam

Keine Experimente beim Keilrippenriemen-Wechsel



Entscheiden Sie sich für die Qualität, die führende Automobilhersteller schon in der Erstausrüstung bevorzugen.

ContiTech Antriebssysteme GmbH
D-30165 Hannover
E-Mail aam@ptg.contitech.de

Continental 
CONTITECH



Ribbed V-belt set

Vehicle type Actros I/MP2/MP3

Scope of supply

1 x ribbed V-belt 9 PK 1890, 1 x ribbed V-belt tensioner

Order number
3564 617 904

Contents

Description	Order number
Ribbed V-belt, Length 1890 mm	1865 485 740
Poly-V belt tensioner	5930 000 542



Ribbed V-belt set

Vehicle type Actros I/MP2/MP3

Scope of supply

1 x ribbed V-belt 9 PK 2835, 1 x ribbed V-belt tensioner

Order number
1100 282 326

Contents

Description	Order number
Ribbed V-belt, Length 2835 mm	1865 487 260
Poly-V belt tensioner	5930 000 540



Deflection pulley/guide pulley

for ribbed V-belt

Illustration	Vehicle type	Material	Outer Ø mm	Width mm	Order number
1	Actros I	metal	80	44	1362 010 040
2	Actros I	metal	74	38	5930 000 551
3	Actros I/MP2/MP3	plastic	74	46.3	5930 000 499
4	Actros I/MP2/MP3	metal	80	48	5930 000 541
5	Actros I/MP2/MP3	metal	95	39	1362 010 041
6	Actros I/MP3	plastic	80	44	9465 500 433
7	Actros MP3	metal	107	34	3564 580 874

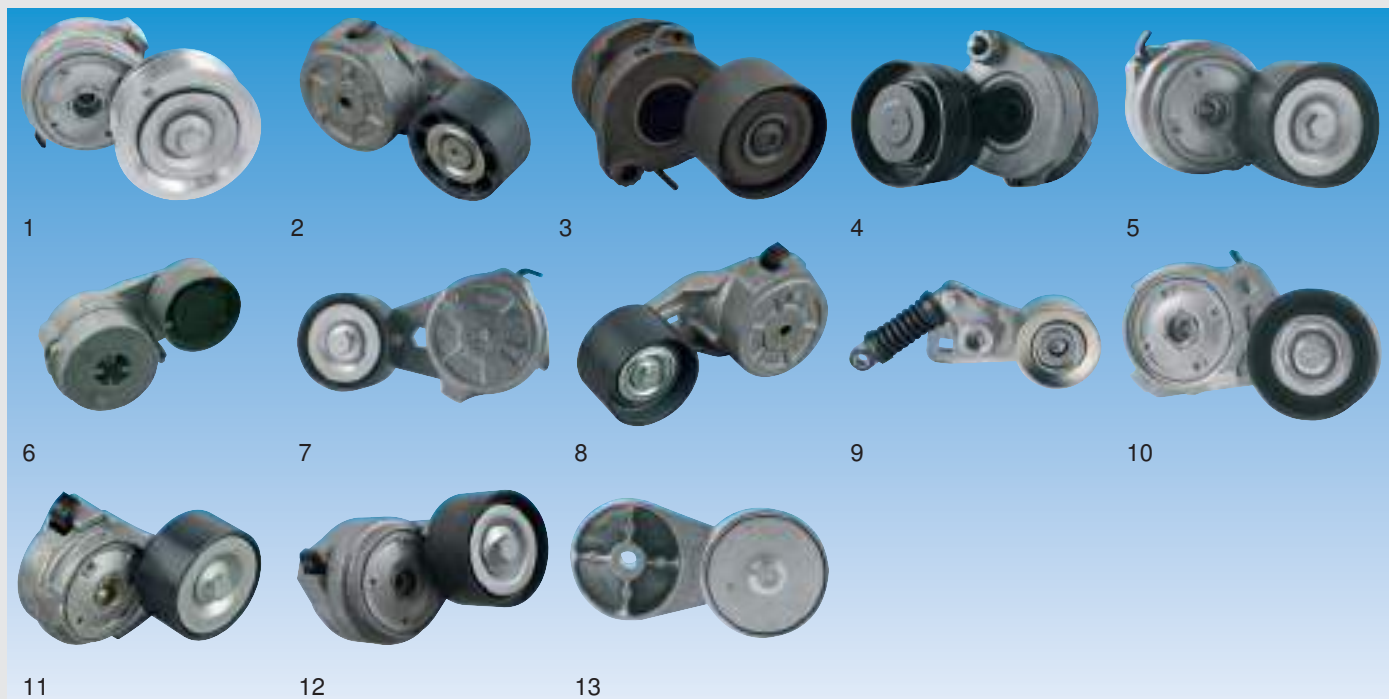

Poly-V belt tensioner

Illustration	Vehicle type	Outer Ø mm	Roll width mm	Order number
1	Actros I	80	34/102,5	9462 001 970
2	Actros I/MP3	74	39/57,7	5930 000 543
3	Actros I/MP3	78	42	1911 043 900
4	Actros I	78	42/104,5	3563 830 141
5	Actros I/MP3	74	46,3	5930 000 511
6	Actros I/MP2/MP3	70	35	9462 001 070
7	Actros I/MP2/MP3	74	34	9462 001 570
8	Actros I/MP2/MP3	74	46	5930 000 542
9	Actros I/MP2/MP3	80.5	48	5930 000 540
10	Actros MP2/MP3	90	34	1911 400 001
11	Actros MP3	74	34	1911 252 424
12	Actros MP3	74	38,3	5930 000 554
13	Actros MP3	74	35,5	5930 000 544



Flywheel

Vehicle type	Actros I/MP2/MP3
Version	with sprocket, 37 grooves
Diameter	430 mm

Order number
9060 100 000

Accessories

Fastening set

1 axial seal (external diameter 140 mm), 1 race (external diameter 120 mm), 1 pilot bearing (external diameter 62 mm), 10 bolts M16 x 1.5

Order number
9060 000 103



Flywheel

Vehicle type	Actros MP2/MP3
Special equipment	SA 505009 05
Version	with gear rim
Diameter	395 mm

Order number
9460 301 905

Accessories

Grooved ball bearing with 2 sealing washers

External diameter	52 mm
Inner diameter	20 mm
Height	15 mm

Order number
8001 630 423



Flywheel

Vehicle type	Actros MP2/MP3
Special equipment	SA 505009 58
Version	with gear rim
Diameter	362 mm

Order number
9060 100 065



Dual mass flywheel

Vehicle type Actros I/MP2/MP3
Diameter 430 mm

Scope of supply
with mounting screws

Order number
9754 000 008

Accessories

Crankshaft seal

Dimensions 115 x 140 x 12 mm

Order number
8002 534 667

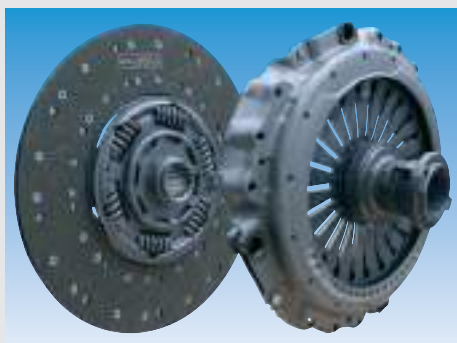

Clutch kit

as replacement

Vehicle type Actros I/MP2/MP3
Parameter MFZ430
Diameter 430 mm
Number of teeth 18
Toothed hub profile 45x50-18N

Scope of supply
Release bearing, mounted with pressure plate

Order number 9270 122 801 **Comparative number** Sachs 3400 122 801

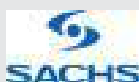

Clutch kit

In exchange

Vehicle type Actros I/MP2/MP3
Parameter MFZ2/400
Diameter 400 mm
Number of teeth 8
Toothed hub profile 45x50-18N

Scope of supply
Disc, automatic unit, release bearing mounted

Order number 9270 121 501 **Comparative number** Sachs 3400 121 501



Clutch kit

Vehicle type	Actros MP2/MP3
Parameter	MFZ2/400X
Diameter	400 mm
Number of teeth	18
Toothed hub profile	45x50-18N

Scope of supply

Disc, automatic unit, release bearing mounted

Order number

9270 700 355

Comparative number

Sachs 3400 700 355



Clutch kit

Vehicle type	Actros MP2/MP3
Parameter	MFZ430
Diameter	430 mm
Number of teeth	18
Toothed hub profile	45x50-18N

Scope of supply

Disc, automatic unit, release bearing mounted

Order number

9270 004 003

Comparative number

Sachs 3400 700 446

Everything your engine loves!

Spare parts documentation for more than 550 engine variants from the manufacturers:

- DAF
- MAN
- MERCEDES-BENZ
- SCANIA
- VOLVO

... and much more besides!

Request your free catalogue copy!





Storage for propeller shaft

Vehicle type	Actros I/MP2/MP3
External diameter	94 mm
Inner diameter	71 mm

Scope of supply
with ball bearing

Order number
9220 001 086

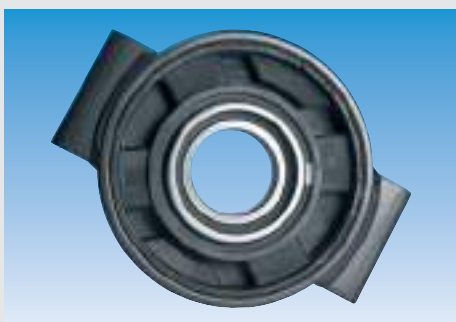

Storage for propeller shaft

Vehicle type	Actros I
External diameter	105 mm
Inner diameter	70 mm

Scope of supply
with ball bearing

Order number
9460 119 845

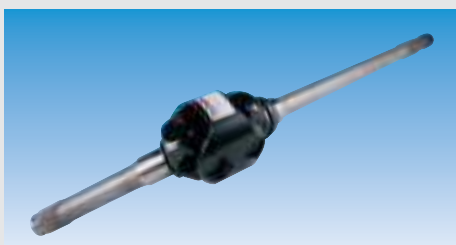

Drive shaft with joint

Vehicle type	Actros I/MP2/MP3
--------------	------------------

Installation side	Length mm	Order number
left	1262	9031 300 047
right	1102	9460 307 001



Oil cooler for retarder

Vehicle type	Actros I/MP2/MP3
Length	285 mm
Width	203 mm
Height	160 mm

Order number
1911 333 019



Parabolic spring

Front axle

Vehicle type	Actros I/MP2/MP3
Form	1J
Number of leaves	2
Thickness	58
Width	90 mm
Length front/rear	900/900 mm
Bushing front/rear	24/60, 24/60 mm
Axle load	7,1

Order number
1033 816 000

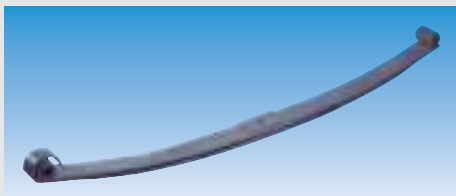

Parabolic spring

front axle

Vehicle type	Actros I/MP2/MP3
Form	1J
Number of leaves	2
Thickness	60
Width	90 mm
Length front/rear	900/900 mm
Bushing front/rear	24/60, 24/60 mm
Axle load	7,5 t

Order number
1033 818 000



Parabolic spring

front axle

Vehicle type	Actros I/MP2/MP3
Form	1KM
Number of leaves	3
Width	90 mm
Length front/rear	900/900 mm
Bushing front/rear	24/60, 24/60 mm

Thickness mm	Axle load t	Order number
79	7,5	1033 684 000
81	8	1033 682 000
83	9	1033 690 000



Spring hoop

Front axle

Thread	M20 x 1.5
Form	0
Interior width	91 mm

Vehicle type	Length mm	Order number
Actros I/MP2/MP3	205	1301 903 205
Actros I/MP2/MP3	225	1301 903 225
Actros I/MP2/MP3	240	1309 894 324
Actros I/MP3	320	1301 943 320

Accessories

Flat collar nut

Thread	M20 x 1.5
Height	20 mm

Order number
6604 020 150

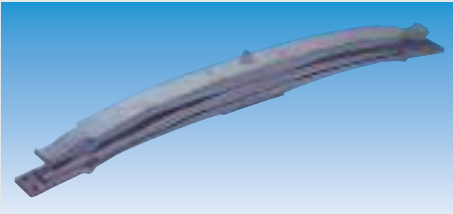

Parabolic spring

Rear axle

Vehicle type	Actros I/MP2/MP3
Form	8BP
Number of leaves	2/1
Thickness	128 mm
Width	100 mm
Length front/rear	780/780 mm
Axle load	9,5 t

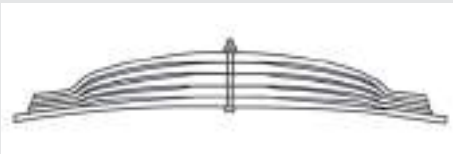
Order number
1033 887 000

Parabolic spring

rear axle

Vehicle type	Actros I/MP2/MP3
Form	8KP
Number of leaves	5
Thickness	195 mm
Width	100 mm
Length front/rear	780/780 mm
Axle load	16 t

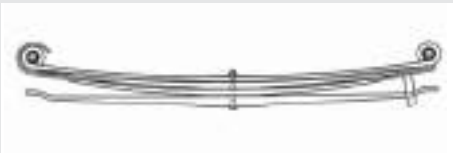
Order number
1033 885 000

Parabolic spring

Rear axle

Vehicle type	Actros I/MP2/MP3
Form	1BK
Number of leaves	3/1
Width	100 mm
Length front/rear	900/885 mm
Bushing front/rear	24/60, 24/60 mm
Axle load	13 t

Thickness mm

127

133

Order number
1033 681 000
1033 683 000

Hollow rubber spring

Vehicle type	Actros I/MP2/MP3
Length	210-232 mm
Width	135-165 mm

Height mm

120

152

Order number
1593 103 050
9560 066 359



Spring hoop

Rear axle

Vehicle type	Actros I/MP2/MP3
Form	1
Thread	M24 x 1.5
Interior width	101 mm

Length mm	Order number
440	1301 553 440
480	1301 553 480

Accessories

Hexagon nut

Thread	M24 x 1.5
Height	24 mm

Order number
9900 135 145



Spring hoop

Rear axle

Vehicle type	Actros I/MP2/MP3
Form	3/7
Thread	M27 x 2
Interior width	101 mm

Length mm	Order number
380	1301 593 380
430	1398 593 430

Accessories

Hexagon nut

Thread	M27 x 2
Height	40 mm

Order number
1303 270 211



Air spring

complete, with steel piston

Vehicle type	Actros I/MP2/MP3
Piston diameter	280 mm
Inner diameter	280 mm
Height	270 mm

Order number
1788 475 721



Air spring

with piston

Vehicle type	Actros I/MP2/MP3
Version	VOSS 232
External diameter	342-352 mm
Piston diameter	265 mm
Height	280 mm

Order number
1788 418 324

Air spring

with steel piston

Vehicle type	Actros I/MP2/MP3
Version	VOSS 232
External diameter	276-286 mm
Piston diameter	200 mm
Height	292 mm

Order number
1788 439 022

Air spring

with piston

Lower attachment: central inner thread M16 x 1.5

Air connection: outer thread M24 x 1.5, inner thread M16 x 1.5

Vehicle type	Actros I/MP2/MP3
Version	VOSS 232
External diameter	276-286 mm
Piston diameter	200 mm
Height	292 mm

Order number
1788 439 012

Air spring bellows

with piston

Vehicle type	Actros I/MP2/MP3
suitable for	Low Liner
Version	VOSS 232
External diameter	297-307 mm
Inner diameter	280 mm
Height	197 mm

Order number
1780 475 921



Air spring

with piston

Vehicle type	Actros I/MP2/MP3
Version	VOSS 232
Outer Ø	360 mm
Height	360 mm

Piston dia. mm	Order number
220	1788 483 822
230	1788 483 823



Shock absorber

Fastening	eye/eye
Version	oil pressure, twin-tube system

(Illustration similar)

Vehicle type	Installation location	Order number	Comparative number
Actros I/MP2/MP3	front axle	9200 000 570	Sachs 310 803
Actros I/MP2/MP3	front axle	9200 001 290	Sachs 131 944
Actros I/MP2/MP3	front axle	9200 124 678	Sachs 124 678
Actros I/MP2/MP3	front axle	9200 001 235	Sachs 310 807
Actros I/MP2/MP3	Front axle	9200 124 639	Sachs 124 639
Actros I	rear axle	9200 001 245	Sachs 124 359
Actros I/MP2/MP3	rear axle	9200 001 310	Sachs 124 376
Actros I/MP2/MP3	rear axle	9200 124 567	Sachs 124 567
Actros I/MP2/MP3	Rear axle	9200 124 638	Sachs 124 638
Actros I/MP2/MP3	rear axle	9200 131 623	Sachs 131 623



Shock absorber

front axle

Vehicle type	Actros I/MP2/MP3
Fastening	eye/eye
Version	Oil pressure, twin-tube
Installation location	front axle

Order number	Comparative number
9201 317 470	Sachs 131 747
9201 319 440	Sachs 131 944
9463 239 500	Sachs 310 163
9463 235 400	Sachs 131 622

(Illustration similar)



(Illustration similar)



Shock absorber

Rear axle

Fastening	Eye/eye
Version	Oil pressure, twin-tube
Installation location	Rear axle

Vehicle type	Order number	Comparative number
Actros I/MP2/MP3	9201 243 130	Sachs 124 313
Actros I/MP2/MP3	9270 311 644	Sachs 311 644
Actros MP2/MP3	9750 001 258	Sachs 311 665
Actros I/MP2/MP3	9201 243 600	Sachs 124 360

Ihr Partner für
OE-Qualitätsfedern.
Made in Germany



KF
Kraemer & Freund

Unser Antrieb: Immer und überall gut ankommen.

Die Blattfedern von Kraemer & Freund verbinden langjährige Expertise und neueste technologische Erkenntnisse mit höchsten Qualitätsstandards.

Als Teil der BILSTEIN-Gruppe und damit des ThyssenKrupp Unternehmensverbunds bieten wir Ihnen

- innovative Federn in Erstausrüster-Qualität
- ein Blattfedern-Sortiment mit ca. 2.000 verschiedenen Federtypen als Komplettfeder und die dazugehörigen Einzellagen
- passende Produkte für alle gängigen Typen sowie die neuesten Fahrzeuggenerationen



Besuchen Sie uns unter www.kraemer-und-freund.de





Drag-link

Vehicle type Actros I/MP2/MP3
 Installation location drop arm to the 1st front axle

Length mm	Pipe Ø mm	Cone-Ø mm	Order number
725	36	22	9070 900 087
876	40	28.6	9070 900 039
879	42	30	9070 900 037
858	40	28,6	9079 927 683



Drag-link

Vehicle type Actros I/MP2/MP3
 Installation location intermediate lever 1 to intermediate bearing 2
 Length 1095 mm
 Pipe diameter 42 mm
 Cone diameter 32 mm

Order number
 9070 001 014



Drag-link

Vehicle type Actros I/MP2/MP3
 Installation location drop arm to the 1st front axle
 Length 879 mm
 Pipe diameter 36 mm
 Cone diameter 28,6 mm

Order number
 9070 900 008

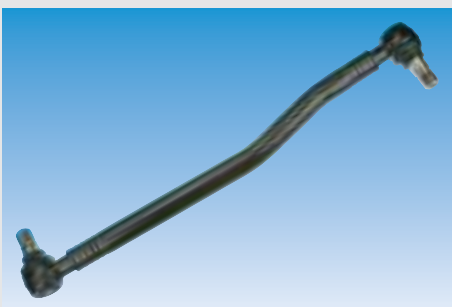

Drag-link

X-CAP

Vehicle type Actros I/MP2/MP3
 Installation location drop arm to the 1st front axle
 Length 711 mm
 Pipe diameter 42 mm
 Cone diameter 32 mm

Order number
 9890 200 163



Ball joint

for steering rod

Vehicle type Actros I/MP2/MP3
 Installation location front axle

(Illustration similar)

Threadtype	Outer thread	Cone-Ø mm	Length mm	Order number
right-hand thread	M28 x 1.5	28.6	141	9070 900 053
right-hand thread	M30 x 1.5	28.6	115	9079 927 623
right-hand thread	M24 x 1.5/M30 x 1.5	30	120	9070 900 117
left-hand thread	M24 x 1.5/M30 x 1.5	30	120	9070 900 123



Power-steering pump

in exchange

Version hydraulic

(Illustration similar)

Vehicle type	Order number	Comparative number
Actros MP2/MP3	9074 204 210	Mercedes-Benz 001 460 44 80
Actros MP2/MP3	9074 209 110	Mercedes-Benz 002 460 14 80
Actros I/MP3	6952 009 210	Mercedes-Benz 002 460 15 80

Power-steering pump

Tandem pump

Vehicle type Actros I/MP2/MP3

Order number	Comparative number
6542 045 410	Mercedes-Benz 003 460 03 80



Stabilizer mounting

Vehicle type Actros I/MP2/MP3

Installation location	Outer Ø mm	Inner Ø mm	Length mm	Material	Order number
front	51	28	55	rubber	9463 236 285
front	61	38	55	rubber	9460 109 904
front/rear	70	40	46	rubber/metal	9290 002 430
front	74	47	56	rubber	9460 109 905
rear	87	56	56	rubber	1597 200 333
rear	80	40	46	rubber/metal	9463 238 185
front	98	70	67	rubber	9461 323 015
front/rear	108.5	80	67	rubber	1583 006 123



Stabilizer mounting

Vehicle type Actros I/MP2/MP3
 Version for vehicles with air suspension
 Installation location rear
 External diameter 109 mm
 Inner diameter 88 mm
 Length 175 mm
 Distance between centres 130 mm
 Bore hole diameter 20.5 mm

Order number
1583 006 121



Steering Track Rod

Vehicle type Actros I/MP2/MP3
 Form straight
 Installation location front axle
 Threadtype right-hand thread
 Length 1735 mm
 Pipe diameter 50 mm
 Cone diameter 32 mm

Order number
9070 900 013



Steering Track Rod

Vehicle type	Actros I/MP2/MP3
Form	offset
Installation location	Front axle
Threadtype	Right-hand thread

Length mm	Pipe Ø mm	Cone-Ø mm	Order number
1588	60	30	9079 924 315
1735	52	32	9070 001 410



**Ball joint
for steering track rod**

Vehicle type	Actros I/MP2
Installation location	front axle
Threadtype	right-hand thread
Outer thread	M38 x 1.5
Cone diameter	38 mm
Length	135 mm

(Illustration similar)

Order number
9070 900 130



**Ball joint
for track rod**

Vehicle type	Actros I/MP2/MP3
Installation location	front axle
Outer thread	M27 x 1.5/M30 x 1.5
Cone	32 mm
Length	120 mm

(Illustration similar)

Threadtype	Order number
left-hand thread	9070 900 045
right-hand thread	9070 900 015



Repair kit

Kingpin

Vehicle type Actros I/MP2/MP3
 Bolt diameter 50 mm
 Bolt length 223 mm

Scope of supply

2 top needle bearings, 2 bottom needle bearings, 1 thrust bearing, 1 sealing ring, 1 thrust collar

Installation location	Installation side	Order number
track-rod arm side	left	9460 066 235
steering arm side	right	9460 066 328

Accessories

Description	Order number
Kingpin	9463 320 006



Repair kit

Kingpin

Vehicle type Actros I/MP2/MP3
 Bolt diameter 50/64 mm
 Bolt length 119 mm

Scope of supply

1 axle bolt, 1 sealing ring, 1 bush, 1 shaft sealing ring, 1 snap ring, 1 screw plug

Order number
1583 005 100



Repair kit

Kingpin

Vehicle type Actros I/MP2/MP3
 Installation location top
 Bolt diameter 50 mm
 Bolt length 109 mm

Scope of supply

1 axle bolt, 1 sealing ring, 1 bush, 1 pressure disc, 1 shaft sealing ring, 1 circlip, 1 screw plug

Order number
1583 005 000



Repair kit

Kingpin

Vehicle type Actros I/MP2/MP3
 Installation location bottom
 Bolt diameter 50 mm
 Bolt length 120 mm

Scope of supply

1 axle bolt, 1 sealing ring, 1 snap ring, 1 shaft sealing ring, 1 screw plug, 2 needle bearings

Order number
9463 300 219

**PROEQUIP**

Sicherheit – Ohne Kompromisse

Nkw-Ersatzteile der Marke TRW Proequip stehen für kompromisslose Erstausrüster-Qualität: stark, zuverlässig, langlebig – in allen Fahrsituationen und unter schwersten Bedingungen. Bremsenteile, Lenkungs- und Aufhängungskomponenten sowie Stoßdämpfer bilden ein vollständiges Ersatzteilangebot für Nkw-Werkstätten. Mit mehr als 100 Jahren Erfahrung als Erstausrüster fertigt TRW alle Produkte nach strengen OE-Standards und testet unter härtesten Bedingungen. Nkw-Profis vertrauen auf TRW Proequip.



www.trwaftermarket.com/trwproequip

NKW-TEILE VOM ERSTAUSRÜSTER



Wheel hub

Installation location Front axle

Vehicle type	Version	Order number
Actros I/MP2/MP3	without bearing	9870 102 496
Actros I	with bearing	9463 300 125

This figure corresponds to 9463 300 125



Wheel hub

Vehicle type Actros I
Version with bearing
Installation location Rear axle

	Order number
(on request)	9463 500 335

Compact bearing

Vehicle type Actros I/MP2/MP3
External diameter 140 mm
Inner diameter 82 mm
Width 115 mm

Scope of supply

inner and outer bearing with sealing ring

	Order number
	9469 819 305



Tapered roller bearing

Vehicle type Actros I/MP2/MP3

(Illustration similar)

Version	Outer Ø mm	Inner Ø mm	Height mm	Order number
wheel hub, outer	130	60	48.5	8001 323 122
wheel hub, outer	130	80	37	8001 331 162
wheel hub, inner	150	100	39	8001 330 202
wheel hub, inner	170	110	47	8001 330 222

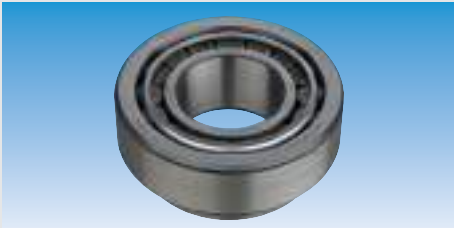

Tapered roller bearing

Vehicle type Actros I/MP2/MP3

Version	Outer Ø mm	Inner Ø mm	Height mm	Order number
Wheel hub, inside	110	55	39	6950 001 328
wheel hub, inner	150	70	64	8001 228 000
wheel hub, outside	72	35	28	8001 332 070
wheel hub, outer	157	100	42	9469 812 305
rear axle, outer	160	100	44	8001 805 312



Shaft sealing ring

for wheel hub

Installation location Rear axle, inner

Illustration	Vehicle type	Outer Ø mm	Inner Ø mm	Height mm	Order number
1	Actros I	150	125	15	8002 971 436
2	Actros I/MP2/MP3	175	145	15	8002 972 816
3	Actros I/MP2/MP3	175	145	17/21	8002 972 815

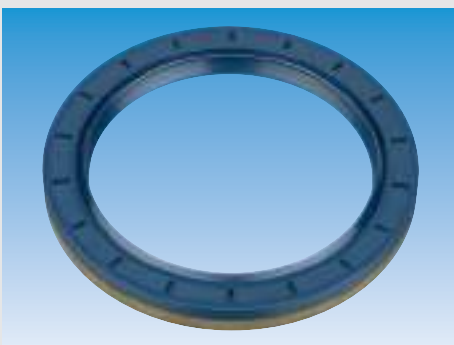

Shaft sealing ring

for wheel hub

Vehicle type Actros I/MP2/MP3

Installation location front axle, inner

Version for 8-hole wheel connection

External diameter 150 mm

Inner diameter 120 mm

Height 12 mm

Order number

9460 245 939



Shaft sealing ring

for wheel hub

Vehicle type	Actros I
Installation location	Front axle, inner
Version	with ABS ring
External diameter	134 mm
Inner diameter	75 mm

Order number
9479 970 446



Repair kit

for wheel hub

Vehicle type	Actros I
Installation location	Rear axle
Installation side	left, right
External diameter	150 mm
Inner diameter	125 mm
Height	15 mm

Scope of supply

1 shaft seal, 1 seal, 1 locking washer

Order number
9460 006 120



Gasket set

for wheel hub

Vehicle type	Actros I/MP2/MP3
Installation location	front axle
External diameter	150 mm
Inner diameter	120 mm
Height	20 mm

Scope of supply

2 axial seals, 1 seal, 1 pulse wheel, 8 hexagon bolts

Order number
9463 301 025



Gasket set

for wheel hub

Vehicle type	Actros I/MP2/MP3
Installation location	rear axle
Installation side	left/right
External diameter	175 mm
Inner diameter	145 mm
Height	17 mm

Scope of supply

1 axial seal, 1 thrust ring, 1 pulse wheel, 1 cover plate, 1 tab washer

Order number
8002 000 033

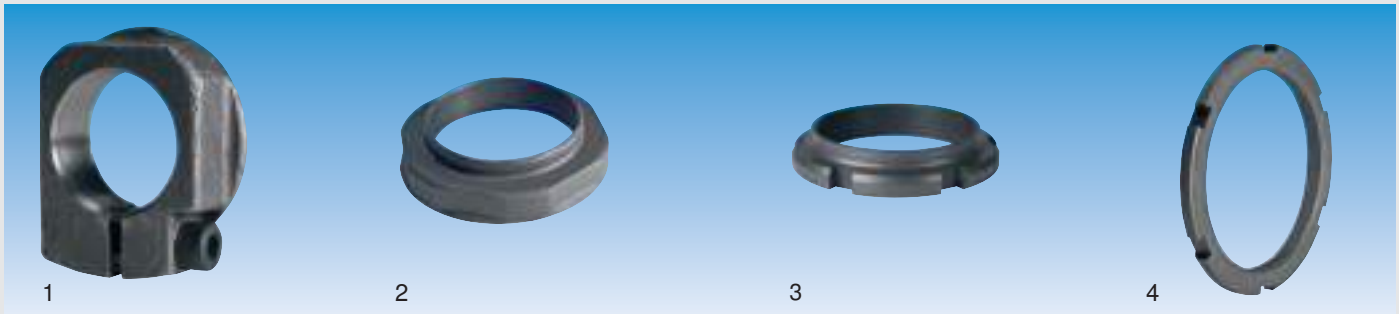

Axle nut

Illustration	Vehicle type	Installation location	Thread	Order number
1	Actros I/MP2/MP3	Front axle/rear axle	M45 x 1.5	1325 040 294
2	Actros I/MP2/MP3	Front axle	M70 x 1.5	9469 908 150
3	Actros I/MP2	Rear axle	M75 x 1.5	(on request) 9463 530 026
4	Actros I/MP2/MP3	Rear axle	M100 x 1.5	9463 560 226



'A' frame

with molecular bearing

Vehicle type	Actros I/MP2/MP3
Installation location	rear axle
Length	622 mm
Distance between holes	152/130/130 mm



Illustration	Pipe Ø mm	Bore hole Ø mm	Order number	Comparative number
1	48	25/23/23	9070 001 009	Mercedes-Benz 942 350 12 05
2	46	25/25/25	9070 001 021	Mercedes-Benz 942 350 15 05
2	46	25/25/25	9070 001 022	Mercedes-Benz 948 350 04 05



'A' frame

with molecular bearing

Vehicle type	Actros I/MP2/MP3
Installation location	rear axle
Length	622 mm
Distance between holes	152/130/130 mm
Pipe diameter	46 mm
Bore hole diameter	25/23/23 mm

Order number
5220 090 013

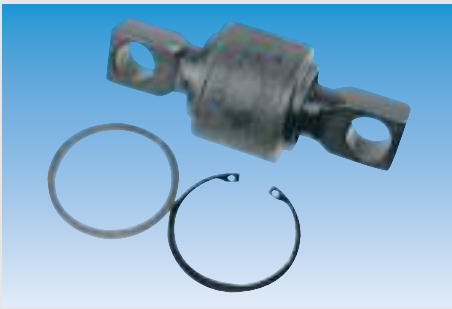

Repair kit

for wishbone

Vehicle type	Actros I/MP2/MP3
Version	with molecular bearing
Bore hole diameter	23 mm
Distance between holes	130 mm

Order number
9079 991 558



Repair kit

for wishbone

Vehicle type	Actros I/MP2/MP3
Version	with molecular bearing

Bore hole Ø mm	Distance between holes mm	Order number
24	130	9463 504 805
25	130	9079 991 608
25	152	9077 200 300
25	152	9079 991 609
25	152	9070 310 410



Trailing arm

Vehicle type	Actros I/MP2/MP3
Version	with molecular bearing
Length	850 mm
Pipe diameter	52 mm
Bore hole diameter	17 mm
Distance between holes	100 mm

Order number
9070 022 092



Trailing arm

Vehicle type	Actros I/MP2/MP3
Version	with molecular bearing
Length	754 mm
Pipe diameter	58 mm
Bore hole diameter	17 mm
Distance between holes	100 mm

Order number
9079 991 543



Trailing arm

Vehicle type	Actros I/MP2/MP3
Version	with molecular bearing
Length	565 mm
Pipe diameter	50 mm
Bore hole diameter	21 mm
Distance between holes	152 mm

Order number

5210 090 055

Repair kit

axle strut, torque rod

Vehicle type	Actros I/MP2/MP3
Version	with molecular bearing
Installation location	Rear axle
Installation side	left, right
External diameter	85 mm
Inner diameter	21 mm
Distance between holes	152 mm

Order number

6170 490 816



Wheel bolt

Vehicle type	Actros I/MP2/MP3
Outer thread	M22 x 1.5

Installation location	Overall length mm	Order number
front axle/rear axle	78,5	2213 000 105
rear axle	96,6	2213 000 106
rear axle	101,5	2213 000 110

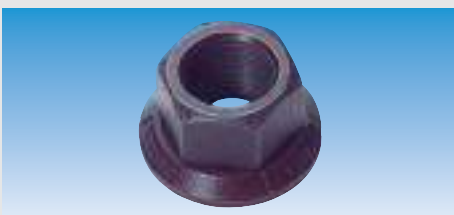

Wheel nut

Vehicle type	Actros I/MP2/MP3
Thread	M22 x 1.5
Spanner size	32

Installation location	suitable for	Height mm	Order number
front axle/rear axle	steel and aluminium wheels	27	1303 221 551
front axle	aluminium wheels	34 (Short sleeve)	6136 320 442
rear axle	aluminium wheels	62 (Long sleeve)	6136 320 452

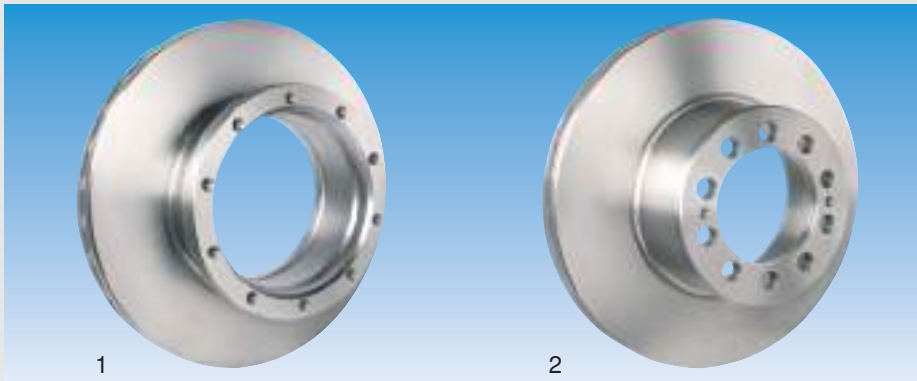

Brake disc

Vehicle type	Actros I/MP2/MP3
Installation location	front/rear axle
Version	internally ventilated
External diameter	430 mm
Thickness	45 mm

Illustration	Height mm	Hole pattern	Order number
1	132.5	10 x M14 x 1,5	3403 460 000
2	143.5	10 x M20 x 1,5	3403 460 001

Suitable brake piston resetting tools available from EUROPART!

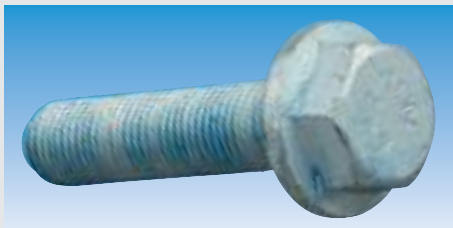

Attachment screw

for brake disc

Vehicle type	Actros I/MP2/MP3
Installation location	Front axle
Surface	dacrotized
Thread	M14 x 1.5
Property class	10.9
Length	60 mm

Order number
9460 066 205

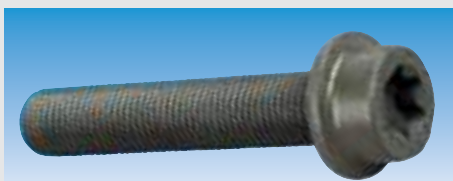

Attachment screw

for brake disc

Vehicle type	Actros I/MP2/MP3
Installation location	Rear axle
Surface	phosphated
Thread	M14 x 1.5
Property class	10.9
Length	75 mm

Order number
9469 900 004



Keine Kompromisse wenn es um Sicherheit geht

BERAL Bremsbeläge sind für den neuen Actros freigegeben

Nach intensiver Entwicklungsarbeit sind BERAL Scheibenbremsbeläge auf Basis der ProTec S[®]-Technologie von Knorr-Bremse für den neuen Actros freigegeben worden. Das Federal-Mogul Forschungs- und Entwicklungs-Team in Bad Camberg hat zwei neue Mischungen entwickelt – je eine für Vorder- und Hinterachse – die hervorragende Werte bei Bremsleistung, Lebensdauer und Fahrkomfort liefern.

Da der neue Actros über eine dynamische Achslastverlagerung verfügt, werden unterschiedliche Bremsmomente an den jeweiligen Achsen benötigt. Für die Vorderachse (Bremsattel Knorr SM7) und für die Hinterachse (Knorr-Bremsattel SL7) bieten die neuen Mischungen

auch eine wirkungsvolle Wärmeableitung. Bremsrubbeln wird verhindert, gleichzeitig werden auch bei hohen Temperaturen sehr gute Bremsleistungen erzielt, d.h. Sicherheit und Komfort profitieren gleichermaßen.

Bezogen auf die Materialabnutzung der Brems Scheibe übertreffen beide Beläge die OE-Anforderungen, sodass auch hier eine längere Lebensdauer erreicht werden kann. Zur Reduzierung des Bremsgeräusches hat der Belag radiale Anstragungen, die eine bessere Druckverteilung des Belages gewährleisten. Außerdem unterstützen diese Merkmale die Bremsleistung und das Verschleißverhalten maßgeblich.



Mercedes-Benz, Gebrauchtwagen der Baureihe W2

BERAL

FEDERAL MOGUL

**EURO
PART**
Brake pad set
front/rear axle

Vehicle type	Actros I/MP2/MP3
Contents of set	4
Coating length	248 mm
Lining width	108 mm
Lining thickness	30.00 mm
Brake system	Knorr SB/SN 7
WVA no.	29061

Scope of supply
with accessories

Order number
2323 405 106

BERAL
Brake pad set

Vehicle type	Actros MP2/MP3
Brake system	SB/SN7 (ProTecS)
WVA no.	29253
Contents of set	4
Coating length	247,7 mm
Lining width	109,7 mm
Lining thickness	30.00 mm

Scope of supply
with accessories

Order number
2120 292 530

TEXTAR
Brake pad set

Vehicle type	Actros MP2
Brake system	Knorr SB 7000
WVA no.	29202
Contents of set	4
Coating length	247,7 mm
Lining width	109,7 mm
Lining thickness	30.00 mm

Scope of supply
with accessories

Order number
2190 873 005



Brake caliper

Vehicle type	Actros I/MP2/MP3
Installation location	front axle/rear axle
Version	standardised

Application range
for 22.5" wheel size

Type	Installation side	Order number
SN7211RC	left	3450 003 800
SN7201RC	right	3450 003 799

Accessories

Description	Order number
Pressure pad set	3400 110 013
Guide sealing set	3450 414 380
Adjuster cap set	3450 411 915



Brake caliper

Vehicle type	Actros I/MP2/MP3
Installation location	front axle/rear axle
Version	standardised

Application range
for 22.5" wheel size

Type	Installation side	Order number
SN7300RC	left	3400 047 092
SN7310RC	right	3400 013 182

Accessories

Description	Order number
Pressure pad set	3400 110 013
Guide sealing set	3450 414 380
Adjuster cap set	3450 411 915



Brake caliper

Vehicle type	Actros I/MP2/MP3
Installation location	front axle/rear axle
Version	standardised

Application range
for 17.5" wheel size

Type	Installation side	Order number
SN5016RC	left	3450 414 785
SN5006RC	right	3450 414 784

Accessories

Description	Order number
Pressure pad set	3400 001 929
Guide sealing set	3400 047 188
Adjuster cap set	3450 411 915



Brake caliper

Vehicle type	Actros I/MP2/MP3
Installation location	front axle/rear axle
Version	standardised

Application range
for 17.5" wheel size

Type	Installation side	Order number
SN5015RC	left	3450 414 783
SN5005RC	right	3450 414 782

Accessories

Description	Order number
Pressure pad set	3400 001 929
Guide sealing set	3400 047 188
Adjuster cap set	3450 411 915



Brake caliper carrier

Vehicle type	Actros I/MP2/MP3
Brake system	Knorr SB/SN 7

Installation location	Order number
front axle	3450 411 905
rear axle	3450 411 910

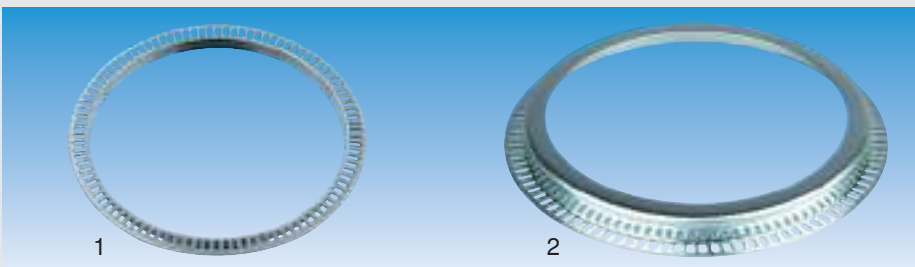

Sensor ring, ABS

ABS

Vehicle type	Actros I/MP2/MP3
--------------	------------------

Illustration	Installation location	Outer Ø mm	Inner Ø mm	Thickness mm	Order number
-	Front axle	178	140	15	9463 334 011
1	Front axle	164/188	160	12	1593 102 551
2	Rear axle	176/195.5	153	16.5	1593 102 550



Brake drum

Vehicle type Actros I/MP2/MP3

Illustration	suitable for	Dimensions mm	Brake path mm	Order number
1	front axle	410 x 237 x 10 x 23/3 x M12 x 1,5	191	2030 410 039
2	rear axle	410 x 306 x 10 x 24/5 x 24/3 x M12 x 1,5	237	2030 410 040
1	rear axle	410 x 306 x 10 x 23/5 x 24/3 x M12 x 1,5	240	2030 410 034

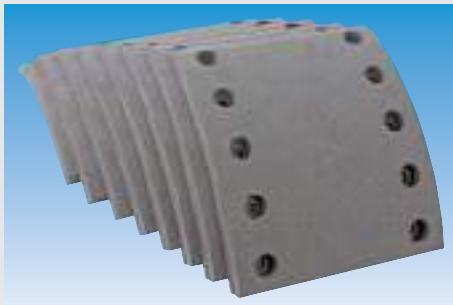

Brake lining set

Vehicle type Actros I/MP2/MP3
 Lining thickness 17.00 mm
 Contents of set 8

WVA no.	Dimensions mm	Order number
19495	410 x 183	2119 487 008
19496	410 x 223	2119 488 008



WABCO

Air dryer

Vehicle type	Actros I/MP2/MP3
Version	1-chamber system
Operating pressure	max. 13 bar

Order number	Comparative number
0565 000 070	WABCO 932 500 110 0



WABCO

Air dryer

Vehicle type	Actros I
Version	1-chamber system with integrated pressure regulator and heating
Operating pressure	max. 13 bar
Opening pressure	14,5 + 2,5 bar
Cut-off pressure	12 ± 0,3 bar
Operating range	1,5 +/- 0,25 bar
Voltage	24 V

Order number	Comparative number
0564 000 020	WABCO 932 400 024 0



WABCO

Air dryer

Vehicle type	Actros I/MP2/MP3
Version	2 chamber system
Operating pressure	max. 13 bar
Opening pressure	14,5 ± 2,5 bar
Cut-off pressure	12 ± 0,3 bar
Voltage	24 V

Order number	Comparative number
0174 330 020	WABCO 432 433 002 0
0174 320 060	WABCO 432 433 206 0



WABCO

Air dryer

as replacement

Vehicle type	Actros I/MP2/MP3
Thread	M39 x 1.5
Operating pressure	max. 13 bar

Order number	Comparative number
3419 851 271	WABCO 432 410 222 7



Air dryer

Vehicle type	Actros I/MP2/MP3
Version	1-chamber system
Cut-off pressure	12,3 +/- 0,3 bar
Operating range	1,5 +/- 0,25 bar
Voltage	24 V

Order number

3450 409 045

Comparative number

Knorr II38310FN00



Air dryer

Vehicle type	Actros I/MP2/MP3
Version	1-chamber system
Cut-off pressure	12,3 +/- 0,3 bar
Operating range	1,5 +/- 0,25 bar
Voltage	24 V

Order number

3400 038 309

Comparative number

Knorr II38308FN00



Four-circuit protection valve

as replacement

Vehicle type	Actros I/MP2/MP3
Operating pressure	max. 13 bar

Order number

0577 050 050

Comparative number

WABCO 934 705 005 7



Pressure sensor

Vehicle type	Actros I/MP2/MP3
--------------	------------------

Order number

0210 435 011

Comparative number

WABCO 932 500 501 1



Pressure sensor

Vehicle type Actros I

Order number

3450 414 230

Comparative number

Knorr I139746F004



Compressed air tank

EN 286-2, steel

Vehicle type Actros I/MP2/MP3

Version with bracket

Volume 5 l

Diameter 154 mm

Length 341 mm

Connection 3 x M22 x 1.5

Operating pressure 10 bar

Order number

3620 001 545



Compressed air tank

EN 286-2, steel

Connection 4 x M22 x 1.5

Operating pressure max. 15.5 bar

Vehicle type	Volume l	Ø mm	Length mm	Order number
Actros I/MP2/MP3	10	206	368	3620 020 610
Actros I/MP2/MP3	20	246	493	3620 024 620
Actros I	20	276	414	3620 027 620
Actros I/MP2/MP3	30	276	583	3620 027 630



Compressed air tank

to EN 286-2, Aluminium

Vehicle type Actros I/MP2/MP3

Connection 2 x M22 x 1.5

Volume l	Ø mm	Length mm	Operating pressure bar	Order number
20	246	500	max. 12.5	1740 200 024
30	246	720	max. 12.5	1742 302 460
40	276	770	max. 12.5	1742 402 760
60	310	907	max. 10	1742 603 100



Air reservoir tensing strap

with bracket, 1-piece

Ø mm	Order number
206	1740 012 060
246	1740 022 460
276	1740 032 760
310	1740 043 100

Accessories

Tensing strap base

Length	1000 mm
Material	rubber

Order number	9085 413 340
--------------	--------------



Dehumidification valve

DIN 74292, standard B

Version	mechanical, with ring
Material	brass
Connection	M22 x 1,5
Operating pressure	20 bar
Spanner size	27

Order number	1740 060 020
--------------	--------------



WABCO

Braking-value sensor

EBS

Vehicle type	Actros I
Operating pressure	max. 10 bar
Thread	VOSS

Version	Connection 1-2	Connection 4	Order number	Comparative number
without silencer	M22 x 1,5	M16 x 1,6	0640 060 030	WABCO 480 001 000 0
with silencer	VOSS 232 NG 12	VOSS 232 NG 8	0360 010 100	WABCO 480 001 010 0



WABCO

Braking-value sensor

EBS

Vehicle type	Actros MP2/MP3
Version	with silencer
Operating pressure	max. 13 bar

Order number	Comparative number
3800 030 100	WABCO 480 003 000 0



WABCO

Hand brake valve

Vehicle type	Actros I
Operating pressure	max. 10 bar

Order number	Comparative number
0607 231 250	WABCO 961 723 125 0



KNORR-BREMSE

Hand brake valve

Vehicle type	Actros I
Version	lateral connections
Operating pressure	max. 10 bar

Order number	Comparative number
3400 006 770	Knorr K038804N00



KNORR-BREMSE

Hand brake valve

Vehicle type	Actros I
Operating pressure	max. 10 bar

Order number	Comparative number
3400 006 760	Knorr K038803N00



KNORR-BREMSE

Hand brake valve

Vehicle type	Actros I/MP2/MP3
Operating pressure	max. 10/8.5 bar

Order number	Comparative number
3401 970 066	Knorr K038808N00



WABCO

Motor coach brake valve

with VOSS 232 coupling unit

Vehicle type Actros I
Version lead 0.5 bar, control ratio 2:1, with silencer
Operating pressure max. 10 bar

Order number	Comparative number
0283 192 740	WABCO 461 319 274 0



WABCO

EBS trailer control valve

Vehicle type Actros I
Version connector, horizontal
Operating pressure max. 8.5 bar

Order number	Comparative number
0064 060 070	WABCO 480 204 002 0



WABCO

EBS axle modulator

Vehicle type Actros I

Order number	Comparative number
0362 000 037	WABCO 480 103 011 0



WABCO

EBS axle modulator

Vehicle type Actros I/MP2/MP3

Order number	Comparative number
3800 105 006	WABCO 480 105 006 0
3801 050 070	WABCO 480 105 007 0



WABCO

EBS relay valve

Vehicle type	Actros I/MP2
Version	proportional relay valve, with silencer
Thread	VOSS 232
Connection	electric, bayonet DIN
Connection 1-2	M22 x 1,5
Connection 4	M16 x 1,5

Order number	Comparative number
0640 060 040	WABCO 480 202 004 0



WABCO

EBS relay valve

Vehicle type	Actros MP3
Version	Proportional relay valve, with silencer
Thread	VOSS 232
Connection	electric, bayonet DIN
Connection 1-2	M22 x 1,5
Connection 4	M16 x 1,5

Order number	Comparative number
0392 020 090	WABCO 480 202 009 0



WABCO

Relay valve

Vehicle type	Actros I/MP2/MP3
Thread	VOSS 230
Connection	electric, bayonet (DIN)
Connection 1-2	M22 x 1,5
Connection 3	with muffler
Connection 4	M16 x 1,5

Order number	Comparative number
0640 060 037	WABCO 973 006 003 0



WABCO

Relay valve

Vehicle type	Actros I/MP2/MP3
Operating pressure	max. 10.2 bar
Thread	VOSS
Connection 1-2	M22 x 1,5
Connection 3	with muffler
Connection 4	M16 x 1,5

Order number	Comparative number
0640 110 040	WABCO 973 011 004 0

PASSION FOR SAFETY

Wir beliefern weltweit LKW-, Anhänger- und Bushersteller mit führenden Technologien für Brems-, Stabilitäts-, Federungs- und automatische Antriebssysteme. Unsere Innovationen erhöhen signifikant die Fahrzeugsicherheit und verbessern gleichzeitig deutlich die Fahrereffektivität.

Wir befassen uns dabei mit nahezu jedem denkbaren Unfall-szenario im Straßenverkehr. Unsere Leidenschaft gilt dem Ziel, bis 2020 die Zahl an Unfällen mit Nutzfahrzeugen um 50 % zu reduzieren.





WABCO

Solenoid control valve

for ABS

Vehicle type	Actros I/MP2/MP3
Installation location	rear axle
Voltage	24 V
Electric current	1,65 A
Connection	electric, bayonet (DIN)
Connection thread	M22 x 1.5 JED-388

Order number	Comparative number
0371 950 087	WABCO 472 195 016 0



WABCO

Speed sensor

S plus

Vehicle type Actros I/MP2/MP3

Illustration	Colour	Cable length mm	Order number	Comparative number
1	orange	2500	0210 329 200	WABCO 441 032 920 0
1	orange	3000	0210 329 420	WABCO 441 032 942 0
1	orange	3600	0210 329 460	WABCO 441 032 946 0
2	black	1500	0210 328 510	WABCO 441 032 851 0
2	black	2000	0210 328 230	WABCO 441 032 823 0
3	black	3400	0210 329 410	WABCO 441 032 941 0

Accessories

Clamping sleeve

Length 33 mm

Order number
0687 605 104

PASSION FOR INNOVATION

Wir beliefern weltweit LKW-, Anhänger- und Bushersteller mit führenden Technologien für Brems-, Stabilitäts-, Federungs- und automatische Antriebssysteme. Unsere Innovationen tragen dazu bei, die Fahrzeugsicherheit und -effizienz ständig zu verbessern und gleichzeitig die Umweltverträglichkeit zu erhöhen.

Seit Jahrzehnten sind wir federführend in der Entwicklung der entscheidenden Technologien unserer Branche: von der Entwicklung des Antiblockiersystems über elektronische Bremssysteme und autonome Notbremssysteme bis hin zu energieeffizienten Kompressoren. Wir arbeiten mit großer Leidenschaft daran, uns kontinuierlich als Technologieführer zu beweisen.

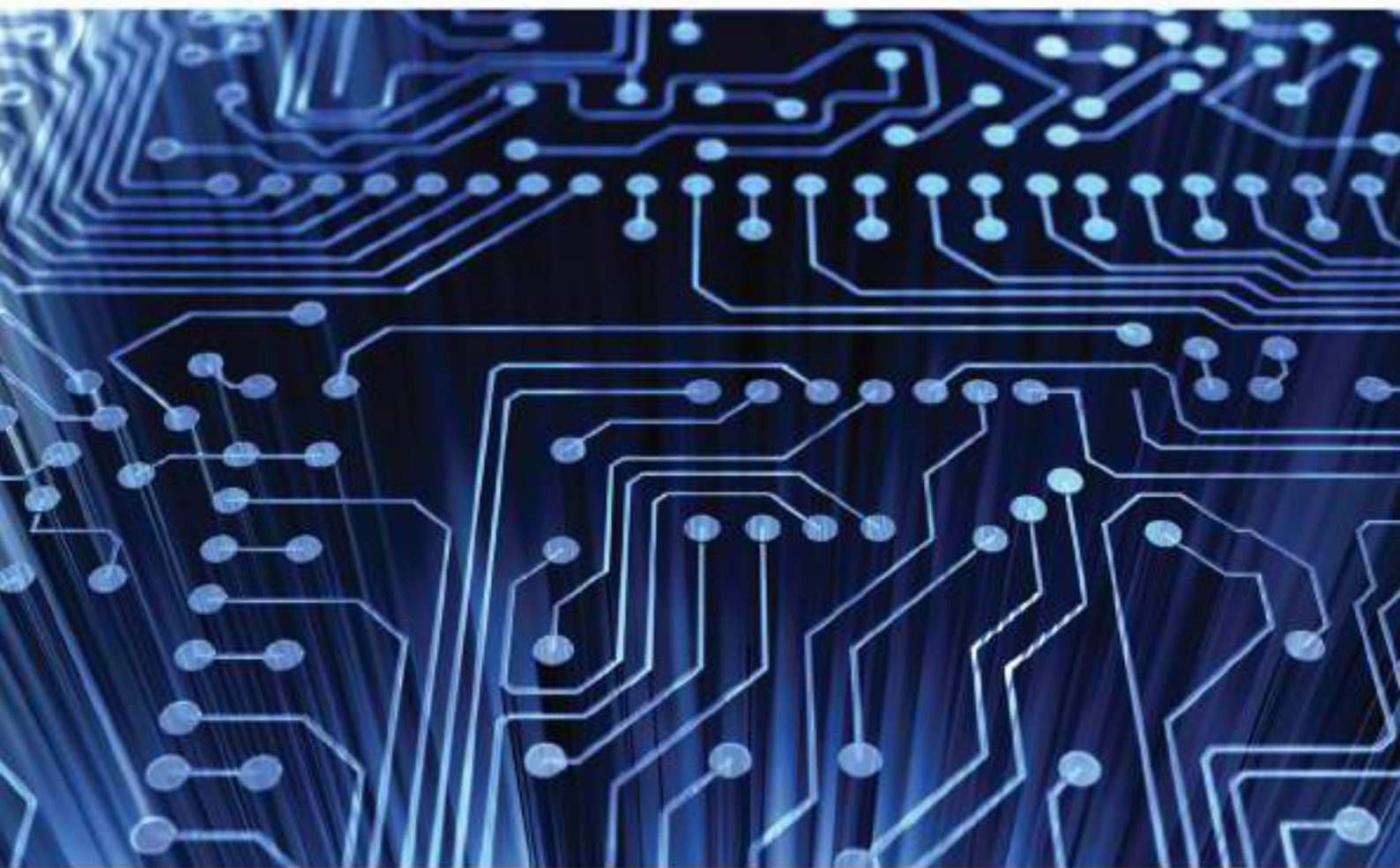
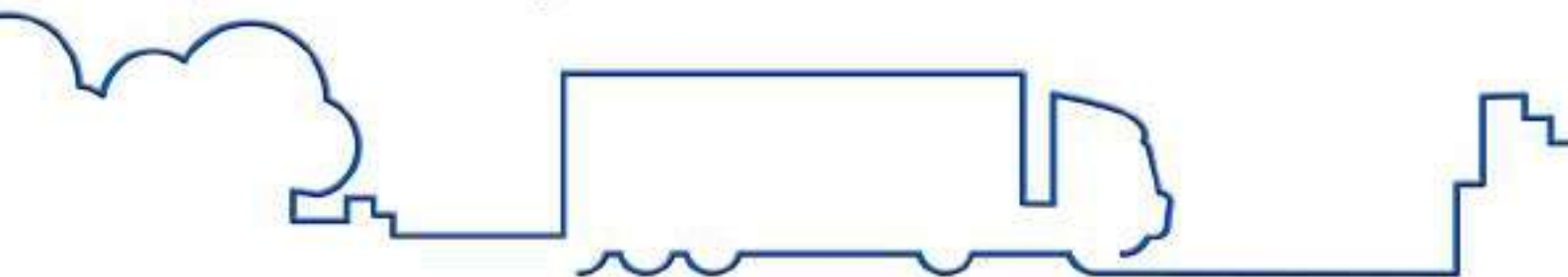



WABCO

Combination brake cylinder

Type 20/24 IBV

with VOSS 232 coupling unit

Vehicle type	Actros I/MP3
Installation location	rear axle
Connection	M22 x 1.5, VOSS NG 12
Operating pressure	max. 10.2/8.5 bar
Stroke	64/64 mm
Length of piston rod	15 mm

Installation side	Order number	Comparative number
left	0554 600 010	WABCO 925 480 005 0
right	0554 600 000	WABCO 925 480 004 0



WABCO

Combination brake cylinder

Type 12/16 IBV

Vehicle type	Actros MP3
Installation location	rear axle
Installation side	left/right
Connection	M22 x 1.5, VOSS 232
Operating pressure	max. 10.2/8.5 bar
Stroke	57/57 mm
Length of piston rod	15 mm

Order number	Comparative number
0554 661 010	WABCO 925 486 101 0



WABCO

Combination brake cylinder

Type 20/24 IBV

with VOSS 232 coupling unit

Vehicle type	Actros I/MP2/MP3
Installation location	rear axle
Connection	M22 x 1.5, VOSS NG12
Operating pressure	max. 10.2/8.5 bar
Stroke	64/64 mm
Length of piston rod	15 mm

Installation side	Order number	Comparative number
left	0554 600 110	WABCO 925 480 011 0
right	0554 600 100	WABCO 925 480 010 0



Membrane brake cylinder

Type 24

with VOSS 232 coupling unit

Vehicle type	Actros I/MP2/MP3
Installation location	front axle
Connection 1	side, M22 x 1.5, VOSS NG 12
Connection 2	central, M12 x 1.5
Stroke	64 mm
Length of piston rod	15 mm

Installation side	Order number	Comparative number
left	3405 351 500	Knorr K002720N00
right	3405 351 400	Knorr K002624N00



Membrane brake cylinder

Type 24

Vehicle type	Actros MP3
Installation location	front axle
Connection 1	M22 x 1.5
Connection 2	M12 x 1.5
Stroke	64 mm
Length of piston rod	15 mm

Installation side	Order number	Comparative number
right	3405 351 600	Knorr K002721N00
left	3405 352 200	Knorr K002722N00

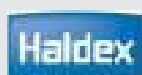

Membrane brake cylinder

Type 24

with clutch unit VOSS 232

Vehicle type	Actros MP3
Installation location	Front axle
Connection 1	on the side, M22 x 1.5, VOSS NG 12
Installation side	left, right
Stroke	64 mm
Length of piston rod	15 mm

Order number	Comparative number
3779 021 830	Haldex 125 240 400



Combination brake cylinder

Type 20/24

with VOSS 232 coupling unit

Vehicle type	Actros I
Installation location	rear axle
Connection	M22 x 1.5
Stroke	57/57 mm
Length of piston rod	15 mm

Installation side	Order number	Comparative number
left	3400 009 492	Knorr K004032000
right	3400 009 491	Knorr K004031000



Combination brake cylinder

Type 20/24

with VOSS 232 coupling unit

Vehicle type	Actros MP2
Installation location	rear axle
Connection	M22 x 1.5
Stroke	64/64 mm
Length of piston rod	15 mm

Installation side	Order number	Comparative number
left	3404 045 000	Knorr K004045000
right	3404 044 000	Knorr K004044000



Combination brake cylinder

Type 20/24 HFL3

with VOSS 232 coupling unit

Vehicle type	Actros I
Installation location	rear axle
Connection	M22 x 1.5, VOSS NG 12
Stroke	64/64 mm
Length of piston rod	15 mm

Installation side	Order number	Comparative number
left	3400 019 060	Knorr K002860N00
right	3400 046 505	Knorr K002861N00

**WABCO****Clutch servo****in exchange**

Vehicle type	Actros I
Piston diameter	102 mm
Connection	M16 x 1.5
Stroke	85 mm
Operating pressure	max. 10 bar

Order number**0730 514 057****Comparative number**

WABCO 970 051 431 7

**WABCO****Clutch servo**

Vehicle type	Actros MP2/MP3
Connection	M16 x 1.5
Stroke	85 mm
Operating pressure	max. 10 bar

Order number**0730 514 410****Comparative number**

WABCO 970 051 441 0

**Coupling head****automatic**

Version with valve

Version	Connection thread	Colour	Order number
brake line	M16 x 1.5	yellow	3700 000 011
brake line	M22 x 1.5	yellow	3700 000 013
supply line	M16 x 1.5	red	3700 000 012
supply line	M22 x 1.5	red	3700 000 014

**Coupling head****automatic**

Version	supply line
Connection thread	M16 x 1.5

Order number**3700 000 008**



WABCO

ECAS path sensor

for air suspension

Vehicle type Actros I, Atego II
 Connection bayonet DIN 72585-A1-2.1-Sn/K2

Order number
0210 500 120

Comparative number
 WABCO 441 050 012 0



WABCO

ECAS path sensor

for air suspension

Vehicle type Actros MP2/MP3
 Connection bayonet DIN 72585-A1-2.1-Sn/K2

Order number
9465 422 618

Comparative number
 WABCO 441 050 121 0



WABCO

ECAS solenoid valve

Vehicle type Actros I/MP2
 Installation location rear axle
 Version 3 magnets, with silencer
 Connection electric, bayonet DIN
 Connection thread M22 x 1.5
 Voltage 24 V
 Operating pressure max. 13 bar

Order number
0379 000 600

Comparative number
 WABCO 472 900 060 0

Accessories

Muffler

Diameter 69 mm
 Height 45/56.5 mm
 Operating pressure max. 13 bar
 Connection M22 x 1.5

Order number
0174 070 000



WABCO

ECAS solenoid valve

Vehicle type	Actros MP2
Installation location	Rear axle
Version	with muffler
Connection	electric, bayonet DIN
Connection thread	M22 x 1.5
Voltage	24 V
Operating pressure	max. 13 bar

Order number

0378 800 000

Comparative number

WABCO 472 880 000 0



WABCO

ECAS solenoid valve

Vehicle type	Actros MP3
Installation location	rear axle, tag axle
Version	with noise reducer, solenoid connection at top
Connection	electric, 2 x bayonet (DIN)
Connection thread	M22 x 1.5, VOSS 230
Voltage	24 V
Operating pressure	max. 5-13 bar

Order number

0379 051 110

Comparative number

WABCO 472 905 111 0



WABCO

ECAS control unit

Vehicle type	Actros I
System	6 x 2
Voltage	24 V

Order number

0761 700 520

Comparative number

WABCO 446 170 055 0



WABCO

Central module

Vehicle type	Actros I
Version	4S/4M

Order number

0362 000 030

Comparative number

WABCO 446 130 014 0



Assortment case

for VOSS connector system 230, complete

Version	Order number
42-piece	0307 001 415

Contents

Number	Description	Dimensions mm	Order number
2	Straight connector	NG 8, Pipe connector 6 x 1	0307 000 050
2	Straight connector	NG 8, Pipe connector 9 x 1,5	0307 000 350
2	Straight connector	NG 12, Pipe connector 9 x 1,5	0307 000 180
2	Straight connector	NG 12, Pipe connector 12 x 1,5	0307 000 200
1	Straight connector	NG 12, Pipe connector 16 x 2	0307 000 060
1	Tee plug connector	NG 12, Pipe connector 12 x 1,5	0307 001 960
1	Angled plug	NG 8, 90°, Pipe connector 6 x 1	0307 000 070
2	Angled plug	NG 8, 90°, Pipe connector 8 x 1	0307 000 340
2	Angled plug	NG 12, 90°, Pipe connector 8 x 1	0307 000 220
2	Angled plug	NG 12, 90°, Pipe connector 12 x 1,5	0307 000 230
6	Gasket set for connectors	NG 8	9460 002 310
6	Gasket set for connectors	NG 12	9460 002 311
4	Union bolt	NG 8, M16 x 1.5	0307 000 030
4	Union bolt	NG 12, M22 x 1.5	0307 000 160
1	Threaded compression adapter	NG 8, M16 x 1.5	3800 022 601
1	Straight screw-in coupling	NG 12, M16 x 1.5	0307 000 300
1	Straight screw-in coupling	NG 12, M22 x 1.5	0307 000 240
1	Sealing plug	NG 8	0307 001 990
1	Sealing plug	NG 12	0307 001 980



Assortment case

for VOSS connector system 232, complete

Version	Order number
381-piece	0307 000 145

Contents

Number	Description	Type	Dimensions mm	Order number
4	Straight coupling	232	NG 8, Pipe connector 8 x 1	0307 124 325
4	Straight coupling	232	NG 12, Pipe connector 12 x 1,5	0307 124 330
10	Adapter for units with step drilling	230	NG 6	0307 000 194
4	Straight screw-in coupling	232	NG 8, M16 x 1.5	0307 124 220
4	Straight screw-in coupling	232	NG 12, M16 x 1.5	0307 124 290
4	Straight screw-in coupling	232	NG 12, M22 x 1.5	0307 124 310
20	Union bolt	230	NG 6, M10 x 1	0307 003 300
6	Union bolt	230	NG 8, M16 x 1.5	0307 000 030
6	Union bolt	230	NG 12, M22 x 1.5	0307 000 160
12	Union bolt	232	NG 8, M16 x 1.5	0307 124 700
12	Union bolt	232	NG 12, M22 x 1.5	0307 124 695
10	Straight connector	230	NG 6, Pipe connector 6 x 1	0307 003 430
15	Straight connecting plug	232	NG 8, Pipe connector 8 x 1	0307 124 360
5	Straight connecting plug	232	NG 12, Pipe connector 8 x 1	0307 124 395
9	Straight connecting plug	232	NG 12, Pipe connector 12 x 1,5	0307 124 400
10	Sealing plug	232	NG 8	0307 124 755
3	Sealing plug	232	NG 12	0307 124 760
10	Straight quick-fit coupling	230	Pipe diameter 6	0307 003 060
4	Angled plug	230	NG 6, 90°, Pipe connector 6 x 1	0307 000 055
10	Angled plug	232	NG 8, 90°, Pipe connector 8 x 1	0307 124 945
6	Angled plug	232	NG 12, 90°, Pipe connector 8 x 1	0307 124 970
6	Angled plug	232	NG 12, 90°, Pipe connector 12 x 1,5	0307 124 975
2	Tee plug connector	232	NG 12, Pipe connector 12 x 1,5/8 x 1	0307 124 660
1	Tee plug connector	232	NG 12, Pipe connector 12 x 1,5/12 x 1,5	0307 124 680
30	O-ring, Mud ring	232	NG 8, 7.5 x 2	0307 239 961
30	O-ring, Mud ring	232	NG 12, 12 x 2	0307 449 961
30	O-ring, Sealing ring	232	NG 8, 7 x 1.5	5239 390 055
30	O-ring, Sealing ring	232	NG 12, 12 x 1.6	0307 089 971
30	O-ring, Mud ring	230	NG 6, 5.5 x 1.5	0307 159 972
30	O-ring, Sealing ring	230	NG 6, 3.5 x 1.5	0307 149 971
20	Spring element	230	NG 6, 6.5	0307 062 179
6	Spring element	230	NG 8, 9.7	0307 000 040
6	Spring element	230	NG 12, 15.2	0307 000 170
20	Clamp	230	NG 6, 7.4	0307 016 900
6	Clamp	230	NG 8, 11.6	0307 000 020
6	Clamp for 6 tube	230	NG 12, 17.6	0307 000 150



H4 main headlamp

Vehicle type	Actros I
Version	with indicator, high beam and side light
Voltage	24 V

Installation side	Application	Order number
left	for vehicles without headlight levelling	3600 100 030
right	for vehicles without headlight levelling	3600 100 040
left	for vehicles with headlight levelling (electric)	3600 100 055
right	for vehicles with headlight levelling (electric)	3600 100 060

Service parts

Description	Order number
Side light/indicator lens, left	3600 100 015
Side light/indicator lens, right	3600 100 025
Reflector, left	3605 321 867
Reflector, right	3605 321 868
H4 halogen headlamp bulb	8900 006 000
Bulb, Drop-shaped, 24 V, 21 W	8900 003 000
Bulb, Drop-shaped, BA 15 s, 24 V, HD version	8900 010 000
Glass-base bulb, 24 V, 5 W	8900 040 130



H4 main headlamp

Vehicle type	Actros I
Voltage	24 V

Application range

for vehicles with headlight levelling (electric)

Installation side	Version	Order number
left	with high beam and side light	9468 204 761
right	with high beam and side light	9468 204 861
left	with indicator and fog light	9468 204 361
right	with indicator and fog light	9468 204 461

Service parts

Description	Order number
Side light/indicator lens, left	3600 100 015
Side light/indicator lens, right	3600 100 025
Reflector, left	3600 321 871
Reflector, right	3600 321 872
H1 halogen headlamp bulb	8900 040 100
H4 halogen headlamp bulb	8900 006 000
Bulb, Drop-shaped, 24 V, 21 W	8900 003 000
Bulb, Drop-shaped, BA 15 s, 24 V, HD version	8900 010 000
Glass-base bulb, 24 V, 5 W	8900 040 130

Headlamp adjustment equipment available from EUROPART!



H4/H1 main headlamp

Vehicle type	Actros I
Version	with high beam, fog and side light
Voltage	24 V

Application range

for vehicles without headlight levelling

Installation side	Order number
left	3600 100 045
right	3600 100 050

Service parts

Description	Order number
Side light/indicator lens, left	3600 100 015
Side light/indicator lens, right	3600 100 025
Reflector, left	3600 321 871
Reflector, right	3600 321 872
H1 halogen headlamp bulb	8900 040 100
H4 halogen headlamp bulb	8900 006 000
Bulb, Drop-shaped, 24 V, 21 W	8900 003 000
Bulb, Drop-shaped, BA 15 s, 24 V, HD version	8900 010 000
Glass-base bulb, 24 V, 5 W	8900 040 130



Xenon headlamp

Vehicle type	Actros MP2
Version	with indicator, high beam and side light
Socket	D2R
Bulb type	H1/Xenon
Voltage	24 V

Application range

for vehicles without headlight range adjustment (electric)

Installation side	Order number
left	9468 200 961
right	9468 201 061

Service parts

Description	Order number
Side light/indicator lens, left	0170 064 011
Side light/indicator lens, right	0170 064 021
Gas discharge lamp, P32d-2, 35 W	0007 949 101
H1 halogen headlamp bulb, P 14,5 s, 70 W	8900 040 100
Bulb, 24 V, 21 W, yellow	9560 013 496
Glass-base bulb, 24 V, 5 W	8900 040 130



H7/H1 main headlamp

Vehicle type	Actros MP2/MP3
Version	with indicator, high beam and parking light
Voltage	24 V

Installation side	Version	Order number
left	for vehicles without headlight levelling	9501 658 202
right	for vehicles without headlight levelling	9501 658 203
left	for vehicles with headlight levelling (electric)	9501 658 200
right	for vehicles with headlight levelling (electric)	9501 658 201

Service parts

Description	Order number
Side light/indicator lens, left	0170 064 011
Side light/indicator lens, right	0170 064 021
H1 halogen headlamp bulb, P 14,5 s, 70 W	8900 040 100
H7 halogen headlamp bulb, PX 26 d, 70 W	8900 001 030
Bulb, 24 V, 21 W, yellow	9560 013 496
Glass-base bulb, 24 V, 5 W	8900 040 130



H7/H1 main headlamp

Vehicle type	Actros MP3
Version	with indicator, high beam and side light
Voltage	24 V

Installation side	Version	Order number
left	for vehicles without headlight levelling	9269 513 011
right	for vehicles without headlight levelling	9269 513 021
left	for vehicles with headlight range adjustment (electric)	9501 658 224
right	for vehicles with headlight range adjustment (electric)	9501 658 225

Service parts

Description	Order number
Side light/indicator lens, left	0170 064 011
Side light/indicator lens, right	0170 064 021
H1 halogen headlamp bulb	8900 040 100
H7 halogen headlamp bulb, PX 26 d, 70 W	8900 001 030
Headlight frame, left	0165 229 031
Headlight frame, right	0165 230 031
Bulb, 24 V, 21 W, yellow	9560 013 496
Glass-base bulb, 24 V, 5 W	8900 040 130
Bracket, left	9468 806 414
Bracket, right	9468 806 514
Plastic cable tie	3237 000 047



Xenon headlamp

Vehicle type	Actros MP2/MP3
Version	with indicator, high beam and parking light
Socket	D1S/H1/PY21W/W5W
Voltage	24 V

Application range

for vehicles without headlight range adjustment, without setting motor

Installation side	Order number
left	9501 658 206
right	9501 658 207

Service parts

Description	Order number
Side light/indicator lens, left	0170 064 011
Side light/indicator lens, right	0170 064 021
H1 halogen headlamp bulb, P 14,5 s, 70 W	8900 040 100
H7 halogen headlamp bulb, PX 26 d, 70 W	8900 001 030
Headlight frame, left	0165 229 031
Headlight frame, right	0165 230 031
Bulb, 24 V, 21 W, yellow	9560 013 496
Glass-base bulb, 24 V, 5 W	8900 040 130
Gas discharge lamp, 85 V, 35 W	2748 541 000
Bracket, left	9468 806 414
Bracket, right	9468 806 514
Plastic cable tie	3237 000 047



H3 spotlight

Vehicle type	Actros I
Width	175.3 mm
Height	89 mm
Depth	78 mm
Voltage	12 V

Installation side	Order number
left	3600 100 085
right	3600 100 090

Accessories

H3 halogen headlamp bulb

Voltage	24 V
Power	70 W

Order number
8900 009 000



H3 spotlight

Vehicle type	Actros I
Width	195 mm
Height	103 mm
Depth	98 mm
Voltage	24 V

Installation side	Order number
left	9648 207 656
right	9648 207 756

Accessories

Description	Order number
H3 halogen headlamp bulb, 24 V, 70 W	8900 009 000
Mounting frame, left	9648 261 759
Mounting frame, right	9648 261 859



H3 fog light

Vehicle type	Actros I
Width	175.3 mm
Height	89 mm
Depth	78 mm
Voltage	24 V

Installation side	Order number
left	3600 100 080
right	3600 100 065

Accessories

H3 halogen headlamp bulb

Voltage	24 V
Power	70 W

Order number
8900 009 000



H3 fog light

Vehicle type	Actros I
Width	195 mm
Height	103 mm
Depth	98 mm
Voltage	24 V

Scope of supply

with bulbs

Installation side	Order number
left	9648 207 856
right	9648 207 956

Accessories

Description	Order number
H3 halogen headlamp bulb, 24 V, 70 W	8900 009 000
Mounting frame, left	9648 261 759
Mounting frame, right	9648 261 859



H3 fog light

Vehicle type	Actros MP2/MP3
Width	300 mm
Height	120 mm
Depth	130 mm
Voltage	24 V

Installation side	Order number
left	9500 440 200
right	9500 440 201

Accessories

H3 halogen headlamp bulb

Voltage	24 V
Power	70 W

	Order number
	8900 009 000



Indicator light

Vehicle type	Actros I
Installation location	front
Installation side	left, right
Voltage	24 V
Colour	yellow

Scope of supply

with cable and circular connector

	Order number
	1325 063 537

Accessories

Bulb

Voltage	24 V
Power	21/5 W

	Order number
	8900 013 000

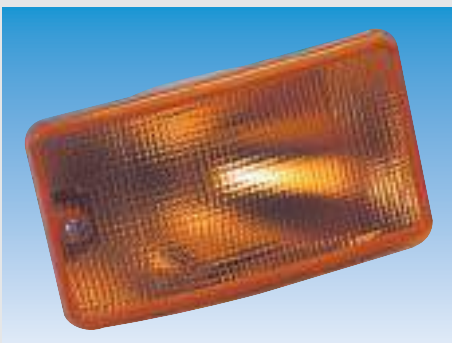

Indicator light

Vehicle type	Actros I
Installation location	front
Installation side	left/right
Width	102 mm
Height	75 mm
Depth	68 mm
Voltage	24 V
Colour	yellow

Scope of supply

with bulb

	Order number
	9460 009 937

Accessories

Bulb

Description	Order number
for indicator, brake, rear fog, reversing lights, 24 V, 21 W	8900 003 000
for brake/tail light, 24 V, 21/5 W	8900 013 000



Indicator light

Vehicle type	Actros I/MP2
Installation location	front, bottom
Width	102 mm
Height	75 mm
Depth	68 mm
Socket	BA 15 s/BAY 15 d
Voltage	24 V
Colour	yellow

Scope of supply

with connection cable

Installation side	Order number
left	6170 463 536
right	6170 463 559

Accessories

Description	Order number
Bulb for indicator, brake, rear fog, reversing lights, 24 V, 21 W	8900 003 000
Bulb for brake/tail light, 24 V, 21/5 W	8900 013 000
Bulb socket	9460 463 655



Position light

Parklight

Vehicle type	Actros I/MP2/MP3
Version	with rubber underlay
Installation side	left, right
Width	53.5 mm
Height	48 mm
Depth	68,2 mm
Socket	BA15s
Bulb type	R10W
Voltage	12/24 V
Colour	yellow

Order number
0006 679 017

Accessories

Bulb

Voltage	24 V
Power	10 W
Bulb type	R10W

Order number
8900 002 000

Echt HELLA. Wie der Name schon sagt.

Originalteile-Qualität und
innovatives Zubehör vom
Marktführer für Beleuchtung.



Entdecken Sie in drei sicherheitsrelevanten Bereichen die LED-Kompetenz von HELLA:

1. Zusatz-Fernscheinwerfer HELLA Luminator LED* mit Positionslicht. *Sorgt jede Nacht für eine gute Nacht.*
Hochleistungs-LED für klares, kaltweißes Fernlicht. LED-Positionslicht in Kartoval®-Optik. Gleichmäßige Lichtverteilung und hervorragende Fahrbahnausleuchtung durch Dreifach-Reflektor. Perfekte Ausleuchtung durch computeroptimierte Feinabstimmung von LED-Leuchtmittel und Frei-Flächentechnik. Schwarzes Aluminium-Gehäuse. Verchromter Glasring. Das Licht für die entspannte, ausgewogene Fahrweise.

* De-minimis förderfähig.

2. LED-Arbeitscheinwerfer Flat Beam*. *Extrem flach, extrem lichtstark. Ideal z. B. für die Führerhausrückwand.*
Gibt dem Auf- und Absatteln bei Nacht eine völlig neue Sicherheitsdimension. Realisiert mit 11 Watt die gleiche Lichtmenge wie ein H3-Halogencheinwerfer mit 70 Watt.

3. Kennleuchte KL 7000 LED*. *Hohe Lebensdauer. Optimales Signalbild bei geringer Leistungsaufnahme.*
Rundumfunktion ohne bewegliche Teile. Vorhandene Halogen-Versionen können mit der vorhandenen Verkabelung ohne Austausch des Basisgehäuses auf LED umgerüstet werden.



HELLA unterstützt die Kraftfahrer-Initiative Ytop
www.y-top.de

HELLA KGaA Hueck & Co.
Riabecker Straße 75,
59552 Lippstadt / Germany
www.hella.de/truck





Position light

Vehicle type	Actros I/MP2/MP3
Installation side	left/right
Width	100 mm
Height	40 mm
Voltage	12/24 V
Fastening	2 x 4,2 mm, hole spacing 82 mm
Socket	SV 8,5
Colour	white

Application range

for vehicles with sun visor

Order number

1325 063 538

Service parts

Description

Description	Order number
Lens, left/right, white	0137 241 001
Bulb, 24 V, 5 W	8900 005 000



Position light

Vehicle type	Actros I/MP2/MP3
Installation side	left/right
Width	100 mm
Height	40 mm
Socket	SV 8,5
Bulb type	C5W
Voltage	24 V
Power	5W
Plug type	2 flat plugs
Fastening	2 x 4.2 mm, hole spacing 82 mm
Colour	white

Scope of supply

with bulb holder

Application range

for vehicles without sun visor

Order number

0961 167 021

Service parts

Description

Description	Order number
Lens, left/right, white	0137 241 001
Bulb, 24 V, 5 W	8900 005 000



LED side marker light

Vehicle type	Actros I/MP2/MP3
Installation side	left, right
Voltage	24 V
Colour	yellow

Version	Order number
with connector, 2-pin	8000 463 509
with 0.5 m cable, 90° cable connection, reverse light	9505 940 112

Accessories

Description	Order number
Connector set	9465 401 581



Side marker light

Vehicle type	Actros I
Version	with reflector, without seal
Installation side	left/right
Width	41 mm
Height	110 mm
Depth	35,2 mm
Voltage	24 V
Fastening	2 x 5.2 mm
Distance between centres	75 mm
Colour	yellow

Order number
9465 444 111

Accessories

Description	Order number
Glass-base bulb, 24 V, 3 W	3610 002 841
Lamp holder, with diaphragm ventilation	9641 520 337
Contact carrier	9463 303 870
Plug housing, AMP, 2-pin	9501 245 102
Plug housing, AMP, 2-pin, handle on housing	9501 002 420
Cable grommet, straight	9501 002 248
Cable grommet, 90° angle	9501 002 249



Clearance light

Rear-Logic

Vehicle type	Actros I
Width	42 mm
Height	109.3 mm
Depth	56,2 mm
Voltage	12/24 V
Type	surface-mounting
Colour	white/red/amber

Installation side	Order number
left	0007 841 011
right	0007 841 021

Accessories

Description	Order number
Bulb, spherical, 24 V, 10 W	8900 002 000
Lens, yellow	0146 838 001
Lens, black	0148 673 021



Rear light

Vehicle type	Actros I/MP2/MP3
Width	425 mm
Height	110 mm
Depth	82 mm
Socket	BA15s/P21W/R10W
Voltage	12/24 V
Connection	Cable grommet
Fastening	2 x M8
Pin spacing	152 mm

Installation side	Version	Order number
left	with indicator, brake, tail and rear fog light, reflector	4300 218 011
right	with indicator, brake, tail and reversing light, reflector	4300 218 012
left	with indicator, brake, tail, rear fog and number plate light, reflector	8840 218 013
right	with indicator, brake, tail and rear fog light, reflector	8840 218 014

Service parts

Description	Order number
Lens, left/right, with rear fog light	4300 218 111
Lens, left/right, with reversing light	4300 218 112
Bulb, for indicator, brake, rear fog, reversing lights, 24 V, 21 W	8900 003 000
Bulb, for tail, licence plate, position and interior lights, 24 V, 10 W	8900 002 000
Nozzle	0141 941 001



PROPLAST
FARBSTREIFENLEUCHTUNG

Rear light

Vehicle type	Actros I/MP2/MP3
Width	139 mm
Height	525 mm
Depth	84,5 mm
Socket	BA 15 s
Voltage	24 V
Connection	Round connector
Pin spacing	200 mm

Installation side	Version	Order number
left	with indicator, brake, tail, rear fog, reversing, number plate, clearance and side marker light, reflector	8840 220 203
right	with indicator, stop, tail, rear fog, reversing, clearance and side marker light, reflector	8840 220 202

Service parts

Description	Order number
Lens, left, with rear fog, indicator, stop, reversing and taillight	1040 000 009
Lens, right, with indicator, stop, reversing, taillight	1040 000 010
Bulb, for indicator, brake, rear fog, reversing lights, 24 V, 21 W	8900 003 000
Bulb, for tail, licence plate, position and interior lights, 24 V, 10 W	8900 002 000



H1 rotating beacon

Version	Halogen
Type	surface-mounting
Voltage	24 V
Dimensions	155 x 194 mm
Colour	yellow

Scope of supply

with bulb

Order number
0008 061 111

Accessories

Base

Material	Rubber
Diameter	155 mm

Form	Order number
flat	0862 164 001
wedge-shaped	8000 005 762



Indicator switch

Vehicle type	Actros I/MP2/MP3
Installation side	left
Voltage	24 V
Cable length	560 mm

Order number
9465 453 125



Light switch

Vehicle type	Actros I
Version	Rotary knob
Colour	black
Material	Plastic

Order number
1325 060 695



Light switch

Vehicle type	Actros MP2/MP3
Version	Rotary switch
Colour	black
Material	Plastic

Order number
(on request) 9465 450 904

Pressure switch

Vehicle type	Actros I/MP2/MP3
Voltage	24 V

Installation location	Switching pressure bar	Order number
Brake circuit III/IV	5,5	9465 455 414
Rear axle	6,5	6170 463 109

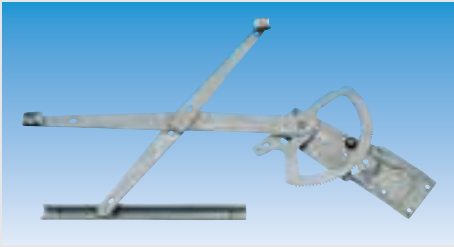

Window winder

electrical

Vehicle type Actros I

Installation side	Order number
left	8000 461 924
right	8000 461 925



Window winder

electric, with motor

Vehicle type Actros I/MP2/MP3

Installation side	Order number
left	3870 050 964
right	3870 050 965

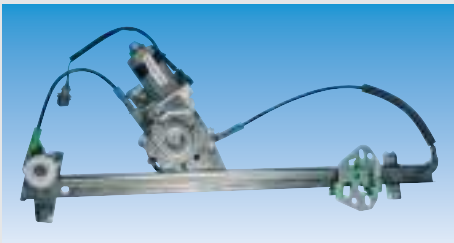

Window winder

electric, with motor

Vehicle type Actros I/MP2/MP3

Installation side	Order number
left	5828 722 346
right	1325 063 373



Electric motor

for window regulators

Vehicle type Actros I

Installation side	Order number
left	5828 820 043
right	8000 463 381



Electric motor

for window regulators

Vehicle type Actros MP2/MP3

Installation side	Order number
left	1325 004 908
right	1325 002 908



Starter Motor

Vehicle type	Actros I/MP2/MP3
Voltage	24 V
Power	6.2 kW
Number of teeth	11
Flange	3-hole flange
Flange diameter	92 mm
Fastening	75°

Order number
7063 000 217



Starter Motor

Vehicle type	Actros I/MP2/MP3
Voltage	24 V
Power	6.2 kW
Number of teeth	11
Flange	3-hole flange
Flange diameter	92 mm
Fastening	81°

Order number
7063 002 371



Starter Motor

Vehicle type	Actros I/MP2/MP3
Voltage	24 V
Power	6.2 kW
Number of teeth	11
Flange	3-hole flange
Flange diameter	92 mm
Fastening	85°

Order number
7063 002 370



Starter Motor

with reduction gear

Vehicle type	Actros I/MP2/MP3
Voltage	24 V
Power	7.5 kW
Number of teeth	12
Flange	3-hole
Flange diameter	92 mm

Order number
9461 511 501

**EURO
PART**
Alternator

Vehicle type	Actros MP3
Version	with belt pulley
Pulley diameter	72 mm
Voltage	24 V
Charging current	80 A
Flange	3-hole flange

Order number
7063 001 031

**EURO
PART**
Alternator

Vehicle type	Actros I/MP2/MP3
Version	with belt pulley
Pulley diameter	77 mm
Voltage	28 V
Charging current	80 A
Flange	3-hole flange

Order number
7063 001 032

**EURO
PART**
Alternator

Vehicle type	Actros I/MP2/MP3
Version	without belt pulley
Voltage	28 V
Charging current	80 A
Flange	3-hole flange

Order number
7063 000 003

Alternator

Vehicle type	Actros I/MP3
Version	right stop, without pulley
Voltage	24 V
Charging current	140 A
Flange	2-hole

Order number
1902 533 300

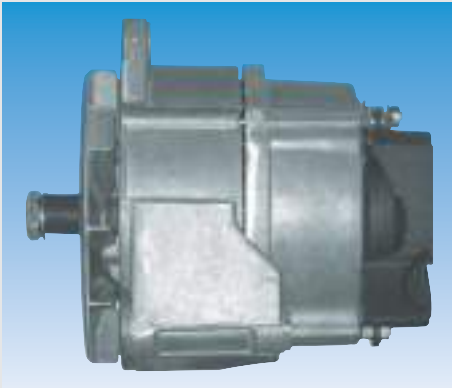

Alternator

Vehicle type	Actros I/MP2/MP3
Version	with belt pulley
Pulley diameter	77 mm
Voltage	24 V
Charging current	100 A
Flange	3-hole

Order number
5240 860 563



Alternator

Vehicle type	Actros I/MP2/MP3
Version	without pulley
Voltage	24 V
Charging current	110 A
Flange	3-hole

Order number
5240 860 807

EUROPART® – a powerful brand

Alongside well-known manufacturer's brands, EUROPART also offers a strong assortment of its own-brand products with more than 5000 items from the various EUROPART ranges.

Your advantages:

- Low-cost alternative for OE standard
- Maximum availability at 200 locations in 28 countries
- Increase your competitiveness
- Consistent service package



Compressor cool box

CoolMatic CS-MP2

custom-made compressor box operates quietly in the drawer under the driver's bed, (L or LH cab), inviting interior lighting, generous volume, top cooling power with minimal power consumption, fully hermetic Danfoss BD35F compressor with integrated control electronics, undervoltage protection, electronic fuse/automatic protection against polarity inversion, dynamically ventilated wire tube condenser, back-foamed coiled-pipe evaporator, steplessly adjustable thermostat with switch on/off function

current consumption: 1.13 Ah/h at +20 °C ambient temperature, 1.88 Ah/h at +32 °C ambient temperature (at +5 °C temperature inside device in each case)

average power consumption approx. 45 W

Vehicle type	Actros MP2/MP3
Volume	25 l
Material	polystyrene
Voltage	12/24 V
Temperature range	+10 to 0 °C
Length	554 mm
Width	451 mm
Height	219 mm
Weight	12.5 kg

Order number

9710 004 714



Top quality at
a fair price.



Front grille

Vehicle type Actros I
 Colour black

Order number
 9467 510 518

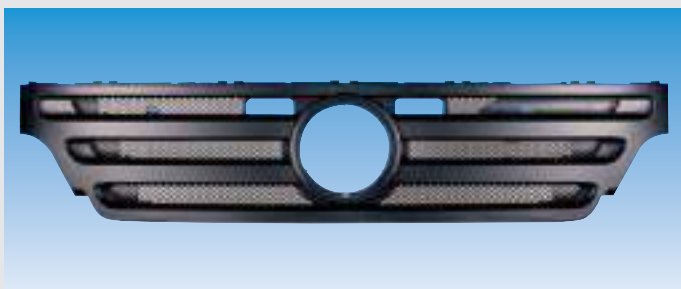

Front grille

Vehicle type Actros MP2
 Driver cab short, medium-long, long
 Colour black

Order number
 9190 500 218

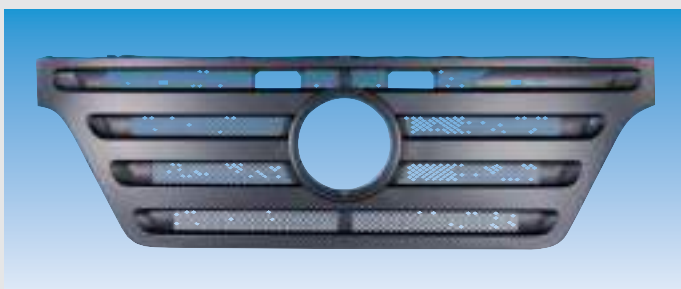

Front grille

Vehicle type Actros MP2
 Driver cab Megaspace

Order number
 8256 000 154

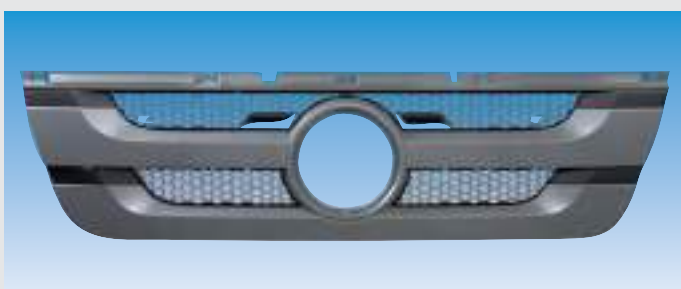

Front grille

Vehicle type Actros MP3
 Driver cab short, medium-long, long

Order number
 9190 501 418

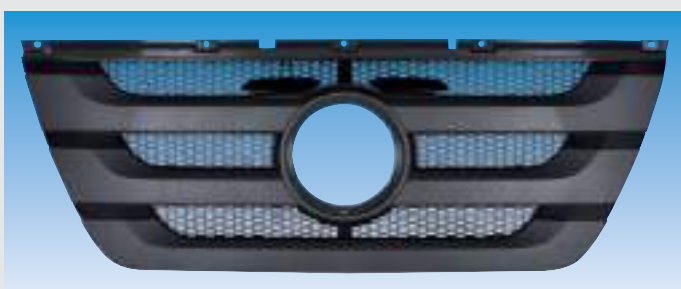

Front grille

Vehicle type Actros MP3
 Driver cab Megaspace

Order number
 (on request) 9467 501 518



Bumper

Vehicle type	Actros I
Driver cab	short, medium-long, long
Material	plastic
Colour	grey

Installation side	Order number
left	9190 000 521
centre, top	9190 800 303
right	9190 000 520

Accessories

Description	Installation side	Order number
Foot step	centre, top	9460 066 305
Flap	centre	9460 066 307
Step-up	centre, bottom	9190 801 670

Bumper

Vehicle type	Actros I
Driver cab	short, medium-long, long
Material	steel
Colour	grey

Application range

Construction site vehicles

Installation side	Order number
left	(on request) 9468 806 170
centre, top	9190 800 303
right	9468 806 270

Accessories

Description	Installation side	Order number
Foot step	centre, top	9460 066 305
Flap	centre	9460 066 307
Step-up	centre, bottom	(on request) 9468 805 370



Rear apron

Vehicle type	Actros I
Driver cab	short, medium-long, long
Version	Low
Colour	grey

Installation side	Order number
left	9190 850 924
centre	9460 066 311
right	9190 850 925

Accessories

Step-up

Installation side	Order number
centre	(on request) 9460 066 356

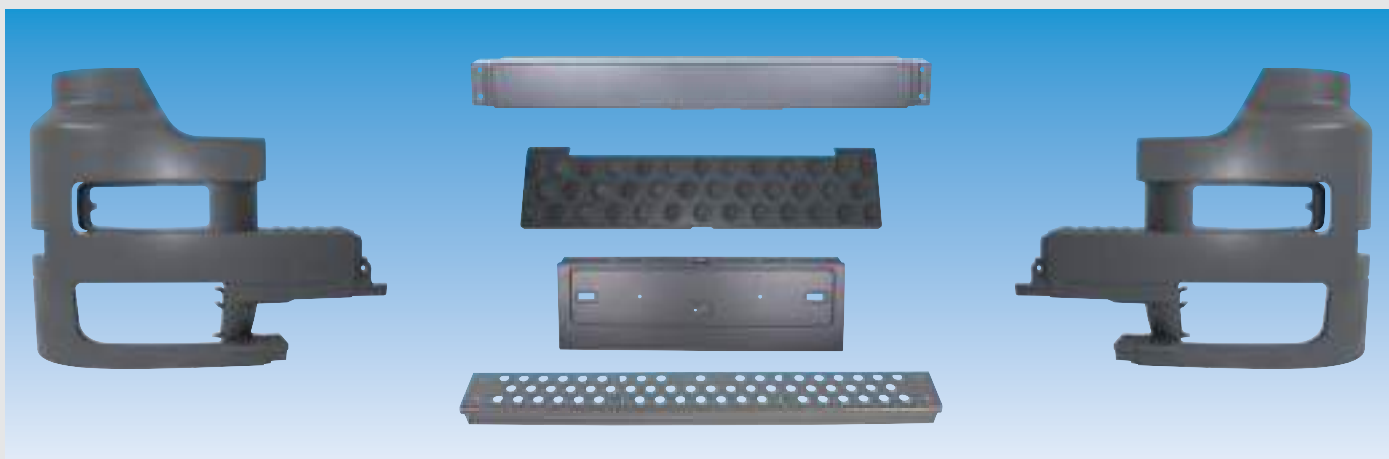

Bumper

Vehicle type	Actros I
Driver cab	Megaspace
Material	plastic
Colour	grey

Installation side	Order number
left	9190 005 500
centre, top	9190 851 301
right	9190 000 551

Accessories

Description	Installation side	Order number
Step-up	centre, top	9460 066 317
Flap	centre	9460 066 316
Step-up	centre, bottom	9190 801 670

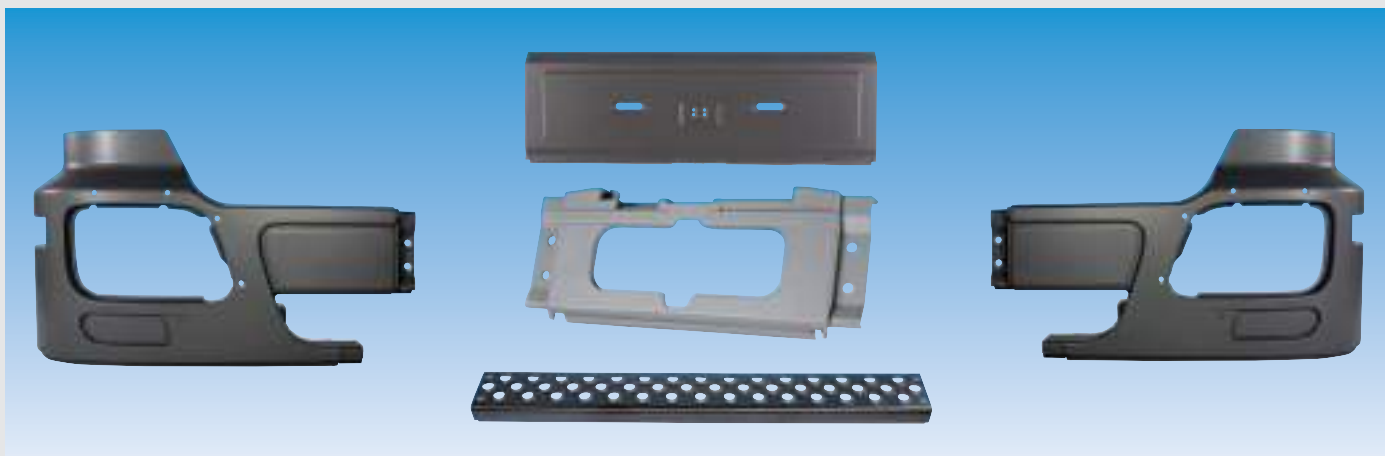

Bumper

Vehicle type	Actros MP2/MP3
Driver cab	short, medium-long, long
Material	plastic
Colour	grey

Installation side	Order number
left	9190 800 401
centre, top	9190 800 405
right	9190 800 402

Accessories

Description	Installation side	Order number
Flap	centre	9190 850 326
Step-up	centre, bottom	9190 830 001

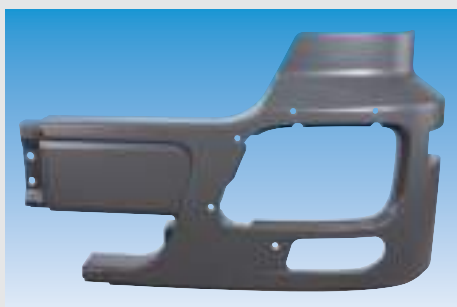

Bumper corner

Vehicle type	Actros MP2/MP3
Driver cab	short, medium-long, long
Version	with cutout for auxiliary driving lamp
Material	plastic
Colour	grey

Installation side	Order number
left	9190 800 403
right	9190 800 404



Bumper corner

Vehicle type	Actros MP2/MP3
Driver cab	short, medium-long, long
Material	steel
Colour	grey

Installation side		Order number
left	(on request)	9468 808 070
right	(on request)	9468 808 170



Rear apron

Vehicle type	Actros MP2
Driver cab	short, medium length, long
Version	Low
Colour	grey

Installation side	Order number
left	9198 850 325
centre, bottom	9198 850 525
right	9198 850 425

Accessories

Description	Installation side		Order number
Cover	centre	(on request)	9468 830 024
Step-up	centre, bottom	(on request)	9468 830 101
Step-up, foldable	centre, bottom	(on request)	9468 800 931

Our network – 200 locations in 28 countries

EUROPART – the international
partner for the workshop

www.europart.net



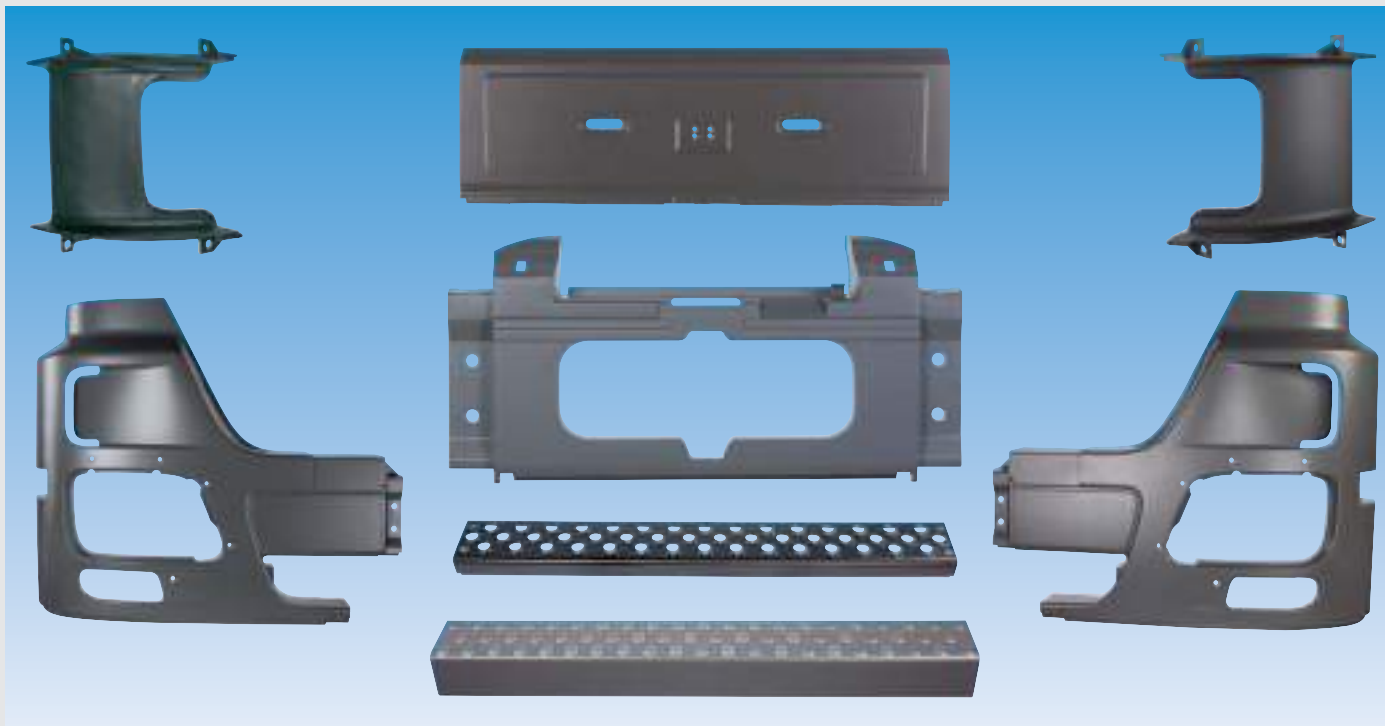

Bumper

Vehicle type	Actros MP2/MP3
Driver cab	Megaspacer
Version	with cutout for fog light
Colour	grey

Installation side	Order number
left	9468 809 370
centre	8256 000 117
right	9468 809 470

Accessories

Description	Installation side	Order number
Step-up	centre, bottom	9190 830 001
Flap	centre	9190 850 326
Front flap	centre	9468 850 526
Air duct	left	8256 000 165
Air duct	right	8256 000 164



Bumper corner

Vehicle type	Actros MP2/MP3
Driver cab	Megaspacer
Version	with cutout for fog light and air inlet
Installation location	front
Colour	grey

Installation side	Order number
left	9190 800 004
right	9190 800 005

Accessories

Air intake

Installation side	Order number
left	9190 840 060
right	9190 840 160

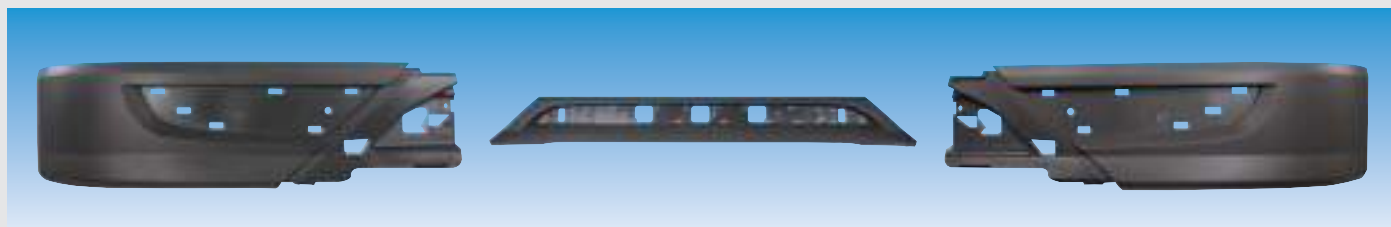

Rear apron

Vehicle type	Actros MP3
Driver cab	short, medium-long, long
Version	low

Installation side	Order number
left	9190 851 625
centre*	9190 851 825
right	9190 851 725

Accessories

Cover

Colour	grey
--------	------

Installation side		Order number
left, outside	(on request)	9468 851 422
right, outside	(on request)	9468 851 522
left, centre	(on request)	9463 885 122
centre	(on request)	9463 885 112
right, centre	(on request)	9468 851 322

*For vehicles up to 442 hp

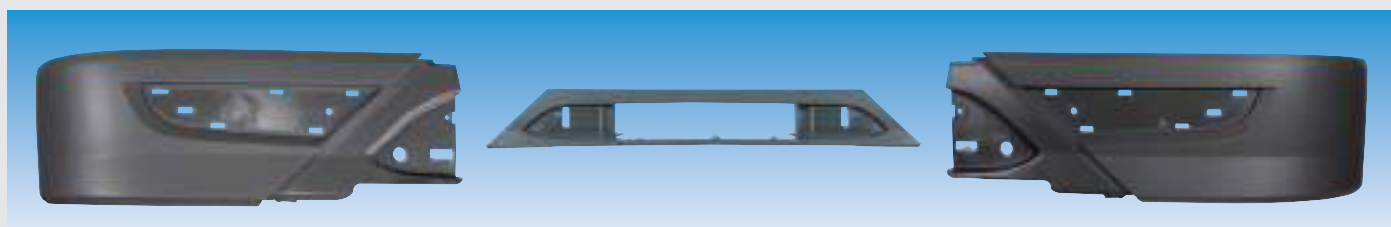

Rear apron

Vehicle type	Actros MP3
Driver cab	Megaspace

Installation side	Order number
left	9190 851 125
centre	9190 851 325
right	9190 851 225

Accessories

Description	Installation side		Order number
Step-up	centre, bottom	(on request)	9468 830 501
Cover	left, outside	(on request)	9468 851 422
Cover	right, outside	(on request)	9468 851 522
Cover	left, centre	(on request)	9463 885 092
Cover	right, centre	(on request)	9463 885 102



Entry box

Vehicle type	Actros I
Driver cab	short, medium-long, long
Height	1005 mm
Colour	grey

Installation side	Order number
left	9190 000 523
right	9190 000 524

Accessories

Step-up

Installation side		Order number
left, top	(on request)	9466 601 028
right, top	(on request)	9466 601 128
left, right, centre		9466 600 428
left, bottom		9466 601 628
right, bottom		9466 601 728

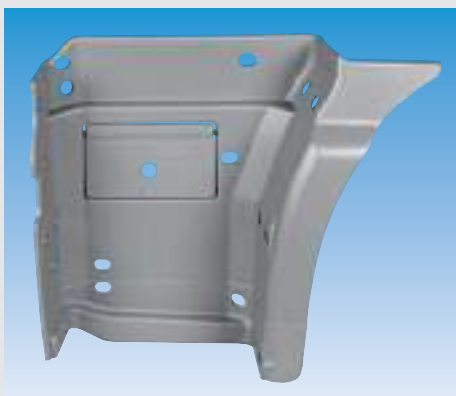

Entry box

Vehicle type	Actros I
Driver cab	short, medium-long, long
Height	930 mm
Colour	grey

Installation side	Order number
left	9466 600 401
right	9466 600 501

Accessories

Step-up

Installation side		Order number
left, top	(on request)	9466 601 328
right, top	(on request)	9466 601 428
left, right, centre		9466 600 428
left, bottom		9466 601 628
right, bottom		9466 601 728



Entry box

Vehicle type	Actros I/MP2/MP3
Driver cab	Megaspace
Installation location	front, bottom
Colour	grey

Installation side	Order number
left	9466 660 801
right	9466 660 901

Accessories

Description	Installation side	Order number
Step-up	left/right, top	9466 663 528
Maintenance flap	left, right	9466 660 105
Cover	left	9190 850 022
Cover	right	9190 850 122
Step-up	left, bottom	9190 663 728
Step-up	right, bottom	9190 663 828



Entry box

with wing

Vehicle type	Actros MP2/MP3
Driver cab	short, medium-long, long
Installation location	top
Colour	grey

Installation side	Order number
left	9196 600 101
right	9196 600 201

Accessories

Step-up

Installation side	Order number
left, right, bottom	9190 660 028

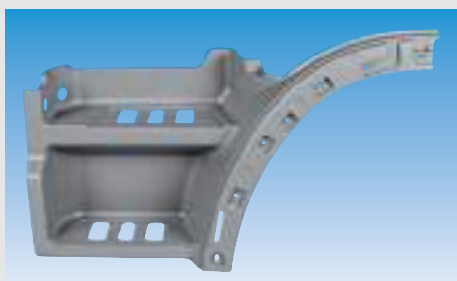

Entry box

with wing

Vehicle type	Actros MP2/MP3
Driver cab	short, medium-long, long
Installation location	top
Colour	grey

Installation side	Order number
left	9463 660 030
right	9190 600 401

Accessories

Step-up

Installation side	Order number
left, right, bottom	9190 660 028



Entry box

with wing

Vehicle type	Actros MP2/MP3
Driver cab	Lowliner
Installation location	top
Colour	grey

Installation side	Order number
left	9190 601 001
right	9190 601 101

Accessories

Step-up

Installation side	Order number
left, right, bottom	9190 660 028



Entry box

Vehicle type	Actros MP2/MP3
Driver cab	short, medium-long, long
Installation location	front, bottom
Height	1025 mm
Colour	grey

Installation side	Order number
left	9196 600 801
right	9196 600 901

Accessories

Step-up

Installation side	Order number
left, right, bottom	9190 660 028



Entry box

Vehicle type	Actros MP2/MP3
Driver cab	short, medium-long, long
Installation location	bottom
Height	945 mm
Colour	grey

Installation side	Order number
left	9190 660 801
right	9190 660 901

Accessories

Step-up

Installation side	Order number
left, right, bottom	9190 660 028

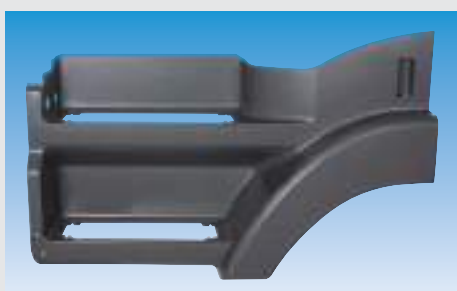

Entry box

with wing

Vehicle type	Actros MP2/MP3
Driver cab	Megaspace
Installation location	top
Special equipment	507701 01

Installation side	Order number
left	9196 661 901
right	9196 662 001

Accessories

Step-up

Installation side	Order number
left, right, bottom	9466 663 428
left, right, top	9466 663 328

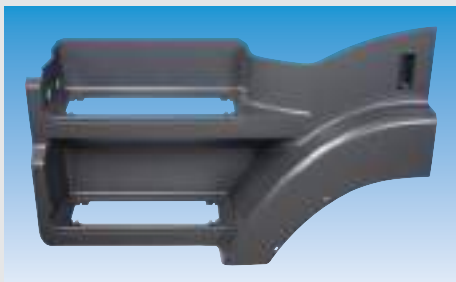

Entry box

with wing

Vehicle type	Actros MP2/MP3
Driver cab	Megaspace
Installation location	top
Special equipment	507701 02

Installation side		Order number
left	(on request)	9466 664 701
right	(on request)	9466 664 801

Accessories

Step-up

Installation side		Order number
left, right, top		9466 663 328
left, right, bottom		9466 663 428

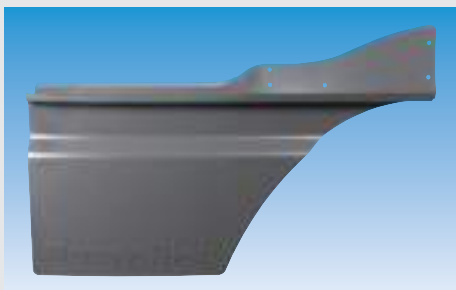

Door extension

Vehicle type	Actros I/MP2/MP3
Driver cab	Megaspace
Installation location	outside

Installation side		Order number
left		8256 000 171
right		8256 000 170

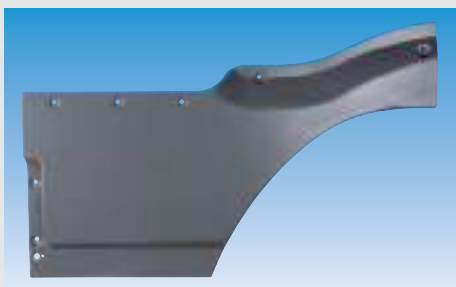

Door extension

Vehicle type	Actros I/MP2/MP3
Driver cab	Megaspace
Installation location	inside

Installation side		Order number
left		8256 000 169
right		8256 000 168



Corner plate

Vehicle type	Actros I
Driver cab	short, medium-long, long, Megaspace
Installation location	top
Colour	white

Installation side		Order number
left		9460 066 333
right		9460 066 334



Corner plate

Vehicle type	Actros I
Driver cab	short, medium-long, long, Megaspacer
Installation location	bottom

Installation side	Order number
left	9460 066 335
right	9460 066 336

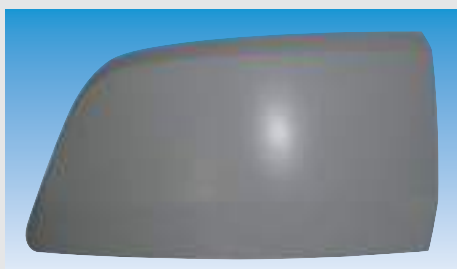

Air deflector

for A-pillar

Vehicle type	Actros I
Driver cab	Megaspacer

Installation side	Order number
left	9460 066 337
right	9460 066 338

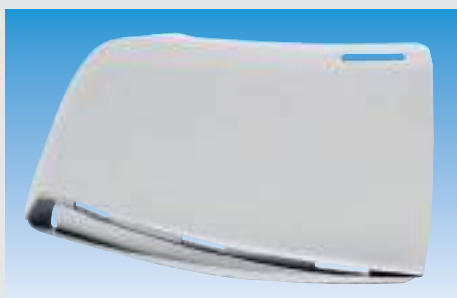

Cover plate

for deflector, A-pillar

Vehicle type	Actros I
Driver cab	short, medium-long, long

Installation side	Order number
left	9460 066 339
right	9460 066 440

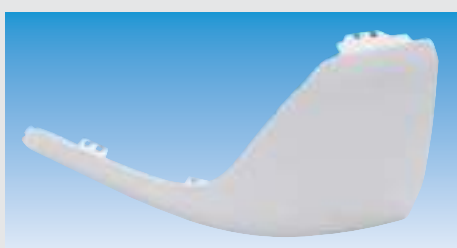

Cover plate

for deflector, A-pillar

Vehicle type	Actros I
Driver cab	short, medium-long, long
Installation location	front

Installation side	Order number
left	9460 066 441
right	9460 066 342



Air deflector

for A-pillar

Vehicle type	Actros MP2
Driver cab	short, medium-long, long, Megaspacer

Installation side	Order number
left	9464 388 402
right	9468 840 323



Air deflector

for A-pillar

Vehicle type	Actros MP2
Driver cab	short, medium-long, long, Megaspacer
Installation location	front, inside

Installation side	Order number
left	8256 000 160
right	8256 000 159



Corner plate

for A-pillar

Vehicle type	Actros MP2
Driver cab	short, medium-long, long, Megaspacer

Installation side	Order number
left	9468 840 023
right	8256 000 155



Corner plate

for A-pillar

Vehicle type	Actros MP3
Driver cab	short, medium-long, long, Megaspacer
Version	primed
Installation location	front

Installation side	Order number
left	9190 841 722
right	9190 841 822



Cover

for corner plate, A-pillar

Vehicle type	Actros MP3
Driver cab	short, medium-long, long, Megaspacer
Version	primed
Colour	white

Installation side	Order number
left	9190 841 922
right	9190 842 022



Wing

Rear axle

Vehicle type Actros I

Description	Installation side		Order number
Wing	left, front section		9195 200 119
Wing	right, front section		9195 200 219
Cover plate	left, front	(on request)	9460 066 277
Cover plate	right, front	(on request)	9460 066 284
Splash protection	left, bottom	(on request)	9460 066 281
Wing	Central piece, 200 mm	(on request)	9460 066 278
Wing	centre section, 150 mm		9190 220 004
Wing	left, rear section		9190 200 320
Wing	right, rear section		9190 201 620
Cover plate	left, rear		9460 066 280
Cover plate	right, rear		9460 066 285
Splash protection	left, right, rear	(on request)	9465 202 181
Splash protection	right, rear	(on request)	9460 066 282

Accessories

Description	Order number
Tightening strap rubber	9465 220 067

Wing

Rear axle

Vehicle type Actros MP2/MP3

Description	Installation side	Order number
Wing	left, front section	9190 200 019
Wing	right, front section	9190 200 119
Wing	centre section, 150 mm	9090 200 007
Wing	centre section, 180 mm	9190 200 207
Wing	Central piece, 200 mm	9465 200 107
Wing, without splash guard	left, right, rear section	8256 200 120
Wing, without splash guard	left, right, rear section	8256 200 020
Splash protection, 215 mm	left, right, rear section	9465 200 281
Splash protection, 170 mm	left, rear section	9195 200 081

Accessories

Description	Order number
Tightening strap rubber	9465 220 167



Windscreen

Vehicle type	Actros I/MP2/MP3
Width	2350 mm
Height	860 mm

Version	Order number
green	9115 000 014
green, with green band	9115 000 016

Accessories

Description	Order number
Sealing frame	9460 066 295



Sunshade

for driver's cab

Vehicle type	Actros I
Driver cab	short, medium-long, long with low roof, from chassis K 344165
Version	without bracket
Material	acrylic glass
Colour	antracite

Order number
9199 224 229

Accessories

Description	Order number
Sunshade holder	9199 224 231



Sunshade

for driver's cab

Vehicle type	Actros I
Version	without bracket
Material	acrylic glass
Colour	antracite

Driver cab	Order number
long, high, Megaspacer, up to chassis K 344164	9190 430 341
long, high, Megaspacer, from chassis K 344165	9192 321 730



Sunshade

for driver's cab

Vehicle type	Actros MP2
Driver cab	short, medium-long, long with low roof
Version	without windscreen cut-out, without bracket
Material	acrylic glass
Colour	antracite

Order number
9190 430 361

Accessories

Description	Order number
Fastening set	9190 430 363



Sunshade

for driver's cab

Vehicle type	Actros MP2
Driver cab	long, high, Megaspaces
Version	without windscreen cut-out
Material	acrylic glass
Colour	antracite

Order number
6170 462 497



Sunshade

for driver's cab

Vehicle type	Actros MP3
Driver cab	short, medium-long, long with low roof
Version	with windscreen cut-out, with bracket
Material	acrylic glass
Colour	antracite

Order number
9190 043 050



Sunshade

for driver's cab

Vehicle type	Actros MP3
Driver cab	long, high and Megaspaces
Version	with windscreen cut-out, with bracket
Material	acrylic glass
Colour	antracite

Order number
9190 043 051



Wiper blade

Vehicle type	Actros I/MP2/MP3
Length	700 mm

Version	Order number
with 1 adapter	7257 002 020
with 4 adapters	7257 002 110



Washer fluid pump

Vehicle type	Actros I/MP2/MP3
Version	Dual pump with 3 connections
Voltage	24 V

Order number
6170 461 883



Wiper motor

Vehicle type	Actros I/MP2/MP3
Voltage	24 V

Order number
9250 404 233



Mirror head

Vehicle type	Actros I/MP2
Installation side	left/right
Length	433 mm
Width	188 mm
Depth	68 mm

Scope of supply
without glass unit

Version	Order number
manual adjustment	9110 000 251
heated, electric adjustment	9110 000 252

Service parts

Description	Order number
Glass unit, Curve radius 1800 mm	9110 000 086
Retaining element with cover	2110 000 285



Main mirror

Vehicle type	Actros I/MP2
Installation side	left/right
Width	188 mm
Depth	68 mm
Curve radius	1200 mm

Scope of supply

complete

mirror complies with ordinance 2003/97/EU or 2007/38/EU

Version	Order number
unheated, manual adjustment	3359 001 013
heated, electric adjustment	9113 783 167

Service parts

Description	Order number
Glass unit, Curve radius 1200 mm	9113 780 840
Retaining element with cover	2110 000 285



Glass unit

for main mirror

Vehicle type	Actros MP3
Width	200 mm
Depth	45 mm
Curve radius	1200 mm

Installation side	Order number
left	9110 221 813
right	9110 221 812



Glass unit

suitable for wide angle mirror

Vehicle type	Actros MP2/MP3
Height	196 mm
Width	193 mm
Depth	44 mm
Curve radius	300 mm

Installation side	Order number
left	9110 221 815
right	9110 221 814



Front mirror

Vehicle type	Actros I/MP2
Version	heated, manual adjustment
Installation side	right
Length	1219 mm
Width	303 mm
Diameter	250 mm

Scope of supply

with retaining element

mirror complies with ordinance 2003/97/EU or 2007/38/EU

Order number
9113 965 210

Service parts

Description	Order number
Glass unit heated, Curve radius 300 mm	9113 961 174
Mirror head heated, manual adjustment	9113 960 148



Front mirror

Vehicle type	Actros MP3
Version	manual adjustment
Installation side	right
Installation location	front, top

Scope of supply

complete

Order number
9468 105 116

Service parts

Installation side	Order number
Mirror housing	9468 101 979
Mirror glass	9468 112 333



Wide angle mirror

Vehicle type	Actros I/MP2
Version	heated, manual adjustment
Installation side	left/right
Model year	-2004
Width	200 mm

Scope of supply

complete

mirror complies with ordinance 2003/97/EU or 2007/38/EU

Order number
9113 773 147

Service parts

Description	Order number
Glass unit, Curve radius 300 mm	9113 771 174
Retaining element with cover	2110 000 285



Ramp mirror

Vehicle type	Actros MP2/MP3
Version	unheated, manual adjustment
Installation side	right/left
Model year	2004-
Width	255 mm
Depth	98 mm

Scope of supply

complete

Order number

9114 001 099

Service parts

Description

Glass unit, Curve radius 300 mm

Order number

9115 791 470



Mounting bracket, outside mirror

for exterior mirror

Vehicle type	Actros I/MP2
Length	197 mm
Width	983 mm
Diameter	28 mm

Scope of supply

with heating cable and control cable

Installation side

left

Order number

9113 781 100

right

9113 781 200

Accessories

Description

Cover

Order number

9111 036 975

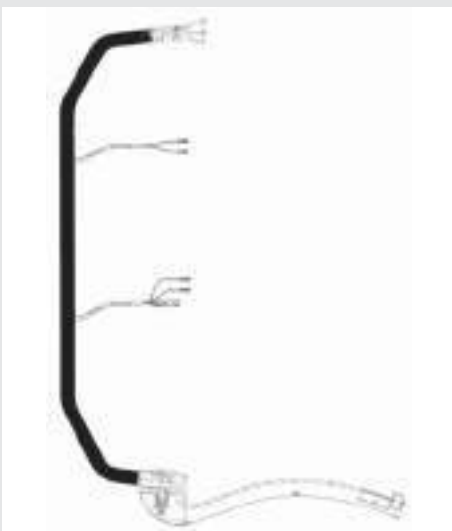

Mounting bracket, outside mirror

for exterior mirror

Vehicle type	Actros I/MP2
Length	227 mm
Width	983 mm
Diameter	28 mm

Scope of supply

with heating cable and control cable

Installation side

left

Order number

9111 037 061

right

9113 783 200

Accessories

Description

Cover

Order number

9111 036 975



Mounting bracket, outside mirror

for exterior mirror

Vehicle type Actros MP3

Installation side		Order number
left	(on request)	9468 103 214
right	(on request)	9468 103 314

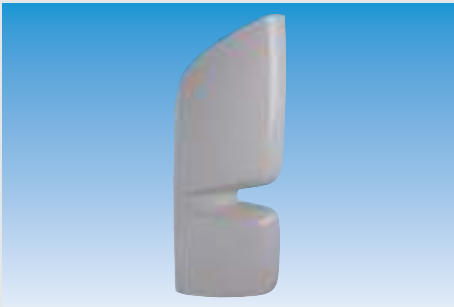

Cover

for exterior mirror

Vehicle type Actros MP3

Surface primed

Installation side		Order number
left		9468 110 507
right		9468 110 607

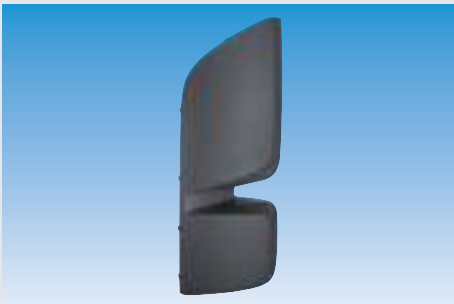

Cover

for exterior mirror

Vehicle type Actros MP3

Colour dark grey

Installation side		Order number
left		9468 110 307
right		9468 110 407



Heat exchanger

for interior heating

Vehicle type Actros I

Length 390 mm

Width 226 mm

Height 40 mm

Order number
0351 312 541



Heat exchanger

for interior heating

Vehicle type Actros MP2/MP3

Length 370 mm

Width 175 mm

Height 32 mm

Order number
0351 312 571



Air-conditioning compressor

Voltage 24 V

Illustration	Vehicle type	Type	Pulley Ø mm	Number of ribs	Order number
1	Actros I/MP2/MP3	7SBU16C	130	11	0351 176 531
2	Actros I/MP2/MP3	7SBU16C	135	9	9100 851 061
-	Actros MP2/MP3	10PA15C	130	8	9462 300 111



Air-conditioning compressor

Vehicle type Actros I/MP2/MP3
 Type 10PA15C
 Pulley diameter 129 mm
 Number of ribs 9
 Voltage 24 V

Order number
 9100 852 050



Condenser

for air-conditioning systems

Vehicle type Actros I/MP2/MP3
 Version without dryer
 Length 673 mm
 Width 457 mm
 Depth 22 mm

Order number
 9100 132 450



Blower

interior

Vehicle type Actros I
 Version double radial
 Voltage 24 V

Order number
 9100 742 870

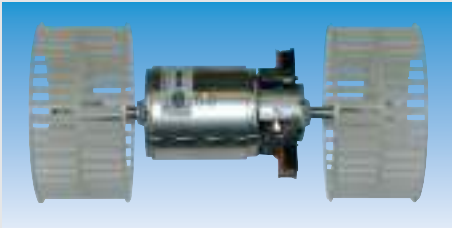

Blower

interior

Version double radial
Voltage 24 V

Vehicle type	Order number	Comparative number
Actros MP2/MP3	9462 830 840	Mercedes-Benz 002 830 84 08
Actros MP2 (on request)	9468 308 308	Mercedes-Benz 002 830 83 08
Actros MP2/MP3	9468 308 408	Mercedes-Benz 003 830 05 08
Actros MP2/MP3	0351 043 381	Mercedes-Benz 003 830 06 08



Blower

for heating

Vehicle type Actros I/MP2/MP3
Voltage 24 V

Order number
0009 157 461

Accessories

Description	Order number
Electrical ballast, 24 V	9261 029 381



Filter dryer

for air-conditioning system

Vehicle type Actros I/MP2/MP3
Version with bracket
Diameter 53 mm
Length 290 mm

Order number
0351 197 441



Filter dryer

for air-conditioning systems

Vehicle type Actros I/MP2/MP3
Version with holder and dual thermostatic switch
Diameter 50 mm
Length 290 mm

Order number
9100 802 520



Filter dryer

for air-conditioning systems

Vehicle type	Actros I/MP2/MP3
Driver cab	short, long
Version	with mounting bracket

Order number
0351 198 541

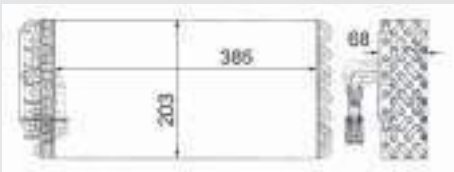

Evaporator

for air-conditioning system

Vehicle type	Actros MP2/MP3
Version	without expansion valve
Length	385 mm
Width	203 mm
Depth	67 mm

Order number
9100 821 020



Evaporator

for air-conditioning system

Vehicle type	Actros MP2/MP3
Version	without expansion valve
Length	200 mm
Width	307 mm
Depth	65 mm

Order number
0351 211 761



Expansion valve

for air-conditioning system

Vehicle type	Actros I
--------------	----------

Order number
0351 239 381

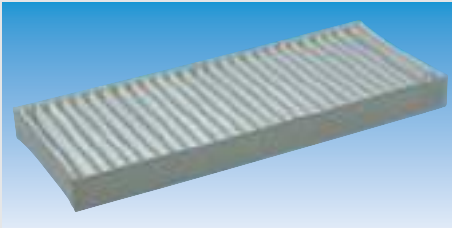
**Cabin filter**

Vehicle type Actros I/MP2/MP3

Length mm	Width mm	Height mm	Order number
378	131.5	40	9020 003 855
380.7	134	37.5	9020 038 690

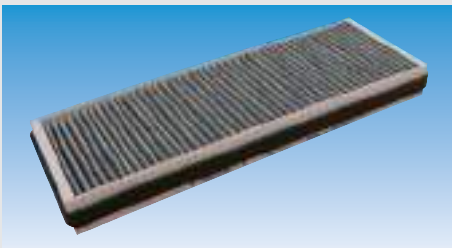
**Cabin filter**

Vehicle type Actros I/MP2/MP3

Length 386 mm

Width 139 mm

Height 40 mm

Order number

9020 010 053

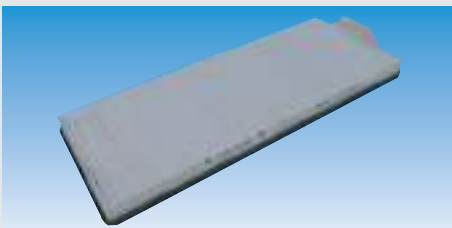
**Cabin filter**

Vehicle type Actros I/MP2/MP3

Length 454 mm

Width 190 mm

Height 56 mm

Order number

9020 000 526

**Cabin filter**

Vehicle type Actros I/MP2/MP3

Length 335 mm

Width 98 mm

Height 10 mm

PU 10 pieces

Order number

9750 001 904

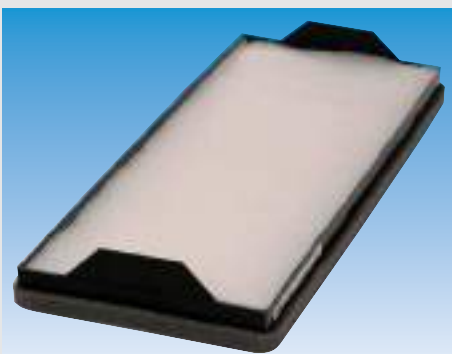
**Cabin filter/pollen filter**

Vehicle type Actros I/MP2/MP3

Length 451 mm

Width 193 mm

Height 56 mm

Order number

9750 103 232



Truck driver's seat

6860/875 NTS

Full height adjustment with memory function, built-in 3-point safety belt system with belt pretensioner, seat back adjustment, shoulder adjustment, lean and horizontal settings, adjustable vertical movement damper, adjustable cushion depth, integrated pneumatic system (IPS) for adjustment of backrest to individual body contour (lumbar support and adjustable side support, rapid lowering, horizontally sprung, grey/anthracite seat covering with fine silver coloured stripes

Vehicle type Actros I/MP2/MP3

Version can be operated from the left, with seat heating and arm rests both sides

Track width 230 mm

Order number

9368 894 301



Truck driver's seat

6860/875 NTS

Full height adjustment with memory function, built-in 3-point safety belt system, seat back adjustment, shoulder adjustment, lean and horizontal settings, adjustable vertical movement damper, adjustable cushion depth, integrated pneumatic system (IPS) for adjustment of backrest to individual body contour (lumbar support and adjustable side support), rapid lowering, horizontally sprung

Vehicle type Actros MP2/MP3

Version can be operated on the left, with seat air-conditioning, armrests on both sides and EPS console

Track width 230 mm

Order number

9368 923 701



(Illustration similar)



Truck driver's seat

6860/875 NTS

automatic weight adjustment with connection to the vehicle pneumatic system, with pressure permanently at least 7.5 bar, built-in 3-point safety belt system, adjustable upper belt diverter, height adjustment with memory function, seat back adjustment, shoulder adjustment, lean and horizontal settings, adjustable vertical movement damper, on/off horizontal springing, adjustable seat cushion depth, integrated pneumatic system (IPS) for adjustment of backrest to individual body contour (lumbar support and adjustable side support), rapid lowering, grey/antracite seat covering with fine silver coloured stripes, with preparation for mounting of the existing EPS III type shift lever console from construction year 2003

Vehicle type Actros MP2/MP3

Track width 230 mm

It is not permitted to use this item in vehicles with air bag systems, seat belt pretensioners and belt lock sensors!

Arm rests must be ordered separately.

Version	Order number
Standard, can be operated on the left	9368 970 701
Comfort, can be operated from the left, with seat climate control	9368 971 701

Accessories

Arm rest

Installation side	Order number
left	9369 296 511
right	9369 296 521



Truck driver's seat

ARIZONA standard

integrated 3-point belt system, automatic positioning system, rapid lowering, tilt adjustment, longitudinal adjustment and backrest adjustment

Vehicle type Actros I, -06/2000

Width 480 mm

Depth 635 mm

Track width 230 mm

These seats may only be installed in vehicles which already have a 3-point belt installed in production!

Arm rests must be ordered separately.

Console required!

Order number
9361 040 671

Accessories

Arm rest

Installation side	Order number
left	9361 067 726
right	9361 067 727



Truck driver's seat

ARIZONA Comfort

air sprung, with external supply, spring travel 80 mm, height adjustment 100 mm, headrest, length adjustment, backrest setting, 3-point restraint system, quick lowering, seat angle adjustment, longitudinal horizontal suspension, pneumatic lumbar support, side contour adjustment, 2-stage seat heating, seat cushion depth setting, adjustable shock absorber

Vehicle type	Actros I, -06/2000
Width	490 mm
Depth	580 mm
Track width	320 mm

Arm rests must be ordered separately.

Order number
9361 040 669

Accessories

Arm rest

Installation side	Order number
left	9361 067 726
right	9361 067 727



Truck driver's seat

Kingman High Performance Comfort

air sprung, with external supply, spring deflection 70 mm, height adjustment 100 mm, built-in headrest, length adjustment, longitudinal horizontal suspension, pneumatic lumbar support, backrest setting, built-in 3-point restraint system, quick lowering, side contour adjustment, seat angle adjustment, adjustable shock absorber, neck cushion with changeable cover, 2-stage seat heating, seat pillow depth setting

Vehicle type	Actros I, 07/2000-07/2003
Width	545 mm
Depth	630 mm
Track width	230 mm

Illustration shows special equipment!
Arm rests must be ordered separately.

Order number
9361 503 090

Accessories

Arm rest

Installation side	Order number
left	9361 029 136
right	9361 029 137





Truck driver's seat

Kingman High Performance Comfort

Spring deflection 70 mm, height adjustment 100 mm, built-in head support, length adjustment, longitudinal horizontal suspension, pneumatic lumbar support, neck pillow with exchangeable cover, backrest setting, built-in 3-point restraint system with adjustable belt, rejuvenated back contour, quick lowering, side contour adjustment, seat heating 2-stage, seat pillow depth setting, seat angle setting, shock absorbers adjustable

Vehicle type Actros I, 07/2000 bis 07/2003
 Width 545 mm
 Depth 630 mm
 Track width 230 mm

For vehicles without an airbag!
Illustration shows special equipment!
Arm rests must be ordered separately.

Order number
9361 031 649



Accessories

Arm rest

Installation side	Order number
left	9361 029 136
right	9361 029 137



Truck driver's seat

Kingman High Performance

Spring deflection 70 mm, height adjustment 100 mm, built-in head support, length adjustment, longitudinal horizontal suspension, pneumatic lumbar support, backrest setting, built-in 3-point restraint system, quick lowering, side contour adjustment, active seat air-conditioning, seat heating 2-stage, seat pillow depth setting, seat angle setting, shock absorbers adjustable

Vehicle type Actros I, 07/2000-07/2003
 Width 545 mm
 Depth 630 mm
 Track width 230 mm

Arm rests must be ordered separately.

Order number
9361 189 172



Accessories

Arm rest

Installation side	Order number
left	9361 029 136
right	9361 029 137



Truck driver's seat

Kingman High Performance standard, without belt pretensioner

air sprung, with external supply, spring deflection 70 mm, height adjustment 100 mm, built-in headrest, length adjustment, longitudinal horizontal suspension, pneumatic lumbar support, backrest setting, built-in 3-point restraint system, quick lowering, side contour adjustment, seat angle adjustment, adjustable shock absorber

Vehicle type	Actros MP2, 03/2003-
Width	545 mm
Depth	630 mm
Track width	230 mm

Illustration shows special equipment!
Arm rests must be ordered separately.

Order number

9361 503 070

Accessories

Arm rest

Installation side	Order number
--------------------------	---------------------

left	9361 029 136
------	--------------

right	9361 029 137
-------	--------------



Truck driver's seat

Kingman High Performance Comfort

spring deflection 70 mm, height adjustment 100 mm, integrated head rest, length adjustment, longitudinal horizontal suspension, pneumatic lumbar support, neck pillow with exchangeable cover, backrest setting, integrated 3-point restraint system with adjustable belt tongue, tapered back contour, quick lowering, side contour adjustment, 2-level seat heating, seat cushion depth setting, seat angle setting, adjustable shock absorbers

Vehicle type	Actros MP2/MP3
Width	545 mm
Depth	630 mm
Track width	230 mm

For vehicles without an airbag!
Illustration shows special equipment!
Arm rests must be ordered separately.

Order number

9361 503 080

(Illustration similar)



Accessories

Arm rest

Installation side	Order number
--------------------------	---------------------

left	9361 029 136
------	--------------

right	9361 029 137
-------	--------------



(Illustration similar)



Truck driver's seat

Kingman High Performance Comfort, with belt pretensioner

spring deflection 70 mm, height adjustment 100 mm, integrated head rest, length adjustment, longitudinal horizontal suspension, pneumatic lumbar support, neck pillow with exchangeable cover, backrest setting, integrated 3-point restraint system with adjustable belt tongue, tapered back contour, quick lowering, side contour adjustment, 2-level seat heating, seat cushion depth setting, seat angle setting, adjustable shock absorbers

Vehicle type	Actros MP2/MP3
Width	545 mm
Depth	630 mm
Track width	230 mm

**Illustration shows special equipment!
Arm rests must be ordered separately.**

Order number
9361 031 658



Accessories

Arm rest

Installation side

left	9361 029 136
right	9361 029 137

Order number
9361 029 136
9361 029 137



Truck driver's seat

Kingman High Performance Air-conditioning, with belt pretensioner

Spring deflection 70 mm, height adjustment 100 mm, built-in head support, length adjustment, longitudinal horizontal suspension, pneumatic lumbar support, backrest setting, built-in 3-point restraint system, quick lowering, side contour adjustment, active seat air-conditioning, seat heating 2-stage, seat pillow depth setting, seat angle setting, shock absorbers adjustable

Vehicle type	Actros MP2/MP3
Width	545 mm
Depth	630 mm
Track width	230 mm

Arm rests must be ordered separately.

Order number
9361 179 178



Accessories

Arm rest

Installation side

left	9361 029 136
right	9361 029 137

Order number
9361 029 136
9361 029 137



Roof-mounted air-conditioning system for truck

CoolAir CA 850S, for stationary operation

extraordinary cooling performance and additional air dehumidification, pleasant climate, independently of the external climatic conditions, can also be operated when the vehicle is moving, simple installation

Refrigerant R134a

Cooling capacity 1000 W (compressor capacity), 850 W (following ISO 5151)

Dimensions of roof unit (W x H x D) 830 x 159 x 635 mm

Input voltage 24 V DC

Current consumption 12-18 A

Colour white

Weight 22 kg

Scope of supply

Remote control, battery cable, operating instructions

	Order number
	1880 000 027

Accessories

Description	Order number
Assembly set	1880 000 032
Protective hood CoolAir	1880 000 040



Door mat

Vehicle type	Actros MP2/MP3
Version	2-piece
Installation side	front left/right

Driver cab	Order number
short, medium, long	9190 110 120
short, medium, long, with foldable seat	9190 110 130



Pedal pad

Vehicle type	Actros I/MP2/MP3
Thickness	13 mm

Version	Length mm	Width mm	Order number
for clutch pedal	70	64/49	9080 001 104
for brake pedal	69.5	63/47	9080 001 105



Filing table

with anti-slip mat

Vehicle type	Actros I
Installation side	centre

Colour	Order number
black	9080 084 741
Root wood finish	9080 084 742

Filing table

with anti-slip mat

Vehicle type	Actros I
Installation side	right

Colour	Order number
black	1002 010 213
Root wood finish	1002 010 214

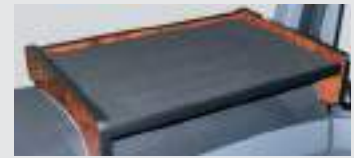

Filing table

with anti-slip mat

Vehicle type Actros MP2/MP3
Installation side centre

Colour	Order number
black	1002 010 215
Root wood finish	1002 010 216

Filing table

with anti-slip mat

Vehicle type Actros MP2/MP3
Installation side right

Colour	Order number
black	1002 010 217
Root wood finish	1002 010 218



Filing table

XXL, with anti-slip mat

Vehicle type Actros MP2/MP3
Installation side centre and right

Colour	Order number
black	1002 010 221
Root wood finish	1002 010 222



Filing table

with anti-slip mat

Vehicle type Actros MP2/MP3
Version with cut-out for telematics system
Installation side centre

Colour	Order number
black	1002 010 219
Root wood finish	9190 210 220

Filing table

XXL, with anti-slip mat

Vehicle type Actros MP2/MP3
Version with cut-out for telematics system
Installation side centre and right

Colour	Order number
black	1002 010 223
Root wood finish	1002 010 224



Shock absorber

Vehicle type Actros I/MP2/MP3
Fastening eye/eye

Version	Installation location	Order number
gas pressure, twin-tube system	front axle	9200 290 590
oil pressure, twin-tube system	rear axle	9200 105 423



Shock absorber

Vehicle type	Actros I/MP2/MP3
Version	Gas pressure, twin-tube system
Fastening	eye/eye
Installation location	rear axle

Order number
9200 001 270



Shock absorber

Vehicle type	Actros I/MP2/MP3
Version	gas pressure, twin-tube system
Fastening	eye/eye
Installation location	front axle

Order number
9200 001 277



Shock absorber

Super Touring

Vehicle type	Actros I/MP2/MP3
Version	Gas pressure, twin-tube
Fastening	eye/eye
Installation location	Front axle

Order number
9202 902 680



Shock absorber

Super Touring

Vehicle type	Actros I/MP2/MP3
Version	gas pressure, twin-tube system
Fastening	eye/fork
Installation location	rear axle

Order number
9202 902 460



Shock absorber

Super Touring

Vehicle type	Actros I/MP2/MP3
Version	oil pressure, twin-tube system
Fastening	eye/eye
Installation location	rear axle

Order number
9270 311 664



Shock absorber

Super Touring

Vehicle type	Actros I/MP2/MP3
Version	Gas pressure, twin-tube
Fastening	Eye/eye
Installation location	Rear axle

Order number
9750 001 439



Shock absorber

Super Touring

Vehicle type	Actros I/MP2/MP3
Version	Gas pressure, single-tube
Fastening	Eye/eye
Installation location	Rear axle

Order number
9750 290 995



Shock absorber

Vehicle type	Actros I
Version	Gas pressure, twin-tube
Fastening	Eye/eye
Installation location	Front axle

Order number
9200 001 276

(Illustration similar)



Gas spring for front flap

Vehicle type	Actros I/MP2/MP3
Spring force	360 N
Inner diameter	10 mm
Length	346/611 mm

Order number
9469 808 464



Driver cab tilt cylinder

Vehicle type	Actros I/MP2/MP3
Installation side	left/right
Pressure	250 bar
Stroke	457 mm
Bore hole diameter	24 mm
Outer thread	M12 x 1.5

Order number
1325 004 621
1325 462 159



Driver cab tilting pump

Illustration	Vehicle type	Order number	Comparative number
1	Actros I	9460 155 335	Mercedes-Benz 001 553 35 01
1	Actros I	9460 155 334	Mercedes-Benz 001 553 34 01
2	Actros I	9465 533 601	Mercedes-Benz 001 553 36 01
2	Actros I	9460 155 337	Mercedes-Benz 001 553 37 01
3	Actros I	9465 530 001	Mercedes-Benz 001 553 00 01
3	Actros I	9465 539 901	Mercedes-Benz 000 553 99 01
4	Actros MP2/MP3	9460 155 338	Mercedes-Benz 001 553 38 01
5	Actros MP2/MP3	9460 155 340	Mercedes-Benz 001 553 40 01
5	Actros MP2/MP3	9460 155 341	Mercedes-Benz 001 553 41 01



Skirting protection bracket

with TÜV approval

Vehicle type Actros I
 Driver cab LH (Megaspaces)
 Version with bottom bar
 Material Stainless steel
 Surface high-gloss polished

you must specify whether the front and rear axles are air sprung, or if the front axle is suspended on leaf springs

Order number

1002 027 210



Skirting protection bracket

with TÜV approval

Vehicle type Actros I
 Driver cab L
 Version with bottom bar
 Material Stainless steel
 Surface high-gloss polished

you must specify whether the front and rear axles are air sprung, or if the front axle is suspended on leaf springs

Order number

1002 027 212



Skirting protection bracket

with TÜV approval

Vehicle type Actros MP2
 Driver cab L
 Version with bottom bar
 Material Stainless steel
 Surface high-gloss polished

Order number

1002 027 216



Skirting protection bracket

with TÜV approval

Vehicle type	Actros MP2
Driver cab	LH (Megaspacer)
Version	with bottom bar
Material	Stainless steel
Surface	high-gloss polished

Order number

1002 027 215



Skirting protection bracket

with TÜV approval

Vehicle type	Actros MP3
Driver cab	LH (Megaspacer)
Version	with bottom bar
Material	Stainless steel
Surface	high-gloss polished

Order number

1002 027 501



Skirting protection mini-brush

with TÜV approval

Vehicle type	Actros MP2
Diameter	76 mm
Material	Stainless steel
Surface	high-gloss polished

Scope of supply

without headlights

Driver cab

Order number

1002 027 233

Low Liner

1002 027 232



Underrun protection tube

fixture below the bumper

Vehicle type	Actros MP2
Driver cab	LH (Megaspace)
Diameter	60 mm
Material	Stainless steel
Surface	high-gloss polished

Order number

1002 001 006



Headlight bracket

for mounting on the sun visor holder

Vehicle type	Actros MP2
Version	for 5 headlights
Installation location	top
Diameter	60 mm
Material	Stainless steel
Surface	high-gloss polished

Scope of supply

without headlights

Order number

9150 503 028



Headlight bracket

with TÜV approval

Vehicle type	Actros MP2/MP3
Version	for 4 headlights
Installation location	bottom
Diameter	60 mm
Material	Stainless steel
Surface	high-gloss polished

Scope of supply

without headlights

Order number

9156 504 019



Headlight bracket

Vehicle type	Actros MP2
Driver cab	S/M/L, flat roof
Installation location	top
Material	Stainless steel
Surface	high-gloss polished

Order number

1002 003 034



H1 spotlight

Rallye 3003

Version	Halogen, with LED position light
Installation side	left, right
Colour	clear
Voltage	12/24 V

Scope of supply
with LEDs

Order number
0009 797 431



H1 spotlight

Luminator-Chromium CELIS®

Version	Halogen, with CELIS® position light
Installation side	left/right
Colour	clear
Voltage	12/24 V

Order number
0007 560 211



Fastening clamp

for headlight

for mounting on the impact protection of light bar

Material Stainless steel

Ø mm	Order number
60	9150 001 430
76	1002 001 431



LED position lights set

Delivery only including installation in impact protection or headlight bar

Colour white

Version	Order number
3 piece set	1002 045 003
5 piece set	1002 045 005
7 piece set	1002 045 007



LED daytime running lights set

preassembled and aligned, installation position meets the requirements of the Road Traffic Act

Vehicle type Actros MP3

Installation side left, right

Material Stainless steel housing

Colour white

Scope of supply

with cable set

Colour	Housing colour	Order number
white	black	9196 745 022
clear	silver	8526 745 023

We can do it here too!

Everything for the "New Actros" - reliably and fast!

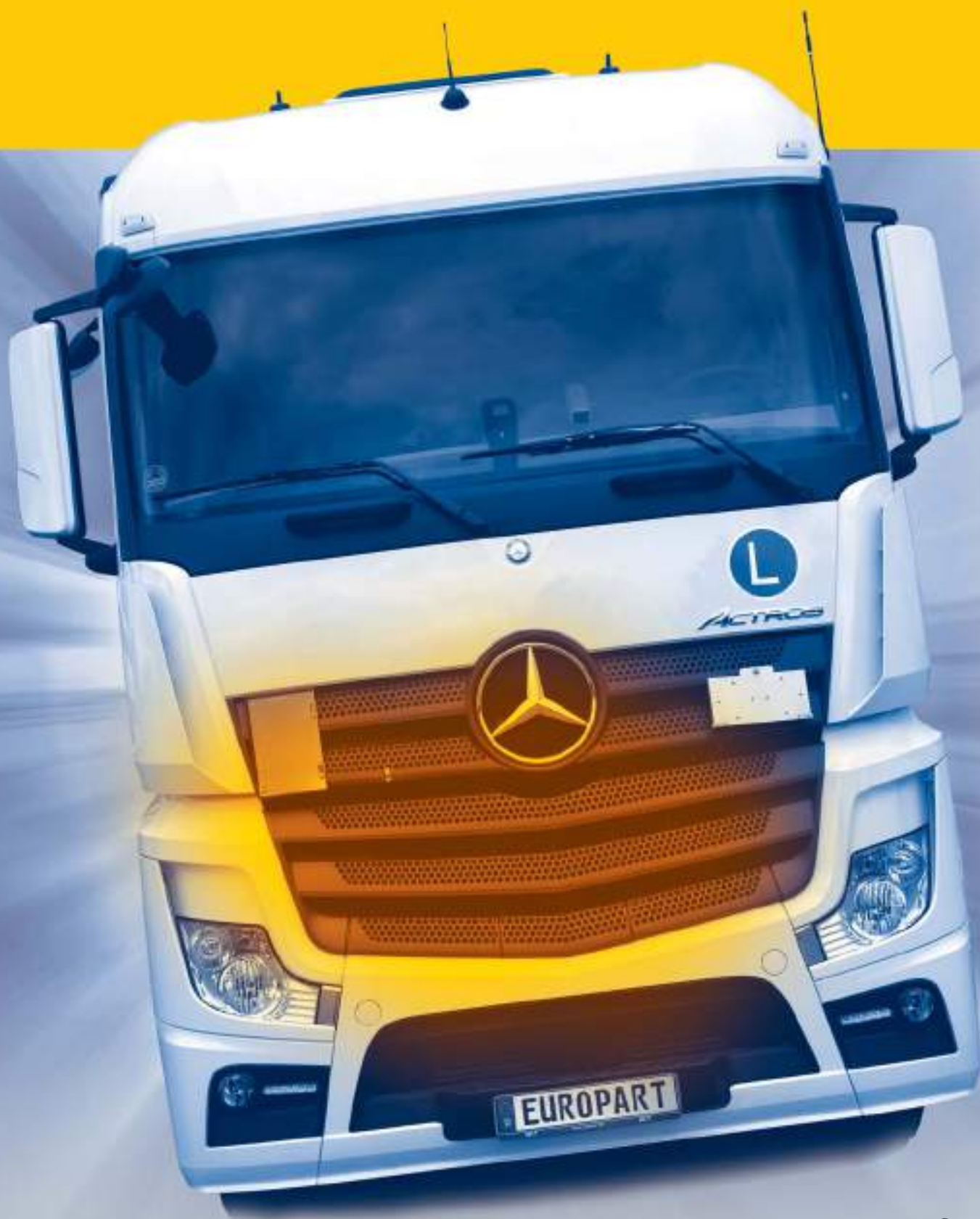

www.europart.net

**EURO
PART** 
... more than parts

Axor

2



Engine	132-143
Drive	144-149
Suspension	150-155
Axle and steering.....	156-165
Braking system	166-171
Pneumatic system	172-185
Lighting and electrics.....	186-195
Bodywork	196-201
Driver's cab.....	202-213



Engine bearing

Vehicle type	Axor I/II/III
Installation location	front and rear
Installation side	right
Width	230 mm
Thickness	130 mm
Inner thread	M18 x 1.5

Order number
1911 045 205



Gasket full set

Vehicle type	Axor I/II/III
Motor type	e.g. OM 906
suitable for	cylinder bore 102 mm

Scope of supply

without oil pan seal and valve cover seal

Order number
8002 000 171



Crankcase seal set

Vehicle type	Axor (t.ex. OM 906, OM 926, ...)
--------------	----------------------------------

Scope of supply

without oil pan seal

Order number
8002 534 470



Cylinder head gasket set

Vehicle type	Axor I/II/III
Motor type	e.g. OM 906
suitable for	cylinder bore 102 mm

Scope of supply

without valve stem seal

Version

for aluminium valve cover

for plastic valve cover

Order number
8002 534 693
8002 049 024



Cylinder head gasket set

Vehicle type	Axor II
Design	e.g. OM 457.914, OM 457.915, OM 457.916, OM 457.920, OM 457.923, OM 457.936

Scope of supply

with valve stem seal

Motor type

up to engine no. 085588

from engine no. 085589

Order number
8002 000 366
8002 000 373



Cylinder head gasket set

Design e.g. OM 457.933, OM 457.934, OM 457.935, OM 457.938, OM 457.941

Scope of supply
with valve stem seal

Motor type	Order number
up to engine no. 085588	8002 000 367
from engine no. 085589	8002 000 376



Cylinder head gasket set

Design e.g. OM 460.900 to OM 460.923, OM 460.925, OM 460.929, OM 460.931

Scope of supply
with valve stem seal

Motor type	Order number
up to engine no. 085588	8002 000 362
from engine no. 085589	8002 000 369



Cylinder head gasket set

Design e.g. OM 460.975 to OM 460.981

Scope of supply
with valve stem seal

Motor type	Order number
up to engine no. 085588	8002 000 368
from engine no. 085589	8002 000 378

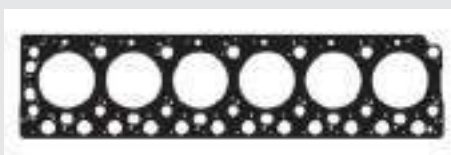

Cylinder head gasket

Vehicle type Axor I/II/III
Material metal elastomer
suitable for cylinder bore 102 mm

Order number
8002 532 579



Cylinder head screw set

Vehicle type Axor II
Design e.g. OM 475, OM 460
Version external multi-tooth
Thread M15
Length 210 mm

Contents
set for one cylinder head

Order number
8002 013 470



Cylinder head screw

Vehicle type	Axor I/II/III (t.ex. OM 906, OM 926, ...)
Material	steel
Thread	M16 x 2
Length	149 mm

for OM 906 and OM 926 14 pieces are required

Order number
8002 046 885



Oil pan gasket

Vehicle type	Axor I/II/III
--------------	---------------

Motor type	Version	Order number
e.g. OM 906, OM 926	for aluminium oil pan	8002 051 734
e.g. OM 906, OM 926	for plastic oil pan	8002 051 736

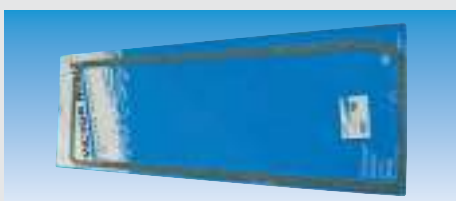

Oil pan gasket

Design	e.g. OM 457.914, OM 457.915, OM 457.916, OM 457.920, OM 457.923, OM 457.936 up to engine no. 938935 e.g. OM 457.933, OM 457.934, OM 457.935, OM 457.938, OM 457.941
--------	------------------------------------------------------------------------------------------------------------------------------------------------------------------------

Order number
8002 001 128

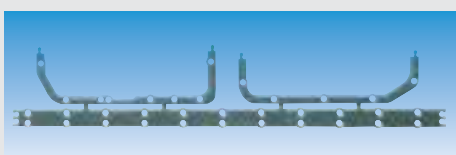

Oil pan gasket

Design	e.g. OM 457.914, OM 457.915, OM 457.916, OM 457.920, OM 457.923, OM 457.936 from engine no. 938936 e.g. OM 460.900 to OM 460.923, OM 460.925, OM 460.929, OM 460.931 and OM 460.975 to OM 460.981 without restriction
--------	--------------------------------------------------------------------------------------------------------------------------------------------------------------------------------------------------------------------------

Order number
8002 001 129

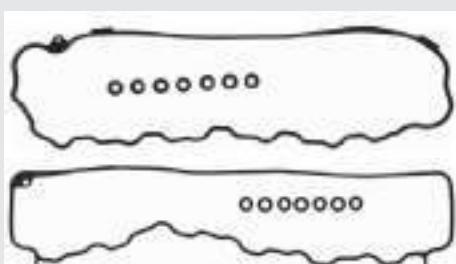

Valve cover gasket set

Vehicle type	Axor I/II/III
--------------	---------------

Motor type	Version	Order number
e.g. OM 906, OM 926	for plastic valve cover	8002 000 056
e.g. OM 906	for aluminium valve cover	8002 000 058

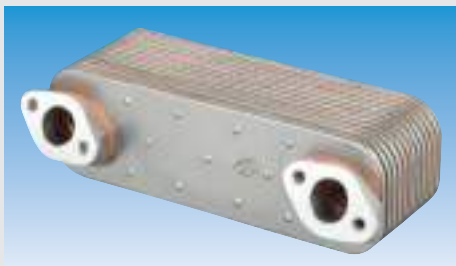

Oil cooler

Vehicle type	Axor I/II/III
Version	13 blades
suitable for	double oil filter
Length	250 mm
Width	78 mm
Height	75 mm

Order number
1911 344 200



Oil pressure sensor

Vehicle type	Axor I/II/III
Motor type	e.g. OM 904 LA, OM 906 LA
Thread	M16 x 1.5
Connection	metric

Version	Order number
without warning contact	9465 420 517
with warning contact	(on request) 9461 534 928

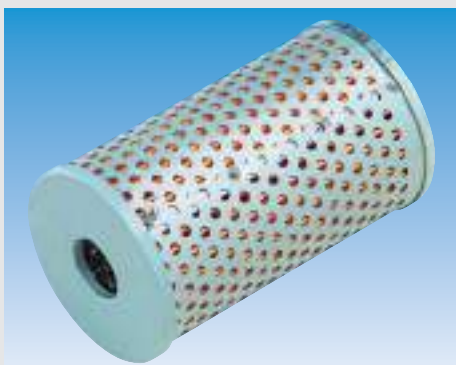

Hydraulic filter

Vehicle type	Axor I/II/III
External diameter	60 mm
Inner diameter	18/18 mm
Height	100.5 mm

Order number
9025 503 090



Fuel filter

Vehicle type	Axor I/II/III
--------------	---------------

Outer Ø mm	Inner Ø mm	Height mm	Order number
95	46	204.7	9020 009 991
91.8	44.9	102.7	9020 010 461



Air filter

Vehicle type	Dimensions mm	Order number
Axor I	Ø 420 x Height 263	9020 421 404
Axor I/II	Ø 420 x Height 317	9024 217 290
Axor I/II/III	Ø 267 x Height 533	9022 713 201
Axor I/II/III	Ø 281.5 x Height 352.8	9020 025 653
Axor I/II	Length 626 x Width 564 x Height 78	9020 641 510

(Illustration similar)



Fuel pump

Version with fuel pre-filter

Order number
9020 100 350

Service parts

Description	Order number
Fuel filter housing	9460 000 400

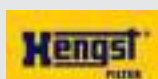

Oil filter

Vehicle type Axor I/II/III, Atego I/II/III

Outer Ø mm	Inner Ø mm	Height mm	Order number
83	37/28	211.5	2127 001 816
121	44.5 / 57	263.5	3359 175 129

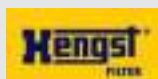

Fuel filter

Vehicle type Axor I/II/III
External diameter 50 mm
Height 41 mm

Order number	Comparative number
9750 103 124	Hengst E11S04 D65
9750 103 121	Hengst E11S03 D132



Fuel filter

Vehicle type Axor II
External diameter 44 mm
Inner diameter 24 mm
Height 80 mm

Order number
9750 230 365



Fuel filter

Vehicle type	Axor I/II/III
External diameter	107.5 mm
Height	219 mm

Order number
3565 429 204



Urea filter

Vehicle type	Axor I/II/III
External diameter	43 mm
Height	85.5 mm

Order number
9750 103 044

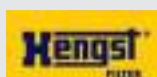
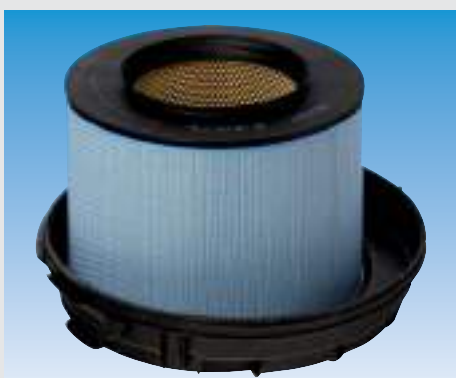

Air filter

Vehicle type	Axor I/II
External diameter	520.5 mm
Inner diameter	221.8 mm
Height	332.3 mm

Order number
9750 103 653



Exhaust turbocharger

in exchange

Vehicle type	Axor I
Motor type	e.g. OM 906

Order number
1902 024 409



Charging pressure sensor

Vehicle type	Axor I/II/III
--------------	---------------

Order number
3600 002 468

Axor
2



Charge air cooler

Vehicle type	Axor I/II/III
Length	630 mm
Width	892 mm
Depth	64 mm

Order number
0376 724 281



Charge air cooler

Vehicle type	Axor II/III
Length	596 mm
Width	712 mm
Depth	64 mm

Order number
9100 137 420

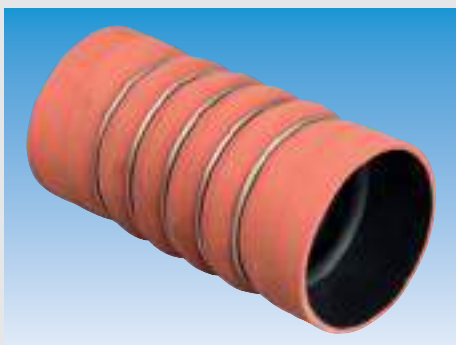

Charge air hose

Vehicle type	Axor I/II/III
--------------	---------------

Inner Ø mm	Length mm	Order number
100	200	8000 946 382
85	195	1911 045 339

Accessories

Hose clip

Clamping range mm	Order number
80-100	9100 736 600
100-120	2300 013 078



Water pump

as replacement

Vehicle type	Axor I/II/III
Type	220 1053
Version	with retarder connection

Scope of supply

with gasket set

Order number
9462 000 501



(Illustration similar)



Water pump

in exchange

Vehicle type Axor I/II/III
Type 220 1064

Scope of supply

with gasket set

Order number
9462 000 601

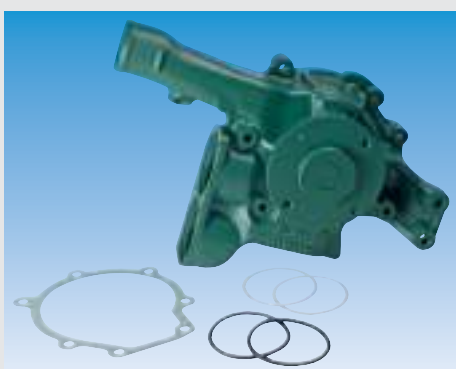

Water pump

in exchange

Vehicle type Axor I/II/III
Type 220 1075

Scope of supply

with gasket set

Order number
9152 201 075



Water pump

Vehicle type Axor II

Scope of supply

with seal set

Order number
6174 436 374



Engine radiator

Vehicle type Axor I
Height 974 mm
Width 668 mm
Depth 42 mm

Order number
0376 722 021



Engine radiator

Vehicle type	Axor I/II/III
Height	815 mm
Width	668 mm
Depth	42 mm

Order number
9100 139 720



Surge tank

for coolant

Vehicle type	Axor I/II/III
Capacity	9,7 l
Length	651 mm
Width	228 mm
Height	194 mm

Order number
0376 705 361



Thermostat

with seal

Vehicle type	Axor I/II/III
Diameter	67 mm
Opening temperature	83 °C

Order number
9100 000 007

Coolant temperature sensor

with seal

Vehicle type	Axor I/II/III
Motor type	OM 904 LA, OM 906 LA
Spanner size	22
Outer thread	M14 x 1.5

Order number
9460 462 921



Radiator fan coupling

Viscous coupling without fan

Vehicle type	Axor I
Diameter	203 mm

Order number
1888 000 021

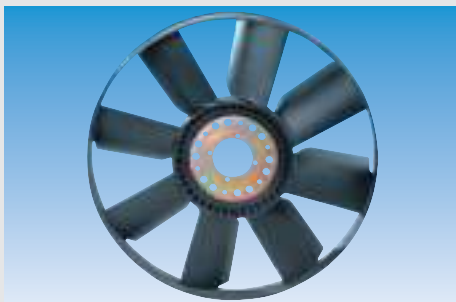

Fan wheel

Vehicle type	Axor II	
Number of blades	8	
Ø mm		Order number
600		0376 757 741
750		0376 733 261

(Illustration similar)

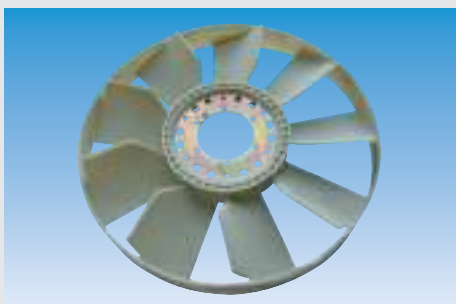

Fan wheel

Vehicle type	Axor I	
Number of blades	9	
Diameter	704 mm	
		Order number
		0376 733 181



Rear silencer

Vehicle type	Axor I/II/III	
Special equipment	508108/09 531391/01	
		Order number
		8730 100 927

Accessories

Description	Order number
Front pipe, centre	4260 054 203
Exhaust pipe clamp, Diameter 130.5 mm	8730 156 100



Rear silencer

Vehicle type	Axor I/II/III	
Special equipment	508108 07	
		Order number
		8730 207 043

Accessories

Description	Order number
Exhaust pipe	8730 207 033
Exhaust pipe clamp, Diameter 128.5 mm	8730 207 039
Exhaust pipe clamp, Diameter 135 mm	8730 207 037



Rear silencer

Vehicle type Axor I/II/III

Application range
for hazardous goods vehicles

Order number
8730 207 019

Accessories

Description	Order number
Front pipe	8730 207 028
Exhaust pipe clamp, Diameter 142 mm	8730 207 029
Exhaust pipe clamp, Diameter 130.5 mm	8730 156 100



Rear silencer

Vehicle type Axor II/III
Motor type OM 906 LA

Order number
8730 207 109

Accessories

Description	Order number
Exhaust pipe front, Diameter 89 mm	8730 207 101
Exhaust pipe clamp, Diameter 90 mm	8730 151 900



Fuel tank

steel
Form rectangular

(Illustration similar)

Vehicle type	Volume l	Dimensions mm	Order number
Axor II/III	300	640 x 560 x 950	9469 410 201
Axor I/II/III	400	640 x 560 x 1250	9469 410 401
Axor I/II/III	590	640 x 560 x 1860	9469 410 601

Accessories

Description	Order number
1 x Fuel cap, lockable, vented	9668 080 110
2 x Console	8730 122 493
4 x Console rubber	9660 022 455
2 x Tightening strap	9660 224 940
2 x Tightening strap rubber	9660 000 703
1 x Tank sensor	9660 022 481
1 x Connection set	8730 102 488
1 x Blind cover	9660 001 906
1 x Fuel Anti-syphon	9668 010 090



SAG

Fuel tank

aluminium

Form rectangular

Vehicle type	Volume l	Dimensions mm	Order number
Axor I/II/III	230	640 x 560 x 720	9464 700 101
Axor II/III	300	640 x 560 x 945	9469 420 301
Axor I/II/III	500	640 x 560 x 1560	9469 420 501

Accessories

Description	Order number
1 x Fuel cap, lockable, vented	9668 080 110
2 x Console	9660 860 050
4 x Console rubber	9660 860 070
2 x Tightening strap	9660 860 060
2 x Tightening strap rubber	9660 860 080
1 x Tank sensor	9660 022 481
1 x Connection set	8730 102 488
1 x Blind cover	9660 001 906
1 x Fuel Anti-syphon	9668 010 090



SAG

Fuel tank

aluminium

Vehicle type Axor I/II/III
Form rectangular

Volume l	Dimensions mm	Order number
300	700 x 700 x 750	9464 701 001
400	700 x 700 x 910	9660 234 200
550	700 x 700 x 1230	9664 701 401

Accessories

Description	Order number
1 x Fuel cap, lockable, vented	9668 080 110
2 x Console	9660 860 330
4 x Console rubber	9660 860 070
2 x Tightening strap	9660 860 100
2 x Tightening strap rubber	9660 860 360
1 x Tank sensor	9660 022 481
1 x Connection set	8730 102 488
1 x Blind cover	9660 001 906
1 x Fuel Anti-syphon	9668 010 090

**CONTITECH®****Ribbed V-belt**

Vehicle type Axor I/II/III

Length mm	Number of ribs	Order number
1910	8	3564 637 204
2000	8	3564 664 942
2035	8	1100 276 616
1725	9	1100 282 514
1825	9	1865 091 826
2125	9	9469 972 092
1670	10	1851 016 700
1815	10	1100 282 365



(Illustration similar)

Ribbed V-belt

Vehicle type Axor I/II/III

Length mm	Number of ribs	Order number
1420	8	1100 219 670
1480	8	9469 970 792
1920	8	1325 040 001
1940	8	9050 289 190
2085	8	3564 663 779
1780	9	9465 997 219
1890	9	1865 485 740
2000	9	1325 080 702
2010	9	2300 000 379
2338	9	1325 000 748
2020	11	3564 642 047
2040	11	1100 282 464
2044	11	2540 101 162

Professional vehicle diagnosis

Across-brand diagnostic tools for tractor vehicles, trailers, semi-trailers, buses and vans

www.europart.net





Poly-V belt tensioner

Vehicle type Axor I/II/III

Illustration	Outer Ø mm	Roll width mm	Order number
1	70	35	9462 001 070
2	74	34	1911 252 424
3	74	38,3	5930 000 554
4	74	35,5	5930 000 544
5	74	46,3	5930 000 511
6	74	39/57,7	5930 000 543
7	74	38,3	1911 400 005
8	75	32,5	9462 004 570
9	78	42	1911 043 900
10	78	42/104,5	3563 830 141
11	80	34/102,5	9462 001 970
12	81	32,9	6954 005 710
13	90	34	1911 400 001



Deflection pulley/guide pulley

for ribbed V-belt

Vehicle type Axor I/II/III

Illustration	Material	Outer Ø mm	Width mm	Order number
1	metal	80	44	1362 010 040
2	metal	74	38	5930 000 551
3	metal	95	39	1362 010 041
4	plastic	80	44	9465 500 433
5	metal	107	34	3564 580 874



Flywheel

Vehicle type	Axor I/II/III
Special equipment	SA 505009 05
Version	with gear rim
Diameter	395 mm

Order number
9460 301 905

Accessories

Grooved ball bearing with 2 sealing washers

External diameter	52 mm
Inner diameter	20 mm
Height	15 mm

Order number
8001 630 423

Flywheel

in exchange

Vehicle type	Axor I/II/III
Special equipment	SA 505009 03
Version	with gear rim and bearing
Diameter	362 mm

Order number
(on request)
9460 302 105

Flywheel

Vehicle type	Axor I/II/III
Special equipment	SA 505009 58
Version	with gear rim
Diameter	362 mm

Order number
9060 100 065



Clutch kit

as replacement

Scope of supply

Vehicle type	Axor I/III
Parameter	MFZ430
Diameter	430 mm
Number of teeth	18
Toothed hub profile	45x50-18N
Release bearing, mounted with pressure plate	

Order number

9270 122 801

Comparative number

Sachs 3400 122 801



Clutch kit

In exchange

Vehicle type	Axor II/III
Parameter	MFZ2/400
Diameter	400 mm
Number of teeth	8
Toothed hub profile	45x50-18N

Scope of supply

Disc, automatic unit, release bearing mounted

Order number

9270 121 501

Comparative number

Sachs 3400 121 501



Clutch kit

Vehicle type	Axor I/II
Parameter	MFZ430
Diameter	430 mm
Number of teeth	18
Toothed hub profile	45x50-18N

Scope of supply

Disc, automatic unit, release bearing mounted

Order number

9270 004 003

Comparative number

Sachs 3400 700 446

Suitable centring tools are available from EUROPART!

**Storage****for propeller shaft**

Vehicle type Axor II/III

External diameter 94 mm

Inner diameter 71 mm

Scope of supply

with ball bearing

Order number**9220 001 086**



SACHS ist eine
Marke von ZF



Technik, die ankommt:

SACHS Kupplungen.



SACHS Kupplungen für Nutzfahrzeuge stehen für Leistung, Ausdauer und Zuverlässigkeit. Sie vereinen innovative Technik mit traditioneller deutscher Markenqualität. Wer so sicher unterwegs ist, kommt auch zuverlässig und termingerecht ans Ziel. Tag für Tag. Ladung für Ladung. Verlassen Sie sich darauf!



Parabolic spring

Front axle

Vehicle type	Axor I/II/III
Form	1J
Number of leaves	2
Thickness	58
Width	90 mm
Length front/rear	900/900 mm
Bushing front/rear	24/60, 24/60 mm
Axle load	7,1

Order number
1033 816 000

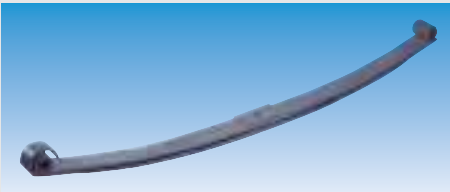

Parabolic spring

front axle

Vehicle type	Axor I/II/III
Form	1J
Number of leaves	2
Thickness	60
Width	90 mm
Length front/rear	900/900 mm
Bushing front/rear	24/60, 24/60 mm
Axle load	7,5 t

Order number
1033 818 000



Parabolic spring

front axle

Vehicle type	Axor I/II/III
Form	1KM
Number of leaves	3
Width	90 mm
Length front/rear	900/900 mm
Bushing front/rear	24/60, 24/60 mm

Thickness mm	Axle load t	Order number
79	7,5	1033 684 000
81	8	1033 682 000
83	9	1033 690 000



Spring hoop

Front axle

Vehicle type	Axor I/II/III
Thread	M20 x 1.5
Form	0
Interior width	91 mm

Length mm	Order number
205	1301 903 205
225	1301 903 225
240	1309 894 324

Accessories

Flat collar nut

Thread	M20 x 1.5
Height	20 mm

Order number
6604 020 150

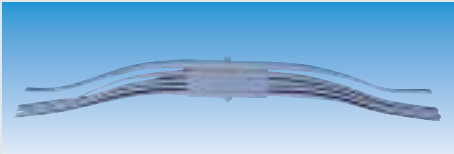

Parabolic spring

Rear axle

Vehicle type	Axor I/II/III
Form	8BP
Number of leaves	4/1
Thickness	133 mm
Width	100 mm
Length front/rear	780/780 mm
Axle load	9,5 t

Order number

1033 693 000



Parabolic spring

rear axle

Vehicle type	Axor II/III
Form	8KP
Number of leaves	5
Thickness	195 mm
Width	100 mm
Length front/rear	780/780 mm
Axle load	16 t

Order number

1033 885 000



Parabolic spring

Rear axle

Form	1BK
Number of leaves	3/1
Width	100 mm
Length front/rear	900/885 mm
Bushing front/rear	24/60, 24/60 mm
Axle load	13 t

Vehicle type	Thickness mm	Order number
--------------	--------------	--------------

Axor II/III	127	1033 681 000
-------------	-----	--------------

Axor I/II/III	133	1033 683 000
---------------	-----	--------------



Hollow rubber spring

Vehicle type	Axor II/III
Length	210-232 mm
Width	135-165 mm

Height mm	Order number
-----------	--------------

120	1593 103 050
-----	--------------

152	9560 066 359
-----	--------------



Spring hoop

Rear axle

Vehicle type	Axor II/III
Form	1
Thread	M24 x 1.5
Interior width	101 mm

Length mm	Order number
440	1301 553 440
480	1301 553 480

Accessories

Hexagon nut

Thread	M24 x 1.5
Height	24 mm

Order number
9900 135 145



Spring hoop

Rear axle

Vehicle type	Axor II/III
Form	3/7
Thread	M27 x 2
Interior width	101 mm

Length mm	Order number
380	1301 593 380
430	1398 593 430

Accessories

Hexagon nut

Thread	M27 x 2
Height	40 mm

Order number
1303 270 211



Air spring

complete, with steel piston

Vehicle type	Axor II/III
Piston diameter	280 mm
Inner diameter	280 mm
Height	270 mm

Order number
1788 475 721

**EURO
PART**
Air spring
with piston

Vehicle type	Axor I/II/III
Version	VOSS 232
External diameter	342-352 mm
Piston diameter	265 mm
Height	280 mm

Order number
1788 418 324

2

Axor



Angebot, Leistung, Preis:

Wenn alles stimmt, ist es eine Schomäcker-Feder: Ersatzteile in Erstausrüster-Qualität.



MADE IN GERMANY

2

Axor

**EURO
PART**

Air spring

with steel piston

Vehicle type	Axor I/II
Version	VOSS 232
External diameter	276-286 mm
Piston diameter	200 mm
Height	292 mm

Order number
1788 439 022

Air spring

with piston

Lower attachment: central inner thread M16 x 1.5

Air connection: outer thread M24 x 1.5, inner thread M16 x 1.5

Vehicle type	Axor I/II/III
Version	VOSS 232
External diameter	276-286 mm
Piston diameter	200 mm
Height	292 mm

Order number
1788 439 012



Air spring

with piston

Vehicle type	Axor I/II/III
Version	VOSS 232
External diameter	360 mm
Height	360 mm

Piston dia. mm	Order number
220	1788 483 822
230	1788 483 823



Shock absorber

Fastening eye/eye
Version oil pressure, twin-tube system

(Illustration similar)

Vehicle type	Installation location	Order number	Comparative number
Axor II/III	front axle	9200 000 570	Sachs 310 803
Axor I/II/III	Front axle	9200 124 639	Sachs 124 639
Axor II/III	front axle	9200 124 678	Sachs 124 678
Axor I/II/III	front axle	9200 001 290	Sachs 131 944
Axor I/II/III	rear axle	9200 131 623	Sachs 131 623
Axor II/III	front axle	9200 001 235	Sachs 310 807
Axor I/II/III	rear axle	9200 124 567	Sachs 124 567
Axor II/III	rear axle	9200 001 310	Sachs 124 376
Axor II/III	Rear axle	9200 124 638	Sachs 124 638



Shock absorber

Fastening eye/eye
Version oil pressure, twin-tube system
Installation location front axle

Vehicle type	Order number	Comparative number
Axor I/II/III	9463 235 400	Sachs 131 622
Axor II/III	9201 317 470	Sachs 131 747
Axor I/II/III	9201 319 440	Sachs 131 944

(Illustration similar)



Shock absorber

Super Touring

Fastening Eye/eye
Version Oil pressure, twin-tube
Installation location Rear axle

Vehicle type	Order number	Comparative number
Axor II/III	9201 243 130	Sachs 124 313
Axor II/III	9201 243 600	Sachs 124 360
Axor I/II/III	9270 311 644	Sachs 311 644
Axor I/II/III	9750 001 258	Sachs 311 665

(Illustration similar)

Axor
2



Drag-link

Vehicle type	Axor I/II/III
Installation location	front
Length	725 mm
Pipe diameter	36 mm
Cone diameter	22 mm

Order number
9070 900 087

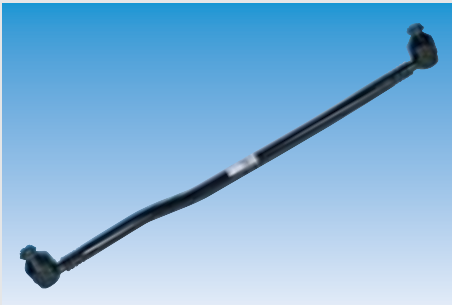

Drag-link

Vehicle type	Axor II/III
Installation location	intermediate lever 1 to intermediate bearing 2
Length	1095 mm
Pipe diameter	42 mm
Cone diameter	32 mm

Order number
9070 001 014

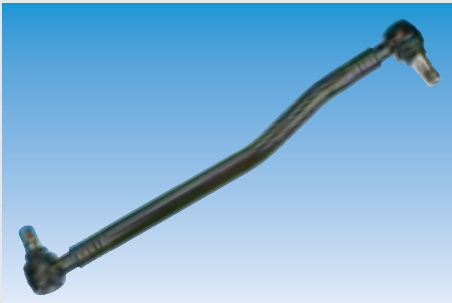

Drag-link

X-CAP

Vehicle type	Axor II
Installation location	drop arm to the 1st front axle
Length	711 mm
Pipe diameter	42 mm
Cone diameter	32 mm

Order number
9890 200 163



Drag-link

X-CAP

Vehicle type	Axor I/II/III
Installation location	drop arm to the 1st front axle
Length	895 mm
Pipe diameter	40 mm
Cone diameter	28,6 mm

Order number
1903 359 600



Ball joint for steering rod

Vehicle type Axor I/II/III
Installation location front axle

(Illustration similar)

Threadtype	Outer thread	Cone-Ø mm	Length mm	Order number
right-hand thread	M28 x 1.5	28.6	141	9070 900 053
right-hand thread	M30 x 1.5	28.6	115	9079 927 623
right-hand thread	M24 x 1.5/M30 x 1.5	30	120	9070 900 117
left-hand thread	M24 x 1.5/M30 x 1.5	30	120	9070 900 123



Power-steering pump in exchange

Vehicle type Axor I/II/III
Version hydraulic

Order number	Comparative number
9074 204 210	Mercedes-Benz 001 460 44 80
9074 209 110	Mercedes-Benz 002 460 14 80
6952 009 210	Mercedes-Benz 002 460 15 80



Stabilizer mounting

Vehicle type Axor I/II/III

Installation location	Outer Ø mm	Inner Ø mm	Length mm	Material	Order number
front	61	38	55	rubber	9460 109 904
front/rear	70	40	46	rubber/metal	9290 002 430
front	74	47	56	rubber	9460 109 905
rear	80	40	46	rubber/metal	9463 238 185
rear	87	56	56	rubber	1597 200 333
front	98	70	67	rubber	9461 323 015
front/rear	108.5	80	67	rubber	1583 006 123



Stabilizer mounting

Vehicle type	Axor I/II/III
Version	for vehicles with air suspension
Installation location	rear
External diameter	109 mm
Inner diameter	88 mm
Length	175 mm
Distance between centres	130 mm
Bore hole diameter	20.5 mm

Order number
1583 006 121



Steering Track Rod

Vehicle type	Axor I/II/III
Form	straight
Installation location	front axle
Threadtype	right-hand thread
Length	1735 mm
Pipe diameter	50 mm
Cone diameter	32 mm

Order number
9070 900 013



Steering Track Rod

Vehicle type	Axor I/II/III
Form	offset
Installation location	front axle
Threadtype	right-hand thread
Length	1735 mm
Pipe diameter	52 mm
Cone diameter	32 mm

Order number
9070 001 410



Ball joint

for track rod

Vehicle type	Axor I/II/III
Installation location	front axle
Outer thread	M27 x 1.5/M30 x 1.5
Cone	32 mm
Length	120 mm

Threadtype

left-hand thread	
right-hand thread	

Order number
9070 900 045
9070 900 015

(Illustration similar)



Repair kit

Kingpin

Vehicle type Axor I/II/III
 Bolt diameter 50 mm
 Bolt length 223 mm

Scope of supply

2 top needle bearings, 2 bottom needle bearings, 1 thrust bearing, 1 sealing ring, 1 thrust collar

Installation location	Installation side	Order number
track-rod arm side	left	9460 066 235
steering arm side	right	9460 066 328

Accessories

Description	Order number
Kingpin	9463 320 006

Wheel hub

Vehicle type Axor I/II/III
 Version without bearing
 Installation location Front axle

Order number
9870 102 496

Compact bearing

Vehicle type Axor I/II
 External diameter 140 mm
 Inner diameter 82 mm
 Width 115 mm

Scope of supply

inner and outer bearing with sealing ring

Order number
9469 819 305



Tapered roller bearing

Vehicle type Axor I/II/III

Version	Outer Ø mm	Inner Ø mm	Height mm	Order number
wheel hub, outside	72	35	28	8001 332 070
wheel hub, inner	150	70	64	8001 228 000
wheel hub, outer	157	100	42	9469 812 305
rear axle, outer	160	100	44	8001 805 312



Tapered roller bearing

Vehicle type Axor I/II/III

(Illustration similar)

Version	Outer Ø mm	Inner Ø mm	Height mm	Order number
wheel hub, outer	130	60	48.5	8001 323 122
wheel hub, outer	130	80	37	8001 331 162
wheel hub, inner	150	100	39	8001 330 202
wheel hub, inner	170	110	47	8001 330 222

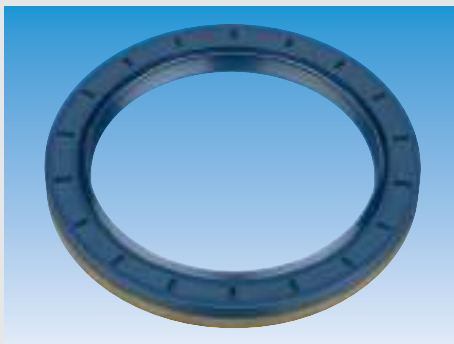

**Shaft sealing ring
for wheel hub**

Vehicle type Axor I/II/III
 Installation location front axle, inner
 Version for 8-hole wheel connection
 External diameter 150 mm
 Inner diameter 120 mm
 Height 12 mm

Order number
9460 245 939

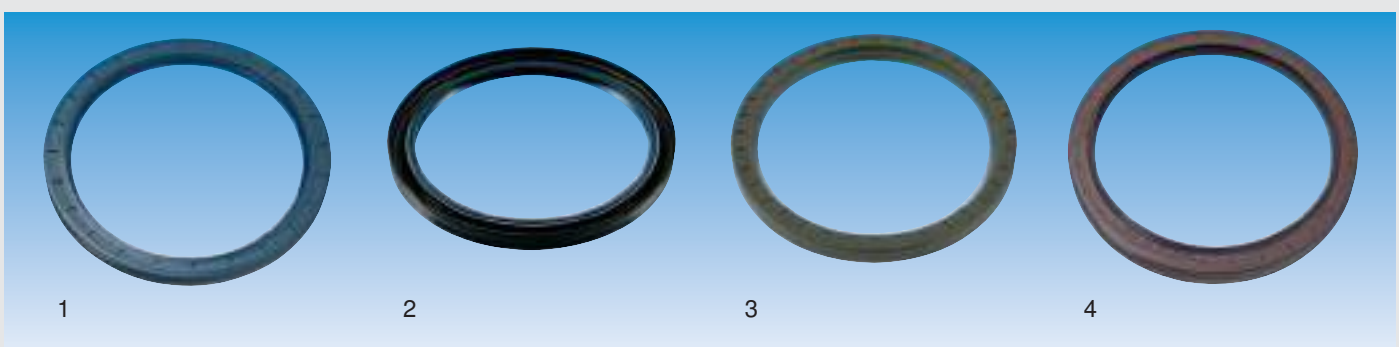

**Shaft sealing ring
for wheel hub**

Vehicle type Axor I/II/III
 Installation location Rear axle, inner
 External diameter 175 mm
 Inner diameter 145 mm

Illustration	Height mm	Order number
1	13	8002 972 960
2	14	8002 979 998
3	15	8002 972 816
4	17/21	8002 972 815



Repair kit

for wheel hub

Vehicle type	Axor II/III
Installation location	Rear axle
Installation side	left, right
External diameter	150 mm
Inner diameter	125 mm
Height	15 mm

Scope of supply

1 shaft seal, 1 seal, 1 locking washer

Order number

9460 006 120



Gasket set

for wheel hub

Vehicle type	Axor I/II/III
Installation location	front axle
External diameter	150 mm
Inner diameter	120 mm
Height	20 mm

Scope of supply

2 axial seals, 1 seal, 1 pulse wheel, 8 hexagon bolts

Order number

9463 301 025

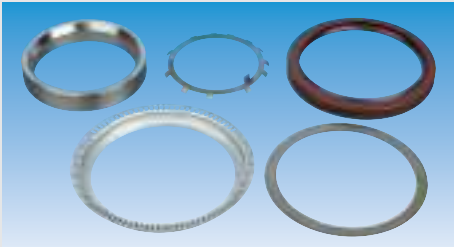

Gasket set

for wheel hub

Vehicle type	Axor I/II/III
Installation location	rear axle
Installation side	left/right
External diameter	175 mm
Inner diameter	145 mm
Height	17 mm

Scope of supply

1 axial seal, 1 thrust ring, 1 pulse wheel, 1 cover plate, 1 tab washer

Order number

8002 000 033

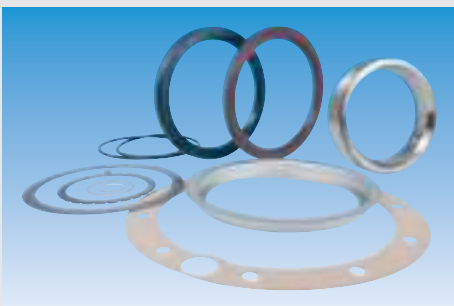

Gasket set

for wheel hub

Vehicle type	Axor I/II/III
Installation location	rear axle
Installation side	left/right
External diameter	175 mm
Inner diameter	145 mm
Height	13 mm

Scope of supply

2 axial seals, 1 pulse wheel, 1 thrust ring, 1 flat seal, 2 sealing ring, 1 circlip, 1 aluminium sealing ring

Order number

2127 009 347

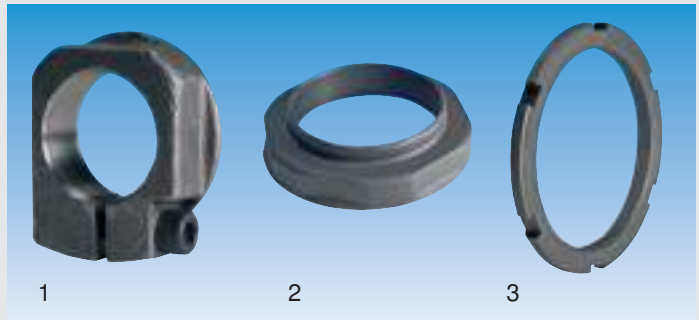

Axle nut

Vehicle type Axor I/II/III

Illustration	Installation location	Thread	Order number
1	Front axle/rear axle	M45 x 1.5	1325 040 294
2	Front axle	M70 x 1.5	9469 908 150
3	Rear axle	M100 x 1.5	9463 560 226

Suitable wrenches are available from EUROPART!



'A' frame

with molecular bearing

Vehicle type Axor I/II/III
 Installation location rear axle
 Length 622 mm
 Distance between holes 152/130/130 mm

Illustration	Pipe Ø mm	Bore hole Ø mm	Order number	Comparative number
1	48	25/23/23	9070 001 009	Mercedes-Benz 942 350 12 05
2	46	25/25/25	9070 001 021	Mercedes-Benz 942 350 15 05
2	46	25/25/25	9070 001 022	Mercedes-Benz 948 350 04 05



'A' frame

with molecular bearing

Vehicle type Axor I/II/III
 Installation location rear axle
 Length 622 mm
 Distance between holes 152/130/130 mm
 Pipe diameter 46 mm
 Bore hole diameter 25/23/23 mm

Order number
5220 090 013

TRY ME!

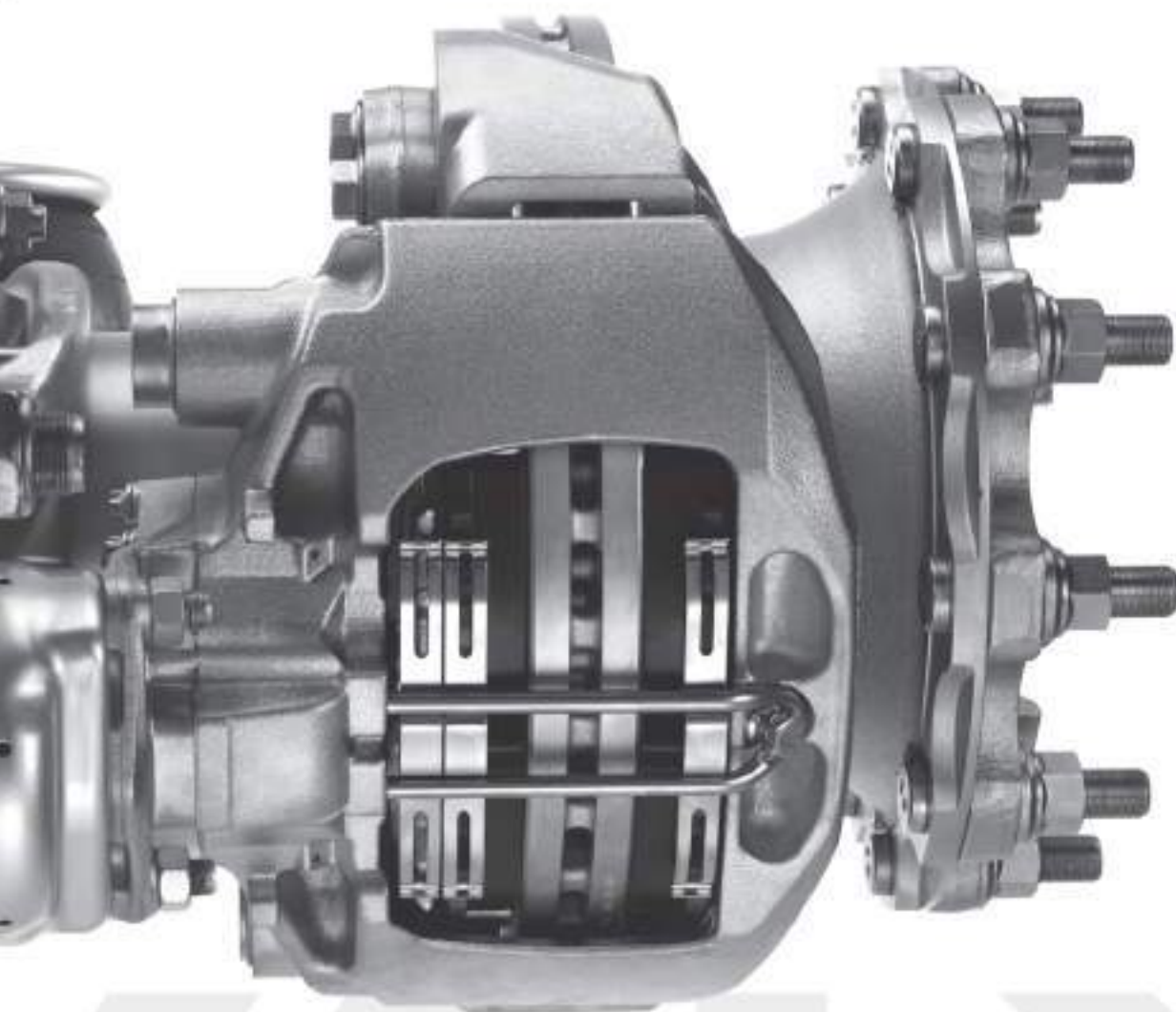

Warum VALX Achsen ausprobieren? Weil VALX ein neues niederländisches Unternehmen mit jungen ambitionierten Zielen ist? Ziele, die ausschließlich auf ein hohes Maß an Kundenzufriedenheit und hoher Qualität begründet sind? Oder weil VALX ein brillantes europäisches Design mit der Effizienz eines chinesischen Herstellers kombiniert? Liegt es vielleicht auch daran, dass VALX Achsen unter den härtesten Bedingungen getestet werden und die starke Präsenz in Europa eine flächendeckende und zuverlässige Partnerschaft garantiert? Wahrscheinlich wollen Sie VALX einsetzen, weil VALX Achsen insgesamt alle Frage beantwortet!

In der Tat sind VALX Achsen die clevere Alternative. Wenn Sie mehr über VALX Wissen wollen, besuchen Sie uns auf der www.valx.eu oder nehmen Sie Kontakt mit uns auf, Tel +31 (0) 40 2088444, oder schreiben Sie an P.O. Box 2, NL-5550 AA Valkenswaard, Niederlande.

Valx axles. The smart alternative.

VALX
GOING THE EXTRA MILE



Repair kit

for wishbone

Vehicle type	Axor I/II/III
Version	with molecular bearing
Bore hole diameter	23 mm
Distance between holes	130 mm

Order number
9079 991 558



Repair kit

for wishbone

Vehicle type	Axor I/II/III
Version	with molecular bearing

Bore hole Ø mm	Distance between holes mm	Order number
24	130	9463 504 805
25	130	9079 991 608
25	152	9077 200 300
25	152	9079 991 609
25	152	9070 310 410



Trailing arm

Vehicle type	Axor II/III
Version	with molecular bearing
Length	850 mm
Pipe diameter	52 mm
Bore hole diameter	17 mm
Distance between holes	100 mm

Order number
9070 022 092



Trailing arm

Vehicle type	Axor II/III
Version	with molecular bearing
Length	754 mm
Pipe diameter	58 mm
Bore hole diameter	17 mm
Distance between holes	100 mm

Order number
9079 991 543

Repair kit

axle strut, torque rod

Vehicle type	Axor I/II/III
Version	with molecular bearing
Installation location	Rear axle
Installation side	left, right
External diameter	85 mm
Inner diameter	21 mm
Distance between holes	152 mm

Order number
6170 490 816

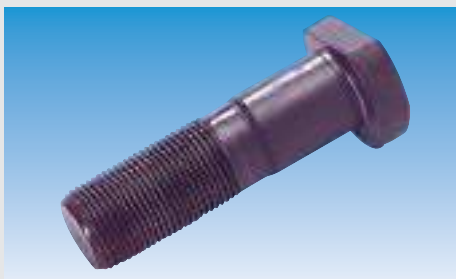

Wheel bolt

Vehicle type	Axor I/II/III
Outer thread	M22 x 1.5

Installation location	Overall length mm	Order number
front axle/rear axle	78,5	2213 000 105
rear axle	96,6	2213 000 106
rear axle	101,5	2213 000 110

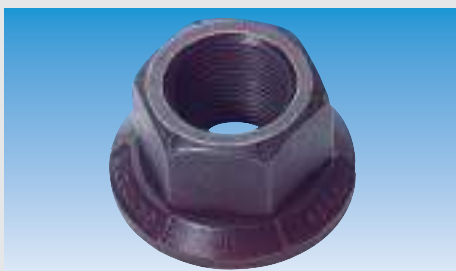

Wheel nut

Vehicle type	Axor I/II/III
Thread	M22 x 1.5
Spanner size	32

Illustration similar

Installation location	suitable for	Height mm	Order number
front axle/rear axle	steel and aluminium wheels	27	1303 221 551
front axle	aluminium wheels	34 (Short sleeve)	6136 320 442
rear axle	aluminium wheels	62 (Long sleeve)	6136 320 452

2

Axor

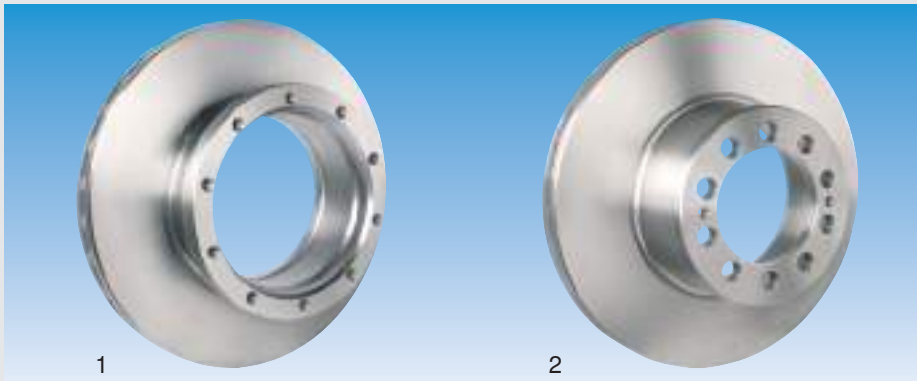

Brake disc

Vehicle type	Axor I/II
Installation location	front/rear axle
Version	internally ventilated

Illustration	Height mm	Hole pattern	Order number
1	132.5	10 x M14 x 1,5	3403 460 000
2	143.5	10 x M20 x 1,5	3403 460 001

Suitable brake piston resetting tools available from EUROPART!

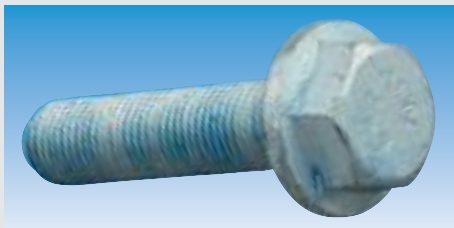

Attachment screw

for brake disc

Vehicle type	Axor I/II
Installation location	Front axle
Surface	dacrotized
Property class	10.9
Thread	M14 x 1.5
Length	60 mm

Order number
9460 066 205

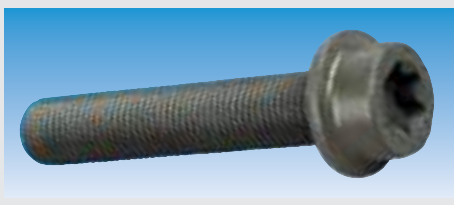

Attachment screw

for brake disc

Vehicle type	Axor I/II
Installation location	Rear axle
Surface	phosphated
Property class	10.9
Thread	M14 x 1.5
Length	75 mm

Order number
9469 900 004



Brake pad set

Contents of set 4
Lining thickness 30.00 mm

Scope of supply
with accessories

Installation location	Brake system	WVA no.	Coating length mm	Lining width mm	Order number
front axle	Knorr SB 6000	29095	210	92,5	2129 095 005
front/rear axle	Knorr SB/SN 7	29061	248	108	2323 405 106



Brake pad set

Vehicle type Axor II
Brake system Knorr SB 7000
WVA no. 29202
Contents of set 4
Coating length 247,7 mm
Lining width 109,7 mm
Lining thickness 30.00 mm

Scope of supply
with accessories

Order number
2190 873 005



Brake caliper

Vehicle type	Axor I/II
Installation location	front axle/rear axle
Version	standardised

Application range
for 22.5" wheel size

Type	Installation side	Order number
SN7211RC	left	3450 003 800
SN7201RC	right	3450 003 799

Accessories

Description	Order number
Pressure pad set	3400 110 013
Guide sealing set	3450 414 380
Adjuster cap set	3450 411 915



Brake caliper

Vehicle type	Axor I/II
Installation location	front axle/rear axle
Version	standardised

Application range
for 22.5" wheel size

Type	Installation side	Order number
SN7300RC	left	3400 047 092
SN7310RC	right	3400 013 182

Accessories

Description	Order number
Pressure pad set	3400 110 013
Guide sealing set	3450 414 380
Adjuster cap set	3450 411 915



Brake caliper

Vehicle type	Axor II/III
Installation location	front axle/rear axle
Version	standardised

Application range
for 17.5" wheel size

Type	Installation side	Order number
SN5016RC	left	3450 414 785
SN5006RC	right	3450 414 784

Accessories

Description	Order number
Pressure pad set	3400 001 929
Guide sealing set	3400 047 188
Adjuster cap set	3450 411 915



Brake caliper

Vehicle type	Axor II/III
Installation location	front axle/rear axle
Version	standardised

Application range
for 17.5" wheel size

Type	Installation side	Order number
SN5015RC	left	3450 414 783
SN5005RC	right	3450 414 782

Accessories

Description	Order number
Pressure pad set	3400 001 929
Guide sealing set	3400 047 188
Adjuster cap set	3450 411 915

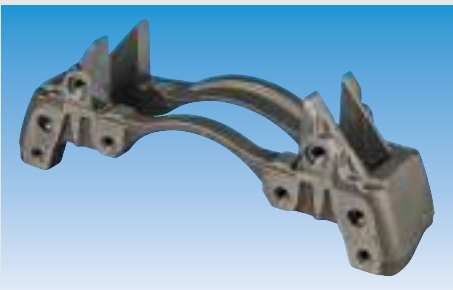

Brake caliper carrier

Vehicle type	Axor I/II
Brake system	Knorr SB/SN 7

Installation location	Order number
front axle	3450 411 905
rear axle	3450 411 910

EUROPART® – a powerful brand

Alongside well-known manufacturer's brands, EUROPART also offers a strong assortment of its own-brand products with more than 5000 items from the various EUROPART ranges.

Your advantages:

- Low-cost alternative for OE standard
- Maximum availability at 200 locations in 28 countries
- Increase your competitiveness
- Consistent service package

Top quality at a fair price.



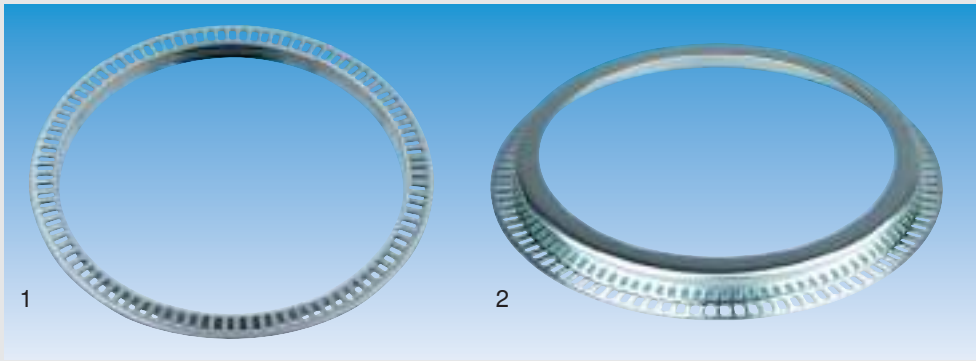

Sensor ring, ABS

ABS

Vehicle type Axor I/II/III

Illustration	Installation location	Outer Ø mm	Inner Ø mm	Thickness mm	Order number
-	Front axle	178	140	15	9463 334 011
1	Front axle	164/188	160	12	1593 102 551
2	Rear axle	176/195.5	153	16.5	1593 102 550



Brake drum

Vehicle type Axor I/II

Illustration	suitable for	Dimensions mm	Brake path mm	Order number
1	front axle	410 x 237 x 10 x 23/ 3 x M12 x 1,5	191	2030 410 039
2	rear axle	410 x 306 x 10 x 24/5 x 24/ 3 x M12 x 1,5	237	2030 410 040
1	rear axle	410 x 306 x 10 x 23/5 x 24/ 3 x M12 x 1,5	240	2030 410 034

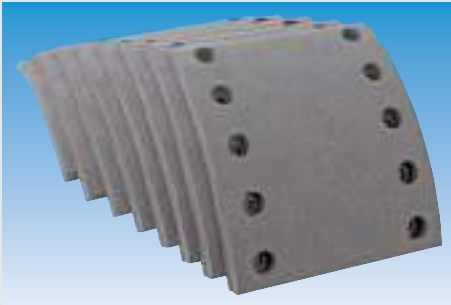
**EURO
PART**

Brake lining set

Vehicle type	Axor I/II
Lining thickness	17.00 mm
Contents of set	8

WVA no.	Dimensions mm	Order number
19495	410 x 183	2119 487 008
19496	410 x 223	2119 488 008

2

Axor

Die Nummer 1

Der Gestängesteller von Haldex

Innovative Vehicle Solutions

Über 60 Millionen mal gewählt und so konzipiert, daß er mindestens 2,5 Millionen Bremsbetätigungen standhält.

Entscheiden Sie sich daher für das Original: Qualität, maximale Sicherheit und ein hervorragendes Preis-/Leistungsverhältnis.

 Weitere Informationen: www.haldex.com



WABCO

Air dryer

Vehicle type	Axor I/II/III
Version	1-chamber system
Operating pressure	max. 13 bar

Order number	Comparative number
0565 000 070	WABCO 932 500 110 0



WABCO

Air dryer

Vehicle type	Axor I/II/III
Version	1-chamber system with integrated pressure regulator and heating
Operating pressure	max. 13 bar
Opening pressure	14,5 + 2,5 bar
Cut-off pressure	12 ± 0,3 bar
Operating range	1,5 +/- 0,25 bar
Voltage	24 V

Order number	Comparative number
0564 000 020	WABCO 932 400 024 0



WABCO

Air dryer

Vehicle type	Axor II/III
Version	2 chamber system
Operating pressure	max. 13 bar
Opening pressure	14,5 ± 2,5 bar
Cut-off pressure	12 ± 0,3 bar
Operating range	1,3 + 0,7 bar
Voltage	24 V

Order number	Comparative number
0174 330 020	WABCO 432 433 002 0
0174 320 060	WABCO 432 433 206 0



WABCO

Air dryer

as replacement

Vehicle type	Axor I/II/III
Operating pressure	max. 13 bar
Thread	M39 x 1.5

Order number

3419 851 271

Comparative number

WABCO 432 410 222 7



WABCO

Air dryer

new drying agent cartridge with improved oil precipitation thanks to integrated coalescence filter for precipitating the tiniest of oil drops, based on tried and trusted WABCO technology

Vehicle type	Axor I
Operating pressure	max. 13 bar
Thread	M39 x 1.5

Easy to retrofit as a replacement for standard drying agent cartridge.

Order number

0179 012 232

Comparative number

WABCO 432 901 223 2



KNORR-BREMSE

Air dryer

Vehicle type	Axor I/II/III
Version	1-chamber system
Cut-off pressure	12,3 +/- 0,3 bar
Operating range	1,5 +/- 0,25 bar
Voltage	24 V

Order number

3450 409 045

Comparative number

Knorr II38310FN00



Air dryer

Vehicle type	Axor I/II/III
Version	1-chamber system
Cut-off pressure	12,3 +/- 0,3 bar
Operating range	1,5 +/- 0,25 bar
Voltage	24 V

Order number

3400 038 309

Comparative number

Knorr II38308FN00



Four-circuit protection valve

as replacement

Vehicle type	Axor I/II/III
Operating pressure	max. 13 bar

Order number

0577 050 050

Comparative number

WABCO 934 705 005 7



Pressure sensor

Vehicle type	Axor I/II/III
--------------	---------------

Order number

0210 435 011

Comparative number

WABCO 932 500 501 1



Pressure sensor

Vehicle type	Axor I/II/III
--------------	---------------

Order number

3450 414 230

Comparative number

Knorr II39746F004

**EURO
PART**
Compressed air tank
EN 286-2, steel

Version	with bracket
Volume	5 l
Diameter	154 mm
Length	341 mm
Connection	3 x M22 x 1.5
Operating pressure	10 bar

Order number
3620 001 545

**EURO
PART**
Compressed air tank
EN 286-2, steel

Connection	4 x M22 x 1.5
Operating pressure	max. 15.5 bar

Volume l	Ø mm	Length mm	Order number
10	206	368	3620 020 610
30	276	583	3620 027 630

Compressed air tank
to EN 286-2, Aluminium

Connection	2 x M22 x 1.5
Operating pressure	max. 12.5 bar

Volume l	Ø mm	Length mm	Order number
20	246	500	1740 200 024
30	246	720	1742 302 460
40	276	770	1742 402 760

Air reservoir tensioning strap
with bracket, 1-piece

Ø mm	Order number
206	1740 012 060
246	1740 022 460
276	1740 032 760

Accessories
Tensioning strap base

Length	1000 mm
Material	rubber

Order number
9085 413 340



Dehumidification valve

DIN 74292, standard B

Version	mechanical, with ring
Material	brass
Connection	M22 x 1,5
Operating pressure	20 bar
Spanner size	27

Order number

1740 060 020



WABCO

Braking-value sensor

EBS

Vehicle type	Axor II
Version	without silencer
Operating pressure	max. 10 bar
Connection 1-2	M22 x 1,5
Connection 4	M16 x 1,6
Thread	VOSS

Order number

0640 060 030

Comparative number

WABCO 480 001 000 0



WABCO

Hand brake valve

Vehicle type	Axor I/II/III
Operating pressure	max. 10 bar

Order number

0607 231 250

Comparative number

WABCO 961 723 125 0



KNORR-BREMSE

Hand brake valve

Vehicle type	Axor I/II/III
Operating pressure	max. 10/8.5 bar

Order number

3401 970 066

Comparative number

Knorr K038808N00



Hand brake valve

Vehicle type Axor I/II/III
Version lateral connections
Operating pressure max. 10 bar

Order number	Comparative number
3400 006 770	Knorr K038804N00



Hand brake valve

Vehicle type Axor I/II/III

Order number	Comparative number
3400 006 760	Knorr K038803N00



Motor coach brake valve

with VOSS 232 coupling unit
Vehicle type Axor I/II/III
Version lead 0.5 bar, control ratio 2:1, with silencer
Operating pressure max. 10 bar

Order number	Comparative number
0283 192 740	WABCO 461 319 274 0



EBS axle modulator

Vehicle type Axor I/II/III

Order number	Comparative number
0362 000 037	WABCO 480 103 011 0



EBS axle modulator

Vehicle type Axor I/II/III

Order number	Comparative number
3800 105 006	WABCO 480 105 006 0
3801 050 070	WABCO 480 105 007 0

(Illustration similar)



WABCO

EBS relay valve

Vehicle type	Axor I/II/III
Version	proportional relay valve, with silencer
Thread	VOSS 232
Connection	electric, bayonet DIN
Connection 1-2	M22 x 1,5
Connection 4	M16 x 1,5

Order number	Comparative number
0640 060 040	WABCO 480 202 004 0



WABCO

Relay valve

Vehicle type	Axor I/II/III
Thread	VOSS 230
Connection	electric, bayonet (DIN)
Connection 1-2	M22 x 1,5
Connection 3	with muffler
Connection 4	M16 x 1,5

Order number	Comparative number
0640 060 037	WABCO 973 006 003 0



WABCO

Relay valve

Vehicle type	Axor I/II/III
Thread	VOSS
Connection 1-2	M22 x 1,5
Connection 3	with muffler
Connection 4	M16 x 1,5

Order number	Comparative number
0640 110 040	WABCO 973 011 004 0



WABCO

Solenoid control valve for ABS

Vehicle type	Axor I/II/III
Installation location	rear axle
Voltage	24 V
Electric current	1,65 A
Connection	electric, bayonet (DIN)
Connection thread	M22 x 1.5 JED-388

Order number	Comparative number
0371 950 087	WABCO 472 195 016 0



WABCO

Speed sensor

S plus

Vehicle type Axor I/II/III

Illustration	Colour	Cable length mm	Order number	Comparative number
1	orange	2500	0210 329 200	WABCO 441 032 920 0
1	orange	3000	0210 329 420	WABCO 441 032 942 0
1	orange	3600	0210 329 460	WABCO 441 032 946 0
2	black	1500	0210 328 510	WABCO 441 032 851 0
2	black	2000	0210 328 230	WABCO 441 032 823 0
3	black	3400	0210 329 410	WABCO 441 032 941 0

Accessories

Clamping sleeve

Length 33 mm

Order number
0687 605 104



KNORR-BREMSE

Membrane brake cylinder

Type 24

with VOSS 232 coupling unit

Vehicle type Axor I/II/III
 Installation location front axle
 Connection 1 side, M22 x 1.5, VOSS NG 12
 Connection 2 central, M12 x 1.5
 Stroke 64 mm
 Length of piston rod 15 mm

Installation side	Order number	Comparative number
left	3405 351 500	Knorr K002720N00
right	3405 351 400	Knorr K002624N00



Membrane brake cylinder

Type 24

Vehicle type	Axor I/II/III
Installation location	front axle
Connection 1	M22 x 1.5
Connection 2	M12 x 1.5
Stroke	64 mm
Length of piston rod	15 mm

Installation side	Order number	Comparative number
left	3405 352 200	Knorr K002722N00
right	3405 351 600	Knorr K002721N00



Combination brake cylinder

Type 20/24 IBV

with VOSS 232 coupling unit

Vehicle type	Axor I/II/III
Installation location	rear axle
Connection	M22 x 1.5, VOSS NG 12
Stroke	64/64 mm
Length of piston rod	15 mm

Installation side	Order number	Comparative number
left	0554 600 010	WABCO 925 480 005 0
right	0554 600 000	WABCO 925 480 004 0



Combination brake cylinder

Type 12/16 IBV

Vehicle type	Axor I/II/III
Installation location	rear axle
Installation side	left/right
Connection	M22 x 1.5, VOSS 232
Operating pressure	max. 10.2/8.5 bar
Stroke	57/57 mm
Length of piston rod	15 mm

Order number	Comparative number
0554 661 010	WABCO 925 486 101 0



WABCO

Combination brake cylinder

Type 20/24 IBV

with VOSS 232 coupling unit

Vehicle type	Axor I/II
Installation location	rear axle
Connection	M22 x 1.5, VOSS NG12
Operating pressure	max. 10.2/8.5 bar
Stroke	64/64 mm
Length of piston rod	15 mm

Installation side	Order number	Comparative number
left	0554 600 110	WABCO 925 480 011 0
right	0554 600 100	WABCO 925 480 010 0



KNORR-BREMSE

Combination brake cylinder

Type 20/24

with VOSS 232 coupling unit

Vehicle type	Axor I/II/III
Installation location	rear axle
Connection	M22 x 1.5
Stroke	64/64 mm
Length of piston rod	15 mm

Installation side	Order number	Comparative number
left	3404 045 000	Knorr K004045000
right	3404 044 000	Knorr K004044000



KNORR-BREMSE

Combination brake cylinder

Type 20/24 HFL3

with VOSS 232 coupling unit

Vehicle type	Axor I/II/III
Installation location	rear axle
Connection	M22 x 1.5, VOSS NG 12
Stroke	64/64 mm
Length of piston rod	15 mm

Installation side	Order number	Comparative number
left	3400 019 060	Knorr K002860N00
right	3400 046 505	Knorr K002861N00



WABCO

Clutch servo

Vehicle type	Axor I/II/III
Connection	M16 x 1.5
Stroke	85 mm
Operating pressure	max. 10 bar

Order number	Comparative number
0730 514 410	WABCO 970 051 441 0



Coupling head

automatic

Version with valve

Version	Connection thread	Colour	Order number
brake line	M16 x 1.5	yellow	3700 000 011
brake line	M22 x 1.5	yellow	3700 000 013
supply line	M16 x 1.5	red	3700 000 012
supply line	M22 x 1.5	red	3700 000 014



Coupling head

automatic

Version supply line
Connection thread M16 x 1.5

Order number
3700 000 008



WABCO

ECAS path sensor

for air suspension

Vehicle type	Axor I/II/III
Connection	bayonet DIN 72585-A1-2.1-Sn/K2

Order number	Comparative number
9465 422 618	WABCO 441 050 121 0



WABCO

ECAS solenoid valve

Vehicle type	Axor I/II/III
Installation location	rear axle
Version	3 magnets, with silencer
Connection	electric, bayonet DIN
Connection thread	M22 x 1.5
Voltage	24 V
Operating pressure	max. 13 bar

Order number

0379 000 600

Comparative number

WABCO 472 900 060 0

Accessories

Muffler

Diameter	69 mm
Height	45/56.5 mm
Operating pressure	max. 13 bar
Connection	M22 x 1.5

Order number

0174 070 000



WABCO

ECAS solenoid valve

Vehicle type	Axor I/II/III
Installation location	Rear axle
Version	with muffler
Connection	electric, bayonet DIN
Connection thread	M22 x 1.5
Voltage	24 V
Operating pressure	max. 13 bar

Order number

0378 800 000

Comparative number

WABCO 472 880 000 0



WABCO

ECAS solenoid valve

Vehicle type	Axor I/II/III
Installation location	rear axle, tag axle
Version	with noise reducer, solenoid connection at top
Connection	electric, 2 x bayonet (DIN)
Connection thread	M22 x 1.5, VOSS 230
Voltage	24 V
Operating pressure	max. 5-13 bar

Order number

0379 051 110

Comparative number

WABCO 472 905 111 0



Assortment case

for VOSS connector system 230, complete

Version	Order number
42-piece	0307 001 415

Contents

Number	Description	Dimensions mm	Order number
2	Straight connector	NG 8, Pipe connector 6 x 1	0307 000 050
2	Straight connector	NG 8, Pipe connector 9 x 1,5	0307 000 350
2	Straight connector	NG 12, Pipe connector 9 x 1,5	0307 000 180
2	Straight connector	NG 12, Pipe connector 12 x 1,5	0307 000 200
1	Straight connector	NG 12, Pipe connector 16 x 2	0307 000 060
1	Tee plug connector	NG 12, Pipe connector 12 x 1,5	0307 001 960
1	Angled plug	NG 8, 90°, Pipe connector 6 x 1	0307 000 070
2	Angled plug	NG 8, 90°, Pipe connector 8 x 1	0307 000 340
2	Angled plug	NG 12, 90°, Pipe connector 8 x 1	0307 000 220
2	Angled plug	NG 12, 90°, Pipe connector 12 x 1,5	0307 000 230
6	Gasket set, for connectors	NG 8	9460 002 310
6	Gasket set, for connectors	NG 12	9460 002 311
4	Union bolt	NG 8, M16 x 1.5	0307 000 030
4	Union bolt	NG 12, M22 x 1.5	0307 000 160
1	Threaded compression adapter	NG 8, M16 x 1.5	3800 022 601
1	Straight screw-in coupling	NG 12, M16 x 1.5	0307 000 300
1	Straight screw-in coupling	NG 12, M22 x 1.5	0307 000 240
1	Sealing plug	NG 8	0307 001 990
1	Sealing plug	NG 12	0307 001 980



Assortment case

for VOSS connector system 232, complete

Version	Order number
381-piece	0307 000 145

Contents

Number	Description	Type	Dimensions mm	Order number
4	Straight coupling	232	NG 8, Pipe connector 8 x 1	0307 124 325
4	Straight coupling	232	NG 12, Pipe connector 12 x 1,5	0307 124 330
10	Adapter for units with step drilling	230	NG 6	0307 000 194
4	Straight screw-in coupling	232	NG 8, M16 x 1.5	0307 124 220
4	Straight screw-in coupling	232	NG 12, M16 x 1.5	0307 124 290
4	Straight screw-in coupling	232	NG 12, M22 x 1.5	0307 124 310
20	Union bolt	230	NG 6, M10 x 1	0307 003 300
6	Union bolt	230	NG 8, M16 x 1.5	0307 000 030
6	Union bolt	230	NG 12, M22 x 1.5	0307 000 160
12	Union bolt	232	NG 8, M16 x 1.5	0307 124 700
12	Union bolt	232	NG 12, M22 x 1.5	0307 124 695
10	Straight connector	230	NG 6, Pipe connector 6 x 1	0307 003 430
15	Straight connecting plug	232	NG 8, Pipe connector 8 x 1	0307 124 360
5	Straight connecting plug	232	NG 12, Pipe connector 8 x 1	0307 124 395
9	Straight connecting plug	232	NG 12, Pipe connector 12 x 1,5	0307 124 400
10	Sealing plug	232	NG 8	0307 124 755
3	Sealing plug	232	NG 12	0307 124 760
10	Straight quick-fit coupling	230	Pipe diameter 6	0307 003 060
4	Angled plug	230	NG 6, 90°, Pipe connector 6 x 1	0307 000 055
10	Angled plug	232	NG 8, 90°, Pipe connector 8 x 1	0307 124 945
6	Angled plug	232	NG 12, 90°, Pipe connector 8 x 1	0307 124 970
6	Angled plug	232	NG 12, 90°, Pipe connector 12 x 1,5	0307 124 975
2	Tee plug connector	232	NG 12, Pipe connector 12 x 1,5/8 x 1	0307 124 660
1	Tee plug connector	232	NG 12, Pipe connector 12 x 1,5/12 x 1,5	0307 124 680
30	O-ring, Mud ring	232	NG 8, 7.5 x 2	0307 239 961
30	O-ring, Mud ring	232	NG 12, 12 x 2	0307 449 961
30	O-ring, Sealing ring	232	NG 8, 7 x 1.5	5239 390 055
30	O-ring, Sealing ring	232	NG 12, 12 x 1.6	0307 089 971
30	O-ring, Mud ring	230	NG 6, 5.5 x 1.5	0307 159 972
30	O-ring, Sealing ring	230	NG 6, 3.5 x 1.5	0307 149 971
20	Spring element	230	NG 6, 6.5	0307 062 179
6	Spring element	230	NG 8, 9.7	0307 000 040
6	Spring element	230	NG 12, 15.2	0307 000 170
20	Clamp	230	NG 6, 7.4	0307 016 900
6	Clamp	230	NG 8, 11.6	0307 000 020
6	Clamp for 6 tube	230	NG 12, 17.6	0307 000 150



(Illustration similar)

H1 main headlamp

Vehicle type Axor II/III
Voltage 24 V

Application range

for vehicles without headlight range adjustment (electric), without setting motor

Installation side	Order number
left	9501 658 210
right	9501 658 211

Service parts

Side light/indicator lens

Version with seal and clips

Installation side	Order number
left	0247 753 001
right	0247 754 001



H4/H1 main headlamp

Vehicle type Axor I
Version with high beam, fog and side light
Voltage 24 V

Application range

for vehicles without headlight levelling

Installation side	Order number
left	3600 100 045
right	3600 100 050

Service parts

Description	Order number
Side light/indicator lens, left	3600 100 015
Side light/indicator lens, right	3600 100 025
Reflector, left	3600 321 871
Reflector, right	3600 321 872
H1 halogen headlamp bulb	8900 040 100
H4 halogen headlamp bulb	8900 006 000
Bulb, Drop-shaped, 24 V, 21 W	8900 003 000
Bulb, Drop-shaped, BA 15 s, 24 V, HD version	8900 010 000
Glass-base bulb, 24 V, 5 W	8900 040 130

Headlamp adjustment equipment available from EUROPART!



H7/H1 main headlamp

Vehicle type	Axor II/III
Version	with high beam and side light
Voltage	24 V

Application range

for vehicles without headlamp levelling and without headlamp cleaning system

Installation side	Order number
left	5532 440 183
right	5532 440 182

Service parts

Side light/indicator lens

Version	with seal and clips
---------	---------------------

Installation side	Order number
left	0247 753 001
right	0247 754 001



H3 fog light

Vehicle type	Axor I
Width	195 mm
Height	103 mm
Depth	98 mm
Voltage	24 V

Scope of supply

with bulbs

Installation side	Order number
left	9648 207 856
right	9648 207 956

Accessories

Description	Order number
H3 halogen headlamp bulb, 24 V, 70 W	8900 009 000
Mounting frame, left	9648 261 759
Mounting frame, right	9648 261 859



H3 spotlight

Vehicle type	Axor II/III
Width	195 mm
Height	103 mm
Depth	98 mm
Voltage	24 V

Installation side	Order number
left	9648 207 656
right	9648 207 756

Accessories

Description	Order number
H3 halogen headlamp bulb, 24 V, 70 W	8900 009 000
Mounting frame, left	9648 261 759
Mounting frame, right	9648 261 859



Indicator light

Vehicle type	Axor II/III
Installation location	front
Socket	BAU 15 s
Voltage	24 V
Connection	bayonet
Colour	white

Scope of supply
with bulb holder

Installation side	Order number
left	9260 001 062
right	0247 015 041

Accessories

Bulb

Voltage	24 V
Power	21 W
Colour	yellow

Order number
9560 013 496



Auxiliary flasher light

Vehicle type	Axor II/III
Version	with side marker light
Installation location	front
Installation side	left/right
Depth	80 mm
External diameter	80 mm
Bulb type	P21/5W
Voltage	24 V
Colour	yellow

Scope of supply
Bulb and cable

Order number
9468 201 021

Accessories

Description	Order number
Bulb for indicator, brake, rear fog, reversing lights, 24 V, 21 W	8900 003 000
Bulb for brake/tail light, 24 V, 21/5 W	8900 013 000
Bulb socket	9460 463 655

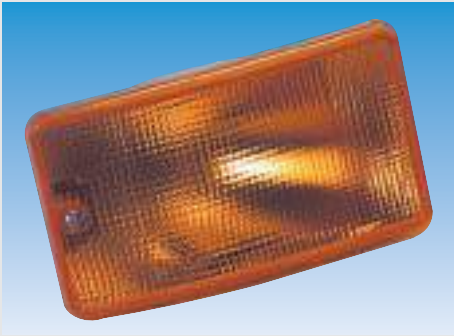

Indicator light

Vehicle type	Axor I
Installation location	front
Installation side	left/right
Width	102 mm
Height	75 mm
Depth	68 mm
Voltage	24 V
Colour	yellow

Scope of supply
with bulb

Order number
9460 009 937

Accessories

Description	Order number
Bulb for indicator, brake, rear fog, reversing lights, 24 V, 21 W	8900 003 000
Bulb for brake/tail light, 24 V, 21/5 W	8900 013 000



Indicator light

Vehicle type	Axor I/II/III
Installation location	front
Installation side	left, right
Bulb type	P21/5W
Colour	yellow

Scope of supply
without bulb carriers

Order number
9503 700 104

Accessories

Bulb

Voltage	24 V
Power	21/5 W

Order number
8900 013 000

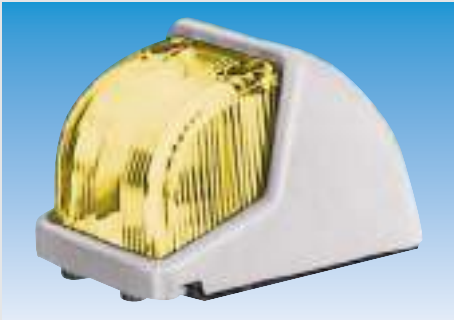

Position light

Parklight

Vehicle type	Axor I/II/III
Version	with rubber underlay
Installation location	front, top
Installation side	left, right
Width	53.5 mm
Height	48 mm
Depth	68,2 mm
Socket	BA15s
Bulb type	R10W
Voltage	12/24 V
Colour	yellow

Order number
0006 679 017

Accessories

Bulb

Voltage	24 V
Power	10 W
Bulb type	R10W

Order number
8900 002 000



Position light

Vehicle type	Axor I/II/III
Installation location	at the side
Voltage	24 V

Installation side	Colour	Order number
left, top	white	1325 463 496
right, top	white	1325 463 497
left, top	yellow	9501 243 334
right, top	yellow	9501 243 336

Accessories

Bulb

Voltage	24 V
Power	10 W

Order number
8900 002 000

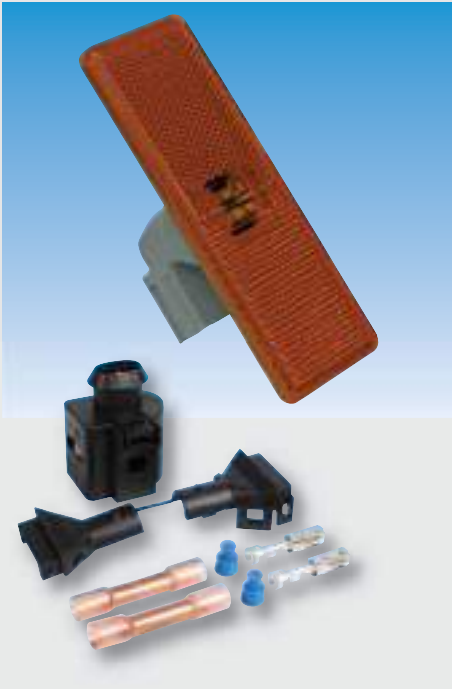

LED side marker light

Vehicle type	Axor I/II/III
Installation side	left, right
Voltage	24 V
Colour	yellow

Version	Order number
with connector, 2-pin	8000 463 509
with 0.5 m cable, 90° cable connection, reverse light	9505 940 112

Accessories

Description	Order number
Connector set	9465 401 581



PROPLAST
FARBSTREIFENLEUCHTUNG

Rear light

Vehicle type	Axor I/II/III
Width	139 mm
Height	525 mm
Depth	84,5 mm
Socket	BA 15 s
Voltage	24 V
Connection	Round connector
Fastening	horizontal

Installation side	Version	Order number
left	with indicator, brake, tail, rear fog, reversing, number plate, clearance and side marker light, reflector	8840 220 203
right	with indicator, stop, tail, rear fog, reversing, clearance and side marker light, reflector	8840 220 202

Service parts

Description	Order number
Lens, left, with rear fog, indicator, stop, reversing and taillight	1040 000 009
Lens, right, with indicator, stop, reversing, taillight	1040 000 010
Bulb for indicator, brake, rear fog, reversing lights, 24 V, 21 W	8900 003 000
Bulb for tail, licence plate, position and interior lights, 24 V, 10 W	8900 002 000



Indicator switch

Vehicle type	Axor I/II/III
Installation side	left
Voltage	24 V
Cable length	560 mm

Order number
9465 453 125

Pressure switch

Vehicle type	Axor I/II/III
Voltage	24 V

Installation location	Switching pressure bar	Order number
Brake circuit III/IV	5,5	9465 455 414
Rear axle	6,5	6170 463 109

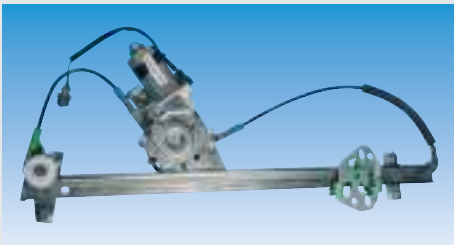

Window winder

electric, with motor

Vehicle type	Axor I/II/III
--------------	---------------

Installation side	Order number
left	5828 722 346
right	1325 063 373



Starter Motor

Vehicle type	Axor I/II
Voltage	24 V
Power	6.2 kW
Number of teeth	11
Flange	3-hole flange
Flange diameter	92 mm
Fastening	75°

Order number
7063 000 217



Starter Motor

Vehicle type	Axor I/II
Voltage	24 V
Power	6.2 kW
Number of teeth	11
Flange	3-hole flange
Flange diameter	92 mm
Fastening	81°

Order number
7063 002 371



Starter Motor

Vehicle type	Axor I/II
Version	with cover
Voltage	24 V
Power	4 kW
Number of teeth	9
Flange	3-hole
Flange diameter	89 mm

Order number
7063 000 215



Starter Motor

with reduction gear

Vehicle type	Axor I/II/III
Voltage	24 V
Power	7.5 kW
Number of teeth	12
Flange	3-hole
Flange diameter	92 mm

Order number
9461 511 501



Alternator

Vehicle type	Axor I/II/III
Version	with belt pulley
Pulley diameter	72 mm
Voltage	24 V
Charging current	80 A
Flange	3-hole flange

Order number
7063 001 031



Alternator

Vehicle type	Axor I/II
Version	with belt pulley
Pulley diameter	77 mm
Voltage	28 V
Charging current	80 A
Flange	3-hole flange

Order number
7063 001 032

**EURO
PART**
Alternator

Vehicle type	Axor I/II/III
Version	without belt pulley
Voltage	28 V
Charging current	80 A
Flange	3-hole flange

Order number
7063 000 003

Alternator

Vehicle type	Axor I/II/III
Version	right stop, without pulley
Voltage	24 V
Charging current	140 A
Flange	2-hole

Order number
1902 533 300

Alternator

Vehicle type	Axor I/II/III
Version	without pulley
Voltage	24 V
Charging current	110 A
Flange	3-hole

Order number
5240 860 807

THE POWER OF EXCELLENCE



Ihr OE-Ausrüster

Starter und Generatoren für Busse und LKW



Wir rüsten u. a. aus: MAN, CUMMINS, IRIS BUS, IVECO, NEOPLAN, RVI, SCANIA, VAN HOOL, VOLVO

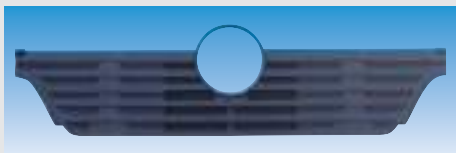

Front grille

Vehicle type Axor I

	Order number
(on request)	9468 880 123

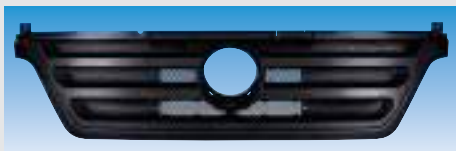

Front grille

Vehicle type Axor II

	Order number
(on request)	9468 800 085



Bumper

Vehicle type Axor I

Colour grey

Installation side		Order number
left	(on request)	9468 802 070
top		9190 800 303
right	(on request)	9468 802 170

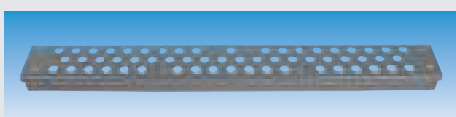

Step-up

for bumpers

Vehicle type Axor I/II

Installation side		Order number
centre, bottom section		9190 801 670
centre, top section	(on request)	9468 800 025

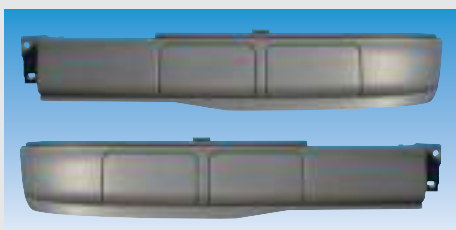

Rear apron

Vehicle type Axor I

Colour grey

Installation side		Order number
left		9468 850 125
right		9468 850 225

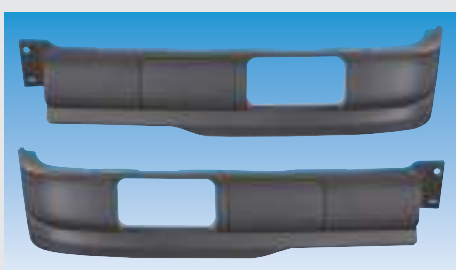

Rear apron

Vehicle type Axor I

Version with cutout for fog light

Colour grey

Installation side		Order number
left	(on request)	9460 885 052
right	(on request)	9460 885 062

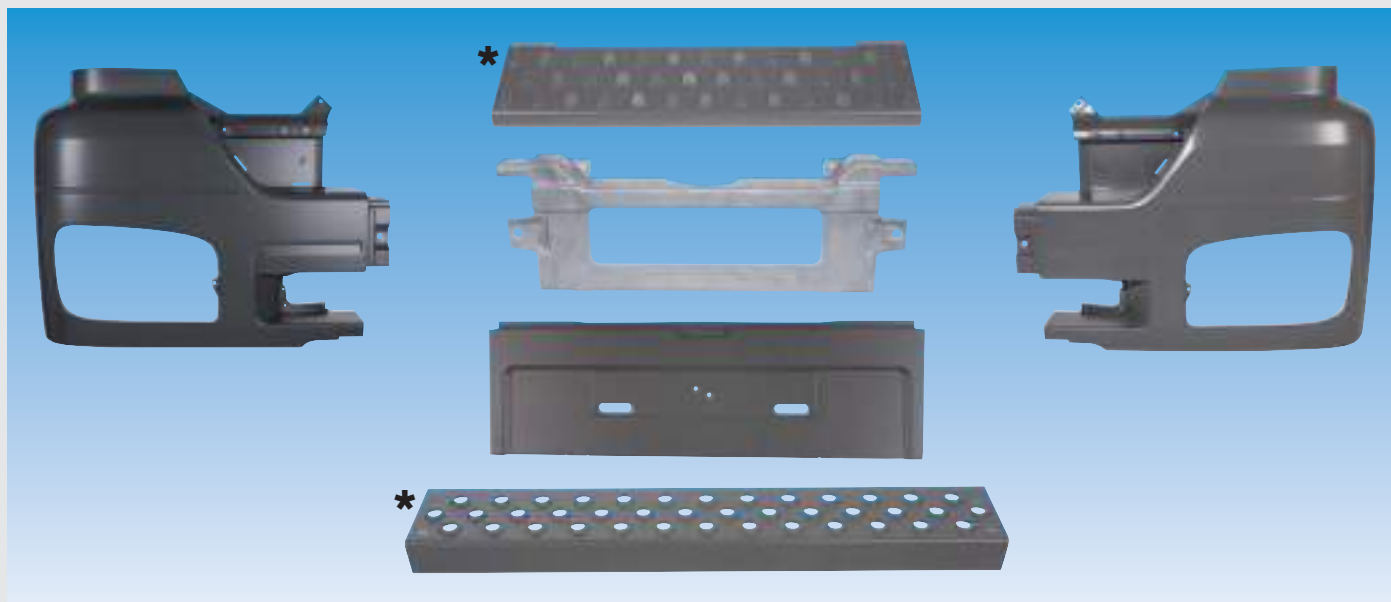

Bumper

Vehicle type Axor II/III
Colour grey

Installation side	Order number
left	9190 800 205
centre, top	9190 800 303
right	9190 800 204

Accessories

Description	Installation side		Order number
Flap for coupling bolt	centre, top	* (on request)	9460 001 270
Flap	centre		9460 066 307
Step-up	centre, bottom	* (on request)	9460 001 240

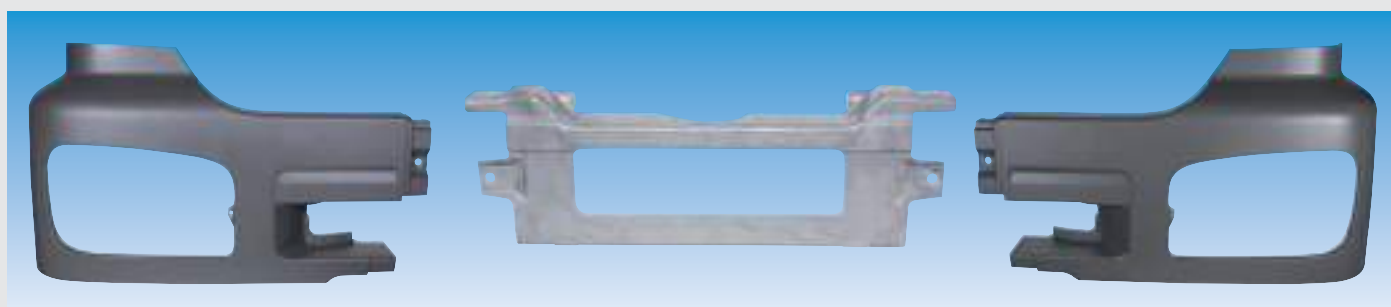

Bumper

Vehicle type Axor II/III
Colour grey

Installation side	Order number
left	9190 880 027
centre, top	9190 800 303
right	9190 880 028

Accessories

Foot step
Colour grey

Installation side	Order number
centre, top	9460 066 305

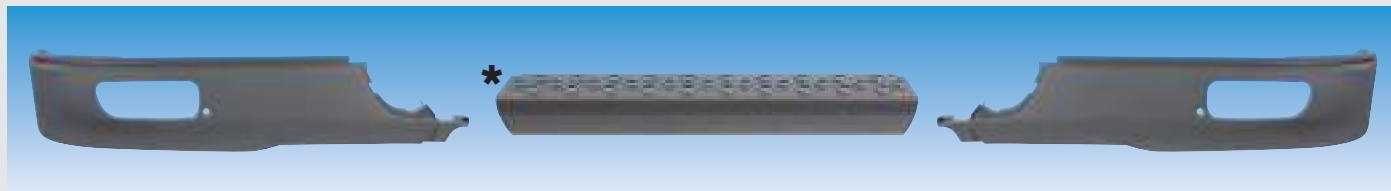

Rear apron

Vehicle type Axor II/III
 Colour grey

Installation side	Order number
left	9464 885 052
centre	* (on request) 9460 001 230
right	9464 885 062

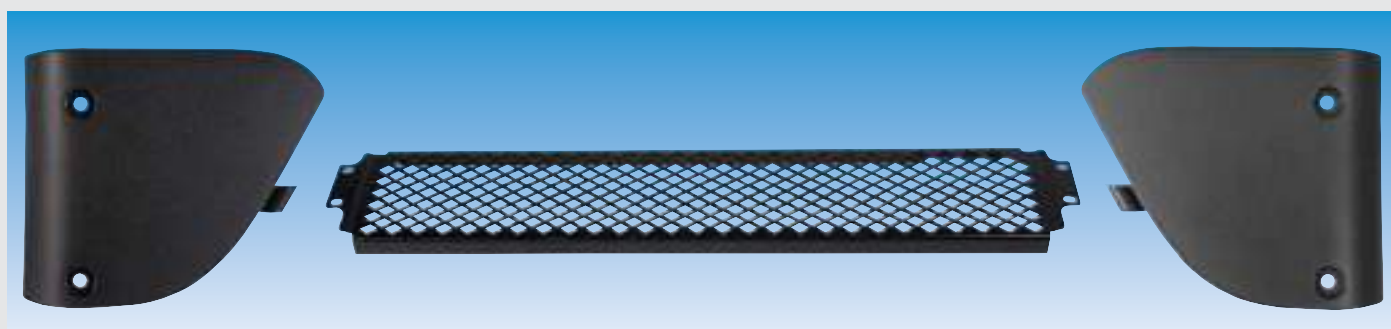

Cover

for front spoiler

Vehicle type Axor II/III
 Colour grey

Installation side	Order number
left	(on request) 9460 001 380
centre	(on request) 9460 001 370
right	(on request) 9460 001 390



Entry

Vehicle type Axor I
 Version 2-step, road version
 Height 825 mm
 Colour grey

Installation side	Order number
left	(on request) 9190 661 001
right	(on request) 9190 661 101

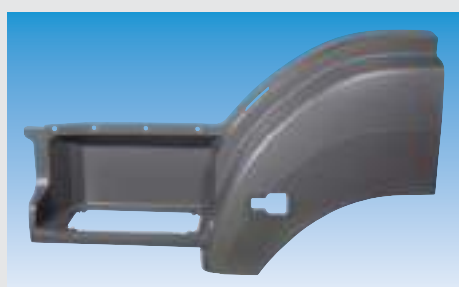

Entry

with wing

Vehicle type Axor I/II/III
 Installation location top
 Colour grey

Installation side	Order number
left	9466 661 301
right	9466 661 401



Entry

Vehicle type	Axor II/III
Version	2-stage
Colour	grey

Installation side	Order number
left	9196 660 101
right	9196 660 201

Accessories

Description	Installation side	Order number
Step-up	left/right, top	9466 660 128
Step-up	left/right, bottom	9466 660 428
Maintenance flap	left/right	(on request) 9466 660 005

Corner plate

for A-pillar

Vehicle type	Axor I
--------------	--------

Installation side	Order number
left	9460 840 123
right	9460 840 223



(Illustration similar)

Air deflector

for A-pillar

Vehicle type	Axor I
--------------	--------

Installation side	Order number
left	(on request) 9460 880 034
right	(on request) 9460 880 044



Corner plate

for A-pillar

Vehicle type	Axor II/III
--------------	-------------

Installation side	Order number
left	9190 840 022
right	9190 840 122

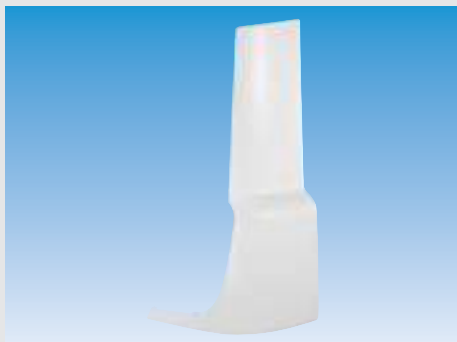

Cover

for corner plate, A-pillar

Vehicle type Axor II/III

Installation side	Order number
left	9190 840 222
right	9190 840 322

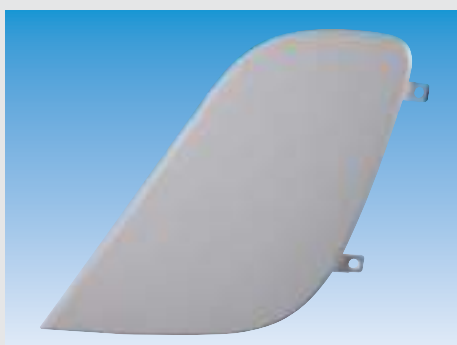

Cover

Vehicle type Axor II/III

Installation side	Order number
left	9198 840 422
right	9198 840 522

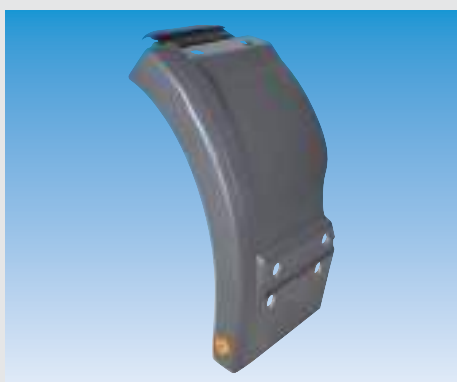

Wing

Vehicle type Axor II/III
 Installation location front axle, rear
 Colour grey

Installation side		Order number
left	(on request)	9468 803 206
right	(on request)	9468 803 306

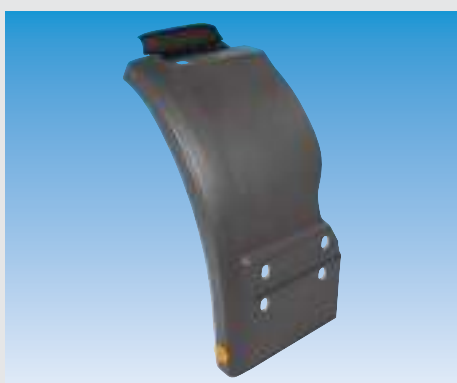

Wing

Vehicle type Axor II/III
 Installation location front axle, rear
 Colour grey

Scope of supply

with cover

Installation side		Order number
left	(on request)	9468 803 006
right	(on request)	9468 801 006



Wing

Vehicle type	Axor I/II/III
Installation location	front axle, rear
Colour	grey

Installation side		Order number
left	(on request)	9468 812 801
right	(on request)	9468 812 901

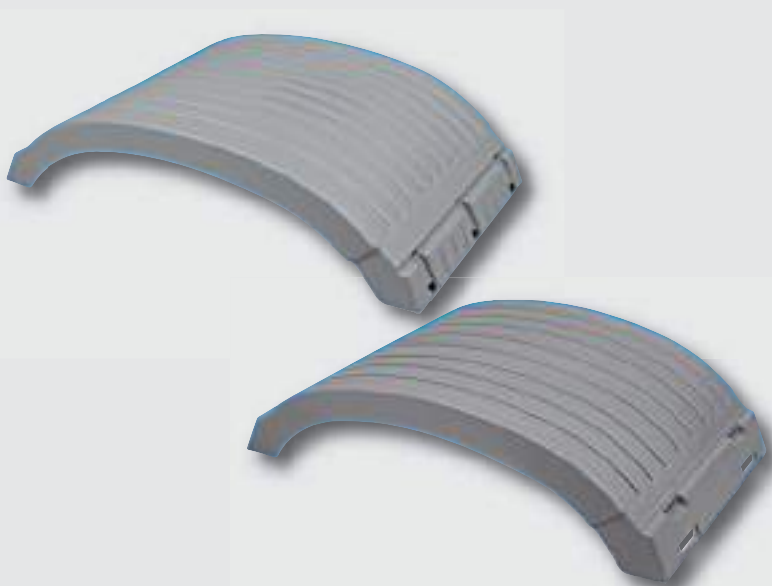

Wing

Vehicle type	Axor I/II/III
Installation location	rear axle

Installation side	Version	Order number
left	front section	9195 200 119
right	front section	9195 200 219
left/right	centre section, for 6 tension ribbons	9190 220 004
left/right	centre section, for 4 tension ribbons	9090 200 007
left	rear section	9190 200 320
right	rear section	9190 201 620

Accessories

Description	Order number
Tightening strap rubber	9465 220 167



Windscreen

Vehicle type	Axor I/II	
Colour		Order number
clear		9115 900 002
green tinted		9115 730 941

Accessories
Sealing frame

Vehicle type		Order number
Axor II		9115 721 937
Axor I		9115 740 322



Sunshade

for driver's cab

Vehicle type	Axor I	
Driver cab	with low roof	
Version	without windscreen cut-out, with bracket	
Material	acrylic glass	
Colour	antracite	
		Order number
		9195 120 000



Sunshade

for driver's cab

Vehicle type	Axor II	
Driver cab	with low roof	
Version	with windscreen cut-out, with bracket	
Material	acrylic glass	
Colour	antracite	
		Order number
		9190 043 040



Sunshade

for driver's cab

Vehicle type	Axor II	
Driver cab	with low roof	
Version	without windscreen cut-out, with bracket	
Material	acrylic glass	
Colour	antracite	
		Order number
		9190 430 420

The illustrations show examples of application on the Atego.



Side window wind deflector

made of smoke-coloured plexiglass, no draught, less window soiling

Vehicle type	Axor I/II	
Version	screw attachment	
Installation side	left/right	
		Order number
		9199 046 017



Wiper blade

with 3 adapters

Vehicle type Axor I/II
Length 650 mm

Order number
7257 002 100



Washer fluid pump

Vehicle type Axor I/II
Version Dual pump with 3 connections
Voltage 24 V

Order number
6170 461 883



Wiper motor

Vehicle type Axor I/II
Installation location front
Voltage 24 V

Order number
3870 404 398



Mirror head

for main mirror

Vehicle type Axor I
Installation side left/right
Model year -2004
Length 380 mm
Width 170 mm
Depth 68 mm

Scope of supply
without glass unit

Version	Order number
heated, manual adjustment	9113 752 147
heated, electric adjustment	9113 752 167

Accessories

Description	Order number
Glass unit, Curve radius 1800 mm	9113 752 470
Retaining element with cover	2110 000 285



Main mirror

Vehicle type	Axor II/III
Model year	2004-
Width	219 mm
Depth	124 mm

Scope of supply
complete

mirror complies with ordinance 2003/97/EU or 2007/38/EU

Version	Installation side	Order number
heated, manual adjustment	left	9115 751 147
heated, manual adjustment	right	9115 752 147
heated, electric adjustment	left	0915 751 167
heated, electric adjustment	right	9115 752 167

Service parts

Description	Order number
Glass unit, Curve radius 1200 mm, Model year -06/2010	9115 750 840
Glass unit, Curve radius 1200 mm, Model year 07/2010-	9111 011 099
Retaining element with cover	9115 750 100

Accessories

Description	Order number
Adapter cable, Model year -06/2010	9110 220 099

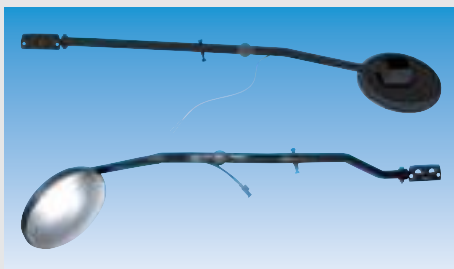

Front mirror

Version	heated, manual adjustment
Installation side	right
Diameter	250 mm

Scope of supply
with retaining element

mirror complies with ordinance 2003/97/EU or 2007/38/EU

Vehicle type	Length mm	Width mm	Order number
Axor I	1261	303	9113 962 210
Axor II/III	1145	265	9113 964 210

Service parts

Description	Order number
Glass unit heated, Curve radius 300 mm	9113 961 174
Mirror head heated, manual adjustment	9113 960 148

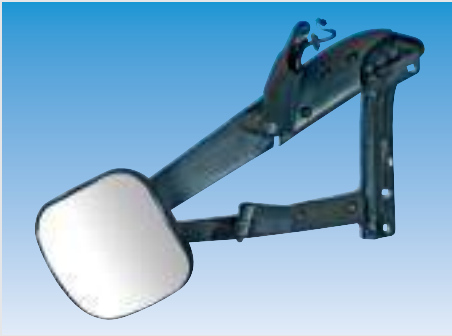

Front mirror

Vehicle type Axor II/III
 Installation side right

Version	Order number
for high roof	9468 107 316
for low roof	9468 107 516

Service parts

Description	Order number
Mirror glass	9468 112 333
Mirror housing	9468 101 979



Wide angle mirror

Vehicle type Axor I/II
 Version heated, manual adjustment
 Model year -2004
 Installation side left/right
 Width 200 mm

Scope of supply
 complete

mirror complies with ordinance 2003/97/EU or 2007/38/EU

Order number
9113 773 147

Service parts

Description	Order number
Glass unit, Curve radius 300 mm	9113 771 174
Retaining element with cover	2110 000 285



Wide angle mirror

Vehicle type Axor II/III
 Version heated, manual adjustment
 Installation side left/right
 Model year 2004-
 Width 199 mm
 Depth 116 mm
 Curve radius 300 mm

Scope of supply
 complete

mirror complies with ordinance 2003/97/EU or 2007/38/EU

Order number
9115 770 147

Service parts

Description	Order number
Glass unit, Curve radius 300 mm, Model year -06/2010	9115 770 870
Glass unit, Curve radius 300 mm, Model year 07/2010-	9110 311 099

Accessories

Description	Order number
Adapter cable, Model year -06/2010	9110 220 099
Retaining element with cover	9115 750 100



Ramp mirror

Vehicle type	Axor II/III
Version	unheated, manual adjustment
Installation side	right/left
Model year	2004-
Width	255 mm
Depth	98 mm

Scope of supply

complete

Order number

9114 001 099

Service parts

Description

Glass unit, Curve radius 300 mm

Order number

9115 791 470



Mounting bracket, outside mirror

Vehicle type	Axor I
Colour	black
Model year	-2004
Length	639 mm
Width	325 mm
Diameter	28 mm

Installation side

left

Order number

9113 752 100

right

9113 752 200

Accessories

Cover

Installation side

left

Order number

9111 037 065

right

9111 037 066

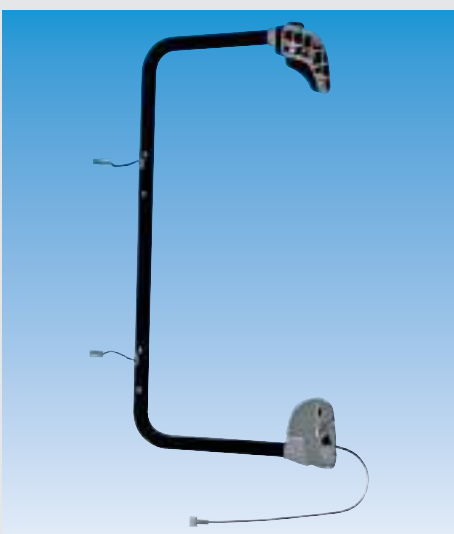

Vehicle type	Axor II
Colour	black
Model year	2004-06/2010
Length	795 mm
Width	376 mm
Diameter	28 mm

Installation side

left

Order number

9115 752 100

right

9111 037 046

Vehicle type	Axor II/III
Colour	black
Model year	07/2010-
Length	795 mm
Width	322 mm
Diameter	28 mm

Installation side

left

Order number

9110 012 099

right

9110 005 099



Air-conditioning compressor

Vehicle type	Axor I/II/III
Type	10PA15C
Version	with poly-V-belt pulley
Pulley diameter	129 mm
Number of ribs	9
Voltage	24 V

Order number
9100 852 050

Air-conditioning compressor

Vehicle type	Axor I/II/III
Type	10PA15C
Version	with clutch
Pulley diameter	130 mm
Number of ribs	8
Voltage	24 V

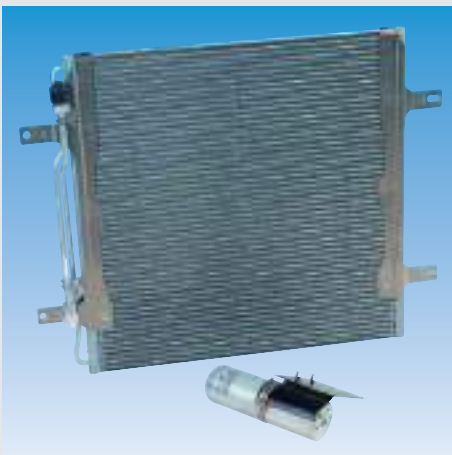
Order number
9462 300 111

Condenser

for air-conditioning systems

Vehicle type	Axor I/II/III
Version	without dryer
Depth	22 mm

Length mm	Width mm	Order number
600	457	0351 317 641
610	470	9100 134 130



Blower

for heating

Vehicle type	Axor I/II/III
Voltage	24 V

Order number
0009 157 461

Accessories

Description	Order number
Electrical ballast, 24 V	9261 029 381



Filter dryer

for air-conditioning system

Vehicle type	Axor I/II/III
Version	with bracket
Diameter	53 mm
Length	290 mm

Order number

0351 197 441



Expansion valve

for air-conditioning system

Vehicle type	Axor I/II/III
--------------	---------------

Order number

0351 239 381

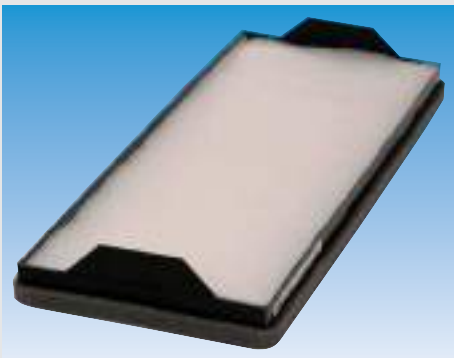

Cabin filter/pollen filter

Vehicle type	Axor I/II/III
Length	451 mm
Width	193 mm
Height	56 mm

Order number

9750 103 232

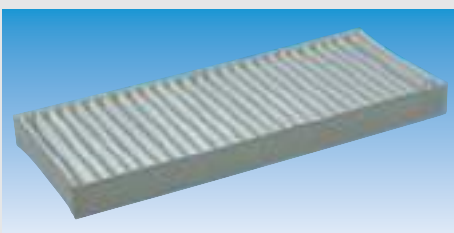

Cabin filter

Vehicle type	Axor I/II/III
Length	454 mm
Width	190 mm
Height	56 mm

Order number

9020 000 526



Roof-mounted air-conditioning system for truck

CoolAir CA 850S, for stationary operation

extraordinary cooling performance and additional air dehumidification, pleasant climate, independently of the external climatic conditions, can also be operated when the vehicle is moving, simple installation

Refrigerant R134a

Cooling capacity 1000 W (compressor capacity), 850 W (following ISO 5151)

Dimensions of roof unit (W x H x D) 830 x 159 x 635 mm

Input voltage 24 V DC

Current consumption 12-18 A

Colour white

Weight 22 kg

Scope of supply

Remote control, battery cable, operating instructions

	Order number
	1880 000 027

Accessories

Description	Order number
Assembly set	1880 000 033
Protective hood CoolAir	1880 000 040



Truck driver's seat

6860/875 NTS

Full height adjustment with memory function, built-in 3-point safety belt system with belt pretensioner, seat back adjustment, shoulder adjustment, lean and horizontal settings, adjustable vertical movement damper, adjustable cushion depth, integrated pneumatic system (IPS) for adjustment of backrest to individual body contour (lumbar support and adjustable side support, rapid lowering, horizontally sprung, grey/anthracite seat covering with fine silver coloured stripes

Vehicle type Axor I/II/III

Version can be operated from the left, with seat heating and console

Suspension pneumatic

Track width 230 mm

Arm rests must be ordered separately.

	Order number
	9368 894 501

Accessories

Arm rest

Installation side	Order number
left	9369 296 511
right	9369 296 521



Truck driver's seat

Kingman High Performance Standard

spring deflection 70 mm, height adjustment 100 mm, built-in headrest, length adjustment, longitudinal horizontal suspension, pneumatic lumbar support, backrest setting, built-in 3-point restraint system with adjustable belt, rejuvenated back contour, quick lowering, side contour adjustment, seat angle adjustment, adjustable shock absorber

Vehicle type	Axor I/II
Width	545 mm
Depth	630 mm
Track width	230 mm
Suspension	pneumatic

For vehicles without an airbag!
Illustration shows special equipment!
Arm rests must be ordered separately.

Order number
9361 503 100



Accessories

Arm rest

Installation side	Order number
left	9361 029 136
right	9361 029 137



Truck driver's seat

Kingman High Performance Comfort

spring deflection 70 mm, height adjustment 100 mm, integrated head rest, length adjustment, longitudinal horizontal suspension, pneumatic lumbar support, neck pillow with exchangeable cover, backrest setting, integrated 3-point restraint system with adjustable belt tongue, tapered back contour, quick lowering, side contour adjustment, 2-level seat heating, seat cushion depth setting, seat angle setting, adjustable shock absorbers

Vehicle type	Axor I/II/III
Width	545 mm
Depth	630 mm
Track width	230 mm
Suspension	pneumatic

Scope of supply
 without armrests
For vehicles without an airbag!
Illustration shows special equipment!
Arm rests must be ordered separately.

Order number
9360 150 311



Accessories

Arm rest

Installation side	Order number
left	9361 029 136
right	9361 029 137



Floor mat set

Vehicle type	Axor I/II
Version	2-piece, front left/right
Material	Rubber
Colour	black

Order number
9190 110 160



Pedal pad

Vehicle type	Axor I/II/III
Thickness	13 mm

Version	Length mm	Width mm	Order number
for clutch pedal	70	64/49	9080 001 104
for brake pedal	69.5	63/47	9080 001 105



Filing table

with anti-slip mat

Vehicle type	Axor II
Installation side	centre

Colour	Order number
black	1002 010 253
Root wood finish	1002 010 254



Shock absorber

Super Touring

Vehicle type	Axor I/II/III
Version	Gas pressure, twin-tube
Fastening	eye/eye
Installation location	Front axle

Order number
9202 902 680



Shock absorber

Super Touring

Vehicle type	Axor I/II/III
Version	Gas pressure, twin-tube
Fastening	Eye/eye
Installation location	front

Order number
9750 001 467



Shock absorber

Super Touring

Vehicle type	Axor I/II/III
Version	gas pressure, twin-tube system
Fastening	eye/eye
Installation location	rear axle

Order number
9202 902 510



Shock absorber

Super Touring

Vehicle type	Axor I/II/III
Version	Gas pressure, single-tube
Fastening	Eye/eye
Installation location	Rear axle

Order number
9750 290 995



1

2 (Illustration similar)

Driver cab tilting pump

Vehicle type Axor I/II/III

Illustration	Order number	Comparative number
1	9465 533 601	Mercedes-Benz 001 553 36 01
1	9460 155 337	Mercedes-Benz 001 553 37 01
2	9465 530 001	Mercedes-Benz 001 553 00 01

Many years, many kilometres...

We have the matching part for every age class!



www.europart.net

**EURO
PART** 
...more than parts

Atego

3



Engine	216-227
Drive	228-233
Suspension	234-239
Axle and steering.....	240-251
Braking system	252-259
Pneumatic system	260-275
Lighting and electrics.....	276-291
Bodywork	292-297
Driver's cab.....	298-309
Truck styling.....	310-311

Engine bearing

Vehicle type Atego I/II/III

Installation location	Order number	Comparative number
front	9461 400 317	Mercedes-Benz 970 240 03 17
rear	9461 400 318	Mercedes-Benz 970 240 03 18

3

Atego



Gasket full set

Vehicle type Atego I/II/III

suitable for cylinder bore 102 mm

Scope of supply

without oil pan seal and valve cover seal

Motor type	Order number
e.g. OM 904	8002 043 461
e.g. OM 906	8002 000 171

Crankcase seal set

Vehicle type Atego I/II/III (t.ex. OM 904, OM 906, ...)

Scope of supply

without oil pan seal

Order number
8002 534 470

Cylinder head gasket set

Vehicle type Atego I/II/III

suitable for cylinder bore 102 mm

Scope of supply

without valve stem seal

Motor type	Version	Order number
e.g. OM 904	for plastic valve cover	8002 000 708
e.g. OM 904	for aluminium valve cover	8002 048 822
e.g. OM 906	for plastic valve cover	8002 049 024
e.g. OM 906	for aluminium valve cover	8002 534 693

Cylinder head gasket set

Vehicle type Atego II

Scope of supply

without valve stem seal

Motor type	Order number
e.g. OM 924	8002 045 099
e.g. OM 926	8002 045 100

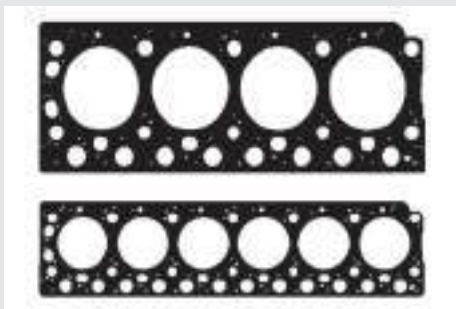

Cylinder head gasket

Vehicle type Atego I/II/III
 Material metal elastomer
 suitable for cylinder bore 102 mm

Motor type	Order number
e.g. OM 904	8002 048 782
e.g. OM 906	8002 532 579



Cylinder head screw

Vehicle type Atego I/II/III (t.ex. OM 904, OM 906, OM 924, OM 926, ...)
 Material steel
 Thread M16 x 2
 Length 149 mm

for OM 906 and OM 926 14 pieces are required, for OM 904 and OM 924 10 pieces are required

Order number
8002 046 885



Oil pan gasket

Vehicle type Atego I/II/III

Motor type	Version	Order number
e.g. OM 904, OM 924	for aluminium oil pan	8029 319 130
e.g. OM 904, OM 924	for plastic oil pan	8002 979 903
e.g. OM 906, OM 926	for aluminium oil pan	8002 051 734
e.g. OM 906, OM 926	for plastic oil pan	8002 051 736

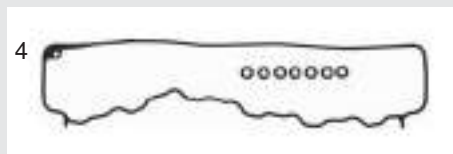
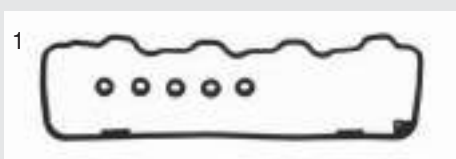

Valve cover gasket set

Vehicle type Atego I/II/III

Illustration	Motor type	Version	Order number
1	e.g. OM 904, OM 924	for plastic valve cover	8002 000 055
2	e.g. OM 904	for aluminium valve cover	8002 000 005
3	e.g. OM 906, OM 926	for plastic valve cover	8002 000 056
4	e.g. OM 906	for aluminium valve cover	8002 000 058



Oil pressure sensor

Vehicle type	Atego I/II/III
Motor type	e.g. OM 904 LA, OM 906 LA
Thread	M16 x 1.5
Connection	metric

Version	Order number
without warning contact	9465 420 517
with warning contact	(on request) 9461 534 928



Fuel pump

Version	with fuel pre-filter
---------	----------------------

Order number
9020 100 350

Service parts

Description	Order number
Fuel filter housing	9460 000 400

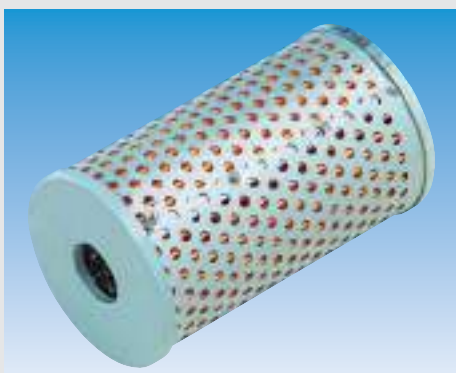

Hydraulic filter

Vehicle type	Atego I/II/III
External diameter	60 mm
Inner diameter	18/18 mm
Height	100.5 mm

Order number
9025 503 090



Fuel filter

Vehicle type	Atego I/II/III
External diameter	91.8 mm
Inner diameter	44.9 mm
Height	102.7 mm

Order number
9020 010 461

(Illustration similar)



Air filter

Vehicle type	Dimensions mm	Order number
Atego I/II/III	∅ 281.5 x Height 352.8	9020 025 653
Atego I/II	∅ 420 x Height 317	9024 217 290
Atego I	Length 626 x Width 564 x Height 78	9020 641 510

(Illustration similar)



Oil filter

Vehicle type Atego I/II/III

Outer ∅ mm	Inner ∅ mm	Height mm	Order number
79.5/83.2	27.9/39	148.5	3359 000 556
83	37/28	211.5	2127 001 816



Hydraulic filter

Vehicle type Atego I/II
 External diameter 83 mm
 Inner diameter 13.6 mm
 Height 116 mm

Order number
9750 103 083



Fuel filter

Vehicle type Atego I/II/III
 External diameter 50 mm
 Height 41 mm

Order number
9750 103 121

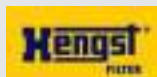

Fuel filter

Vehicle type	Atego II
External diameter	107.5 mm
Height	219 mm

Order number
9750 104 510

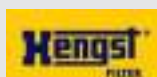

Fuel filter

Vehicle type	Atego I/II/III
External diameter	107.5 mm
Height	219 mm

Order number
3565 429 204

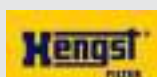

Urea filter

Vehicle type	Atego I/II/III
External diameter	43 mm
Height	85.5 mm

Order number
9750 103 044



Exhaust turbocharger

in exchange

Vehicle type	Atego I/II/III
Motor type	e.g. OM 904 LA, with 150 PS (from engine no. 067604)

Order number
1902 024 511



Exhaust turbocharger

in exchange

Vehicle type	Atego I/II/III
Motor type	e.g. OM 904 LA, with 170 PS from engine no. 066059

Order number
1902 807 024



Exhaust turbocharger

in exchange

Vehicle type Atego I
 Motor type e.g. OM 906

Order number
 1902 024 409



Charging pressure sensor

Vehicle type Atego I/II/III

Order number
 3600 002 468



Charge air cooler

Vehicle type Atego I/II/III
 Length 572 mm

Width mm	Depth mm	Order number
432	52	9100 137 360
512	64	9100 137 000



Charge air cooler

Vehicle type Atego I
 Length 596 mm
 Width 712 mm
 Depth 64 mm

Order number
 9100 137 420

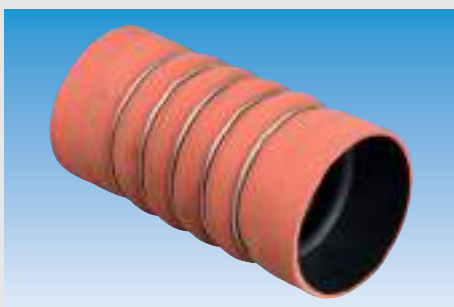

Charge air hose

Vehicle type Atego I/II/III
 Inner diameter 85 mm
 Length 195 mm

Order number
 1911 045 339

Accessories

Hose clip

Clamping range 80-100 mm

Order number
 9100 736 600

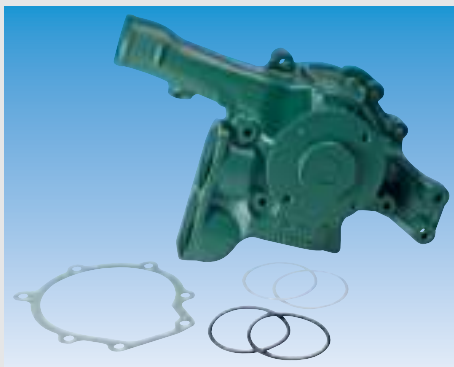

Water pump

in exchange

Vehicle type Atego I/II/III
 Type 220 1075

Scope of supply
 with gasket set

Order number
 9152 201 075



Water pump

Vehicle type Atego I/II
 Type 220 998
 Version with impeller

Scope of supply
 with seal set

Order number
 9150 000 725



Water pump

Vehicle type Atego I/II/III

Scope of supply
 with seal set

Order number
 6174 436 374

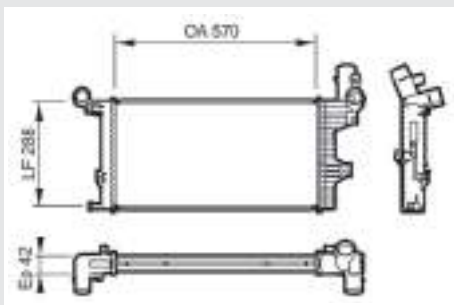

Engine radiator

Vehicle type Atego I/II/III
 Width 570 mm
 Height 288 mm
 Depth 42 mm

Order number
 1100 128 955



Engine radiator

Vehicle type Atego I
 Width 668 mm
 Height 815 mm
 Depth 42 mm

Order number
 9100 139 720



Engine radiator

Vehicle type Atego I/II/III
Height 569 mm

Width mm	Depth mm	Order number
558	42	9100 134 180
560	33	9100 135 100



Surge tank

for coolant

Vehicle type Atego I/II/III
Material Plastic

Order number
3880 134 003



Surge tank

for coolant

Vehicle type Atego I/II
Material Plastic
Capacity 9,7 l
Length 651 mm
Width 228 mm
Height 194 mm

Order number
0376 705 361



Thermostat

with seal

Vehicle type Atego I/II/III
Diameter 67 mm
Opening temperature 83 °C

Order number
9100 000 007

Coolant temperature sensor

with seal

Vehicle type Atego I/II/III
Outer thread M14 x 1.5

Motor type	Spanner size	Order number
OM 904 LA	19	6170 462 920
OM 904 LA, OM 906 LA	22	9460 462 921



Radiator fan coupling

Visco clutch without fan

Vehicle type Atego I/II/III
 Diameter 165 mm

Order number
 9100 138 039

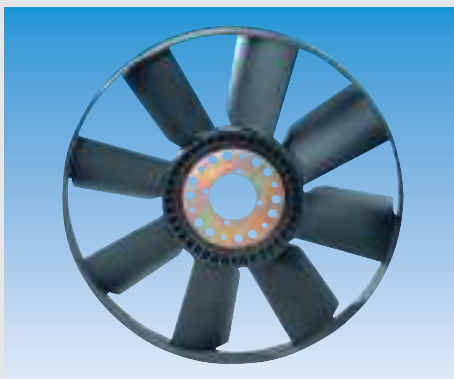

Fan wheel

Vehicle type Atego II
 Number of blades 8
 Diameter 600 mm

Order number
 0376 757 741

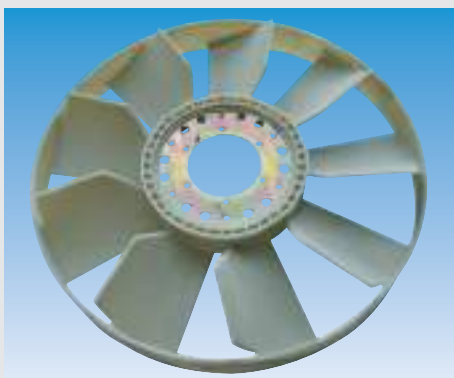

Fan wheel

Vehicle type Atego I/II/III
 Number of blades 9
 Diameter 704 mm

Order number
 0376 733 181



Rear silencer

Vehicle type Atego I/II/III
 Motor type OM 906 LA, BM 970, 972
 Special equipment 509095 03

Order number
 8730 504 660

Accessories

Description	Order number
Exhaust pipe front, Diameter 90 mm	8730 532 810
Exhaust pipe clamp, Diameter 90 mm	8730 151 900
Exhaust pipe clamp, Diameter 90.5 mm	8730 117 400



Abgassysteme & Partikelfilter für Mercedes Serien

Von Europas führendem Lieferanten von getesteten und genehmigten Systemlösungen.

INFO-HOTLINE:
Tel 0 180 225 1125

Dinex GmbH
Gewerbestr. 3-5
36148 Kalbach
Fax 0 6655 918 601
dinex@dinex.de
www.dinex.de

EURO IV ERSATZSCHALLDÄMPFER

- Direkter Ersatz des Original EURO IV Schalldämpfers.
- Edelstahl Design.
- Offene Filterlösung mit Dinex Technologie.



NACHRÜSTUNG AUF PMK 2 (EURO IV PM)

- Upgrade von EURO II-III Mercedes LKW auf PMK 2 Emissionslevel.
- Einfache Installation und Service – minimale Werkstattzeiten.
- OE-gleiches Design.

DiSiC[®] catalysed
Emissionsreduktionsraten

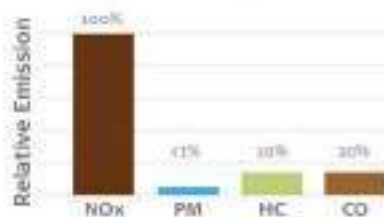

HITZEISOLATION FÜR DIE NACHRÜSTUNG

- Minimiert den Hitzeverlust um die optimale Funktion des Filters zu gewährleisten.
- Schmutz-, vibrations-, wasser-, und frostresistent.
- Alle Standardrohre sind von Dinex mit Isolation erhältlich.

OE-nummer	Dinex line
942.490.4119 / 942.490.3019	51111
942.490.2019 / 942.490.1019	51153
970.492.0001	51103
940.492.0159 / 940.490.1019/0519	53153



Dinex no. 50048
Ersetzt Schalldämpfer mit
OE Nr. 942.490.2704



Qualitätsprodukte von Dinex – Europas führender Lieferant von kompletten Abgassystemen und Emissionstechnologien für Nutzfahrzeuge



going the extra mile



Rear silencer

Vehicle type	Atego I/II/III
Motor type	OM 904 LA, BM 970, 972
Special equipment	509095 01

Order number
8730 207 155

Accessories

Description	Order number
Exhaust pipe front, Diameter 75 mm	8700 532 770
Exhaust pipe clamp, Diameter 75 mm	8730 166 100
Exhaust pipe clamp, Diameter 75.5 mm	8730 104 500



Rear silencer

Vehicle type	Atego I/III/III
Special equipment	508108/09 531391/01

Order number
8730 100 927

Accessories

Description	Order number
Front pipe centre	4260 054 203
Exhaust pipe clamp, Diameter 130.5 mm	8730 156 100



Rear silencer

Vehicle type	Atego I
Motor type	OM 906 LA

Order number
8730 207 109

Accessories

Description	Order number
Exhaust pipe front, Diameter 89 mm	8730 207 101
Exhaust pipe clamp, Diameter 90 mm	8730 151 900



Fuel tank

steel

Vehicle type	Atego I/II/III
Form	rectangular

(Illustration similar)

Volume l	Dimensions mm	Order number
300	640 x 560 x 950	9469 410 201
400	640 x 560 x 1250	9469 410 401

Accessories

Description	Order number
1 x Fuel cap, lockable, vented	9668 080 110
2 x Console	8730 122 493
4 x Console rubber	9660 022 455
2 x Tightening strap	9660 224 940
2 x Tightening strap rubber	9660 000 703
1 x Tank sensor	9660 022 481
1 x Connection set	8730 102 488
1 x Blind cover	9660 001 906
1 x Fuel Anti-syphon	9668 010 090



SAG

Fuel tank

aluminium

Form	rectangular
------	-------------

Volume l	Dimensions mm	Order number
230	640 x 560 x 720	9464 700 101
300	640 x 560 x 945	9469 420 301
500	640 x 560 x 1560	9469 420 501

Accessories

Description	Order number
1 x Fuel cap, lockable, vented	9668 080 110
2 x Console	9660 860 050
4 x Console rubber	9660 860 070
2 x Tightening strap	9660 860 060
2 x Tightening strap rubber	9660 860 080
1 x Tank sensor	9660 022 481
1 x Connection set	8730 102 488
1 x Blind cover	9660 001 906
1 x Fuel Anti-syphon	9668 010 090



V-belt

XPB2040

Vehicle type	Atego I/II
Version	toothed, raw edge
Length	2040 mm

Order number
3564 640 363



CONTITECH®

Ribbed V-belt

Vehicle type Atego I/II/III

Length mm	Number of ribs	Order number
1910	8	3564 637 204
2000	8	3564 664 942
2035	8	1100 276 616
1725	9	1100 282 514
2325	9	1800 000 151
1670	10	1851 016 700
1815	10	1100 282 365
1890	11	9461 997 269
2871	11	1865 000 000
1515	12	1865 487 070



(Illustration similar)

Ribbed V-belt

Vehicle type Atego I/II/III

Length mm	Number of ribs	Order number
1215	8	1100 282 512
1420	8	1100 219 670
1480	8	9469 970 792
1920	8	1325 040 001
1940	8	9050 289 190
2085	8	3564 663 779
2295	9	1100 282 515
2870	9	1100 211 715
2020	11	3564 642 047
2040	11	1100 282 464
2044	11	2540 101 162
2835	11	1100 282 465



Poly-V belt tensioner

Vehicle type Atego I/II/III

Illustration	Outer Ø mm	Roll width mm	Order number
1	70	35	9462 001 070
2	74	38,3	1911 400 005
3	74	39/57,7	5930 000 543
4	74	34	1911 252 424
5	74	38,3	5930 000 554
6	74	35,5	5930 000 544
7	74	46,3	5930 000 511
8	78	42	1911 043 900
9	78	42/104,5	3563 830 141
10	81	32,9	6954 005 710
11	90	34	1911 400 001

Everything your engine loves!

Spare parts documentation for more than 550 engine variants from the manufacturers:

- DAF
- MAN
- MERCEDES-BENZ
- SCANIA
- VOLVO

... and much more besides!

Request your free catalogue copy!





Deflection pulley/guide pulley

for ribbed V-belt

Vehicle type Atego I/II/III

Illustration	Material	Outer Ø mm	Width mm	Order number
1	metal	80	48	5930 000 541
2	plastic	80	44	9465 500 433
3	metal	107	34	3564 580 874



EURO PART

Flywheel

Vehicle type Atego I/II/III
Version with sprocket, 37 grooves
Diameter 430 mm

Order number
9060 100 000

Accessories

Fastening set

1 axial seal (external diameter 140 mm), 1 race (external diameter 120 mm), 1 pilot bearing (external diameter 62 mm), 10 bolts M16 x 1.5

Order number
9060 000 103

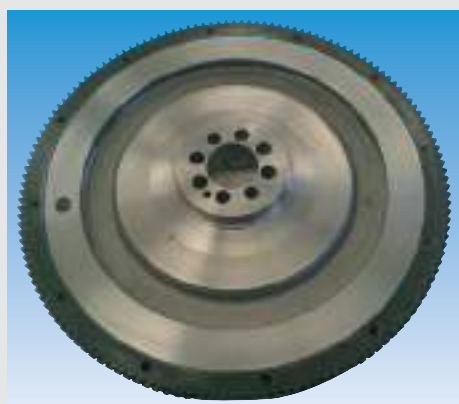

EURO PART

Flywheel

Vehicle type Atego I/II/III
Special equipment SA 505009 05
Version with gear rim
Diameter 395 mm

Order number
9460 301 905

Accessories

Grooved ball bearing with 2 sealing washers

External diameter 52 mm
Inner diameter 20 mm
Height 15 mm

Order number
8001 630 423



Flywheel

in exchange

Vehicle type	Atego I/II/III
Special equipment	SA 505009 03
Version	with gear rim and bearing
Diameter	362 mm

	Order number
(on request)	9460 302 105



Flywheel

Vehicle type	Atego I/II/III
Version	with gear rim
Special equipment	SA 505009 58
Diameter	362 mm

	Order number
	9060 100 065



Dual mass flywheel

Vehicle type	Atego I/II/III
Diameter	430 mm

Scope of supply

with mounting screws

	Order number
	9754 000 008

Accessories

Crankshaft seal

Dimensions	115 x 140 x 12 mm
------------	-------------------

	Order number
	8002 534 667

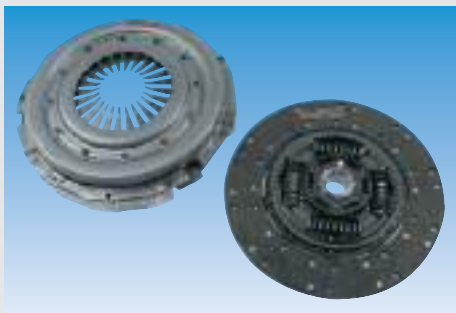

Clutch kit

as replacement

Vehicle type	Atego I/II/III
Toothed hub profile	36x40-18N
Diameter	362 mm
Number of teeth	18

Scope of supply

Disc, automatic unit

Order number
9270 127 701

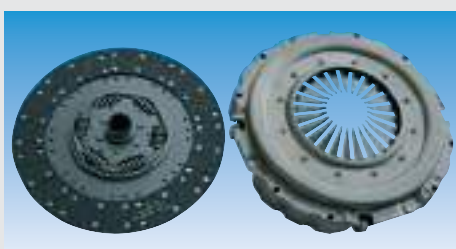

Clutch kit

In exchange

Vehicle type	Atego I/II/III
Toothed hub profile	36x40-18N
Diameter	395 mm
Number of teeth	18

Order number
9271 121 201

Accessories

Central release mechanism

Connection	1 x M20, 1 x M22
Version	without sensor, with black seal

Order number
9279 985 010



Clutch kit

Vehicle type	Atego I
Parameter	MFZ430
Diameter	430 mm
Number of teeth	18
Toothed hub profile	45x50-18N

Scope of supply

Disc, automatic unit, release bearing mounted

Order number
9270 004 003

Comparative number
Sachs 3400 700 446

Suitable centring tools are available from EUROPART!



Storage for propeller shaft

Vehicle type Atego I/II/III
 External diameter 94 mm
 Inner diameter 71 mm

Scope of supply
 with ball bearing

Order number
 9220 001 086

3

Atego

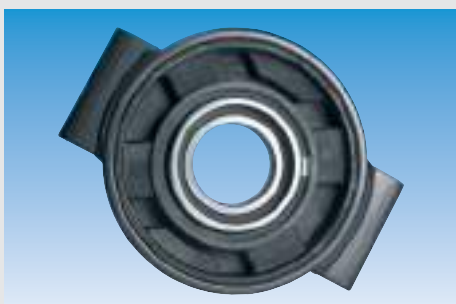

Storage for PTO shaft

Vehicle type Atego I/II/III

Scope of supply
 with ball bearing

Outer Ø mm	Inner Ø mm	Order number
98	61.5	9464 100 022
105	70	9460 119 845



Storage for propeller shaft

Vehicle type Atego I/II/III
 External diameter 170 mm
 Inner diameter 45 mm

Scope of supply
 with ball bearing

Order number
 9070 002 110



Storage for PTO shaft

Vehicle type Atego I/II/III
 External diameter 170 mm
 Inner diameter 55 mm

Scope of supply
 with ball bearing

Order number
 9220 001 045

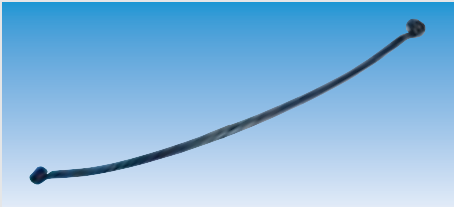

Parabolic spring

Front axle

Vehicle type	Atego I/II/III
Form	7
Number of leaves	1
Thickness	31
Width	80 mm
Length front/rear	860, 940 mm
Bushing front/rear	16/46, 16/46 mm
Axle load	3,2

Order number
1033 828 000



Parabolic spring

Front axle

Vehicle type	Atego I/II/III
Form	7L
Number of leaves	2
Thickness	56
Width	80 mm
Length front/rear	860, 940 mm
Bushing front/rear	18/52, 18/52 mm
Axle load	4,7

Order number
1033 842 000



Parabolic spring

Front axle

Vehicle type	Atego I/II/III
Form	7L
Number of leaves	2
Thickness	60
Width	80 mm
Length front/rear	860, 940 mm
Bushing front/rear	18/52, 18/52 mm
Axle load	5,7

Order number
1033 860 000



Parabolic spring

front axle

Vehicle type	Atego I
Form	1KM
Number of leaves	3
Thickness	79
Width	90 mm
Length front/rear	900, 900 mm
Bushing front/rear	24/60, 24/60 mm
Axle load	7,5

Order number
1033 684 000



Spring hoop

Front axle

Vehicle type	Atego I/II/III
Thread	M16 x 1.5
Form	0
Interior width	81 mm

Length mm	Order number
180	1301 863 180
210	1301 863 200
240	1301 863 240

Accessories

Hexagon nut

Thread	M16 x 1.5
Height	16 mm

Order number
6624 016 150

3

Atego



Parabolic spring

Rear axle

Vehicle type	Atego I/II/III
Width	80 mm

Form	Number of leaves	Thickness mm	Length front/rear mm	Bushing front/rear mm	Axle load t	Order number
1BL	1/1	67	800/800	18/52, 18/52	5,7	1033 687 000
1BL	2/1	97	850/850	22/60, 22/60	9,3	1033 817 000
1BT	2/2	141	850/850	22/61, 22/60	10,4	1033 855 000



Parabolic spring

Rear axle

Vehicle type	Atego I
Form	1BK
Number of leaves	3/1
Width	100 mm
Length front/rear	900/885 mm
Bushing front/rear	24/60, 24/60 mm
Axle load	13 t

Thickness mm	Order number
127	1033 681 000
133	1033 683 000



Spring hoop

Rear axle

Form	1
Thread	M24 x 2
Interior width	102 mm
Length	460 mm

Order number
1301 583 460

Accessories

Flat collar nut

Thread	M24 x 2
Height	33 mm

Order number
5230 000 148

Spring hoop

Rear axle

Form	7
Thread	M18 x 1.5
Interior width	81 mm
Length	450 mm

Order number
1301 873 450

Accessories

Flat collar nut

Thread	M18 x 1.5
Height	18 mm

Order number
1303 181 580



CONTITECH®

Air spring

with piston

Vehicle type	Atego I/II/III
Version	VOSS 232
External diameter	236-246 mm
Piston diameter	190 mm
Height	225 mm

Order number
1780 478 621



www.contitech.de/luftfedern-ersatz

Zur Sicherheit: Luftfedersysteme in Original- Qualität von ContiTech



- OEM-Qualität kompromisslos – das richtige Produkt für jede Anwendung
- Exakt ausgelegte Federungseigenschaften – einfache und passgenaue Montage
- Maximale Lebensdauer bei höchsten Beanspruchungen
- Über 350 Partner weltweit – ContiTech Air Spring Systems verfügt über Produktionsstandorte in Deutschland, Ungarn, China, Türkei, Mexiko und Korea
- Ein Zentrallager für den Ersatzmarkt gewährleistet eine optimale Lieferfähigkeit über das gesamte Produktspektrum

ContiTech – World's Market Leader in Air Spring

**EURO
PART**
Air spring
complete, with steel piston

Vehicle type	Atego I/II/III
Piston diameter	280 mm
Inner diameter	280 mm
Height	270 mm

Order number
1788 475 721

**EURO
PART**
Air spring
with steel piston

Vehicle type	Atego I
Version	VOSS 232
External diameter	276-286 mm
Piston diameter	200 mm
Height	292 mm

Order number
1788 439 022
Air spring

Lower attachment: central inner thread M16 x 1.5

Air connection: outer thread M24 x 1.5, inner thread M16 x 1.5

Vehicle type	Atego I/II/III
Version	VOSS 232
External diameter	276-286 mm
Piston diameter	200 mm
Height	292 mm

Order number
1788 439 012

Air spring
with piston

Vehicle type	Atego I/II
Version	VOSS 232
External diameter	300 mm
Piston diameter	280 mm
Height	310 mm

Order number
1788 475 729



(Illustration similar)



Shock absorber

Vehicle type	Atego I/II/III
Fastening	Eye/eye
Version	oil pressure, twin-tube system
Installation location	front axle

Order number	Comparative number
9000 125 910	Sachs 313 766
9200 001 290	Sachs 131 944
9200 001 235	Sachs 310 807

3

Atego



Shock absorber

Fastening	eye/eye
Version	oil pressure, twin-tube system

(Illustration similar)

Vehicle type	Installation location	Order number	Comparative number
Atego I	front axle	9463 235 400	Sachs 131 622
Atego I	front axle	9201 319 440	Sachs 131 944
Atego I/II/III	rear axle	9201 317 390	Sachs 131 739
Atego I/II/III	rear axle	9750 001 321	Sachs 311 666



(Illustration similar)



Shock absorber

Vehicle type	Atego I
Fastening	Eye/eye
Version	Oil pressure, twin-tube
Installation location	Rear axle

Order number	Comparative number
9750 001 258	Sachs 311 665
9201 243 130	Sachs 124 313



Drag-link

X-CAP

Vehicle type	Atego I
Installation location	drop arm to the 1st front axle
Length	711 mm
Pipe diameter	42 mm
Cone diameter	32 mm

Order number
9890 200 163

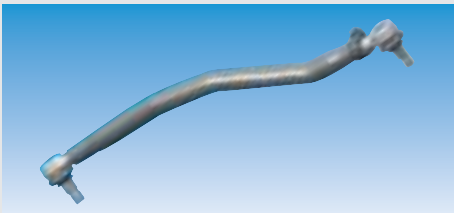

Drag-link

Vehicle type	Atego I/II/III
Installation location	drop arm to the 1st front axle
Length	875 mm
Pipe diameter	50 mm
Cone diameter	26 mm

Order number
9054 600 605



Ball joint

for track rod/drag link

Vehicle type	Atego I
Installation location	front axle
Outer thread	M24 x 1.5/M30 x 1.5
Cone	30 mm
Length	120 mm

Threadtype	Order number
right-hand thread	9070 900 117
left-hand thread	9070 900 123



Power-steering pump

in exchange

Vehicle type	Atego I/II/III
Version	hydraulic

Order number	Comparative number
9074 204 210	Mercedes-Benz 001 460 44 80
9074 204 910	Mercedes-Benz 000 460 94 80
9074 209 110	Mercedes-Benz 002 460 14 80
6952 009 210	Mercedes-Benz 002 460 15 80

Power-steering pump

Tandem pump

Vehicle type Atego I/II/III

Order number

6542 045 410

Comparative number

Mercedes-Benz 003 460 03 80



Stabilizer mounting

Vehicle type Atego I/II/III

Installation location	Outer Ø mm	Inner Ø mm	Length mm	Material	Order number
front	28.5	12	30	rubber/metal	9290 001 050
front	40	17	40	rubber/metal	9460 105 325
front	61	38	55	rubber	9460 109 904
front	74	47	56	rubber	9460 109 905
rear	80	40	46	rubber/metal	9463 238 185
rear	87	56	56	rubber	1597 200 333
front	98	70	67	rubber	9461 323 015
front/rear	108.5	80	67	rubber	1583 006 123



Stabilizer mounting

Vehicle type	Atego I/II/III
Version	for vehicles with air suspension
Installation location	rear
External diameter	109 mm
Inner diameter	88 mm
Length	175 mm
Distance between centres	130 mm
Bore hole diameter	20.5 mm

Order number

1583 006 121



Steering Track Rod

Vehicle type	Atego I/II/III
Form	straight
Installation location	front axle
Threadtype	left-hand thread/right-hand thread
Length	1605 mm
Pipe diameter	40 mm
Cone diameter	30 mm

Order number

9070 900 112



Steering Track Rod

Vehicle type	Atego I
Installation location	Front axle
Form	offset
Threadtype	Right-hand thread

Length mm	Pipe Ø mm	Cone-Ø mm	Order number
1588	60	30	9079 924 315
1735	52	32	9070 001 410



Ball joint for steering track rod

Vehicle type	Atego I/II/III
Installation location	front axle
Outer thread	M27 x 1.5/M30 x 1.5
Cone	32 mm
Length	120 mm

Threadtype	Order number
left-hand thread	9070 900 045
right-hand thread	9070 900 015

(Illustration similar)



Wheel hub

Vehicle type	Atego I/II/III
Installation location	Front axle

Version	Order number
with bearing	9463 300 125
without bearing	9870 102 496



Wheel hub

Vehicle type	Atego I/II/III
Installation location	Rear axle
Version	with bearing

	Order number
(on request)	9463 500 335

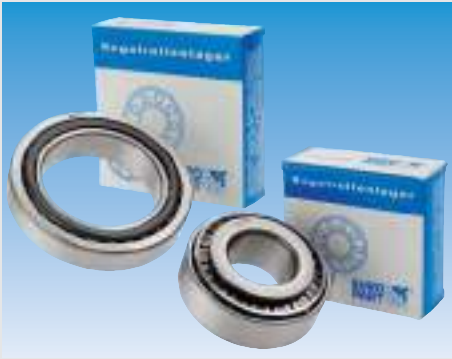

Tapered roller bearing

Vehicle type Atego I/II/III

Version	Outer Ø mm	Inner Ø mm	Height mm	Order number
wheel hub, outer	130	60	48.5	8001 323 122
wheel hub, outer	130	80	37	8001 331 162
wheel hub, inner	150	100	39	8001 330 202
wheel hub, inner	170	110	47	8001 330 222



Atego

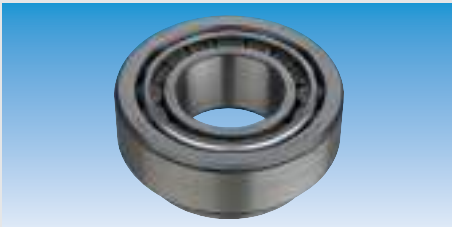

Tapered roller bearing

Vehicle type Atego I/II/III

Version	Outer Ø mm	Inner Ø mm	Height mm	Order number
wheel hub, outside	72	35	28	8001 332 070
Wheel hub, inside	110	55	39	6950 001 328
wheel hub, inner	150	70	64	8001 228 000
wheel hub, outer	157	100	42	9469 812 305
rear axle, outer	160	100	44	8001 805 312

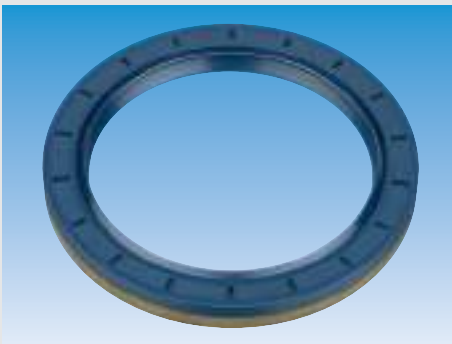

Shaft sealing ring

for wheel hub

Vehicle type Atego I/II/III
 Installation location front axle, inner
 Version for 8-hole wheel connection
 External diameter 150 mm
 Inner diameter 120 mm
 Height 12 mm

Order number
9460 245 939



Shaft sealing ring

for wheel hub

Vehicle type Atego I/II/III
 Installation location Front axle, inner
 Version with ABS ring
 External diameter 134 mm
 Inner diameter 75 mm

Order number
9479 970 446

Energiesparende SKF Kegelrollenlager

SKF hat neue Kegelrollenlager entwickelt, die Energieeinsparungen von 30% und mehr ermöglichen. SKF Kunden können mit diesen Lagern ihre Ziele nachhaltig, energieeffizient und profitabel umsetzen.

Energievorräte weltweit begrenzt

Die Energievorräte der Erde sind begrenzt. Daher ist die Senkung des Energieverbrauchs heute eines der vordringlichsten umweltrelevanten Ziele. Dies kann unter anderem durch die Reduzierung von Reibung erreicht werden. Wälzlager haben hier schon immer einen erheblichen Beitrag geleistet. Die neuen, energiesparenden SKF Kegelrollenlager bieten in puncto Reibungsminderung jedoch noch weitaus mehr. Sie wurden speziell darauf ausgelegt, den Energieverbrauch in Wälzlagern noch weiter zu senken.

Spezifische Produktmerkmale energiesparender Kegelrollenlager:

- Geringeres Gewicht
- Optimierte neue Konstruktion
- PEEK-Käfig auf Wunsch
- Längere Laufbahn
- Spezielle Rollentopographie
- Energiesparende Kegelrollenlager basieren auf dem Standard Kegelrollenlager-sortiment

Vorteile energiesparender Kegelrollenlager

- Reibungsreduzierung um mindestens 30% – und damit geringerer Energieverbrauch der Lager
- Niedrigere Betriebstemperaturen führen zu besseren Schmierungsbedingungen
- Geringere Massenträgheit durch weniger Gewicht; geringeres Risiko von Gleitbewegungen und den damit verbundenen Anschmierungen
- Geringere Reibung ermöglicht erheblich höhere Betriebsdrehzahlen
- Standard-Kegelrollenlager können problemlos durch die neuen, energiesparenden Lager ersetzt werden

Wettbewerbsvorteile:

SKF bietet diese neue Bauart energiesparender Kegelrollenlager als Alternative zu sämtlichen Standard-Kegelrollenlagern an. Die neuen Lager wurden nicht für eine einzige spezielle Anwendung entwickelt. Ihre Außenabmessungen entsprechen der ISO-Norm, wodurch sie Standard-Kegelrollenlager problemlos ersetzen können.





Shaft sealing ring

for wheel hub

Installation location Rear axle, inner

Illustration	Vehicle type	Outer Ø mm	Inner Ø mm	Height mm	Order number
1	Atego I/II/III	150	125	15	8002 971 436
2	Atego I	175	145	13	8002 972 960
3	Atego I/II/III	175	145	14	8002 979 998
4	Atego I/II/III	175	145	15	8002 972 816
5	Atego I/II/III	175	145	17/21	8002 972 815



Repair kit

for wheel hub

Vehicle type Atego I/II/III
 Installation location Rear axle
 Installation side left, right
 External diameter 150 mm
 Inner diameter 125 mm
 Height 15 mm

Scope of supply

1 shaft seal, 1 seal, 1 locking washer

Order number
9460 006 120



Gasket set

for wheel hub

Vehicle type Atego I/II/III
 Installation location front axle
 External diameter 150 mm
 Inner diameter 120 mm
 Height 20 mm

Scope of supply

2 axial seals, 1 seal, 1 pulse wheel, 8 hexagon bolts

Order number
9463 301 025

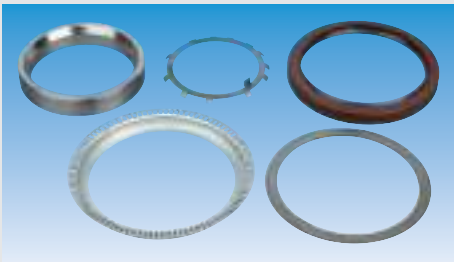

Gasket set

for wheel hub

Vehicle type	Atego I/II/III
Installation location	rear axle
Installation side	left/right
External diameter	175 mm
Inner diameter	145 mm
Height	17 mm

Scope of supply

1 axial seal, 1 thrust ring, 1 pulse wheel, 1 cover plate, 1 tab washer

Order number
8002 000 033

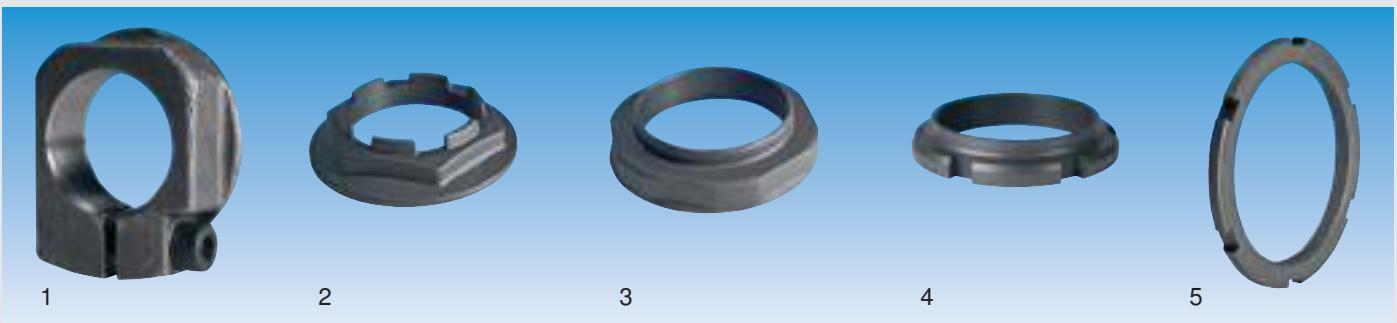

Axle nut

Vehicle type Atego I/II/III

Illustration	Installation location	Thread	Order number
1	Front axle/rear axle	M45 x 1.5	1325 040 294
2	Front axle/rear axle	M64 x 1.5	(on request) 9462 332 007
3	Front axle	M70 x 1.5	9469 908 150
4	Rear axle	M75 x 1.5	(on request) 9463 530 026
5	Rear axle	M100 x 1.5	9463 560 226



'A' frame

with molecular bearing

Vehicle type	Atego I/II/III
Installation location	Rear axle
Length	622 mm
Distance between holes	152/130/130 mm
Pipe diameter	46 mm
Bore hole diameter	25/25/25 mm

Order number
9070 001 021



'A' frame with molecular bearing

Vehicle type	Atego I/II/III
Installation location	rear axle
Distance between holes	152/130/130 mm
Length	622 mm
Pipe diameter	46 mm
Bore hole diameter	25/23/23 mm

Order number
5220 090 013



Repair kit

for wishbone

Vehicle type	Atego I/II/III
Version	with molecular bearing
Bore hole diameter	23 mm
Distance between holes	130 mm

Order number
9079 991 558



Repair kit

for wishbone

Vehicle type	Atego I/II/III
Version	with molecular bearing

Bore hole Ø mm	Distance between holes mm	Order number
25	130	9079 991 608
25	152	9077 200 300
25	152	9079 991 609



Repair kit

Kingpin

Vehicle type	Atego I/II/III
Bolt diameter	50 mm
Bolt length	223 mm

Scope of supply

2 top needle bearings, 2 bottom needle bearings, 1 thrust bearing, 1 sealing ring, 1 thrust collar

Installation location	Installation side	Order number
track-rod arm side	left	9460 066 235
steering arm side	right	9460 066 328

Accessories

Description	Order number
Kingpin	9463 320 006



Repair kit

Kingpin

Vehicle type Atego I/II/III
 Bolt diameter 50 mm
 Bolt length 109 mm

Scope of supply

1 axle bolt, 1 sealing ring, 1 bush, 1 pressure disc, 1 shaft sealing ring, 1 circlip, 1 screw plug

Order number
 1583 005 000



Repair kit

Kingpin

Vehicle type Atego I/II/III
 Bolt diameter 50 mm
 Bolt length 120 mm

Scope of supply

1 axle bolt, 1 sealing ring, 1 snap ring, 1 shaft sealing ring, 1 screw plug, 2 needle bearings

Order number
 9463 300 219



Repair kit

Kingpin

Vehicle type Atego I/II/III
 Bolt diameter 50/64 mm
 Bolt length 119 mm

Scope of supply

1 axle bolt, 1 sealing ring, 1 bush, 1 shaft sealing ring, 1 snap ring, 1 screw plug

Order number
 1583 005 100



Transverse link

Vehicle type Atego I/II/III
 Version with molecular bearing
 Installation location Front axle
 Length 813 mm
 Bore hole diameter 17 mm
 Distance between holes 100 mm
 Pipe diameter 48 mm

Order number
 9050 238 300

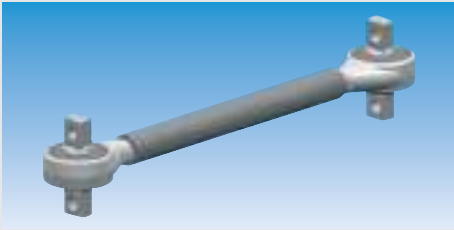

Trailing arm

Vehicle type	Atego I/II/III
Version	with molecular bearing
Length	655 mm
Pipe diameter	40 mm
Bore hole diameter	17 mm
Distance between holes	115 mm

Order number
9073 500 906



Trailing arm

Vehicle type	Atego I/II/III
Version	with molecular bearing
Length	850 mm
Pipe diameter	52 mm
Bore hole diameter	17 mm
Distance between holes	100 mm

Order number
9070 022 092



Trailing arm

Vehicle type	Atego I/II/III
Version	with molecular bearing
Length	754 mm
Pipe diameter	58 mm
Bore hole diameter	17 mm
Distance between holes	100 mm

Order number
9079 991 543



Wheel bolt

Vehicle type Atego I/II/III

Installation location	Outer thread	Overall length mm	Order number
front axle/rear axle	M18 x 1.5	63	2213 001 501
rear axle	M18 x 1.5	78	9464 020 071
front axle	M20 x 1.5	70	2213 000 100
front axle/rear axle	M20 x 1.5	85	2213 000 900
front axle/rear axle	M22 x 1.5	78,5	2213 000 105
rear axle	M22 x 1.5	96,6	2213 000 106
rear axle	M22 x 1.5	101,5	2213 000 110

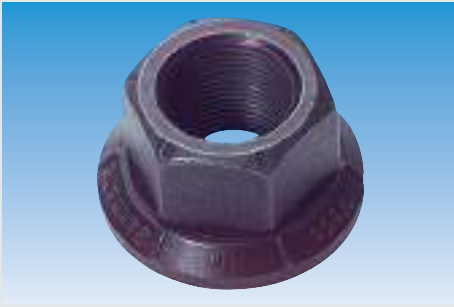

Wheel nut

Vehicle type Atego I/II/III

This figure corresponds to 1303 221 551

Installation location	suitable for	Thread	Height mm	Spanner size mm	Order number
front axle/rear axle		M18 x 1.5	18	24	1303 181 580
front axle/rear axle		M20 x 1.5	21	27	1303 201 580
front axle/rear axle	steel and aluminium wheels	M22 x 1.5	27	32	1303 221 551
front axle	aluminium wheels	M22 x 1.5	34 (Short sleeve)	32	6136 320 442
rear axle	aluminium wheels	M22 x 1.5	62 (Long sleeve)	32	6136 320 452

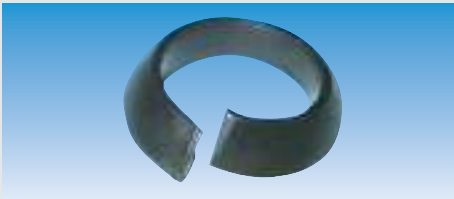

Retainer ring for wheel bolts

Vehicle type Atego I/II/III
 Standard DIN/ISO 74361
 Installation location front/rear
 Thickness 8 mm

Outer Ø mm	Inner Ø mm	Order number
29	18.5	2280 185 700
34	20.5	2280 205 800

BEST IN SPARE PARTS

ENTWICKLUNG
PRODUKTION
VERTRIEB

**Unsere Produkte sind
'designed in Germany'**

Weitere Informationen und einen
Einblick in unseren elektronischen
Katalog erhalten Sie unter:

WWW.PE.DE

Besuchen Sie uns, wir freuen uns
auf Sie! Auch bei **FACEBOOK.PE.DE**



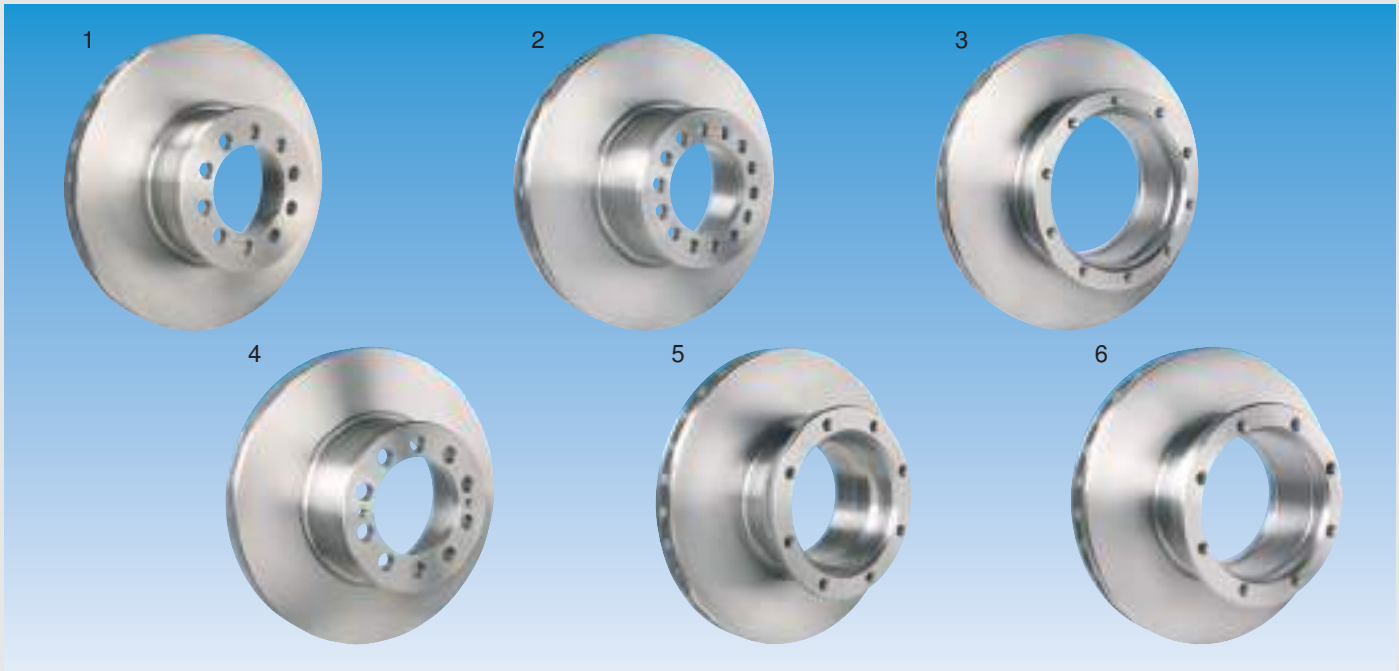

Brake disc

Vehicle type Atego I/II
Version internally ventilated

Illustration	Installation location	Dimensions mm	Height mm	Hole pattern	Order number
1	front axle	335 x 34	102.5	10 x 14,5	3410 304 181
2	front axle	377 x 45	134	14 x 14,5	3410 306 760
3	front/rear axle	430 x 45	132.5	10 x M14 x 1,5	3403 460 000
4	front/rear axle	430 x 45	143.5	10 x M20 x 1,5	3403 460 001
5	rear axle	335 x 34	111	8 x M12 x1,5	2030 335 002
6	rear axle	377 x 45	138.5	8 x M14 x 1,5	3410 306 770

Suitable brake piston resetting tools available from EUROPART!

Qualität ist unsere Stärke



Seit fast 100 Jahren zeigt Textar in Sachen Qualität und Sicherheit echte Power. Erstklassige Rezepturen und jahrzehntelange Entwicklungserfahrung sorgen für eine konstant kraftvolle Performance unserer Bremsbeläge. Textar – eine starke Leistung!



Textar is a registered trademark of TMD Friction.

www.textar.com

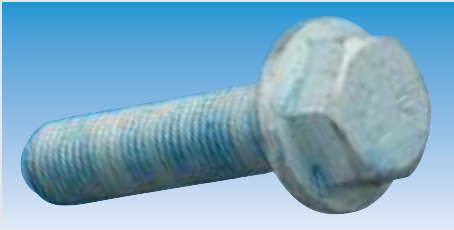

Attachment screw

for brake disc

Vehicle type	Atego I/II
Installation location	Front axle
Surface	dacroitized
Thread	M14 x 1.5
Property class	10.9
Length	60 mm

Order number
9460 066 205

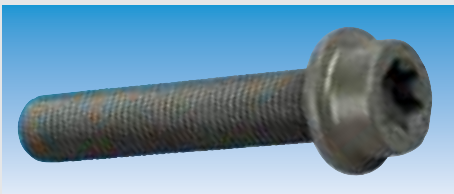

Attachment screw

for brake disc

Vehicle type	Atego I/II
Installation location	Rear axle
Surface	phosphated
Thread	M14 x 1.5
Property class	10.9
Length	75 mm

Order number
9469 900 004



Brake pad set

Front axle/rear axle

Vehicle type	Atego I/II
Contents of set	4
Coating length	185 mm
Lining width	84 mm
Lining thickness	27.00 mm
Brake system	Knorr SB/SN 5
WVA no.	29183

Scope of supply

with accessories

Order number
2129 115 008



Brake pad set

Vehicle type Atego I/II
 Contents of set 4
 Lining thickness 30.00 mm

Scope of supply
 with accessories

Installation location	Brake system	WVA no.	Coating length mm	Lining width mm	Order number
front axle	Knorr SB 6000	29095	210	92,5	2129 095 005
front/rear axle	Knorr SB/SN 7	29061	248	108	2323 405 106



Brake pad set

Vehicle type Atego I
 Brake system Knorr SB/SN 5
 WVA no. 29183
 Contents of set 4
 Coating length 185 mm
 Lining width 84 mm
 Lining thickness 27.00 mm

Scope of supply
 with accessories

Order number
 2129 115 270

(Illustration similar)



Brake pad set

Brake system Knorr SB 7000
 WVA no. 29202
 Contents of set 4
 Coating length 247,7 mm
 Lining width 109,7 mm
 Lining thickness 30.00 mm

Scope of supply
 with accessories

Order number
 2190 873 005



Brake caliper

Installation location	front axle/rear axle
Version	standardised

Application range
for 22.5" wheel size

Type	Installation side	Order number
SN7211RC	left	3450 003 800
SN7201RC	right	3450 003 799

Accessories

Description	Order number
Pressure pad set	3400 110 013
Guide sealing set	3450 414 380
Adjuster cap set	3450 411 915



Brake caliper

Vehicle type	Atego I/II/III
Installation location	front axle/rear axle
Version	standardised

Application range
for 17.5" wheel size

Type	Installation side	Order number
SN5016RC	left	3450 414 785
SN5006RC	right	3450 414 784

Accessories

Description	Order number
Pressure pad set	3400 001 929
Guide sealing set	3400 047 188
Adjuster cap set	3450 411 915



Brake caliper

Vehicle type	Atego I/II/III
Installation location	front axle/rear axle
Version	standardised

Application range
for 17.5" wheel size

Type	Installation side	Order number
SN5015RC	left	3450 414 783
SN5005RC	right	3450 414 782

Accessories

Description	Order number
Pressure pad set	3400 001 929
Guide sealing set	3400 047 188
Adjuster cap set	3450 411 915



Brake caliper

Vehicle type	Atego I/II
Installation location	front axle/rear axle
Version	standardised

Type	Installation side	Order number
SN6558RC	left	3400 047 090
SN6568RC	right	3400 047 091

Accessories

Description	Order number
Pressure pad set	3400 001 929
Guide sealing set	3400 047 188
Adjuster cap set	3450 411 915

3

Atego



Brake caliper carrier

Vehicle type	Atego I/II/III
--------------	----------------

Brake system	Installation location	Order number
Knorr SB/SN 5	front axle/rear axle	3700 001 927
Knorr SB/SN 6	front axle/rear axle	3450 412 185
Knorr SB/SN 7	front axle	3450 411 905
Knorr SB/SN 7	rear axle	3450 411 910

Our network – 200 locations in 28 countries

EUROPART – the international partner for the workshop

www.europart.net



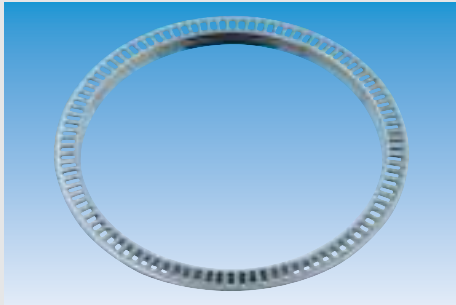

Sensor ring, ABS

ABS

Vehicle type	Atego I/II/III
Installation location	Front axle

This figure corresponds to 1593 102 551

Outer Ø mm	Inner Ø mm	Thickness mm	Order number
164/188	160	12	1593 102 551
175	145	12	(on request) 9463 340 415
178	140	15	9463 334 011

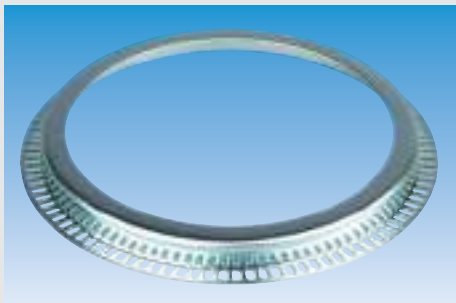

Sensor ring, ABS

ABS

Vehicle type	Atego I/II/III
Installation location	Rear axle
External diameter	176/195.5 mm
Inner diameter	153 mm
Thickness	16.5 mm

Order number
1593 102 550



Sensor ring, ABS

ABS

Vehicle type	Atego I/II/III
Installation location	Rear axle
External diameter	131/162 mm
Inner diameter	102/128 mm
Thickness	80 mm

Order number
9473 560 415



Brake drum

Vehicle type Atego I

Illustration	suitable for	Dimensions mm	Brake path mm	Order number
1	front axle	410 x 237 x 10 x 23/3 x M12 x 1,5	191	2030 410 039
2	rear axle	410 x 306 x 10 x 24/5 x 24/3 x M12 x 1,5	237	2030 410 040
1	rear axle	410 x 306 x 10 x 23/5 x 24/3 x M12 x 1,5	240	2030 410 034

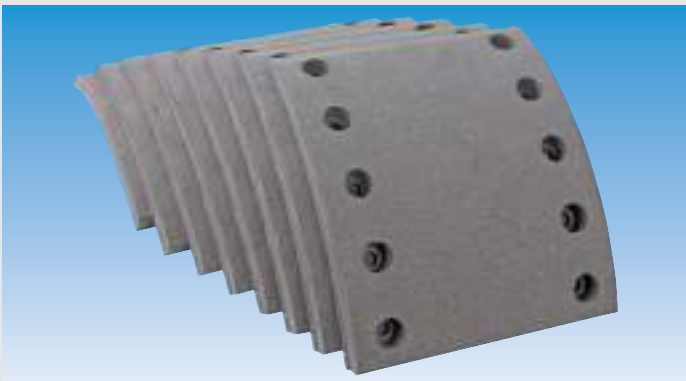

Brake lining set

Vehicle type Atego I
 Lining thickness 17.00 mm
 Contents of set 8

WVA no.	Dimensions mm	Order number
19495	410 x 183	2119 487 008
19496	410 x 223	2119 488 008

**WABCO****Air dryer**

Vehicle type	Atego I/II/III
Version	1-chamber system
Operating pressure	max. 13 bar

Order number	Comparative number
0565 000 070	WABCO 932 500 110 0

**WABCO****Air dryer**

Vehicle type	Atego I/II/III
Version	1-chamber system with integrated pressure regulator and heating bar
Operating pressure	max. 13 bar
Opening pressure	14,5 + 2,5 bar
Cut-off pressure	12 ± 0,3 bar
Operating range	1,5 +/- 0,25 bar
Voltage	24 V

Order number	Comparative number
0564 000 020	WABCO 932 400 024 0

**WABCO****Air dryer**

Vehicle type	Atego I/II/III
Version	2 chamber system
Operating pressure	max. 13 bar
Opening pressure	14,5 ± 2,5 bar
Cut-off pressure	12 ± 0,3 bar
Voltage	24 V

Order number	Comparative number
0174 330 020	WABCO 432 433 002 0
0174 320 060	WABCO 432 433 206 0

**WABCO****Air dryer****as replacement**

Vehicle type	Atego I/II/III
Thread	M39 x 1.5
Operating pressure	max. 13 bar

Order number	Comparative number
3419 851 271	WABCO 432 410 222 7



Air dryer

Vehicle type	Atego I/II/III
Version	1-chamber system
Cut-off pressure	12,3 +/- 0,3 bar
Operating range	1,5 +/- 0,25 bar
Voltage	24 V

Order number

3450 409 045

Comparative number

Knorr II38310FN00



Air dryer

Vehicle type	Atego I/II/III
Version	1-chamber system
Cut-off pressure	12,3 +/- 0,3 bar
Operating range	1,5 +/- 0,25 bar
Voltage	24 V

Order number

3400 038 309

Comparative number

Knorr II38308FN00



Four-circuit protection valve

as replacement

Vehicle type	Atego I/II/III
Operating pressure	max. 13 bar

Order number

0577 050 050

Comparative number

WABCO 934 705 005 7



Pressure sensor

Vehicle type	Atego I/II/III
--------------	----------------

Order number

0210 435 011

Comparative number

WABCO 932 500 501 1

Atego



Pressure sensor

Vehicle type Atego I/II/III

Order number

3450 414 230

Comparative number

Knorr II39746F004



Compressed air tank

EN 286-2, steel

Vehicle type Atego I/II
 Version with bracket
 Volume 5 l
 Diameter 154 mm
 Length 341 mm
 Connection 3 x M22 x 1.5
 Operating pressure 10 bar

Order number

3620 001 545



Compressed air tank

EN 286-2, steel

Vehicle type Atego I/II
 Connection 4 x M22 x 1.5
 Operating pressure max. 15.5 bar

Volume l	Ø mm	Length mm	Order number
20	276	414	3620 027 620
30	276	583	3620 027 630



Compressed air tank

to EN 286-2, Aluminium

Vehicle type Atego I/II
 Connection 2 x M22 x 1.5
 Diameter 246 mm
 Operating pressure max. 12.5 bar

Volume l	Length mm	Order number
20	500	1740 200 024
30	720	1742 302 460



Air reservoir tensioning strap

with bracket, 1-piece

Vehicle type Atego I/II

Ø mm	Order number
206	1740 012 060
246	1740 022 460
276	1740 032 760

Accessories

Tensioning strap base

Length 1000 mm

Material rubber

Order number
9085 413 340



Dehumidification valve

DIN 74292, standard B

Version mechanical, with ring

Material brass

Connection M22 x 1,5

Operating pressure 20 bar

Spanner size 27

Order number
1740 060 020



EBS foot brake module

in exchange

Vehicle type Atego I/II/III

Order number

3403 718 150

Comparative number

Knorr I137181N50



Braking-value sensor

EBS

Vehicle type Atego I

Version without silencer

Operating pressure max. 10 bar

Connection 1-2 M22 x 1,5

Connection 4 M16 x 1,6

Thread VOSS

Order number

0640 060 030

Comparative number

WABCO 480 001 000 0



WABCO

Hand brake valve

Vehicle type	Atego I/II/III
Operating pressure	max. 10 bar

Order number	Comparative number
0607 231 250	WABCO 961 723 125 0



KNORR-BREMSE

Hand brake valve

Vehicle type	Atego I/II/III
Operating pressure	max. 10/8.5 bar

Order number	Comparative number
3401 970 066	Knorr K038808N00



KNORR-BREMSE

Hand brake valve

Vehicle type	Atego I/II/III
Version	lateral connections
Operating pressure	max. 10 bar

Order number	Comparative number
3400 006 770	Knorr K038804N00



KNORR-BREMSE

Hand brake valve

Vehicle type	Atego I/II/III
Operating pressure	max. 10 bar

Order number	Comparative number
3400 006 760	Knorr K038803N00



WABCO

Motor coach brake valve

with VOSS 232 coupling unit

Vehicle type	Atego I/II/III
Version	lead 0.5 bar, control ratio 2:1, with silencer
Operating pressure	max. 10 bar

Order number	Comparative number
0283 192 740	WABCO 461 319 274 0



WABCO

EBS axle modulator

Vehicle type Atego I/II/III

Order number

3800 105 006

Comparative number

WABCO 480 105 006 0



WABCO

EBS axle modulator

Vehicle type Atego I/II/III

Order number

0362 000 037

Comparative number

WABCO 480 103 011 0



WABCO

EBS relay valve

Version proportional relay valve, with silencer

Thread VOSS 232

Connection electric, bayonet DIN

Connection 1-2 M22 x 1,5

Connection 4 M16 x 1,5

Order number

0640 060 040

Comparative number

WABCO 480 202 004 0



WABCO

Relay valve

Vehicle type Atego I/II/III

Thread VOSS 230

Connection electric, bayonet (DIN)

Connection 1-2 M22 x 1,5

Connection 3 with muffler

Connection 4 M16 x 1,5

Order number

0640 060 037

Comparative number

WABCO 973 006 003 0



WABCO

Relay valve

Vehicle type	Atego I/II/III
Thread	VOSS
Connection 1-2	M22 x 1,5
Connection 3	with muffler
Connection 4	M16 x 1,5

Order number	Comparative number
0640 110 040	WABCO 973 011 004 0



WABCO

Solenoid control valve

for ABS

Vehicle type	Atego I/II/III
Installation location	rear axle
Voltage	24 V
Electric current	1,65 A
Connection	electric, bayonet (DIN)
Connection thread	M22 x 1.5 JED-388

Order number	Comparative number
0371 950 087	WABCO 472 195 016 0



WABCO

Speed sensor

S plus

Vehicle type Atego I/II/III

Illustration	Colour	Cable length mm	Order number	Comparative number
1	orange	2500	0210 329 200	WABCO 441 032 920 0
1	orange	3000	0210 329 420	WABCO 441 032 942 0
2	black	1500	0210 328 510	WABCO 441 032 851 0
2	black	2000	0210 328 230	WABCO 441 032 823 0
3	black	3400	0210 329 410	WABCO 441 032 941 0

Accessories

Clamping sleeve

Length 33 mm

Order number
0687 605 104



Membrane brake cylinder

Type 24

with VOSS 232 coupling unit

Vehicle type	Atego I/II/III
Installation location	front axle
Connection 1	side, M22 x 1.5, VOSS NG 12
Connection 2	central, M12 x 1.5
Stroke	64 mm
Length of piston rod	15 mm

Installation side	Order number	Comparative number
left	3405 351 500	Knorr K002720N00
right	3405 351 400	Knorr K002624N00

3

Atego



Membrane brake cylinder

Type 24

Vehicle type	Atego I/II/III
Installation location	front axle
Connection 1	M22 x 1.5
Connection 2	M12 x 1.5
Stroke	64 mm
Length of piston rod	15 mm

Installation side	Order number	Comparative number
right	3405 351 600	Knorr K002721N00
left	3405 352 200	Knorr K002722N00



Membrane brake cylinder

Type 24

with clutch unit VOSS 232

Vehicle type	Atego I/II/III
Installation location	Front axle
Connection 1	on the side, M22 x 1.5, VOSS NG 12
Installation side	left, right
Stroke	64 mm
Length of piston rod	15 mm

Order number	Comparative number
3779 021 830	Haldex 125 240 400



WABCO

Combination brake cylinder

Type 20/24 IBV

with VOSS 232 coupling unit

Vehicle type	Atego I/II/III
Installation location	rear axle
Connection	M22 x 1.5, VOSS NG 12
Stroke	64/64 mm
Length of piston rod	15 mm

Installation side	Order number	Comparative number
left	0554 600 010	WABCO 925 480 005 0
right	0554 600 000	WABCO 925 480 004 0



WABCO

Combination brake cylinder

Type 12/16 IBV

Vehicle type	Atego I/II/III
Installation location	rear axle
Installation side	left/right
Connection	M22 x 1.5, VOSS 232
Operating pressure	max. 10.2/8.5 bar
Stroke	57/57 mm
Length of piston rod	15 mm

Order number	Comparative number
0554 661 010	WABCO 925 486 101 0



WABCO

Combination brake cylinder

Type 20/24 IBV

with VOSS 232 coupling unit

Vehicle type	Atego I
Installation location	rear axle
Connection	M22 x 1.5, VOSS NG12
Operating pressure	max. 10.2/8.5 bar
Stroke	64/64 mm
Length of piston rod	15 mm

Installation side	Order number	Comparative number
left	0554 600 110	WABCO 925 480 011 0
right	0554 600 100	WABCO 925 480 010 0



Combination brake cylinder

Type 20/24

with VOSS 232 coupling unit

Vehicle type	Atego I/II/III
Installation location	rear axle
Connection	M22 x 1.5
Stroke	57/57 mm
Length of piston rod	15 mm

Installation side	Order number	Comparative number
left	3400 009 492	Knorr K004032000
right	3400 009 491	Knorr K004031000

3

Atego



Combination brake cylinder

Type 20/24

with VOSS 232 coupling unit

Vehicle type	Atego I/II/III
Installation location	rear axle
Connection	M22 x 1.5
Stroke	64/64 mm
Length of piston rod	15 mm

Installation side	Order number	Comparative number
left	3404 045 000	Knorr K004045000
right	3404 044 000	Knorr K004044000



Combination brake cylinder

Type 20/24 HFL3

with VOSS 232 coupling unit

Vehicle type	Atego I/II/III
Installation location	rear axle
Connection	M22 x 1.5, VOSS NG 12
Stroke	64/64 mm
Length of piston rod	15 mm

Installation side	Order number	Comparative number
left	3400 019 060	Knorr K002860N00
right	3400 046 505	Knorr K002861N00



WABCO

Clutch servo

in exchange

Vehicle type	Atego I
Piston diameter	102 mm
Connection	M16 x 1.5
Stroke	85 mm
Operating pressure	max. 10 bar

Order number	Comparative number
0730 514 057	WABCO 970 051 431 7



WABCO

Clutch servo

Vehicle type	Atego I/II/III
Connection	M16 x 1.5
Stroke	85 mm
Operating pressure	max. 10 bar

Order number	Comparative number
0730 514 410	WABCO 970 051 441 0



Coupling head

automatic

Vehicle type	Atego I/II/III
Version	with valve

Version	Connection thread	Colour	Order number
brake line	M16 x 1.5	yellow	3700 000 011
brake line	M22 x 1.5	yellow	3700 000 013
supply line	M16 x 1.5	red	3700 000 012
supply line	M22 x 1.5	red	3700 000 014



Coupling head

automatic

Version	supply line
Connection thread	M16 x 1.5

Order number
3700 000 008



WABCO

ECAS path sensor

for air suspension

Vehicle type Atego I/II/III
 Connection bayonet DIN 72585-A1-2.1-Sn/K2

Order number

9465 422 618

Comparative number

WABCO 441 050 121 0

3

Atego



WABCO

ECAS solenoid valve

Vehicle type Atego I/II/III
 Installation location Rear axle
 Version with muffler
 Connection electric, bayonet DIN
 Connection thread M22 x 1.5
 Voltage 24 V
 Operating pressure max. 13 bar

Order number

0378 800 000

Comparative number

WABCO 472 880 000 0



WABCO

ECAS solenoid valve

Vehicle type Atego I/II/III
 Installation location rear axle
 Version 3 magnets, with silencer
 Connection electric, bayonet DIN
 Connection thread M22 x 1.5
 Voltage 24 V
 Operating pressure max. 13 bar

Order number

0379 000 600

Comparative number

WABCO 472 900 060 0

Accessories

Muffler

Diameter 69 mm
 Height 45/56.5 mm
 Operating pressure max. 13 bar
 Connection M22 x 1.5

Order number

0174 070 000



WABCO

ECAS solenoid valve

Vehicle type	Atego I/II/III
Installation location	rear axle, tag axle
Version	with noise reducer, solenoid connection at top
Connection	electric, 2 x bayonet (DIN)
Connection thread	M22 x 1.5, VOSS 230
Voltage	24 V
Operating pressure	max. 5-13 bar

Order number	Comparative number
0379 051 110	WABCO 472 905 111 0



WABCO

ECAS control unit

Vehicle type	Actros I, Atego I/II
System	6 x 2
Voltage	24 V

Order number	Comparative number
0761 700 520	WABCO 446 170 055 0



WABCO

Central module

Version	4S/4M
---------	-------

Order number	Comparative number
0362 000 030	WABCO 446 130 014 0

“V^{top} drivers: Roll up!”

EUROPART is already there.



We are “all fired up” and support this initiative:

1. We want to help to improve the social standing of the driver.
2. We want to stimulate the knowledge and sense of responsibility of the driver.
3. We want to optimise understanding of the needs of the driver in all levels of society.
4. We want to join in helping to make road traffic safer and more harmonious for all those involved.

Reason – Understanding – Example:
The trademarks of the V^{top} drivers.

An initiative of the long-distance truck driver magazine FERNFAHRER and the lighting specialist Hella.

More information from:

www.europart.net

www.v-top.de

**EURO
PART** 
... more than parts



Assortment case

for VOSS connector system 230, complete

Version	Order number
42-piece	0307 001 415

Contents

Number	Description	Dimensions mm	Order number
2	Straight connector	NG 8, Pipe connector 6 x 1	0307 000 050
2	Straight connector	NG 8, Pipe connector 9 x 1,5	0307 000 350
2	Straight connector	NG 12, Pipe connector 9 x 1,5	0307 000 180
2	Straight connector	NG 12, Pipe connector 12 x 1,5	0307 000 200
1	Straight connector	NG 12, Pipe connector 16 x 2	0307 000 060
1	Tee plug connector	NG 12, Pipe connector 12 x 1,5	0307 001 960
1	Angled plug	NG 8, 90°, Pipe connector 6 x 1	0307 000 070
2	Angled plug	NG 8, 90°, Pipe connector 8 x 1	0307 000 340
2	Angled plug	NG 12, 90°, Pipe connector 8 x 1	0307 000 220
2	Angled plug	NG 12, 90°, Pipe connector 12 x 1,5	0307 000 230
6	Gasket set for connectors	NG 8	9460 002 310
6	Gasket set for connectors	NG 12	9460 002 311
4	Union bolt	NG 8, M16 x 1.5	0307 000 030
4	Union bolt	NG 12, M22 x 1.5	0307 000 160
1	Threaded compression adapter	NG 8, M16 x 1.5	3800 022 601
1	Straight screw-in coupling	NG 12, M16 x 1.5	0307 000 300
1	Straight screw-in coupling	NG 12, M22 x 1.5	0307 000 240
1	Sealing plug	NG 8	0307 001 990
1	Sealing plug	NG 12	0307 001 980



Assortment case

for VOSS connector system 232, complete

Version	Order number
381-piece	0307 000 145

Contents

Number	Description	Type	Dimensions mm	Order number
4	Straight coupling	232	NG 8, Pipe connector 8 x 1	0307 124 325
4	Straight coupling	232	NG 12, Pipe connector 12 x 1,5	0307 124 330
10	Adapter for units with step drilling	230	NG 6	0307 000 194
4	Straight screw-in coupling	232	NG 8, M16 x 1.5	0307 124 220
4	Straight screw-in coupling	232	NG 12, M16 x 1.5	0307 124 290
4	Straight screw-in coupling	232	NG 12, M22 x 1.5	0307 124 310
20	Union bolt	230	NG 6, M10 x 1	0307 003 300
6	Union bolt	230	NG 8, M16 x 1.5	0307 000 030
6	Union bolt	230	NG 12, M22 x 1.5	0307 000 160
12	Union bolt	232	NG 8, M16 x 1.5	0307 124 700
12	Union bolt	232	NG 12, M22 x 1.5	0307 124 695
10	Straight connector	230	NG 6, Pipe connector 6 x 1	0307 003 430
15	Straight connecting plug	232	NG 8, Pipe connector 8 x 1	0307 124 360
5	Straight connecting plug	232	NG 12, Pipe connector 8 x 1	0307 124 395
9	Straight connecting plug	232	NG 12, Pipe connector 12 x 1,5	0307 124 400
10	Sealing plug	232	NG 8	0307 124 755
3	Sealing plug	232	NG 12	0307 124 760
10	Straight quick-fit coupling	230	Pipe diameter 6	0307 003 060
4	Angled plug	230	NG 6, 90°, Pipe connector 6 x 1	0307 000 055
10	Angled plug	232	NG 8, 90°, Pipe connector 8 x 1	0307 124 945
6	Angled plug	232	NG 12, 90°, Pipe connector 8 x 1	0307 124 970
6	Angled plug	232	NG 12, 90°, Pipe connector 12 x 1,5	0307 124 975
2	Tee plug connector	232	NG 12, Pipe connector 12 x 1,5/8 x 1	0307 124 660
1	Tee plug connector	232	NG 12, Pipe connector 12 x 1,5/12 x 1,5	0307 124 680
30	O-ring, Mud ring	232	NG 8, 7.5 x 2	0307 239 961
30	O-ring, Mud ring	232	NG 12, 12 x 2	0307 449 961
30	O-ring, Sealing ring	232	NG 8, 7 x 1.5	5239 390 055
30	O-ring, Sealing ring	232	NG 12, 12 x 1.6	0307 089 971
30	O-ring, Mud ring	230	NG 6, 5.5 x 1.5	0307 159 972
30	O-ring, Sealing ring	230	NG 6, 3.5 x 1.5	0307 149 971
20	Spring element	230	NG 6, 6.5	0307 062 179
6	Spring element	230	NG 8, 9.7	0307 000 040
6	Spring element	230	NG 12, 15.2	0307 000 170
20	Clamp	230	NG 6, 7.4	0307 016 900
6	Clamp	230	NG 8, 11.6	0307 000 020
6	Clamp for 6 tube	230	NG 12, 17.6	0307 000 150



H4/H1 main headlamp

Vehicle type	Atego I
Version	with high beam, fog and side light
Voltage	24 V

Application range

for vehicles without headlight levelling

Installation side	Order number
left	3600 100 045
right	3600 100 050

Service parts

Description	Order number
Side light/indicator lens, left	3600 100 015
Side light/indicator lens, right	3600 100 025
Reflector, left	3600 321 871
Reflector, right	3600 321 872
H1 halogen headlamp bulb	8900 040 100
H4 halogen headlamp bulb	8900 006 000
Bulb, Drop-shaped, 24 V, 21 W	8900 003 000
Bulb, Drop-shaped, BA 15 s, 24 V, HD version	8900 010 000
Bulb, 24 V, 5 W	8900 040 130



H4/H1 main headlamp

Vehicle type	Atego I
Version	with fog and side light
Voltage	24 V

Application range

for vehicles with headlight range adjustment

Installation side	Order number
left	1100 264 110
right	1100 264 105

Service parts

Description	Order number
Side light/indicator lens, left	3740 009 000
Side light/indicator lens, right	3740 008 999
H1 halogen headlamp bulb	8900 040 100
H4 halogen headlamp bulb	8900 006 000
Glass-base bulb, 24 V, 5 W	8900 040 130
Bulb, Drop-shaped, BA 15 s, 24 V, HD version	8900 010 000

Headlamp adjustment equipment available from EUROPART!



H4/H1 main headlamp

Vehicle type Atego I/II/III
Voltage 24 V

Application range

for vehicles with headlight levelling (electric)

Installation side	Version	Order number
left	with high beam, fog and side light	9468 200 561
right	with high beam, fog and side light	9468 200 661
left	with low beam and high beam	1100 025 440
right	with low beam and high beam	1100 025 435

Service parts

Description	Order number
Side light/indicator lens, left	3740 009 000
Side light/indicator lens, right	3740 008 999
H1 halogen headlamp bulb	8900 040 100
H4 halogen headlamp bulb	8900 006 000
Glass-base bulb, 24 V, 5 W	8900 040 130
Bulb, Drop-shaped, BA 15 s, 24 V, HD version	8900 010 000



H7/H1 main headlamp

Vehicle type Atego I/II/III
Version with high beam and side light
Voltage 24 V

Application range

for vehicles with headlight levelling

Installation side	Order number
left	9581 658 081
right	9581 658 082

Service parts

Description	Order number
H1 halogen headlamp bulb	8900 040 100
H7 halogen headlamp bulb, PX 26 d, 70 W	8900 001 030
Glass-base bulb, 24 V, 5 W	8900 040 130



H7/H1 main headlamp

Vehicle type Atego I/II/III
Version with high beam, fog and side light
Voltage 24 V

Scope of supply
without setting motor

Application range
for vehicles with/without headlight levelling

Installation side

	Order number
left	9581 658 083
right	9581 658 084

Service parts

Description

Description	Order number
H1 halogen headlamp bulb	8900 040 100
H7 halogen headlamp bulb, PX 26 d, 70 W	8900 001 030
Glass-base bulb, 24 V, 5 W	8900 040 130

www.eurolites.it

Via Pietro Nenni, 13
10036 Settimo T.se (Torino - Italy)
Tel. +39 011 2738200 - Fax +39 011 2741197

eurolites

Lighting



H4 main headlamp

Vehicle type	Atego I
Version	with indicator, high beam and side light
Voltage	24 V

Installation side	Application	Order number
left	for vehicles without headlight levelling	3600 100 030
right	for vehicles without headlight levelling	3600 100 040
left	for vehicles with headlight levelling (electric)	3600 100 055
right	for vehicles with headlight levelling (electric)	3600 100 060

Service parts

Description	Order number
Side light/indicator lens, left	3600 100 015
Side light/indicator lens, right	3600 100 025
Reflector, left	3605 321 867
Reflector, right	3605 321 868
H4 halogen headlamp bulb	8900 006 000
Bulb, Drop-shaped, 24 V, 21 W	8900 003 000
Bulb, Drop-shaped, BA 15 s, 24 V, HD version	8900 010 000
Glass-base bulb, 24 V, 5 W	8900 040 130



H4 main headlamp

Vehicle type	Atego I
Voltage	24 V

Application range

for vehicles with headlight levelling (electric)

Installation side	Version	Order number
left	with high beam and side light	9468 204 761
right	with high beam and side light	9468 204 861
left	with indicator and fog light	9468 204 361
right	with indicator and fog light	9468 204 461

Service parts

Description	Order number
Side light/indicator lens, left	3600 100 015
Side light/indicator lens, right	3600 100 025
Reflector, left	3600 321 871
Reflector, right	3600 321 872
H1 halogen headlamp bulb	8900 040 100
H4 halogen headlamp bulb	8900 006 000
Bulb, Drop-shaped, 24 V, 21 W	8900 003 000
Bulb, Drop-shaped, BA 15 s, 24 V, HD version	8900 010 000
Glass-base bulb, 24 V, 5 W	8900 040 130



H3 spotlight

Vehicle type	Atego I
Width	175.3 mm
Height	89 mm
Depth	78 mm
Voltage	12 V

Installation side	Order number
left	3600 100 085
right	3600 100 090

Accessories

H3 halogen headlamp bulb

Voltage	24 V
Power	70 W

Order number
8900 009 000



H3 spotlight

Vehicle type	Atego I
Width	195 mm
Height	103 mm
Depth	98 mm
Voltage	24 V

Installation side	Order number
left	9648 207 656
right	9648 207 756

Accessories

Description

Description	Order number
H3 halogen headlamp bulb, 24 V, 70 W	8900 009 000
Mounting frame, left	9648 261 759
Mounting frame, right	9648 261 859



H3 fog light

Vehicle type	Atego I
Width	175.3 mm
Height	89 mm
Depth	78 mm
Voltage	24 V

Installation side	Order number
left	3600 100 080
right	3600 100 065

Accessories

H3 halogen headlamp bulb

Voltage	24 V
Power	70 W

Order number
8900 009 000



H3 fog light

Vehicle type	Atego I
Width	195 mm
Height	103 mm
Depth	98 mm
Voltage	24 V

Scope of supply

with bulbs

Installation side

	Order number
left	9648 207 856
right	9648 207 956

Accessories

Description

	Order number
H3 halogen headlamp bulb, 24 V, 70 W	8900 009 000
Mounting frame, left	9648 261 759
Mounting frame, right	9648 261 859

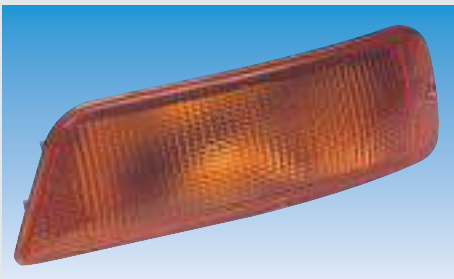

Indicator light

Vehicle type	Atego I
Installation location	front
Bulb type	P21W
Voltage	24 V
Colour	yellow

Scope of supply

with bulb

Installation side

	Order number
left	9468 200 121
right	9468 200 221

Accessories

Bulb

Power	21 W
Voltage	24 V

Order number
8900 003 000



Indicator light

Vehicle type	Atego I
Installation location	front
Voltage	24 V
Colour	yellow

Installation side

	Order number
left	9468 200 021
right	9460 820 012

Accessories

Bulb

Power	21 W
Voltage	24 V

Order number
8900 003 000



Indicator light

Vehicle type	Atego II/III
Installation location	front
Socket	BAU 15 s
Voltage	24 V
Colour	transparent

Installation side	Order number
left	9260 001 056
right	0247 016 041

Accessories

Bulb

Power	21 W
Voltage	24 V
Colour	yellow

Order number
9560 013 496

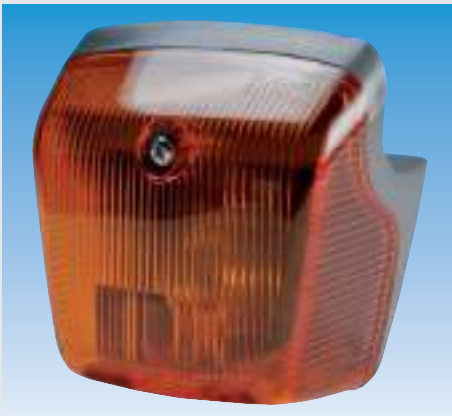

Indicator light

Vehicle type	Atego I/II/III
Installation location	front
Voltage	24 V
Colour	yellow

Installation side	Order number
left	9507 006 700
right	9507 006 800

Accessories

Bulb

Power	21 W
Voltage	24 V

Order number
8900 003 000



Auxiliary flasher light

Vehicle type	Atego I
Version	with side marker light
Installation location	front
Installation side	left/right
Depth	80 mm
External diameter	80 mm
Bulb type	P21/5W
Voltage	24 V
Colour	yellow

Scope of supply

Bulb and cable

Order number
9468 201 021

Accessories

Description	Order number
Bulb for indicator, brake, rear fog, reversing lights, 24 V, 21 W	8900 003 000
Bulb for brake/tail light, 24 V, 21/5 W	8900 013 000
Bulb socket	9460 463 655



Auxiliary flasher light

Vehicle type	Atego I/II/III
Installation location	wheel housing
Installation side	left/right, at the side
Colour	orange
Voltage	24 V

Application

BM: 666.000/030/100/130/200/230

Order number
9648 200 021

Accessories

Description	Order number
Bulb for indicator, brake, rear fog, reversing lights, 24 V, 21 W	8900 003 000
Bulb for brake/tail light, 24 V, 21/5 W	8900 013 000
Bulb socket	9460 463 655



Position light

Vehicle type	Atego I/II/III
Installation location	at the side
Voltage	24 V

Installation side	Colour	Order number
left, top	white	1325 463 496
right, top	white	1325 463 497
left, top	yellow	9501 243 334
right, top	yellow	9501 243 336

Accessories

Bulb

Voltage	24 V
Power	10 W

Order number
8900 002 000



LED side marker light

Vehicle type	Atego I/II/III
Installation side	left, right
Voltage	24 V
Colour	yellow

Version	Order number
with connector, 2-pin	8000 463 509
with 0.5 m cable, 90° cable connection, reverse light	9505 940 112

Accessories

Description	Order number
Connector set	9465 401 581



Side marker light

Vehicle type	Atego I/II/III
Version	with reflector, without seal
Installation side	left/right
Width	41 mm
Height	110 mm
Depth	35,2 mm
Voltage	24 V
Fastening	2 x 5.2 mm
Distance between centres	75 mm
Colour	yellow

Order number
9465 444 111

Accessories

Description	Order number
Glass-base bulb, 24 V, 3 W	3610 002 841
Lamp holder with diaphragm ventilation	9641 520 337
Contact carrier	9463 303 870
Plug housing, AMP, 2-pin	9501 245 102
Plug housing, AMP, 2-pin, handle on housing	9501 002 420
Cable grommet, straight	9501 002 248
Cable grommet, 90° angle	9501 002 249



Clearance light

Rear-Logic

Vehicle type	Atego I/II/III
Width	42 mm
Height	109.3 mm
Depth	56,2 mm
Voltage	12/24 V
Type	surface-mounting
Colour	white/red/amber

Installation side	Order number
left	0007 841 011
right	0007 841 021

Accessories

Description	Order number
Bulb, spherical, 24 V, 10 W	8900 002 000
Lens, yellow	0146 838 001
Lens, black	0148 673 021



PROPLAST
FARBSTREIFENLEUCHTUNG

Rear light

Vehicle type	Atego I/II/III
Voltage	24 V
Colour	red/white/amber

Installation side	Version	Order number
left	with licence plate light	9565 445 603
right	without licence plate light	9465 445 703

Service parts

Description	Order number
Lens	9198 100 695
Lens for side marker light	0146 838 001
Bulb for indicator, brake, rear fog, reversing lights, 24 V, 21 W	8900 003 000
Bulb for tail, licence plate, position and interior lights, 24 V, 10 W	8900 002 000
Repair kit for connector, 8-pin	8840 203 024



PROPLAST
FARBSTREIFENLEUCHTUNG

Rear light

Vehicle type	Atego I/II/III
Width	340 mm
Height	130 mm
Voltage	24 V
Connection	Schlemmer connector
Colour	red/white/amber

Installation side	Version	Order number
left	with indicator, stop, licence plate, rear fog, reversing light and tail light, with reflector	8840 203 130
left/right	with indicator, stop, tail, rear fog and reversing light, with reflector	8840 203 128

Service parts

Description	Order number
Lens, left/right	8840 203 126
Bulb for indicator, brake, rear fog, reversing lights, 24 V, 21 W	8900 003 000
Bulb for tail, licence plate, position and interior lights, 24 V, 10 W	8900 002 000
Repair kit for connector, 8-pin	8840 203 024



PROPLAST
FAHRZEUGELEKTROTECHNIK

Rear light

Vehicle type	Atego I
Width	425 mm
Height	110 mm
Depth	82 mm
Socket	BA15s/P21W/R10W
Voltage	12/24 V
Connection	Cable grommet
Fastening	2 x M8
Pin spacing	152 mm

Installation side	Version	Order number
left	with indicator, brake, tail and rear fog light, reflector	4300 218 011
right	with indicator, brake, tail and reversing light, reflector	4300 218 012
left	with indicator, brake, tail, rear fog and number plate light, reflector	8840 218 013
right	with indicator, brake, tail and rear fog light, reflector	8840 218 014

Service parts

Version	Order number
Lens, left/right, with rear fog light	4300 218 111
Lens, left/right, with reversing light	4300 218 112
Bulb, for indicator, brake, rear fog, reversing lights, 24 V, 21 W	8900 003 000
Bulb, for tail, licence plate, position and interior lights, 24 V, 10 W	8900 002 000
Nozzle	0141 941 001



PROPLAST
FAHRZEUGELEKTROTECHNIK

Rear light

Vehicle type	Atego I/II/III
Width	139 mm
Height	525 mm
Depth	84,5 mm
Socket	BA 15 s
Voltage	24 V
Connection	Round connector
Fastening	horizontal

Installation side	Version	Order number
left	with indicator, brake, tail, rear fog, reversing, number plate, clearance and side marker light, reflector	8840 220 203
right	with indicator, stop, tail, rear fog, reversing, clearance and side marker light, reflector	8840 220 202

Service parts

Version	Order number
Lens, left, with rear fog, indicator, stop, reversing and taillight	1040 000 009
Lens, right, with indicator, stop, reversing, taillight	1040 000 010
Bulb for indicator, brake, rear fog, reversing lights, 24 V, 21 W	8900 003 000
Bulb for tail, licence plate, position and interior lights, 24 V, 10 W	8900 002 000



H1 rotating beacon

Version	Halogen
Type	surface-mounting
Voltage	24 V
Dimensions	155 x 194 mm
Colour	yellow

Scope of supply
with bulb

Order number
0008 061 111

Accessories

Base

Material	Rubber
Diameter	155 mm

Form	Order number
flat	0862 164 001
wedge-shaped	8000 005 762

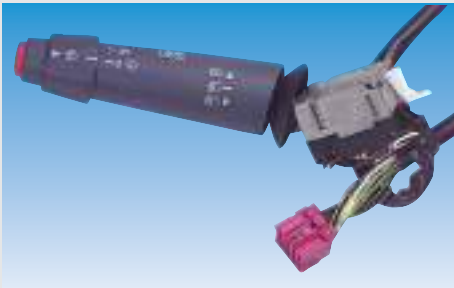

Indicator switch

Vehicle type	Atego I/II/III
Installation side	left
Voltage	24 V
Cable length	560 mm

Order number
9465 453 125

Pressure switch

Vehicle type	Atego I/II/III
Voltage	24 V

Installation location	Switching pressure bar	Order number
Brake circuit III/IV	5,5	9465 455 414
Rear axle	6,5	6170 463 109



Window winder electric, with motor

Vehicle type	Atego I/II/III
--------------	----------------

Installation side	Order number
left	5828 722 346
right	1325 063 373



Starter Motor

Vehicle type	Atego I/II/III
Voltage	24 V
Power	6.2 kW
Number of teeth	11
Flange	3-hole flange
Flange diameter	92 mm

Order number
7063 002 370



Starter Motor

Vehicle type	Atego I/II
Version	with cover
Voltage	24 V
Power	4 kW
Number of teeth	9
Flange	3-hole
Flange diameter	89 mm

Order number
7063 000 215



Starter Motor

with reduction gear

Vehicle type	Atego I/II/III
Voltage	24 V
Power	7.5 kW
Number of teeth	12
Flange	3-hole
Flange diameter	92 mm

Order number
9461 511 501



Alternator

Vehicle type	Atego I/II/III
Version	with belt pulley
Pulley diameter	77 mm
Voltage	28 V
Charging current	80 A
Flange	3-hole flange

Order number
7063 001 032

**EURO
PART**
Alternator

Vehicle type	Atego I/II/III
Version	with belt pulley
Pulley diameter	72 mm
Voltage	24 V
Charging current	80 A
Flange	3-hole flange

Order number
 7063 001 031

3

Atego

**EURO
PART**
Alternator

Vehicle type	Atego I
Version	without belt pulley
Voltage	28 V
Charging current	80 A
Flange	3-hole flange

Order number
 7063 001 030

**EURO
PART**
Alternator

Vehicle type	Atego I/II/III
Version	without belt pulley
Voltage	28 V
Charging current	80 A
Flange	3-hole flange

Order number
 7063 000 003

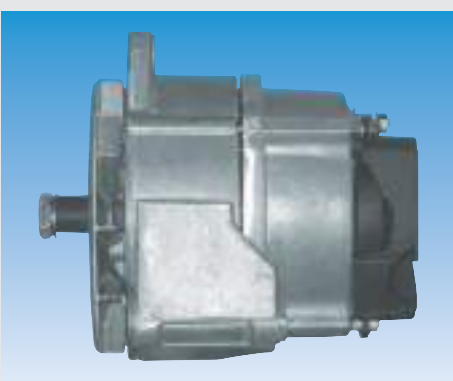
Alternator

Vehicle type	Atego I/II/III
Version	with belt pulley
Pulley diameter	77 mm
Voltage	24 V
Charging current	100 A
Flange	3-hole

Order number
 5240 860 563



Alternator

Vehicle type	Atego I/II/III
Version	without pulley
Voltage	24 V
Charging current	110 A
Flange	3-hole

Order number
5240 860 807

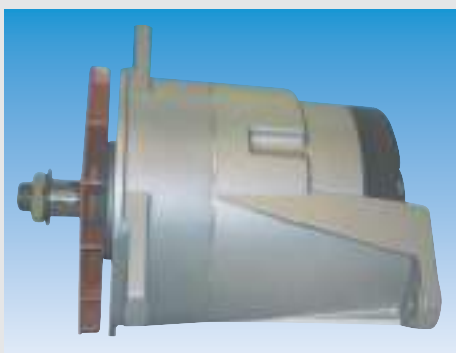

Alternator

Vehicle type	Atego I/II/III
Version	right stop, without pulley
Voltage	24 V
Charging current	140 A
Flange	2-hole

Order number
1902 533 300

Wheel Bearing Repair easily!



The vehicle manufacturers Mercedes Benz and Volkswagen offer repair kits for the replacing of the wheel bearing for the Mercedes Benz Sprinter type 906 or Volkswagen Crafter type 2E/2F a complete knuckle with pre-mounted wheel bearing unit.

This repairing method makes an additional axle alignment necessary.

EUROPART offers for these vehicles a wheel bearing repair solution, where the knuckle remains installed in the car:

Order number 6950 668 010 for axle load > 1850 kg and

Order number 6950 668 011 for axle load <1850 kg

The wheel bearing unit is renewed professionally with the help of these special tools:

Order number 9500 004 150 including hydraulic cylinder or

Order number 9500 041 500 without hydraulic cylinder, if it already exists

This is eliminating the need for axle alignment.

Repair with the vehicle manufacturers method:

1. Vehicle comes into the workshop
2. Wheel, brake pads, brake caliper and brake disk removed
3. All connections to axle bracket removed
4. Axle bracket removed
5. Axle bracket reinstalled
6. All connections to axle bracket reassembled
7. Brake caliper, brake pads, brake disk and wheel reinstalled
8. Test for the axle alignment
9. Axle geometries readjusted
10. Test drive

Repair with special tool and wheel bearing unit:

1. Vehicle comes into the workshop
2. Wheel, brake pads, brake caliper and brake disk removed
3. Use the special tool for wheel bearing removal and installation
4. Brake caliper, brake pads, brake disk and wheel reinstalled
5. Test drive

Depending on the vehicle 60 % of the repair time can be reduced.



Front grille

Vehicle type Atego I

Order number
9468 840 185



Front grille

Vehicle type Atego II

Order number
(on request) 9468 800 585

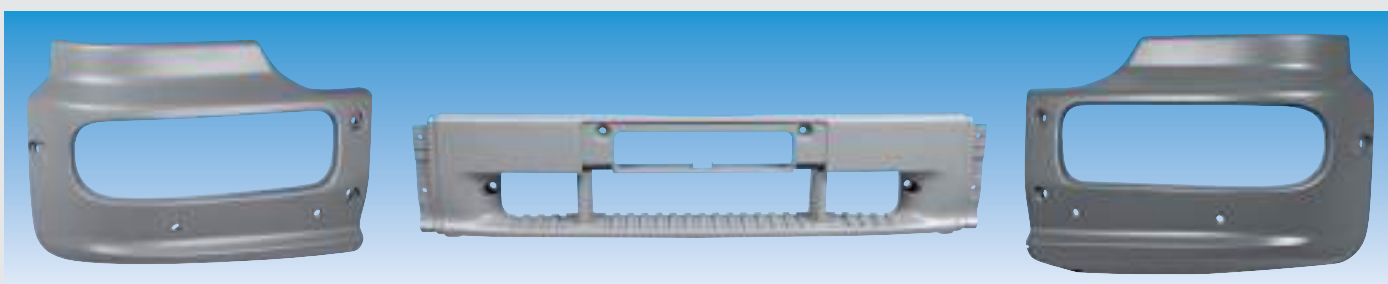

Impact corner

Vehicle type Atego I/II/III
Colour grey

Installation side	Order number
left	9190 000 512
centre	9190 000 500
right	9190 000 510

Accessories

Bumper bracket

Installation side	Order number
left	9460 253 439
right	9460 253 539

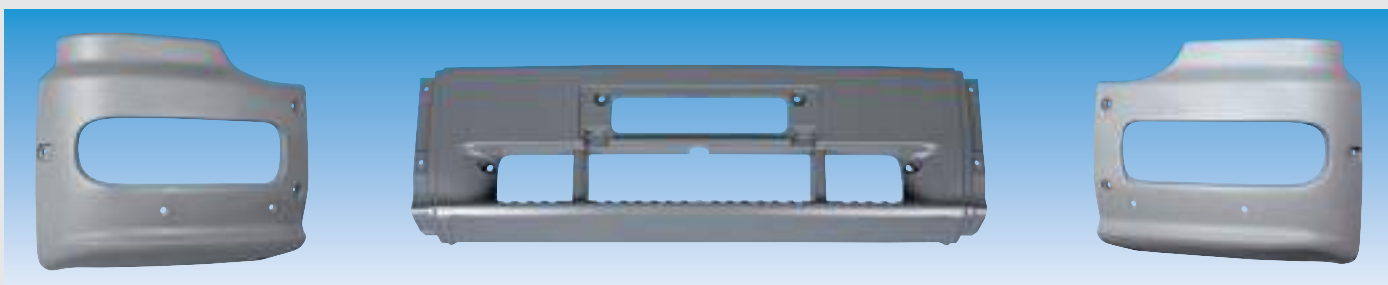

Impact corner

Vehicle type Atego I/II/III
Version high, for the cab with 2-stage entry
Colour grey

Installation side	Order number
left	9190 800 104
centre	9190 801 170
right	9190 800 105

Accessories

Bumper bracket

Installation side	Order number
left	9460 253 439
right	9460 253 539

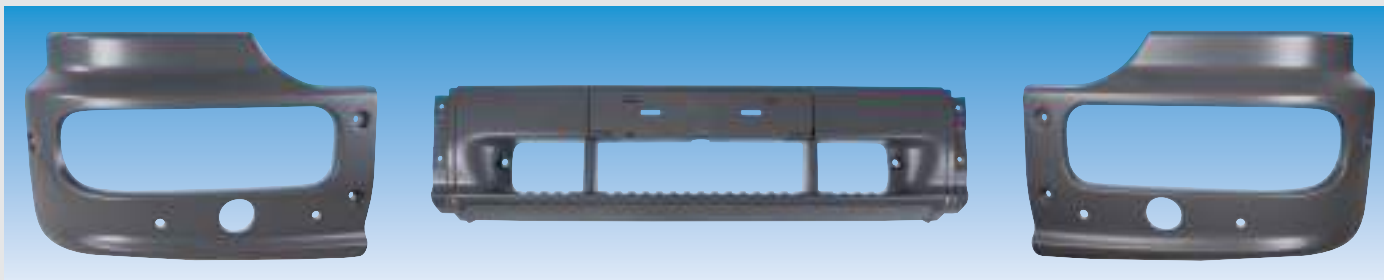

Bumper

Vehicle type	Atego II/III
Version	with cutout for headlight cleaning system
Colour	grey

Installation side		Order number
left	(on request)	9463 880 127
centre	(on request)	9468 804 470
right	(on request)	9463 880 137

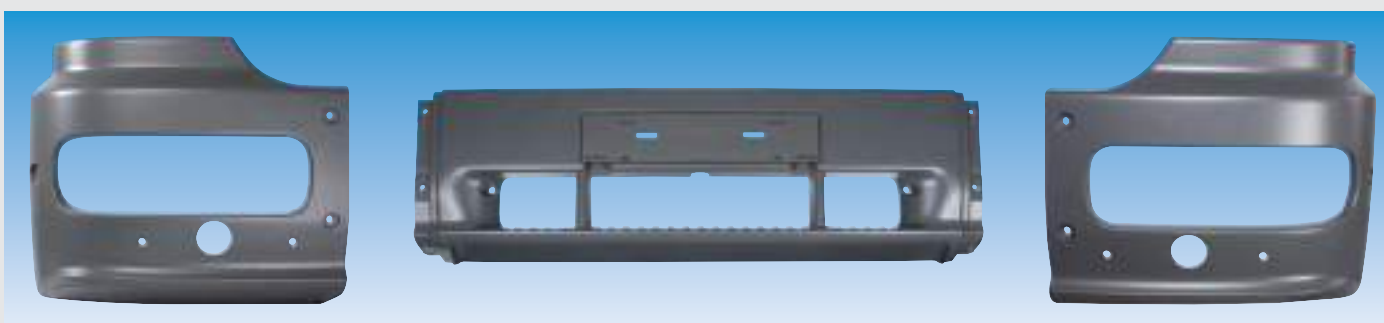

Bumper

Vehicle type	Atego II/III
Version	high, for driver's cab with 2-step entry, with cut-out for headlight cleaning system
Installation location	front
Colour	grey

Installation side		Order number
left	(on request)	9468 801 870
centre	(on request)	9468 805 170
right	(on request)	9468 801 970



Entry

for driver cab

Vehicle type	Atego I (18 t-)
Version	2-level
Installation location	bottom
Colour	grey

Installation side	Order number
left	9460 660 010
right	9460 660 020

Accessories

Step-up

Installation side	Order number
left/right, top	9466 660 128
left/right, bottom	9466 660 428

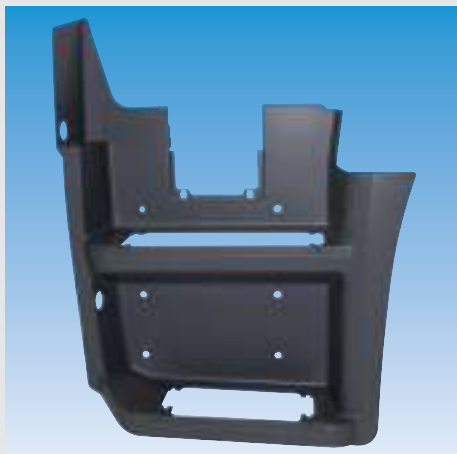

Entry

for driver cab

Vehicle type	Atego I
Version	2-stage
Installation location	bottom
Colour	grey

Installation side	Order number
left	9466 602 101
right	9466 602 201



Entry

with wing

Vehicle type	Atego I/II/III
Version	1-step, wide with torsion bar
Installation location	at the side
Colour	grey

Installation side	Order number
left	9196 662 501
right	9196 662 901

Accessories

Step-up

	Order number
	9466 660 428



Entry

with wing

Vehicle type	Atego I/II/III
Version	2-step, narrow with torsion bar
Installation location	at the side
Colour	grey

Installation side	Order number
left	9190 663 301
right	9190 663 601

Accessories

Step-up

Installation side	Order number
left/right, top	9466 661 428
left, bottom	9466 661 528
right, bottom	9466 661 628



Entry

with wing

Vehicle type	Atego I/II/III
Installation location	at the side
Colour	grey

Installation side	Version	Order number
left	2-step, wide with torsion bar	9190 663 101
right	2-step, wide with torsion bar	9466 663 501
right	2-step, wide	9190 663 201

Accessories

Step-up

Installation side	Order number
left/right, top	9466 661 428
left, bottom	9466 661 528
right, bottom	9466 661 628

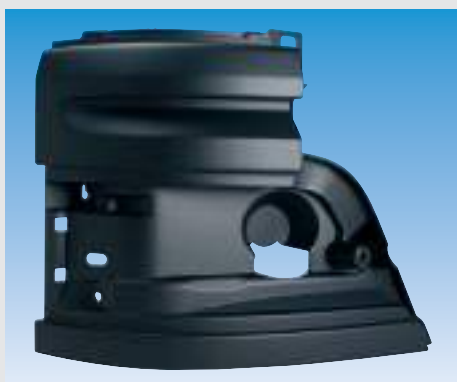

Air deflector

for A-pillar

Vehicle type	Atego I
--------------	---------

Installation side	VIN	Order number
left	-K 567741	(on request) 9460 884 012
right	-K 567741	(on request) 9460 884 022
left	K 567742-	(on request) 9460 880 034
right	K 567742-	(on request) 9460 880 044

Corner plate

for A-pillar

Vehicle type	Atego I
--------------	---------

Installation side	Order number
left	9460 840 123
right	9460 840 223



Corner plate

for A-pillar

Vehicle type Atego II/III

Installation side		Order number
left	(on request)	9468 840 022
right	(on request)	9468 840 122

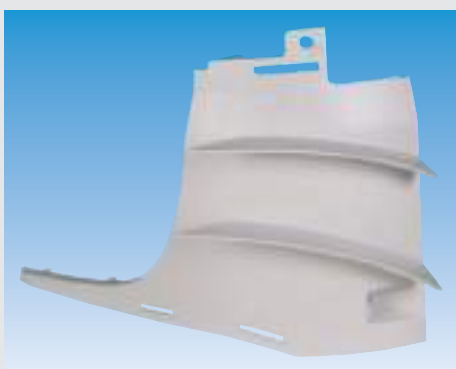

Air deflector

for A-pillar

Vehicle type Atego II/III

Installation side		Order number
left		9463 884 042
right		9468 840 522

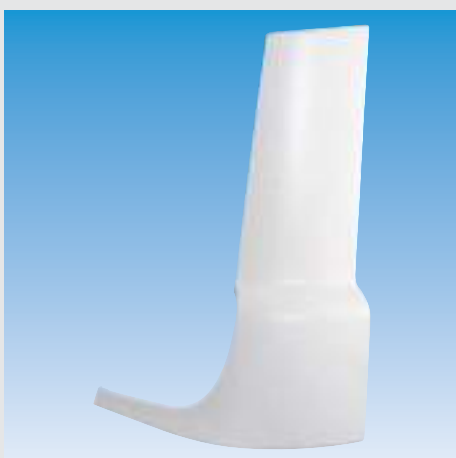

Cover

for deflector, A-pillar

Vehicle type Atego II/III

Installation side		Order number
left	(on request)	9468 840 222
right		9468 840 322



Wing

Version high, cover on cab, narrow

Installation location front axle, rear

Installation side left/right

	Order number
	9465 212 801



Wing

Installation location rear axle, front, rear
 Installation side left/right
 Colour grey

Illustration	suitable for		Order number
1	base frame height 180 mm	(on request)	9465 220 501
2	wing, wide	(on request)	9465 221 101
3	base frame height 130/180 mm	(on request)	9465 220 001

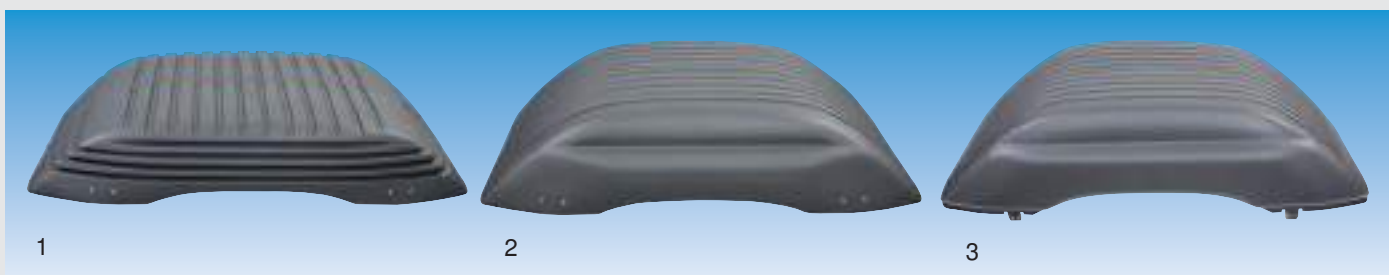

Wing

Installation location Rear axle, top
 Installation side left/right

Illustration	suitable for		Order number
1	base frame height 130 mm	(on request)	9465 220 502
2	base frame height 180 mm	(on request)	9465 220 402
3	wing, wide	(on request)	9465 220 702



Windscreen

Vehicle type	Atego I/II	
Colour		Order number
clear		9115 900 002
green tinted		9115 730 941

Accessories

Sealing frame

Vehicle type		Order number
Atego I/II		9115 721 937
Atego I		9115 740 322



Sunshade

for driver's cab

Vehicle type	Atego I	
Driver cab	with low roof	
Version	without windscreen cut-out, with bracket	
Material	acrylic glass	
Colour	antracite	
		Order number
		9195 120 000



Sunshade

for driver's cab

Vehicle type	Atego II	
Driver cab	with low roof	
Version	with windscreen cut-out, with bracket	
Material	acrylic glass	
Colour	antracite	
		Order number
		9190 043 040



Sunshade

for driver's cab

Vehicle type	Atego II	
Driver cab	with low roof	
Version	without windscreen cut-out, with bracket	
Material	acrylic glass	
Colour	antracite	
		Order number
		9190 430 420

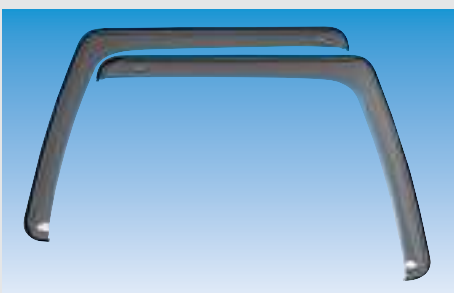

Side window wind deflector

made of smoke-coloured plexiglass, no draught, less window soiling

Vehicle type	Atego I/II	
Version	screw attachment	
Installation side	left/right	
		Order number
		9199 046 017

**EURO
PART**

Wiper blade

with 3 adapters

Vehicle type	Atego I/II
Length	650 mm

Order number
7257 002 100

Washer fluid pump

Vehicle type	Atego I/II
Version	Dual pump with 3 connections
Voltage	24 V

Order number
6170 461 883

Wiper motor

Vehicle type	Atego I/II
Installation location	front
Voltage	24 V

Order number
3870 404 398

MEKRA

Mirror head

for main mirror

Vehicle type	Atego I
Installation side	left/right
Model year	-2004
Length	380 mm
Width	170 mm
Depth	68 mm

Scope of supply
without glass unit

Version

heated, manual adjustment	9113 752 147
heated, electric adjustment	9113 752 167

Order number
Accessories
Description

Glass unit, Curve radius 1800 mm	9113 752 470
Retaining element with cover	2110 000 285

Order number

3

Atego



Main mirror

Vehicle type	Atego II/III
Model year	2004-
Width	219 mm
Depth	124 mm

Scope of supply
complete

mirror complies with ordinance 2003/97/EU or 2007/38/EU

Version	Installation side	Order number
heated, manual adjustment	left	9115 751 147
heated, manual adjustment	right	9115 752 147
heated, electric adjustment	left	0915 751 167
heated, electric adjustment	right	9115 752 167

Service parts

Description	Order number
Glass unit, Curve radius 1200 mm, Model year -06/2010	9115 750 840
Glass unit, Curve radius 1200 mm, Model year 07/2010-	9111 011 099
Retaining element with cover	9115 750 100

Accessories

Description	Order number
Adapter cable, Model year -06/2010	9110 220 099

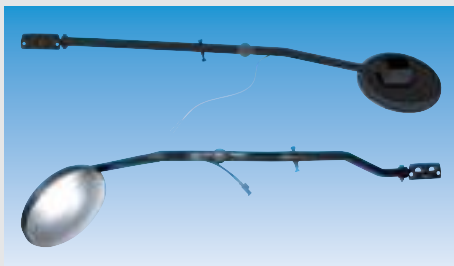

Front mirror

Version	heated, manual adjustment
Installation side	right
Diameter	250 mm

Scope of supply
with retaining element

mirror complies with ordinance 2003/97/EU or 2007/38/EU

Vehicle type	Length mm	Width mm	Order number
Atego I	1261	303	9113 962 210
Atego II/III	1145	265	9113 964 210

Service parts

Description	Order number
Glass unit heated, Curve radius 300 mm	9113 961 174
Mirror head heated, manual adjustment	9113 960 148



Front mirror

Vehicle type	Atego II/III
Installation side	right

Version	Order number
for high roof	9468 107 316
for low roof	9468 107 516

Service parts

Description	Order number
Mirror glass	9468 112 333
Mirror housing	9468 101 979



Reflecting your visions.



MEKRA
LANG



Wide angle mirror

Vehicle type	Atego I/II
Version	heated, manual adjustment
Installation side	left/right
Model year	-2004
Width	200 mm

Scope of supply
complete

mirror complies with ordinance 2003/97/EU or 2007/38/EU

Order number
9113 773 147

Service parts

Description	Order number
Glass unit, Curve radius 300 mm	9113 771 174
Retaining element with cover	2110 000 285



Wide angle mirror

Vehicle type	Atego II/III
Version	heated, manual adjustment
Installation side	left/right
Model year	2004-
Width	199 mm
Depth	116 mm
Curve radius	300 mm

Scope of supply
complete

mirror complies with ordinance 2003/97/EU or 2007/38/EU

Order number
9115 770 147

Service parts

Description	Order number
Glass unit, Curve radius 300 mm, Model year -06/2010	9115 770 870
Glass unit, Curve radius 300 mm, Model year 07/2010-	9110 311 099

Accessories

Description	Order number
Adapter cable, Model year -06/2010	9110 220 099
Retaining element with cover	9115 750 100



Ramp mirror

Vehicle type	Atego II/III
Version	unheated, manual adjustment
Installation side	right/left
Model year	2004-
Width	255 mm
Depth	98 mm

Scope of supply

complete

Order number

9114 001 099

Service parts

Description

Glass unit, Curve radius 300 mm

Order number

9115 791 470



Mounting bracket, outside mirror

Vehicle type	Atego I
Colour	black
Model year	-2004
Length	639 mm
Width	325 mm
Diameter	28 mm

Installation side

left	9113 752 100
right	9113 752 200

Accessories

Cover

Installation side

left	9111 037 065
right	9111 037 066

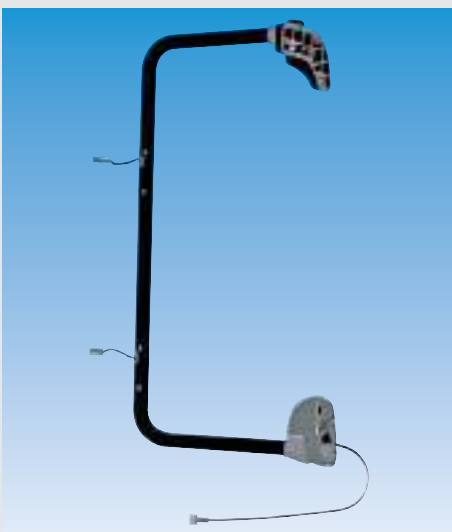

Vehicle type	Atego II
Colour	black
Model year	2004-06/2010
Length	795 mm
Width	376 mm
Diameter	28 mm

Installation side

left	9115 752 100
right	9111 037 046

Vehicle type	Atego II/III
Colour	black
Model year	07/2010-
Length	795 mm
Width	322 mm
Diameter	28 mm

Installation side

left	9110 012 099
right	9110 005 099



Air-conditioning compressor

Vehicle type Atego I/II/III
Voltage 24 V

Illustration	Type	Pulley Ø mm	Number of ribs	Order number
1	7SBU16C	130	11	0351 176 531
2	7SBU16C	135	9	9100 851 061
-	10PA15C	130	8	9462 300 111



Air-conditioning compressor

Vehicle type Atego I/II/III
Type 10PA15C
Pulley diameter 129 mm
Number of ribs 9
Voltage 24 V

Order number
9100 852 050

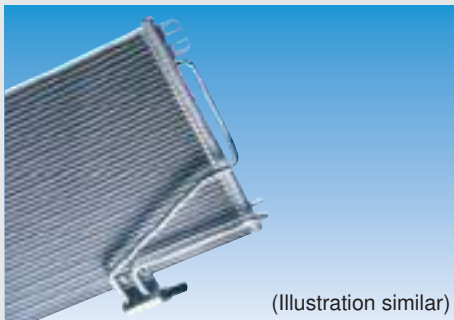

Condenser for air-conditioning systems

Vehicle type Atego I/II/III
Version without dryer
Length 500 mm
Width 537 mm
Depth 16 mm

Order number
9100 135 500



Blower for heating

Vehicle type Atego I/II/III
Voltage 24 V

Order number
0009 157 461

Accessories

Description	Order number
Electrical ballast, 24 V	9261 029 381



Filter dryer
for air-conditioning system

Vehicle type Atego I/II/III
Version with bracket
Diameter 53 mm
Length 290 mm

Order number
0351 197 441



Filter dryer
for air-conditioning system

Vehicle type Atego I/II/III
Version with bracket
Diameter 64 mm

Motor type	Length mm	Order number
OM 904 LA	200	0351 198 551
OM 906 LA	210	0351 197 471



Expansion valve
for air-conditioning system

Vehicle type Atego I/II/III

Order number
0351 239 381

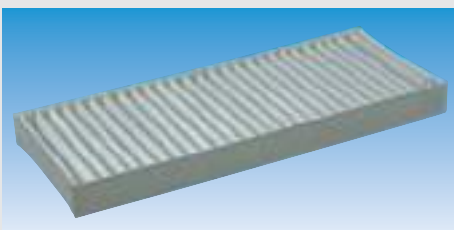

(Illustration similar)



Cabin filter

Vehicle type Atego I/II/III
Length 380.7 mm
Width 134 mm
Height 37.5 mm

Order number
9020 038 690

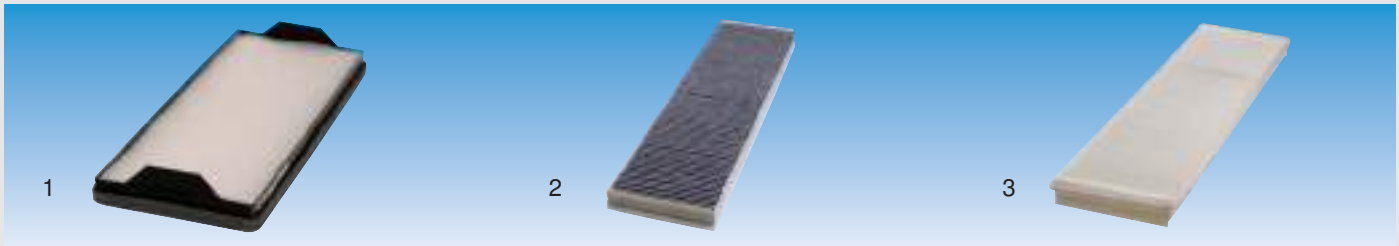

Cabin filter/pollen filter

Illustration	Vehicle type	Length mm	Width mm	Height mm	Order number
1	Atego I	451	193	56	9750 103 232
2	Atego I/II/III	582	168	38	9750 104 007
3	Atego I/II/III	579	163	38	9750 104 040

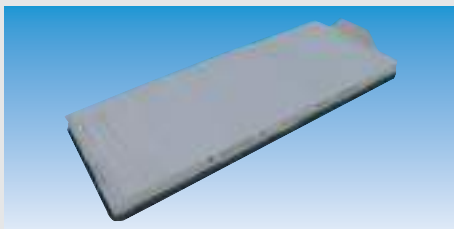

Cabin filter

Vehicle type Atego I
 Length 454 mm
 Width 190 mm
 Height 56 mm

Order number
 9020 000 526

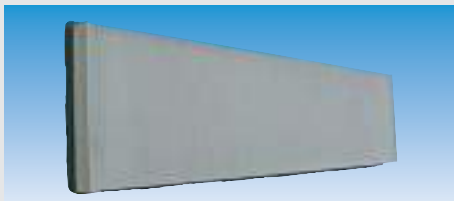

Cabin filter

Vehicle type Atego I/II/III
 Length 579 mm
 Width 163 mm
 Height 38 mm

Order number
 9020 000 514



Roof-mounted air-conditioning system for truck

CoolAir CA 850S, for stationary operation

extraordinary cooling performance and additional air dehumidification, pleasant climate, independently of the external climatic conditions, can also be operated when the vehicle is moving, simple installation

Refrigerant R134a
 Cooling capacity 1000 W (compressor capacity), 850 W (following ISO 5151)
 Dimensions of roof unit (W x H x D) 830 x 159 x 635 mm

Input voltage 24 V DC
 Current consumption 12-18 A
 Colour white
 Weight 22 kg

Scope of supply

Remote control, battery cable, operating instructions

Order number
 1880 000 027

Accessories

Description	Order number
Assembly set	1880 000 033
Protective hood CoolAir	1880 000 040



Truck driver's seat

6860/875 NTS

Full height adjustment with memory function, built-in 3-point safety belt system with belt pretensioner, seat back adjustment, shoulder adjustment, lean and horizontal settings, adjustable vertical movement damper, adjustable cushion depth, integrated pneumatic system (IPS) for adjustment of backrest to individual body contour (lumbar support and adjustable side support, rapid lowering, horizontally sprung, grey/anthracite seat covering with fine silver coloured stripes

Vehicle type Atego I
Version can be operated from the left, with seat heating and console
Suspension pneumatic
Track width 230 mm

Arm rests must be ordered separately.

Order number
9368 894 501

Accessories

Arm rest

Installation side	Order number
left	9369 296 511
right	9369 296 521



Truck driver's seat

Kingman High Performance Comfort

spring deflection 70 mm, height adjustment 100 mm, integrated head rest, length adjustment, longitudinal horizontal suspension, pneumatic lumbar support, neck pillow with exchangeable cover, backrest setting, integrated 3-point restraint system with adjustable belt tongue, tapered back contour, quick lowering, side contour adjustment, 2-level seat heating, seat cushion depth setting, seat angle setting, adjustable shock absorbers

Vehicle type Atego I/II/III
Width 545 mm
Depth 630 mm
Track width 230 mm
Suspension pneumatic

For vehicles without an airbag!
Illustration shows special equipment!
Arm rests must be ordered separately.

Order number
9360 150 311



Accessories

Arm rest

Installation side	Order number
left	9361 029 136
right	9361 029 137



Truck driver's seat

Kingman High Performance Standard

spring deflection 70 mm, height adjustment 100 mm, built-in headrest, length adjustment, longitudinal horizontal suspension, pneumatic lumbar support, backrest setting, built-in 3-point restraint system with adjustable belt, rejuvenated back contour, quick lowering, side contour adjustment, seat angle adjustment, adjustable shock absorber

Vehicle type	Atego I/II
Width	545 mm
Depth	630 mm
Track width	230 mm
Suspension	pneumatic

For vehicles without an airbag!
Illustration shows special equipment!
Arm rests must be ordered separately.

Order number
9361 503 100



Accessories

Arm rest

Installation side	Order number
left	9361 029 136
right	9361 029 137



Pedal pad

Vehicle type	Atego I/II/III
Thickness	13 mm

Version	Length mm	Width mm	Order number
for clutch pedal	70	64/49	9080 001 104
for brake pedal	69.5	63/47	9080 001 105

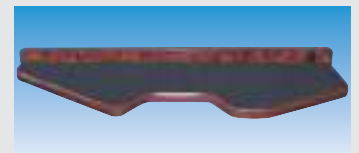

Filing table

with anti-slip mat

Installation side centre

Colour	Order number
black	9510 210 251
Root wood finish	1002 010 252

Filing table

with anti-slip mat

Vehicle type Atego II
 Installation side centre

Colour	Order number
black	1002 010 253
Root wood finish	1002 010 254



Shock absorber

Vehicle type Atego I/II/III
Fastening Eye/eye

Version	Installation location	Order number
Oil pressure, twin-tube	Front axle	9201 316 760
gas pressure, twin-tube system	rear axle	9202 902 510



Shock absorber

Super Touring

Vehicle type Atego I
Version Gas pressure, twin-tube
Fastening eye/eye
Installation location Front axle

Order number
9202 902 680



Shock absorber

Super Touring

Vehicle type Atego I/II/III
Version Gas pressure, single-tube
Fastening Eye/eye
Installation location Rear axle

Order number
9750 290 995



Shock absorber

Super Touring

Vehicle type Atego I/II/III
Version Oil pressure, twin-tube
Fastening Pin/plate
Installation location Rear axle

Order number
9201 351 800



Driver cab tilting pump

Vehicle type Atego I/II/III

Order number
9465 530 001

Comparative number
Mercedes-Benz 001 553 00 01

(Illustration similar)



Skirting protection bracket

with TÜV approval

Version	Standard
Material	Stainless steel
Surface	high-gloss polished

Order number

1002 021 216



Headlight bracket

with clamps

Driver cab	flat roof
Version	for 3 headlights
Material	Stainless steel
Surface	high-gloss polished

Scope of supply

without headlights

Order number

1002 003 009



H1 spotlight

Rallye 3003

Version	Halogen, with LED position light
Installation side	left, right
Colour	clear
Voltage	12/24 V

Scope of supply

with LEDs

Order number

0009 797 431



H1 spotlight

Luminator-Chromium CELIS®

Version	Halogen, with CELIS® position light
Installation side	left/right
Colour	clear
Voltage	12/24 V

Order number

0007 560 211



Fastening clamp

for headlight

for mounting on the impact protection of light bar

Material Stainless steel

Ø mm	Order number
60	9150 001 430
76	1002 001 431



LED position lights set

Delivery only including installation in impact protection or headlight bar

Colour white

Version	Order number
3 piece set	1002 045 003
5 piece set	1002 045 005
7 piece set	1002 045 007

Technical equipment and accessories

4



Attachments	314-317
Universal truck styling.....	318-323
On-board equipment.....	324-327
Starter batteries	328
Bulbs	330-332
Warning markers	333-335
Emergency equipment.....	336-338
Special tools	339-349
Diagnosis, maintenance and repair devices.....	350-365
Chemical products	366-375



Fifth wheel

with extended handle and rubber joint bearing

Fastener	2"
Vertical load on the fifth wheel	20 t
D-value	152 kN

Type	Height mm	Order number
JSK 37 C150 ZJ	150	3001 008 180
JSK 37 C185 ZJ	185	3001 008 186

Service parts

Description	Order number
Repair kit for lock	3050 322 151
Repair kit for mounting	3050 212 160



Fifth wheel

with sliding discs and LubeTronic

Fastener	2"
Vertical load on the fifth wheel	20 t
D-value	152 kN

Type	Height mm	Order number
JSK 37 C0 20 87 AA	150	3001 372 087
JSK 37 C0 38 87 AA	185	3001 373 887

Service parts

Description	Order number
Repair kit for lock	3050 312 160
Repair kit for mounting	3050 212 160
Slide pad set	3053 106 003



Fifth wheel

with plain bearings

Fastener	2"
Vertical load on the fifth wheel	20 t
D-value	152 kN

Type	Height mm	Order number
JSK 42 K0 20 35 AA	150	3001 008 385
JSK 42 K0 38 35 AA	185	3001 008 387

Service parts

Description	Order number
Repair kit for lock	3001 100 619
Repair kit for mounting	3001 370 220



Fifth wheel

with sliding discs and LubeTronic

Fastener	2"
Vertical load on the fifth wheel	20 t
D-value	152 kN

Type	Height mm	Order number
JSK 42 K0 20 87 AA	150	3001 422 087
JSK 42 K0 38 87 AA	185	3001 008 409

Service parts

Description	Order number
Repair kit for lock	3001 100 619
Repair kit for mounting	3001 370 220
Slide pad set	3001 100 702

JOST

Sicherheit

durch Sensoren

Die sensierte Sattelkupplung

Jetzt im neuen ACTROS

Fahrer-Assistenzsysteme machen die Arbeit einfacher und helfen Unfälle zu vermeiden. So wie die sensierte Sattelkupplung von JOST, die mit drei Sensoren ausgestattet ist.

- Eine Fernanzeige verarbeitet die Signale der Sensoren und zeigt den Verschlusszustand im Fahrerhaus an.
- Zusätzliche Verschlusskontrolle und erhöhte Sicherheit ist durch die optische und akustische Anzeige im Fahrerhaus auch bei schlechten Sichtverhältnissen gewährleistet.



Weitere Infos im Internet unter:
www.jost-world.com/sensoric





Trailer hitch

automatic

for heavy central axle trailers with trailer coupling rings 50, EEC type-approved according to Class C 50-X, in line with guideline 94/20 EC

Type	5050 A
D-value	200 kN
DC value	135 kN
V-value	75/63 kN
Drawbar load	1000/2000 kg

Order number

3204 996 305



Trailer hitch

automatic

for the connection of fifth-wheel and central axle trailers with trailer coupling ring 40 according to DIN 74054 or 40 mm according to ISO 8755 as well as identical Class S trailer coupling rings according to guideline 94/20 EC or ECE 55-01

DC value	92 kN
Drawbar load	1000 kg

Type	D-value kN	V-value kN	Hole pattern mm	Order number
4040/G145A	100	38	140 x 80	3204 991 104
4040/G150A	137	40	160 x 100	3204 996 314



Was sehen sie hier?

Leidenschaft für Qualität und Präzision

Seit 90 Jahren stehen wir für neueste Technologien, Funktionalität, Zuverlässigkeit und Produkte, für schnellen Kundendienst und Service. Und das wird auch so bleiben.



Toolbox

suitable for every vehicle type

sturdy shape thanks to all-round steel profiles and PUR-coated base with ribbed surface, waterproof thanks to rubber seals in the lid, three-point lock with stainless steel pushing rods, actuated through handle with built-in lock, made of heat-resistant, high-strength, scratch and tear-proof polyurethane

Temperature resistance -40 to +80 °C
Material polyurethane

Scope of supply

Toolbox incl. 2 keys, 4 mounting brackets for attachment under the vehicle floor and fastening material

Type	Version	Width mm	Height mm	Depth mm	Order number
101	hinge at the bottom	440	398	480	9081 200 011
102	hinge at the bottom	588	445	480	9080 240 911
103	hinge at the bottom	749	429	450	9081 200 030
104	hinge at the bottom	753	429	550	9081 200 040
105	hinge at the bottom	1040	486	480	9081 200 050
106	hinge at the bottom	755	290	450	9081 200 060
107	hinge at the side	676	664	525	9081 200 190

4
Technical equipment and accessories



GROSSE NAVIS FÜR GROSSE BRUMMIS



NAV-XEA70T EU
17,7 cm / 7" Touchscreen



NAV-XEA50T EU
12,7 cm / 5" Touchscreen



Europaweit mobile Navigation der neuesten Generation für besondere Trucker-Ansprüche: Deutliche Sprachansagen sorgen zusammen mit intuitiven Bedienoberflächen und selbsterklärenden Piktogrammen auf großen Displays für besten Handling-Komfort. Geschwindigkeits- und Spurassistent, Text to Speech (Ansage von Straßennamen), TMC (by Avanteq) und GeoDaylight inklusive. Diesen technischen Highlights steht auch das trendsichere Design der XEA-Serie mit geraden, klaren Formen in nichts nach. Be mobile!

SPEZIELLE LKW-PARAMETER UND PROFILE:

- ABMESSUNGEN, ACHSZAHL, GEWICHT, ETC. INDIVIDUELL EINSTELLBAR
- GEFAHRGUT (UNTERKATEGORIEN WÄHLBAR)
- PARAMETER-SPEZIFISCHES ROUTING (TUNNELHÖHEN, BRÜCKENLASTEN, DURCHFahrtsverbote, VERMEIDUNG VON WENDEN, ETC.)





Air horn kit

Super Fanfare

Type Beam
Material Stainless steel

Scope of supply
complete mounting set

Length cm	Order number
65/70	1002 017 702
80/85	1002 017 701



Air horn kit

Original HS

Material Stainless steel
Length 67/76 cm

Scope of supply
complete mounting set

Order number
1002 000 000



Air horn

pneumatic

Version with mini-compressor
Material Stainless steel
Length 55 cm

Order number
1002 017 704



Wheel cover

Version with snap ring holder
Installation location front
Material Stainless steel

Size	Order number
17.5"	8600 045 795
22.5"	8600 045 791



Wheel cover

Grand Prix

Version with snap ring holder
Installation location front
Material Stainless steel

Size	Order number
17.5"	1002 042 040
19.5"	1002 042 030

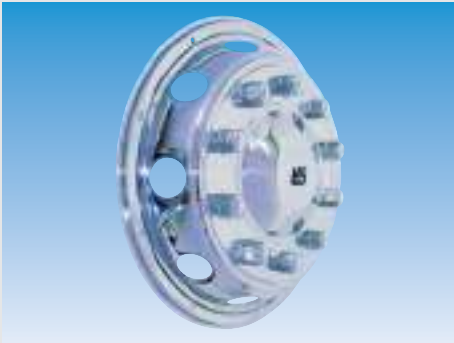

Wheel cover

Grand Prix

Size	22.5"
Version	with snap ring holder
Installation location	front
Material	Stainless steel

Order number
8600 042 050

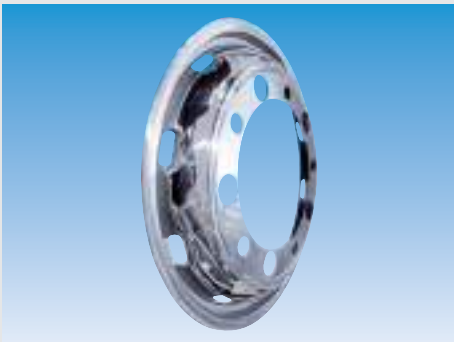

Wheel cover

screwed together with original bolts

Size	22.5"
Installation location	front
Material	Stainless steel

Order number
1002 042 010



Wheel cover

Version	with snap ring holder
Installation location	rear
Material	Stainless steel

Size	Order number
17.5"	8600 045 796
19.5"	8600 045 794
22.5"	8600 032 055



Wheel cover

Grand Prix

Version	with snap ring holder
Installation location	rear
Material	Stainless steel

Size	Order number
17.5"	1002 042 045
19.5"	1002 042 035



Wheel cover

Grand Prix

Size	22.5"
Version	with snap ring holder
Installation location	rear
Material	Stainless steel

Order number
8600 045 792



Wheel cover

Exklusiv

Size	22.5"
Version	with snap ring holder
Installation location	rear
Material	Stainless steel

Order number
1002 042 065



Wheel cover

Exklusiv

Size	22.5"
Version	with wheel nut caps
Installation location	rear
Material	Stainless steel

Order number
1002 042 075

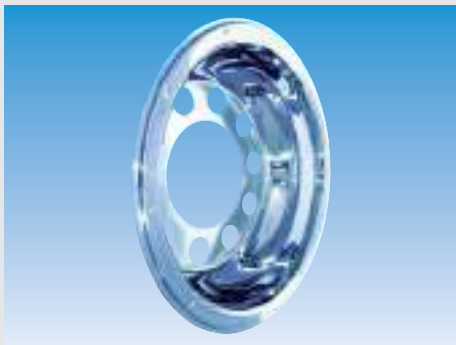

Wheel cover

Brilliant

Size	22.5"
Version	open, with snap ring holder
Installation location	rear
Material	Stainless steel

Order number
1002 042 080



Wheel cover

Classic

Front axle Supersingle, rear axle disc-braked	
Size	22.5"
Version	closed design
Installation location	front/rear
Material	Stainless steel

Order number
9199 847 077



Wheel cover

Classic

Front axle Supersingle, rear axle disc-braked	
Size	22.5"
Version	open
Installation location	front/rear
Material	Stainless steel

Order number
9199 847 076



Wheel cover

Type 1, universal fit

- for all rims with strongly swung rim flange
- Very fast fitting (approx. 2 minutes per cap)
 - No loosening of wheel bolts or nuts necessary
 - The wheel can be removed without the cap having to be removed

Size 22.5"
Material Stainless steel, polished

Central cap not included in the scope of supply - please order separately

Version	Order number
front	8610 704 100
rear	8610 704 200

Accessories

Description	Order number
Central cap	8604 501 505

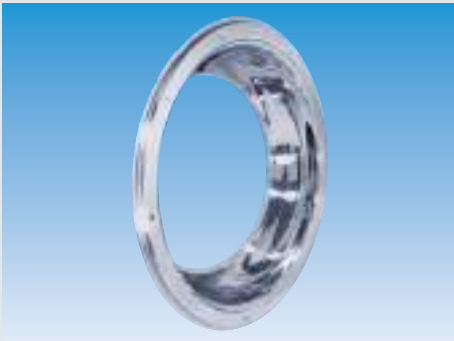

Rim ring

Exklusiv

Size 22.5"
Version with snap ring holder
Installation location rear
Material Stainless steel

Order number
1002 042 095



Rim ring

Standard

Size 22.5"
Version with snap ring holder
Installation location front
Material Stainless steel

Order number
1002 040 000

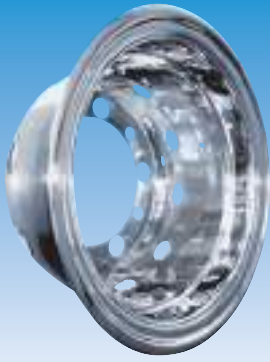

Rim lining

screwed together with original bolts

Size	22.5"
Installation location	rear
Material	Stainless steel

Rim width	Order number
8,25"	1002 042 020
9"	1002 042 025

4

Technical equipment and accessories



Wheel stud cover ring

closed design

Material Stainless steel

Version	Size	Number of holes	Order number
for aluminium and steel rims	17.5"	6	1002 001 802
for aluminium and steel rims	17.5/19.5"	8	1002 001 805
for steel wheels	22.5"	10	8600 001 800
for aluminium rims	22.5"	10	8600 007 801



Wheel stud cover ring

open

Material Stainless steel

Version	Size	Number of holes	Order number
for aluminium and steel rims	17.5"	6	8526 501 806
for steel wheels	22.5"	10	1002 001 803



Wheel hub cover

flat

Material Stainless steel

Order number
1002 002 000

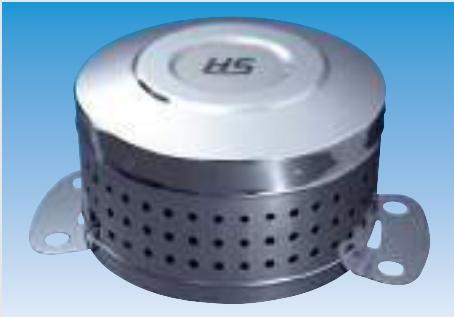

Wheel hub cover

medium-high, vented

Material Stainless steel
Height 170 mm

Version

for steel wheels
for aluminium rims

Order number
1002 002 021
1002 002 022

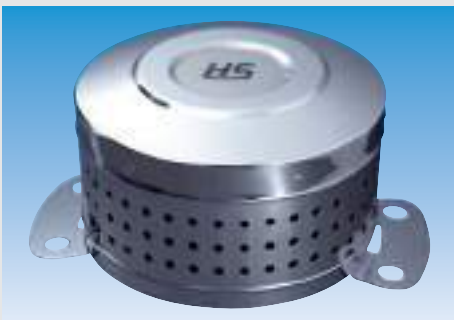

Wheel hub cover

high, vented

Material Stainless steel
Height 240 mm

Version

for steel wheels
for aluminium rims

Order number
1002 002 016
1002 002 017



Wheel nut cap

Spanner size mm

27
30
32
33

Order number
1002 001 090
1002 001 100
1002 001 210
1002 001 310



Reversing video system

PerfectView RVS 550

with 5" LCD monitor and colour camera, monitor easily removed because of Easylink support, optimum picture quality even at low temperatures, USB charger port, compact colour camera with extra-low design, IR LEDs for better night vision

5" colour LCD monitor M 5L

automatic or manual switch-on, automatic day/night switching, normal or mirror image function, 2 separately controllable camera inputs, picture setting can be saved for each camera, loudspeaker, USB connection for charging of e.g. MP3 players, LED background lighting, 235000 pixels

CAM 50C colour camera

Normal or mirror image function, anodised and powder coated casing, adjustable sun glare protection, microphone, temperature-controlled heating, LDR-controlled IR LEDs, angle of field 120°

Scope of supply

Monitor (cable set), Easylink monitor bracket, camera, 20 m connection cable from monitor to camera, mounting accessories for all components, dazzle and sun-glare protection

Order number

1880 000 009



Reversing video system

PerfectView RVS 750X

with 7" LCD monitor and colour camera, high end system for ultimate comfort and convenience – optimal day and night-time vision with the large colour monitor and light-sensitive infra-red LED camera

7" colour LCD monitor M 7LX

for 12 V and 24 V operating voltage, automatic or manual switch-on, automatic day/night switching, normal or mirror image function, adjustable distance marks, 3 separately controllable camera inputs, picture setting can be saved for each camera, loudspeaker, USB connection for charging of e.g. MP3 players, LED background lighting, 337000 pixels

CAM 50C colour camera

Normal or mirror image function, anodised and powder coated casing, adjustable sun glare protection, microphone, temperature-controlled heating, LDR-controlled IR LEDs, angle of field 120°

Scope of supply

Monitor (cable set), Easylink monitor bracket, colour camera, 20 m connection cable from monitor to camera, mounting accessories for all components, visor/sun protection

Order number

1881 900 010



Compressor cool box

CoolFreeze CDF-35

with integrated control electronics, undervoltage protection can be set for load- or starter battery, electronic fuse, automatic protection against polarity inversion, dynamically ventilated wire pipe capacitor, standing height for 1.5-litre reusable bottles temperature range +10 to -15 °C, continuously variable with electronic thermostat, average power consumption 45 W

Volume 31 l
 Voltage 12/24 V DC
 Width 560 mm
 Height 380 mm
 Depth 340 mm
 Weight 17 kg

Scope of supply

DC connection cable

TÜV/GS-tested

Order number

9710 200 301



Cool box

TROPICOOOL Classic

7-stage temperature control in heating and cooling mode, LED temperature display, memory function stores the last setting, membrane keyboard protects the electronics from dust and humidity, standing height for 1.5-litre reusable bottles Cooling max. 30 °C below ambient temperature, heating +50 to +65 °C average power drawn 55-80 W

Voltage = 12/24. ~ 230 V

TÜV/GS-tested

Type	Volume l	Dimensions mm	Weight kg	Order number
TC-21FL	21	450 x 420 x 303	6	9712 112 241
TC-35FL	35	550 x 460 x 376	10	9713 212 241



Cool box

CoolFun CX-18, thermo-electric

standing height for 1.5 litre deposit bottles, can be switched between cold/warm, cable compartment integrated in the lid

cooling max. approx. 20 °C at ambient temperature, heating approx. +65 °C

average power consumption 42 W

Volume	18 l
Voltage	12/24 V DC
Width x height x depth	390 x 380 x 290 mm
Weight	4.3 kg

Scope of supply

DC connection cable

TÜV/GS-tested

Order number

9711 812 240



Microwave

SAMSUNG Roadmate

Interior lighting, rotary table, 30-minute timer, automatic programming, door with safety lock

recommended supply line thickness:

22 mm² for a cable length of 0 to max. 3 m

36 mm² for a cable length of 3 to max. 5 m

Capacity	17 l
Voltage	24 V
Current consumption	40 A
Power	500 W
Width x height x depth	460 x 247 x 312 mm
Colour	black
Weight	8.1 kg

Scope of supply

mounting kit for wall or floor mounting

Order number

9710 002 002



Kettle

MCK-750-24/N

rugged relay technology, automatically switches off when boiling point is reached, protected against boiling dry, operating indicator

Capacity	0,75 l
Power	380 W
Voltage	24 V
Colour	black/aluminium silver

Application range

specially developed for mobile applications

Scope of supply

mounting kit for wall or floor mounting

Order number

9710 075 024



Percolator

high quality thermal jug in stainless steel with latch strap for secure hold, automatic cut-off after brewing, removable filter with drip-stop valve, designed for use with standard paper filters, removable water tank with water level indicator and safety fixture, LED indicators

Capacity	750 ml
Version	for 6 cups
Voltage	24 V
Power	380 W
Current consumption	25 A
Width x height x depth	270 x 232 x 170 mm

Application range

specially developed for use in trucks

Scope of supply

thermal jug, mounting bracket for wall or floor mounting

Order number

9710 188 624



Bottle cooler

wear-free thermo-electrics with external fan, suitable for all standards 1 to 1.5 liter bottles, inner container of aluminium for fast cooling/heating, with simple screw connection

cooling mode up to 22 °C below ambient temperature, heating mode up to +60 °C beverage temperature

Colour	silver grey
Voltage	12/24 V

Order number

1880 000 810



Starter battery



4

12 V, filled and charged

The wide range of EUROPART starter batteries for trucks and cars stands out particularly not only thanks to its excellent price-performance ratio but also through good start-up power, low water consumption, universal application possibilities, load capacity, long service life and reliability. It goes without saying that the quality requirements of EUROPART starter batteries comply with general DIN/EN standards.

Type	Capacity Ah	Length x width x height mm	Order number
620 045 068	120	513 x 189 x 223	9560 620 343
640 035 076	140	513 x 189 x 223	9560 640 203
670 043 100	170	513 x 223 x 223	9560 670 183
680 032 100	180	513 x 223 x 223	9560 680 323
700 038 105	200	518 x 276 x 242	9560 700 273
725 012 115	225	518 x 276 x 242	9560 710 143

Technical equipment and accessories



Starter battery

Promotive blue, 12 V, filled and charged

absolutely maintenance-free, labyrinth safety cover with flashback protection, central degassing, can be stored for up to 15 months, optimised current flow with PowerFrame grid technology for particularly low resistance and maximum conductivity, extended OE technology

Type	Capacity Ah	Length x width x height mm	Order number
670 103 100	170	513 x 223 x 223	9560 670 102
640 400 080	140	513 x 189 x 223	9560 640 401
640 103 080	140	513 x 189 x 223	9560 640 104



Starter battery

Promotive silver, 12 V, filled and charged

absolutely maintenance-free, labyrinth safety cover with flashback protection, central degassing, can be stored for up to 18 months, optimised current flow with PowerFrame grid technology for particularly low resistance and maximum conductivity, extended OE technology

Type	Capacity Ah	Length x width x height mm	Order number
725 103 115	225	518 x 276 x 242	9560 725 104
680 108 100	180	513 x 223 x 223	9560 680 110
645 400 080	145	513 x 189 x 223	9560 645 400

The technology that keeps your fleet on the road. **Who started it?**



VARTA® Promotive batteries are built to power fleets and reduce Total Cost of Ownership. Advanced PowerFrame® and Labyrinth lid technologies, plus durable design, deliver reliability, zero maintenance, and longer life. Which means less downtime.

To find out how VARTA can save you money, visit www.varta-automotive.com

It all starts with  **VARTA®**



H1 halogen headlamp bulb

Vision Plus: up to 50 % more light on the road, 10-20 m further visibility

Socket P 14,5 s

Voltage 24 V

Power 70 W

Application range

for high beam/low beam and fog light

Order number

8900 040 100

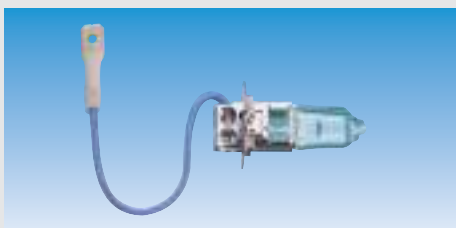

H3 halogen headlamp bulb

Voltage 24 V

Power 70 W

Socket PK 22 s

Application range

for low beam/high beam/fog light and worklight

Order number

8900 009 000

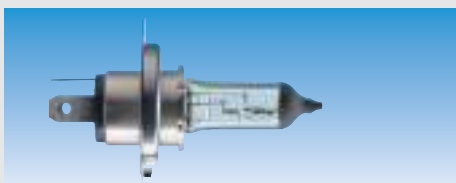

H4 halogen headlamp bulb

Voltage 24 V

Power 75/70 W

Socket P 43 t

Application range

for low beam/high beam/fog light

Order number

8900 006 000

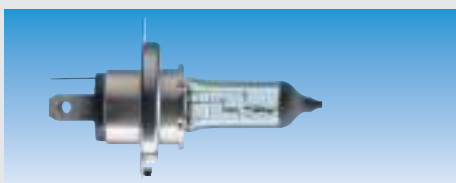

H4 halogen headlamp bulb

Version Heavy Duty, Vision Plus: up to 50 % more light on the road, 10-20 m further visibility

Voltage 24 V

Power 75/70 W

Socket P 43 t

Application range

for high beam/low beam and fog light

Order number

8900 008 000



H7 halogen headlamp bulb

Voltage 24 V
Power 70 W
Socket PX 26 d

Application range

for low beam/high beam/fog light and worklight

	Order number
	8900 001 030



Bulb

Drop-shaped

Socket BA 15 s
Voltage 24 V
Power 21 W

Application range

for indicator, brake, rear fog, reversing lights

Version

Heavy Duty

	Order number
Heavy Duty	8900 010 000
-	8900 003 000



Bulb

Drop-shaped

Socket BAY15d
Voltage 24 V
Power 21/5 W

Application range

for brake/tail light

	Order number
	8900 013 000



Bulb

spherical

Socket BA 15 s
Voltage 24 V

Application range

for tail/licence plate/position and interior light

Power W

5

	Order number
5	8900 001 000
10	8900 002 000



Bulb

Spherical

Version Heavy Duty
 Socket BA 15 s
 Voltage 24 V

Application range

for tail/licence plate/position and interior light

Power W	Order number
5	8900 011 000
10	8900 012 000

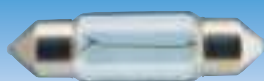

Bulb

festoon bulb

Voltage 24 V
 Diameter 11 mm
 Socket SV 8,5

Application range

for tail/licence plate/position and interior light

Power W	Length mm	Order number
5	35	8900 005 000
10	41	8900 040 060

EUROPART® – a powerful brand

Alongside well-known manufacturer's brands, EUROPART also offers a strong assortment of its own-brand products with more than 5000 items from the various EUROPART ranges.

Top quality at a fair price.

Your advantages:

- Low-cost alternative for OE standard
- Maximum availability at 200 locations in 28 countries
- Increase your competitiveness
- Consistent service package





Marking board

for trucks and tractors

retro-reflective type II, fluorescent

Version	edged
Material	aluminium
Standard	ECE 70
Width	565 mm
Height	130 mm

Type	Order number
left	9650 000 470
right	9650 000 480



Marking board set

for trucks and tractor units

reflective type II, fluorescent

Version	smooth
Material	aluminium
Standard	ECE 70
Width	565 mm
Height	130 mm

Order number
9651 000 495



Warning panel

retro-reflecting type 1

Version	folding, with edge protection and fastening elements
Material	Sheet steel
Width	400 mm
Height	300 mm
Colour	orange

in accordance with GGVSEB/ADR

Order number
9650 006 001



Warning panel

Waste

retro-reflecting type 1

Version	folding, with fastening elements and edge protection
Material	Sheet steel
Width	400 mm
Height	300 mm
Colour	white

Order number
9650 205 060



Number panel

retro-reflecting type I
 Material sheet steel
 Width 400 mm
 Height 300 mm
 Colour orange/black
according to GGVSEB/ADR

Version

Version	Order number
rigid, with edge protection, without spaces	9651 000 190
rigid, with edge protection, without spaces, with digit set	9650 205 400

4

Technical equipment and accessories



Numeral set

25 digits and X

retro-reflecting type I
 Version with edge protection
 Material sheet steel
 Width 70 mm
 Height 117 mm
 Colour orange/black

Scope of supply

with pouch
according to GGVSEB/ADR

Order number

9650 205 410



Parking warning sign

retro-reflective type II, fluorescent
 Form A
 Material sheet steel
 Width 423 mm
 Height 423 mm
 Colour white/red

**in accordance with § 17 StVO (Rules of the Road), § 22a StVZO and TA 18b,
 in accordance with § 51c, § 72 StVZO (German Rules of the Road), DIN 11030**

Version

Version	Type	Order number
folding, with edge protection	indicating left	9650 204 510
folding, with edge protection	indicating right	9651 204 510
folding, without edge protection	indicating left	9650 010 700
folding, without edge protection	indicating right	9650 010 710



Parking warning sign

retro-reflective type II, fluorescent
 Form A
 Material sheet steel
 Width 423 mm
 Height 423 mm
 Colour white/red

**in accordance with § 17 StVO (Rules of the Road), § 22a StVZO and TA 18b,
 in accordance with § 51c, § 72 StVZO (German Rules of the Road), DIN 11030**

Version

Version	Order number
rigid, with edge protection	9650 204 500
rigid, without edge protection	9650 010 690

Immer auf der Lauer!

Witte plusguide®- Wir reflektieren sicher in der Nacht.



Vehicle
Safety



Warntafeln



Warnmarkierungen



Schutzausrüstung / Reparatur- und Klebebänder



Witte plusguide GmbH
Sendener Stiege 4
48163 Münster
Tel. +49 (0) 2536 / 991-200
www.witte-group.com

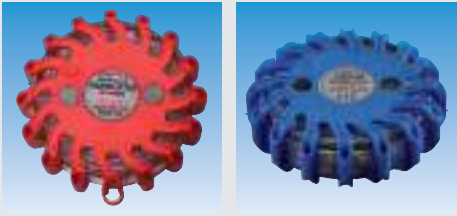

Warning flash lamp

With 16 ultra-bright LEDs, 10 light variations (also SOS morse code) can be switched, visible at night up to 10 km, light duration up to 100 hours, with magnet: Easy to mount, for instance on the vehicle roof, visibility range 360°, breakproof, not sensitive to temperature, waterproof and floatable, changeable batteries (lithium CR 123 recommended)

Weight 200 g
 Diameter 120 mm
 Height 35 mm

Application range

for protection against accidents, breakdowns and for personal safety



Colour	Lens colour	Order number
red	red	9195 491 151
blue	yellow	9195 491 152



(Illustration similar)

Case for hazardous goods

approved according to hazardous goods transport regulations

Type 73 SN -VM
 Dimensions 420 x 330 x 165 mm

Scope of supply

Panorama full mask, combination filter DIN 3183, A2 B2 E2 K2, eye rinsing bottle with sterile contents, gloves PVC stockinette lined, light protective clothing, over-boots made of rubber

Order number
9194 320 002



(Illustration similar)

Case for hazardous goods

approved according to hazardous goods transport regulations

Type 74 SN-VM
 Dimensions 420 x 330 x 165 mm

Scope of supply

Panorama full mask, combination filter DIN 3183, A2 B2 E2 K2, eye rinsing bottle with sterile filling, gloves PVC-jersey lined, protective suit with hood, over-boots made of rubber, first-aid equipment in accordance with DIN 13 164, rescue blanket

Order number
9194 320 003



Rechargeable fire extinguisher

Fire class A, B, C, refillable

very service-friendly, CE compliant

Contents 6 kg
 Standard DIN EN 3
 Version semi-automatic, with pivoted extinguisher pistol and internal cartridge
 Type P6STAR
 Temperature range -30 to +60 °C

Application range

ideal for hazardous goods transport

GS tested

Order number
 9195 491 025



Continuous pressure fire extinguisher

Fire class A, B, C, refillable

made of high quality sheet steel, CE compliant

Contents 6 kg
 Standard DIN EN 3
 Type PD 6 GA
 Temperature range -30 to +60 °C

Application range

suitable for LPG and heating oil storage, garages and hobby rooms

Scope of supply

high-quality wall bracket

GS tested

Order number
 9195 491 125



Powder fire extinguisher

for passenger car, fire class A, B and C, refillable

Contents 2 kg
 Standard EN 3
 Type F 2 G

Scope of supply

complete with testing valve, vibration-proof car bracket and tightening strap

Order number
 9195 492 000



Fire extinguisher box

for 6 kg and 9 kg fire extinguishers

Type	Rimbox 155
Material	polypropylene copolymer, recyclable, impact-proof and UV-stable
Version	with window
Height	674 mm
Width	313 mm
Depth	225 mm
Weight	3 kg

Order number
9080 240 912



Vehicle bracket

for fire extinguisher 6 kg

Scope of supply

Bracket incl. 2 retaining straps

Order number
9195 491 200



Grille protective cover

for fire extinguisher up to 6 kg

Order number
9195 516 000



Portable fire extinguishers must be suitable for use on a vehicle and must meet the relevant requirements of the EN 3 standard.



Pressure pad set

for replacing the rubber bearing for front and rear axle shock absorber eyes with 30-40 mm diameter

Application range

Mercedes-Benz Actros 1996-, Atego 1998-2004, Axor 2004-, LK/LN 1984-1998, MK 1987-1996, NG 1973-1996, SK 1987-1996, 507D-814D 1986-1994, Unimog 1977-1988, Vario 512D-815D 1996-, Sprinter

Version

5-piece

Order number

9533 507 300

Accessories

Silent bearing tool set Press frame, mechanical

Order number

9514 051 302

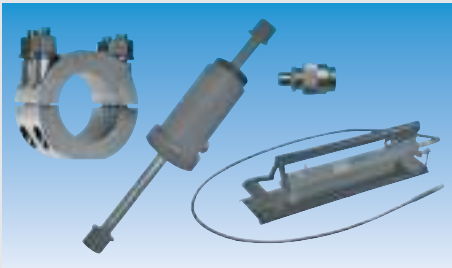

Basic set

Commercial vehicle silent bearing

for use of the corresponding half-shell sets when replacing the silent bearing at the leaf spring, stabilizer, driver's cab mounting, shock absorber without removing the axle

Version hydraulic

Scope of supply

Clamping block for pretensioning of silent bearings up to 90 mm diameter, hydraulic cylinder 17.5 t, hydraulic coupling for hydraulic cylinder, hydraulic foot pump max. 700 bar, complete with 10 mm (3/8") NPT connection and 2.50 m hose, M20 nut with collar (2 pieces) and truck tension bolts 515 mm

Order number

9140 500 006



Half shell set

for silent bearing replacement

Application	Ø mm	Order number
Mercedes-Benz LN 1320	45	9500 609 012
Mercedes-Benz B 3229 B, 652, 650	58	9500 609 014
Mercedes-Benz trucks and Renault trucks	60	9500 609 015
Mercedes-Benz Actros (stabilizer), Atego	63-65	9500 609 016
Mercedes-Benz Actros (stabilizer), new 1380	75	9500 609 019
Mercedes-Benz Actros (stabilizer), bearing with stud	84	9533 505 416

Accessories

Description	Application	Order number
Addition for half shell set	45 mm diameter silent bearing	9533 505 509
Clamping block extension	for installation of all silent bearings up to 90 mm diameter	9514 050 419
Silent bearing tool set, 4-piece	Vehicle-typical half-shell set is required!	3566 180 793



Bit assortment

IMPACT

with 22 mm hexagonal drive

Application range

for assembly and disassembly on cylinder head screws, brake caliper screws, drop arm (e.g. Actros), wheel flange screws, oil drain screws, shock absorber fixture

Scope of supply

1 TORX® each T60/T70/T80/T90/T100
 1 hexagon socket each 17/19/22/24 mm
 1 outer TORX® each E18/E20/E22/E24
 2 bit bracket with 3/4" and 1" drive
 1 L-key for holding the bits in the bracket
 in plastic case

Version

16-piece

Order number

9514 057 940



Double-ended ring spanner set

straight, extra long, ultra-strong

Length 290-440 mm
 Material chrome vanadium
 Surface high-gloss polished

Application range

e.g. for carrier joints, stub axle screw fittings, cardan shaft flange (also truck before towing)

Scope of supply

10 x 11, 12 x 14, 13 x 15, 16 x 18, 17 x 19, 22 x 24 mm
 in plastic case

Version

6-piece

Order number

3566 180 619



Pry bar set

Plastic handles with protective caps

Material hardened tooling steel
 Surface bronzed

Scope of supply

1 each of pry bars with lengths 200/300/450/600 mm

Version

4-piece

Order number

9534 759 010



Filter wrench

for air dryer cartridge

for loosening granulate cartridges on commercial vehicles

Material Special steel
 Drive 1/2"
 Clamping range 95-165 mm

Order number

9856 745 130

(Illustration similar)



Wrench for torque-type self-locking nuts

Drive 3/4"

Size mm	Application range	Order number
56 x 71	e.g. Mercedes-Benz commercial vehicle axle VL 3/8, 13, VO 3/10, VL 4/7, 9, 10, VD 4/14, VO 4/11, 13, 18, VL 4/15, 16, 19, VD 4/20 in models: 363/385/387/389/391/393/395/617/620/621/622/623/625/649	2300 032 584
60 x 76	e.g. Mercedes-Benz, reinforced 9 t front axle VL5 DC, VL5/1 D-9, VL 5/2 D-9 for model 2629/6 x 4, 2635 K/6 x 4, 3535 K/8 x 4/4, Discos-Trailer trailer axle from construction year 97-5/2000 with compact mounting (HUB-Unit), same design as the non-driven Actros front axle and for Faust 9 t front axle	9514 050 327



Impact socket

DIN 3129/ISO 2725-2

Form Hexagon
Version short
Drive 1"
Material chrome vanadium special steel
Surface bronzed/black

Application range

for hexagon head screws, for all electric or pneumatic socket wrenches (impact wrenches)

Scope of supply

with connection pin and O-ring

Spanner size mm	Order number
55	9534 091 515
60	9534 091 520



Screwdriver set

Form 5-star with hole
Length 105 mm
Width 300 mm
Height 60 mm

Application range

e.g. for plug-in pumps on Mercedes-Benz commercial vehicles (Actros and Atego)



Version	Order number
8-piece	9514 051 510

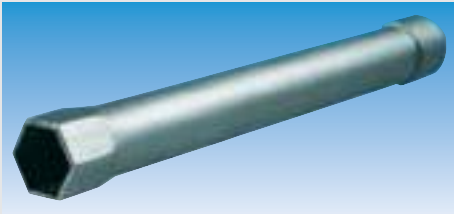

Socket wrench insert

for alternator

Form	Hexagon
Drive	1/2"
Length	200 mm
Spanner size	19 mm

Application range

for ribbed V-belt tensioning on alternators, e.g. on Mercedes-Benz SK series and MAN F90, F2000

Order number

9534 005 256

4



Socket wrench insert

IMPACT insert

Form	twelve edges
Version	extra deep, ultra-strong
Drive	1/2"
Length	78 mm
Spanner size	36 mm

Application range

for releasing PTO shaft screws, e.g. on Mercedes-Benz truck transmission G2/24/27

Order number

9534 010 193

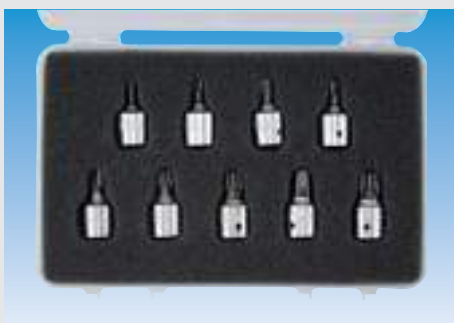

Socket set

with face spanner bore

Form	5-star with hole
Drive	1/4"

Application range

for VAG, Ford, Volvo, Mercedes-Benz passenger cars and trucks, Rover etc., on alternator, engine control, air flow meter, door cladding, immobiliser and plug-in pumps

Scope of supply

1 set each IP10, IP15, IP20, IP25, IP27, IP30, IP40, IP45, IP50
in plastic case

Version

9-piece

Order number

3566 183 628



Socket wrench insert

with face spanner bore

Form 5-star, with hole
 Drive 1/4"

Application range

e.g. for plug-in pumps on Mercedes-Benz Actros

Size	Length mm	Order number
IP10	16	9534 000 410
IP15	26	9534 000 415
IP20	26	9534 000 420
IP25	26	9534 000 425
IP27	26	9534 000 427
IP30	26	9534 000 430
IP40	26	9534 000 440
IP45	26	9534 000 445
IP50	26	9534 000 450



Socket set

Form Hexagon T-profile, without bore
 Drive 1/2"
 Length 80 mm

Application range
 for trucks

Scope of supply

1 each x T60/T70/T80/T90/T100

Version	Order number
5-piece	9500 140 518



Socket wrench insert

without face spanner bore

Form Hexagon T-profile, without bore
 Version long
 Drive 1/2"
 Size T70
 Length 80 mm

Application range

e.g. Mercedes-Benz, MAN, DAF rear axle, oil drain screw

Order number
9534 005 349



Impact driver socket

IMPACT insert

Special insert for T-profile bolts, impact driver quality, high-strength design for extreme loads

Form T-profile, without bore
 Drive 3/4"
 Spanner size T60 mm

Application range

For Mercedes-Benz Actros droparm and brake caliper

Length mm	Order number
80	2300 051 461
130	9500 140 534



Impact driver socket

IMPACT insert

Form	Hexagon socket
Drive	3/4"
Length	138 mm
Spanner size	14 mm

Application range

zur mounting of hexagon socket brake caliper screws on the rear axle of Mercedes-Benz Actros and Citaro for axle types HL7 + HL8 Hypoid, Neoplan ZF and for MAN TGA wheel hubs

Order number

9534 001 441



Impact driver socket

IMPACT insert

Form	twelve edges
Drive	3/4"
Length	110 mm

Application range

for truck cylinder head screws

Spanner size mm	Order number
------------------------	---------------------

17	9514 050 072
----	---------------------

19	9514 050 073
----	---------------------



Splined bit

IMPACT insert

Drive	3/4"
Size	M16
Length	80 mm

Application range

for flywheel screws, e.g. on Mercedes-Benz Atego

Order number

9514 050 120



Splined bit

IMPACT insert

Version	long
Drive	1/2"
Length	75 mm

Application range

for mounting of ultra-strong screws on Mercedes-Benz Atego flywheels

Size	Order number
-------------	---------------------

M14	9534 101 954
-----	---------------------

M16	9534 101 956
-----	---------------------



Ball joint extraction tool

Clamping range	34 mm
Lever clamping range	up to 70 mm

Application

for medium-sized trucks, buses and construction vehicles
for heavy-duty trucks, buses and construction vehicles

Order number

9500 001 293
2300 043 040



Radiator pressure test tool set

Pressure loss monitoring via pressure gauge, possibility of testing blanking plugs, pressure testing of cooling system
Measuring range 0-2,5 bar

Scope of supply

1 pump
7 radiator adapters for current trucks by DAF, IVECO, Mercedes-Benz, MAN, Scania, Renault and Volvo
in case

Version

8-piece

Order number

9514 050 083



Pipe connection key set

Open

Application range

For injector pipework, air conditioning systems, brake pipes, compressed air and hydraulic pipework, oil pressure switch, 1/2" drive

Scope of supply

1 each of ring spanners 20/21/22/23/24/25/26/27/28/30/32 mm
1 extension, 125 mm
1 jointed handle, 385 mm

Version

13-piece

Order number

3566 180 774

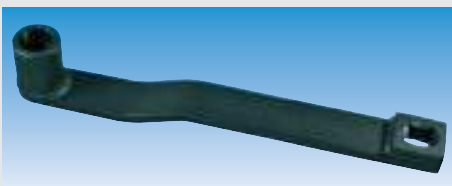

Assembly key

for brake calipers

Form	twelve edges
Drive	1/2"
Spanner size	27 mm

Application range

for mounting of mounting screws on the front brake system of Mercedes-Benz Atego and Actros

Order number

9514 051 437



Oil pressure tester

for diagnosis of leaks in the oil system, scale 0-10 bar

Scope of supply

Connection adapter:

R 1/8" DIN 2999

1/8" x 27 NPT

1/4" x 18 NPT-3/8" x 20 UNF-1/2" x 20 UNF

M10 x 1.0/M12 x 1.5/M14 x 1.5/M16 x 1.5/M18 x 1.5/90°

Order number

9514 050 086



Oil filter spanner

for AdBlue®

for installation and removal of the filter housing cover when changing the AdBlue® filter on Mercedes-Benz commercial vehicles with Blue-Tec® engines

Form Hexagon

Drive 1/2"

Spanner size 46 mm

Observe tightening torque recommended by the vehicle manufacturer!

Order number

9534 000 046



Magnet wheel inserter

for magnet wheel without shaft seal

Length 175 mm

Height 162 mm

Application range

on Mercedes-Benz Actros vehicles with ABS disc brakes and lifting axle as well as identical axles of trailers and semi-trailers

Order number

9514 050 079



Scope of supply

1 bit 1/2" drive, 4 teeth, 72 mm long (for Mercedes-Benz series OM 401/421, 403/423, LA, A, 470)

1 bit with 32 mm outer hexagon drive, 4 teeth, with inner thread M14 x 1.5 mm, 70 mm long (for Mercedes-Benz, Neoplan, Setra)

1 bit 1/2" drive, 3 teeth, 120 mm long (for Mercedes-Benz, MAN)

1 bit with 32 mm outer hexagon drive, 4 teeth, 120 mm long (for Mercedes-Benz, MAN)

Version

4-piece

Order number

9514 050 082



Castle nut wrench

extremely strong, milled and turned from solid material, designed for high tightening and loosening torques, replaceable guide pipe

Form	Square socket
Drive	3/4"
Number of journals	6
Journal width	11,5 mm

Application range

e.g. Mercedes-Benz with 10 and 13 t planetary axle, hypoid and trailing axle NR 7/4 (without guide tube)

Order number

9514 050 318



Castle nut wrench

Form	Square socket
Drive	3/4"
Number of journals	6
Journal width	10 mm

Application range

e.g. Mercedes-Benz Actros, rear axle HL/HL 8 (hypoid axle)

Order number

9514 050 329



Castle nut wrench

extremely strong design for high tightening and loosening torques, guide pipe is tightly fitted, with union guide pipe extendable to 57 mm diameters as bayonet connection and with spring pin

Form	Square socket
Drive	3/4"
Number of journals	6
Journal width	10 mm

Application range

e.g. Mercedes-Benz Atego, rear axle (pinion axle) HL2

Order number

9514 050 332



Piston ring cable tie

with spanner wrench

with full fine adjustment

Material Special spring band steel

Length 80 mm

Clamping range 90-175 mm

Order number

9240 072 298



Piston ring pliers

blue handles

for secure attachment of piston rings

Material nickel-plated to a gloss

Length 240 mm

Clamping range 110-160 mm

Order number

9240 639 753



**Made in Germany -
Made by GEDORE**



www.gedore.com



Piston ring pliers

hardened with prism plates

for secure spreading of piston rings

Material chrome-plated, bronzed tips
 Length 220 mm
 Clamping range 60-160 mm

Order number

9240 072 304



Brake spring pliers

for drum brakes

chrome-plated, with special binding and supporting crown, especially suitable for glued brake pads, heavy-duty model with exchangeable spring hooks and hand pinch protection

Material Chrome vanadium steel
 Length 500 mm

Order number

9240 072 390



Motor turning gear

for Mercedes-Benz and MAN

with new, thin baseplate and 2 toothed wheels

suitable for Mercedes-Benz engines, series 400 and 500
 MAN 6- and 12-cylinder engines

Drive 2"

Order number

9500 500 505



Motor turning gear

for Mercedes-Benz and MAN

with new, extra thick baseplate and 3 toothed wheels

suitable for Mercedes-Benz engines, series 900
 MAN 5-, 6- and 8-cylinder engines

Drive 1/2"

Order number

9500 500 506



Battery charger

MXT 14

CTEK charger, electronic, SUPPLY – special mode in which the device can be used as a power supply unit if the battery is removed (radio code), Regeneration mode – special mode in which exhaustively discharged batteries can be regenerated and returned to full capacity, with 8-stage, fully-automatic IUoUp charging characteristics without voltage peaks,

MAN approval issued

Technical data

Battery capacity: 28-300 Ah (charge), 28-500 Ah (maintain)

Battery types: open, maintenance-free AGM, gel and lead-calcium

Reverse current: < 2.3 mA

Charging time for a 60 Ah battery: 4 hrs at 14 A

Protection class IP44

Weight 1.4 kg

Cable length 1.85 m

Voltage 170-260 V AC

Charge voltage 27.2 V, 28.8 V, 31.6 V, **nominal 24 V**

Charge current, max. 14 A

Width x Height x Length 128 x 64 x 233 mm

GS-tested, 2 year manufacturer's warranty

Order number

9539 640 145

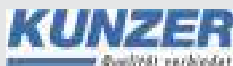

Battery charger

XT 14000 EXTENDED

High-frequency charger with fully automatic charging characteristic IUoUp without voltage peaks, the solution for permanent installation in vehicles with 24V on-board voltage, for open, maintenance-free, AGM, GEL and lead-calcium batteries

Technical data

Battery capacity: 28-300 Ah (charging), 28-500 Ah (maintenance)

Back current drain: < 2 Ah/month

Protection class IP44

Connection 24 V

Weight 2.4 kg

Version 7-stage charging characteristic

Voltage 220-240 V AC

Charge voltage 28.8 V, nominal 24 V

Charge current, max. 14 A

Width x Height x Length 128 x 64 x 233 mm

Application range

suitable for vehicles in which electrical consumers are regularly operated with the vehicle at a standstill or for seasonal operation

Scope of supply

6 m cable with M8 ring terminals for battery connection

Order number

9539 640 101





Start booster

AS 12-24/1600

maximum starting power through extremely deep-cycle resistant AGM battery (replaceable), lifetime for max. 50% start discharge: 1,000 cycles, correct use protects the electronic equipment of the vehicle, built-in voltmeter which indicates the state of charge of the batteries and the correct operation of the charging equipment as well as the generator, built-in socket, high-quality internally bridged crocodile clips with a very wide opening angle, impact-resistant polyethylene casing, charging via electronic battery charger with pulse charge retention or with cable (not included in the delivery) via the generator through the vehicle's cigarette lighter socket

Technical data

Starting current: at 12 Volt 1600 A, at 24 Volt 800 A
 Peak current: at 12 Volts 4740 A, at 24 Volts 2370 A

Version	portable
Weight	22 kg
Cable length	1.35 m
Cable cross-section	35 mm ²
Dimensions	485 x 520 x 160 mm
suitable for	Vehicles up to 250 horsepower at 24 V

Order number
 9539 640 164



Start booster

ASF 12-24/3200

professional external starter unit, maximum cold-start power thanks to an extremely cycle-resistant AGM battery, start-up without voltage peaks, manual voltage selection, correct use protects vehicles' electronic components, integrated voltmeter which displays the charging status of the batteries and the correct functioning of the charging equipment and alternator, built-in socket, high-quality, internally bridged crocodile clips with a very wide opening angle, impact-resistant one-piece housing with lifetime guarantee, charging through electronic battery charger with pulse charging preservation or using the cable provided through the alternator at the vehicle's cigarette lighter.

Technical data

Service life 1000 cycles with max. 50 % start discharge
 Starting current 3200 A at 12 V, 1600 A at 24 V
 Peak current 7750 A at 12 V, 3875 A at 24 V

Weight	38 kg
Cable length	1.75 m
Cable cross-section	70 mm ²
Voltage	12/24 V

Scope of supply

IUU charger

The IUU charger provided allows permanent connection to the mains. This means full power is always available immediately. Incl. short-circuit and inverse polarity protection.

Order number
 9539 640 168



Test case

LE-UN AB03

With the collaboration of various commercial vehicle manufacturers, a testing system for SCR equipment was developed, which is already successfully being used at the manufacturers' training centres and is recommended by them. The AdBlue® testing case offers the facility to perform the necessary mechanical tests on AdBlue® exhaust gas aftertreatment systems.

All the testing components in the case are manufactured from selected high-quality materials to ensure a long service life involving frequent contact with the corrosive AdBlue®. The case is equipped for the Denoxtronic systems I and II.

Mechanical measurements to be performed:

Denoxtronic I

- Quantity measurement at the supply module and at the dosage module

Denoxtronic II

- Quantity measurement at the dosage module
- Visual check of the spray pattern
- Flow rate check of the heating line
- Optional: pressure measurement

Application range

for Denoxtronic I and II AdBlue® systems

Scope of supply

Measuring containers with caps (250 ml and 1 litre), oil testing paper, hook and magnet for mounting, rinsing hose

for Denoxtronic I

- Pressure/metering unit
- Adapter hoses
- Threaded adapter
- 180 Ohm resistance
- Chain for measuring containers

for Denoxtronic II

- Scales for exact measurement of the AdBlue® quantity, calibrating weight
- Adapter hoses and cables
- Bypass line
- Rubber leash and blanking plugs

Order number

9682 202 411

AdBlue® must not contain any mineral oils or greases, nor any silicone oils or greases! Lubricate components: for instance O-rings in the pipe system, threaded fittings at the filter etc. with liquid soap or Vaseline®.

Once having come into contact with AdBlue®, receptacles such as measuring containers, funnels or adapter hoses must then only be used for diagnosis and work on AdBlue® systems.



Test strips

for detecting diesel and oils in AdBlue®

for detecting incorrect tank filling and testing in warranties

Contents 100 strips

Dimensions 20 x 70 mm

Oil and diesel damage the AdBlue® system

Order number

9682 202 412

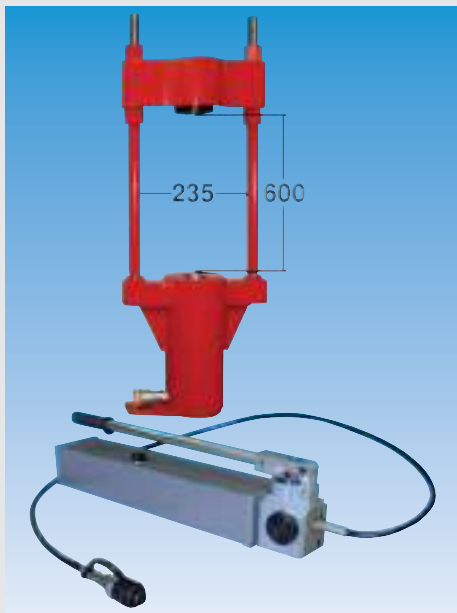

Axle leg bolt press

FP 50 s

hydraulic pressing jig for pressing kingpins in and out with the axle built in and removed

Pressure 40 t
 Stroke 115 mm
 Weight 45 kg

Scope of supply

Press body with hand pump included, bridge and piston locking piece, 2 stay bolts with nuts, bridge reducer (55/65 mm diameter)

Order number
 9534 004 012

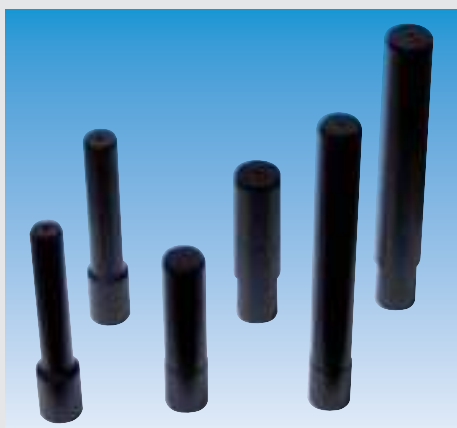

Stud accessories set

Kingpin press FP 40 i/FP 50 i

Scope of supply

comprising one pressure bolt each in the sizes:

- Diameter 21.5 x Length 150 mm
- Diameter 24.5 x Length 150 mm
- Diameter 30.0 x Length 120 mm
- Diameter 30.0 x Length 220 mm
- Diameter 34.0 x Length 120 mm
- Diameter 34.0 x Length 220 mm

Version

6-piece

Order number
 9534 004 020



Axle leg bolt press set

FP 65 s

For pressing bolts in and out without removing the front axle, saves a great deal of time, easy to handle, works in any position, high pressing force, can also be used as a stationary and mobile workshop press

Version for MAN special application as well as all other trucks
 Pressure 73 t
 Stroke 115 mm
 Clearance 250 mm

Scope of supply

1 press body, 2 stay bolts, 1 transverse bridge complete, 1 reducer for bridge bore diameter 70/55 mm, 1 separate hand pump with 1.8 m hydraulic hose, 1 pressure bolt set (6-piece) diameter 21.5 - 39 mm, 1 bridge and piston locking piece, 1 lifting and transport cart, pivotable

Order number
 9534 004 055



Test device

for AdBlue®, coolant antifreeze and battery acid

Model RFM 02

The continual reduction of exhaust gas values is presenting ever greater demands on diesel engines. This requires a system of exhaust gas treatment. Here, AdBlue® (32.5 % urea, 67.5 % water) from an additional in-vehicle tank is sprayed in controlled doses into the exhaust flow and effects a chemical reaction in the SCR catalytic converter. Nitrogen oxides are converted to nitrogen and steam. AdBlue® is subject to gradual "decomposition" and only has a limited lifetime (the water content drops through evaporation)! To avoid serious damage or even replacement of all components in the SCR system, and guarantee perfect function, AdBlue® must be tested.

Order number

9682 220 433



Filling and bleeding device

for diesel filters

filling and bleeding of diesel filters while still installed, connected to compressed air, the integrated venturi system creates a powerful vacuum and extracts the fuel

Application range

for use when changing a filter, vehicle refuelled with wrong fuel or driven until the tank is empty

Scope of supply

matching hoses (4, 6, 8 mm) with plug-in nipple) for all diesel direct injection systems, e.g. HDI, CDI etc., "Chamäleon" based vacuum pump with filling and bleeding kit

Order number

9682 220 511



Short-circuit and interruption detector

Fast locating of short-circuits, broken cables and creepage currents without having to pierce wires, no time-consuming dismantling of plastic trims, entry ladders, carpets etc.; wire identification, wire testing, standard tests and special tests, this precision unit comprises a transmitter, locator, current tester and safety contact adapter in three sizes, the locator part has a choice of three sensitivity levels

Application range

It can be used for all types of circuits with voltages between 6 and 42 V DC, e.g. passenger cars, trucks, trailers, boats, etc.

Order number

9682 220 510



Leak detector

ULTRASONIC Easy Flex

small, handy and compact, easily locates faults e.g. on pneumatic, steam, gas or vacuum systems, receives airborne ultrasonic signals (38-42 kHz) which form around a leak spot and transforms these into acoustic signals, the nearer and larger the leak spot, the faster the acoustic signal

Scope of supply

with headphones, 9 V block battery, in case

Order number

9526 611 021



Repair kit

7NKSR40, Truck

for the repairs of all commercial vehicle radiator hoses, independent of the vehicle or engine make, all radii can be made up, the connection fittings have a bead on both sides to ensure safe and permanently sealed connections, any unexpected hose defects are repaired immediately and at low cost.

Application range

for 38, 50, 55 and 60 mm radiator hoses

Scope of supply

1 each of hose piece, length 450 mm: 38 x 4 mm/50 x 4.5 mm/55 x 4.5 mm/60 x 5 mm

1 each of hose bend 90°: 38 x 5 mm/50 x 6 mm/55 x 6 mm/60 x 6 mm

4 each of pipe pieces with bead, length 60 mm: 38 x 1.5 mm/50 x 1.5 mm/
55 x 1.5 mm/60 x 1.5 mm

Worm drive clamps W2: 4 x Torro 35-50/12 mm, 8 x Torro 50-70/12 mm,
4 x Torro 60-80/12 mm

Version

40-piece

Order number

9539 641 070

4

Technical equipment and accessories



Repair kit

for fuel line

Today, PA tubes are the dominant type of line used in the fuel system, from the fuel tank through the fuel filter to the engine. With this repair set, you can repair all kinds of lines, no matter whether they are 8 mm diameter lines for petrol or 10 mm diameter lines for diesel. Transitions between different kinds of materials can be safely set up (PA tube-steel pipe, hose-steel pipe, PA tube-hose). In addition, the set contains all the SAE connectors required on the fuel filter. This repair set can be used to repair all faults on the fuel line quickly and safely.

Version	Order number
117-piece	9539 641 120



Disconnecting pliers

universal, Type 7DSK01

allows single-handed opening of SAE quick-release couplings, safe handling, gripper opening with release spring (self-opening)

Application range

SAE quick-release couplings on fuel lines

Order number
9539 641 182

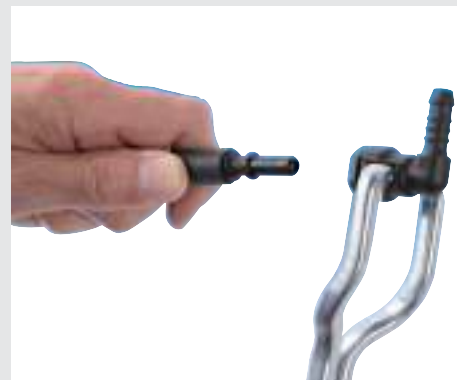

KUNZER
Qualität verbindet

Disconnecting pliers

universal, Type 7DSKG01

needed when changing fuel filters which are equipped with quick-release couplings, prevents damage to the SAE quick-release couplings

Application range

SAE quick-release couplings on fuel filters

Order number
9539 641 183



Technical equipment and accessories



Diagnosis interface unit

Uniprobe Truck

Module for measuring electrical values with USB connection or Bluetooth, the measurements available are multimeter, 4-channel oscilloscope, battery efficiency test and starter/alternator switching circuit (2nd generation), physical/electrical monitoring of CAN networks (2nd generation), high voltage test, integrated ignition coils, misfires and traditional pressure tests

Scope of supply

Strap, manual and software

Amp clamp BICOR3

- 10 mV/A from 0 to 200 A

- 1 mV/A from 0 to 1,200 A

absolutely necessary for testing starter and charging systems for vans and light commercial vehicles

Amp clamp BICOR4

- 1 V/A from 0 to 3 A

- 0.1 V/A from 0 to 30 A

absolutely necessary for all lost current tests

Order number
9539 003 363



Diagnosis unit

Navigator TXT IDC4 Plus light truck

universal self-diagnosis module for reading and deleting errors, actuator test, activations, numerical and graphical measured values indicator, recorder function, settings and programming

will be delivered ready for operation, including installation and on-site briefing

Scope of supply

- EOBD cable, USB cable, Bluetooth antenna, USB-Bluetooth antenna for PC, software licence IDC3 Plus Truck for PC with hardware dongle, strap, manual
- **Texpack Truck contract** - annual subscription for software updates¹
- **Tex@info Truck contract** - for Hotline, sending out information and Google® search function in problem database²

¹this contract results in subsequent costs of EUR 700 net per year from the 2nd year of use

²this contract results in subsequent costs of EUR 300 net per year from the 2nd year of use

	Order number
	9539 003 607



Accessories set

Truck voltage supply and adapter cables for Navigator TXT, module A/T-DIA and NAVIGATOR mobile, this set is essential for the use of further diagnosis cables

Version	Order number
3-piece	9539 003 405



Interface cable

for connecting vehicles to the diagnosis unit

Version 14-pin	Order number
	9539 003 292



For the fast service.



Diagnosis unit

Axone TRUCK Service

Convenient service unit, specially for the truck or bus company with their own small workshop who would like to perform standard maintenance themselves

- global scanning of all the control units installed in the vehicle with read-out and deletion of the fault codes stored there
- service reset for oil, brake linings and air filter
- clutch initialisation
- coding of injectors
- initialisation of terminal W (generator)
- air suspension level adjustment
- truck OBD scanning tool
- new generation Axone Direct (with new HD electronics) via cable
- SD memory card with special software
- advanced electronics with powerful processor for use on 24 V systems

Scope of supply

SD card with ATS software, OBD cable, kit for external update via PC

Order number
9539 003 550

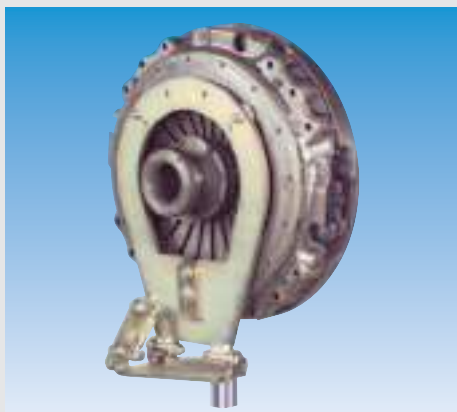

Assembly jig

cDISK, Pressure plates

Pressure plate fitting tool for the removal and installation of truck clutches, the pressure plates of which are very difficult to install and remove on account of their high net weight of up to 80 kg, the cDISK makes this task much easier. In combination with existing garage equipment (garage crane, crane, pit or floor lifting trolley), the pressure plate and/or the flywheel can be fitted easily by a single person. The adjustable angle of tilt and ROLLFIT system guarantee optimum working ergonomics.

Scope of supply

Basic tool, fitting arm, transport hoop, exchangeable pins 35, 45 and 55 mm

Order number
9534 004 200



Accessories set

cDISK

to take EvoBus pressure plates, the standard rollers are replaced by rollers from the additional kit

Load capacity 80 kg

Order number
9534 004 210



Flywheel adaptation

for pit lifts or floor lifts

positive-locking hold ensured by hexagonal screws

Surface yellow chromated
Diameter of hole circle 450 mm
Load capacity 80 kg
Weight 1.5 kg

Application range

can only be used in conjunction with cDisk base plate fitting tool

Order number
9534 004 205



Flywheel adaptation

for clutch OM 470-473

used for fast removal and installation of clutches on commercial vehicles, trucks and buses

Version	Locking and unlocking via push-button
Surface	electrogalvanized blue
Diameter of hole circle	480 mm
Weight	6 kg

Application range

can only be used in connection with cDisk base plate mounting device

Order number
9534 004 206



Pressure casing adaptation

for pit lifts or floor lifts

cDisk pressure housing modification for pressure plates with die-cast housing, safe hold in the disc spring thanks to rotatable locking catch necessary for Mercedes-Benz A 0072501404 and A 0072505204

Version	yellow chromated
suitable for	Mercedes-Benz
Load capacity	80 kg
Weight	6 kg

Order number
9534 004 215

Specialists in application

Always the special tool to suit your trailer

When you use the right tool, you can carry out any tricky repair or installation quickly and accurately. EUROPART will help you with the suitable special tool for a professional installation!

More information from:

www.europart.net



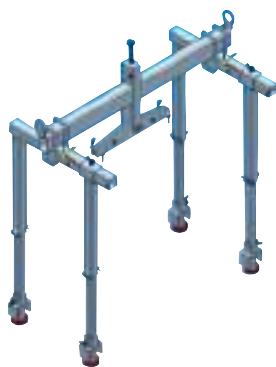

Engine support rig

can be positioned on the basic frame of the truck by a mounting crane, forklift or similar, each pair of feet can be adjusted transverse to the direction of travel, all four feet are height-adjustable, two of these can be adjusted in their longitudinal direction

Surface black, matt finish
 Diameter of hole circle 480 mm
 Load capacity 2000 kg

Scope of supply

2 chain slings

Application range

to support the following engines: HDEP, MDEG, 457, 500 and 900 on the Actros, Atego, Axor and Econic model series

Order number
9534 004 220

4

Technical equipment and accessories

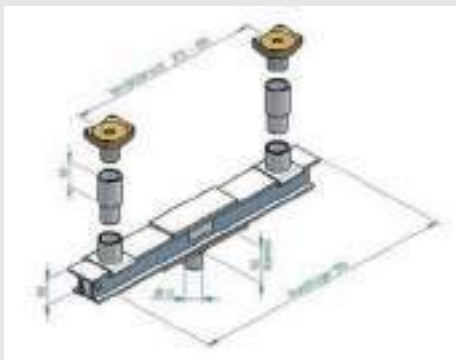

Axle traverse

According to the manufacturer, the new Actros (launched in autumn 2011) and its predecessor models can only be lifted with a two-point system. This applies to both the front and rear axles. Only in the case of on-the-spot breakdown repairs, e.g. on the motorway, may the vehicles be raised at a single point using a movable car lifter at the specified jack points. The carrying plates of the lorry axle traverse can be width-adjusted and height-adjusted at any jack points using spacers.

Height 349 mm
 Load capacity 14 t
 Adjustment range 370-850 mm

Scope of supply

2 sliders, 2 carrying plates X, 2 spacers DS 1

Traverses with different stud diameters or optional adapter sockets are available on request, at an additional cost!

Peg-Ø mm	Order number
35	9534 004 225
55	9534 004 226



Increased safety during maintenance and repair work

Lifting and supporting made easy!

Protect people and materials – use the position recommendations for lifting and supporting points on the supporting structure!

The vehicle should not be loaded when supported on the supporting structure (vehicle kerb weight). **Attention: Only in exceptional cases – if unloading is not possible – a loaded vehicle can also be supported (see position A-C).**



How it is done:

Lifting at position **F**

- at drawbar eyes with overall vehicle weight allowed

Lifting and supporting at position **A – C**

- with overall vehicle weight allowed

Supporting at position **D – E**

- with pressure distribution panel (e.g. wooden panel) with vehicle kerb weight allowed

+++ Safety information +++

Site regulations must always be observed when lifting vehicles.

According to accident prevention regulations, every lifted vehicle must be safely supported!

More information from:

www.europart.net

**EURO
PART**
... more than parts



KUNZER
Qualität verbindet

Unlocking tool set

for air-conditioning systems

for unlocking various quick-release couplings on air-conditioning systems, air, oil and fuel lines

Scope of supply

Plastic carrying case

Version

22-piece

Order number

9539 641 050



In the passenger car field the system is called DISTRONIC (DTR) and in the field of trucks and buses distance control speed control (ART)

Radar adjustment jig

suitable for Mercedes-Benz passenger cars, trucks and buses

The DISTRONIC, known as DTR in passenger cars and ART (distance control speed control) in trucks, is located in the radar eye on the front of the vehicle. It mainly comprises an aerial with transmitting and receiving unit, the beams of which collect traffic information up to a distance of 150 m in front of the vehicle. It calculates vehicle speed and ideal distance to the vehicle in front during driving, and if this distance becomes too small, the distance control speed control reduces acceleration, when the road is clear, it accelerates again to the set speed.

Using this device and its 3 different centring rings, all the radar heads in distance control systems ever installed at Mercedes either in passenger cars or trucks (e.g. Actros) and buses (EvoBus, Setra) can be adjusted.

Scope of supply

- adjustment equipment with 3 exchangeable centring rings for different vehicle types (passenger cars and trucks)
- laser project for 12 Volt battery with operating display (diode)
- vacuum bell
- spirit level
- helical connection cable with plug for 12 Volt battery (inverse polarity protected)
- catch chain
- adjustment housing with centring nest and self-test jig
- 2 marker sticks for wheel holders
- aluminium storage case

Order number

9539 500 010



Radar adjustment jig

ART adjustment equipment

Beam form: spot-shaped approx. 6 mm at 20 m

suitable for	EvoBus and Setra
Material	stainless steel, brass, anodized aluminium, magnetic steel
Operating temperature	-10 to +40 °C
Weight	1.3 kg
Range	50 m
Voltage	2.4-5 V
Current consumption	50 mA(2)

Scope of supply

built-in laser in laser attachment with switch and LED for function control, built-in battery compartment for 2 Mignon cells (AA, included in scope of supply), 3 base holders with magnetic bases and close-fit nest for laser attachment

Order number

9539 500 012



Brake maintenance unit

Vario 5-20 MO

one-main operation, intelligent technology with automatic control mechanisms, suitable for hydraulic clutches and gearshift control, stepless adjustment of pressure control range, with electronic deactivation

Contents	5 -20 l
Rate of delivery	over 40 l/h
Length of filling hose	3.5 m
Length of mains cable	5 m
Power supply	230-60 V
Pressure range	0-3,5 bar
Weight	22 kg
Temperature range	0 to 45 °C
Width x height x depth	400 x 850 x 330 mm

Mercedes-Benz approval (for work on the HPS2 gearshift control and clutch system with secondary surge tank on the Actros MP11, Atego and Axor)

Order number

9539 500 045



Accessories set

Type no. 102 MO, for brake maintenance unit

for filling and bleeding the clutch and gearshift control

Scope of supply

2 adapters, 3 hoses, canister

Version

6-piece

Order number

9539 500 048



KUNZER
Qualität verbindet

Oil filter cap set

Commercial vehicles

different cartridges and casings are used in oil and fuel tank filters for commercial vehicles; with this set, almost all oil and fuel filters found in commercial vehicles can be removed and installed.

Contents	9-piece
Colour	black
Material thickness	2.5 mm
suitable for	Size 36 mm, hexagon - Mercedes-Benz (e.g. Axor engine series 400, Atego engine series 900, Actros engine series 500, buses), Scania (PDE V8-engine, HP1-engine fuel filter), different oil and fuel filter casing covers Size 74 mm, 14-edges - MAN (series TGM and TGL), Mercedes-Benz (e.g. Sprinter engine series 600) Size 106 mm, 15-edges - MAN (8-10 tonnes series L 2000), Scania (PDE-engine, Fiat (Ducato 2,5 D/TD), Iveco Size 107 mm, 15-edges - Volvo, Iveco, Renault, Scania oil filters and fuel filters Size 108 mm, 15-edges - Volvo, Iveco, Renault, Scania oil filters and fuel filters Size 108 mm, 18 grooves - Renault transporters (Master, Traffic 2.4, 2.5, 2.8 D/TD), Opel (Movano) Size 135 mm, 18-edges - MAN 18-48 tonnes series F 2000, TGA, oil filter casing cover

Order number

9539 641 026



Motor oil

5W30

all-year motor oil, excellent cold start properties, keeps the charge air cooler extremely clean, has very long oil changing intervals up to 120,000 km, excellent smooth running properties, significantly reduced fuel consumption

Version synthetic

Specification API CI-4, ACEA E6-10/E7-10, MB 228.51, MAN M 3477, Volvo VDS III, Volvo CNG, MAN 3271-1, Renault RGD/RLD-RLD-2, MTU Type 3.1, Deutz DQC IV-05 / IV-10 LA, Mack EO-M Plus, Caterpillar ECF-2, DAF

Application range

specially developed for reduced-emission LOW SAPS EURO 4, EURO 5 and EURO 6 engines

Contents	Container	Order number
20 l	Canister	9773 000 007
55 l	Barrel	9773 000 008
200 l	Barrel	9773 000 009



Motor oil

10W40

universal smooth running oil for maximum oil change intervals, very good cold start properties, smooth engine running, very good shearing and ageing properties, modern additive technology and selected basic oils ensure optimum engine cleanliness, excellent light running and wear protection features

Version synthetic

Specification API CI-4, ACEA E6-10/E7-10, MAN 3277, MB 228.5, Volvo VDS III, Renault Truck RLD-2, MTU Typ 3, Deutz DQC III-05/IV-05, Scania LDF-2/LDF-3, Caterpillar ECF-1A/ECF 2

Application range

for heavy-load, exhaust-optimised diesel engines for commercial vehicles, can also be used in conventional naturally aspirated diesel and turbo diesel engines

Contents	Container	Order number
20 l	Canister	9773 000 031
55 l	Barrel	9773 000 032
200 l	Barrel	9773 000 033



Motor oil

15W40

for long oil-change intervals, KAT-tested, maximum wear protection, excellent ageing and viscosity stability, all-year motor oil, high-quality basic oils and a modern additive technology guarantee high power reserves and optimum wear protection characteristics for long oil change intervals, excellently suitable for vehicles with and without exhaust gas turbocharger

Version mineral
 Specification API CI-4/SL, ACEA A3-07/B3-04/E3-96/E5-02/E7-08, Jaso DH-1, MAN M 3275-1, MB 228.3, MB 229.1, Renault RLD-2, MTU Type 2, MACK EO-M+, Volvo VDSIII, John Deere JDQ 78 a, Caterpillar ECF-1A/ECF-2, Cummins CES 20076, 20077, 20078, Valtra CR, Komatsu

Application range

for universal use with a focus on modern diesel engines, but also suitable for a mixed vehicle fleet

Contents	Container	Order number
5 l	Canister	9773 000 002
20 l	Canister	9773 000 035
55 l	Barrel	9773 000 036
200 l	Barrel	9773 000 037



Antifreeze for pneumatic brakes

Wabcothyl

To prevent functional problems in all pneumatic brake systems, protects against damage caused by ice formation and does not corrode rubber nor metal parts.

Contents	Container	Order number
1 l	Bottle	0697 020 874
10 l	Plastic canister	0697 020 884
30 l	Plastic canister	0697 020 894





Screen wash

Guaranteed freezing protection up to -60 °C

DEKRA tested, suitable for fan nozzles, suitable for polycarbonate, biodegradable, methanol-free, not subject to VBF,

Mixing ratio (parts frost protection: water):

2:1 to -30 °C, 1:1 to -20 °C, 1:2 to -10 °C, 1:3 to - 5 °C, undiluted to -60 °C

Hand pump for chemicals and adapter for plastic barrels can be delivered on request.

Contents	Container	Order number
1 l	Bottle	9230 000 100
5 l	Canister	9230 000 200
20 l	Canister	9230 000 403
60 l	Barrel	9230 000 500
200 l	Barrel	9230 000 603

Accessories

Drain tap

suitable for	Order number
20 and 60 liter containers	9198 544 160
200 litre container	9198 544 162



Radiator protection

EP 12

Additive for the radiator, contains no nitrites, amines or phosphates and is **silicate-free**, protects the radiator from frost and corrosion, raises the boiling point of water. Can only be mixed with other G11 and G12 radiator antifreeze agents of the same quality! Can be used in MB325.3, MAN 324 SNF, VW TL 774 F (Audi, Seat, Skoda, VW), MTU MTL 5048, Porsche Carrera, Boxter, Cayenne. Suitable for aluminium engines. Based on 1,2-ethanediol (monoethylene glycol).

Contents	Container	Version	Order number
1.5 l	Bottle	-	9198 544 166
5 l	Canister	-	9198 544 168
20 l	Canister	-	9230 003 102
60 l	Barrel	incl. drain tap	9230 001 101
200 l	Barrel	2" barrel pump connection	9230 002 102



Piston pump

Version progressively operated
 Operating pressure 300 bar
 Voltage 24 V
 flow rate per revolution

Order number	9820 115 924	9820 015 924	9820 019 240
Type	KFGS1-5+924	KFG1-5	KFAS1
Container contents kg	2	2	1
Rate of delivery mm ³	180	180	200
Scope of supply	with container and control system, pump element, connection cable, mains adapter and fill level switch	with container, without control system, pump element, connection cable, mains adapter and fill level switch	with container, without control system, pump element and connection cable

Accessories

Low-viscosity grease

Divinol L 283

Contents	Container	Order number
5 kg	Cartridge	9909 021 121
15 kg	Can	9909 021 120

4

Technical equipment and accessories



Low-viscosity grease

GLP 00/000

shear-stable lithium-saponified semi-fluid grease, water resistant, oxidation and corrosion resistant, free of lead, barium and chlorine, offers very good protection against wear

Temperature resistance -40 to +120 °C
 Version wiht lithium soap
 Colour light green

Application range

can be used in central lubricating systems as well as for lubrication of gear mechanisms

Contents	Container	Order number
500 ml	Tube	9794 000 001
5 kg	Bucket	9794 000 002
15 kg	Hobbock	9794 000 003
25 kg	Bucket	9794 000 004
50 kg	Hobbock	9794 000 005



High-pressure grease

with graphite, NLGI-Class 2

for the lubrication of roller and plain bearings, provides corrosion protection, high pressure-absorbing properties, seawater-proof

Temperature resistance -30 to +130 °C

Application range

for agricultural machinery, construction machinery, diggers, trucks, tractors, stone-breakers, articulated trucks, lifts, loading equipment, conveyer belts and water pumps

designation according to DIN 51 825: KPF 2 K-30

designation according to ISO/DIS 6743-9: ISO-L-XCCHB 2

Contents	Container	Order number
400 g	Cartridge	9794 000 015
5 kg	Bucket	9794 000 016
25 kg	Bucket	9794 000 018



High-pressure grease

with MoS₂

for use as plain and roller bearing grease for high-strain lubricant spots, ensures improved corrosion protection behaviour

Temperature resistance -30 to +120 °C, briefly +130 °C

Colour black

Application range

for motor vehicles, devices, machines, conveyer systems, construction machinery etc.

designation according to DIN 51 825: KPF 2 K-30

designation according to ISO/DIS 6743-9: ISO-L-XCCHB 2

Contents	Container	Order number
400 g	Cartridge	9230 000 380
1 kg	Can	9230 000 385
5 kg	Bucket	9794 000 027
25 kg	Bucket	9794 000 029



Single-handed grease guns set

for 400 g cartridges and loose grease, with filling and bleeding nipple (can be filled with filling device), new, ergonomically optimised heavy-duty design, 2 connections (horizontal or vertical), thus optimal accessibility even in tight spaces

Pressure, max. 300 bar

Order number
9534 794 002



Permanent grease

suitable for permanent lubrication, excellent corrosion protection, water-resistant, good adhesive properties, can withstand pressure

Temperature resistance -30 to +120 °C, briefly up to +140 °C

Version wiht lithium soap

Colour blue

Application range

Motor vehicles, industrial machines and equipment

possible description according to DIN 51502: KP2K-30

Contents	Container	Order number
400 g	Cartridge	9794 000 008
500 g	Screw-type cartridge	9794 000 009
5 kg	Bucket	9794 000 010
15 kg	Hobbock	9794 000 011
25 kg	Bucket	9794 000 012
50 kg	Hobbock	9794 000 013



Multi-purpose grease

KL 2 K

lithium soap lubricating grease, with a smooth free texture, squeeze-stable, resistant to oxidation, for use as a grease for plain and rolling contact bearings, ensures improved corrosion protection behaviour

Temperature resistance -30 to +120 °C, for short periods up to +130 °C

Standard NLGI-Class 2

Version wiht lithium soap

Colour natural

Application range

for motor vehicles, devices, machines, conveyer systems, construction machinery etc.

designation according to DIN 51 825: K 2 K-30

designation according to ISO/DIS 6743-9: ISO-L-XCHHA 2

Contents	Container	Order number
400 g	Cartridge	9794 000 021
5 kg	Bucket	9794 000 022
15 kg	Bucket	9794 000 023
25 kg	Hobbock	9794 000 024
50 kg	Hobbock	9794 000 025
180 kg	Barrel	9794 000 026



Gear oil

Hypoid SAE 85W-90

maximum pressure absorbing properties, reduces wear and running noise, compatible with all sealing materials, high-performance high-pressure gear oil, made of carefully selected basic oils and multi-functional extreme-pressure additives

Version mineral

Specification API GL-5, MIL-L-2105 D, Renault GL-5 Axle, Volvo 97310+97316, DAF, ZF TE-ML 05A/07A/16B/16C/16D/17B/19B/21A, Voith 3.325-339, MAN 342 M1, MB 235.0

Application range

for maximum-load vehicle gears, particularly axle gears with hypoid

Contents	Container	Order number
1 l	Bottle	9773 000 000
5 l	Canister	9773 000 001
20 l	Canister	9773 000 015
55 l	Barrel	9773 000 016
200 l	Barrel	9773 000 017



Gear oil

ATF Dexron IID/IIIG

liquid gear oil, excellent corrosion protection with very high ageing stability, guarantees perfect functioning of liquid gears even under the most difficult of operating conditions and large temperature fluctuations

Specification GM Dexron III G, GM Dexron II D, GM Dexron TASA, Ford Mercon 2004, Voith H55.6335.3x, Allison C-4, Caterpillar TO-2, MAN 339 V1/Z1, MB 236.6, Renk, Sperry Vickers, Sundstrand, Volvo 97340, Volvo 97341*, ZF TE-ML 02F, 03D, 04D, 05L, 09, 11B, 14A

Application range

for use in mechanical manual gearboxes, automatic gears, in torque converters as well as in power steering where a lubricant of this specification is prescribed

Contents	Container	Order number
1 l	Bottle	9773 000 018
20 l	Canister	9773 000 019
55 l	Barrel	9773 000 020
200 l	Barrel	9773 000 021



**EURO
PART**

Hydraulic oil

HLP 46

with anti-wear and anti-corrosion additives, based on high-quality mineral oils, meets the requirements for hydraulic oils according to DIN 51 524 part 2, HLP

Application range

for all hydraulic systems where HLP oils are recommended, for hydraulic controllers and torque converters, for precision hydraulics and lifting equipment, for hydraulic systems where high thermal loads can occur

Contents	Container	Order number
1 l	Bottle	9773 000 022
5 l	Canister	9773 000 023
55 l	Barrel	9773 000 024
200 l	Barrel	9773 000 025



**EURO
PART**

Brake fluid

DOT 4

high-grade synthetic brake fluid which has been especially developed for use in brake systems with drum and/or disc brakes, suitable for all hydraulic car brake and coupling systems, except for systems using mineral oil, can be mixed with all brake fluids that meet the same requirements

Specification complies with: FMVSS 116 DOT 4 (Federal Motor Vehicle Safety Standard), SAE J 1703, ISO 4925

Wet boiling point 170 °C

Dry boiling point 260 °C

Also suitable for vehicles with ABS.

Contents	Container	Order number
1 l	Bottle	9785 000 015
5 l	Canister	9785 000 016
20 l	Canister	9785 000 017
60 l	Barrel	9785 000 018
208 l	Barrel	9785 000 019



Battery acid

To "activate" (prime) dry pre-charged batteries!

specific weight of 1.28 kg/l

Contents	Container	Order number
35 kg	Canister	9560 000 150
75 kg	Canister	9560 000 140



Urea solution

AdBlue®, for reduction of the NOx emission

Contents	Container	Order number
10 l	Canister	9066 170 007
210 l	Barrel	9066 170 200



Urea solution

AdBlue®, for reduction of the NOx emission

To keep new emission regulations defined by the EU, diesel vehicles are equipped with SCR technology (selective catalytic reduction). In the SCR process, the high NOx emissions that are produced during optimised combustion in the engine are post-treated in a catalytic converter. The reducing agent AdBlue® is necessary for this process, it is a non-toxic and odourless urea solution, in an exactly defined concentration. AdBlue® is sprayed in an exactly defined dosage through nozzles into the exhaust flow, where it hydrolyses and then causes conversion of the nitrogen oxides (NOx) into nitrogen (N) and water (H₂O).

Scope of supply

without the pump unit shown

The 1000 l container can be collected free of charge

Contents	Container	Order number
1,000 l	Container	9066 170 008

Accessories

Tank pump

Version	Order number
with automatic petrol pump nozzle	9066 170 010



Tank pump

Basic pump without meter

suitable for 1000 l container
 Rate of delivery 40 l/min
 Version with manual petrol pump nozzle

Order number
 9066 170 014



Pump nozzle

for AdBlue® urea solution

suitable for Basic pump
 Version manual

Order number
 9066 170 030



Tank pump

for AdBlue® urea solution

Low risk of contamination with AdBlue®, suitable for IBC and barrels

Version **With adjustable speed**
 Length of tube 1150 mm
 Voltage 220-240 V

Order number
 9539 488 600

Accessories

Description	Order number
Flow counter	9539 488 601
Pump nozzle, Type 0204-450	9539 488 602
Adapter, Type BCS 56 x 4	9539 488 610
Adapter, Type G 2"	9539 488 611
Adapter, Type BCS 70-6	9539 488 612
Test strips for detecting diesel and oils in AdBlue®	9682 202 412



Test device

equipped with automatic temperature compensation (ATC), easy to read, adjustable eyepiece

Application range

for measuring AdBlue®, anti-freeze coolant G11/G12/G13, anti-freeze screen wash systems, battery acid density

Order number
 9500 100 529

A

Accessories set for Navigator TXT	Technical equipment and accessories.....	358
Accessories set cDISK	Technical equipment and accessories.....	360
Accessories set for brake maintenance unit	Technical equipment and accessories.....	365
Air deflector	Actros.....	99, 100
Air deflector	Axor	199
Air deflector	Atego.....	295, 296
Air dryer.....	Actros.....	52, 53
Air dryer.....	Axor	172-174
Air dryer.....	Atego.....	260, 261
Air filter	Actros	8, 11
Air filter	Axor	135, 137
Air filter	Atego.....	219
Air horn	Technical equipment and accessories.....	318
Air horn kit.....	Technical equipment and accessories.....	318
Air reservoir tensioning strap	Actros	55
Air reservoir tensioning strap	Axor	175
Air reservoir tensioning strap	Atego.....	263
Air spring.....	Actros	30-32
Air spring.....	Axor	152-154
Air spring.....	Atego.....	236, 238
Air spring bellows	Actros	31
Air-conditioning compressor	Actros	109
Air-conditioning compressor	Axor	207
Air-conditioning compressor	Atego.....	304
Alternator	Actros	85, 86
Alternator	Axor	193, 194
Alternator	Atego	288-290
Antifreeze for pneumatic brakes	Technical equipment and accessories.....	367
Assembly jig	Technical equipment and accessories.....	360
Assembly key	Technical equipment and accessories.....	345
Assortment case for VOSS connector system 230	Actros	68
Assortment case for VOSS connector system 232	Actros	69
Assortment case for VOSS connector system 230	Axor	184
Assortment case for VOSS connector system 232	Axor	185
Assortment case for VOSS connector system 230	Atego.....	274
Assortment case for VOSS connector system 232	Atego.....	275
Attachment screw for brake disc	Actros	46
Attachment screw for brake disc	Axor	166
Attachment screw for brake disc	Atego.....	254
Auxiliary flasher light.....	Axor	188
Auxiliary flasher light.....	Atego.....	282, 283
Axle leg bolt press.....	Technical equipment and accessories.....	353
Axle leg bolt press set.....	Technical equipment and accessories.....	353
Axle nut	Actros	43
Axle nut	Axor	162
Axle nut	Atego.....	246
Axle traverse.....	Technical equipment and accessories.....	362

B

Ball joint.....	Actros.....	35, 37
Ball joint.....	Axor	157, 158

Ball joint	Atego	240, 242
Ball joint extraction tool	Technical equipment and accessories	345
Basic set commercial vehicle silent bearing	Technical equipment and accessories	339
Battery acid	Technical equipment and accessories	374
Battery charger	Technical equipment and accessories	350
Bit assortment	Technical equipment and accessories	340
Blower	Actros	109, 110
Blower	Axor	207
Blower	Atego	304
Bottle cooler	Technical equipment and accessories	327
Brake caliper	Actros	49, 50
Brake caliper	Axor	168, 169
Brake caliper	Atego	256, 257
Brake caliper carrier	Actros	50
Brake caliper carrier	Axor	169
Brake caliper carrier	Atego	257
Brake disc	Actros	46
Brake disc	Axor	166
Brake disc	Atego	252
Brake drum	Actros	51
Brake drum	Axor	170
Brake drum	Atego	259
Brake fluid	Technical equipment and accessories	373
Brake lining set	Actros	51
Brake lining set	Axor	171
Brake lining set	Atego	259
Brake maintenance unit	Technical equipment and accessories	365
Brake pad set	Actros	48
Brake pad set	Axor	167
Brake pad set	Atego	254, 255
Brake spring pliers	Technical equipment and accessories	349
Braking-value sensor	Actros	55
Braking-value sensor	Axor	176
Braking-value sensor	Atego	263
Bulb	Technical equipment and accessories	331, 332
Bumper	Actros	89-91, 93
Bumper	Axor	196, 197
Bumper	Atego	293
Bumper corner	Actros	91, 93
C		
Cabin filter	Actros	112
Cabin filter	Axor	208
Cabin filter	Atego	305, 306
Cabin filter/pollen filter	Actros	112
Cabin filter/pollen filter	Axor	208
Cabin filter/pollen filter	Atego	306
Case for hazardous goods	Technical equipment and accessories	336
Castle nut wrench	Technical equipment and accessories	347
Central module	Actros	67
Central module	Atego	272
Charge air cooler	Actros	13, 14

Charge air cooler	Axor	138
Charge air cooler	Atego	221
Charge air hose	Actros	14
Charge air hose	Axor	138
Charge air hose	Atego	221
Charging pressure sensor	Actros	13
Charging pressure sensor	Axor	137
Charging pressure sensor	Atego	221
Clearance light	Actros	80
Clearance light	Atego	284
Clutch kit	Actros	25, 26
Clutch kit	Axor	147
Clutch kit	Atego	232
Clutch servo	Actros	65
Clutch servo	Axor	182
Clutch servo	Atego	270
Combination brake cylinder	Actros	62, 64
Combination brake cylinder	Axor	180, 181
Combination brake cylinder	Atego	268, 269
Compact bearing	Actros	40
Compact bearing	Axor	159
Compressed air tank	Actros	54
Compressed air tank	Axor	175
Compressed air tank	Atego	262
Compressor cool box	Actros	87
Compressor cool box	Technical equipment and accessories	325
Condenser	Actros	109
Condenser	Axor	207
Condenser	Atego	304
Connecting rod bearing pair	Actros	11
Continuous pressure fire extinguisher	Technical equipment and accessories	337
Cool box	Technical equipment and accessories	325, 326
Coolant temperature sensor	Actros	16
Coolant temperature sensor	Axor	140
Coolant temperature sensor	Atego	223
Corner plate	Actros	98-100
Corner plate	Axor	199
Corner plate	Atego	295, 296
Coupling head	Actros	65
Coupling head	Axor	182
Coupling head	Atego	270
Cover plate	Actros	99
Cover plate for exterior mirror	Actros	108
Cover plate, A-pillar	Actros	100
Cover plate for front spoiler	Axor	198
Cover plate for corner plate, A-pillar	Axor	200
Cover for deflector, A-pillar	Atego	296
Crankcase seal set	Actros	4
Crankcase seal set	Axor	132
Crankcase seal set	Atego	216
Cylinder head gasket	Axor	133

Cylinder head gasket	Atego	217
Cylinder head gasket set	Actros	4
Cylinder head gasket set	Axor	132, 133
Cylinder head gasket set	Atego	216
Cylinder head repair kit	Actros	5
Cylinder head screw	Axor	134
Cylinder head screw	Atego	217
Cylinder head screw set	Actros	5
Cylinder head screw set	Axor	133
Cylinder liner	Actros	6
D		
Deflection pulley/guide pulley	Actros	22
Deflection pulley/guide pulley	Axor	145
Deflection pulley/guide pulley	Atego	230
Dehumidification valve	Actros	55
Dehumidification valve	Axor	176
Dehumidification valve	Atego	263
Diagnosis interface unit	Technical equipment and accessories	357
Diagnosis unit	Technical equipment and accessories	358, 359
Dipstick	Actros	7
Disconnecting pliers	Technical equipment and accessories	356, 357
Door extension	Actros	98
Door mat	Actros	119
Double-ended ring spanner set	Technical equipment and accessories	340
Drag-link	Actros	34
Drag-link	Axor	156
Drag-link	Atego	240
Drive shaft	Actros	27
Driver cab tilt cylinder	Actros	123
Driver cab tilting pump	Actros	123
Driver cab tilting pump	Axor	212
Driver cab tilting pump	Atego	309
Dual mass flywheel	Actros	25
Dual mass flywheel	Atego	231
E		
EBS axle modulator	Actros	57
EBS axle modulator	Axor	177
EBS axle modulator	Atego	265
EBS foot brake module	Atego	263
EBS relay valve	Actros	58
EBS relay valve	Axor	178
EBS relay valve	Atego	265
EBS trailer control valve	Actros	57
ECAS control unit	Actros	67
ECAS control unit	Atego	272
ECAS path sensor	Actros	66
ECAS path sensor	Axor	182
ECAS path sensor	Atego	271
ECAS solenoid valve	Actros	66, 67
ECAS solenoid valve	Axor	183
ECAS solenoid valve	Atego	271, 272

Electric motor	Actros	83
Engine bearing	Actros	4
Engine bearing	Axor	132
Engine bearing	Atego	216
Engine piston	Actros	4
Engine radiator	Actros	15
Engine radiator	Axor	139, 140
Engine radiator	Atego	222, 223
Engine support rig	Technical equipment and accessories	362
Entry	Axor	198, 199
Entry	Atego	293-295
Entry box	Actros	95-98
Evaporator	Actros	111
Exhaust turbocharger	Actros	12, 13
Exhaust turbocharger	Axor	137
Exhaust turbocharger	Atego	220, 221
Expansion valve	Actros	111
Expansion valve	Axor	208
Expansion valve	Atego	305
F		
Fan wheel	Actros	16
Fan wheel	Axor	141
Fan wheel	Atego	224
Fastening clamp for headlight	Actros	127
Fastening clamp for headlight	Atego	311
Fifth wheel	Technical equipment and accessories	314
Filing table	Actros	119, 120
Filing table	Axor	211
Filing table	Atego	308
Filling and bleeding device	Technical equipment and accessories	354
Filter dryer	Actros	110, 111
Filter dryer	Axor	208
Filter dryer	Atego	305
Filter wrench	Technical equipment and accessories	340
Fire extinguisher box	Technical equipment and accessories	338
Floor mat set	Axor	211
Flywheel	Actros	24
Flywheel	Axor	146
Flywheel	Atego	230, 231
Flywheel adaptation	Technical equipment and accessories	360, 361
Four-circuit protection valve	Actros	53
Four-circuit protection valve	Axor	174
Four-circuit protection valve	Atego	261
Front grille	Actros	88
Front grille	Axor	196
Front grille	Atego	292
Front mirror	Actros	106
Front mirror	Axor	204, 205
Front mirror	Atego	300
Fuel filter	Actros	8, 10
Fuel filter	Axor	135-137

Fuel filter	Atego	218-220
Fuel pump	Actros	7
Fuel pump	Axor	136
Fuel pump	Atego	218
Fuel tank	Actros	18, 19
Fuel tank	Axor	142, 143
Fuel tank	Atego	227
G		
Gas spring	Actros	123
Gasket full set	Axor	132
Gasket full set	Atego	216
Gasket set for wheel hub	Actros	42
Gasket set for wheel hub	Axor	161
Gasket set for wheel hub	Atego	245, 246
Gear oil	Technical equipment and accessories	372
Glass unit	Actros	105
Grille protective cover for fire extinguisher	Technical equipment and accessories	338
H		
H1 halogen headlamp bulb	Technical equipment and accessories	330
H1 main headlamp	Axor	186
H1 rotating beacon	Actros	81
H1 rotating beacon	Atego	287
H1 spotlight	Actros	127
H1 spotlight	Atego	310
H3 fog light	Actros	74, 75
H3 fog light	Axor	187
H3 fog light	Atego	280, 281
H3 halogen headlamp bulb	Technical equipment and accessories	330
H3 spotlight	Actros	73, 74
H3 spotlight	Axor	187
H3 spotlight	Atego	280
H4 halogen headlamp bulb	Technical equipment and accessories	330
H4 main headlamp	Actros	70
H4 main headlamp	Atego	279
H4/H1 main headlamp	Actros	71
H4/H1 main headlamp	Axor	186
H4/H1 main headlamp	Atego	276, 277
H7 halogen headlamp bulb	Technical equipment and accessories	331
H7/H1 main headlamp	Actros	72
H7/H1 main headlamp	Axor	187
H7/H1 main headlamp	Atego	277, 278
Half shell set for silent bearing replacement	Technical equipment and accessories	339
Hand brake valve	Actros	56
Hand brake valve	Axor	176, 177
Hand brake valve	Atego	264
Headlight bracket	Actros	126
Headlight bracket	Atego	310
Heat exchanger	Actros	108
High-pressure grease	Technical equipment and accessories	370
Hollow rubber spring	Actros	29
Hollow rubber spring	Axor	151

Hydraulic filter	Actros	8, 9
Hydraulic filter	Axor	135
Hydraulic filter	Atego	218, 219
Hydraulic oil	Technical equipment and accessories	373
I		
Impact corner	Atego	292
Impact driver socket	Technical equipment and accessories	343, 344
Impact socket	Technical equipment and accessories	341
Indicator light	Actros	75, 76
Indicator light	Axor	188, 189
Indicator light	Atego	281, 282
Indicator switch	Actros	82
Indicator switch	Axor	192
Indicator switch	Atego	287
Inlet valve	Actros	12
Interface cable	Technical equipment and accessories	358
K		
Kettle	Technical equipment and accessories	326
L		
Leak detector	Technical equipment and accessories	355
LED daytime running lights set	Actros	128
LED position lights set	Actros	128
LED position lights set	Atego	311
LED side marker light	Actros	79
LED side marker light	Axor	191
LED side marker light	Atego	283
Light switch	Actros	82
Low-viscosity grease	Technical equipment and accessories	369
M		
Magnet wheel inserter	Technical equipment and accessories	346
Main bearing set	Actros	11
Main mirror	Actros	105
Main mirror	Axor	204
Main mirror	Atego	300
Marking board	Technical equipment and accessories	333
Marking board set	Technical equipment and accessories	333
Membrane brake cylinder	Actros	63
Membrane brake cylinder	Axor	179, 180
Membrane brake cylinder	Atego	267
Microwave	Technical equipment and accessories	326
Mirror head	Actros	104
Mirror head	Axor	203
Mirror head	Atego	299
Motor coach brake valve	Actros	57
Motor coach brake valve	Axor	177
Motor coach brake valve	Atego	264
Motor oil	Technical equipment and accessories	366, 367
Motor turning gear	Technical equipment and accessories	349
Mounting bracket, outside mirror	Actros	107, 108
Mounting bracket, outside mirror	Axor	206
Mounting bracket, outside mirror	Atego	303

Multi-purpose grease	Technical equipment and accessories.....	371
N		
Number panel.....	Technical equipment and accessories.....	334
Numeral set.....	Technical equipment and accessories.....	334
O		
Oil cooler	Actros	27
Oil cooler	Axor	135
Oil filter.....	Actros	8, 9
Oil filter.....	Axor	136
Oil filter.....	Atego.....	219
Oil filter cap set	Technical equipment and accessories.....	365
Oil filter spanner.....	Technical equipment and accessories.....	346
Oil pan gasket.....	Actros.....	6
Oil pan gasket.....	Axor	134
Oil pan gasket.....	Atego.....	217
Oil pressure sensor	Actros.....	6
Oil pressure sensor	Axor	135
Oil pressure sensor	Atego.....	218
Oil pressure tester	Technical equipment and accessories.....	346
Oil separator	Actros.....	7
Output valve	Actros	12
P		
Parabolic spring.....	Actros.....	28, 29
Parabolic spring.....	Axor	150, 151
Parabolic spring.....	Atego.....	234, 235
Parking warning sign	Technical equipment and accessories.....	334
Pedal pad	Actros.....	119
Pedal pad	Axor	211
Pedal pad	Atego.....	308
Percolator	Technical equipment and accessories.....	327
Permanent grease.....	Technical equipment and accessories.....	371
Pin and groove nut set	Technical equipment and accessories.....	346
Pipe connection key set	Technical equipment and accessories.....	345
Piston pump	Technical equipment and accessories.....	369
Piston ring cable tie.....	Technical equipment and accessories.....	348
Piston ring pliers	Technical equipment and accessories.....	348, 349
Poly-V belt tensioner	Actros	23
Poly-V belt tensioner	Axor	145
Poly-V belt tensioner	Atego.....	229
Position light	Actros.....	76, 78
Position light	Axor	190
Position light	Atego.....	283
Powder fire extinguisher	Technical equipment and accessories.....	337
Power-steering pump	Actros	35
Power-steering pump	Axor	157
Power-steering pump	Atego.....	240, 241
Pressure casing adaptation.....	Technical equipment and accessories.....	361
Pressure pad set	Technical equipment and accessories.....	339
Pressure sensor.....	Actros.....	53, 54
Pressure sensor.....	Axor	174
Pressure sensor.....	Atego.....	261, 262

Pressure switch	Actros	82
Pressure switch	Axor	192
Pressure switch	Atego.	287
Pry bar set.	Technical equipment and accessories.	340
Pump nozzle	Technical equipment and accessories.	375
R		
Radar adjustment jig.	Technical equipment and accessories.	364
Radiator fan coupling	Actros	16
Radiator fan coupling	Axor	140
Radiator fan coupling	Atego.	224
Radiator pressure test tool set	Technical equipment and accessories.	345
Radiator protection	Technical equipment and accessories.	368
Ramp mirror	Actros	107
Ramp mirror	Axor	206
Ramp mirror	Atego.	303
Rear apron	Actros	90, 92, 94
Rear apron	Axor	196, 198
Rear light	Actros.	80, 81
Rear light.	Axor	191
Rear light.	Atego.	285, 286
Rear silencer.	Actros	18
Rear silencer.	Axor	141, 142
Rear silencer.	Atego.	224, 226
Rechargeable fire extinguisher.	Technical equipment and accessories.	337
Relay valve	Actros	58
Relay valve	Axor	178
Relay valve	Atego.	265, 266
Repair kit air compressor.	Actros.	7
Repair kit axle strut, torque rod	Actros	45
Repair kit axle strut, torque rod	Axor	165
Repair kit for fuel line	Technical equipment and accessories.	356
Repair kit for wheel hub	Actros	42
Repair kit for wheel hub	Axor	161
Repair kit for wheel hub	Atego.	245
Repair kit for wishbone.	Actros	44
Repair kit for wishbone.	Axor	164
Repair kit for wishbone.	Atego.	247
Repair kit Kingpin	Actros	38
Repair kit Kingpin	Axor	159
Repair kit Kingpin	Atego.	247, 248
Repair kit Truck	Technical equipment and accessories.	355
Retainer ring.	Atego.	250
Reversing video system	Technical equipment and accessories.	324
Ribbed V-belt	Actros	20
Ribbed V-belt	Axor	144
Ribbed V-belt	Atego.	228
Ribbed V-belt set	Actros	22
Rim lining.	Technical equipment and accessories.	322
Rim ring	Technical equipment and accessories.	321
Roof-mounted air-conditioning system for truck.	Actros	119
Roof-mounted air-conditioning system for truck.	Axor	209

Roof-mounted air-conditioning system for truck	Atego	306
S		
Screen wash	Technical equipment and accessories	368
Screwdriver set	Technical equipment and accessories	341
Sensor ring, ABS	Actros	50
Sensor ring, ABS	Axor	170
Sensor ring, ABS	Atego	258
Shaft sealing ring	Actros	41, 42
Shaft sealing ring	Axor	160
Shaft sealing ring	Atego	243, 245
Shock absorber	Actros	32, 33, 120-122
Shock absorber	Axor	155, 211, 212
Shock absorber	Atego	239, 309
Short-circuit and interruption detector	Technical equipment and accessories	354
Side marker light	Actros	79
Side marker light	Atego	284
Side window wind deflector	Axor	202
Side window wind deflector	Atego	298
Single-handed grease guns set	Technical equipment and accessories	370
Skirting protection bracket	Actros	124, 125
Skirting protection bracket	Atego	310
Skirting protection mini-brush	Actros	125
Slim V-belt	Actros	20
Socket set	Technical equipment and accessories	342, 343
Socket wrench insert	Technical equipment and accessories	342, 343
Solenoid control valve	Actros	60
Solenoid control valve	Axor	178
Solenoid control valve	Atego	266
Speed sensor	Actros	60
Speed sensor	Axor	179
Speed sensor	Atego	266
Splined bit	Technical equipment and accessories	344
Spring hoop	Actros	28, 30
Spring hoop	Axor	150, 152
Spring hoop	Atego	235, 236
Stabilizer mounting	Actros	36
Stabilizer mounting	Axor	157, 158
Stabilizer mounting	Atego	241
Start booster	Technical equipment and accessories	351
Starter battery	Technical equipment and accessories	328
Starter Motor	Actros	84
Starter Motor	Axor	192, 193
Starter Motor	Atego	288
Steering Track Rod	Actros	36, 37
Steering Track Rod	Axor	158
Steering Track Rod	Atego	241, 242
Step-up	Axor	196
Storage for propeller shaft	Actros	27
Storage for propeller shaft	Axor	148
Storage for propeller shaft	Atego	233
Stud accessories set	Technical equipment and accessories	353

Sunshade	Actros	102, 103
Sunshade	Axor	202
Sunshade	Atego	298
Surge tank	Actros	15
Surge tank	Axor	140
Surge tank	Atego	223
T		
Tank pump	Technical equipment and accessories	375
Tapered roller bearing	Actros	40, 41
Tapered roller bearing	Axor	159, 160
Tapered roller bearing	Atego	243
Test case for Denoxtronic I and II AdBlue® systems	Technical equipment and accessories	352
Test device for AdBlue®	Technical equipment and accessories	354, 375
Test strips for detecting diesel and oils in AdBlue®	Technical equipment and accessories	352
Thermostat	Actros	16
Thermostat	Axor	140
Thermostat	Atego	223
Toolbox	Technical equipment and accessories	317
Trailer hitch	Technical equipment and accessories	316
Trailing arm	Actros	44, 45
Trailing arm	Axor	164
Trailing arm	Atego	249
Transverse link	Atego	248
Truck driver's seat	Actros	113-118
Truck driver's seat	Axor	209, 210
Truck driver's seat	Atego	307, 308
U		
Underrun protection tube	Actros	126
Unlocking tool set	Technical equipment and accessories	364
Urea filter	Actros	10
Urea filter	Axor	137
Urea filter	Atego	220
Urea solution	Technical equipment and accessories	374
V		
Valve cover gasket	Actros	6
Valve cover gasket set	Axor	134
Valve cover gasket set	Atego	217
V-belt	Atego	228
Vehicle bracket for fire extinguisher	Technical equipment and accessories	338
W		
Warning flash lamp	Technical equipment and accessories	336
Warning panel	Technical equipment and accessories	333
Washer fluid pump	Actros	104
Washer fluid pump	Axor	203
Washer fluid pump	Atego	299
Water pump	Actros	14, 15
Water pump	Axor	138, 139
Water pump	Atego	222
Wheel bolt	Actros	45
Wheel bolt	Axor	165
Wheel bolt	Atego	249

Wheel cover	Technical equipment and accessories	318-321
Wheel hub	Actros	40
Wheel hub	Axor	159
Wheel hub	Atego	242
Wheel hub cover	Technical equipment and accessories	323
Wheel nut	Actros	45
Wheel nut	Axor	165
Wheel nut	Atego	250
Wheel nut cap	Technical equipment and accessories	323
Wheel stud cover ring	Technical equipment and accessories	322
Wide angle mirror	Actros	106
Wide angle mirror	Axor	205
Wide angle mirror	Atego	302
Window winder	Actros	83
Window winder	Axor	192
Window winder	Atego	287
Windscreen	Actros	102
Windscreen	Axor	202
Windscreen	Atego	298
Wing	Actros	101
Wing	Axor	200, 201
Wing	Atego	296, 297
Wiper blade	Actros	104
Wiper blade	Axor	203
Wiper blade	Atego	299
Wiper motor	Actros	104
Wiper motor	Axor	203
Wiper motor	Atego	299
Wrench for torque-type self-locking nuts	Technical equipment and accessories	341
X		
Xenon headlamp	Actros	71, 73

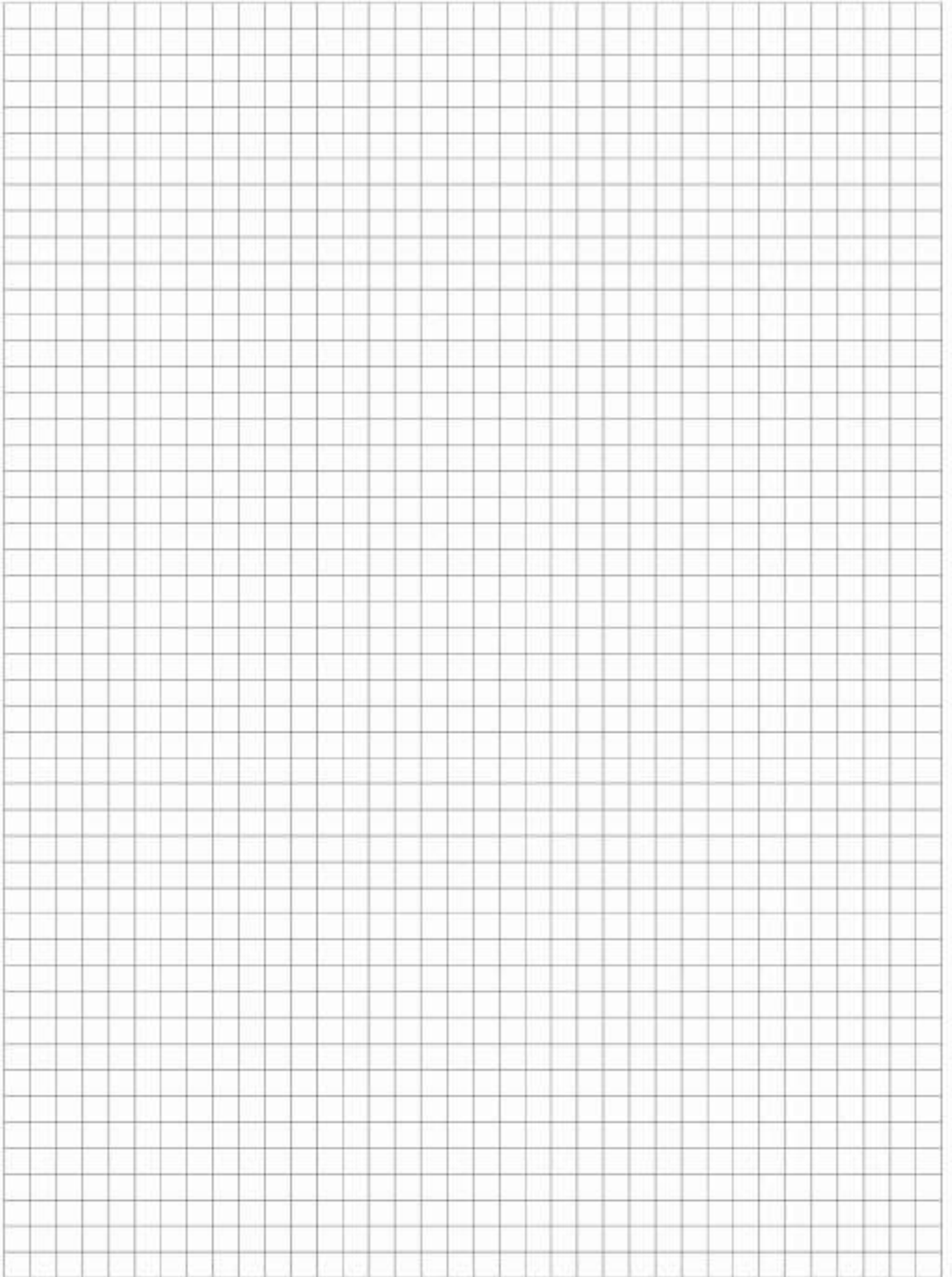

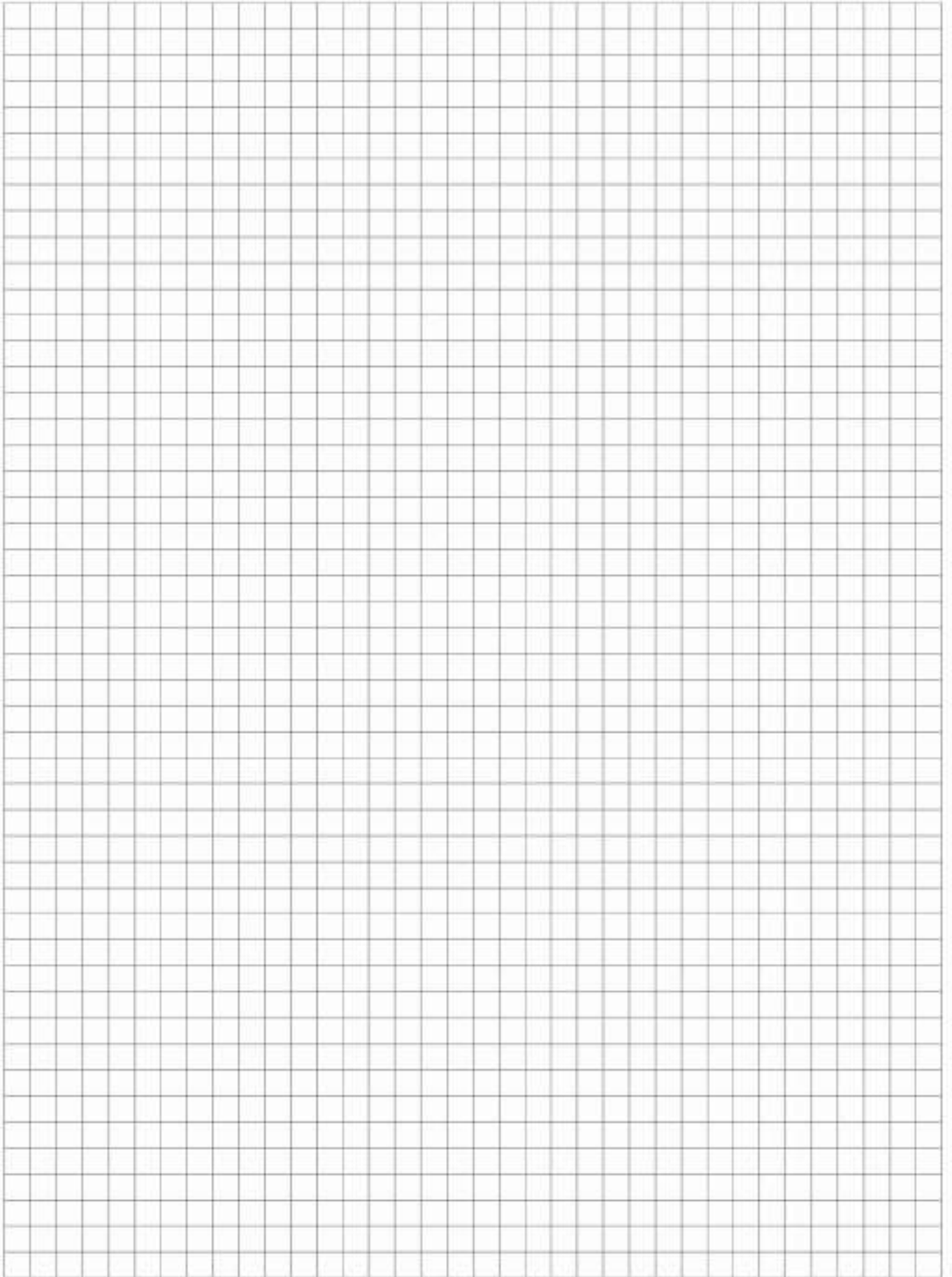

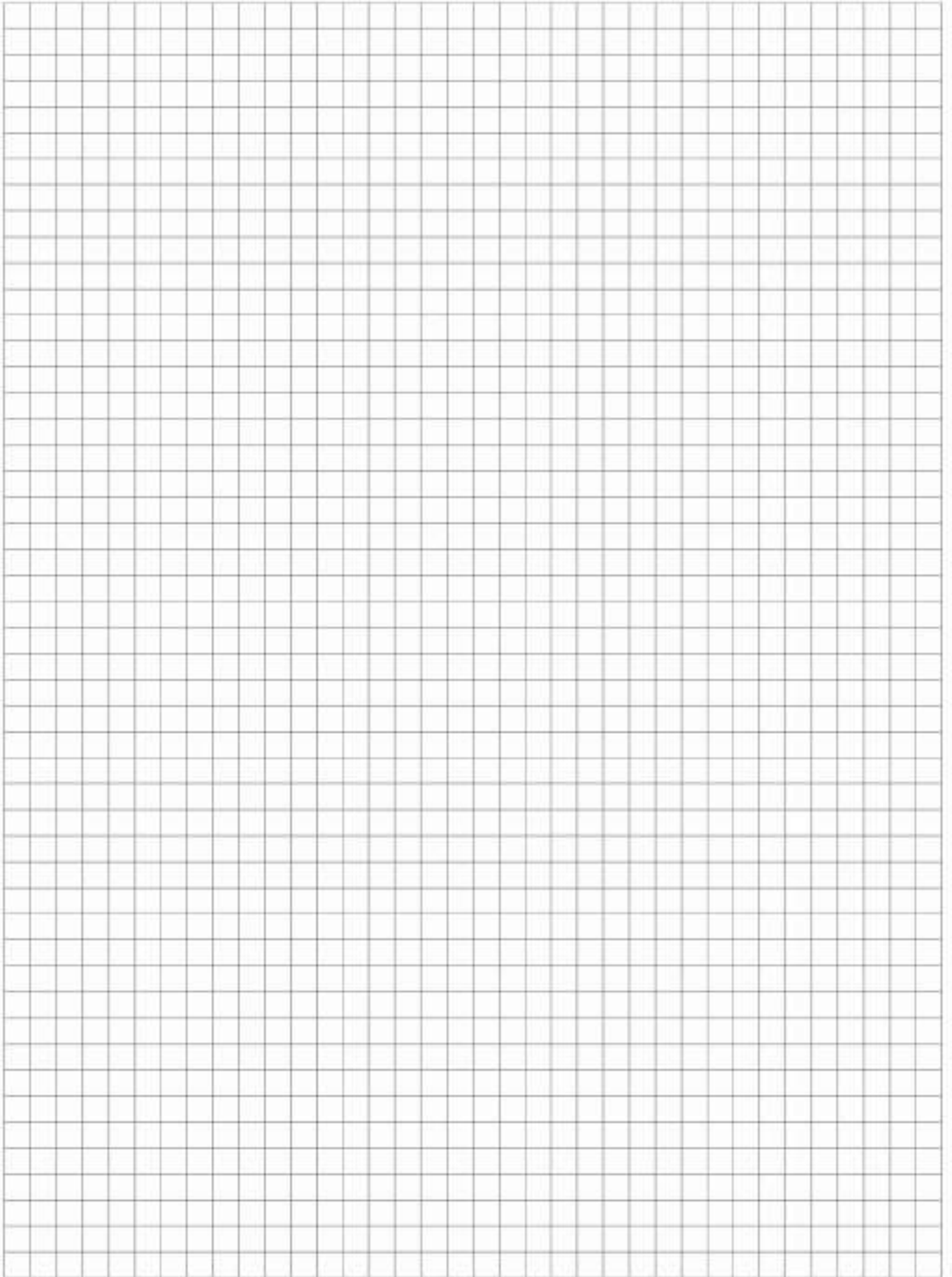

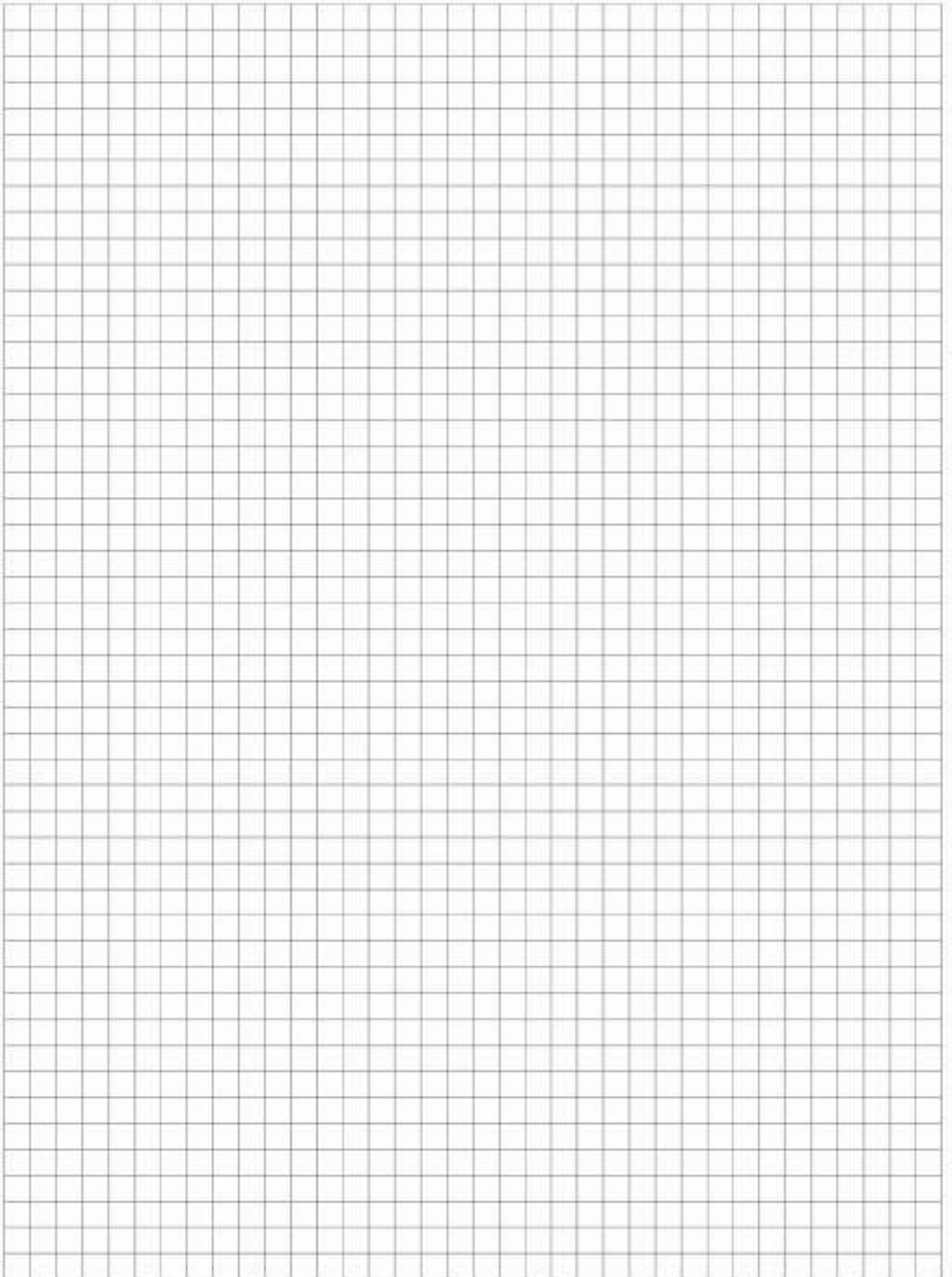

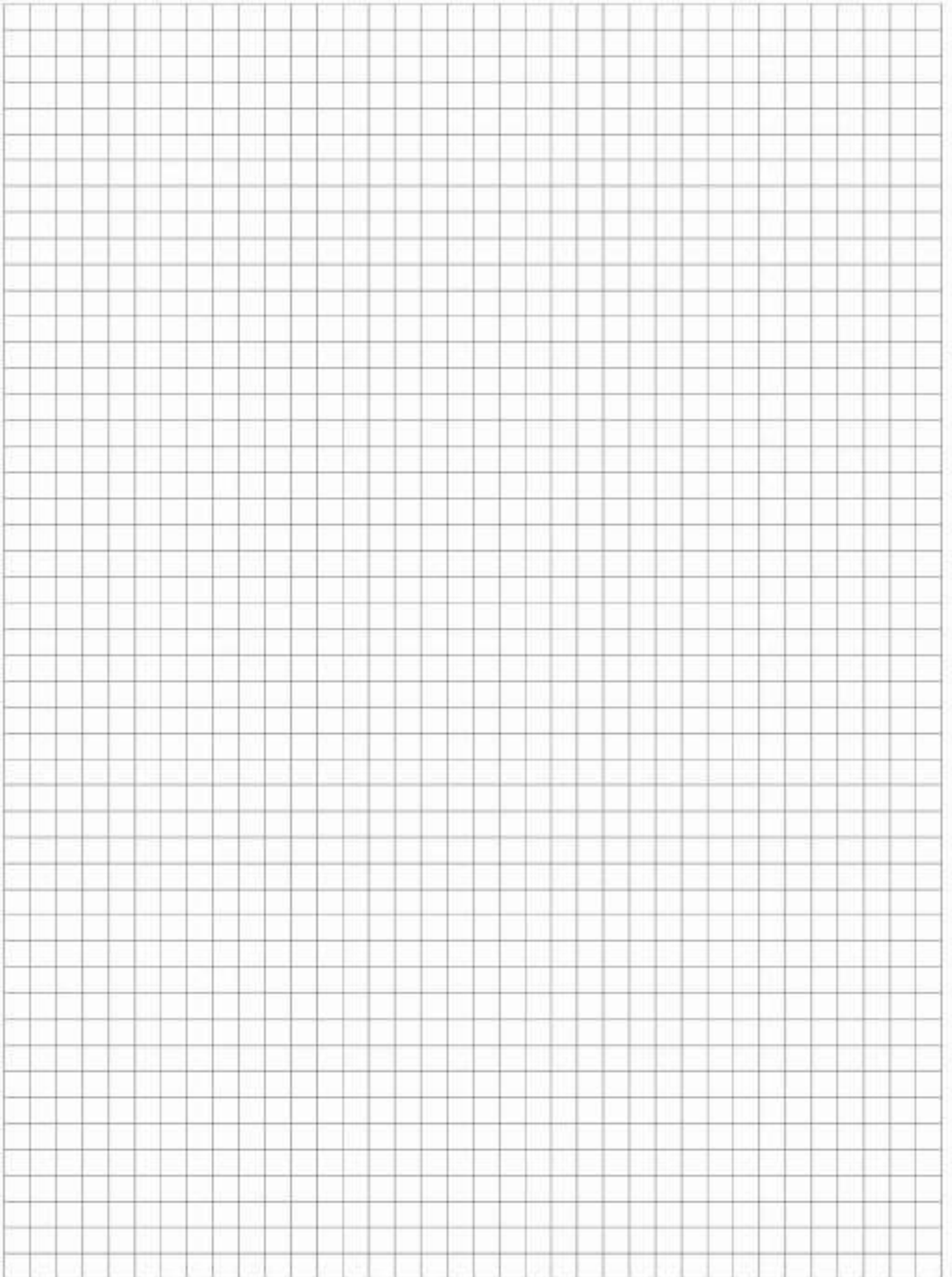

Find your nearest EUROPART sales outlet on the Internet at:

www.europart.net

- Jekaterinenburg
- Irkutsk
- Krasnojarsk
- Novosibirsk
- Tjumen

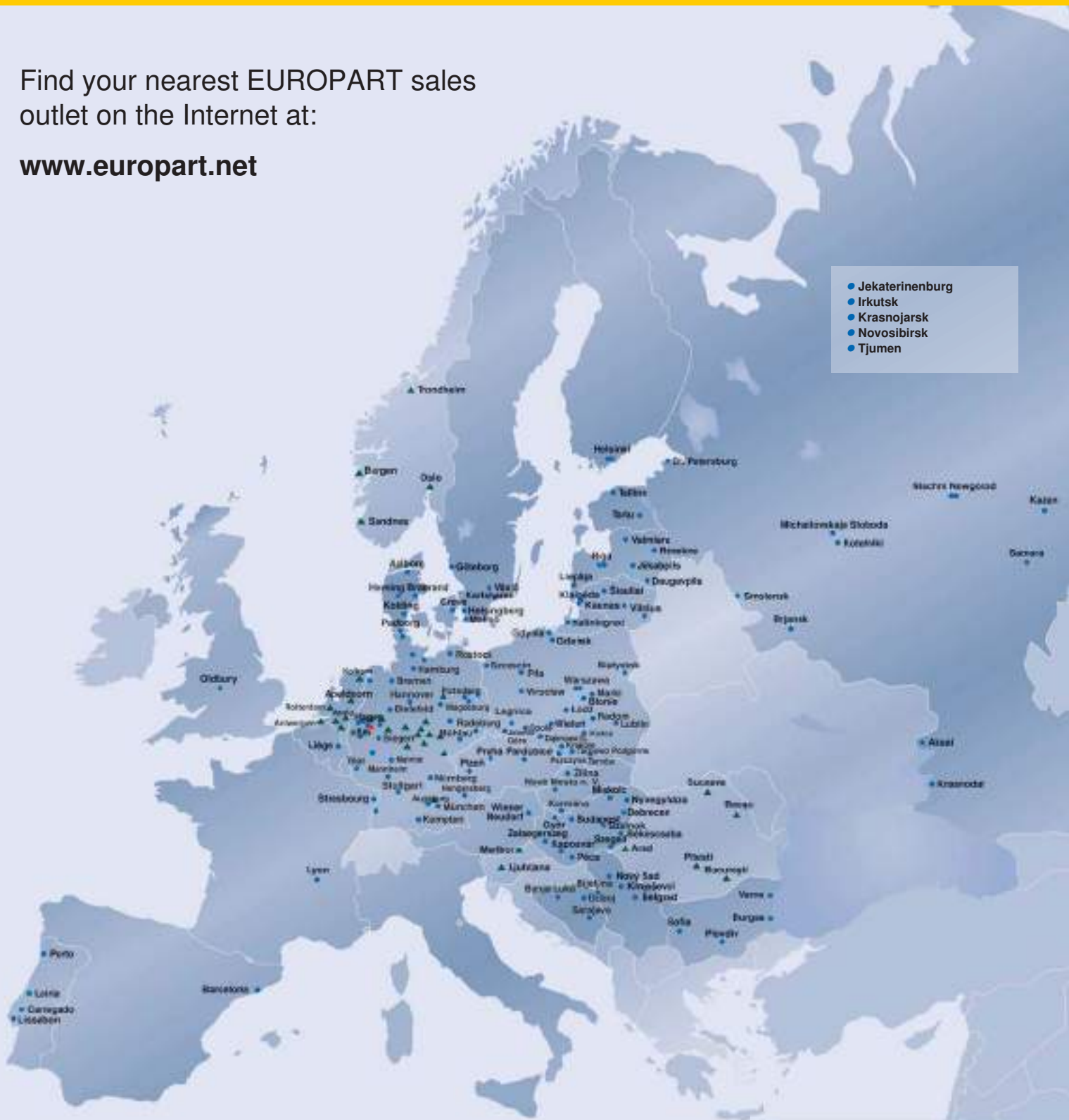

United Arab Emirates



EUROPART ranges for vehicle workshops:



Vehicle parts

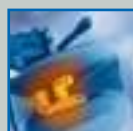

Truck spare parts



Trailer spare parts



Light commercial
spare parts

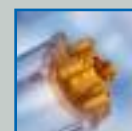

Bus spare parts



Passenger car
parts



Workshop requirements



Fastening systems



Workshop utilities



Operational safety and
environmental protection



Chemical-technical
products



Tools