



Mercedes-Benz
Unimog

Service

Workshops Manual UNIMOG 421-411

Volume 1

© DaimlerChrysler AG,
Produktbereich Sonderfahrzeuge/Unimog
D 76744 Wörth

Sämtliche Rechte der Verbreitung – in jeglicher Form und Technik
einschließlich der Einspeicherung in elektronische Medien – sind vorbehalten.

Technical details of the vehicle in relation to data and illustrations contained in this manual
are subject to change. All rights, including reprint, reproduction
or translation (also of extracts), reserved.

Buch&Bild hat 1994 vom Produktbereich Unimog das Copyright für den Nachdruck
der technischen Unimog-Oldtimer-Literatur erhalten.

WESTFIELD 4 x 4
Spares for MB Unimogs
Tel: +44 (0) 1524 791968
Fax: +44 (0) 1524 792653
sales@west-4x4.demon.co.uk

wessel@buchundbild.de
www.buchundbild.de

Änderungen vorbehalten
UKD 30 402 21 03
05.89

The present workshop manual comprises the descriptions of all important assembly, tuning, testing and reconditioning jobs.

The contents of the workshop manual are subdivided according to the groups known as such. The group index facilitates finding the individual groups, the list of contents of each group facilitates finding the individual jobs.

The pertinent data, adjusting values, dimensions and tolerances, as well as the special tools, are listed on the first pages of the respective groups.

The contents are divided according to unit versions and subdivided according to chapters and sections.

The contents are presented in the shape of smaller, individually complete sections. Each section begins with a new page 1 and is identified as follows (example):

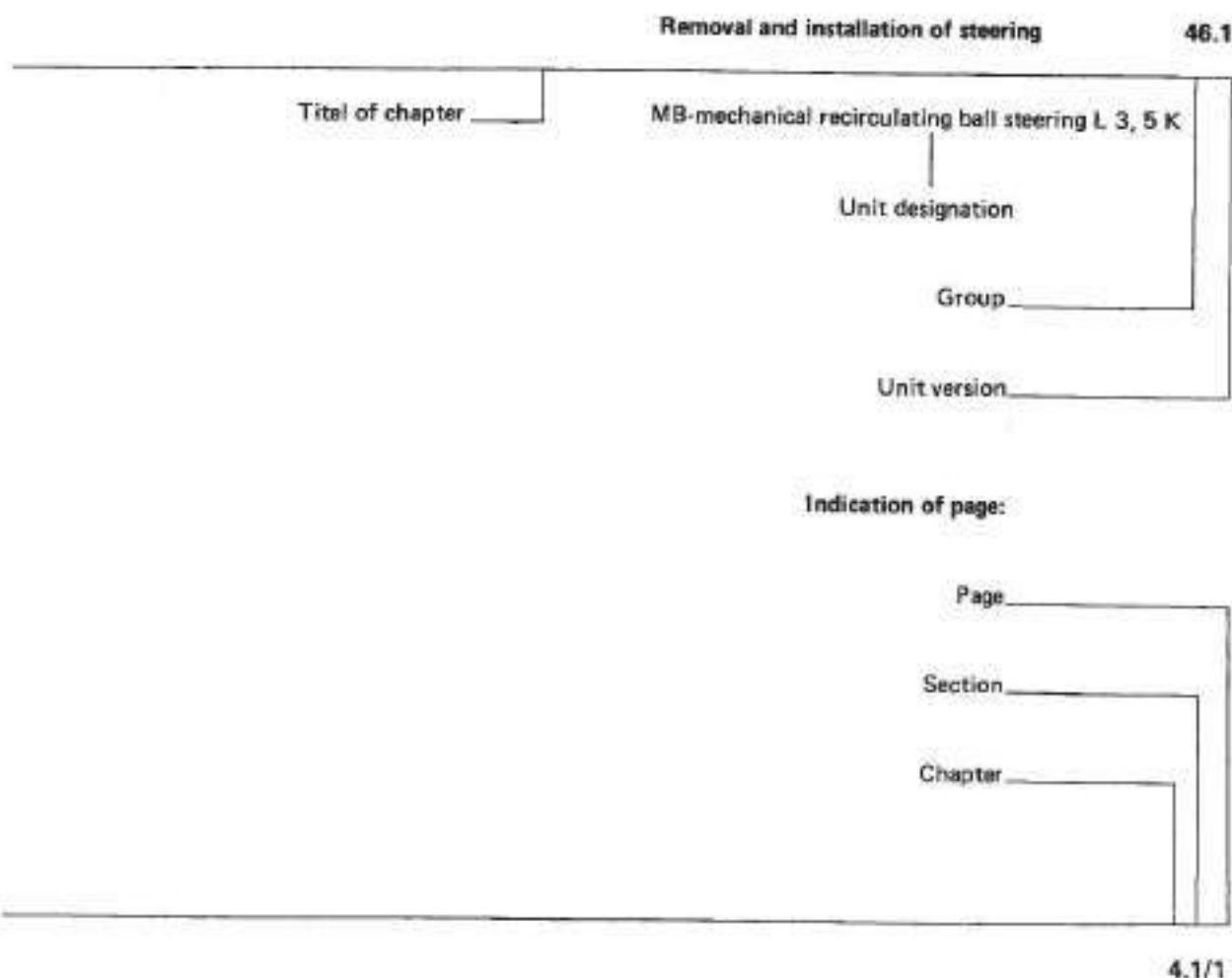

Any reference to this page, at any place in entire workshop manual says: Refer to 46.1-4.1/1.

Introduction

The unit versions are consecutively numbered starting at 1, that is, each version has its own code number. The unit designation of each page is additionally placed under head of each page. A separating sheet and a detailed list of contents is located in front of each unit.

The sections which are valid for all unit versions are covered in version 0.

The data (adjusting data, tightening torques, machining dimensions, etc.) and special tools are separately listed in front of each unit version.

The numerical values expressed in SI-units based on the new international unit system have been converted and rounded off (acc. to DIN 1335).

The pressure data specified in bar are gauge pressures.

Output in kW (kilowatt)

Former unit HP (horsepower)

$$1 \text{ kW} = 1.360 \text{ HP}$$

$$1 \text{ HP} = 0.735 \text{ kW}$$

Torque in Nm (newtonmeter)

Former unit kpm (kilopondmeter)

$$1 \text{ Nm} = 0.101\,972 \text{ kpm} \approx 0.102 \text{ kpm}$$

$$1 \text{ kpm} = 9.806\,65 \text{ Nm} \approx 9.81 \text{ Nm}$$

Pressure in bar (Bar)

Former unit kp/cm²

(kilopond per square centimeter)

$$1 \text{ bar} = 1.019\,716 \text{ kp/cm}^2 \approx 1.020 \text{ kp/cm}^2$$

$$1 \text{ kp/cm}^2 = 0.980\,665 \text{ bar} \approx 0.981 \text{ bar}$$

The specified part numbers, as well as the fig. number in exploded views are serving only for identification and better differentiation of the individual versions. When ordering spare parts, always use the part numbers from valid microfiches.

We shall do our best to keep this workshop manual continuously up to date by means of additional supplements.

Daimler-Benz Aktiengesellschaft
Werk Gaggenau
UNIMOG-Kundendienst

Contents

Chapter	page
1 General 421	
Installation survey	1.1/1
Overall view	1.2/1
Vehicle dimensions	1.3/1
Maximum speeds	1.4/1
Weights and trailer loads	1.5/1
Service products, capacities	1.6/1
2 General Type 411	
Technical data	2.1/1

Installation survey (starting chassis end No. 009 854, Sept. 1974)

Vehicle	Model designation	421.124/125	421.140/141	421.128/129	421.132/133
	Sales designation	U 52	U 600	U 600 L	U 600 T
	Wheelbase	2250 mm		2605 mm	—
Engine	Model designation	616.915 ¹⁾ ; 616.911		616.931 ²⁾ 616.932/933	616.930 ³⁾ 616.932
	Sales designation	616			
	Installation	standard		with SA 35 613	standard
Single clutch	Model designation	—			
	Sales designation	G 250 KR			
	Installation	standard			
Double clutch	Model designation	—			
	Sales designation	DT 240/225 N			
	Installation	special version SA 35 814			
Main transmission	Model designation	717.802 ⁴⁾			
	Sales designation	UG 2/27-6/14.53 GA			
	Installation	standard			
Auxiliary transmission	Model designation	—			
	Sales designation	VOG 2/27-2/1.26 and VOG 2/27-3/4.67 and VOG 2/27-4/42.88			
	Installation	special version SA 35 452			
Power takeoff	Model designation	—			
	Version	shiftable			
	Installation	special version SA 35 448			
Front axle	Model designation	737.003	737.005	737.004	737.003
	Sales designation	AU 2/2S-2.5	AU 2/2ES-2.6	AU 2/2S-2.5	AU 2/2S-2.5
	Installation	standard			
Rear axle	Model designation	747.007	747.009	747.008	—
	Sales designation	HU 2/2S-2.5	HU 2/2ES-2.6	HU 2/2S-2.5	—
	Installation	standard			
Steering	Model designation	—			
	Sales designation	ZF 7340 or ZF 8036			
	Installation	standard or special version SA 35 521			
Steering pump	Model designation	—			
	Sales designation	ZF 7672 or ZF 7673			
	Installation	special version SA 35 521			
PTO shaft displacement gears	Version	Input 1 ³ / ₄ " Output 1 ³ / ₈ "		—	
	Ratio	i = 1		—	
	Speed n _{max} 1/min	3000		—	
	Installation	special version SA 35 303		—	
Cab	Model designation	421.810 or 421.820			
	Sales designation	—			
	Installation	standard			

¹⁾ Up to chassis end No. 009 857²⁾ Up to chassis end No. 010 445³⁾ Up to chassis end No. 009 854⁴⁾ Also available with 2 x 4 shift (SA 35 451), but without auxiliary transmission

Overall view



URO0-0129

Vehicle dimensions¹⁾

Tire size		10.5-18
Wheelbase	mm	2250
Track width	mm	1403 ³⁾
Turning circle	m	9.1 to 9.25
Turning circle	mm	10350
Max. length	mm	4000
Max. width, all-steel driver's cab	mm	1825
Large width, Driver's cab with folding top	mm	1800
Vehicle height over driver's cab, unloaded	mm	2200
Vehicle height over tarpaulin frame, unloaded	mm	2290
Ground clearance	mm	387
Overhang angle at front	°	40
Overhang angle at rear	°	70
Ground clearance before-rear axle	mm	385
Fording depth	mm	755
Height of the trailer coupling unloaded	mm	720
No of seats in the driver's cab		2 (5) ²⁾

¹⁾ all specified values with units of measurement are approx. values

²⁾ Dual cabin

³⁾ with tires 7.5-18 8 PR 1393 mm
 10.5-20 8 PR 1489 mm
 8 PR 1393 mm

Loading area¹⁾

Length inside	short platform	mm	1475
	Long platform	mm	1753
Width inside		mm	1500
Height of the sideboard		mm	360
Loading height over ground unloaded		mm	1140
Effective area	short platform	m ²	2.2
	long platform	m ²	2.63

¹⁾ all specified values with units of measurement are approx. values

Max. speeds 6-speed gear shift

Total axle ratio		Max. speeds km/h at engine speed 3000/min and 3500/min									
		Engine speed 1/min	Forward speeds						Reverse speeds		Tires
8.3 ¹⁾	1		2	3	4	5	6	1	2		
Main gears	Main speeds	3000	3.94	7.13	12.72	23.02	34.76	57.26	4.92	8.92	7.5-18
		3500	4.60	8.32	14.84	26.86	40.55	67.00	5.74	10.41	10.5-18
		3000	4.22	7.64	13.64	24.68	37.27	61.39	5.28	9.57	10.5-20
		3500	4.92	8.91	15.91	28.79	43.48	72.00	6.16	11.17	
		3000	4.27	7.74	13.80	24.98	37.74	62.18	5.46	9.68	10.5R20
		3500	4.99	9.03	16.10	29.15	44.03	72.52	6.24	11.29	
		3000	4.26	7.73	13.79	24.96	37.69	62.08	5.34	9.67	12.5-18
		3500	5.07	9.18	16.35	29.61	44.72	73.66	6.34	11.47	7.5-20
		3000	4.58	8.26	14.72	26.64	40.24	66.28	5.70	10.32	
	3500	5.32	9.63	17.17	31.08	46.95	77.33	6.65	12.04	12.5-20	
	Additional crawler speeds ²⁾	3000	1.28	2.31	-	-	-	-	-	-	7.5-18
		3500	1.49	2.70	-	-	-	-	-	-	10.5-18
		3000	1.37	2.48	-	-	-	-	-	-	10.5-18
		3500	1.60	2.89	-	-	-	-	-	-	
		3000	1.38	2.50	-	-	-	-	-	-	10.5R20
		3500	1.61	2.91	-	-	-	-	-	-	
		3000	1.38	2.51	-	-	-	-	-	-	12.5-18
		3500	-	-	-	-	-	-	-	-	7.5-20
3000		1.47	2.66	-	-	-	-	-	-	12.5-20	
3500	-	-	-	-	-	-	-	-			
Auxiliary gears	Intermediate speeds	3000	3.13	5.56	10.09	18.25	27.57	45.41	3.90	7.07	7.5-18
		3500	3.65	6.59	11.77	21.29	32.17	52.98	4.55	8.15	10.5-18
		3000	3.35	6.07	10.82	19.57	29.56	48.69	4.19	7.58	10.5-20
		3500	3.91	7.06	12.62	22.83	34.49	56.81	4.88	8.84	
		3000	3.39	6.14	10.95	19.81	29.93	49.30	4.24	7.68	10.5R20
		3500	3.96	7.16	12.77	23.11	34.92	57.51	4.95	8.96	
		3000	3.39	6.13	10.94	19.79	29.89	49.24	4.23	7.67	12.5-18
		3500	-	-	-	-	-	-	-	-	7.5-20
		3000	3.62	6.55	11.67	21.13	31.92	52.57	4.52	8.19	12.5-20
	3500	-	-	-	-	-	-	-	-		
	Crawler speeds	3000	0.844	1.528	2.724	4.932	-	-	1.055	1.910	7.5-18
		3500	0.985	1.783	3.178	5.754	-	-	1.230	2.226	10.5-18
		3000	0.906	1.639	2.921	5.289	-	-	1.132	2.048	10.5-20
		3500	1.057	1.912	3.408	6.171	-	-	1.321	2.389	
		3000	0.917	1.659	2.957	5.353	-	-	1.146	2.074	10.5R20
		3500	1.069	1.936	3.450	6.246	-	-	1.337	2.42	
		3000	0.915	1.657	2.953	5.348	-	-	1.145	2.072	12.5-18
		3500	-	-	-	-	-	-	-	-	7.5-20
3000		0.977	1.769	3.153	5.708	-	-	1.22	2.212	12.5-20	
3500	-	-	-	-	-	-	-	-			
Worm gear speeds	3000	0.092	0.167	0.297	0.537	-	-	0.115	0.208	7.5-18	
	3500	0.107	0.195	0.347	0.627	-	-	0.134	0.243	10.5-18	
	3000	0.099	0.178	0.318	0.576	-	-	0.123	0.223	10.5-20	
	3500	0.116	0.208	0.371	0.672	-	-	0.144	0.260		
	3000	0.099	0.181	0.322	0.583	-	-	0.125	0.226	10.5R20	
	3500	0.116	0.211	0.376	0.680	-	-	0.145	0.263		
	3000	0.099	0.180	0.322	0.582	-	-	0.124	0.226	12.5-18	
	3500	-	-	-	-	-	-	-	-	7.5-20	
	3000	0.106	0.193	0.343	0.621	-	-	0.133	0.241	12.5-20	
3500	-	-	-	-	-	-	-	-			

¹⁾ Standard²⁾ cannot be fitted with sleeve shift

Max. speeds 6-speed gear shift

Total axle ratio 8.8 ¹⁾		Max. speeds km/h at engine speed 3000/min and 3500/min									
		Engine speed 1/min	Forward speeds						Reverse speeds		Tires
1	2		3	4	5	6	1	2			
Main gears	Main speeds	3000	3.71	6.72	11.99	21.70	32.77	53.98	4.64	8.41	7.5-18
		3500	4.33	7.84	14.00	24.35	38.25	63.00	5.42	9.82	10.5-18
		3000	3.98	7.21	12.86	23.27	35.14	57.88	4.98	9.02	10.5-20
		3500	4.65	8.41	15.02	27.15	41.00	67.60	5.81	10.52	
		3000	4.03	7.30	13.01	23.56	35.58	58.61	5.04	9.13	10.5R20
		3500	4.70	8.70	15.18	27.48	41.51	66.37	5.88	10.65	
		3000	4.02	7.29	13.00	23.53	35.53	58.53	5.03	9.12	12.5-18
		3500	-	-	-	-	-	-	-	-	7.5-20
		3000	4.39	7.94	14.15	25.62	38.70	63.75	5.48	9.91	12.5-20
	3500	-	-	-	-	-	-	-	-		
	Additional crawler speeds ²⁾	3000	1.20	2.18	-	-	-	-	-	-	7.5-18
		3500	1.41	2.54	-	-	-	-	-	-	10.5-18
		3000	1.29	2.34	-	-	-	-	-	-	10.5-20
		3500	1.51	2.73	-	-	-	-	-	-	
		3000	1.30	2.36	-	-	-	-	-	-	10.5R20
		3500	1.52	2.75	-	-	-	-	-	-	
		3000	1.30	2.37	-	-	-	-	-	-	12.5-18
		3500	-	-	-	-	-	-	-	-	7.5-20
3000		1.39	2.51	-	-	-	-	-	-	12.5-20	
3500	-	-	-	-	-	-	-	-			
Auxiliary gears	Intermediate speeds	3000	2.95	5.33	9.51	17.21	25.99	42.81	3.68	6.67	7.5-18
		3500	3.45	6.22	11.10	20.01	30.31	49.90	4.31	7.78	10.5-18
		3000	3.16	5.72	10.20	18.45	27.67	45.90	3.95	7.15	10.5-20
		3500	3.70	6.68	11.91	21.53	32.61	53.60	4.62	8.34	
		3000	3.20	5.79	10.32	18.68	28.22	46.48	3.99	7.24	10.5R20
		3500	3.73	6.76	12.04	21.80	32.92	54.22	4.66	8.44	
		3000	3.20	5.78	10.31	18.66	28.18	46.42	3.99	7.23	12.5-18
		3500	-	-	-	-	-	-	-	-	7.5-20
		3000	3.41	6.17	11.00	19.92	30.09	49.56	4.26	7.72	12.5-20
	3500	-	-	-	-	-	-	-	-		
	Crawler speeds	3000	0.796	1.441	2.568	4.850	-	-	0.995	1.801	7.5-18
		3500	0.928	1.682	2.990	5.420	-	-	1.161	2.105	10.5-18
		3000	0.854	1.545	2.754	4.986	-	-	1.067	1.931	10.5-20
		3500	0.998	1.804	3.230	5.820	-	-	1.245	2.254	
		3000	0.864	1.564	2.788	5.048	-	-	1.080	1.956	10.5R20
		3500	1.008	1.825	3.253	5.889	-	-	1.260	2.281	
		3000	0.863	1.562	2.784	5.042	-	-	1.079	1.953	12.5-18
		3500	-	-	-	-	-	-	-	-	7.5-20
3000		0.921	1.668	2.973	5.383	-	-	1.152	2.085	12.5-20	
3500	-	-	-	-	-	-	-	-			
Worm gear speeds	3000	0.067	0.157	0.280	0.506	-	-	0.108	0.196	7.5-18	
	3500	0.102	0.183	0.327	0.590	-	-	0.126	0.229	10.5-18	
	3000	0.093	0.168	0.300	0.543	-	-	0.116	0.210	10.5-20	
	3500	0.109	0.196	0.350	0.634	-	-	0.135	0.265		
	3000	0.094	0.170	0.303	0.549	-	-	0.118	0.213	10.5R20	
	3500	0.110	0.200	0.354	0.641	-	-	0.137	0.248		
	3000	0.094	0.170	0.304	0.549	-	-	0.117	0.213	12.5-18	
	3500	-	-	-	-	-	-	-	-	7.5-20	
	3000	0.100	0.182	0.324	0.586	-	-	0.125	0.227	12.5-20	
3500	-	-	-	-	-	-	-	-			

¹⁾ SA 38 555²⁾ cannot be fitted with sleeve shift

Max. speed 2 x 4-speed gear shift (SA 35 451)

Total axle ratio	Max. speeds km/h at engine speed 3000/min and 3500/min													Tires
	Engine speed 1/min	Forward speeds								Reverse speeds				
		1	2	3	4	5	6	7	8	1	2	3	4	
8.3 Main speeds	3000	3.94	7.13	10.78	17.75	12.72	23.02	34.76	57.26	4.92	8.92	13.47	22.18	7.5-18
	3500	4.60	8.32	12.58	20.71	14.84	26.86	40.55	66.80	5.74	10.41	15.72	25.88	10.5-18
	3000	4.22	7.64	11.55	19.03	13.64	24.68	37.27	61.39	5.28	9.57	14.45	23.78	10.5-20
	3500	4.92	8.91	13.48	22.20	15.91	28.79	43.48	71.62	6.16	11.17	16.86	27.74	
	3000	4.26	7.73	11.69	19.24	13.79	24.96	37.69	62.08	5.34	9.67	14.61	24.05	12.5-18
	3500	4.99	9.03	13.65	22.47	16.10	29.15	44.03	72.52	6.24	11.29	17.06	28.10	10.5R20 7.5-20
	3000	4.56	8.26	12.47	20.54	14.72	26.64	40.24	66.28	5.70	10.32	15.59	25.68	12.5-20
	3500	5.32	9.63	14.55	23.96	17.17	31.08	46.95	77.33	6.65	12.04	18.19	29.96	

Total axle ratio	Max. speeds km/h at engine speed 3000/min and 3500/min													Tires
	Engine speed 1/min	Forward speeds								Reverse speeds				
		1	2	3	4	5	6	7	8	1	2	3	4	
8.8 Main speeds	3000	3.71	6.72	10.16	16.73	11.99	21.70	32.77	53.98	4.64	8.41	12.70	20.91	7.5-18
	3500	4.33	7.84	11.86	18.84	14.00	24.35	38.25	63.00	5.42	9.82	14.83	24.41	10.5-18
	3000	3.98	7.21	10.89	17.94	12.86	23.27	35.14	57.88	4.98	9.02	13.62	22.42	10.5-20
	3500	4.65	7.41	12.71	21.85	15.02	27.15	41.00	67.60	5.81	10.52	15.90	26.20	
	3000	4.07	7.29	11.02	18.14	13.00	23.53	35.53	58.53	5.03	9.12	13.77	22.67	12.5-18
	3500	4.70	8.51	12.86	25.70	15.17	27.48	41.51	68.37	5.88	10.65	16.08	26.49	10.5R20 7.5-20
	3000	4.30	7.78	11.76	23.51	13.88	25.12	37.94	62.49	5.38	9.73	14.70	24.21	12.5-20
	3500	5.02	9.08	13.72	27.42	16.19	29.31	44.26	72.90	6.27	11.35	17.15	28.24	

Total axle ratio	Max. speeds km/h at engine speed 3500/min												Tires	
	Forward speeds								Reverse speeds					
	1	2	3	4	5	6	7	8	1	2	3	4		
7.62 ¹⁾														
Main speeds	5.04	9.13	13.80	22.43	16.28	29.46	44.51	73.30	6.31	11.41	17.25	28.40	10.5-18	
	5.13	9.63	14.55	23.66	17.16	31.07	46.94	77.30	6.65	12.04	18.19	29.95	10.5-20	
	5.43	9.84	14.86	24.16	17.53	31.73	47.94	78.96	6.79	12.30	18.58	30.59	10.5R20	
	5.52	9.99	15.09	24.54	17.81	32.23	48.69	80.20	6.90	12.50	18.87	31.07	12.5-18	
	5.80	10.49	15.84	25.77	18.69	33.84	51.12	84.19	7.24	13.11	19.81	32.62	12.5-20	

¹⁾ Applicable to vehicle model 421, 128/129

Weights and axle loads

Weights

Chassis Model	Sales designation	Version	Speed restriction to km/h	Tires Size	Type	PR	perm. axle loads		Weights Dead weight ¹⁾ kg	perm. payload kg	perm. gross vehicle kg													
							FA kg	RA kg																
421.124 .125	U 52	Standard	none	7.5-18	MPT	8	2100 2200 ²⁾	2100 2000 ²⁾	2850	1250	4100													
				10.5-18		6 10	2500	2500																
				10.5-20		6 8																		
.140 .141	U 600			10.5-18		6 8 10	2600	2600																
				10.5-20		8 10 14																		
.124 .125	U 52			with heavy attachments max. 40 km/h		none	12.5-18	MPT				8	2500	2500	2850	1250	4100							
												10	2600	2600										
.140 .141	U 600						10.5-18					MPT	6	3000				3000	2000	4850				
													10											
.124 .125	U 52						with snow clearing attachments max. 40 km/h					none	10.5-20	MPT				6	3550	3550	2850	5700		
		8																						
.140 .141	U 600	10.5-18	MPT		6				3400	3400	2650		5500											
					10																			
.124 .125	U 52	with heavy attachments max. 40 km/h	none		10.5-20				MPT	6	3550		3550					2850					5700	
										8														
.140 .141	U 600			10.5-18	MPT	6		3400		3400					2650	5500								
						10																		
.124 .125	U 52			with snow clearing attachments max. 40 km/h	none	10.5-20		MPT		6					3550	3550	2850							5700
										8														
.140 .141	U 600					10.5-18	MPT			6		3400		3400					2650	5500				
										10														
.124 .125	U 52					with heavy attachments max. 40 km/h	none			10.5-20		MPT		6					3550	3550	2850	5700		
														8										
.140 .141	U 600	10.5-18	MPT						6	3400	3400		2650	5500										
									10															

¹⁾ Following equipment are contained in dead weight:
cascade box, special PTO, hydraulic system, power lift, compressed air system, spare wheel, long auxiliary loading area, front and rear pto shaft and 80 kg for other equipment.

²⁾ 2100 kg with overall axle ratio 8.3

2200 kg with overall axle ratio 8.8

³⁾ heavy attachments and snow clearing attachments are not permissible.

⁴⁾ Operating instructions: The vehicle must be equipped with hydraulic steering and with speed plates 40 km/h. When driving the four-wheel drive must be switched on. It is not permissible to widen the track.

Trailer loads

Vehicle				Permissible trailer load kg		
Model	Sales designation	Version	Speed restriction kg	Trailer unbraked	Trailer braked not continuous brake system kg	Trailer braked continuous brake system kg
421.124 .125	U 52	Standard	–	1250	8000	13200
421.140 .141	U 600	in acc. with EEC	–	1425	8000	13100
421.124 .125	U 52	With heavy attachments four-wheel drive	20	1250	8000	12540
421.140 .141	U 600		40	1425	8000	12450
421.124 .125	U 52	With heavy snow clearing attachments four-wheel drive	30	None	None	None
421.140 .141	U 600		40			

Fluids, Filling Capacities

Group		Fluid (page no. of MB specifications for service products)	SAE Grade	Season	Capacity l	
Engine	with oil filter	Engine oil (226-227.1)	*)	*)	max. 7.0 min 4.5	
	of which in oil filter				0.8	
	oil bath air filter				1.0	
Transmission	Main transmission	Transmission oil (235.1)	80 ²⁾ 80w ⁶⁾ 80w/85w ⁶⁾ 85w/90 ²⁾ 90 ¹⁾	all year	6.0	
	– with auxiliary transmission and/without PTO		7.0			
	– with crawler gear (below)		7.0			
PTO shafts	PTO shaft bearing ¹⁾	Transmission oil (235.1)	80	all year	0.1	
	Displacement gears				1.4	
Axles	Differential housing	Hypoid transmission oil (235)	90	all year	2.5	
	Wheel hub drive				0.25	
	Differential lock	Initial operation oil (225.3)	10 W		0.001	
	Expansion tank for differential lock	Initial operation oil (225.3) or ATF ⁵⁾ (236.2)	10 W –		0.3	
Steering	Power steering	Engine oil (226, 227) or ATF ⁵⁾ (326.2)	10 W ²⁾ –	all year	2.0	
	mechanical	Transmission oil	80		0.6	
Hydraulic system	Oil reservoir, total	Engine oil (226, 227.1) or hydraulic oil (341)	10 W ³⁾ –	all year	15.0	
	when changing oil				13.0	
	perm. removal				7.0	
Brake system	Total capacity	Brake fluid ⁴⁾ (331.1)	–	all year	0.8	
Compressed air system	without antifreeze unit	Antifreeze (325)	–	all year	as required	
	with antifreeze unit	Ethyl alcohol			0.2	
Clutch actuation	Expansion tank	Brake fluid (331.1 or 331.2)	–	all year	0.2	
Lube nipple	Axle, universal shafts, power lift, chassis	Lubr. grease (266) or multipurpose grease (267)	–	all year	as required	
DB rope winch	Front	Type A	Transmission oil (235.1)	80	all year	0.75
		Type C				1.25
	Rear	Type 4000 H	ATF ⁵⁾ or engine oil (226/227/236.2)	– 10 W	all year	2.0

- ¹⁾ Permanent filling
²⁾ In cold zones use SAE 5W-20/30
³⁾ In hot zones use SAE 30, in cold zones SAE 5W-20/30
⁴⁾ Change once a year (safety rule)
⁵⁾ ATF oils must not be mixed with other oils
⁶⁾ Optional
⁷⁾ In hot zones
⁸⁾ Viscosity ranges

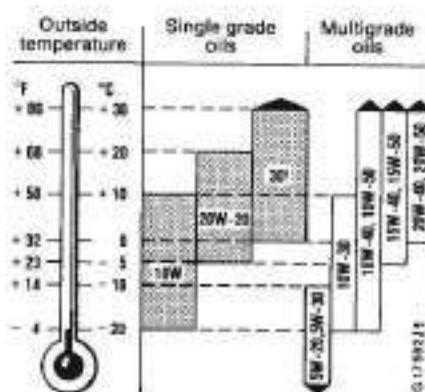

¹⁾ During continuous outside temperatures above +30 °C (86 °F) SAE 40 may be used.

Group		Fluid (page no. of MB specifications for service products)	Season	Capacity /
Battery	-Terminals	Anti-acid grease Ft40V1 (350)	all year	as required
	-Topping up	Distilled water		
Fuel tank	Standard	Diesel fuel DIN 51601	all year	90
Cooling system	with heater	Coolant ⁶⁾ (325)	all year	17.0
	without heater			15.0
	of which antifreeze protection to -25 °C	Antifreeze ⁷⁾		6.75
	and anti-corrosion protection	Treating agent (311)		0.2
Windshield washer	Windshield water bottle	MB windshield washer cleaner	all year	2.4

⁶⁾ comprising water, antifreeze and treating agent

⁷⁾ antifreeze prot. to °C	antifreeze approx. %
10	20
20	34
25	40
30	44
40	51

Chassis Type 411

Technical Data

Model

Type 411
shorter longer
Wheelbase

Chassis dimensions:

Wheelbase	1720 mm	2120 mm
Track, front	1290 mm	1290 mm
Track, rear	1295 mm	1295 mm
Track with reversed wheels, front	1538 mm	1538 mm
Track with reversed wheels, rear	1543 mm	1543 mm
Min. track circle diameter (outer track)	7,6 m	9,1 m
Max. length	3460 mm	3860 mm (3860)**
Max. width	1630 mm	1630 mm (1790)**
Max. height	2035 mm	2035 mm (2140)**
Clearance below differential	380 mm	380 mm
Clearance below axle	460 mm	460 mm
Platform length (i. l.)	1475 mm	1475 mm (1875)****
Platform width (i. w.)	1500 mm	1500 mm
Platform height (i. h.)	360 mm	360 mm
Effective loading area (1475 x 1500 mm)	2,2 m ²	2,2 m ² (2,8)****
Loading height above ground, unloaded	1065 mm	1065 mm
Height of trailer coupling, unloaded	780 mm	780 mm
Seats in cab	1/1	1/1
Tilting angle	38°	38°
Angle of approach, front/rear	38°/47°	38°/62°

Weights:

GVW	3200 kg	3500 kg***
Deadweight	1795 kg	1895 kg (1940)**
Payload	1000 kg	1200 kg****
Perm. front axle load	1900 kg	1900 kg
Perm. rear axle load	2000 kg	2000 kg
Recommended total trailer weight	16 t	16 t

* = In agricultural field operations weight of tractor is reduced by approx. 135 kg when windshield, roof are removed.

** = Applicable to UNMOG Type 411 with steel cab.

*** = Applicable to German version with normal loading platform. GVW of export model with larger loading platform is 3550 kg, payload 1600 kg.

**** = Applicable to export version with larger loading platform.

I. Lifting capacity of hydraulic power lift arms**a) Rear power lift**

The capacity of the power lift system ranges from 470–525 mkp depending on connection.

Lifting power at implement connections of 3-point linkage at 550 mm coupling height and average lifting spindle length of 100 mm clear thread:

Centre of gravity behind swivel bearings (m)	Lifting capacity (kp)		Lifting height at centre of gravity (mm)*	
	BA – front	BA – rear	BA – front	BA – rear
0	1190	1350	410	390
0,4	900	1010	555	520
0,8	750	850	710	610
1,0	690	790	775	640
1,2	630	730	825	675
1,4	580	680	850	690

Note: BA = bottom arm

* The max. stroke at centre of gravity taking into account coil springs and flattening of tire; does not take into account losses which occur in floating position.

b) Front power lift

Max. lifting power with largest perm. piston diameter of hydraulic cylinder 72 mm

Pressure 6000 kp
Traction 5000 kp

II. Lifting capacity of pneumatic power lift arms**a) Rear power lift arms**

Max. lifting capacity at implement connecting points

with distance between centre of gravities of implement fitted as follows:

Distance between centre of gravity (cm)	Lifting capacity (kp)	
	Type 401*	Type 411**
0	645	830
25	550	730
50	460	630
80	350	520
120	200	360
150	90	240

b) Front power lift arms (6.5 bar operating pressure)

Max. lifting power of 35 cm long arm (lifting cylinder connection up to pivoting axis) with distance between centre of gravities of implement fitted as follows:

Distance between centre of gravities (cm)	Lifting capacity (kp)
40	640
60	570
80	510
100	440
120	370
150	270

* = Applicable to old power lift system with 7.5 bar operating pressure (hydraulic cylinder with 1700 mm diameter).

** = Applicable to new power lift system with 6.5 bar operating pressure (hydraulic cylinder with 190 mm diameter).

Adjusting and Installation Instructions Type 411 (Dimensions in mm)

Position of front wheels

Toe-in (unloaded vehicle)	$0 \pm \frac{3}{1}$
Camber	1° 45'
Caster	approx. 4°
Inclination	10°

Front and rear axle

Spiral bevel gear	Klingelberg gearing
Axle drive reduction	
a) Type 411, 411a, 411b	25 : 7 = 3.57 : 1
b) Type 411b / 411c	35 : 9 = 3.89 : 1
	from front axle no 6457
	from rear axle no. 6194
Reduction on wheel hub drive	32 : 15 = 2.13 : 1
Dual reduction	for a) i total = 1 : 7.62
	for b) i total = 1 : 8.29
Backlash of crown and pinion	0.15-0.20
Axial play of crown gear incl. differential housing in bearing seats	+ 0.002 to 0.05
Backlash of differential bevel gears	0.15 - 0.20
clearance (axial) of double joint	
shift in wheel hub drive	0 + 0.02, no preload

Shock absorbers

Manufacturer	Stabilus
Type	Telescope T 40 x 130
Dimension	40 mm piston Ø, maintenance-free

Swings

	Basic design	reinforced design
Front springs		
Untensioned length	2 coil springs	
Spring deflection per 100 kg load	320 ± 3 mm	15.95 mm 9.10 mm
Rear springs		
Untensioned length of main spring	2 coil springs with 2 helper springs	
Spring deflection per 100 kg load	380 ± 3 mm	17.70 mm 12.45 mm
Untensioned length of helper spring	250 ± 3 mm	
Spring deflection per 100 kg load	11.60 mm	

Brakes

Footbrake	Hydraulic brake system acting on all four wheels
Effective braking area per wheel	494 cm ²
Play between thrust rod and piston of master brake cylinder	1
Free travel of brake pedal measured at running plate	10

Handbrake

Acting mechanically on rear wheels

Steering*

Spindle steering
 Play at steering wheel
 Steering wheel
 Reduction

Spindle
 * ZF power steering optional

Type 411
 "Fulmina" Type 30
 20-30
 Petri 450 Ø
 1 : 24.3 = 5.06 steering wheel turns =
 75° turn of steering arm
 Double thread lefthand 16 mm,
 inclination ... Stg. < 9° 35'

Clutch**I. Single Clutch**

Manufacturer
 Single plate dry clutch
 Thrust pressure
 Clutch pedal clearance measured at running plate
 Contact area of clutch plate
 Thickness of clutch plate incl.
 clutch lining

Fichtel & Sachs
 Type K 225
 90 kp
 20-25
 221 cm²
 loaded 9.3 ± 0.3 mm
 unloaded 9.8 ± 0.3 mm

II. Double Clutch

Manufacturer
 Double clutch
 Thrust pressure
 1. First stage (drive clutch)
 2. Second stage (pto clutch)
 Clutch play

Fichtel & Sachs
 Type Do 225/200 K

 approx. 120 kp
 approx. 250 kp
 1,5 mm

Transmission

Axial play of drive for 4-wheel drive
 Axial play of countershaft between
 cover and spacer ring
 Radial play between bushing and first/third gear
 (counter shaft - sliding bearing)
 All wheel sets must have a perceptible
 play after installation

0.20 - 0.30

 0.20 + 0.1

 0.13 - 0.19

 approx. 0.1 - 0.2 mm

Remaining axial plays of individual
 shafts for the recesses of roller
 bearings and stages of the shaft are

given

Pneumatic trailer brake system

Manufacturer	Westinghouse, Hannover
Single piston air compressor	Type 411 004 120 0
Capacity	96 cm ³
Max. rpm of air compressor	2450 rpm
Operating pressure	7.5 kp/cm ²
Delivery at 7.3 kp/cm ² counterpressure and max. rpm of 2750	approx. 120 l/min
Pressure regulator with tire inflating bottle	Type 475 304 001 0
Pressure regulator set (operating pressure)	5.2 kp/cm ²
Pressure regulator with tire inflating bottle, adjustable: for trailer brake	Type 475 305 000 0
for power lift arms	5.2 kp/cm ² 8.5 kp/cm ²

Double line brake system

Hydraulically operated brake valve	Type 470 008 001 0
Pressure regulator	Type 475 304 001 0
Brake pressure	7.2 kp/cm ²

Single piston air compressor with gear oil pump

Type/Designation**	Westinghouse / 415 701 100 0
Air compressor	Type 411 005 100 0
Air compressor rpm	2450 rpm
Capacity	96 cm ³
Operating pressure	7.35 kp/cm ²
Delivery at 7.3 kp/cm ² counterpressure and max. rpm of 2750 rpm	approx. 120 l/min

Hydraulic system

** Gear oil pump with air compressor	Westinghouse 415 701 100 0
Gear oil pump	Type 416 101 000 0
Oil pump rpm	2450 rpm
Operating pressure	150 kp/cm ²
Delivery at max. engine rpm of 2750 without counterpressure	18.5 l/min
Delivery at operating pressure	16 ltr./min
Hydraulic double valve with pressure relief valve	Type 466 799 000 0

Tightening Torques in kpm

Engine

Type	OM 615	OM 621	OM 636
Crankshaft bearing bolts	9 ¹⁾	9	8
Piston rod bolts	5,5 ¹⁾	4,1 - 0,6	3,75
Flywheel mounting	Angle torque ²⁾	5,5 + 0,5	
Cylinder head bolts	9	9	8
Thrust bolt of prechamber	15 + 3	15 + 3	15
Nozzle in nozzle holder	7 + 1	7 + 1	
Nozzle holder in cylinder head	7 + 1	7 + 1	
Glow plugs	5	5	
Pressure valve carrier at injection pump	4,5 + 0,5	4,5 + 0,5	
Cap nuts of injection lines	2,5	2,5	
Rocker arm bearing bracket bolts	3,75 ³⁾	3,75 ³⁾	-
Nuts for ring piece on nozzle holder	7 - 1	7 - 1	5
Polit-stop nut on int. gear shaft for mounting timing device	7	7	-
Collar bolt on crankshaft, front	21 + 1	21	18
Mounting bolts for oil filter lower part	4 - 0,5	4 - 0,5	-
Oil pressure valve in cylinder crank case	4	4 + 1	-
Cylinder head cover	1,0	2,5	-
Oil filter pot	4 - 0,5	4 - 0,5	-
Front engine mounting	8	8	-

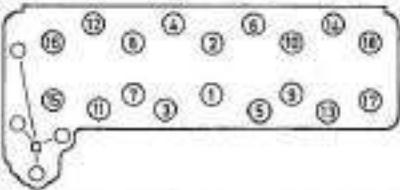
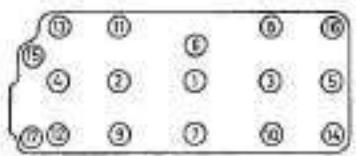
Type	Sketch for tightening sequence of cylinder head bolts	Torqueing in stages Tightening torque in mkp			
		First step	Second step	Third step	Check
OM 621		3	6	9	9
OM 615		4	6	9	9
OM 636		4	6	8	8

a = Tighten bolts with thread M8 with hand wrench.
Cylinder head bolts are slackened in the reverse order, starting from the back.

- 1) Connection rod and main bearing bolts are tightened without locking plates to the recommended torque. Before tightening, grease threads of bolts and nuts.
2) Tighten expansion bolts for flywheel mounting: first step 3 + 1 mkp, angle of torque 60° ± 10°.
3) When tightening rocker arm mounting bolts, rocker arms should not be subjected to load by camshaft.

Transmission 421

Bolt, small bearing main shaft rear	4.7-5
-------------------------------------	-------

Front and rear axle 421, 411b, 411c

Stabilizer	18-20
Axle drive adjustment	12 kpcm
Bolts on wheel hub drive housing and thrust tube	9-10
Bolts on axle drive housing	13,5
Clamping bolt in wheel hub drive	22
Wheel hub bolts	29
Shock absorber fastening bolts	12-14
Axle struts (bolts M16-10 K)	22 ± 2
Steering arm at steering knuckle	22

Front and rear axle 411, 411a

Fastening nut for strut on mounting bracket	7.5-8
Fastening bolts of crown gear of differential housing	7-8
Slotted nut at bevel gear shaft	14-16
Hexagon bolts for steering knuckles and connection housing at axle bridge, resp.	24
Mounting bolts of stabilizer	17
Wheel locking bolt	75-100

Steering 421, 411

Steering arm	25-30
Steering mounting on frame, bolt M24 x 1.5	40

SurveyVersion

Engine 616

15.9

Model 421, 411

15

Contents

Chapter	Page
1 General	
Technical data alternator	1.1/1
Sectional view	1.1/1
Technical data starter motor	1.1/2
Sectional view	1.1/2
Technical data glow plugs	1.1/3
Special tools	1.2/1
Tightening torque	1.2/1
Exploded view	1.3/1

Technical data**Alternator**

Electrical system		12 Volt (Series)	12 Volt (SA 35 496)	24 Volt (SA 35 613) ¹⁾
Manufacturer		Bosch		
Design		Three-phase		
Output	W	490	770	756
Rated voltage	V		14	28
Current	A	35	55	27
Number of revolutions, max.	1/min		9000	11000
Start of charging	1/min		1000	1180
Gear ratio engine/alternator		1 : 1.80		
Inscription		K 1-14 V 35 A 20	K 1-14 V 55 A 20	K 1-28 V 27 A 23

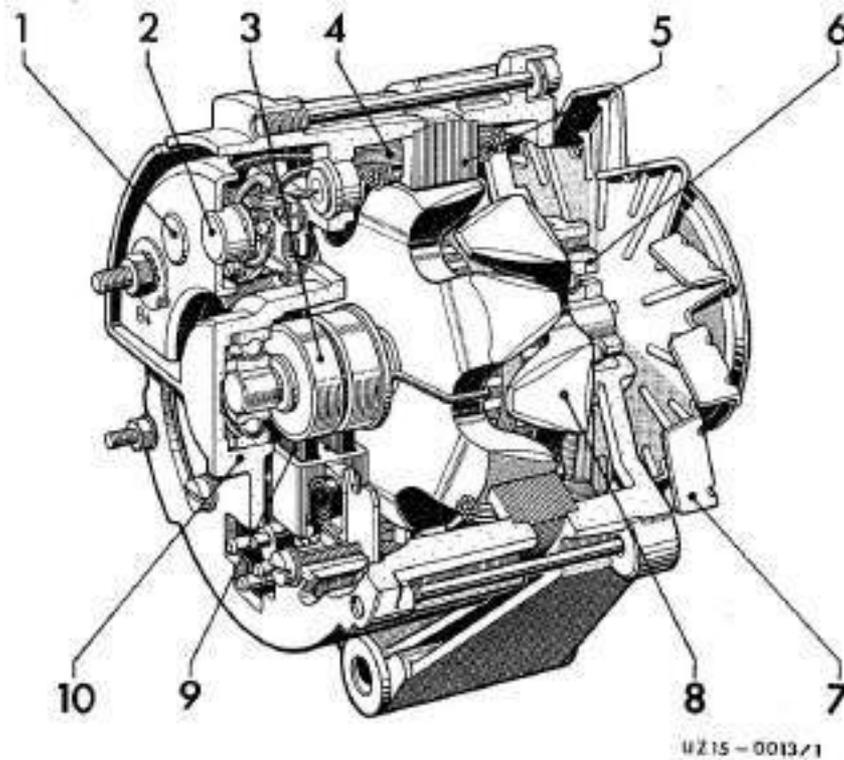
¹⁾ Engine-model 616.933**Sectional view****Alternator**

- 1 Heat sink
- 2 Diode
- 3 Slip ring
- 4 Stator winding
- 5 Stator core

- 6 Drive bearing
- 7 Fan
- 8 Claw pole rotor
- 9 Carbon brush
- 10 Slip ring bearing

15.9 General Information

616

Starter

Installation		Standard	SA 35 613
Manufacturer		Bosch	
Construction		Pre-engaged-drive starting motor	
Type		JF → 12 V 2.3 kW	JF → 24 V 2.6 kW
Marking		→ 12 V 0001 362 600	→ 24 V 0001 363 106
Direction of rotation		to the right	
Rated voltage	V	12	24
Output	kW	2.3	2.6
Pinion gearing	No. of teeth	z	9
	Module	m	2.11
	Pressure angle	α°	12
	Profile displacement factor	x	+ 0.753

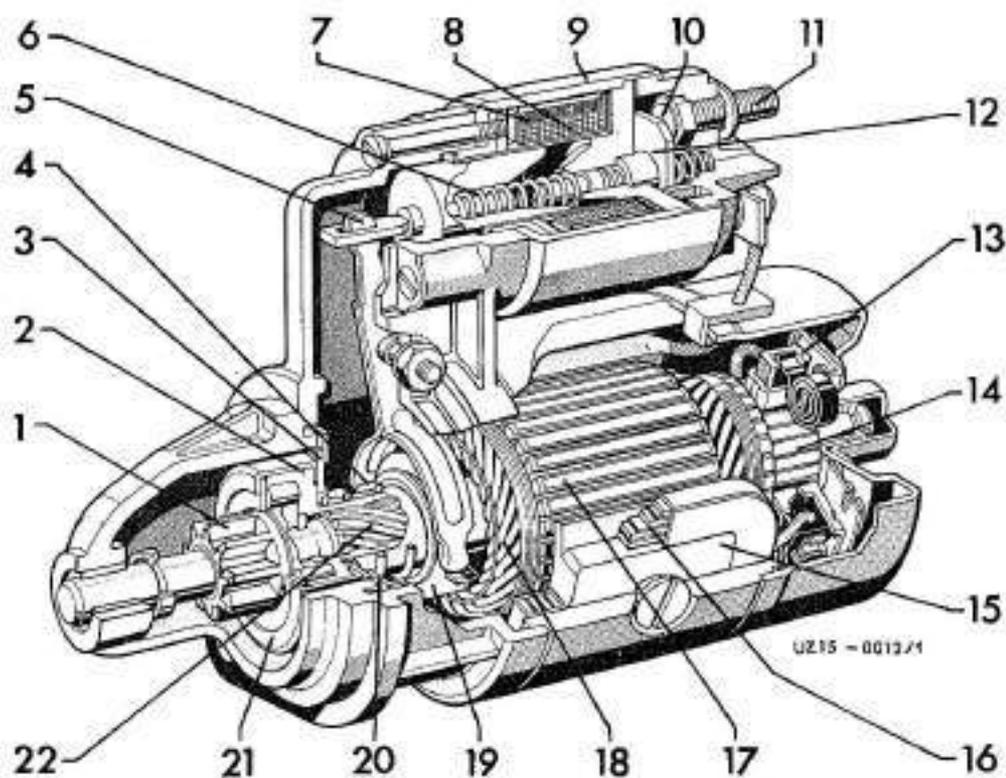

Starter

- | | | |
|-------------------|----------------------------|--------------------------------------|
| 1 Pinion | 9 Solenoid relay | 16 Exciter winding |
| 2 Driver | 10 Relay contact | 17 Starter armature |
| 3 Brake disk | 11 Terminal stud | 18 Armature winding |
| 4 Meshing spring | 12 Bridging contact member | 19 Guide ring |
| 5 Engaging lever | 13 Carbon brush | 20 Stop |
| 6 Return spring | 14 Commutator | 21 Roller-type overrunning clutch |
| 7 Holding winding | 15 Pole shoe | 22 Armature shaft with spiral spline |
| 8 Pull-in winding | | |

Glow plugs

Installation		Series		SA 35 613	
Manufacturer		Bosch	Beru	Bosch	Beru
Type		KE 4484 B/A	182 MJ	A 250 201020	165 MJ
Type of connection		1 pole			
Operating voltage	V	9.5		18	
Operating current	A	9.1	10	5.2	
Number		4			
Length	mm	79.5	78	78.5	77
Male connector		M 18 x 1.5			

Standard installation

Engine-model	to engine-end-no.
616.911	003 345
616.932	000 380
616.933	000 204

Installation		Series		SA 35 613	
Manufacturer		Beru		Beru	
Type		0 100 221 107		0 100 231 101	
Type of connection		1 pole			
Operating voltage	V	11.5		18	
Operating current	A	14		5	
Number		4			
Length	mm	68 ± 1			
Male connector		M 12 x 1.25			

Standard installation

Engine-model	from engine-end-no.
616.911	003 346
616.932	000 381
616.933	000 205

Special tool

Ser. no.	Designation	Special tool	Tool-seet
1	Box wrench	000 589 30 03 00	A
2	Socket wrench for glow plugs	001 589 23 09 00	A
3	Reamer for glow plug duct	617 589 00 53 00	D

Tightening torques

Designation	Thread/ strength	Nm
Alternator at carrier	M 8/8.8	38
Clamping bolt at crankcase	M 10/10.9	50
Belt pulley at alternator	M 14	35 to 45
Glow plug in cylinder head	M 18	50
	M 12	35
Starter motor at clutch housing	M 12/8.8	65 to 65

Exploded view

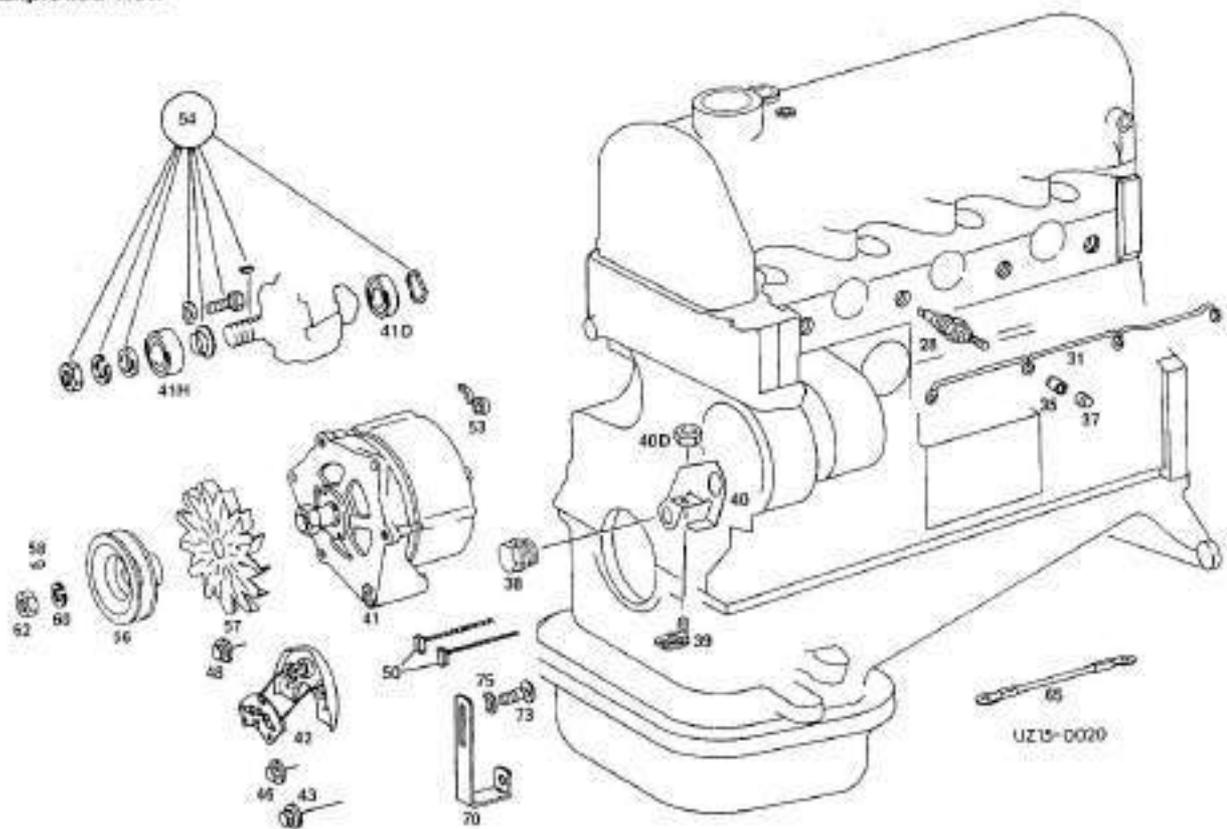

Electrical equipment on engine

28	Glow plug	48	Exciter-diode
31	Busbar	50	Set of brushes
35	Nut	53	Spring
37	Cap	54	Repair kit rotor
38	Plug	56	Belt pulley
39	Bracket	57	Fan
40	Bracket	58	Woodruff key
40D	Nut	60	Spring washer
41	Alternator	62	Nut
41D	Ball bearing	65	Earth cable
41H	Ball bearing	70	Angle
42	Rectifier	73	Bolt
43	Plus-diode	75	Springer washer
45	Minus-diode		

Exploded view

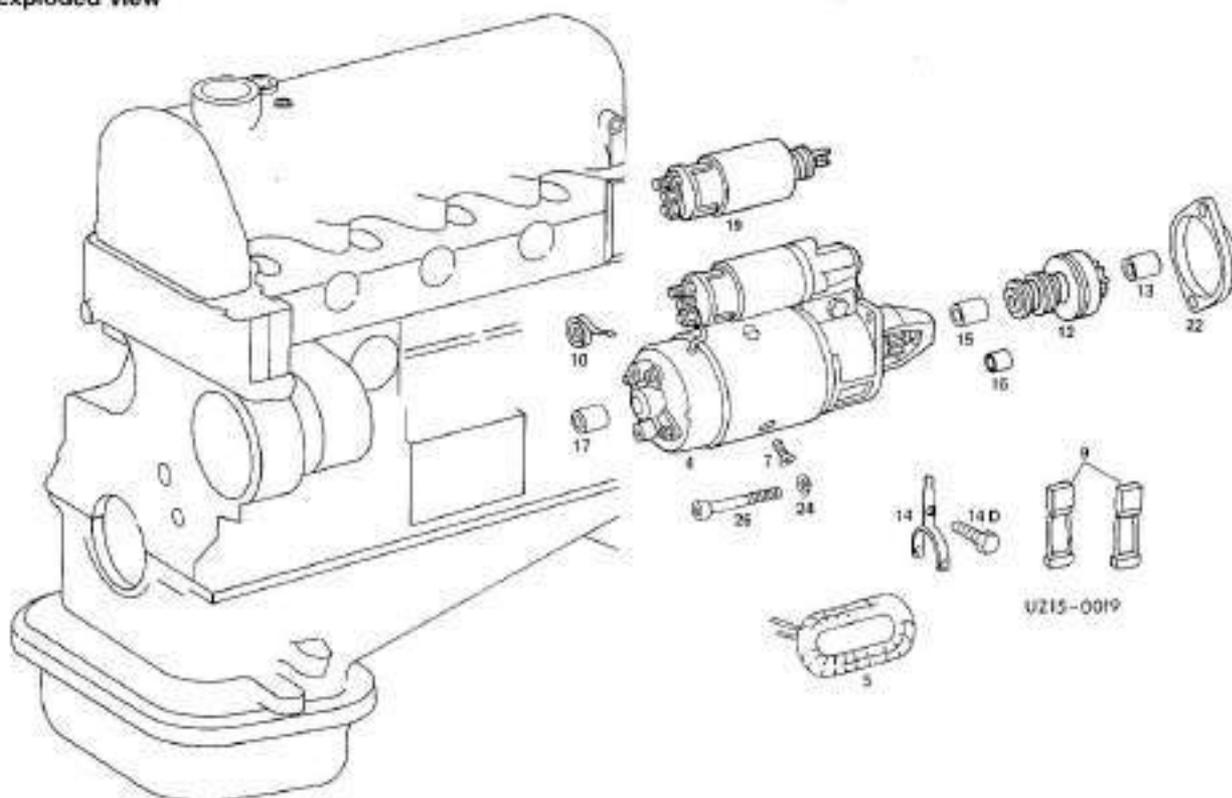

Starter motor

- | | | | |
|----|-----------------|-----|--------------------------|
| 4 | Starter motor | 14D | Bolt |
| 5 | Exciter winding | 15 | Bushing |
| 7 | Bolt | 16 | Bushing |
| 9 | Set of brushes | 17 | Bushing |
| 10 | Spring | 19 | Solenoid-operated switch |
| 12 | Pinion | 22 | Intermediate piece |
| 13 | Bushing | 24 | Spring washer |
| 14 | Shift lever | 26 | Bolt |

II. Type 411

Starter

Bosch order no.	Type	Rotating direction	Max. Torque	Short circuit current input
0 001 354 031	ID (R) 12 V 1.8 PS	clock wise	4.1 kpm	845 Amp.

Generator

Bosch order no.	Type	Current	Max. Amp.	RPM/Min.
0 101 206 012	EG (R) 14 V 20 A 27	14 V	20 Amp.	4720

Regulator

Bosch order no.	Type	Current	Max. charging rate
0 190 309 028	VA 14 V 20 A	14 V	20 Amp.

Glow plugs

Bosch order no.	Type	Execution of glow wire	Rated voltage
0 250 002 002 0 250 001 001	Bosch KE/GA 2/2 Bosch KE/GA 1/8	coil spring like loop like	1.4 V 0.9 V
- -	Beru 202 GE Beru 214 GK	coil spring like loop like	1.4 V 0.9 V

Remark: The shaft of the Beru glow plug, of which the glow wire is coming out, is not a live one, therefore not ground sensitive.

Table of electrical circuit on engine OM 636

(all fuses 8 Amp. as per DIN 72581)

Fuse no.	Consumer
1	Back-up light
2	Tail light, left
3	Tail light, right, instrument panel light
4	Blinker
5	Horn and windshield wiper
6	Stop light
7	Main beam, left
8	Main beam, right
9	Dimming light, left
10	Dimming light, right
11	Parking-and position light, right
12	Parking-and position lighth, left

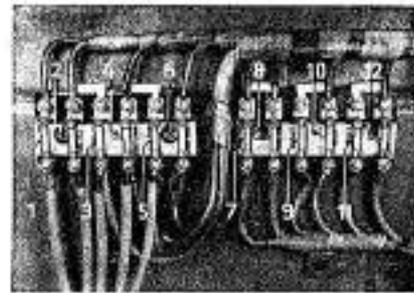

Picture 15/54-0/4

Arrangement of fuses

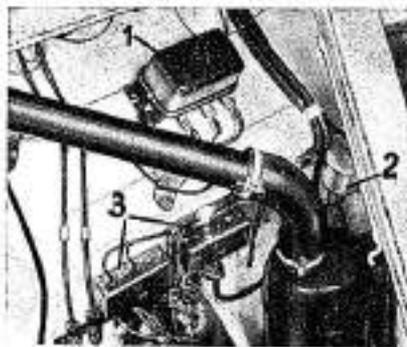

Picture 15/54-0/5

1 = Generator regulator
2 = Blinker sending unit
3 = Fuse boxes

Explanation for wiring diagram

Picture 15/54-0/6

- 1 = Head light, left
- 2 = Head light, right
- 3 = Blink-and position light, left
- 4 = Blink-and position light, right
- 5 = Engine
- 6 = Generator
- 7 = Starter
- 8 = Fuse boxes
- 9 = Windshield wiper
- 10 = Plug (female)
- 11 = Blinker sending unit
- 12 = Glow plug resistance
- 13 = Glow plug control
- 14 = High beam indication light
- 15 = Charging control light
- 16 = Panel instrument light
- 17 = Blinker control light, for 1st trailer
- 18 = Blinker control light, for 2nd trailer
- 19a = Oil pressure switch
- 19b = Oil pressure control light
- 20 = Glow plug starter switch
- 21 = Main switch box
- 22 = Switch for blinker
- 23 = Horn
- 24 = Terminal rail
- 25 = Stop light switch
- 26 = Button for horn
- 27 = Terminal rail
- 28 = Battery, 12 V
- 29 = Trouble lamp
- 30 = Trailer female plug with the connection of
- 31 = Stop-brake light, right
- 32 = Stop-brake light, left
- 33 = Ground
- 34 = Tail light, left
- 35 = Tail light, right
- 36 = Stop light
- 37 = 3rd brake
- 38 = 34 bottom
- 39 = 34 top
- 40 = 31
- 41 = 38 middle
- 42 = 38 outside
- 43 = 34
- 44 = 32
- 45 = 31
- 46 = Blink stop-and tail light, left
- 47 = Blink stop-and tail light, right
- 48 = Switch for control light (trouble light)
- 49 = Switch for 3rd brake

Picture 15/54-0/6

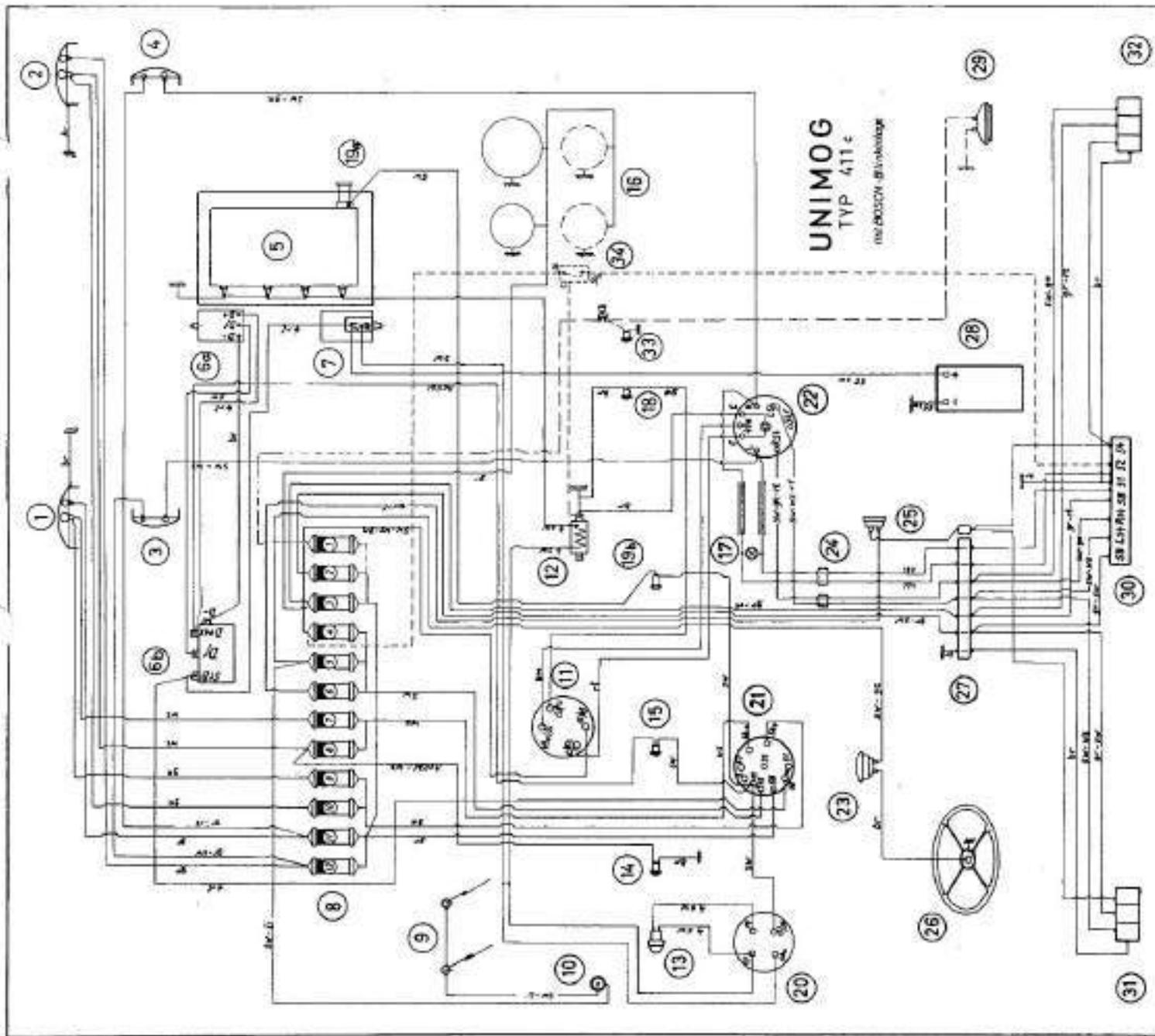

Remove, Install and Partially Repair the Starter on Type 421 15-1

The starter is operated electrical via the glowplug starter switch on the dash board. If the starter fails to start, the reason for failure may be in the electrical system or in the starter itself. Loose terminals and bad ground connections may be the reasons for malfunctioning; the usual permissible loss of tension should not exceed more than 4 % in the cable going to-and from the starter.

The reaction of the switched-on head lights tell the condition of the battery and contacts of the starter.

- a) Are the head lights going off, a bad connection is on the battery, on the cable connectors of the starter, or on any ground wire.
- b) Are the lights going off slowly, the battery is not charged, or damaged, or old.
- c) If the lights of the head lights do not change at all, the starter needs a checking.

A. Remove and install starter

1. Remove ground cable from battery.
2. Disconnect cable from starter.
3. Remove starter from crankcase housing in forward direction.
4. Installation is done in vice-versa sequences. Coat pinion and pinion shaft with grease.

B. Repair starter partially

Remark:

If the starter fails to work, it is advisable to have a service station check into it far to repair.

The repair instructions of the starter therefore deal only with an exchange of the carbon brushes and springs as well as changing of the starter pinion.

1. Remove collector protection ring.
2. Remove brushes. Picture 15-1/1.
3. Place starter into vise, decatter castled nut of pinion shaft, remove nut with washer.
4. Remove pinion from shaft by turning anti-clockwise.

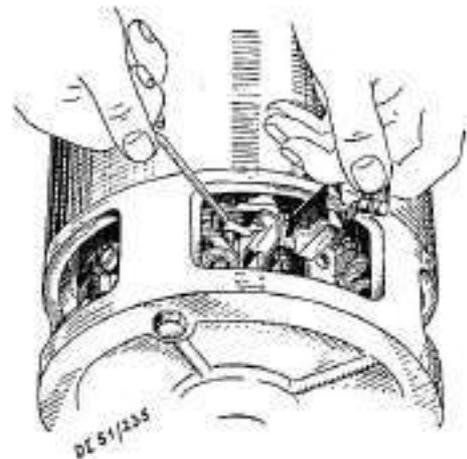

Picture 15-1/1

5. Remove screws on starter housing cover and take off cover.
6. Remove armature out of housing.
7. Clean brushes with fuel and a clean cloth. Never touch the sparking contact areas with a file or sand paper, clean brush mountings with air pressure.
8. Clean collector, if grooves can be seen, turn off a little and polish, also clean grooves between the collector bars (otherwise short circuit).
9. Check starter pinion, if necessary, renew.
10. Check brushes and brush pressure springs, if necessary, renew.

11. Reassembly is done vice-versa.
12. Check starter on test bench.
Picture 15-1/2.

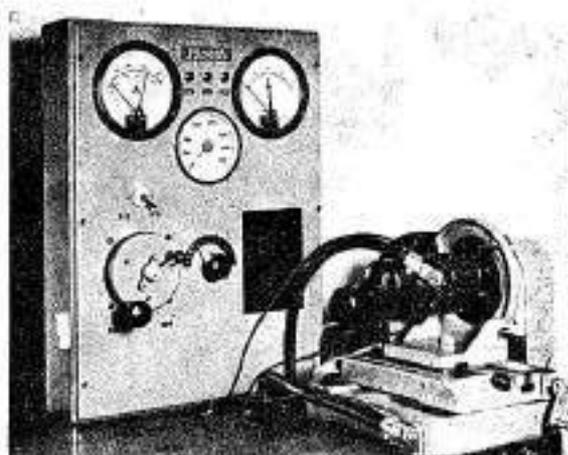

Picture 15-1/2

C. Remove and install magnetic switch

Remove:

1. Remove ground cable on ground pole of battery.
2. Disconnect cable 30 and 51 on the connection of the magnetic switch. Remove the cable from the field windings to the magnetic switch.
3. Remove the control cable on the connection 50.
4. Remove the cylindrical screws on the cover flange for the drive bearing, unhook the magnetic switch on the engagement lever and remove.

Installation:

5. Check the installation measurement 'a' on the magnetic switch and if necessary adjust. (See page 15/54-0/1.)

After the adjustment, the universal fork and the counter nut must be secured with varnish FL 53 V 8.
6. The rest of the installation is done vice-versa.

A. Remove and install starter

1. Remove ground cable on battery.
2. Remove starter cable (30).
3. Loosen electric wire on connection 50.
4. Loosen connecting bolts of starter on crank-case housing and remove starter, use tool no. 636 589 00 01 00.
5. Installation is done vice-versa.

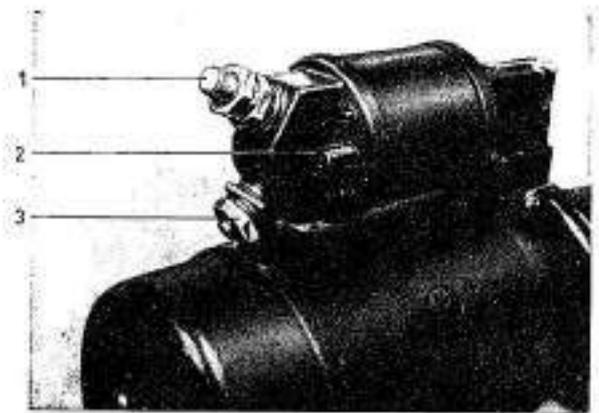

Picture 15-1.1/1

- 1 = Connection 30
- 2 = Connection 50
- 3 = Connection bolt for magnetic switch

B. Partially repair starter

Remark:

For the repair of the starter, the same rules as of the generator do apply, that means bring starter to the nearest Bosch Service Station.

The description of starter repair only goes for changing of brushes and brush springs as well as changing of the starter pinion.

1. Remove protection cover plate for collector.
2. Tightening screw (hex. nut for el. wire from magnetic switch to the starter motor) to be loosend.
3. Lift up brush pressure spring, and remove the brushes.
4. The 2 long screws to be taken out, remove bearing cover, incl. armature (before taking out, mark).
5. If the starter pinion is to be changed, remove the magnetic switch by loosening the two top counter sunk screws and the horizontal pin too.
6. Decotter castled nut in front of the starter pinion, remove same and the lock ring too.
7. Remove armature out of its front mounting bearing.
8. Pull down shifting fork. Starter pinion can now be removed.
9. Clean and check collector, if necessary use polish linnen to clean, also clean the grooves between the bars (otherwise short circuit).
10. Check starter pinion and if necessary, renew.
11. Check also and if necessary, renew the brush pressure springs and the brushes.
12. Reassembly is done vice-versa.
13. Check starter on test stand.

Remove and Install Generator on Type 421

15-2

(Three-phase generator)

I. In general

The generator is supplying the direct current, needed for the electrical system in the vehicle, converted by the silicon rectifier into direct current (diode in bridge position). Converting a.c. into d.c. By means of a two-contact-one-element regulator, the operating voltage is regulated. The generator itself regulates the max. voltage, the rectifiers are taken over the functioning of the return current switch. The generator is pre-excited by the battery and during the operation the exiting is done by an installed (3) exiting diode in the coil.

The three-phase generator needs no maintenance.

To avoid great damages, look out for the following:

1. As long as the engine is running, do not remove ignition key or the terminals on the battery, the connection on the generator itself, or the plug of the regulator. Otherwise the diodes will be damage by the inductive voltage peak.
2. For the same reason it is not permissible to pull a UNIMOG as long as the cables on the battery are not connected (when loading a vehicle).
3. The three-phase generator must and should **not be** polarized. The pre-exiting is sufficient as long as the control light is on.
4. By no means mix-up the terminals or the connections on the generator, regulator or starter.
5. **Attention when quick charging.**
When re-charging the battery with a quick charger (battery installed in the vehicle) remove the terminals. **If, in exceptional cases, the quick charger is used as a starter aid – as by where the terminals are not removed – the implement must be shut-off before disconnected.**

Otherwise a high voltage is induced by the sudden load decrease and the diods are destroyed.

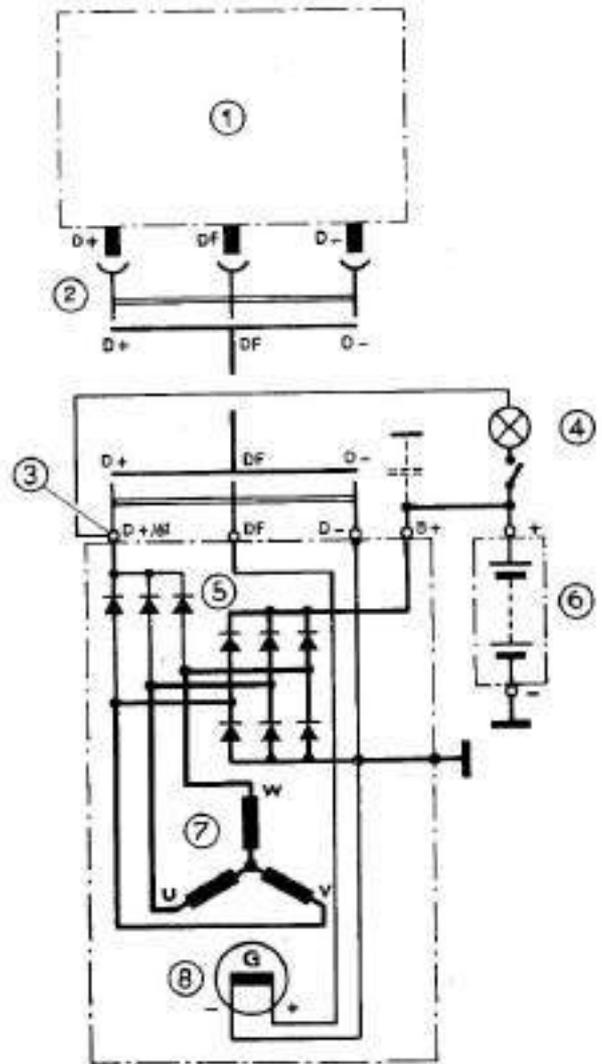

Picture 15-2/1

- 1 = Regulator
- 2 = Plug connections
- 3 = Screw connections
- 4 = Loading warning light
- 5 = Rectifier
- 6 = Battery
- 7 = Three-phase coil
- 8 = Exiting coil (runner)

Attention: Implements with separate main switch to be shut-off only, after the load voltage has been set back to 0 Amps.

A bad connection of the terminal can also lead to destruction of the diods when a starter aid is used. They are also in danger when a quick charger or a battery is connected the wrong way, with the one in the vehicle (acting as starter aid).

6. The regulator connections nor the generator should be shortened, nor should the hot wire be connected with the ground wire.

7. Generator trouble in general are mostly shown by the bright shining indication lamp for ignition. The exact malfunctioning of the generator can only be destined on a test bench. However, the generator with regulator can be tested while both of them are installed as follows:

- a) Connect voltage meter on D+ and D-. Without a switch-on consumer, the regulator voltage at engine rpm. of 1500/min., should be for various types of regulators, between 13.9 to 14.8 V.
- b) Shut-on consumer (head lights and wind

shieled wiper motors) of approx. 200 W. At this consumer, the regulator voltage should be within the recommended limits.

If the voltage is not within this limits, shut-off engine, pull regulator plug and repeat checking with new regulator. In case the regulator voltage is now correct install the new regulator. If the voltage is still out of the limit recommended, change generator.

Pay attention for a surrounding temperatur of the regulator, app. 20° C and a load capacity of the battery of 60 %.

B. Remove and install generator

- 1. Disconnect battery.
- 2. Disconnect wires from generator.
Remark:
Instead of a cable shoe, a three-fold-plug connection is mounted.
- 3. Remove set screw on bracket of generator, remove V-belt. Picture 15-2/2.
- 4. Remove screw on support of generator bracket, take off generator.
- 5. Installation is done vice-versa, connect cables.
- 6. Tension V-belt.

Remark:

Any repair of an alternator should be done in an authorized Bosch Service Station.

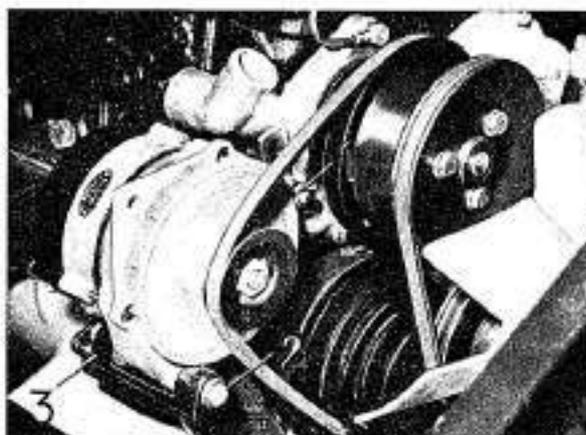

Picture 15-2/2

- 1 = Set screw for V-belt
- 2 = Screw of generator support
- 3 = Generator support bracket

Remove, Install and Partially Repair Generator on Type 411 15-2.1

The rated output of the generator is 130 W. The generator can be overloaded continuously up to 50 %. The reserve is to charge the battery even when consumers are shut-on (head lights at night). Continuous consumers are the ones in operation usually all night:

Head light, tail light, licens plate light etc.

A. Remove and install generator

1. Disconnect ground cable on battery.
2. Disconnect wires on generator.
3. Remove set screw on bracket of generator and take off V-belt.
4. Remove both screws on the carrier of generator mounting bracket, take off generator.
5. Installation is done vice-versa.

B. Partially repair generator

The generator should only be repaired in the own shop if no Bosch Service Station is around. Otherwise give generator out for repair.

1. Loosen and remove collector protection strap.
2. Lift brush springs and brushes too, clamp brushes with springs to hold, don't brake brushes.
3. Remove both long screws, also the bearing cover on the drive side, including the coil. (Before pulling out, mark.)
4. Loosen mounting screw of the plus brush holder (cable shoe).
5. Remove bearing cover on collector side.
6. Remove nut on V-belt pully and pull off V-belt pully itself.
7. Check ball bearing. Remove the 3 screws

Remark:

It might be a good idea to have generator run as an engine for a little while, therefore connect no. 61 with 51.

Do this before V-belt is mounted.

If the generator runs in the same direction as the engine does, this is the right direction and generator has the correct polarity too. Provided the battery is connected in the right way,

in the bearing cover and pull-off the ball bearing. Use puller 000 589 20 33 00.

8. If collector shows grooves, turn down slightly.

The isolation between the collector bars and the bars itself must be set-back by 0.6 mm. If this is not the case, use a collector saw for cut-in. Clean collector.

9. Clean brushes with clean rag. If worn out, renew.

The brushes should glide in the brush holder easily and the springs should press them down sufficiently.

10. Reassembling of the generator is done vice-versa.

11. Check generator on a test bench or after installation into vehicle.

Remark:

To have a continuous control whether or not the generator is working while the engine is running, a control light is mounted on the dash board.

This check lamp should light when the ignition key is pushed in and the engine is not running. The moment the engine starts running, the light must go off. This means the generator is working **perfect**.

If the lamp goes on during the vehicle is in operation, that would mean the generator does not work. The trouble must be looked after at once to avoid a voltage drop in the battery.

In the most cases the voltage regulator did failed. Since the regulator can only be repaired in a Bosch Service Station, change the complete regulator.

1. Disconnect ground cable from battery.
2. Disconnect cable on voltage regulator.
3. Remove regulator.

Remark:

The voltage regulator is located in the front engine compartment.

4. Installation is done vice-versa.

Check glow plugs

To be able to have the complete glow system under control, some is equipped with a incandescent spiral. This spiral must get cheery red when the pre-heater switch is brought into position no. 1.

If the spiral is getting glowing much brighter, the ground wire must be better connected on the glow wire, of a glow plug, on the glow plug indicator resistor or on the pre-heating resistance.

If the spiral is not glowing at all, a glow plug is out for order, mostly the glow plug wire is broken.

To check which one, proceed as follows: shorten out all glow plugs one after one (use screw driver) and at same time bring starter switch in pos. 1, the one glow plug is out of order on which the glow plug indicator is starting to glow when the plug is shortened out.

If the glow plugs are OK, check the glow plug indicator on dash board or the glow plug indicator resistor under the hood.

As of installation of engine OM 615 (chassis no. 421 ... 002 229) the outer bus bars are functioning as resistors. Therefore, no resistor in drivers cab. See Picture 15-4/1.

Remove and install glow plugs

1. Remove ground cable terminal from battery.
2. Disconnect hot wire from plug no. 4 and ground cable from plug no. 1.
3. Remove nuts from plugs and also the current connecting rails with insulators. Unscrew glow plugs.

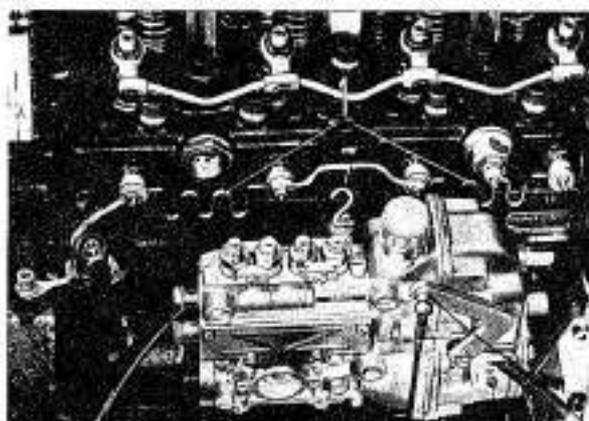

Picture 15-4/1

1 = Outer bus bar acting as resistor
2 = Inner bus bar

Remark:

Before installing glow plugs again, check the glow plug channel with tool no. 636 589 03 53 00 and if necessary clean with a reamer.

The reamer should have a dia. of 11 mm, coat same with grease and start the tool screwing into the glow plug channel to remove the carbon. After finishing, start up the engine to have carbon blown out.
Picture 15-4/2.

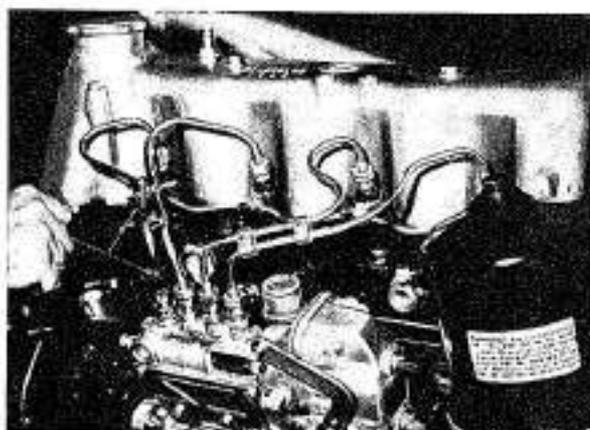

Picture 15-4/2

1 = Check plug 636 589 03 53 00

4. Install glow plug into cylinder head.

Torque is 5 mkp.

Contents

Chapter	Page
1 General	
Technical data coolant pump, engine 616	11/1
Sectional view coolant pump, engine 616	1.1/1
Technical data coolant regulator, engine 616	1.1/2
Capacity, engine 616	1.1/2
Sectional view coolant pump, engine 621, 636	1.1/3
Belt pulley-gear ratios, engine 621, 636	1.1/3
Engine cooling	1.1/3
Special tools	1.2/1
Tightening torques	1.2/1
Exploded view	1.3/1
2 Checking cooling system	2.1/1
3 Repairing coolant regulator	
Removing and installing coolant regulator, engine 616	3.1/1
Removing and installing coolant regulator, engine 615, 621	3.2/1
Removing and installing coolant regulator, engine 636	3.3/1
4 Repairing coolant pump	
Removing and installing coolant pump, engine 615, 621, 636	4.1/1
Disassembling and assembling coolant pump, engine 621, 636	4.2/1
5 Disassembling and assembling fan bearing	
Engine 615, 621, 636	5.1/1
6 Cleaning cooling system	6.1/1

Technical data

Engine cooling

Parallel-distance of fan from radiator block		mm	15
Distance, flange – hub	a	mm	89.2 ± 0.2
Distance, impeller – flange	b	mm	23 ± 0.2
V-belt tension	Coolant pump, alternator and crankshaft	mm	approx. 5 to 10*
	Air compressor and crankshaft	mm	approx. 10 to 15*
	Coolant pump and fan-bearing bracket	mm	approx. 10 to 15*

Gear ratio from crankshaft to	Coolant pump	Alternator	Fan normal tropics	
	1 : 0.9	1 : 1.95	1 : 1	1 : 1.1

* Depressing with moderate thumb pressure.

Coolant pump

- | | |
|----------------------------|------------------------------|
| 1 Hub | 6 Impeller |
| 2 Deep-groove ball bearing | 7 Coolant shaft pump |
| 3 Bearing housing | a Reference size |
| 4 Side ring seal | b Distance impeller – flange |
| 5 Counter ring with O-Ring | |

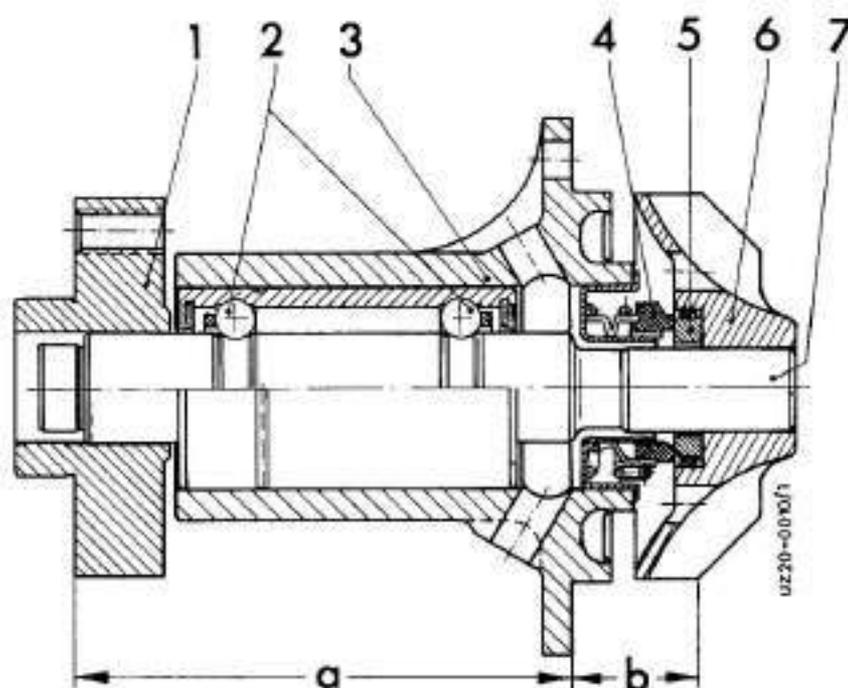

20.9 General

616

Technical data coolant regulator

Start of opening	°C	71 ± 2
Valve lift	mm at °C	8 at 85
Pressure max. in closed valve	bar	0.8

Capacities

Assembly	Service product (sheet-no. of the MB-service product-specifications)	Season	Capacity		
			with heating	without heating	
Cooling system	Coolant	all-year	17.0	15.0	
Antifreeze protection to	-10 °C +14 °F		Water Antifreeze (325)	13.5 3.5	12.0 3.0
	-20 °C -4 °F		Water Antifreeze (325)	11.5 5.5	9.75 5.75
	-30 °C -22 °F		Water Antifreeze (325)	9.5 7.5	8.25 6.75
	-40 °C -40 °F		Water Antifreeze (325)	8.5 8.5	7.55 7.45
Corrosion protection	Treating agent (311)		20 cm ³ /l Coolant		

Coolant pump

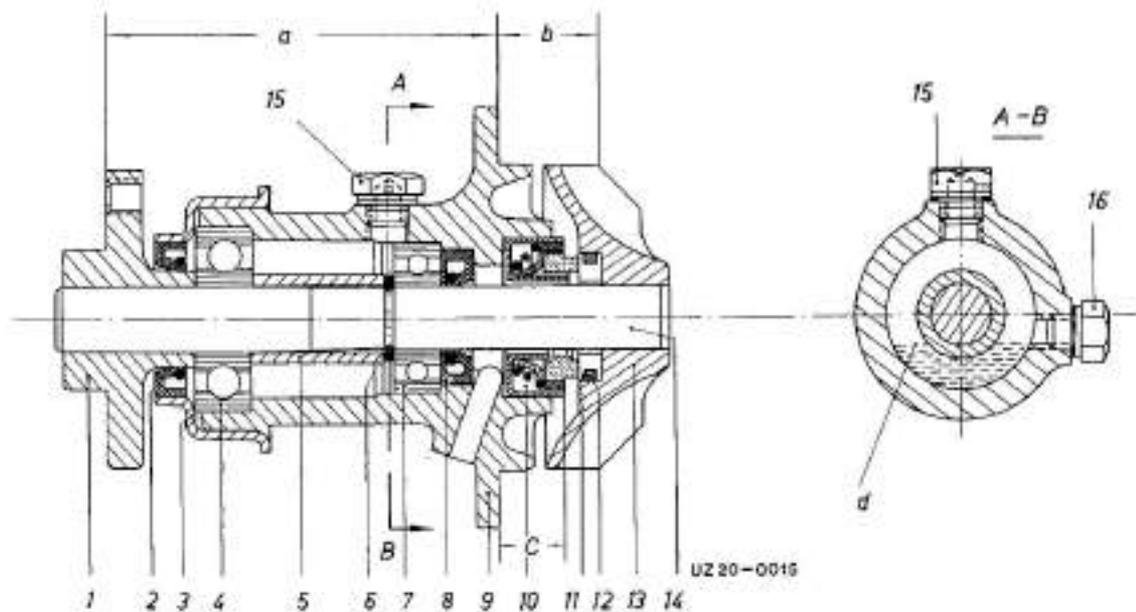

Distance a = 89 ± 0.2;

Reference size b = 23 ± 0.2;

Installation dim. c = 14.7;

d = Oil level

- | | | |
|------------------------------|------------------------------|--------------------------------------|
| 1 = Hub | 6 = Retaining ring | 12 = O-ring |
| 2 = Radial seal | 7 = Deep-groove ball bearing | 13 = Impeller |
| 3 = Sealing ring retainer | 8 = Sealing ring | 14 = Coolant shaft pump |
| 4 = Deep-groove ball bearing | 9 = Bearing house | 15 = Oil filler screw with vent bore |
| 5 = Spacer sleeve | 10 = Slide ring seal | 16 = Oil level-inspection screw |
| | 11 = Counter ring | |

Belt pulley-gear ratios

Gear ratio from crankshaft to	Coolant pump	Alternator	Fan
OM 621 – Typ 421	1 : 0.9	1 : 1.95	1 : 1
OM 636 – Typ 411	1 : 1.18	1 : 1.72	1 : 1

Engine cooling

Designation	Typ 421 / OM 621	Typ 411 / OM 636	Note
Parallel-distance of fan from radiator block	15 mm	10 mm	–
Distance of impeller from flange of coolant pump	23 ± 0.2	23 ± 0.2	–
V-belt tension at coolant pump, alternator and crankshaft	ca. 5–10 mm	ca. 6 mm	Depressing with moderate thumb pressure
V-belt tension at air compressor and crankshaft	ca. 10–15 mm	ca. 10–15 mm	Depressing with moderate thumb pressure
V-belt tension at coolant pump and fan-bearing pedestal	ca. 10–15 mm	–	Depressing with moderate thumb pressure

Special tools

Ser. no.	Designation	Special tools	Tool-set
1	Radiator test pump	001 589 482 100	B

Tightening torques

Designation	Thread/ strength	Nm
Coolant pump at crankcase	M 8/10.9	30
Coolant pump housing at bearing housing	M 6	10
Fan at hub	M 8/8.8	25

Exploded View

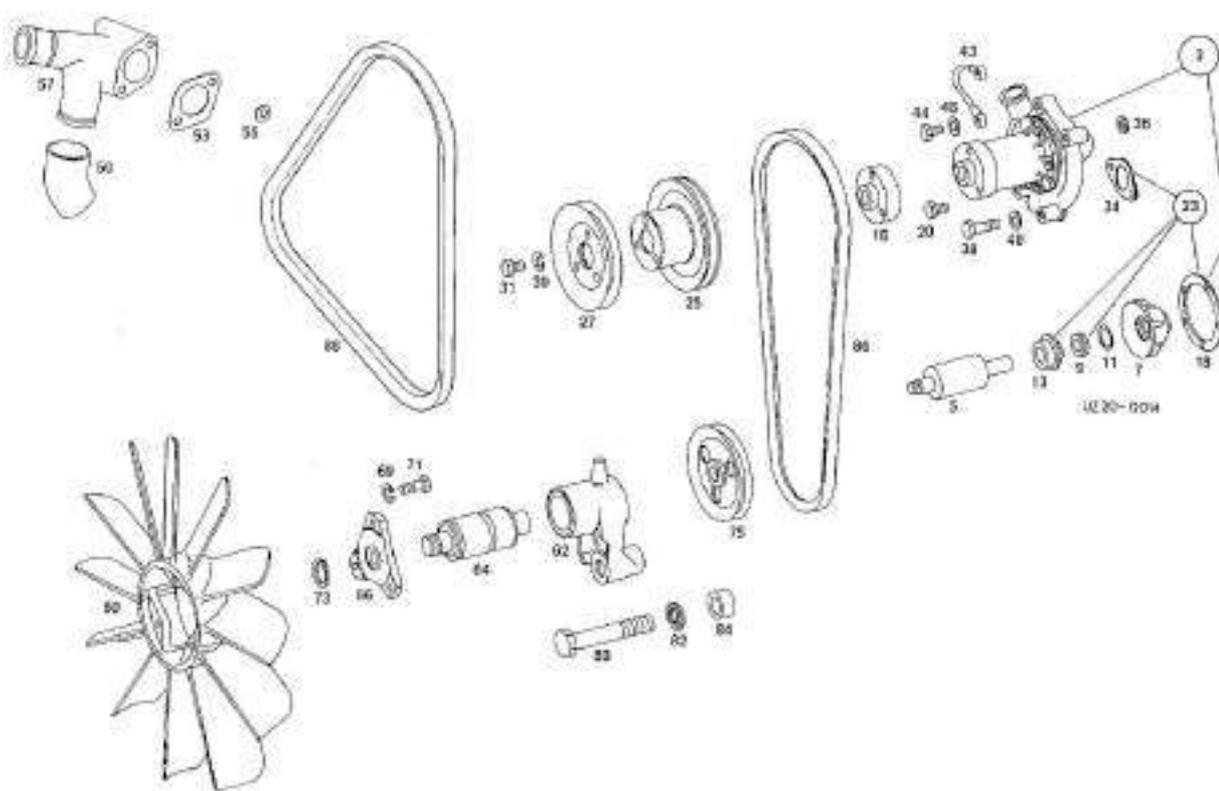

Engine Cooling

- | | | | |
|----|----------------------|----|--------------------|
| 3 | Coolant pump | 44 | Hollow bolt |
| 5 | Grooved ball bearing | 46 | Sealing ring |
| 7 | Impeller | 50 | Hose |
| 9 | Thrust ring | 53 | Gasket |
| 11 | Sealing ring | 55 | Washer |
| 13 | Sealing ring | 57 | Connection piece |
| 16 | Hub | 60 | Fan |
| 18 | Gasket | 62 | Holder |
| 20 | Bolt | 64 | Ball bearing |
| 23 | Prepare set | 66 | Disk |
| 25 | V-belt | 69 | Spring lock washer |
| 27 | V-belt | 71 | Bolt |
| 30 | Spring lock washer | 73 | Circlip |
| 31 | Bolt | 75 | Belt pulley |
| 34 | Gasket | 80 | Bolt |
| 36 | Washer | 82 | Washer |
| 38 | Bolt | 84 | Spacer |
| 40 | Washer | 86 | V-belt |
| 43 | Vent line | 88 | V-belt |

Checking

The cooling system operates at overpressure controlled by the valve in the inlet lock of the expansion tank. When the coolant is heated, the overpressure valve maintains the system under pressure up to 0.5 kp/cm² while the vacuum valve balances any harmful vacuum during cooling. The pressurized cooling system must therefore be checked for leaks when cold,

- 1 Unscrew closing cover from expansion tank.
- 2 For checking, top up coolant to maximum level so that too much air does not require to be compressed.
- 3 Fit special tool No. 1.
- 4 Pump up to approx. 0.5 km/cm² with test pump and check whether pressure remains stationary. If there is a pressure drop, repair defect points. Even if pressure remains stationary, check hose connections for needle hole leaks (sweating).

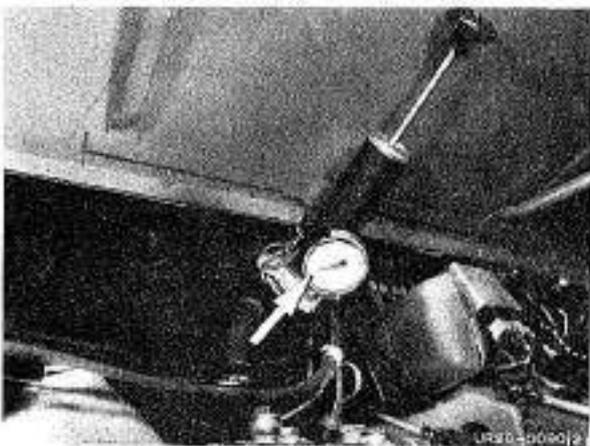
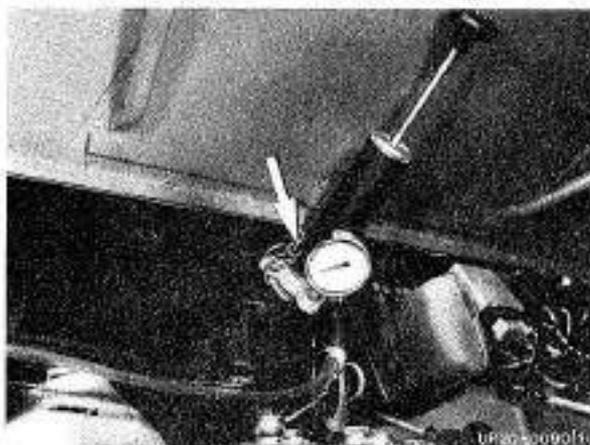

The following characteristics may occur:

- 5 If the pointer on the tester fluctuates, this is usually an indication that the cylinder head gasket is leaking.
- 6 Loss of coolant via the overflow pipe is indicated by a sudden rise and then a drop in the test pressure. This can be caused by furring in the water jacket, caused by local hot spots which result in steam bubbles being formed and water thus being ejected. To rectify, have engine or entire cooling system defurred.
- 7 Test closing cover with special tool No. 1. In particular, check sealing ring for notches or cracking.

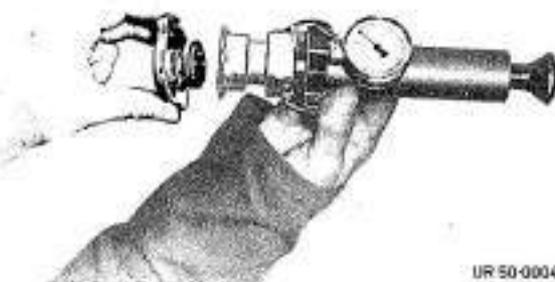

UR 50-0004

Removal

1 Drain coolant.



2 Disconnect bypass line from engine to coolant regulator.

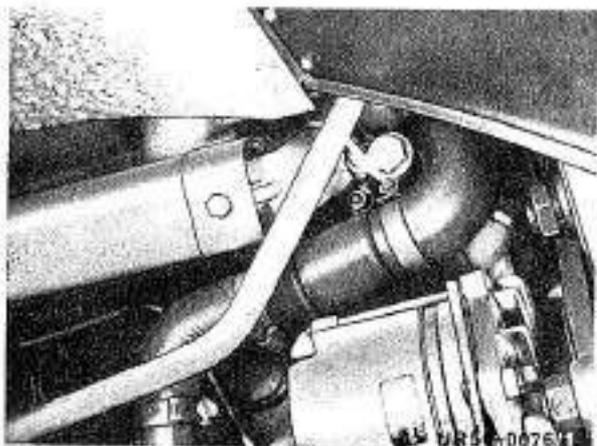

3 Disconnect line to coolant pump.

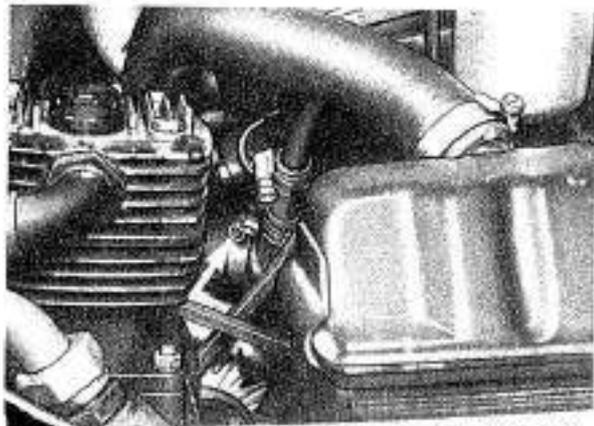

4 Disconnect line to radiator and remove coolant regulator.

5 Clean all parts, check and replace as necessary.

6 Check regulator insert for function, refer to 1.1/2.

7 Installation takes place in the reverse sequence.

8 Fill in coolant.
Refer to 1.1/2 for capacities.

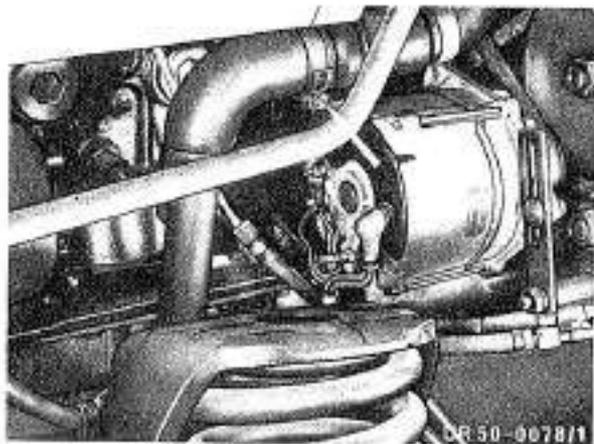

Removal and installation

- 1 Drain coolant. With antifreeze collect contents. Drain plug is underneath the radiator.
- 2 Remove upper coolant hose of coolant regulator.
- 3 Unscrew pipe sockets and remove gasket.
- 4 Remove regulator element.

Important!

When reinstalling, the vent valve (bore) for radiator must be located on the side of the coolant connection, i. e. at the highest point.

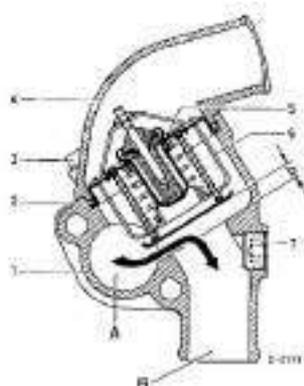

Main valve closed
By-pass valve fully opened
Stroke **b** 7.5 to 8 mm

- 1 Coolant regulator
- 2 Sealing ring
- 3 Hexagon socket screw
- 4 Cover
- 5 Ball valve
- 6 Coolant regulator element
- 7 Screw plug

- A from engine
B to engine via by-pass line

- 5 Check regulator element for function and, if required, exchange. The coolant regulator is best tested in a container with hot water in which a thermometer is immersed. The regulator should begin to open at $79^{\circ} + 1^{\circ}$ C and entirely open at $91^{\circ} + 3^{\circ}$ C.

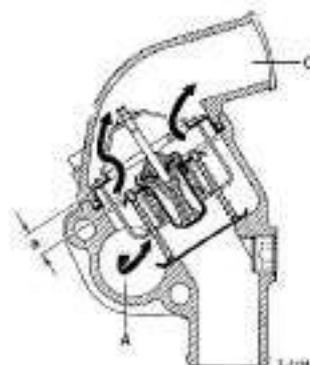

Main valve opened
Stroke **a** 8 to 9 mm at approx. 91° to 94° C.
By-pass line closed

- A from engine
B to radiator

A pressure relief valve in the coolant expansion tank connection ensures an overpressure of 0,4 bar in the system. Consequently the boiling temperature is increased in sea level from 100° to 108° C.

Note:

Repairs cannot be made to the regulator element. Unusable regulator elements are to be replaced.

- 6 Installation takes place in reverse sequence.

- 7 Fill with coolant. Run engine and check hose connections for leaks. Replace hose clamp and rubber hoses, if required.

Note:

The cooling water contents in engine and original radiator is specified for the maximum load of engine (for example high outside temperatures, mountainous area).

Removal and installation

- 1 Drain coolant. With antifreeze collect contents. Drain cock is at the lower coolant line.
- 2 Release hose clamp and hose of coolant line from reservoir to engine and remove.
- 3 Release union nut (knurled nut) and remove with the coolant regulator. Pay attention to rubber gasket which is in front of the bead of the coolant regulator. The arrow embossed on the coolant regulator must always point upward when installing, i. e. toward expansion tank. Coat union nut or threaded ring before the installation with grease.

Note:

Repairs **cannot** be made to the coolant regulator (for example by exchanging the insert). Unusable coolant regulators are to be replaced, recognizable from full opening in cold condition. A coolant regulator is best tested in a container with hot water in which a thermometer is immersed. The thermostat should begin to open at 80°-3° and entirely open at 87° to 88°. At the same time the valve should rise by 8 mm. A pressure relief valve in the coolant expansion tank connection ensures an overpressure of 0.4 bar. Consequently the boiling temperature is increased at sea level from 100° to 108° C.

- 4 Installation takes place in reverse sequence.
- 5 Fill with coolant. Run engine and check hose connections for leaks. If required, replace hose clamp and rubber hoses.

Removal and installation

A. With engine OM 615 and OM 621

- 1 Drain coolant. If coolant contains additives, collect coolant.
- 2 Remove belt tensioner for air compressor.
- 3 Release upper radiator mount.
- 4 Unscrew bracket at the engine block.
- 5 Release and remove v-belt for fan drive.
- 6 Release tensioning device of the alternator and remove.
- 7 Release both hose lines at pipe socket of coolant pump housing.
- 8 Unscrew slide ring seal.
- 9 Unscrew coolant pump (three hexagon bolts).
- 10 Replace gasket and sealing ring between coolant pump and crankcase. Before, thoroughly clean parting surface of sealing compound residues.
- 11 Installation takes place in reverse sequence.
- 12 Install the slide ring seal free of tension and use the two new sealing rings at the connections.
- 13 Fill with coolant, Run engine and check hose connections as well as flange connection of pump at engine block for leaks.

Note:

In order to determine whether the pump correctly works after installation, take closing cover at coolant filter pipe off with running warm engine. The flow must already be visible when engine is idling.

B. With engine OM 636

- 1 Drain coolant. Collect in the case of antifreeze.
- 2 Remove v-belt.
- 3 Unscrew fastening bolts of the coolant pump at the cylinder head. Remove coolant pump. Note gasket.
- 4 Installation takes place in reverse sequence.
- 5 Set v-belt to correct tension, i. e., so that it can just be pressed with the thumb out of the straight (Values according to table on page 1.1/3).

The coolant pump version on engine OM 621 has a slide ring seal between bearing housing and impeller. The coolant pump version on engine OM 636 has a collector ring gasket. The repair in both coolant pump version is the same by analogy.

Disassembly

1 Unscrew coolant pump housing from bearing housing.

2 Pull off hub or belt pulley from coolant pump shaft with extractor 112 589 07 33 00. To do so, the coolant pump shaft is held in a vice with the impeller.

3 Pull the sealing ring retainer with an extractor off the bearing housing. Then press the sealing ring out of the sealing ring retainer.

4 Press the coolant pump shaft with a drift out of the bearing housing.

5 Knock out both deep-groove ball bearings, the sealing ring and if necessary, the slide ring seal out of the bearing housing with a drift.

6 Slip slip ring, collector ring cage, pressure spring and cover off coolant pump shaft with engine version OM 636.

7 In the version on engine OM 621, force out only if necessary, the counter ring with rubber O-ring with two suitable tools at the milled slot of the impeller. Then if necessary, force out coolant pump shaft out of impeller with a drift.

8 Clean and check all parts. Check particularly the coolant pump shaft and the ball bearing as well as in version OM 621 the slide ring seal and the counter ring for wear.

Note:

Sealing rings, retaining rings and in version OM 636 the slip ring are always replaced.

Assembly

9 Press coolant pump shaft into impeller, end of shaft must be flush with impeller.

10 With the version on OM 621, press counter ring into impeller with rubber O-ring after lightly oiling rubber O-ring.

Note: Lapped side of counter ring must point upward (toward slip ring gasket) and must not be damaged when pressing in.

11 Press sealing ring into bearing housing with assembly sleeve.

Beforehand, lightly coat outside of sealing ring and bore in bearing housing with oil.

12 On the version OM 621, press slip ring gasket into bearing housing with suitable installer sleeve. Coat bore of housing with oil beforehand.

13 For version on OM 636 slip compression spring, cover, slip ring cage, sealing ring and slip ring onto shaft.

After assembly, check whether the cover is properly seated on the sealing ring. If necessary push on with screwdriver.

14 Slip housing over coolant pump shaft.

Caution! Do not damage sealing lips of sealing ring in so doing.

15 When fitting coolant pump, do not damage slip ring gasket, fit bearing housing with coolant pump shaft to self-made base ring.

Fit deep-groove ball bearing onto shaft and press into bearing housing with assembly sleeve.

Lightly oil outside of bore of bearing housing and deep-groove ball bearing so that the bearing slides better when being pressed in.

After pressing in the deep-groove ball bearing, check that distance "b" = 23 ± 0.2 mm (refer to p. 1.1/3).

16 Insert circlip on coolant pump shaft and fit spacer sleeve.

17 Fit deep-groove ball bearing on coolant pump shaft and press into bearing housing with assembly sleeve.

Re-check distance from flange of bearing housing to bevel of impeller.

20.9 Disassembling and assembling coolant pump

621

636

18 Install the sealing ring into the sealing ring retainer. Press sealing ring retainer onto bearing housing.

19 Press hub so far on coolant pump shaft until it touches the deep-groove ball bearing.

20 Bolt coolant pump housing to bearing housing. In so doing use a new gasket.

21 Screw in screw plug with new sealing ring into the bearing housing. In so doing use a new gasket. Fill the coolant pump with 10 ccm gear oil, then screw in bleed screw, which must upward in installed condition.

Note:

New or replacement coolant pumps are not filled with oil.

22 Check coolant pump on a test bench or on engine for leaks. The coolant pump must neither lose coolant nor oil.

Fan bearing

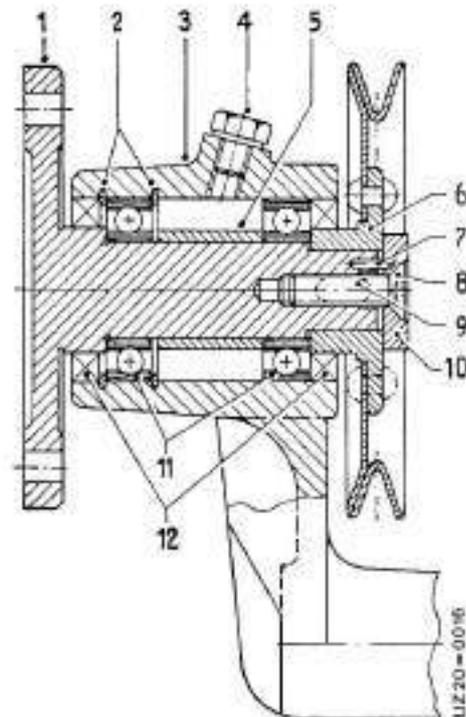

- 1 Drive shaft for fan
- 2 Retaining ring
- 3 Fan bracket
- 4 Oil filler screw
- 5 Spacer sleeve
- 6 Belt pulley
- 7 Clamping sleeve
- 8 Countersunk bolt with hexagon socket
- 9 Key
- 10 Washer
- 11 Deep-groove ball bearing
- 12 Shaft seal

Disassembling and assembling fan bearing

- 1 Remove fan bearing.
- 2 Unscrew countersunk bolt with hexagon socket.
- 3 Remove washer with clamping sleeve.
- 4 Force out drive shaft for fan.
- 5 Remove pulley and gasket.
- 6 Remove front retaining ring.
- 7 Pull out deep-groove ball bearings and unscrew spacer sleeve.
- 8 Check all parts and replace sealing ring.
- 9 Assembly takes place in reverse sequence by analogy.
- 10 Insert front bearing and retaining rings in fan bracket.
- 11 Insert front sealing ring and press in drive shaft for fan from front.
- 12 Slip on spacer sleeve and press on rear bearing.
- 13 Insert rear sealing ring and belt pulley.
- 14 Drive in clamping sleeve and mount washer.
- 15 Fasten countersunk bolt.

Note:

Before inserting countersunk bolt, the bore must be degreased and blown out dry. Insert loctite in screw hole to secure!

Cleaning

If the cooling water starts to boil, there is a fault in the cooling system, possibly too little water or contamination. In that case the cooling system must be **degreased, defurred and cleaned**.

Note:

When examining, above all, check the slide ring seal (rubber hose) from the cylinder head to the cooling water outlet, namely:

1. for cracking,
2. for contamination,
3. for lime deposits.

The free passage through the hose is checked by releasing on one side while observing the escape of water.

Degreasing:

Fill in two handfuls of soda, P 3 or IMI into the cooling system at the cooling water inlet. Drive one day with this additive, then again drain solution. Thoroughly flush through cooling system with engine running with simultaneous flow of fresh water.

Defurring:

We recommend urgently that the defurring be executed only in a customer service centre. Defurring is best performed by means of a hydrochrome treatment

since the cleaning operation can be monitored exactly by means of a test strip supplied by the manufacturer.

Precisely observe instructions for use of the hydrochrome treatment:

Dissolve 13 cm³ solvent in 13 l water and fill in with engine running in partial quantities of respectively 1/2 l. After a longer trip, at least after one day, shortly immerse a test strip through the filler hole into the cooling water. Read which pH-value the shade of the test strip used corresponds to the colour scale supplied together with test instructions and test strips from manufacturer. If this amounts to more than six, drain cooling water, once again thoroughly flush out cooling system and repeat the procedure. The cleaning is concluded, if after a longer trip, the pH-value remains under six. Then once again drain cooling water, thoroughly flush out cooling system and treat the filled cooling water according to instructions for use.

Cleaning:

Blow out radiator from engine side with compressed air or spray with water so that the radiator fins are thoroughly clean of foreign bodies. Check rubber hose connection between radiator and pipeline for leaks and exchange if cracked or brittle. Remove and thoroughly clean thermostat.

Under no circumstances use hydrochloric acid solution for cleaning!

Contents

Chapter	Page
1 General	
Installation group general	1.1/1
Technical data	1.2/1
Faults and remedy	1.3/1
Brake diagram	1.4/1
Sectional view master brake cylinder	1.5/1
Sectional view wheel brake cylinder	1.6/1
Special tools, Consumables	1.7/1
Survey diagram brake lining turning device	1.8/1
Exploded view	1.9/1
2 Adjusting free travel of brake footpedal	2.1/1
3 Bleeding brake system	
Test instructions, storage and storage periods for brake unit	3.1/1
Brake hoses general	3.2/1
Replacing brake fluid	3.3/1
Notes bleeding	3.4/1
Bleeding single circuit drum brake	3.5/1
Bleeding dual circuit drum brake	3.6/1
4 Adjusting service brake	4.1/1
5 Adjusting parking brake	5.1/1
6 Disassembling and assembling single circuit master brake cylinder	6.1/1
7 Disassembling and assembling wheel brake cylinders	7.1/1
8 Disassembling and assembling double wheel brake cylinders	8.1/1
9 Removal and installation of brake shoes	9.1/1
10 Replacing brake linings	10.1/1
11 Turning brake shoes	11.1/1
12 Exchanging handbrake cables	12.1/1
13 Checking ALB-regulator setting, adjusting	13.1/1

Installation survey

Chassis model	Sales designation	Brake system tractor	Trailer	Installation
421-122	U 40 U 45	Single circuit hydraulic system with single circuit compressed air assistance lever type handbrake		Standard with
123				SA 35 324
124	SA 35 344			
125	SA 35 349			
126	SA 35 378			
127	SA 35 379			
128	SA 35 532			
129	SA 35 563			
130	SA 35 621			
131	SA 35 625			
132	SA 35 643			
133	SA 35 718			
134	SA 35 719			
135	SA 35 931			
136	SA 36 031			
137	J 600 T	*1) Dual circuit hydraulic system with single circuit compressed air assistance ALB at rear axle and 1/2 front axle lever type handbrake	Single line	with
138				SA 35 235
139	SA 35 567			
140	U 600		Dual line	with
141				SA 35 536
142	SA 35 425			
143	SA 35 567			
144	SA 35 617			
145	U 60	Single circuit hydraulic system with single circuit compressed air assistance lever type handbrake	Single and dual line	with
146				SA 35 348

*1) SA for model 421, 122, 123, 124, 125, 126, 128, 129, 142 and 143

Technical data**Drum brake (front and rear axle)****Brake linings**

Chassis		Axle		Brake lining					Material
Model	Sales designation	Model at front	Model at rear	Thickness mm	Repair stage 1 mm	Repair stage 2 mm	Minimum lining thickness mm	Lining width mm	
421.124 .125	U 600 (U 54)	737.003	747.007	6.0	5.4 ¹⁾²⁾	7.0	3.0	70 ¹⁾²⁾	Energol W 35 Textar PV 62
.132 .133	U 600 T								
.128 .129	U 600 L	004	008						
.140 .141	U 600	005	009						

Brake drum

Chassis		Axle		Repair stages inner diameter				Permissible ovality from fit core to the inner diameter (%)
Model	Sales designation	Model at front	Model at rear	Normal mm	Repair stage 1 mm	Repair stage 2 mm	Max wear mm	
421.124 .125	U 600 (U 54)	737.003	747.007	349.2 ¹⁾²⁾	350.3 ²⁾	351.3 ²⁾	352 ¹⁾²⁾	0.05
.132 .133	U 600 T							
.128 .129	U 600 L	004	008					
.140 .141	U 600	005	009					

Wheel brake cylinder

Chassis		Axle		Wheel brake cylinder			Air 003 mm
Model	Sales designation	Model at front	Model at rear	Ø Diameter front axle mm	Ø Diameter rear axle mm	Commissate stroke mm	
421.124 .125	U 600 (U 54)	737.003	747.007	34.92	20.54	20 ¹⁾	1.0 ²⁾
.132 .133	U 600 T						
.128 .129	U 600 L	004	008				
.140 .141	U 600	005	009				

1) For axle model 747.007/009: 14 mm

2) Double wheel cylinder

Faults and remedy**Hydraulic system (drum brake)**

Faults	Cause	Remedy
Brake footpedal offers no resistance, but can be fully depressed further and spongy.	Air in the system Too little fluid supply in the reservoir.	Bleed, if possible with bleeder Supplement and bleed brake fluid. Adjust wheel brake before bleeding brakes.
Braking action only after repeated depressing of the brake footpedal	Wheel brake not adjusted Air in the system.	Adjust wheel brake. Bleed.
The brake weakens and the brake footpedal can be depressed fully short time after adjusting.	Leaking lines damaged or unusable sleeves in main or wheel brake cylinder	The line must be sealed, damaged sleeves are to be replaced
Brake heat up during use	Compensating bore in the master brake cylinder clogged Too little clearance between brake footpedal and master brake cylinder piston. Brake shoes - return springs weak. Rubber parts swollen from use of improper fluids	Clean compensating bore of the master brake cylinder Adjust brake footpedal Install new return springs. Drain fluid, remove all rubber parts, flush installation through well with metholated spirits, install new rubber parts including bottom valve and valve seat ring.
Brake tightens itself.	Compensating bore in the master brake cylinder is clogged. This can happen due to swollen sleeve. Use of improper fluid or variation of the brake footpedal stop.	Clean compensating bore with a 0.5 mm fine wire, flush brake line through well with metholated spirits, insert new sleeve, fill with brake fluid, Check and correctly adjust stop of the brake footpedal so that the compensating bore is freely in the idle condition of the brake.

42.3 General

Faults and remedy

Wheel brakes (drum brake)

Faults	Cause	Remedy
Brake pedal travel is too great.	Worn brake linings.	Adjust wheel brakes (do not adjust at the brake foot/pedal); replace brake linings if necessary.
In spite of very high foot pressure poor braking action.	Unsuitable brake linings	Install standard specified brake linings.
	Brake linings oil stained by leaking sealing ring or wheel brake cylinder.	Reseal wheel hubs or nuts and steering knuckle as well as wheel brake cylinder, replace brake linings (washing oil-stained pads with gasoline or petroleum or the flame cleaning of oil-stained pads is no remedy and is prohibited, since lubricating material always escapes during braking from pads treated in this way)
	Brake lining surface glazed.	Turn brake drums, turn brake linings with turning device.
Brakes chatter and tend to lock.	Brake shoes sticking	Remove brake drum, release bearing.
	Brake drum torn.	Replace brake drum
	Out-of-true brake drums	Turn or replace drums. *)
Squealing brakes.	Brake shoe return spring too weak	Replace return spring.
	Badly adjusted brakes	Satisfactory adjust brakes
	Dirt, dust penetrated.	Clean brakes.
Brakes pull unevenly.	Ends of lining not levelled	Revel pads
	Loose lining rivet.	Re-rivet, reline as necessary.
	Out-of-true brake drums	Turn or replace drums. *)
	Piston jams.	Release pistons or replace wheel brake cylinder.
Brake shoe is locked firmly in the pin.	Brake shoe is locked firmly in the pin.	Release brake shoes and pin Exchange tire
	Brakes unilaterally oil-stained.	Replace oil-stained brake linings. Renewal must take place at all brakes, at least axlewise, so that uniform friction conditions exist.

*) Brake drums may always be polished on both sides of axle with some danger

Brake diagram

Dualcircuit hydraulic system with single circuit compressed air assistance, ALB at rear axle and 1/2 front axle

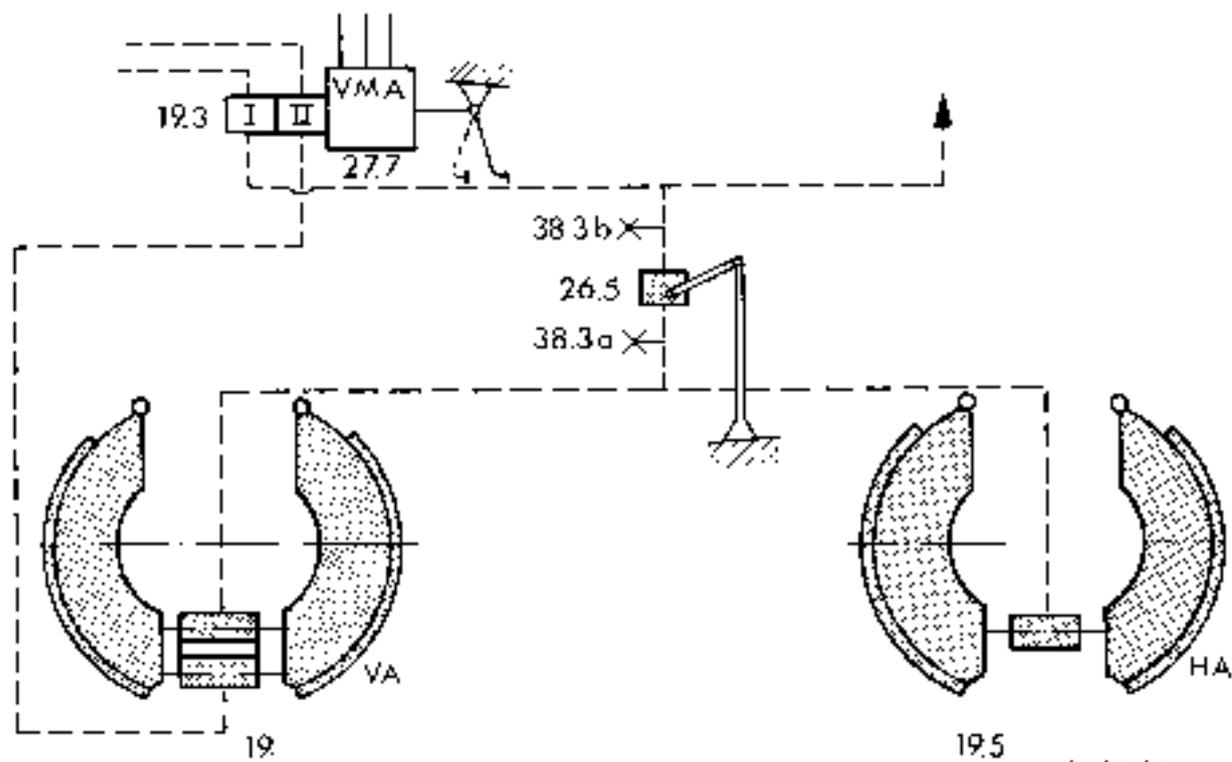
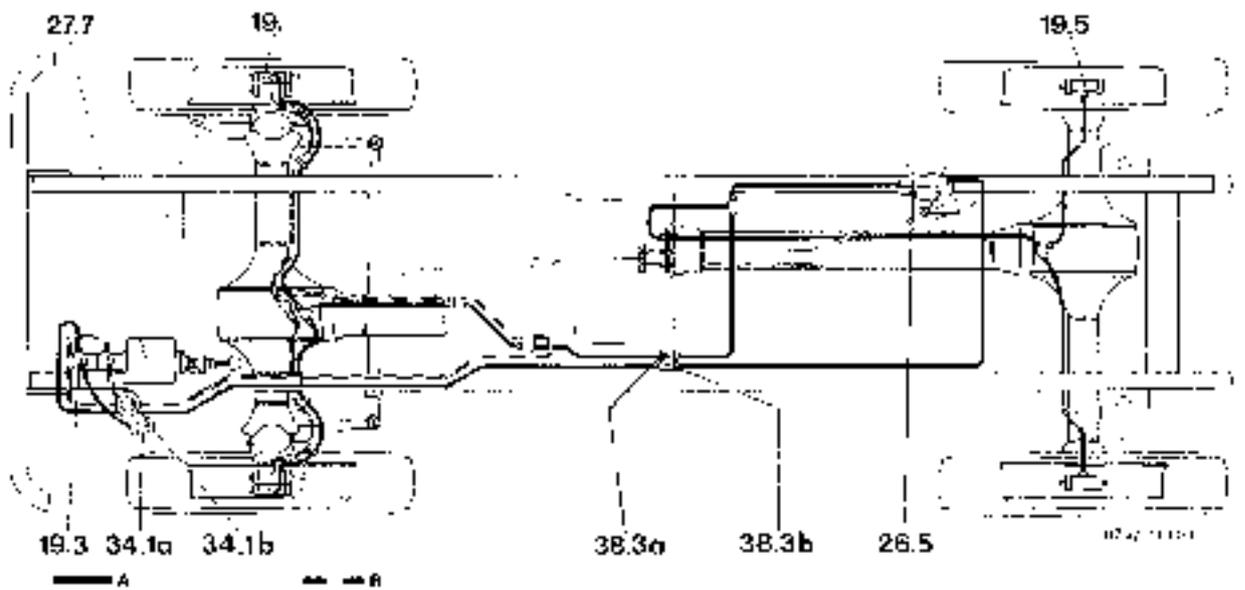

A Hydraulic circuit I
 B Hydraulic circuit II

- 10 Double wheel cylinder
- 19.3 Tandem master brake cylinder
- 19.5 Wheel brake cylinder
- 26.5 ALB-regulator
- 27.7 Compressed air brake booster

- 34.1a Brake fluid reservoir (circuit II)
- 34.1b Brake fluid reservoir (circuit I)
- 38.3a ALB test connection regulated
- 38.3b ALB test connection unregulated

Sectional View

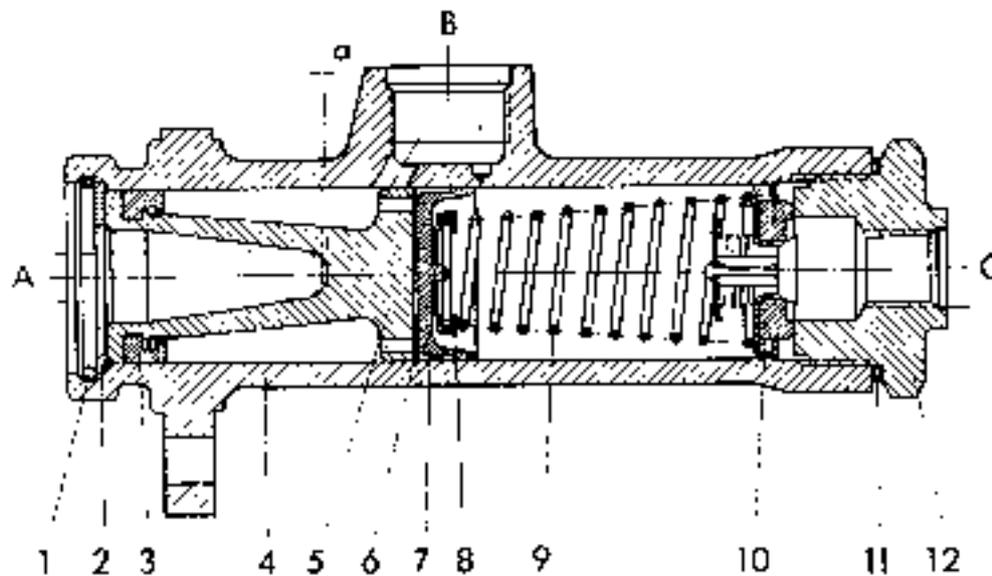

UZ 42-0023

Single-Circuit Master Brake Cylinder

- A Piston rod
 B Connection, reservoir
 C Connection, brake line
 a 1 mm piston rod clearance
- | | |
|-----------------|----------------------|
| 1 Snap ring | 7 Primary cup |
| 2 Stop plate | 8 Spring seal |
| 3 Secondary cup | 9 Compression spring |
| 4 Body | 10 Bottom valve |
| 5 Piston | 11 Sealing ring |
| 6 Filler | 12 Screw plug |

Sectional view

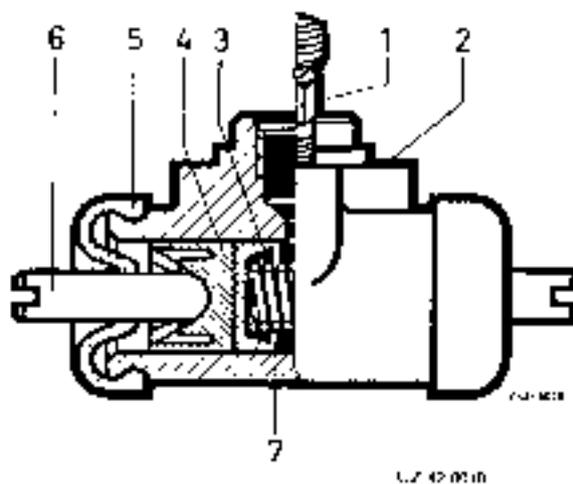

Wheel brake cylinder

- | | |
|---------------|-------------------|
| 1 Bleed screw | 5 Cap |
| 2 Housing | 6 Thrust |
| 3 Sleeve | 7 Pressure spring |
| 4 Piston | |

Sectional view

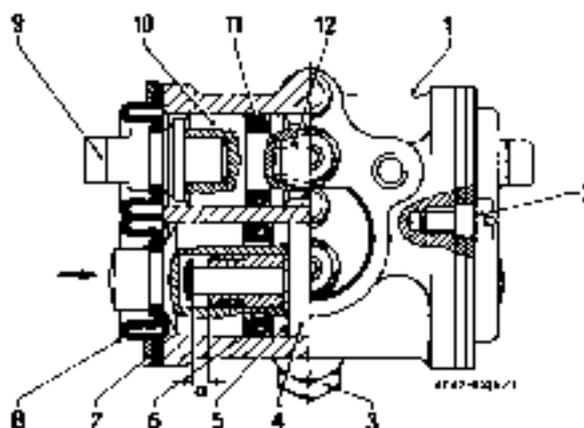

Double wheel brake cylinder

- | | |
|---------------------------|--------------------|
| 1 Double cylinder housing | 8 Cap |
| 2 Slotted-head screw | 9 Thrust pin |
| 3 Skip screw | 10 Piston top |
| 4 Adjuster | 11 Slotted sleeve |
| 5 Piston bottom | 12 Pressure spring |
| 6 Slotted sleeve | a Air gap 1,8 mm |
| 7 Retaining plate | |

Note:

From chassis end no. 012 886 the guide groove at the lower piston (arrow) is no longer provided, face spherically milled

Special tools

Serial no.	Designation	Special tool	Set of tools
1	Blocking device	421 589 00 21 00	B
2	Clamping device	421 589 01 21 00	B

Tool Fa. Kindermann

Serial no.	Designation
1	Brake lining turning device APD 1 for Unimog-MB trac. Special-Unimog flange U 1, spacer, special steel Fa. Kindermann

Consumables

Serial no.	Designation	Part number
1	Long life grease	commercially available

Survey diagram, brake lining turning device APD 1

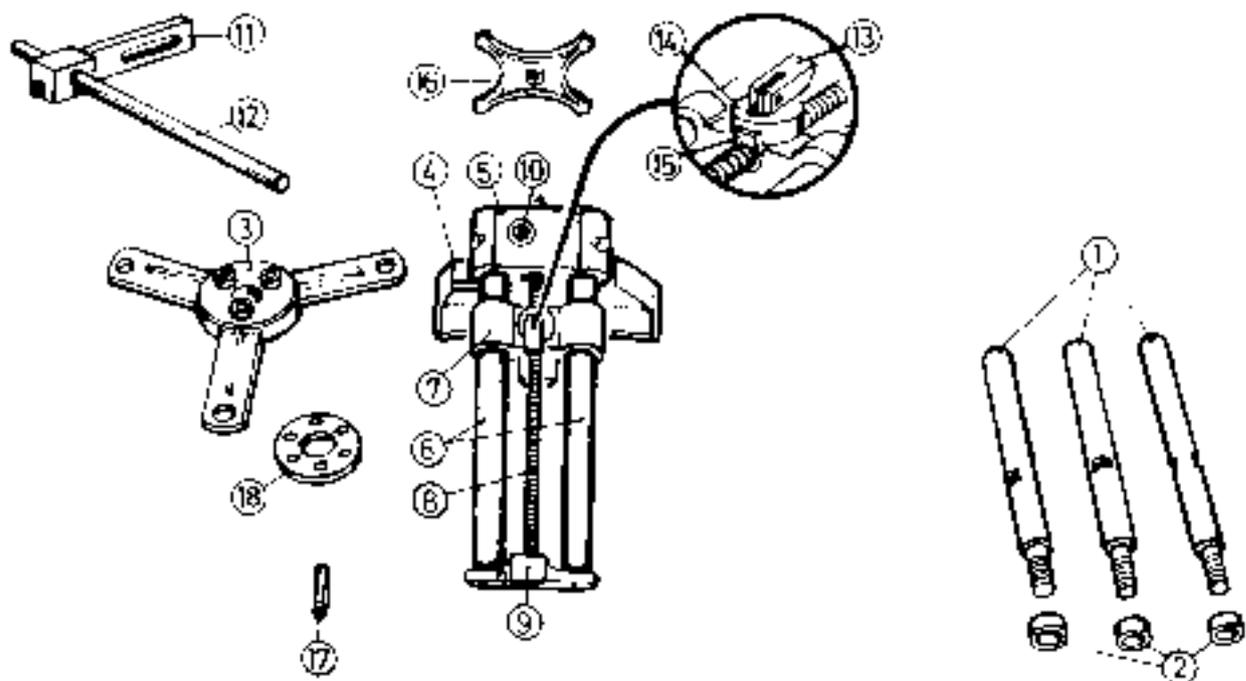

U242-0393

- | | | | |
|---|------------------------------|----|----------------------|
| 1 | Extension | 10 | Setting hole |
| 2 | Spacer ring | 11 | Clamp guide |
| 3 | Spider | 12 | Driver rod |
| 4 | Cross arm mount | 13 | Feed selector finger |
| 5 | Guide column bearing bracket | 14 | Half-round nut guide |
| 6 | Guide columns | 15 | Half-round nut |
| 7 | Steel holder | 16 | Spider |
| 8 | Fearl spindle | 17 | Finish turned steel |
| 9 | Guide column yoggle | 18 | Flexible disk |

Exploded view

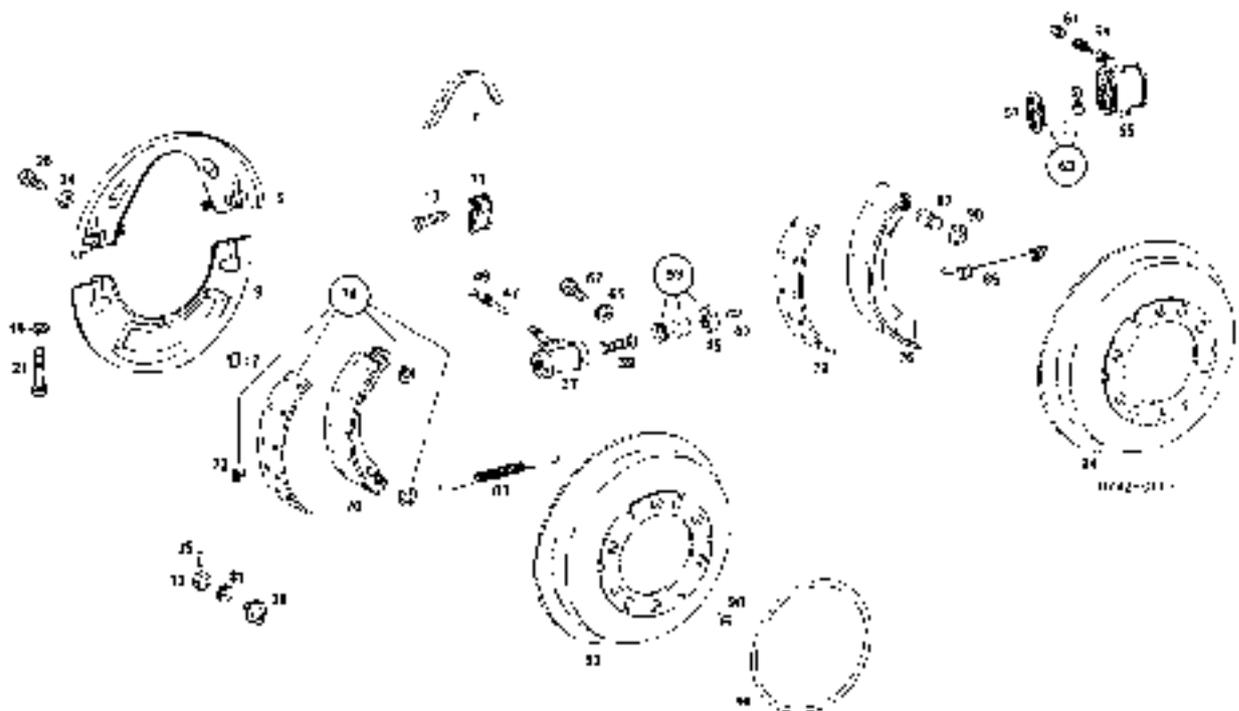

Brake components front axle

5	Guard	55	Double wheel cylinder
7	Sealing rubber	57	Cap
9	Guard	59	Bleed valve
11	Cap	61	Cap
13	Bolt	63	Repair kit
17	Cap	65	Washer
18	Washer	67	Bolt
21	Bolt	70	Brake bracket
24	Washer	72	Rivet
26	Bolt	74	Repair kit
28	Roller	76	Brake shoe
31	Cap spring	78	Brake lining
33	Nut	83	Spring
35	Clamping sleeve	85	Spring
37	Wheel brake cylinder	87	Pin
39	Spring	90	Retaining ring
42	Thrust pin	92	Brake drum
45	Cap	94	Brake drum
47	Bleed valve	96	Gasket
49	Cap	98	Bolt
53	Repair kit		

42.3 General

737.0

Exploded view

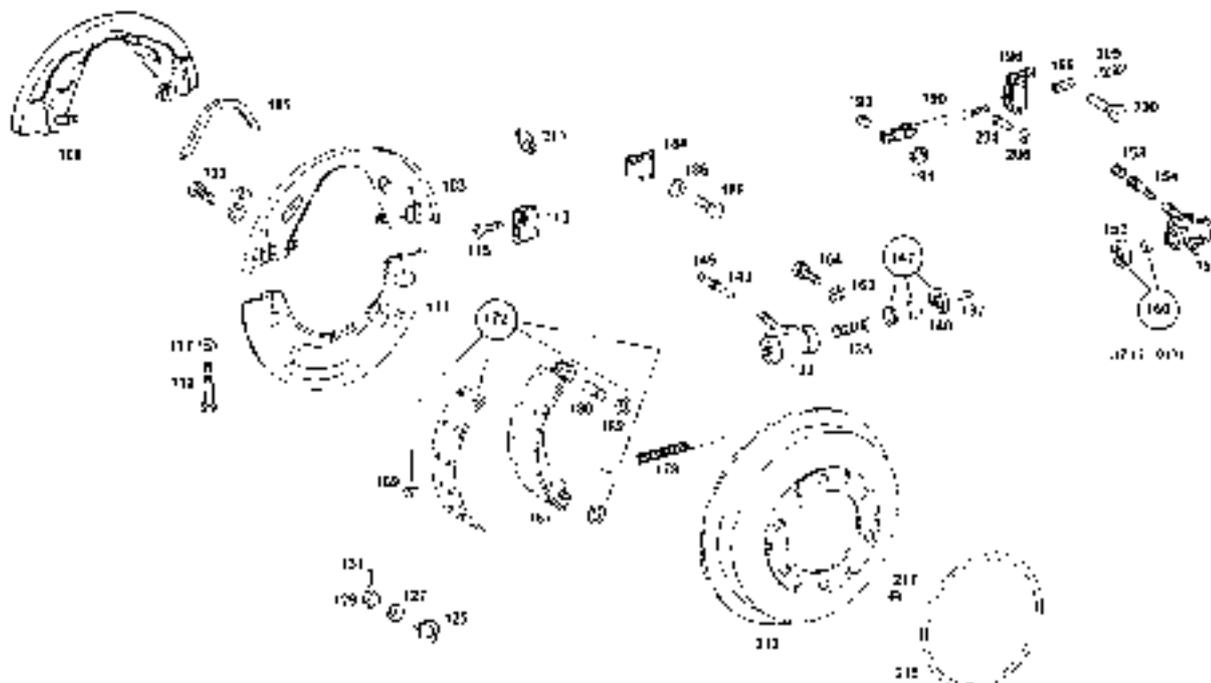

Brake components rear axle

103	Guard	140	Cap	192	Retaining ring
105	Sealing rubber	142	Bleed valve	194	Brake cable guide
106	Guard	145	Cap	196	Washer
111	Guard	147	Repair kit	198	Bolt
113	Cap	150	Wheel brake cylinder	199	Pole
115	Bolt	152		192	Pin
117	Washer	154	Bleed valve	194	Washer
119	Bolt	158	Cap	196	Strap
121	Washer	160		198	Compression strap
123	Bolt	162	Washer	200	Bolt
125	Roller	164	Bolt	204	Pin
127	Cup spring	167	Brake shoe	206	Washer
129	Nut	160	Brake lining	209	Spring
131	Clamping sleeve	172	Repair kit	211	Cap
133	Wheel brake cylinder	178	Spring	213	Brake drum
135	Spring	180	Pin	215	Gasket
137	Thrust pin			217	Bolt

Adjustment

1 With brake pedal at neutral, piston rod clearance must be about 1 mm

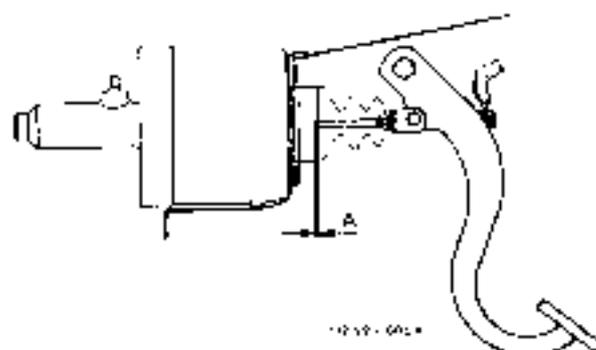

2 If necessary, correct clearance at adjusting screw (eccentric).



Test Specifications, Storage and Shelf Life for Brake Components

Test Specifications

Note: In the interest of road safety, it is essential to give careful attention to checking and reconditioning the brake system. The brake system should therefore be examined at regular intervals.

Scope of Inspection Work

- 1 Check brake shoes and brake pads/linings.
- 2 Check rubber dust caps on wheel and pressure cylinders as well as fixed calipers
- 3 Check brake drums and brake disks
- 4 Check lines for corrosion, charring and pitting.
- 5 Check brake system for leaks (including hydraulic system)
- 7 Check free travel of brake pedal
- 8 Check handbrake
- 9 Check braking action

Note: When reconditioning brake system, note the shelf lives and types of storage for rubber components in brake system

Storage Rooms – Types of Storage – Shelf Life

Spare for hydraulic brake systems, whether complete assemblies or individual components, whether packed or unpacked, must be carefully stored in the interest of safety. Non-compliance with the instructions concerning

Storage rooms – types of storage – shelf life

will normally render the parts unusable.

General

Essential rubber fittings for hydraulic brake systems such as seals, sealing rings, dust caps and brake hoses, are prone to the effects of

heat - oxygen - sunlight - moisture - ozone.

If exposed to such influences when stored, these parts will deteriorate in quality and serviceability to such an extent that they will not be fit for use.

Storage Rooms

Storage rooms for hydraulic brake assemblies, boosters, rubber fittings and brake hoses must be

cool - dry - clean

Storage temperatures should be between -10°C and -35°C . On no account may brake components be stored in the direct vicinity of radiators (at least 1 m away), or in racks positioned above radiators.

42.3 Bleeding Brake System

Types of Storage

Packaged single parts must be left in their packaging until they are needed.

Unpackaged parts should be sealed by means of threaded stoppers at open connecting holes. Parts removed from their packaging must be properly closed again for further storage.

Brake hoses must be stored on flat surfaces, without strain or stress. This means that they must not be kinked or bent over edges. Brake hoses may be stored in their original packaging (U-shaped bend).

Rubber fittings such as seals, sealing rings and dust caps require extreme care and must not be deformed by unnecessary loads. This particularly applies to secondary cups and groove seals. These rubber parts may be stacked in layers one above the other. If appropriate storage space is available.

Shelf Life

Master Cylinders, Tandem Master Cylinders, Wheel Cylinders, Input Cylinders, Output Cylinders 4 1/2 years

Unions and bleeder valves must be tightened and all connection holes sealed with stoppers. Units must be assembled, using the specified protective (not brake fluid).

Master Cylinders and Tandem Master Cylinders for Brake Boosters

may also be stored for 4 1/2 years, provided they are obtained as separate assemblies.

Brake Pressure Regulators 4 1/2 years

Brake Booster T 50 2 years

Trouble may be expected if this shelf life is exceeded. These boosters may be reconditioned only by the manufacturer and must be returned to us for overhaul at the customer's expense.

Brake Boosters T 51/T 52 Complete with Master or Tandem Master Cylinder 4 1/2 years

Trouble may be expected if this shelf life is exceeded. The vacuum part cannot be reconditioned and must be scrapped.

Vacuum Part for Brake Boosters T 51/T 52 5 years

These brake boosters cannot be reconditioned and must be replaced.

Brake Hoses, Clutch Hoses 4 1/2 years

Rubber Fittings (loose, stored dry) 4 1/2 years

Rubber Fittings in Repair Packs 4 1/2 years

Repair Packs with Assembled Rubber Parts 4 1/2 years

Stoplight Switches 5 years

Brake Fluid (sealed in original containers) 5 years

Re-close container properly after removing fluid.

Brake Pad/Lining Repair Sets 10 years

Brake Hoses, General

Brake hoses are the moving links in the brake system piping.

Any brake hose that is exchanged must be replaced by one of exactly the same length and positioned at exactly the same location.

Maintenance

After lubricating, ensure that no grease is left on brake hoses. All grease residues should be carefully removed. Prior to using sprays containing mineral oil, it is recommended to cover the brake hoses. This should also be done when applying underbody protection.

Brake hoses must not be painted

Stove-enamelling or treatment with radiators after painting must not exceed 80°C.

Cleaning

Dirt deposits should only be removed with water. Never use light-grade petroleum, paraffin or similar.

Installation

The end of new brake hoses must be perfectly clean for installation. Never subject to tension, kinking or torsion, nor allow to chafe. Note maximum wheel lock and spring travel.

Tighten screw fittings well. Then refill hydraulic system with fluid and vent. Make absolutely sure that front brake hoses do not touch steering knuckles and do not get pinched when steering wheel is turned.

Exchanging Brake Fluid

General

Brake fluids conforming to DOT 3 and DOT 4 are hygroscopic, i.e. they absorb moisture from the air. This lowers the boiling point of brake fluid and all containers must therefore be properly closed. Since considerable heat may be developed by braking and reliable brake operation is extremely important, the water proportion must be kept as low as possible. The higher the water content, the greater the risk that the brake system will fail as a result of vapour bubbles.

You are therefore advised to exchange the brake fluid **once every year**.

Caution! Never re-use old brake fluid.

Filtration is also inadequate because it will only remove a certain amount of dirt, and leave all the harmful water that cannot be seen. Even traces of mineral oil, e.g. engine or gear oil, may cause rubber components to swell severely and lead to brake failure. To eliminate all risks, it is absolutely essential that brake fluid is stored in the original containers. These containers must never be filled with any other liquid or fluid. Clean tools free of oil and grease are a matter of course. Brake fluid is frequently mistakenly referred to as "brake oil". This term should always be avoided because brake fluid is not an "oil" and must not be confused with "oil" on any account.

Inadvertent Consumption of Brake Fluid

Normal brake fluids, like the ATE range, chiefly contain polyglycol ether, along with special additives.

The consumption of brake fluid will therefore cause signs of poisoning such as headaches, dizziness, stomach upsets, vomiting, diarrhoea and unconsciousness. Like many other liquids used for engineering purposes, brake fluids may also have **lethal consequences** if consumed inadvertently in large quantities.

Therefore, do not store brake fluids in places which are accessible to children or other persons who cannot read the marking.

Automotive mechanics are frequently found to store brake fluid in beverage bottles. This is a bad habit which has repeatedly led - particularly in hot weather - to brake fluid being consumed inadvertently.

On no account pour brake fluid into bottles for beer, coca cola, mineral water etc.

Medical aid is required if brake fluid is drunk despite these precautions. The doctor should immediately flush out the patient's stomach and then contact a clinic able to handle cases of poisoning.

Medical Notes for Doctor:

1. Flush out stomach:
 - a) Either with 50 cc glycerol added to water - or
 - b) With a potassium permanganate solution of 1 : 5000.
2. Intravenous: calcium gluconate 20 cc 20%.
3. Intravenous: drip infusion of 0.5 - 2 l mannite in 6 hours, with 40 mg lasix on first day.
4. Immediate peritoneal dialysis.
5. Electrolyte substitutes, e.g. stercorundin, similar to treatment of overdose of sleeping tablets.

Please consult appropriate experts for further details.

Caution: Parts of the body which come into contact with brake fluid should be thoroughly rinsed with water. Eyes should be rinsed out with borax solution.

Information obtainable from following experts:

Dr. med. H. J. Kutschmar Fayzweke Hoernel AG Werk Giesdorf (Tel. Burgkuechen)	Phone Dir. Dial Code 05679	Tel. No. Ext. 71 Ext. 545
Dr. H. Salvecke Fayzweke Hoernel AG Werk Giesdorf (Tel. Burgkuechen) or other office hours	05679	Ext. 71 Ext. 652
	05671	Ext. 0646

Instructions for Bleeding

The brake system must be bled after any repair job that has involved opening the sealed hydraulic system, or when the brake pedal feels soft and spongy. A variety of special-purpose equipment, e. g. the ARC 50 unit or the ATE filler/bleeder, are commercially available for this purpose. Follow the instructions supplied with this equipment.

Do not re-use fluid that has been pumped out when bleeding because it may contain foreign matter which will then enter the brake system. In addition, brake fluid, being highly hygroscopic, steadily absorbs moisture from the atmosphere and its boiling point drops during service life. As a result, vapour bubbles may form in the brake system under extreme conditions.

Brake fluid contains constituents which will dissolve paint. Ensure that brake fluid is kept well away from the vehicle paintwork.

When bleeding the system, ensure that the bottom of the refilling container is always covered by brake fluid. On no account may the compensating port be free of fluid because air will otherwise be drawn in when the brake pedal is pressed, rendering the entire bleeding operation futile.

Also ensure that the bleeder vessel is held high enough so that the level in the vessel is higher than the outlet from the bleeder valve.

Bleeding is completed when bubble-free brake fluid flows through the bleeder hose.

Following bleeding, top up reservoir to 'Maximum' mark with brake fluid.

Note: If the system is bled by 'pumping' the brake pedal, remember to close the corresponding bleed screw each time before releasing the brake pedal. This ensures that air cannot be drawn in through the bleed screw hole.

Bleeding

- 1 Prop up engine hood.
- 2 Prepare bleeder for use in accordance with manufacturer's instructions.
- 3 Unscrew cap on reservoir and connect bleeder.
- 4 Remove dust cap from bleed screw at master cylinder and connect bleed hose.
- 5 Bleed master brake cylinder as described in 3.4/1.
- 6 Bleed wheel brake cylinder at rear axle by analogy to steps 4 to 5.
- 7 Bleed wheel brake cylinder at front axle by analogy to steps 4 to 5.

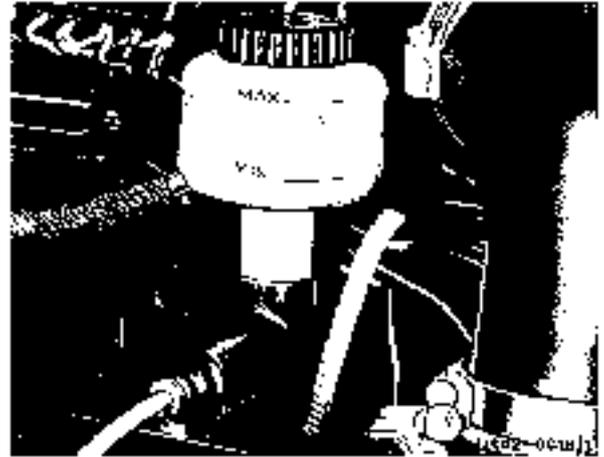

Bleeding

- 1 Raise bonnet
- 2 Make bleeder operable according to specifications of manufacturer
- 3 Unscrew closing cover of expansion tank from circuit I or II and connect bleeder.



- 4 Remove dust cap at bleed screw and connect bleeder cylinder.



- 5 Bleed master brake cylinder, as described in 3.4/1.

- 6 Execute further bleeding in following sequence.

Brake circuit I

Master brake cylinder, hydropneumatic control valve ALB regulator, wheel brake cylinder, beginning at rear right, rear left, front right, front left.

Brake circuit II

Master brake cylinder, wheel brake cylinder front right and front left below



Adjustment

Note: Adjust brakes individually at each side when brake drums are cold.

- 1 Unscrew back plate at bottom.
- 2 Jack up vehicle and release parking brake.
- 3 Turn adjuster (1) outward (b) until brake shoe contacts brake drum.
- 4 Turn adjuster (1) back (a) so that wheel just turns freely.
- 5 Press brake pedal several times, checking if wheels turn freely.
- 6 Adjust service brake at rear axle, referring to steps 2 to 5.
- 7 Attach back plate and lower vehicle.
- 8 Perform trial run.

Note: Adjustment is correct if brake drums are still cool after a lengthy run without braking.

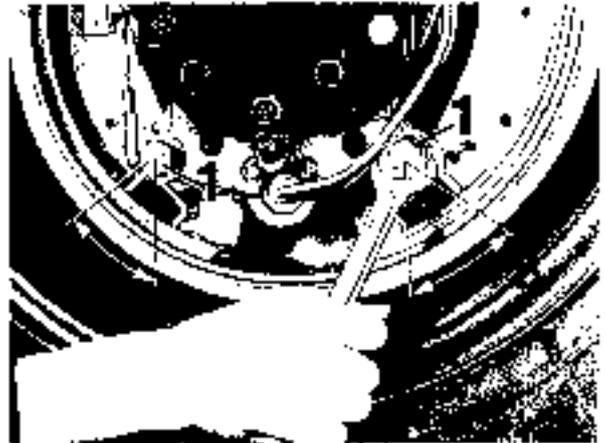

Adjustment

- 1 Adjust service brake, refer to 4.1/1
- 2 Turn thrust rod until brake shoe contacts brake drum

Note: Thrust rod has righthand thread

- 3 Turn thrust rod back until wheel just turns freely, pressing brake pedal several times while doing so

- 4 Apply handbrake rack to second detent. Trailer control valve must operate in this position if trailer brake system is fitted.

Note: When rack is tightened to fourth detent (brakes begin to act at third detent), both rear wheels must resist turning by hand but turn freely again when rack is released



Disassembly and Assembly

The Item Nos. () relate to p. 1.6/1.

- 1 Unscrew reservoir.
- 2 Remove snap ring (1) and stop plate (2). Take out piston (5) with secondary cup (3).
- 3 Remove compression spring (9) together with spring seat (8) and bottom valve (10).
- 4 Clean and check all parts, replacing if necessary.

Note: Never use anything but **spirit** to clean any part. Cleaning with **gasoline**, benzene or paraffin or with any mineral oil or grease will **destroy** rubber components or cause them to **swell**. Rubber components with scored surfaces or flattened edges must be replaced.

- 5 Assemble in reverse sequence.

Note: Prior to installing, coat cup seats, piston and cylinder bore with brake cylinder paste No. 2.

Disassembly and Assembly

- 1 Clean exterior of slave cylinder.
- 2 Take off dust caps (2) and remove with thrust pins (3).
- 3 Remove pistons (4), cup seals (5) and compression spring (6).
- 4 Remove bleed screw (7).
- 5 Clean all parts with brake fluid or spirit and check. Replace any damaged part.
- 6 Assemble in reverse sequence.

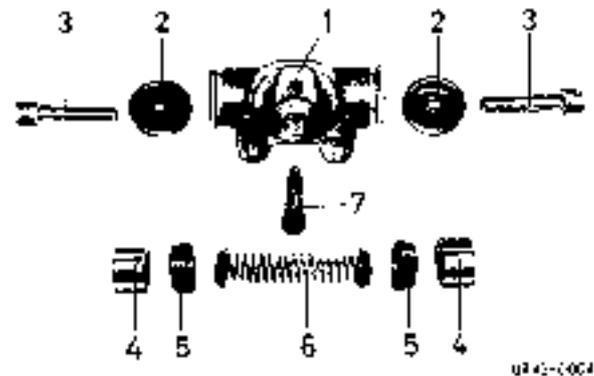

0942-1004

Note: When dry, pistons must fit snugly in cylinder bore. Edges of rubber seals must be sharp, running surfaces must not be scored. Prior to assembling, coat cylinder bore, pistons and seals with brake cylinder paste No. 2.

Disassembly and assembly

- 1 Remove wheel brake cylinder.
- 2 Externally clean wheel brake cylinders.
- 3 Remove slotted head screw, remove retaining plates.
- 4 Remove caps of the wheel cylinder housing, remove thrust pin and piston with collared rings from upper chamber.
- 5 Unscrew stop screw below with sealing ring.
- 6 Remove piston below completely from lower chamber of wheel brake cylinder.
- 7 Remove slotted sleeves of both pistons.
- 8 Unscrew bleed screws.
- 9 Clean and check all parts with brake fluid or methohalated sprits. Replace damaged parts.
- 10 Assembly takes place in reverse sequence.

Note:

The pistons must move back and forth in dry condition aspirating in the cylinder bore. The edges of the slotted sleeves must be sharp-edged, the bearing surfaces may not show any scoring. Before assembly, cylinder bore, piston and slotted rings must be provided with ATE-brake cylinder-paste.

- 11 Install wheel brake cylinder.

Removal and Installation

- 1 Detach wheel
- 2 Unscrew countersunk bolts and force off brake drum.
- 3 Remove brake backplates.
- 4 Detach brake shoe return spring
- 5 Release and remove brake shoe pin

Note: When removing brake shoes at rear axle, additionally detach handbrake cable and remove handbrake thrust rod.

- 6 Remove brake shoes.
- 7 Install in reverse sequence, coating brake shoe pin with grease No. 5

Note: Countersunk bolts must not project.
Check sealing ring in brake drum for wear, replacing if necessary.

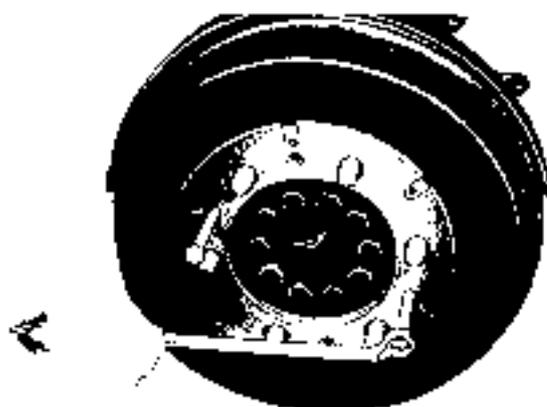

UR 15-3003

Replacement

Note: Brake linings which are oily, brittle or worn down to minimum thickness must be replaced.

- 1 Remove brake shoes, referring to 11.1/1

Note: Prior to selecting new brake linings (repair stages), check brake drums for thermal cracking scoring and wear machining or replacing if necessary. Use a brake drum lathe in accordance with manufacturer's instructions. Refer to Table 1.3/1 for minimum lining thickness and repair stages of brake linings as well as diameters and repair stages of brake drums.

Always use brake linings of same type on any one axle.

- 2 Remove fastening rivets.
- 3 Clean, check and dress contact surfaces of brake linings on brake shoes.
- 4 Select brake linings to suit brake drum diameter (repair stage) and rivet in position.

Note: It is preferable to use a riveting machine and rivets approved for the purpose. Set up riveting machine according to manufacturer's instructions. Start riveting in centre. Do not turn lining segments through 180°, thickest side of lining pointing toward centre of brake shoe. Brake lining must fit snugly across entire surface. Corners of linings must not be broken nor must linings be torn at rivets.

- 6 Install brake shoes, refer to 9.1/1

Note: To ensure that new brake linings provide immediate effect, they must be dressed in situ on axle, refer to 11.1/1

Dressing Brake Linings on Axle

Brake shoes can be dressed in situ using brake shoe turning equipment.

Be sure never to exceed maximum brake drum diameter specified; refer to 1.3/1 for permissible brake drum diameter.

Diameters of brake drums and brake shoes must always be equal on any one axle.

Turning**Note:**

The numbers in brackets refer to survey diagram of brake booster.

- 1 Switch off four-wheel drive and differential lock.
- 2 Raise vehicle, remove running wheels left and right at respective axle.
- 3 Remove recessed screw and remove brake drum.
- 4 Remove brake cover plates.
- 5 Unscrew bracket for handbrake cable.
- 6 Unscrew oil filter screws and bolt (special tool no. 1 for brake shoes right and left).
- 7 Align brake shoe parallel with both threaded nuts of special tool no. 1.

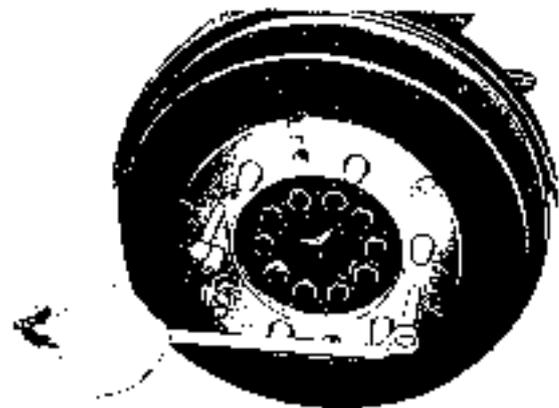

UR35-C003



UR42-0050/1

- 8 Install mounting plate for brake turning device at wheel hub or nut.



UR42-0055/1

- 9 Bolt cross arm of brake turning device at mounting plate.

- 10 Introduce and clamp cutting tool (17) up to the stop in steel holder (7).

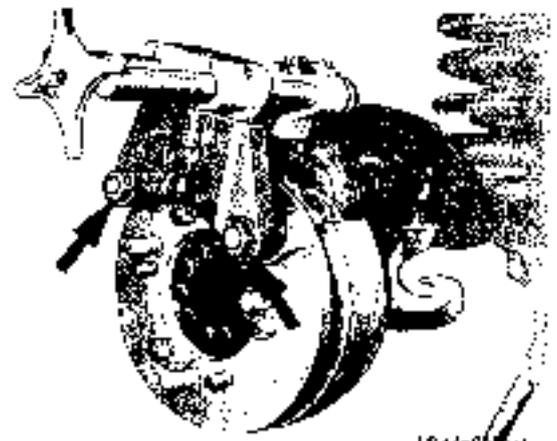

UR47-0005/1

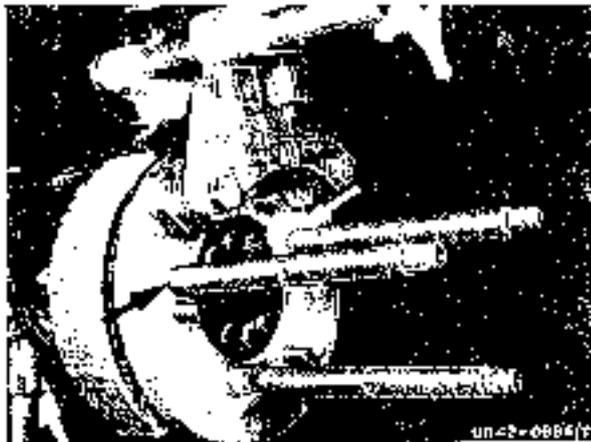

11 Fasten extensions (1) to wheel pin

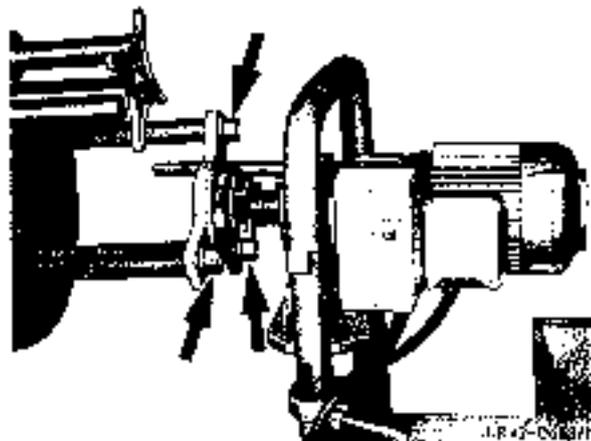

12 Fasten corresponding spider (3) to extensions, install flexible disk (18) of drive motor at spider(3)

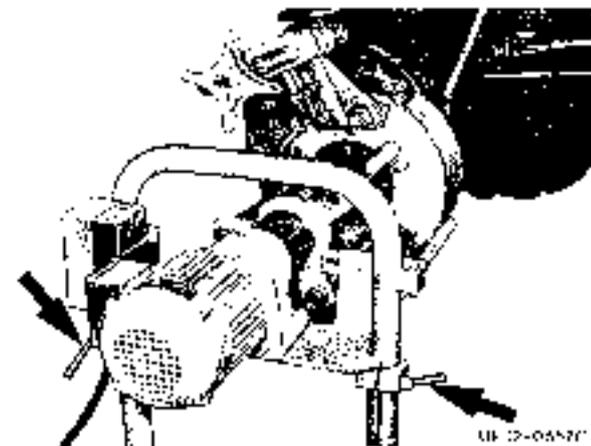

13 Release locking screw and adjust height of the centre of drive motor to the centre of wheel hub.

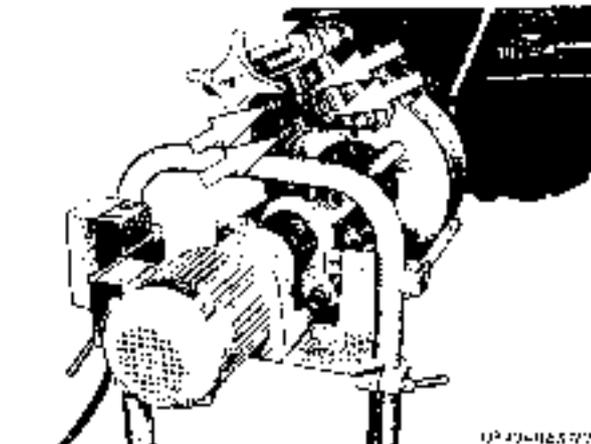

14 Release locking screws of cross arm mounts.

15 Adjust cutting tool by turning central setting bolt (10) to corresponding turning diameter.

Note:

1 Scale graduation on side rough scale = diameter adjust of 1 mm.

1 Scale graduation on mounting scale = 1 = diameter adjust of 0.1.

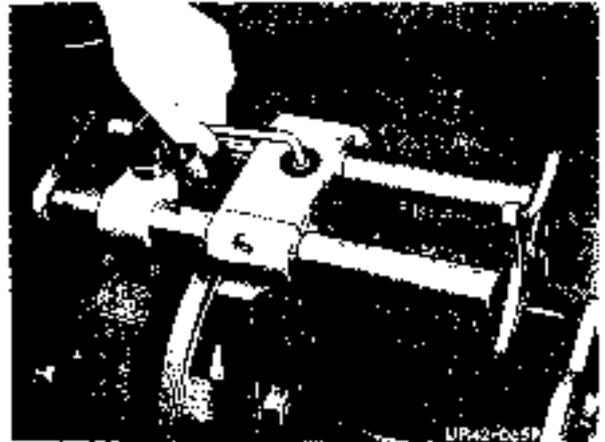

for example, adjusting to drum diameter

⊙ 365 mm:

- 1) Diameter a = 36 mm drum or turning dimensions for brake shoes
- 2) Diameter b = 320 mm mounting plate
- 3) c = mounting plate
- 4) setting on rough scale for turning diameter 365 mm

Fine scale must be at "0".

Drum or turning diameter 303 mm to max. 0.368 mm

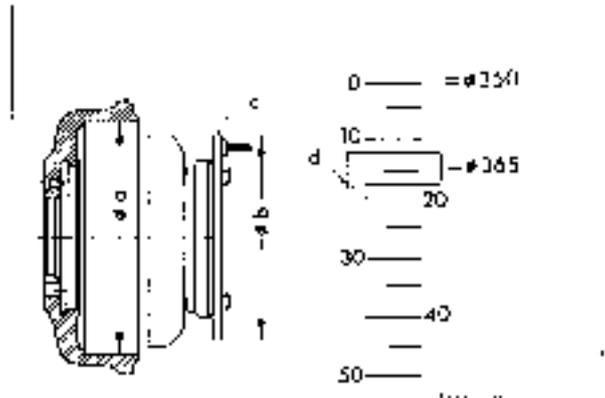

16 Tighten locking screws

17 Using special tool no. 1, tighten brake shoe right or left.



18 Insert special tool no. 2 in brake shoes.

19 Adjust opposite brake shoes by turning tension nut of special tool no. 2 so that the cutting tool uniformly turns the entire surface of the brake lining.

20 Fasten special tool no. 1 and adjust securing brake shoe, as described in operation 19.

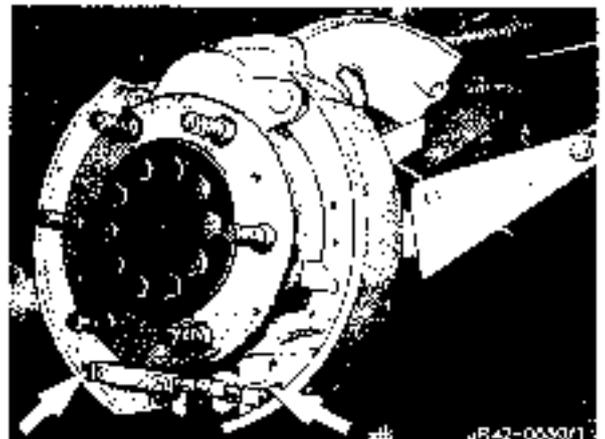

42.3 Turning brake shoes

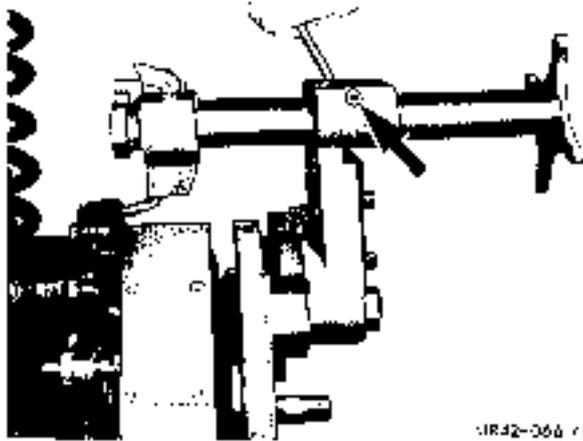

0R42-066 (1)

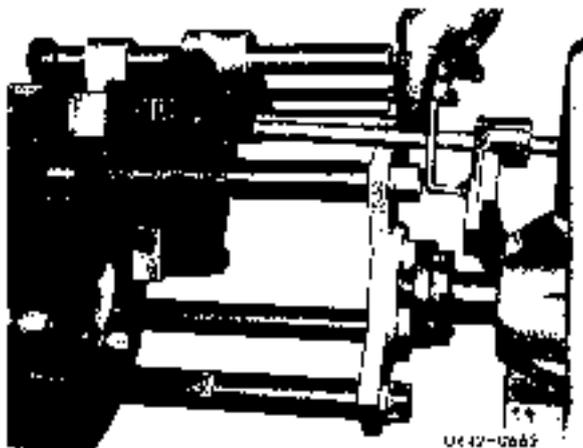

0R42-066 (2)

21 Release locking screws in the guide column bearing bracket (5), shift guide columns (6) with lined spindle (8) and steel holder (7) until the cutting tool is some mm outside the edge of brake lining. Fasten locking screws.

22 Check end cut-cut by freely turning spider (16).

23 Raise feed selector fingers (13), push steel holder into starting position, again lower feed selector finger (13)

24 Push back guide driver rod (12) in clamp guide (11) so far that spider (16) is still grasped

25 Release clamp guide and adjust so that a clearance of from 2 to 3 mm exists between driver rod (12) and cut out of spider (16).

26 Place spider vertically and turn once by hand to check ease of operation

27 Install protective cover and turn brake shoes

Note:

Repeat turning if necessary until drum or turn diameter on entire brake shoe is reached and corresponding air gap is ensured.

Exchanging

- 1 Remove wheels
- 2 Remove recessed screw and remove brake drum.

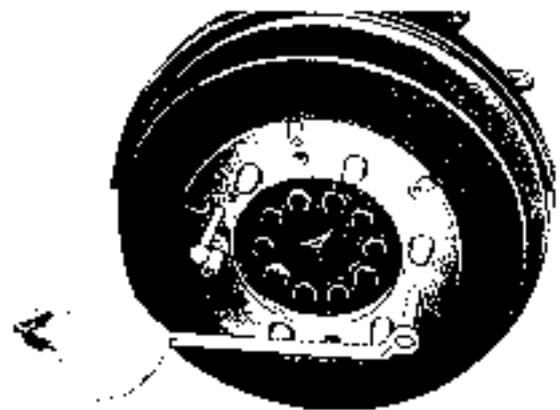

UR15-0003

- 3 Release adjusting nuts (1), remove handbrake cable from bracket.
- 4 Release fastening clips for handbrake cable at axle struts to right and left.
- 5 Remove brake cover plate

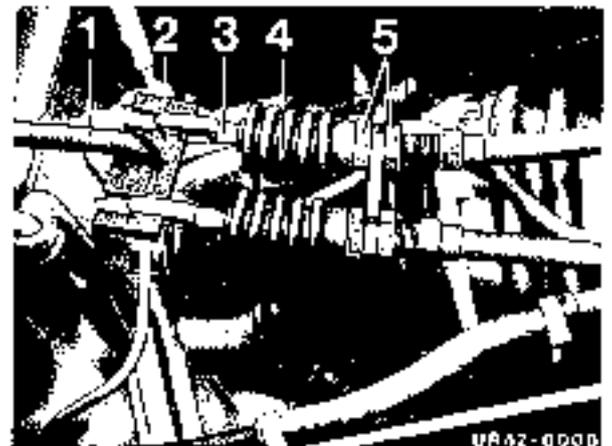

UA42-0000

- 6 Detach brake cable from brake shoes, remove brake cable
- 7 Installation takes place in reverse sequence.
- 8 Adjust parking brake system, see 5.1.1.

Checking setting, adjusting to chassis and no. 013 170

The ALB-regulator must not be adjusted. Connect two manometers to respective test connections 1 and 2 of empty vehicle for hydraulic examination of the setting (brake force distribution). Actuate foot-brake pedal until overpressure indicates 100 bar (kp/cm^2) on the pressure gauge (test connection 2). This value corresponds to **unregulated overpressure before** the ALB-regulator. An overpressure of 40 or 45 bar (kp/cm^2) must then exist at the second pressure gauge (test connection 1). This value corresponds to the regulated overpressure after the ALB-regulator. Adjustment after lengthy driving.

When loaded (perm. payload) the pointer must agree with the housing mark on the actuating shaft.

The regulator lever should be at least horizontal on the sensation and if possible point even 3 to 4° upward. Due to negligible setting springs, the pointer can be offset to the left. **Remedy:** adjust control rod in its length by turning ball heads until pointer and housing mark are aligned.

Observe sign in driver's cab for adjusting reg. valve.

Perform adjustment only at control rod. The control rod must be attached to the correct bore of the regulator lever. See table.

Brake force control	
Nominal values vehicle	
load bar (kp/cm^2)	100,100
unloaded bar (kp/cm^2)	$100 \pm 40 \pm 1$
Regulator lever bore	Middle
Lever arm length (mm)	92
Distance (mm) after installation spacers	86
Corresponding rear axle load (kg)	approx. 2400

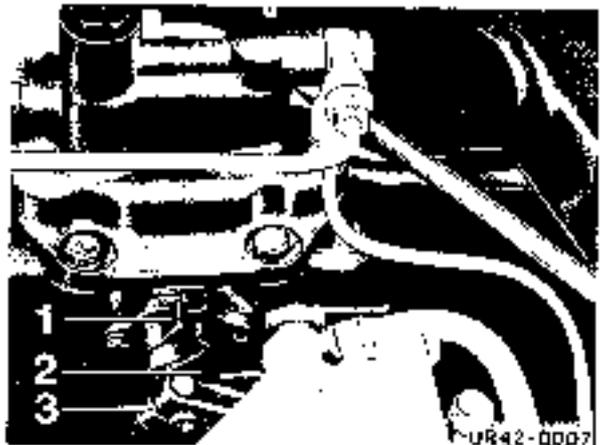
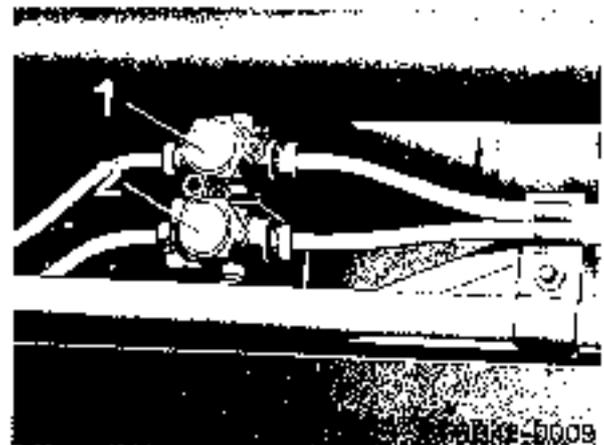

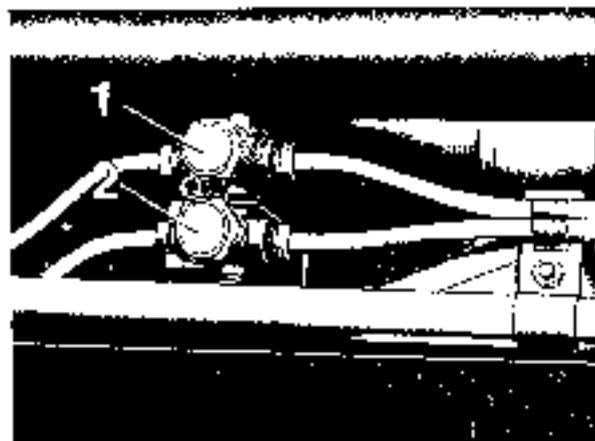

Checking setting, adjusting (Westinghouse regulator)

From chassis end no. 013 171

- 1 For checking, detach fail-safe device control spring from torque tube.
- 2 Connect pressure gauge of the tester to both test connections in front of and behind the ALB-regulator.

- 1 Test connection regulated.
- 2 Test connection unregulated.

3 Slowly depress brake footpedal fully. At the same time both pressure gauges uniformly climb up to the fail-safe pressure of 26 to 30 bar, then the pressure gauge of the regulated circuit must stop.

4 Adjust as required pressure of the regulated circle to 26 to 30 bar at adjustment screw (1).

5 Attach control spring at torque tube.

6 For checking the load-dependent throttle control, determine rear axle load in vehicle ready for driving (weigh).

7 Fully depress brake footpedal (until approx. 140 bar) in so doing the pressure gauge pointer of the regulated circuit must remain within the specified pressure range (see diagram).

8 If required adjust the control pressure by shifting control spring in elongated hole at torque tube.

Note:

- Shorten spring travel. Control pressure is reduced.
- Lengthen spring travel. Control pressure is increased.

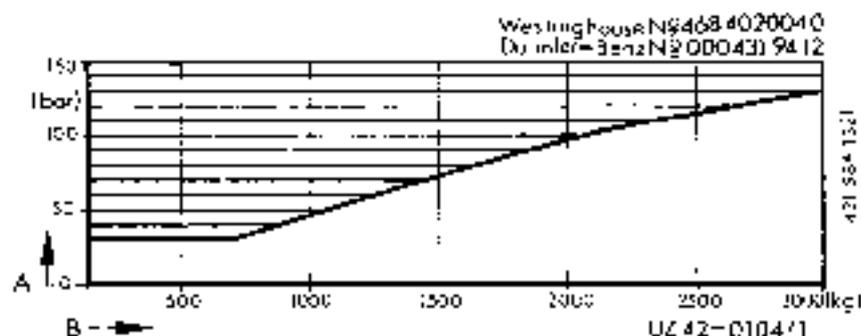

A Pressure not regulated (cut off at 10 bar)
 B Control pressure at rear axle (5 mm)

Contents

Chapter	Page
1 General	
Installation survey compressed air systems	1.1/1
Installation survey compressed air system (EC-version)	1.2/1
Installation survey equipment	1.3/1
Equipment number codes	1.4/1
Mode of operation of the compressed air brake system	1.5/1
Faults and remedy (without EC-version)	1.6/1
Faults and remedy (EC-version)	1.7/1
Technical data and notes for laying and preparing of piping	1.8/1
Description of the brake system	1.9/1
Symbols (basic symbol) pneumatics and hydraulics DIN 24300	1.10/1
Symbols pneumatics and hydraulic system DIN 24300	1.11/1
Brake diagram	1.12/1
Function drawing	1.13/1
2 Control equipment	2.1/1

Installation survey compressed air systems

All chassis models have hydraulic single-circuit-brakes as standard

Sales designation	UNIMOG Chassis model	Compressed air system		Chassis edition	Special version SAs 3s	Observations
		Designation	Version			
U 045/421 (L 040/421)	421.122 421.123	421 030 06 42	-	-	374/2	
		421 030 21 43	E	-	355/3	
		421 030 23 43	E	-	335/4	
		421 030 25 43	Z	-	356/3	
		421 030 26 43	Z	-	358/4	
		421 030 27 43	K	-	348/3	
		421 030 28 43	K	-	348/4	
		421 030 17 43	-	-	378/1	French version
		421 030 18 43	-	-	378/2	French version
		421 030 23 43	-	-	335/7	Swiss version
		421 030 24 43	-	-	335/6	Swiss version
		421 030 15 43	-	-	340/5	Italian version
		421 030 20 43	-	-	349/6	Italian version
U 052/421	421.124 421.125	421 030 06 42	-	-	379/4	
		421 030 30 43	F	-	335/8	
		421 030 35 43	E	-	375/11	
		421 030 30 43	Z	-	336/5	
		421 030 33 43	K	-	346/6	
		421 030 36 43	-	-	378/3	French version
		421 030 37 43	-	-	378/4	French version
		421 030 31 43	-	-	355/13	Swiss version
		421 030 34 43	-	-	349/9	Italian version
		421 030 35 43	-	-	349/10	Italian version
J 060/421	421.126 421.127	n.a.	-	-	-	Replaced by BM 421.128
		n.a.	-	-	-	Replaced by BM 421.125
J 055/421 T J 040/421 T	421.130 421.131	421 060 31 42	-	-	379/1	Power head
J 630/421 T	421.132 421.133	421 060 13 42	-	-	373/5	Power head
U 050/421	421.102 421.155	421 000 36 43	-	-	378/3	French version
U 060/421 (Argentina)	421.310	n.a.	-	-	-	
U 060/431 (Argentina)	431.210 431.211	n.a.	-	-	-	
		n.a.	-	-	-	

E = Single-line compressed air control for trailer brake system

Z = Dual-line compressed air control for trailer brake system

K = Combined single and dual line air control for trailer brake system

T = Power head

Installation survey compressed air systems (EC-version)

All chassis models have hydraulic dual-circuit brakes with compressed air assistance as standard

Model	Designation	Only valid in connection with	Special version
421.140/141	Compressed air control for dual-line-trailer brake system		35.617/01
421.140/141	Compressed air control for single trailer brake system		35.617/02
421.140/141	Compressed air control for single and dual-line-trailer brake system		35.617/03
421.140/141	Compressed air control for dual-line-trailer brake system with compressed air connection		35.617/04
421.140/141	Compressed air control for single and dual-line-trailer brake system with compressed air connection		35.617/05
421.140/141	Compressed air control for dual-line-trailer brake system	ALB	35.617/07
421.140/141	Compressed air control for single and dual-line-trailer brake system	ALB	35.617/01
421.140/141	ALB-regulator		35.621/03
421.140/141	ALB-regulator	35.617/01 or 35.617/02 or 35.617/03	35.621/04
421.140/141	ALB-regulator		35.931/01
421.140/141	ALB-regulator	35.617/07 or 35.617/08	35.931/02
421.124/125	Anti-freeze pump	35.335/09 35.336/05 35.346/05 35.379/04	35.625/03
421.140/141	Anti-freeze pump	35.617/02 or 35.617/07 or 35.617/08	35.625/04
421.126/129	Anti-freeze pump	30.031/01	35.625/07
421.126/129	EC-brake system	30.023	30.031/01

Equipment number codes

Mercedes-Benz part number	Supplier part number		Remarks
Single cylinder air compressor			
000 131 70 01	West. 411 004 101 0	without oil pump	98 cm ³
000 131 70 01	West. 415 701 100 0	with oil pump	
002 131 10 01	West. 411 040 500 0	without conn.	Power steering pump 108 ³
002 131 11 01	West. 411 040 540 0	with conn.	
Pressure regulator with air cleaner and tire inflating connection			
000 431 79 06	West. 475 304 201 0		
Pressure regulator with air cleaner without tire inflating connection			
001 431 29 06	West. 975 300 003 0		
Antifreeze			
000 431 26 15	West. 432 198 030 0	} SA 35 563 { SA 35 525	
Drain valve			
000 432 08 07	West. 934 300 001 0	} optional	
000 432 13 07	Techmatik 176.0-4 827		
000 432 15 07	Bosch 481 700 061		
Single-chamber- brake booster			
000 431 74 14	West. 462 007 042 0		
Control valve			
001 429 66 44	West. 470 013 000 0	hydropneumatic	

43.3 General

Mercedes-Benz part number	Supplier part number	Remarks
Trailer control valve with pressure limiter (air-controlled)		
000 431 49 05	West. 471 200 006 0	} Single-line
000 431 70 05	West. 471 200 112 0	
000 431 71 05	West. 471 200 113 0	
001 431 16 05	Bosch 461 061 005	} Dual-line
001 431 34 05	Knorr B 30 181	
001 431 37 05	West. 973 002 402 0	
Shut-off cock		
000 429 14 31	West. 462 002 107 0	
Coupling head		
000 429 01 30	West. 452 300 000 0	
000 429 27 30	West. 880 020 012 0	
000 429 28 30	West. 452 200 004 0	
000 429 37 30	Bosch 0 484 103 101	
000 429 38 30	Bosch 0 484 150 101	
000 429 39 30	Bosch 0 484 102 002	
000 429 40 30	Bosch 0 484 102 003	
000 429 45 30	West. 452 802 000 0	
000 429 48 30	Knorr 3 A 99 585	
000 429 68 30	West. 452 303 011 0	
000 429 74 30	West. 452 300 016 0	
000 429 76 30	West. 852 200 210 0	
000 429 79 30	West. 852 200 022 0	
000 429 80 30	West. 852 200 221 0	
000 429 81 30	West. 852 200 222 0	
Pressure control valve		
001 429 66 44	West. 473 011 000 0	

Mercedes-Benz part number	Supplier-part number	Remarks
Relay valve		
000 429 66 44	West. 973 001 010 0	
000 429 66 44	West. 473 011 000 0	
001 429 21 44	West. 473 017 000 0	
Handbrake valve		
000 431 02 16	West. 461 704 025 0	
000 430 39 81	West. 461 700 004 0	
000 430 76 81	West. 461 701 002 0	
Single-chamber-brake cylinder		
000 420 52 24	West. 421 002 000 0	
000 420 70 24	West. 421 021 000 0	
Brake pressure regulator		
000 431 42 12	West. 475 601 014 0	
000 431 72 12	Bosch 0 481 099 009	
000 431 94 12	West. 468 402 004 0	
Two-way valve		
000 420 40 44	West. 434 202 000 0	
001 429 24 44	West. 434 208 000 0	
Three way valve		
000 429 68 44	West. 371 020 000 0	
Overflow valve		
000 429 72 44	West. 434 100 203 0	with limited return flow
001 429 52 44	West. 434 100 124 0	without return flow
001 429 53 44	West. 434 100 122 0	

43.3 General

Mercedes-Benz part number	Supplier's part number	Remarks
Pressure reducing valve		
000 429 45 44	West 475 003 005 0	Swiss version
000 429 48 44	West 475 006 002 0	
001 429 17 44	West 475 010 003 0	
Non-return valve		
003 429 07 44	West 434 014 100 0	
Directional control valve		
000 434 05 01	West 463 013 010 0	
000 434 22 01	West 463 013 111 0	} 3/2 way valve
003 434 23 01	West 463 013 112 0	
001 429 04 44	West 571 002 000 0	
002 429 21 44	West 571 004 000 0	2/2 way valve
002 429 26 44	Bosch 0 481 007 016	3/2 way valve

Subdivision of Compressed Air Brake Systems

Compressed air brake system	Hydraulic Brake System	
	Single-Circuit Brake System	Dual-Circuit Brake System
Compressed air brake booster	X	X
Compressed air control for single-circuit trailer brake system	X	-
Compressed air control for dual-circuit trailer brake system	X	X
Compressed air control for single- and dual-circuit trailer brake system	X	X

Operation

Single-Circuit Compressed Air Brake System

This brake system requires only one air line to the trailer. The trailer brake system is energized when the trailer brake line is **bled**.

During extended downhill runs, the compressed air supply in the trailer may become exhausted because no more air is supplied to the trailer during braking.

Air gauge pressure: 5.2 bar.

Dual-Circuit Compressed Air Brake System

This brake system has two air lines to the trailer. The line from the reservoir of the tractor unit to the trailer reservoir is under pressure (supply line). The second line leads to the control unit in the trailer and is pressureless (brake line).

The trailer brake is energized by **charging** the brake line **with air**. The control unit of the trailer connects the reservoir to the brake cylinders. When the trailer connection is interrupted (interruption of energized supply line), the trailer is automatically braked.

The advantage of the dual-circuit compressed air brake system is that the compressed air supply in the trailer cannot be exhausted even during very long downhill runs.

Air gauge pressure: 7.3 bar.

Compressed Air Generation System

The fresh air drawn through the oil bath air cleaner of the engine is compressed in the air compressor and flows to the pressure regulator with air cleaner and tire inflation connection. There, the compressed air supplied is cleaned and the operational gauge pressure automatically monitored. When the specified max. operating overpressure is attained, the air compressor is switched to idling, and when compressed air is drawn from the pressure tank, to charging. The compressed air supplied flows from the pressure regulator into the compressed air tank, in front of which a defroster unit or defroster pump is installed optionally. The dual pressure gauge (white needle) indicates the gauge pressure in the tank.

Tractor Brake System

From the compressed air tank the compressed air flows to the brake booster.

Simultaneously compressed air flows to the air-controlled trailer control valve (connection V) and through this unit to the coupling head.

When braking, the pedal force acts on the one hand via the brake pedal on the hydraulic master brake cylinder and on the other hand on the compressed air brake booster. The function of the booster increases the mechanical force acting on the master brake cylinder by the compressed air employed. This compressed air (brake gauge pressure) is indicated by the double pressure gauge (red needle). The hydraulic brake gauge pressure flows from the master brake cylinder to the wheel brake cylinders of the front and rear axles.

Simultaneously, uncompressed air flows from the brake booster (connection A) to the air-controlled trailer control valve (connection Z). This bleeds the trailer control line (coupling head) and braking action in the trailer is initiated.

Troubleshooting

Compressed Air System (without EEC system)

Repairs to assemblies may only be performed by authorized workshops and brake service points.

Fault	Cause	Remedy
Pressure Regulator with Air Filter and Tire Inflating Port		
Cut-in pressure excessive or inadequate	Pressure regulator incorrectly adjusted	Adjust to cut-in pressure, refer to technical data "Pressure regulator"
Pressure regulator fails to switch air compressor over to idling	Passage choked, Control piston sticking, Grooved ring defective.	Clean passage, Check control piston and grooved ring, replacing if necessary
Pressure regulator fails to switch air compressor over to on-load operation	Vent choked, intake valve leaking, adjusting spring defective, sealing ring leaking, Cut-off piston sticking.	Clean vent, clean or replace valve. Check or replace spring. Replace sealing ring. Check cut-off piston and sealing ring
Compressed air escapes from drain socket in charging position.	Safety or no-load valve leaking.	Clean or replace valve and valve seat ring
Pressure regulator loses compressed air at vent in no-load or charging position	Intake valve leaking, Spring defective.	Clean or replace valve. Replace spring.
Pressure regulator does not admit compressed air to air tank.	Filter choked.	Clean or replace filter.
Compressed air escapes from dust cap on tire inflating port	Valve leaking.	Check or replace valve
Brief operating interval between pressure regulator cut-in and cut-out.	Heavy air consumption, Check valve leaking.	Check compressed air system for leaks. Clean or replace valve.
Defroster		
Compressed air escapes from actuating rod	Sealing ring leaking	Replace sealing ring. Check sealing surface on rod.
Compressed air escapes from mounting flange of reservoir.	O-ring leaking.	Replace O ring.
Steady consumption of antifreeze in closed position.	Sealing ring leaking.	Replace sealing ring
Defroster does not work satisfactorily in operating position.	No antifreeze left. More water than antifreeze in reservoir.	Drain water and top up with antifreeze

43.3 General

Fault	Cause	Remedy
Defrosting Pump		
Thrust tappet is too loose (no counter-pressure felt) or liquid level does not drop after repeated operation.	Piston seal leaking or strainer or supply hose choked	Fit new piston seal. Clean strainer or supply hose.
Air escaping at thrust tappet guide in replenishing tank.	Valve chamber dirty or valve head damaged.	Remove valve head. Clean valve chamber. Replace or recondition valve head.
Drainage Valve		
Drainage valve leaking.	Actuating valve or valve seat dirty or distorted.	Briefly operate actuating valve. Clean or replace valve or valve seat.
Brake Servo Unit		
Leaky	Rubber parts or valves defective	Replace rubber parts or valves.
Functional faults	Piston, piston liner or piston rod show signs of damage	Replace assembly.
Double Pressure Gauge		
Single-circuit air brake system: Gauge not accurate (can be checked by fully applying brakes) Tank and brake pressure pointers must agree.	Incorrectly connected Instrument defective	Connect correctly Replace instrument.
Brake Pressure Warning Light		
Warning light comes on when travelling.	Brake pressure inadequate or non-existent	Watch double pressure gauge, replenish tank pressure. Check brake system for leaks

Fault	Cause	Remedy
Trailer Control Valve, Single-Circuit		
With brakes released, compressed air escapes at vent (E) and connection (Z).	Exhaust valve leaking. Sealing ring leaking	Clean or replace valve and valve seat. Replace sealing ring
Compressed air escapes at vent (E) in closed position.	Intake valve leaking Diaphragm defective.	Clean or replace valve and valve seat. Replace diaphragm
Valve does not give satisfactory graduation.	Graduating piston sticking Sealing ring leaking Returner defective.	Check or replace piston and sealing ring. Replace snap ring
Unit does not give correct advance; refer to technical data of appropriate valve.	Graduating piston sticking Spring broken. Diaphragm defective.	Check piston and sealing ring. Replace spring. Replace diaphragm.
Pressure rises in part (E) in braking position.	Intake valve leaking.	Check or replace valve and valve seat
Isolating Cock		
Compressed air escapes at vent in through position	Seal leaking	Replace seal.
Compressed air permanently escapes at vent in isolating position.	Valve leaking	Clean or replace valve and valve seat.
Coupling Head		
Compressed air escapes in coupled position.	Sealing surfaces defective.	Replace sealing rings.
Pressure Control Valve		
Valve leaking	Seal worn	Replace seal
Relay Valve		
Compressed air escapes at vent (E) in released position	Intake valve leaking O-ring defective.	Check valve and valve seat. Replace O-ring.
Compressed air escapes at vent (E) in partial or full braking position	Exhaust valve leaking	Check valve and valve seat
Valve does not give fine graduation	Piston sticking. O-ring defective.	Check piston for ease of movement. Replace O-ring
Response stage too high.	O-ring and piston sticking.	Check piston for ease of movement. Replace O-ring.
Handbrake Valve		
Compressed air escapes from closed intake valve in released position	Intake valve leaking O-ring defective.	Check valve and valve seat. Replace O-ring.
When handbrake is applied, compressed air escapes at closed exhaust valve	Exhaust valve leaking.	Check valve and valve seat.

43.3 General

Fault	Cause	Remedy
Piston Brake Cylinder		
Leaking	Interior of cylinder shows heavy dirt deposits (because gaiter is destroyed).	Clean interior of brake cylinder and replace gaiter
	Seal worn and seal track scored.	Replace seal
Piston does not return to end position	Interior of cylinder dirty or rusty	Clean interior of brake cylinder.
Two-Way Valve/Three-Way Valve		
Valve leaking	Valve seat in body leaking	Check and clean valve seat, replace sealing ring, replace valve if necessary.
Overflow Valve		
Overflow valve too high or too low.	Incorrectly adjusted	Adjust to specified overflow pressure. refer to technical data "Overflow Valve"
Pressure Reducing Valve		
Pressure reduction incorrect.	Adjusting spring not preloaded correctly	Correct preloading
Compressed air escapes at joint between ports 1 and 2.	Intake valve leaking	Clean or replace valve and valve seat.
Check Valve		
Check valve fails to hold compressed air entering in direction of arrow	Valve leaking.	Clean or replace valve
Air Admission Valve (Actuating Valve)		
Compressed air escapes at vent (E) in released position.	Valve leaking	Clean or replace valve.
Compressed air escapes steadily at vent (E) in actuating position.	Valve or seal defective.	Clean or replace valve, replace sealing ring
Actuating tappet does not return fully to released position	Spring defective. Tappet sticking.	Replace spring check tappet, repairing or replacing if necessary

Note: A soap solution leaving no residue should be used for testing air lines and air assemblies.

Compressed Air System (EEC System)

Repairs to assemblies must only be executed by authorized workshops and brake service points

Fault	Cause	Remedy
Air Compressor/Auxiliary Air Compressor		
Compressed air delivery inadequate or non-existent.	Suction or delivery valves leaking. Excessive play between piston and cylinder. Line or filter in pressure regulator coked up. Cylinder head gasket defective.	Overhaul or replace air compressor. Clean line or filter in pressure regulator, replace if necessary. Replace cylinder head gasket.
Air compressor overheating	Brake system leaking heavily	Rectify leakage in brake system
	Line or filter from pressure regulator coked up	Clean line or filter from pressure regulator, replacing if necessary
	Too many additional air loads.	Install auxiliary air compressor
Air compressor using too much oil	Vacuum in intake line	Clean air filter, replacing filter element if necessary
	Cylinder and piston rings heavily worn.	Overhaul or replace air compressor.
Pressure Regulator		
Compressed air escapes at outlet socket in charging position.	No-load valve leaking.	Clean or replace valve and valve seat.
Pressure regulator fails to switch air compressor over to no-load	Diaphragm piston sticking	Check or replace diaphragm piston.
Pressure regulator fails to switch air compressor over to on-load.	Adjusting spring defective, cut-off piston sticking.	Replace spring, check cut-off piston and sealing ring.
Pressure regulator loses compressed air at vent in charging position.	Intake valve leaking, spring defective	Clean or replace valve, replace spring.
Pressure regulator loses compressed air at vent in no-load position	Exhaust valve leaking, spring defective.	Clean or replace valve, replace spring.
Pressure regulator does not admit compressed air to air tank.	Filter choked.	Clean or replace filter.
Brief switching interval between pressure regulator cut-in and cut-out	Heavy air consumption, check valve leaking, sealing ring or exhaust valve leaking.	Check brake system for leaks. Check valves and seals. Replace wear parts.
Defroster		
Compressed air escapes at actuating rod.	Sealing ring leaking	Replace sealing ring at actuating rod
Steady consumption of alcohol in closed position	Sealing ring leaking	Replace sealing ring
Defroster does not work satisfactorily in operating position.	No antifreeze left. More water than antifreeze in supply tank.	Drain water and top up with antifreeze.

43.3 General

Fault	Cause	Remedy
Dual-Circuit Protection Valve		
Opening pressure for one brake circuit is not reached.	Incorrectly adjusted.	Adjust to specified opening pressure.
Limited return flow is not ensured.	Valve body sticking.	Overhaul or replace valve.
Compressed air escapes at breather port in operating position.	Spring broken	Replace spring
	Diaphragm leaking.	Replace diaphragm or valve.
Tank Pressure		
Is not reached or not reached quickly enough	Air compressor not delivering sufficient compressed air.	Check air compressor, overhauling or replacing if necessary
		Clean pressure regulator; replacing if necessary.
Drainage Valve.		
Valve leaking.	Pressure regulator steadily discharging air.	Briefly operate actuating valve Replace if valve still leaks.
Overflow Valve W/O Return		
Overflow valve cannot be exactly adjusted.	Actuating valve seat dirty or defective	Clean diaphragm or replace with spring.
Valve does not hold back compressed air	Diaphragm leaking, spring defective.	Clean or replace check valve
Double Pressure Gauge		
The two pointers do not agree at full braking position; out of tolerance ± 0.2 bar	Check valve leaking	Replace double pressure gauge
Air escapes at double pressure gauge.	Wear in transmission mechanism	Replace double pressure gauge.
Incorrect indication	Solder leaking	The two pointers must agree when brakes are fully applied at standstill. Replace gauge if necessary.
	Assembly defective.	

Fault	Cause	Remedy
Warning Light		
Comes on while travelling. Important: Stop immediately.	Tank pressure inadequate or non-existent.	Watch double brake pressure gauge until tank pressure is restored. Check compressed air system for leaks, sealing if necessary.
	Leakage in hydraulic brake circuit	Rectify leaks, bleeding brake system if necessary. Check fluid level, correcting if necessary.
	Brake pad/lining wear	Replace brake pads/linings. Check fluid level, correcting if necessary.
Warning light does not come on when pressure drops below warning level	Bulb defective. Fault in electrical system	Replace bulb. Rectify electrical fault.
Air Brake Servo Unit		
Compressed air escapes at vent in released position.	Intake valve leaking.	Replace intake valve.
Compressed air escapes at vent in partial and full braking positions.	Exhaust valve, sealing rings and seals leaking.	Replace exhaust valve, sealing rings and seals, exchanging servo unit if necessary.
Wheel brakes are slow to release after braking.	No pedal play.	Adjust pedal play.
	Inner stiffness between piston and cylinder bore. Compression spring weak.	Check brake servo unit, replacing if necessary.
	Control piston sticking in 3/2-way valve (changeover valve for trailer working).	Check 3/2-way valve, replacing if necessary.
Brake graduation not fine enough	Pedal system stiff.	Check brake servo unit, replacing if necessary.
	Inner stiffness between piston and cylinder bore.	Check brake servo unit, replacing if necessary.
Handbrake Valve		
Compressed air escapes at vent in released position.	Exhaust valve or sealing ring leaking.	Replace exhaust valve and sealing ring.
Compressed air escapes at vent in partial and full braking positions.	Intake valve leaking.	Clean or replace intake valve.
Valve does not give satisfactory graduation.	Vent dirty.	Clean vent.

Fault	Cause	Remedy
Trailer Control Valve, Single-Circuit		
Compressed air escapes at vent and control port with brakes released.	Exhaust valve leaking, seating rings leaking	Clean or replace valve and valve seat. Replace seating ring.
Compressed air escapes at vent in closed position.	Exhaust valve leaking, diaphragm defective.	Clean or replace valve and valve seat. Replace diaphragm.
Valve does not provide satisfactory graduation.	Graduating piston sticking. Sealing ring leaking. Snap ring defective.	Check piston and sealing ring replacing if necessary. Replace snap ring.
Assembly does not provide correct advance.	Graduating piston sticking. Spring broken. Diaphragm defective.	Check piston and sealing ring. Replace spring. Replace diaphragm.
Pressure in trailer control line rises above 5.4 bar in released position.	Pressure reducing piston or spring defective. Intake valve may be leaking.	Check or replace piston and sealing ring. Replace spring. Check or replace valve and valve seat.
Pressure rises in trailer control line in braking position.	Intake valve leaking.	Check or replace valve and valve seat.
Hydropneumatic Control Valve		
Compressed air escapes at vent with brakes released.	Intake valve leaking.	Clean or replace intake valve.
	Control valve of dual-line system leaking between pressure chamber port 43 and control chamber port 42, allowing air to pass through connecting line to hydropneumatic control valve and escape at vent.	Replace dual-line control valve.
Compressed air escapes at vent in closed position.	Exhaust valve or seating ring leaking.	Clean exhaust valve, replacing if necessary. Replace seating ring.
Valve does not provide satisfactory graduation.	Control piston stiff.	Release control piston, replacing valve if necessary.
	Air in hydraulic control chamber.	Vent valve.
Residual pressure left in brake line (2-line) to trailer when brakes released.	Control piston stiff or sticking, leaving residual pressure in connecting line to control chamber port 42 of control valve (2-line) and preventing brake line from being fully exhausted.	Replace hydropneumatic control valve.

Fault	Cause	Remedy
Trailer Control Valve, Dual-Line		
With service and parking brakes released, compressed air escapes at vent	Intake valve or sealing rings leaking	Clean or exchange intake valve Exchange sealing rings
With service and parking brakes released, compressed air escapes at vent of hydropneumatic control valve.	Diaphragm piston leaking.	Exchange control valve.
Operating stage of valve is excessive or graduation is not satisfactory. Residual pressure left in trailer brake line	Inner stiffness at valve (piston sticking).	Check control valve, exchanging if necessary
At partial and full braking positions, compressed air escapes at vent	Exhaust valve or sealing ring leaking.	Clean or exchange exhaust valve Exchange sealing rings
Trailer Control Valve, Dual-Line		
With service and parking brakes released, residual pressure left in trailer control line	Air brake servo unit is not exhausting fully.	Check and adjust pedal play. Check air brake servo unit, exchanging if necessary
	Hydropneumatic control valve is not exhausting fully.	Check hydropneumatic control valve, exchanging if necessary.
	Handbrake valve is not providing full admission.	Check and adjust handbrake valve setting. Check handbrake valve, exchanging if necessary.
With parking brake applied, compressed air escapes at vent,	Exhaust valve or sealing ring leaking	Clean or exchange exhaust valve. Exchange sealing rings.
	Control valve of single-line brake system is leaking toward control port.	Check single-line trailer control valve, exchanging if necessary.
Two-Way Valve		
Compressed air escapes at uncontrolled delivery port line	Piston slide leaking.	Exchange piston slide

43.2 General

Fault	Cause	Remedy
Coupling head, single line		
Compressed air escapes at coupled position	Sealing surfaces defective	Exchange sealing rings
At uncoupled position, compressed air escapes at coupling head.	Valve leaking	Check valves and valve seats, exchanging if necessary
Not enough compressed air is reaching trailer.	Pin of opposite coupling head is not pressing fully on valve. Strainer is choked	Exchanging coupling head with pin. Clean strainer.
At coupling head (special version) compressed air escapes from valve hole at disconnected position.	Valve body leaking	Clean valve or exchange coupling head
Coupling heads, dual-line		
After coupling up, compressed air escapes at sealing surfaces during full brake application.	Sealing surfaces defective.	Exchange sealing rings
Coupling heads lock unsatisfactorily.	Retainer worn out.	Exchange retainers on both coupling heads
After disconnecting, compressed air escapes at supply head.	Valve leaking Strainer choked	Clean or exchange valve. Clean strainer.
2/2-way valve (break-away valve)		
Compressed air escapes at breather hole.	Valve leaking	Exchange valve.
When brakes are fully applied pressure in supply line does not drop to 1.5 bar within 2 seconds	Restrictor unloose, in valve too large, or piston stiff.	Check valve, exchanging if necessary.
3/2-way valve (changeover valve)		
With tractor unit working alone, compressed air escapes at breather hole throughout full brake application	Valve leaking	Exchange valve.
With tractor unit working alone, brakes release too slowly or residual pressure left in air brake servo unit.	3/2-way valve is stiff or piston sticking. The M-chamber of air brake servo unit is therefore exhausting too slowly or incompletely	Check valve, exchanging if necessary.

Fault	Cause	Remedy
3/2-Way Valve (actuating valve)		
At released position, compressed air escapes at vent	Valve leaking	Clean or exchange valve
At actuating position, compressed air steadily escapes at vent	Valves or sealing rings defective	Clean valves, exchanging if necessary.
Actuating tappet does not fully return to released position	Spring defective, tappet sticking	Check valves, exchanging if necessary.
3/2-Way Valve (testing valve)		
With handbrake released, compressed air escapes at rotary knob.	Sealing ring on tappet at top is leaking	Exchange sealing ring or valve
Handbrake exhausts. Testing valve admits. At the same time, compressed air steadily escapes at handbrake valve vent	Seal on tappet in centre is leaking	Exchange seal or valve.
Handbrake exhausts. At same time, compressed air steadily escapes at handbrake valve vent.	Sealing ring on tappet at bottom is leaking	Exchange sealing ring or valve

Technical Data**Minimum Bending Dia. for Plastic Pipes**

Pipe dimension OD x wall thickness	Minimum permissible bending radius in mm
4 x 1	20
6 x 1	30
6 x 0.5	40
8 x 1	40
8 x 2	40
11 x 1.5	55
12 x 1.5	60
13 x 1.5	65

Safe Working Pressure

The safe pressures (see Table) must not be exceeded

Pipe dimension OD x wall thickness	Safe working pressure in bar at + 23° C
4 x 1	50
6 x 1	30
6 x 0.5	13
8 x 1	21
8 x 2	50
11 x 1.5	24
12 x 1.5	21
13 x 1.5	16

The safe maximum working pressure given through pipe catalogue refers to the burst pressure

Special Tools

Cons. No.	Designation*	Tool No.	Tool set
1	Pipe clamp	752 589 00 37 01	B

Instructions for Laying and Fabricating Metal Piping:

Piping when laid must not be subject to stresses of chafing and must be fixed at the same anchoring points as the line removed.

A pipe bender should be used for bending purposes. Refer to line removed for shape. On no account must pipeline be heated for bending because surface protection will be destroyed and oxidation will cause brake unit trouble.

Each pipe end must be cut off at right angles and deburred. Slide cap nut, cutting and thrust rings onto pipe end and couple to union while pressing pipe into position. Pipe must not be allowed to turn. Then release cap nut again to check whether cutting edge of cutting ring has penetrated pipe surface and whether visible bead has been produced by the cutting edge. Prior to final installation, the piping must be cleaned with compressed air.

Instructions for Installing Plastic Piping:

1 Material.

Plastic piping is made of polyamide 11-12 w.l.T. Polyamide is flexible and resists all fluids, oils and greases used in motor vehicles. In addition, plastic piping is also resistant to bases, unchlorinated solvents, organic and inorganic acids and diluted oxidants. The melting point of plastic piping is +166° C, temperature between -40° and +100° C being perfectly safe.

When performing drilling and welding operations, protect or remove plastic piping.

2 Coupling and Fitting:

Plastic pipe (1) should be cut off at right angles for each new joint. Then slip sleeve insert (2) fully home into pipe end and position cap nut (3) and cutting ring (4) on plastic pipe. Now hand-tighten cap nut until appreciable resistance is felt at union (5). Tighten 1 1/2 to 1 3/4 more turns using wrench. Release cap nut and check whether cutting ring is seated firmly in plastic pipe and also whether a slight bulge has appeared in front of cutting ring. Then tighten cap nut in the normal manner.

To fit a pipe union, hold plastic piping in special tool No. 1.

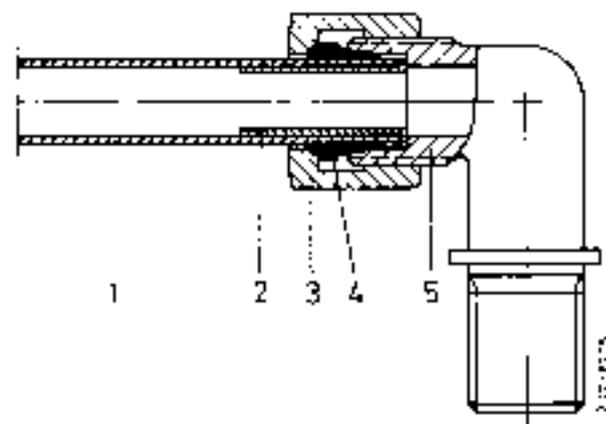

Damage to plastic piping does not necessitate replacing the entire line. The damaged section can be cut out and repaired with the aid of a double union.

1. Underneath
2. Nut
3. Seal insert
4. Covering ring

3 Laying

Plastic piping when laid must not be subject to chafing and must be fastened by cable clips at intervals of 50 cm. When tightened, cable clips must still allow plastic piping to move.

Plastic piping must not be bent below a minimum radius (refer to 1.17.1) because it may otherwise buckle.



1.17.1

Description of Compressed Air System

Brake System: Hydraulic single-circuit brake system with compressed air assistance

Installed in Model: 421.122/123

Acc. to Drawing No.: 421 000 06 42

Special Version: 035.379/2 Code 710
035.324/1/2 Code 780/781 Air compressor with/without oil pump

Pressure Layout: Control pressure = 7.3 ± 0.2 bar
Control range - 0.6 ± 0.4 bar

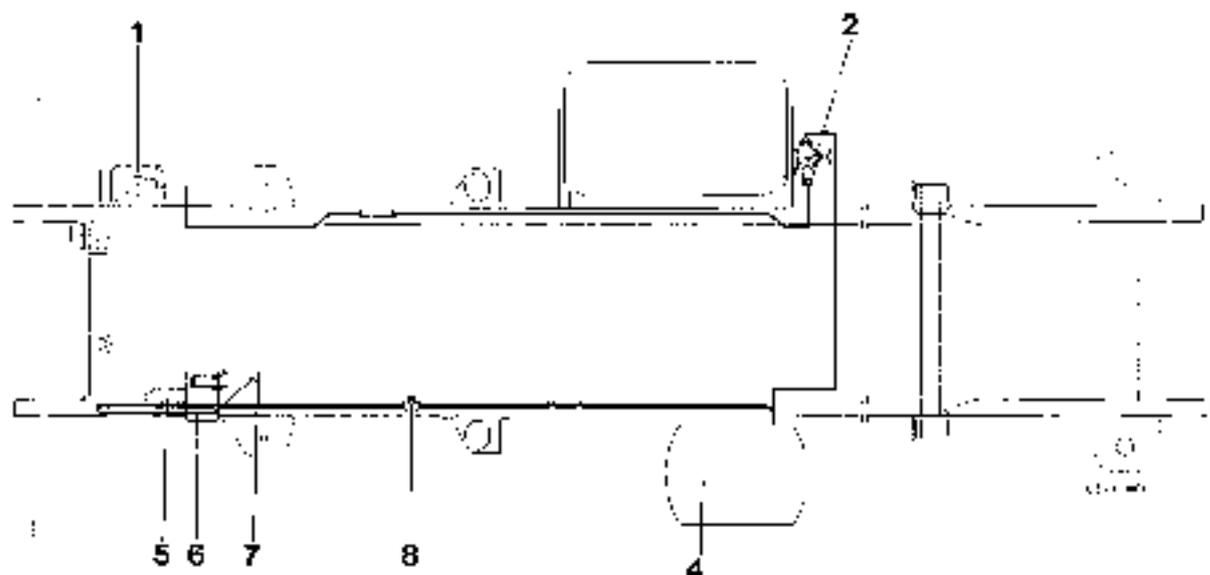
Installation Diagram:

43.3 General Information

Explanations re 1.9/1

Item	Designation of Unit	Part No	
		Mercedes-Benz	Wearinghouse
1	Air compressor	000 131 78 01	411 004 101 0
1a	Suppl. air compressor	-	-
2	Pressure regulator with filter and tire inflation connection	000 431 79 06	475 304 201 0
2a	Pressure regulator	-	-
2b	Air cleaner with tire inflation connection	-	-
2c	Tire inflation cylinder	-	-
3	Antifreeze device or antifreeze pump	-	-
4	Compressed air tank (30 l)	421 432 09 15	-
4a	Suppl. compressed air tank	-	-
5	Master brake cylinder optional	001 430 35 01 002 430 53 01	-
6	Compressed air brake booster	000 431 74 14	462 007 042 0
7	Brake double pressure gauge	no data	-
8	Connection for actuating differential lock	BM 22 x 1.5	DIN 71 302
9	Trailer control valve	-	-
10	Changeover valve (green lever) / shut-off valve	-	-
11	Coupling head (black) for brake hose	-	-
12	Pressure control valve	-	-
13	Relay valve	-	-
14	Coupling head (red) for supply hose	-	-
15	Coupling head (yellow) for brake hose	-	-
16	Handbrake valve	-	-
17	Brake cylinder	-	-
18	Brake force regulator	-	-
19	Two-way valve	-	-
20	Three-way valve	-	-
21	Overflow valve	-	-
22	Pressure reduction valve	-	-
23	Check valve	-	-

Description of Compressed Air System

Brake System:	Hydraulic single-circuit brake system with compressed air assistance
Installed in Model:	421 124/125
Acc. to Drawing No.:	421 000 08 42
Special Version:	035.379/04 Code 710/B 15 035.324/07 Code 780/M 30 with connection for power steering pump

Pressure Layout: Output pressure = 7.5 ± 0.2 bar
Control range = 0.8 ± 0.4 bar

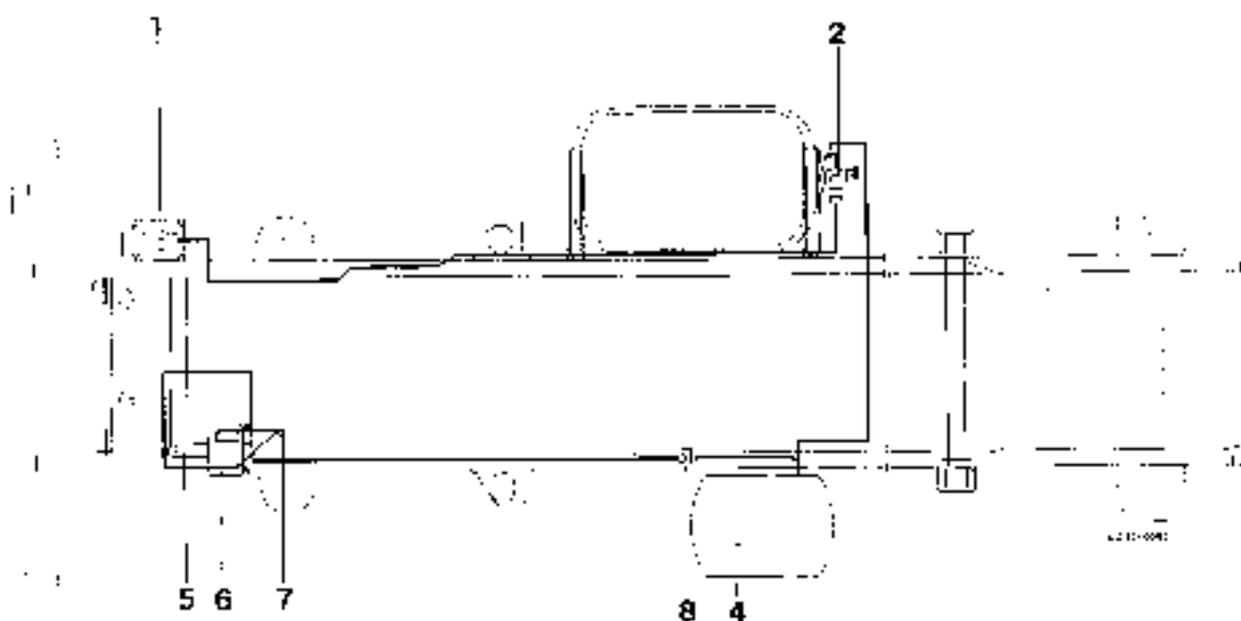
Installation Diagram:

43.3 General Information

Explanations re 1.9/3

Item	Designation of Unit	Part No.	
		Mercedes-Benz	Westinghouse
1	Air compressor	002 131 11 01	411 040 840 C
1a	Suppl. air compressor	-	-
2	Pressure regulator with filter and tire inflation connection	000 431 79 06	475 304 201 0
2a	Pressure regulator	-	-
2b	Air cleaner with tire inflation connection	-	-
2c	Tire inflation cylinder	-	-
3	Antifreeze device or antifreeze pump	-	-
4	Compressed air tank (30 l)	421 432 08 15	-
4a	Suppl. compressed air tank	-	-
5	Master brake cylinder optional	001 430 85 01 002 430 53 01	- -
6	Compressed air brake booster	000 431 74 14	462 007 042 0
7	Brake double pressure gauge	no data	-
8	Connection for actuating differential lock	BM 22 x 1.5	DIN 74 302
9	Trailer control valve	-	-
10	Changeover valve (green lever) / shutoff valve	-	-
11	Coupling head (black) for brake hose	-	-
12	Pressure control valve	-	-
13	Relay valve	-	-
14	Coupling head (red) for supply hose	-	-
15	Coupling head (yellow) for brake hose	-	-
16	Handbrake valve	-	-
17	Brake cylinder	-	-
18	Brake force regulator	-	-
19	Two-way valve	-	-
20	Three-way valve	-	-
21	Overflow valve	-	-
22	Pressure reduction valve	-	-
23	Check valve	-	-

Description of Compressed Air System

Brake System: Hydraulic single circuit brake system with compressed air assistance and compressed air control for single line trailer brake system.

Installed in Model: 421 122/123

Acc. to Drawing No.: 421 000 21 43

Special Version: 035 335/03 Code 720
035 324/01 Code 780 air compressor without oil pump

Pressure Layout: Output pressure = 6.3 ± 0.3 bar
Control range 0.5 bar

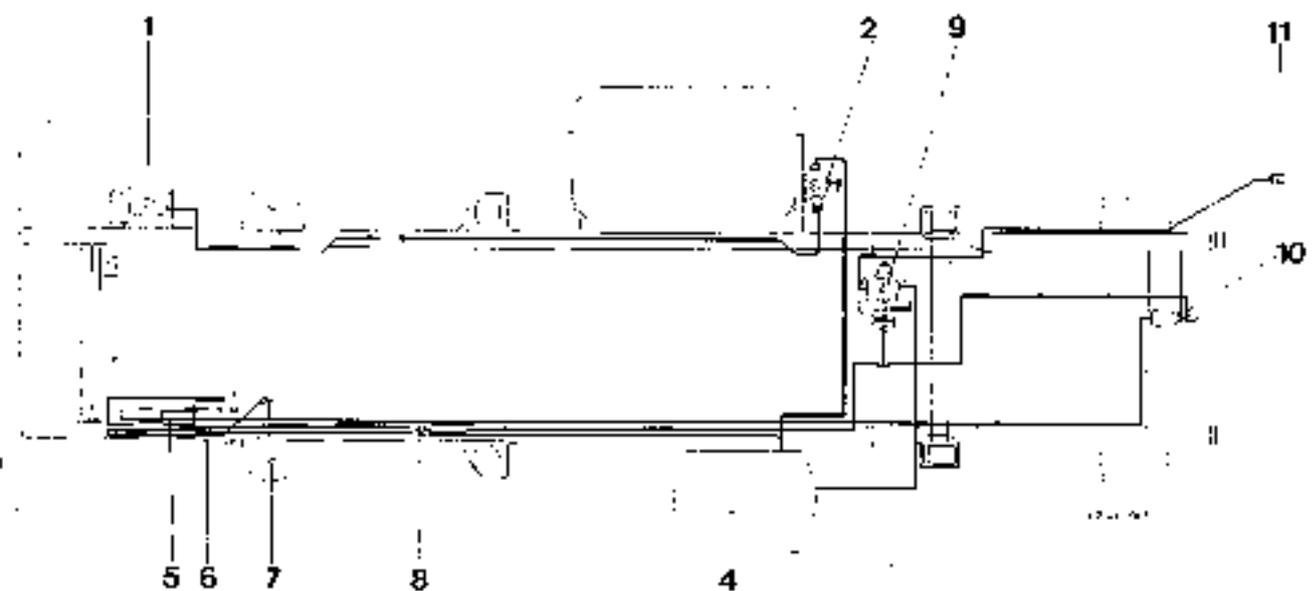
Installation Diagram:

43.3 General Information

Explanations re 1.9/5

Item	Designation of Unit	Part No.	
		Mercedes-Benz	Westinghouse
1	Air compressor	000 131 78 01	411 004 101 0
1a	Suppl. air compressor	-	-
2	Pressure regulator with filter and tire inflation connection	000 431 79 06	475 304 201 0
2a	Pressure regulator	-	-
2b	Air cleaner with tire inflation connection	-	-
2c	Tire inflation cylinder	-	-
3	Antifreeze device or antifreeze pump	-	-
4	Compressed air tank (30 l)	421 432 08 15	-
4a	Suppl. compressed air tank	-	-
5	Master brake cylinder optional	001 430 05 01 002 430 53 01	- -
6	Compressed air brake booster	000 431 74 14	462 007 042 0
7	Brake double pressure gauge	no data	-
8	Connection for actuating differential lock	BM 22 x 1.5	DIN 74 302
9	Trailer control valve	000 431 71 05	471 200 113 0
10	Changeover valve (green lever) / shut-off valve	000 429 14 31	452 002 107 0
11	Coupling head (black) for brake hose	000 429 48 30	-
12	Pressure control valve	-	-
13	Relay valve	-	-
14	Coupling head (red) for supply hose	-	-
15	Coupling head (yellow) for brake hose	-	-
16	Handbrake valve	-	-
17	Brake cylinder	-	-
18	Brake force regulator	-	-
19	Two-way valve	-	-
20	Three-way valve	-	-
21	Overflow valve	-	-
22	Pressure reduction valve	-	-
23	Check valve	-	-

Description of Compressed Air System

Brake System: Hydraulic single-circuit brake system with compressed air assistance and compressed air control for single-line trailer brake system

Installed in Model: 42¹.122/123

Acc. to Drawing No.: 42¹ 000 22 49

Special Version: 035.335/03 Code 720
035.324/01 Code 780 air compressor without oil pump

Pressure Layout: Cutout pressure = 5.3 ± 0.3 bar
Control range = 0.5 bar

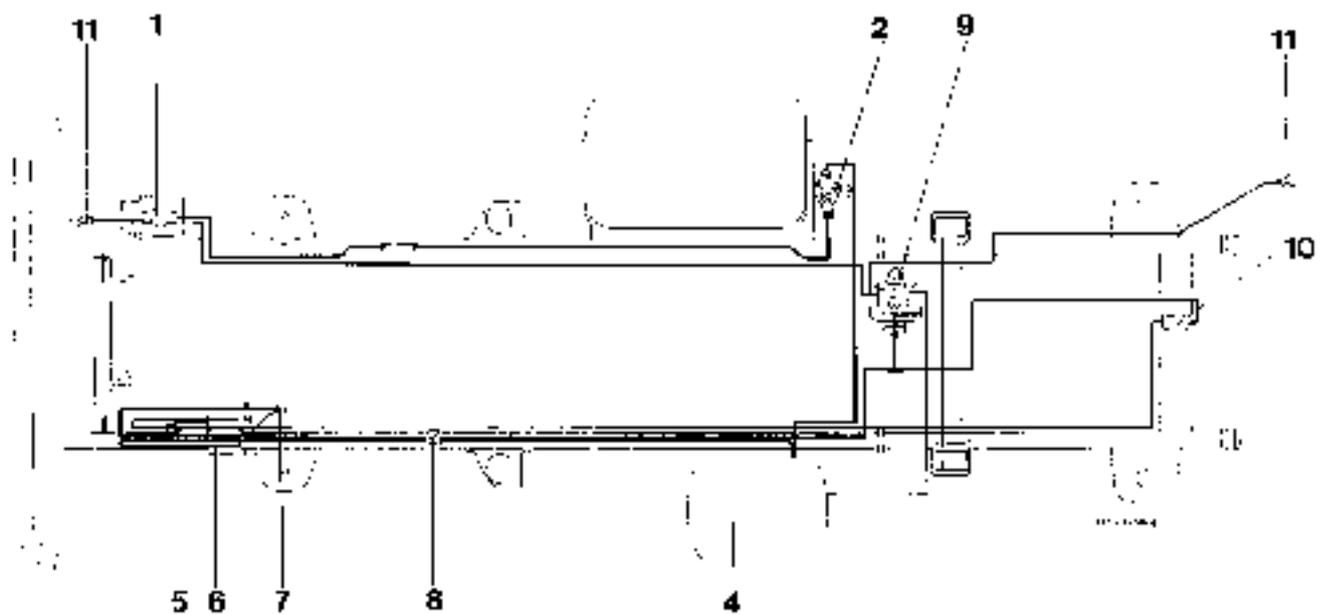
Installation Diagram:

43.3 General Information

Explanations re 1.9/7

Item	Designation of Unit	Part No	
		Mercedes-Benz	Westinghouse
1	Air compressor	000 131 78 01	411 004 101 0
1a	Suppl. air compressor	-	-
2	Pressure regulator with filter and tire inflation connection	000 431 79 06	475 304 201 0
2a	Pressure regulator	-	-
2b	Air cleaner with tire inflation connection	-	-
2c	Tire inflation cylinder	-	-
3	Antifreeze device or antifreeze pump	-	-
4	Compressed air tank (30 lt)	421 432 08 15	-
4a	Suppl. compressed air tank	-	-
5	Master brake cylinder optional	001 430 85 01 002 430 53 01	- -
6	Compressed air brake booster	000 431 74 14	462 007 042 0
7	Brake double pressure gauge	no data	-
8	Connection for actuating differential lock	BM 22 x 1.5	DIN 74 302
9	Trailer control valve	000 431 71 05	471 200 113 0
10	Changeover valve (green lever) / shut-off valve	000 429 14 31	452 002 107 0
11	Coupling head (black) for brake hose	000 429 48 30	-
12	Pressure control valve	-	-
13	Relay valve	-	-
14	Coupling head (red) for supply hose	-	-
15	Coupling head (yellow) for brake hose	-	-
16	Handbrake valve	-	-
17	Brake cylinder	-	-
19	Brake force regulator	-	-
19	Two-way valve	-	-
20	Three-way valve	-	-
21	Overflow valve	-	-
22	Pressure reduction valve	-	-
23	Check valve	-	-

Description of Compressed Air System

Brake System: Hydraulic single-circuit brake system with compressed air assistance and compressed air control for single-line trailer brake system

Installed in Model: 421 124/125

Acc. to Drawing No.: 421 000 30 43 without front compressed air port
421 000 39 43 with front compressed air port

Special Version: 035.335/79 Code 720/B 40
035.335/11 Code 723
035.324/06/07 Code 780/M 30 without/with port for power steering pump

Pressure Layout: Cutout pressure - 5.3 + 0.3 bar
Control range - 0.5 bar

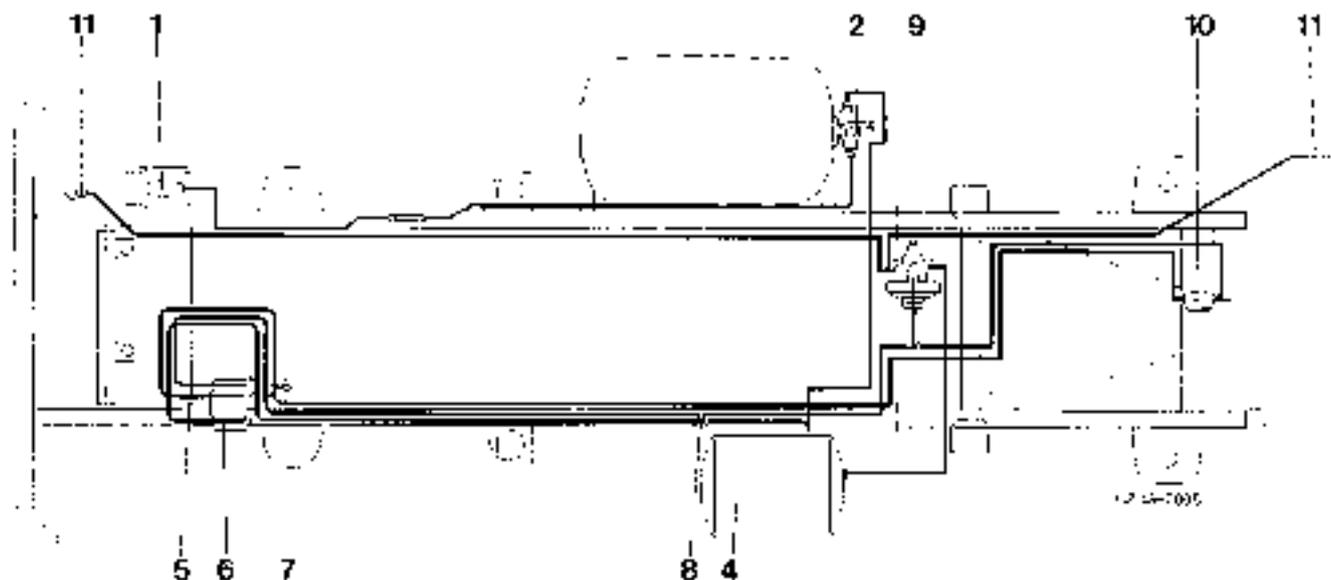
Installation Diagram:

43.3 General Information

Explanations on 1.9/9

Item	Designation of Unit	Part No.	
		Mercedes-Benz	Westinghouse
1	Air compressor optional	002 131 10 01 002 131 11 01	411 040 800 0 411 040 840 0
1a	Suppl. air compressor	-	-
2	Pressure regulator with filter and tire inflation connection	000 431 73 0R	475 304 201 U
2a	Pressure regulator	-	-
2b	Air cleaner with tire inflation connection	-	-
2c	Tire inflation cylinder	-	-
3	Antifreeze device or antifreeze pump	-	-
4	Compressed air tank (30 l)	421 432 08 1b	-
4a	Suppl. compressed air tank	-	-
5	Master brake cylinder optional	001 430 85 01 002 430 53 01	- -
6	Compressed air brake booster	000 431 74 14	4R2 007 042 0
7	Brake double pressure gauge	no data	-
8	Connection for actuating differential lock	BM 22 x 1,5	DIN 74 302
9	Trailer control valve	000 431 71 05	471 203 113 0
10	Changeover valve (green lever) / shutoff valve	000 429 14 31	452 002 107 0
11	Coupling head (black) for brake hose	000 429 48 30	-
12	Pressure control valve	-	-
13	Relay valve	-	-
14	Coupling head (red) for supply hose	-	-
15	Coupling head (yellow) for brake hose	-	-
16	Handbrake valve	-	-
17	Brake cylinder	-	-
18	Brake force regulator	-	-
19	Two-way valve	-	-
20	Three-way valve	-	-
21	Overflow valve	-	-
22	Pressure reduction valve	-	-
23	Check valve	-	-

Description of Compressed Air System

Brake System: Hydraulic single-circuit brake system with nonpressured air assistance and compressed control for dual-line trailer brake system.

Installed in Model: 421 122/123

Acc. to Drawing No.: 421 000 25 43

Special Version: 035 336/03 Code 730
035 324/01 Code 790 air compressor without oil pump

Pressure Layout: Cutout pressure = 7.3 ± 0.2 bar
Control range = 0.6 ± 0.4 bar

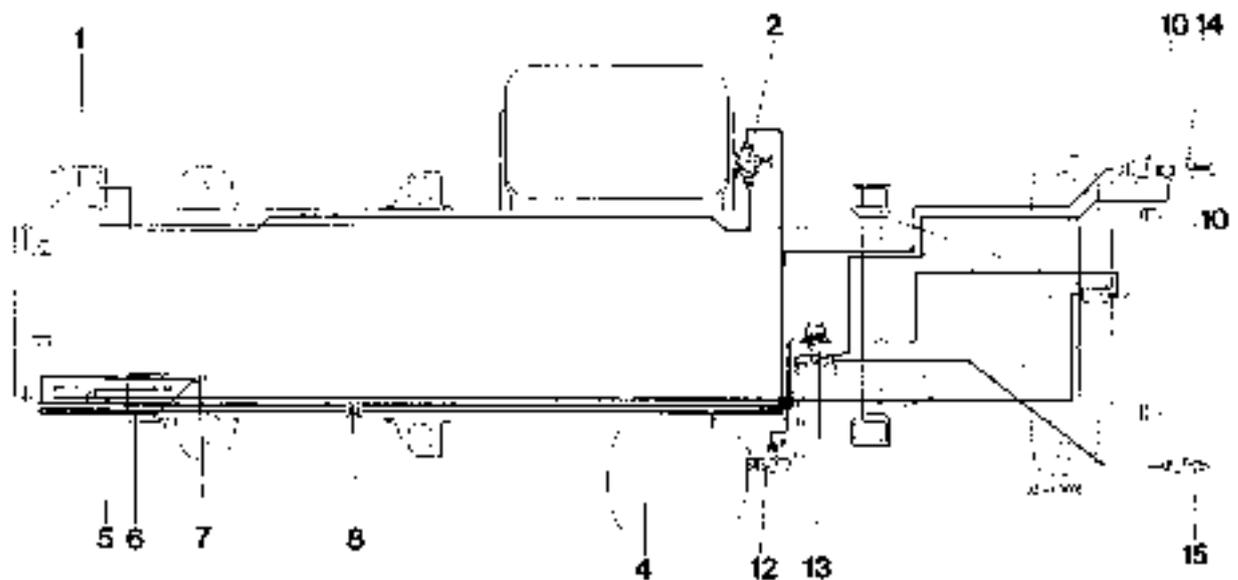
Installation Diagram:

43.3 General Information

Explanation: refer 1.9/11

Item	Designation of Unit	Part No.	
		Mercedes-Benz	Westinghouse
1	Air compressor	000 131 78 01	411 004 101 0
1a	Suppl. air compressor	-	-
2	Pressure regulator with filter and tire inflation connection	000 431 78 08	475 304 201 0
2a	Pressure regulator	-	-
2b	Air cleaner with tire inflation connection	-	-
2c	Tire inflation cylinder	-	-
3	Antifreeze device or antifreeze pump	-	-
4	Compressed air tank (30 l)	421 432 08 15	-
4a	Suppl. compressed air tank	-	-
5	Master brake cylinder optional	001 430 95 01 002 430 53 01	-
6	Compressed air brake booster	000 431 74 14	462 007 042 0
7	Brake double pressure gauge	no data	-
8	Connection for actuating differential lock	BM 22 x 1.5	DIN 74 302
9	Trailer control valve	-	-
10	Changeover valve (green lever) / shutoff valve	000 429 14 31	452 002 107 0
11	Coupling head (black) for brake hose	-	-
12	Pressure control valve	001 429 66 44	434 403 003 0
13	Relay valve	000 429 86 44	473 011 003 0
14	Coupling head (red) for supply hose	000 429 28 33	452 200 004 0
15	Coupling head (yellow) for brake hose	000 429 28 33	452 200 004 0
16	Handbrake valve	-	-
17	Brake cylinder	-	-
18	Brake force regulator	-	-
19	Two-way valve	-	-
20	Three-way valve	-	-
21	Overflow valve	-	-
22	Pressure reduction valve	-	-
23	Check valve	-	-

Description of Compressed Air System

Brake System: Hydraulic single-circuit brake system with compressed air assistance and compressed control for dual-line trailer brake system.

Installed in Model: 421 122/123

Acc. to Drawing No.: 421 000 26 43

Special Version: 035.336/04 Code 730
035.324/01/02 Code 780/781 air compressor without/with oil pump

Pressure Layout: Cutout pressure = 7.3 ± 0.2 bar
 Control range - 0.6 ± 0.4 bar

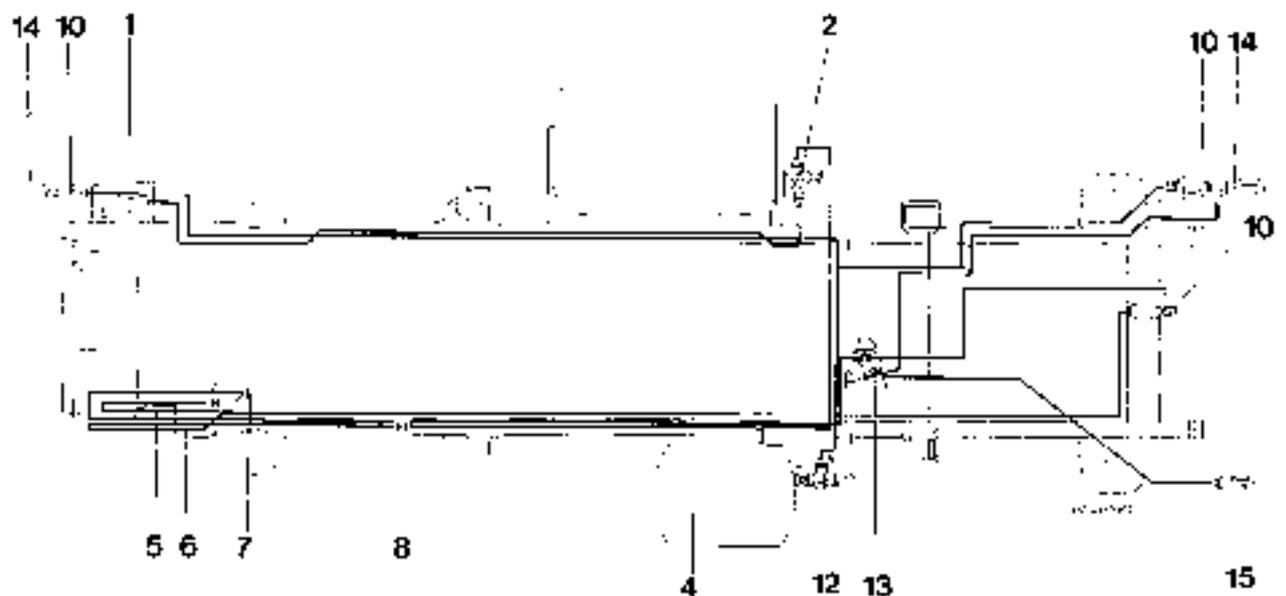
Installation Diagram:

43.3 General Information

Explanations re 1.0/13

Item	Designation of Unit	Part No.	
		Mercedes-Benz	Westinghouse
1	Air compressor	000 131 70 01	415 701 100 0
1a	Suppl. air compressor	-	-
2	Pressure regulator with filter and tire inflation connection	000 431 79 06	475 304 201 0
2a	Pressure regulator	-	-
2b	Air cleaner with tire inflation connection	-	-
2c	Tire inflation cylinder	-	-
3	Antifreeze device or antifreeze pump	-	-
4	Compressed air tank (50 l)	421 432 06 15	-
4a	Suppl. compressed air tank	-	-
5	Master brake cylinder optional	001 430 85 01 002 430 63 01	- -
6	Compressed air brake booster	000 431 74 14	462 007 042 0
7	Brake double pressure gauge	no data	-
8	Connection for actuating differential lock	BM 22 x 1.5	DIN 74 302
9	Trailer control valve	-	-
10	Changeover valve (green level) / shutoff valve	000 429 14 31	452 002 107 0
11	Coupling head (black) for brake hose	-	-
12	Pressure control valve	001 420 66 44	434 403 000 0
13	Relay valve	000 429 66 44	473 011 000 0
14	Coupling head (red) for supply hose	000 429 28 30	452 200 004 0
15	Coupling head (yellow) for brake hose	000 429 28 30	452 200 004 0
16	Handbrake valve	-	-
17	Brake cylinder	-	-
18	Brake force regulator	-	-
19	Two-way valve	-	-
20	Three-way valve	-	-
21	Overflow valve	-	-
22	Pressure reduction valve	-	-
23	Check valve	-	-

Description of Compressed Air System

Brake System: Hydraulic single-circuit brake system with compressed air assistance and compressed air control for dual-line trailer brake system

Installed in Model: 421 124/125

Acc. to Drawing No.: 421 000 32 43

Special Version: C35.336/06 Code 730/B 42
C35.324/06/07 Code 780/M 30 without/with part for power steering pump

Pressure Layout: Cutout pressure = 7.0 ± 0.2 bar
Control range = $-0.6 + 0.4$ bar

Installation Diagram:

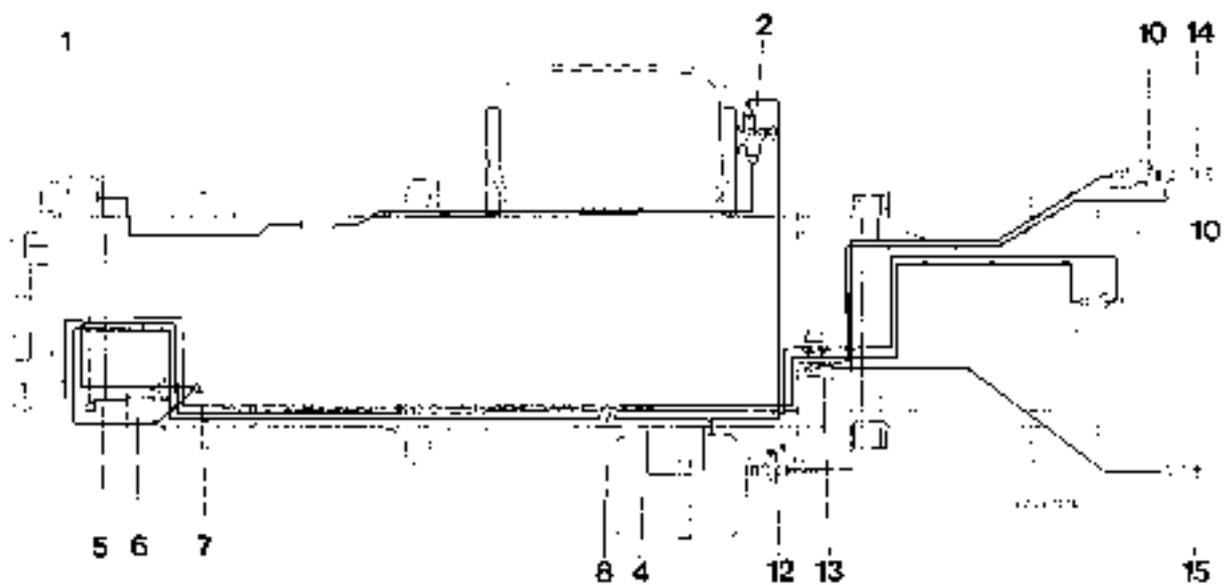

43.3 General Information

Explanations re 1.9/16

Item	Designation of Unit	Part No.	
		Mercedes-Benz	Westinghouse
1	Air compressor	002 131 11 01	411 040 840 0
1a	Suppl. air compressor	-	-
2	Pressure regulator with filter and tire inflation connection	000 431 79 05	475 304 201 0
2a	Pressure regulator	-	-
2b	Air cleaner with tire inflation connection	-	-
2c	Tire inflation cylinder	-	-
3	Antifreeze device or antifreeze pump	-	-
4	Compressed air tank (30 l)	421 432 08 15	-
4a	Suppl. compressed air tank	-	-
5	Master brake cylinder optional	001 430 85 01 002 430 53 01	- -
6	Compressed air brake booster	000 431 74 14	452 007 042 0
7	Brake double pressure gauge	no data	-
8	Connection for actuating differential lock	BM 22 x 1.5	DIN 74 302
9	Trailer control valve	-	-
10	Changeover valve (green lever) / shutoff valve	000 429 14 31	452 002 107 0
11	Coupling head (black) for brake hose	-	-
12	Pressure control valve	001 429 56 44	434 403 000 0
13	Relay valve	000 429 56 44	473 011 000 0
14	Coupling head (red) for supply hose	000 429 28 30	452 200 304 0
15	Coupling head (yellow) for brake hose	000 429 22 30	452 200 304 0
16	Handbrake valve	-	-
17	Brake cylinder	-	-
18	Brake force regulator	-	-
19	Two-way valve	-	-
20	Three-way valve	-	-
21	Overflow valve	-	-
22	Pressure reduction valve	-	-
23	Check valve	-	-

Description of Compressed Air System

Brake System: Hydraulic single-circuit brake system with compressed air assistance and compressed air control for combined single- and dual-line trailer brake system

Installed in Model: 421 122/123

Acc. to Drawing No.: 421 000 27 43

Special Version: 035.348/03 Code 725
035.324/01/02 Code 790/781 air compressor with/without oil pump

Pressure Layout: Output pressure - 7.3 ± 0.2 bar
Control range - 0.5 ± 0.4 bar

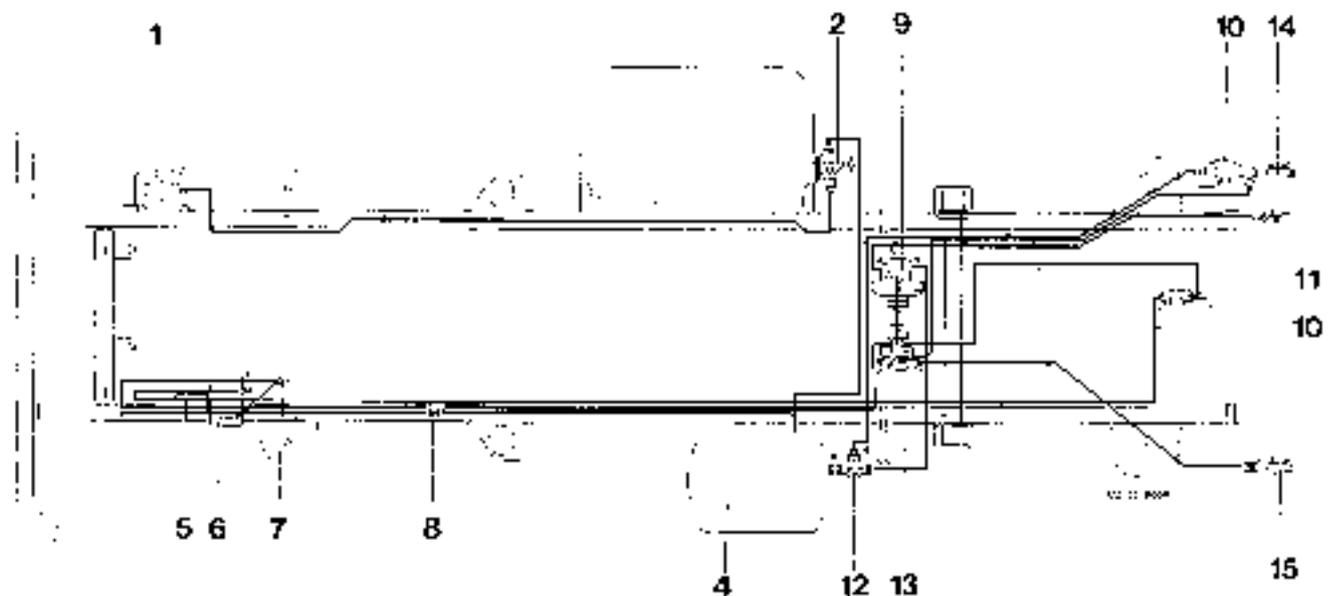
Installation Diagram:

43.3 General Information

Explanations re 1.9/17

Item	Designation of Unit	Part No.	
		Mercedes-Benz	Westinghouse
1	Air compressor	000 131 79 01	415 701 100 0
1a	Suppl. air compressor		
2	Pressure regulator with filler and tire inflation connection	000 431 79 06	475 304 201 0
2a	Pressure regulator		-
2b	Air cleaner with tire inflation connection	-	-
2c	Tire inflation cylinder	-	-
3	Antifreeze device or antifreeze pump	-	-
4	Compressed air tank (30 l)	421 432 08 15	-
4a	Suppl. compressed air tank	-	-
5	Master brake cylinder optional	001 430 85 01 002 430 53 01	-
6	Compressed air brake booster	000 431 74 14	462 307 042 0
7	Brake double pressure gauge	no cata	-
8	Connection for actuating differential lock	BM 22 x 1.5	DIN 74 302
9	Trailer control valve	000 431 71 05	471 200 113 0
10	Changeover valve (green lever) / shutoff valve	000 429 14 31	452 002 197 0
11	Coupling head (black) for brake hose	000 429 40 30	-
12	Pressure control valve	001 429 66 44	434 403 000 0
13	Relay valve	000 429 66 44	475 011 000 0
14	Coupling head (red) for supply hose	000 429 28 30	452 200 004 0
15	Coupling head (yellow) for brake hose	000 429 28 30	452 200 004 0
16	Handbrake valve		
17	Brake cylinder	-	-
18	Brake force regulator	-	-
19	Two-way valve	-	-
20	Three-way valve	-	-
21	Overflow valve	-	-
22	Pressure reduction valve	-	-
23	Check valve	-	-

Description of Compressed Air System

Brake System: Hydraulic single-circuit brake system with compressed air assistance and compressed air control for combined single- and dual-line trailer brake system

Installed in Model: 421 122/123

Acc. to Drawing No.: 421 000 25 40

Special Version 035 349/04 Code 72B
035 324/01/02 Code 760/781 air compressor with/without oil pump

Pressure Layout: Output pressure = 7.3 ± 0.2 bar
Control range = -0.6 ± 0.4 bar

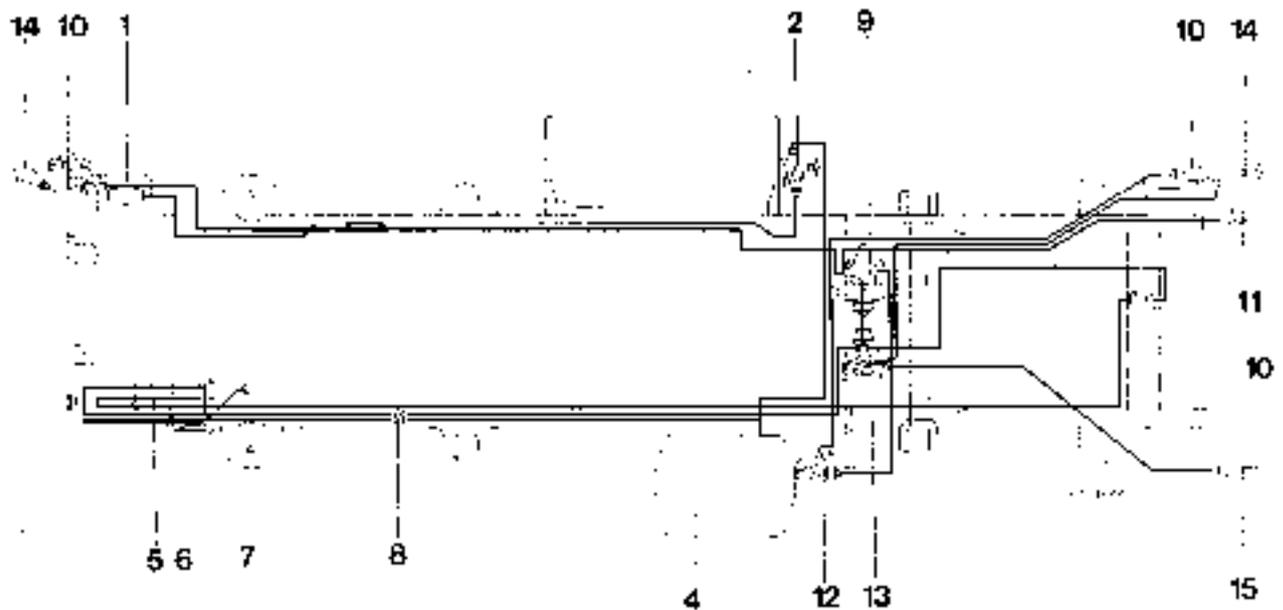
Installation Diagram.

43.3 General Information

Explanations re 1.9/19

Item	Designation of Unit	Part No.	
		Mercedes-Benz	Westinghouse
1	Air compressor	000 131 70 01	415 701 100 0
1a	Suppl. air compressor		-
2	Pressure regulator with filter and tire inflation connection	000 431 79 06	475 304 201 0
2a	Pressure regulator	-	-
2b	Air cleaner with tire inflation connection	-	-
2c	Tire inflation cylinder	-	-
3	Antifreeze device or antifreeze pump	-	-
4	Compressed air tank (30 l)	421 432 02 15	-
4a	Suppl. compressed air tank		-
5	Master brake cylinder optional	001 430 85 01 002 430 53 01	- -
6	Compressed air brake booster	000 431 74 14	462 007 042 0
7	Brake double pressure gauge	no data	-
8	Connection for actuating differential lock	BM 22 x 1.5	DIN 74 302
9	Trailer control valve	000 431 71 05	471 200 113 0
10	Changeover valve (green lever) / shutoff valve	000 429 14 31	452 002 107 0
11	Coupling head (black) for brake hose	000 429 48 30	
12	Pressure control valve	001 429 66 44	434 403 000 0
13	Relay valve	000 429 68 44	473 011 000 0
14	Coupling head (red) for supply hose	000 420 28 30	452 206 004 0
15	Coupling head (yellow) for brake hose	000 429 28 30	452 200 004 0
16	Handbrake valve	-	-
17	Brake cylinder	-	-
18	Brake force regulator	-	-
19	Two-way valve	-	-
20	Three-way valve	-	-
21	Overflow valve	-	-
22	Pressure reduction valve	-	-
23	Check valve	-	-

Description of Compressed Air System

Brake System: Hydraulic single-circuit brake system with compressed air assistance and compressed air control for combined single- and dual-line trailer brake system

Installed in Model: 421 124/125

Acc. to Drawing No.: 421 000 33 43

Special Version: 035 348/05 Code 725/B 45
035 324/06/07 Code /80/M 30 with/without port for power steering pump

Pressure Layout: Cutout pressure = 7.3 ± 0.2 bar
Control range = 0.6 - 3.4 bar

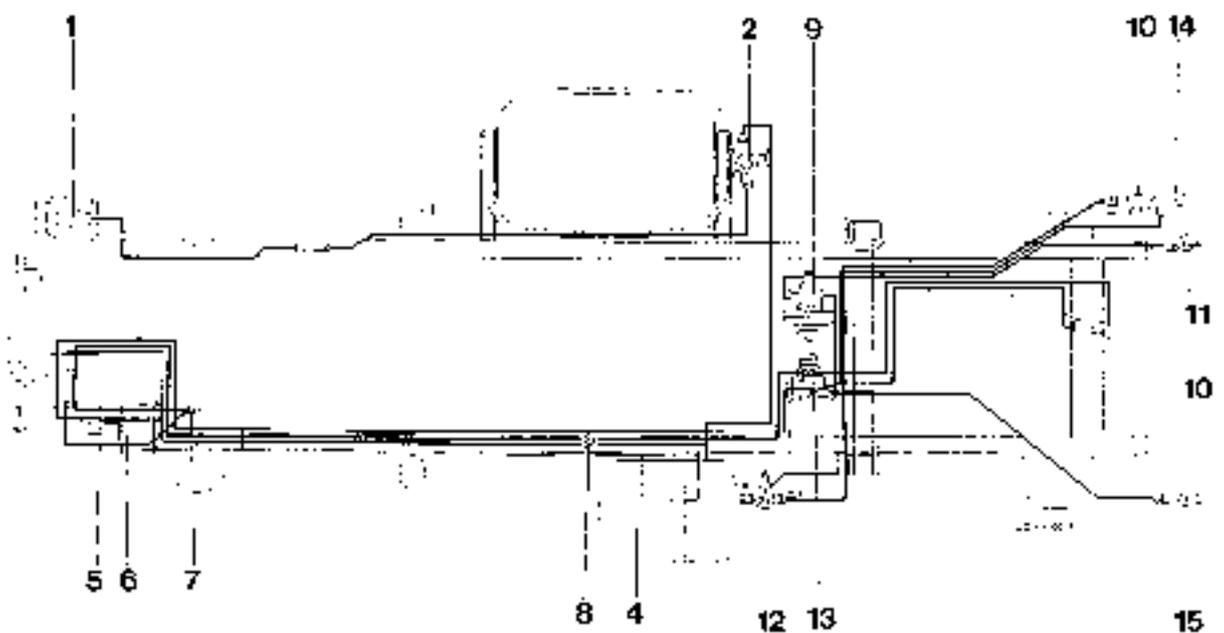
Installation Diagram:

43.3 General Information

Explanations re 1.9/21

Item	Designation of Unit	Part No.	
		Mercedes-Benz	Westinghouse
1	Air compressor	002 131 11 01	411 040 840 0
1a	Suppl. air compressor	-	-
2	Pressure regulator with filter and tire inflation connector	000 431 79 06	475 304 201 0
2a	Pressure regulator	-	-
2b	Air cleaner with tire inflation connection	-	-
2c	Tire inflation cylinder	-	-
3	Antifreeze device or antifreeze pump	-	-
4	Compressed air tank (30 l)	421 432 06 15	-
4a	Suppl. compressed air tank	-	-
5	Master brake cylinder optional	001 430 85 01	-
6	Compressed air brake booster	L00 431 74 14	462 007 042 0
7	Brake double pressure gauge	no data	-
8	Connection for actuating differential lock	BM 22 x 1.5	DIN 74 302
9	Trailer control valve	000 431 71 05	471 200 113 0
10	Changeover valve (green lever) / shutoff valve	000 429 14 31	452 002 107 0
11	Coupling head (black) for brake hose	000 429 48 30	-
12	Pressure control valve	001 429 66 44	434 403 000 0
13	Relay valve	000 429 66 44	473 011 003 0
14	Coupling head (red) for supply hose	000 429 28 30	452 200 304 0
15	Coupling head (yellow) for brake hose	000 429 28 30	452 200 304 0
16	Handbrake valve	-	-
17	Brake cylinder	-	-
18	Brake force regulator	-	-
19	Two-way valve	-	-
20	Three-way valve	-	-
21	Overflow valve	-	-
22	Pressure reduction valve	-	-
23	Check valve	-	-

Description of Compressed Air System

Brake System: Hydraulic single-circuit brake system with compressed air assistance

Installed in Model: 421.130/131

Acc. to Drawing No.: 421 000 01 42

Special Version: 035.079/01 Code 710
035.024/05 Code 781 air compressor with oil pump

Pressure Layout: Output pressure = 7.5 ± 0.2 bar
Control range = 0.6 ± 0.4 bar

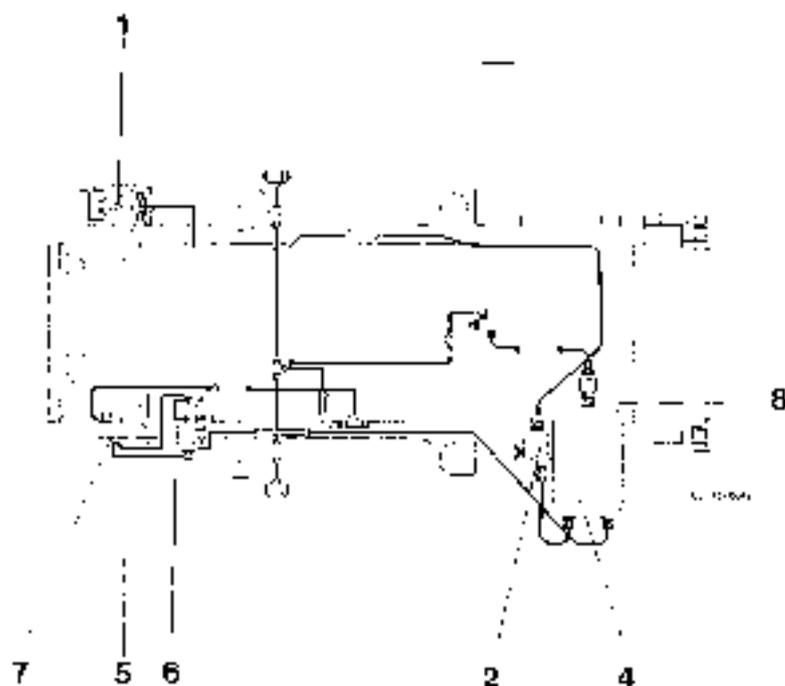
Installation Diagram.

43.3 General Information

Explanations re 1.9/23

Item	Designation of Unit	Part No.	
		Mercedes-Benz	Westinghouse
1	Air compressor	000 131 70 01	415 701 100 C
1a	Suppl. air compressor	-	-
2	Pressure regulator with filter and tire inflation connection	000 431 79 06	475 304 201 C
2a	Pressure regulator	-	-
2b	Air cleaner with tire inflation connection	-	-
2c	Tire inflation cylinder	-	-
3	Antifreeze device or antifreeze pump	-	-
4	Compressed air tank (30 l)	421 432 04 15	-
4a	Suppl. compressed air tank	-	-
5	Master brake cylinder	001 430 85 01	-
6	Compressed air brake booster	000 431 74 14	462 007 042 0
7	Brake double pressure gauge	no data	-
8	Connection for actuating differential lock	BM 22 x 1.5	DIN 74 299
9	Trailer control valve	-	-
10	Changeover valve (green lever) / shutoff valve	-	-
11	Coupling head (black) for brake hose	-	-
12	Pressure control valve	-	-
13	Relay valve	-	-
14	Coupling head (red) for supply hose	-	-
15	Coupling head (yellow) for brake hose	-	-
16	Handbrake valve	-	-
17	Brake cylinder	-	-
18	Brake force regulator	-	-
19	Two-way valve	-	-
20	Three-way valve	-	-
21	Overflow valve	-	-
22	Pressure reduction valve	-	-
23	Check valve	-	-

Description of Compressed Air System

Brake System:	Hydraulic single-circuit brake system with compressed air assistance	
Installed in Model:	421.132/163	
Acc. to Drawing No.:	421 000 13 42	
Special Version:	035 379/05	Code 710
	035 324/06/07	Code 760/M 30 with/w thout port for power steering pump
Pressure Layout:	Cutout pressure = 7.3 ± 0.2 bar	
	Control range = 0.6 ± 0.4 bar	

Installation Diagram:

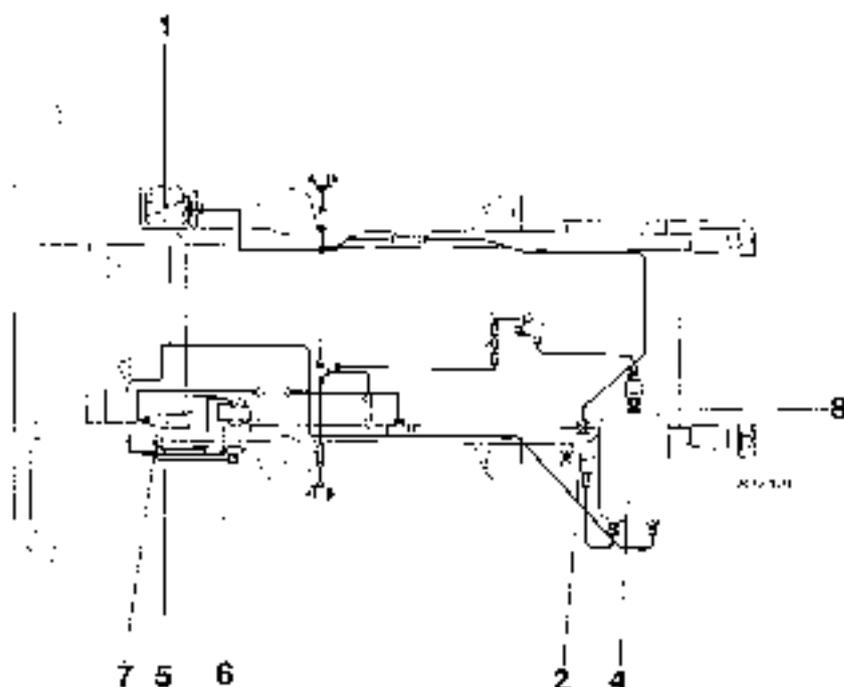

43.3 General Information

Explanations refer 9/25

Item	Designation of Unit	Part No.	
		Mercedes-Benz	Westinghouse
1	Air compressor optional	002 131 10 01 002 131 11 01	41' 040 800 0 41' 040 840 0
1a	Suppl. air compressor	-	-
2	Pressure regulator with filter and tire inflation connection	003 431 79 00	475 304 201 0
2a	Pressure regulator	-	-
2b	Air cleaner with tire inflation connection	-	-
2c	Tire inflation cylinder	-	-
3	Antifreeze device or antifreeze pump	-	-
4	Compressed air tank (30 l)	421 432 04 15	-
4a	Suppl. compressed air tank	-	-
5	Master brake cylinder optional	001 430 85 01 002 430 53 01	-
6	Compressed air brake booster	000 431 74 14	402 007 042 0
7	Brake double pressure gauge	no data	-
8	Connection for actuating differential lock	BM 22 x 1 0	DIN 74 280
9	Trailer control valve	-	-
10	Changeover valve (green lever) / shutoff valve	-	-
11	Coupling head (black) for brake hose	-	-
12	Pressure control valve	-	-
13	Relay valve	-	-
14	Coupling head (red) for supply hose	-	-
15	Coupling head (yellow) for brake hose	-	-
16	Handbrake valve	-	-
17	Brake cylinder	-	-
18	Brake force regulator	-	-
19	Two-way valve	-	-
20	Three-way valve	-	-
21	Overflow valve	-	-
22	Pressure reduction valve	-	-
23	Check valve	-	-

Description of Compressed Air System

Brake System: Hydraulic single-circuit brake system with compressed air assistance

Installed in Model: 421.122/123

Acc. to Drawing No.: 421 000 17 43 (French version)

Special Version: 035.378/01 Code 727
035.324/01/02 Code 780/781 air compressor with/w thout oil pump

Pressure Layout: Circuit pressure = 7.3 ± 0.2 bar
Control range = $0.6 + 0.4$ bar

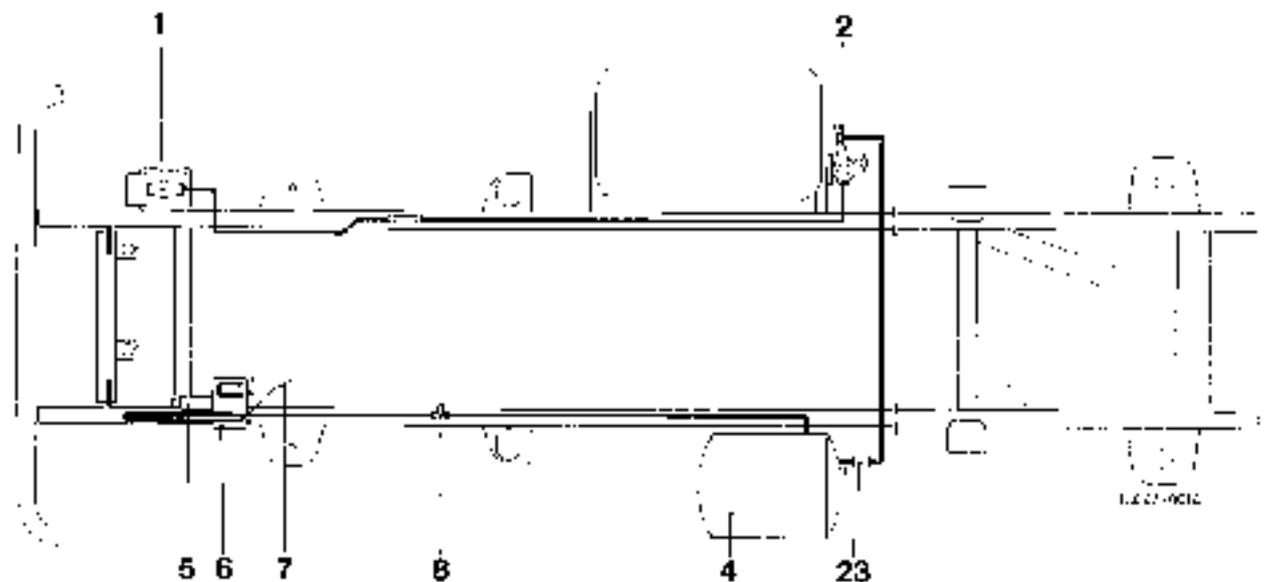
Installation Diagram:

43.3 General Information

Explanations re 1.9/27

Item	Designation of Unit	Part No.	
		Mercedes-Benz	Westinghouse
1	Air compressor optional	001 131 78 01 000 131 70 01	411 004 101 0 415 701 100 0
1a	Suppl. air compressor	-	-
2	Pressure regulator with filter and tire inflation connection	000 431 79 06	475 304 701 0
2a	Pressure regulator	-	-
2b	Air cleaner with tire inflation connection	-	-
2c	Tire inflation cylinder	-	-
3	Antifreeze device or antifreeze pump		
4	Compressed air tank (30 l)	421 432 08 15	-
4a	Suppl. compressed air tank	-	
5	Master brake cylinder optional	001 430 85 01 002 430 53 01	- -
6	Compressed air brake booster	000 431 74 14	462 007 042 0
7	Brake double pressure gauge	no data	-
9	Connection for actuating differential lock	BM 22 x 1.5	DrN 74 302
9	Trailer control valve	-	-
10	Changeover valve (green lever) / shutoff valve	-	-
11	Coupling head (black) for brake hose	-	-
12	Pressure control valve	-	-
13	Relay valve	-	-
14	Coupling head (red) for supply hose	-	-
15	Coupling head (yellow) for brake hose	-	-
16	Handbrake valve	-	-
17	Brake cylinder	-	-
18	Brake force regulator	-	-
19	Two-way valve	-	-
20	Three-way valve	-	-
21	Overflow valve	-	-
22	Pressure reduction valve	-	-
23	Check valve	003 429 07 41	434 014 100 0

Description of Compressed Air System

Brake System:	Hydraulic single-circuit brake system with compressed air assistance	
Installed in Model:	471 124/125/162/163	
Acc. to Drawing No.:	421 000 36 43 (French version)	
Special Version:	030 373/03	Code 727
	030 324/06/07	Code 780/M 3U with/without port for power steering pump

Pressure Layout: Cutout pressure - 7.0 ± 0.2 bar
Control range - 0.6 ± 0.4 bar

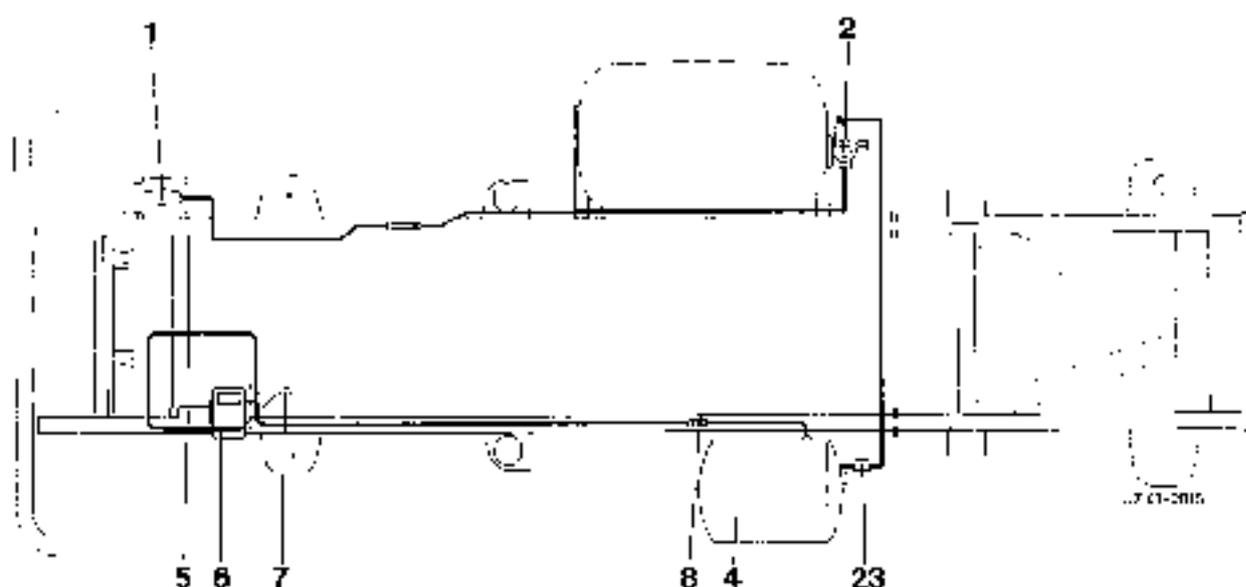
Installation Diagram:

43.3 General Information

Explanations: ré 1.9/29

Item	Designation of Unit	Part No.	
		Mercedes-Benz	Westinghouse
1	Air compressor optional	002 131 10 01 002 131 11 01	41' 040 900 0 41' 040 840 0
1a	Suppl. air compressor	-	-
2	Pressure regulator with filter and tire inflation connection	000 431 79 08	475 334 201 0
2a	Pressure regulator	-	-
2b	Air cleaner with tire inflation connection	-	-
2c	Tire inflation cylinder	-	-
3	Antifreeze device or antifreeze pump	-	-
4	Compressed air tank (30 l)	421 432 08 15	-
4a	Suppl. compressed air tank	-	-
5	Master brake cylinder optional	001 430 35 01 002 430 53 01	- -
6	Compressed air brake booster	000 431 74 14	482 007 042 0
7	Brake double pressure gauge	no data	-
8	Connection for actuating differential lock	BM 22 x 1.5	DIN 74 302
9	Trailer control valve	-	-
10	Changeover valve (green lever) / shutoff valve	-	-
11	Coupling head (black) for brake hose	-	-
12	Pressure control valve	-	-
13	Relay valve	-	-
14	Coupling head (red) for supply hose	-	-
15	Coupling head (yellow) for brake hose	-	-
16	Handbrake valve	-	-
17	Brake cylinder	-	-
18	Brake force regulator	-	-
19	Two-way valve	-	-
20	Three-way valve	-	-
21	Overflow valve	-	-
22	Pressure reduction valve	-	-
23	Check valve	003 429 07 44	434 014 10 00

Description of Compressed Air System

Brake System: Hydraulic single-circuit brake system with compressed air assistance and compressed air control for dual-line trailer brake system as well as separate booster brake.

Installed in Model: 421 122/123

Acc. to Drawing No.: 421 000 16 43 (French version)

Special Version: 035.378/02 Code 727
035.324/01/02 Code 780/78* air compressor with/without oil pump

Pressure Layout: Cutout pressure = 7.3 ± 0.2 bar
Control range = $0.6 + 0.1$ bar

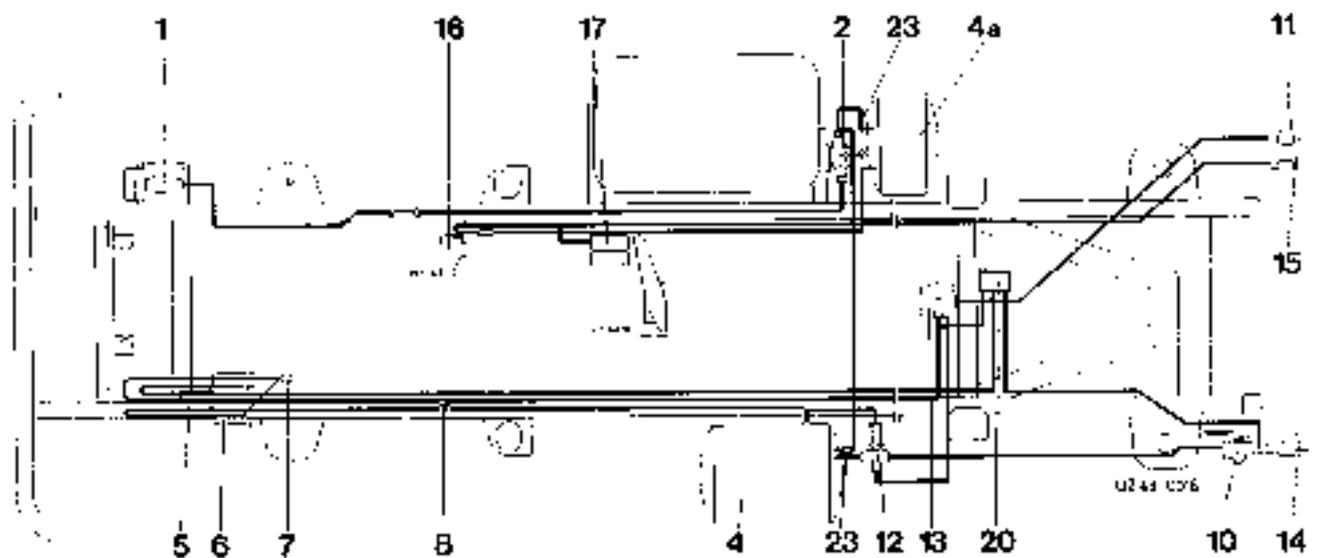
Installation Diagram:

43.3 General Information

Explanations re 1.9/31

Item	Designation of Unit	Part No	
		Mercedes Benz	Westinghouse
1	Air compressor optional	000 131 79 01 000 131 70 01	411 004 101 0 415 701 100 0
1a	Suppl. air compressor	-	-
2	Pressure regulator with filter and tire inflation connection	000 431 79 06	475 304 201 0
2a	Pressure regulator	-	-
2b	Air cleaner with tire inflation connection	-	-
2c	Tire inflation cylinder	-	-
3	Antifreeze device or antifreeze pump	-	-
4	Compressed air tank (30 l)	421 432 03 15	-
4a	Suppl. compressed air tank	421 432 03 15	-
5	Master brake cylinder optional	001 430 85 01 002 430 53 01	- -
6	Compressed air brake booster	000 431 74 14	462 007 042 0
7	Brake double pressure gauge	no data	-
8	Connection for actuating differential lock	BM 22 x 1.5	DIN 74 302
9	Trailer control valve	-	-
10	Changeover valve (green lever) / shutoff valve	000 429 14 31	452 002 107 0
11	Coupling head (black) for brake hose	000 429 27 30	890 020 012 0
12	Pressure control valve	001 429 68 44	434 403 000 0
13	Relay valve	000 429 65 11	473 010 000 0
14	Coupling head (red) for supply hose	000 429 01 30	452 300 000 0
15	Coupling head (yellow) for brake hose	000 429 27 30	890 020 012 0
16	Handbrake valve	000 431 02 18	481 704 025 0
17	Brake cylinder	000 420 52 24	421 002 000 0
18	Brake force regulator	-	-
19	Two-way valve	-	-
20	Three-way valve	000 429 68 44	371 020 000 0
21	Overflow valve	-	-
22	Pressure reduction valve	-	-
23	Check valve	003 429 07 44	434 014 10 00

Description of Compressed Air System

Brake System: Hydraulic single-circuit brake system with compressed air assistance and compressed air control for dual-line trailer brake system as well as separate booster brake

Installed in Model: 421.124/125

Acc. to Drawing No.: 421 000 37 43 (French version)

Special Version: 035.378/04 Code 727
035.324/06/07 Code 780/M 30 with/without part for power steering pump

Pressure Layout: Cutout pressure = 7.0 ± 0.2 bar
Control range = 0.6 ± 0.4 bar

Installation Diagram:

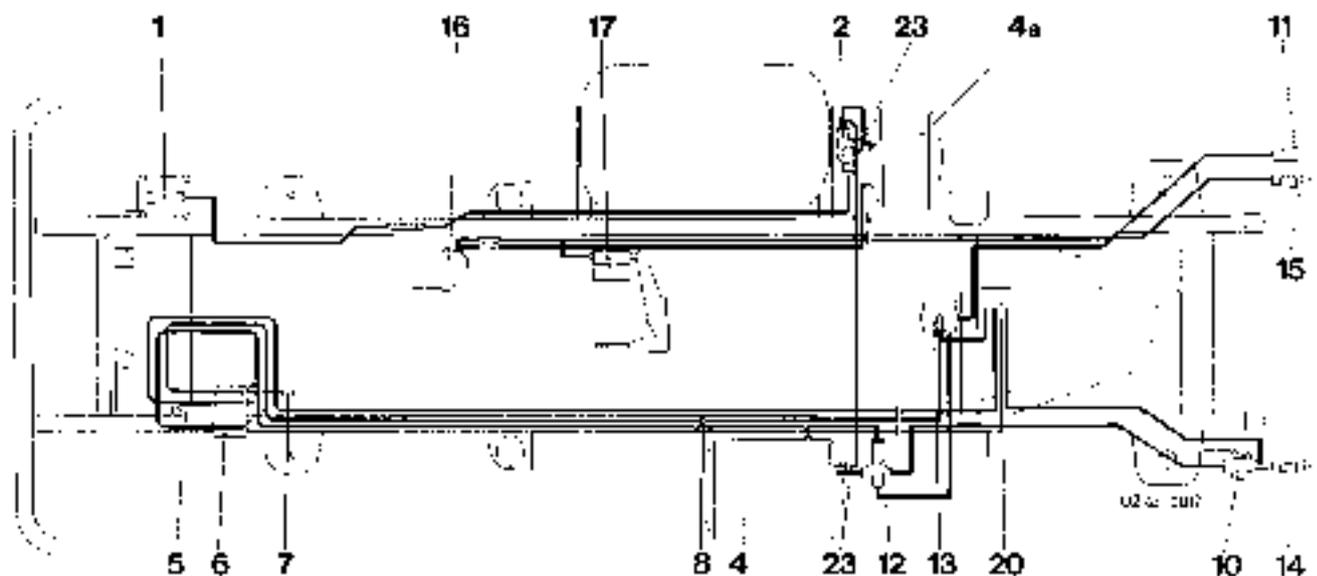

43.3 General Information

Explanations re 1.9/33

Item	Designation of Unit	Part No	
		Mercedes-Benz	Westinghouse
1	Air compressor optional	002 131 10 01 002 131 11 01	411 040 900 0 411 040 840 0
1a	Suppl. air compressor	-	-
2	Pressure regulator with filter and tire inflation connection	000 431 79 06	475 304 201 0
2a	Pressure regulator	-	-
2b	Air cleaner with tire inflation connection	-	-
2c	Tire inflation cylinder	-	-
3	Antifreeze device or antifreeze pump	-	-
4	Compressed air tank (30 l)	421 432 08 15	-
4a	Suppl. compressed air tank	421 432 03 15	-
5	Master brake cylinder optional	001 430 85 01 002 430 53 01	- -
6	Compressed air brake booster	000 431 74 14	462 007 042 0
7	Brake double pressure gauge	no data	-
8	Connection for actuating differential lock	BM 22 x 1.5	DIN 74 302
9	Trailer control valve	-	-
10	Changeover valve (green lever) / shutoff valve	000 429 14 31	452 002 107 0
11	Coupling head (black) for brake hose	000 429 27 30	390 020 012 0
12	Pressure control valve	001 429 66 44	434 403 000 0
13	Relay valve	000 429 65 44	473 010 000 0
14	Coupling head (red) for supply hose	000 429 01 30	452 300 000 0
15	Coupling head (yellow) for brake hose	000 429 27 30	890 020 012 0
16	Handbrake valve	000 431 02 16	461 704 025 0
17	Brake cylinder	000 420 52 24	421 002 000 0
19	Brake force regulator	-	-
19	Two-way valve	-	-
20	Three-way valve	000 429 66 44	3/1 020 003 0
21	Overflow valve	-	-
22	Pressure reduction valve	-	-
23	Check valve	003 428 07 44	434 014 100 0

Description of Compressed Air System

Brake System: Hydraulic single-circuit brake system with compressed air assistance and compressed air control for single-line trailer brake system as well as separate supply line.

Installed in Model: 421.122/123

Acc. to Drawing No.: 421 000 23 43 without front compressed air port Swiss version
421 000 24 43 with front compressed air support

Special Version: 035.335/07/08 Code 722
035.324/01 or /02 Code 782/781 air compressor with/w/ front oil pump

Pressure Layout: Cutout pressure = 5.3 ± 0.3 bar
Control range = 0.5 bar

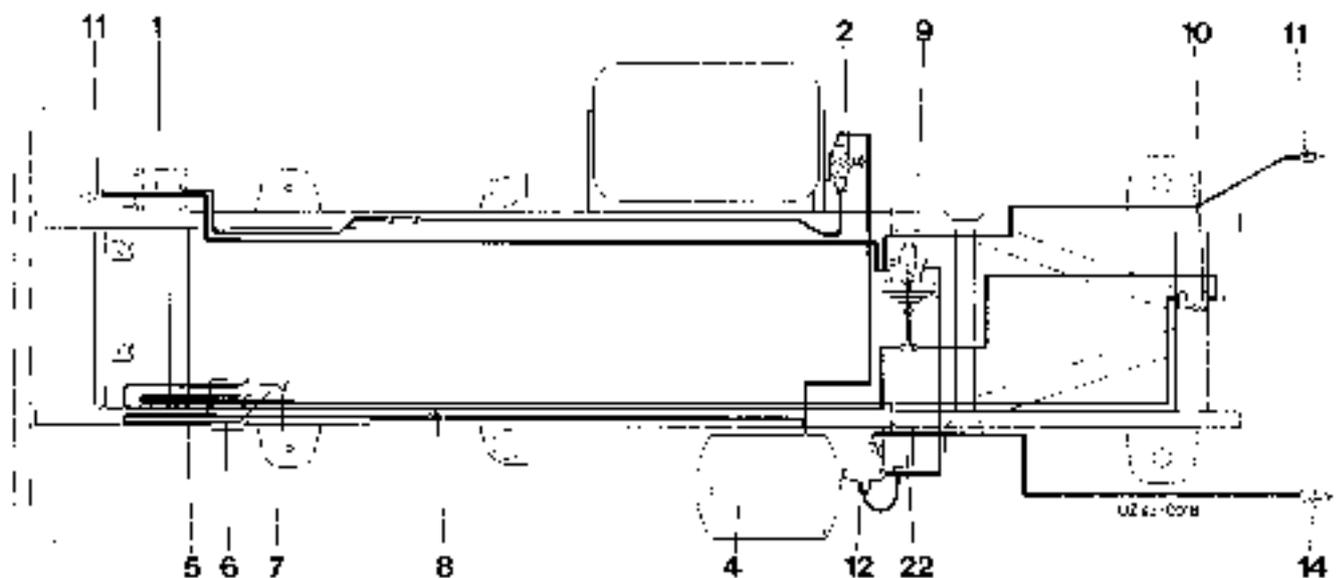
Installation Diagram:

43.3 General Information

Explanations re 1.9/35

Item	Designation of Unit	Optional	Part No.	
			Mercedes-Benz	Westinghouse
1	Air compressor	optional	000 131 78 01 000 131 75 01	411 004 107 0 415 701 100 0
1a	Suppl. air compressor		-	-
2	Pressure regulator with filter and tire inflation connection		000 431 70 06	475 304 207 0
2a	Pressure regulator		-	-
2b)	Air cleaner with tire inflation connection		-	-
2c	Tire inflation cylinder		-	-
3	Antifreeze device or antifreeze pump		-	-
4	Compressed air tank (30 l)		421 432 08 15	-
4a	Suppl. compressed air tank		-	-
5	Master brake cylinder		001 430 84 01	-
6	Compressed air brake booster		000 431 74 14	462 007 042 0
7	Brake double pressure gauge		no data	-
8	Connection for actuating differential lock		BM 22 x 1.5	DIN 74 302
9	Trailer control valve		000 431 70 05	471 206 112 0
10	Changeover valve (green lever) / shut-off valve		000 429 14 31	452 002 107 0
11	Coupling head (black) for brake hose		000 429 48 30	-
12	Pressure control valve		001 429 68 44	434 403 000 0
13	Relay valve		-	-
14	Coupling head (red) for supply hose		000 429 68 30	452 303 011 0
15	Coupling head (yellow) for brake hose		-	-
16	Handbrake valve		-	-
17	Brake cylinder		-	-
18	Brake force regulator		-	-
19	Two-way valve		-	-
20	Three-way valve		-	-
21	Overflow valve		-	-
22	Pressure reduction valve		000 429 45 44	475 003 005 0
23	Check valve		-	-

Description of Compressed Air System

Brake System: Hydraulic single-circuit brake system with compressed air assistance and compressed air control for single-line trailer brake system as well as separate supply line

Installed in Model: 421 124/125

Acc. to Drawing No.: 421 000 31 13 (Swiss version)

Special Version: 035 335/10 Code 722
035 324/06/07 Code 760/M 30 with/without port for power steering pump

Pressure Layout: Output pressure = 5.3 + 0.3 bar
Control range = 0.5 bar

Installation Diagram:

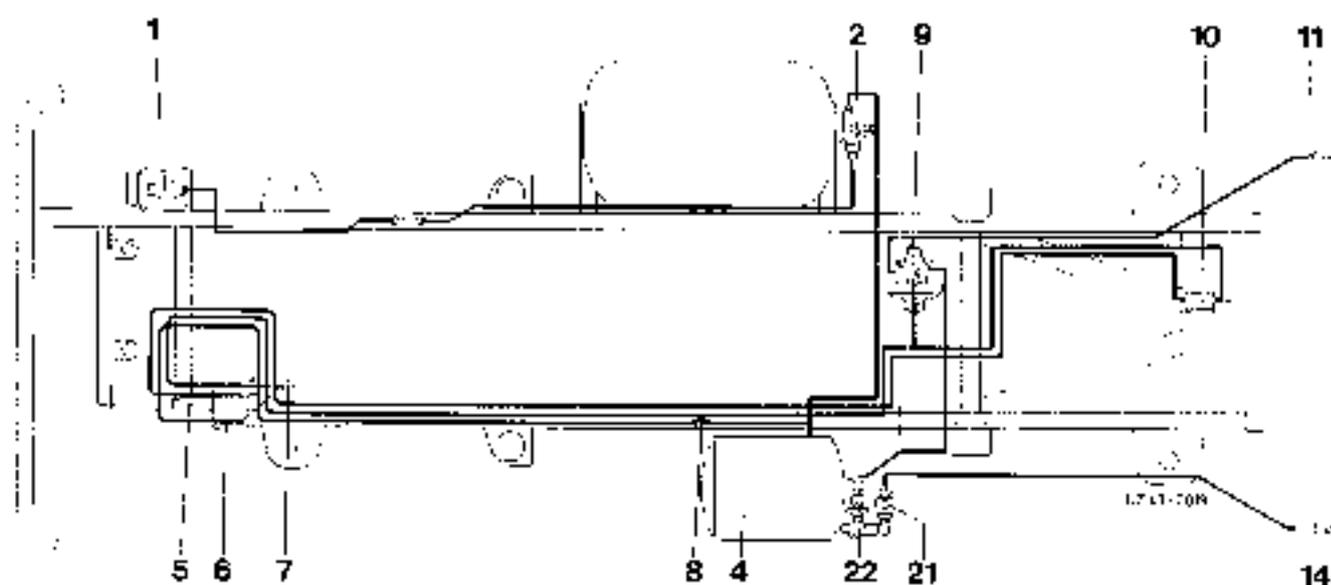

43.3 General Information

Explanations → 1.9/37

Item	Designation of Unit	Part No.	
		Mercedes-Benz	Westinghouse
1	Air compressor optional	002 131 13 01 002 131 11 01	411 040 500 0 411 040 540 0
1a	Suppl. air compressor	-	-
2	Pressure regulator with filter and tire inflation connection	000 431 79 06	475 304 201 0
2a	Pressure regulator	-	-
2b	Air cleaner with tire inflation connection	-	-
2c	Tire inflation cylinder	-	-
3	Antifreeze device or antifreeze pump	-	-
4	Compressed air tank (20 l)	421 432 08 15	-
4a	Suppl. compressed air tank	-	-
5	Master brake cylinder	002 430 74 01	-
6	Compressed air brake booster	000 431 74 14	462 007 042 0
7	Brake double pressure gauge	no data	-
8	Connector for actuating differential lock	BM 22 x 1.5	DIN 74 302
9	Trailer control valve	000 431 70 05	471 200 112 0
10	Changeover valve (green lever) / shutoff valve	000 429 14 31	452 002 107 0
11	Coupling head (black) for brake hose	000 429 49 30	-
12	Pressure control valve	-	-
13	Relay valve	-	-
14	Coupling head (red) for supply hose	000 429 68 30	452 303 011 0
15	Coupling head (yellow) for brake hose	-	-
16	Handbrake valve	-	-
17	Brake cylinder	-	-
18	Brake force regulator	-	-
19	Two-way valve	-	-
20	Three-way valve	-	-
21	Overflow valve	000 429 72 44	434 100 203 0
22	Pressure reduction valve	001 429 17 44	475 010 003 0
23	Check valve	-	-

Description of Compressed Air System

Brake System: Hydraulic single-circuit brake system with compressed air assistance

Installed in Model: 421 122/123

Acc. to Drawing No.: 421 000 19 43 (Italian version)

Special Version: 035 349/05 Code 715
035 324/01/02 Code 780/781 air compressor with/without oil pump

Pressure Layout: Cutout pressure = 7.3 ± 0.2 bar
Control range = 0.6 ± 0.4 bar

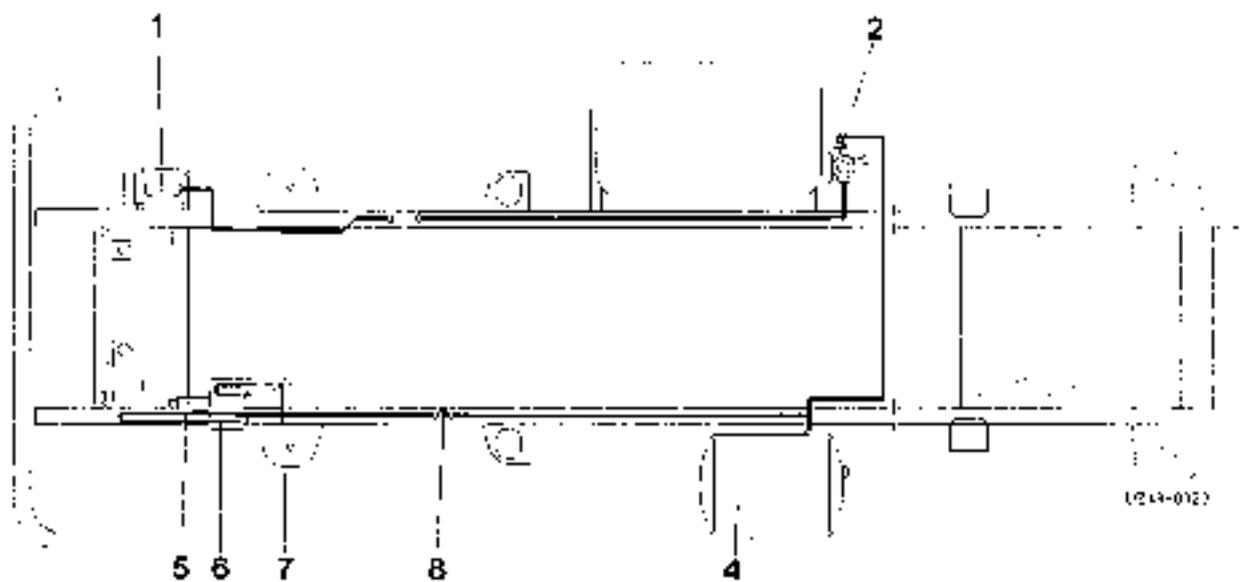
Installation Diagram:

43.3 General Information

Explanations re 1.9/39

Item	Designation of Unit	Part No	
		Mercedes-Benz	Westinghouse
1	Air compressor optional	000 131 70 01 000 131 70 01	411 604 101 0 415 701 100 0
1a	Supply air compressor		-
2	Pressure regulator with filter and tire inflation connection	000 431 78 0E	475 304 201 0
2a	Pressure regulator	-	-
2b	Air cleaner with tire inflation connection		-
2c	Tire inflation cylinder	-	-
3	Antifreeze device or antifreeze pump		-
4	Compressed air tank (30 l)	421 432 08 15	
4a	Supply compressed air tank	-	-
5	Master brake cylinder	001 430 84 01	-
6	Compressed air brake booster	000 431 74 14	4E2 007 012 0
7	Brake double pressure gauge	no data	
8	Connection for actuating differential lock	BM 22 x 1.5	DIN 74 302
9	Trailer control valve		-
10	Changeover valve (green lever) / shutoff valve	-	-
11	Coupling head (black) for brake hose		-
12	Pressure control valve	-	-
13	Relay valve		-
14	Coupling head (red) for supply hose	-	-
15	Coupling head (yellow) for brake hose	-	-
16	Handbrake valve		-
17	Brake cylinder	-	-
18	Brake force regulator	-	-
19	Two-way valve	-	-
20	Three-way valve	-	-
21	Overflow valve	-	-
22	Pressure reduction valve	-	-
23	Check valve		

Description of Compressed Air System

Brake System:	Hydraulic single-circuit brake system with compressed air assistance	
Installed in Model:	421.124/125	
Acc. to Drawing No.:	421.000.19.43 (Italian version)	
Special Version:	035.349/09	Code 726
	055.324/06/07	Code 780/M 50 with/without port for power steering pump

Pressure Layout: Cut-off pressure = 7.3 ± 0.2 bar
Control range = $-0.5 + 0.4$ bar

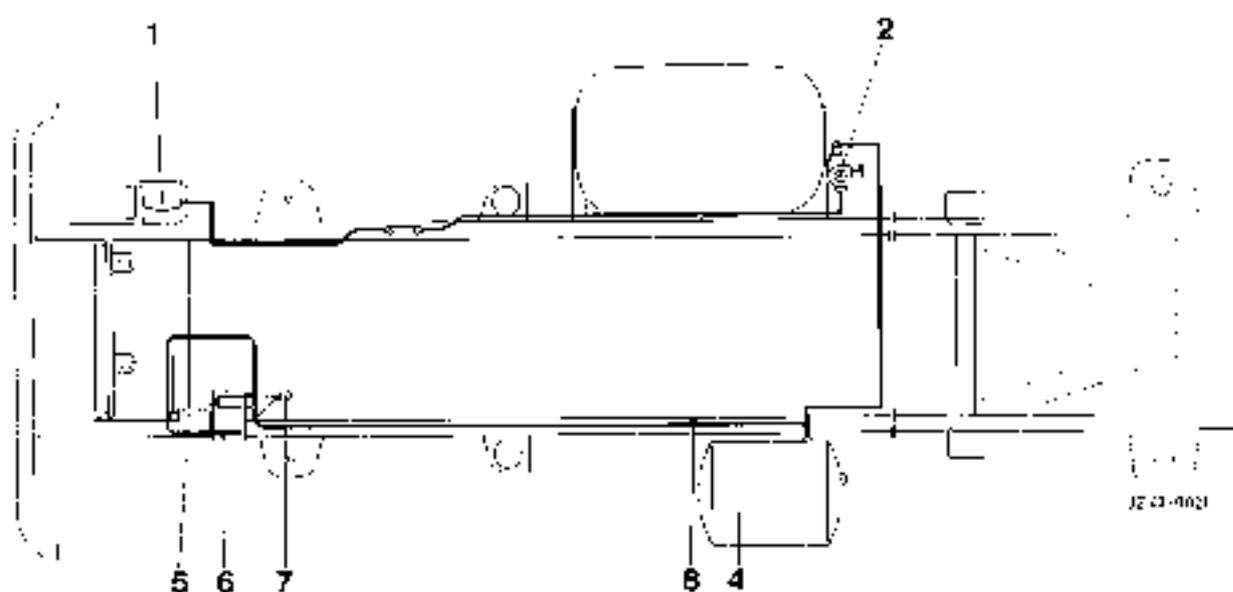
Installation Diagram:

43.3 General Information

Explanations re 1.9/41

Item	Designation of Unit	Part No.	
		Mercedes-Benz	Westinghouse
-	Air compressor	optional	
		002 131 10 01 002 131 14 01	411 040 800 J 411 040 840 J
1a	Suppl. air compressor	-	-
2	Pressure regulator with filter and tire inflation connection	000 431 79 06	475 304 201 0
2a	Pressure regulator	-	-
2b	Air cleaner with tire inflation connection	-	-
2c	Tire inflation cylinder	-	-
3	Antifreeze device or antifreeze pump	-	-
4	Compressed air tank (30 l)	421 432 06 15	-
4a	Suppl. compressed air tank	-	-
5	Master brake cylinder	002 430 74 01	-
6	Compressed air brake booster	000 431 74 14	462 007 042 0
7	Brake double pressure gauge	no data	-
8	Connection for actuating differential lock	BM 22 x 1.5	DIN 74 302
9	Trailer control valve	-	-
10	Changeover valve (green lever) / shutoff valve	-	-
11	Coupling head (black) for brake hose	-	-
12	Pressure control valve	-	-
13	Relay valve	-	-
14	Coupling head (red) for supply hose	-	-
15	Coupling head (yellow) for brake hose	-	-
16	Handbrake valve	-	-
17	Brake cylinder	-	-
18	Brake force regulator	-	-
19	Two-way valve	-	-
20	Three-way valve	-	-
21	Overflow valve	-	-
22	Pressure reduction valve	-	-
23	Check valve	-	-

Description of Compressed Air System

Brake System: Hydraulic single-circuit brake system with compressed air assistance and compressed air control for dual-line trailer brake system as well as separate booster brake

Installed in Model: 421.122/123

Acc. to Drawing No.: 421 000 20 06 (Italian version)

Special Version: 035 349/06 Code 729
035 024/01/02 Code 780/781 air compressor with/without oil pump

Pressure Layout: Output pressure = 7.9 ± 0.2 bar
Control range = $-0.6 + 0.4$ bar

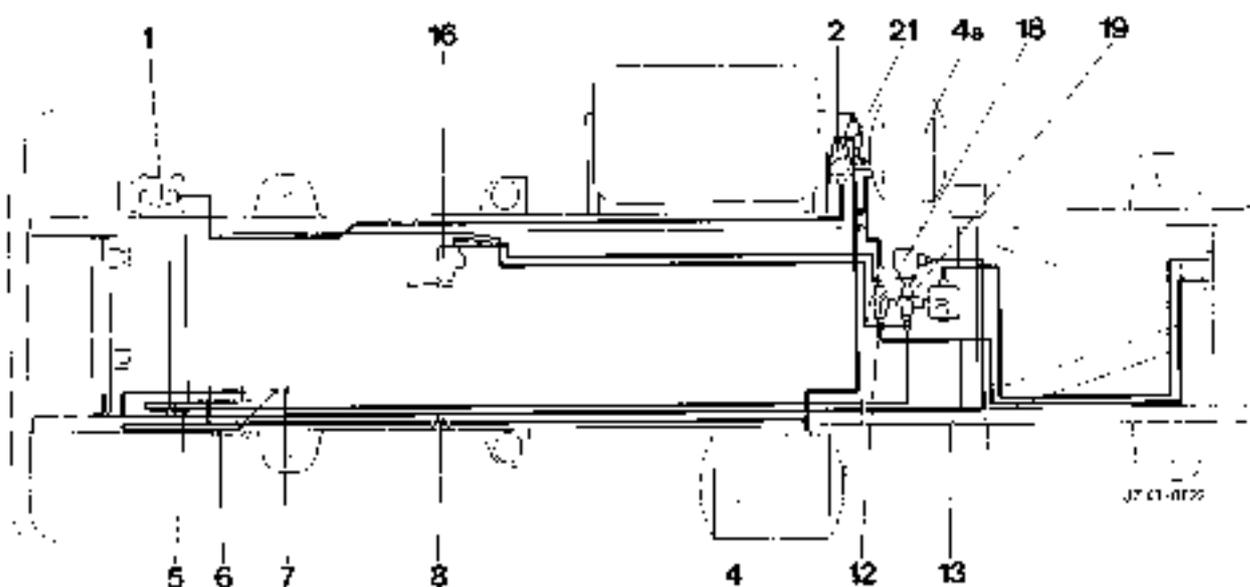
Installation Diagram:

43.3 General Information

Explanations re 1.9/43

Item	Designation of Unit	Part No.	
		Mercedes-Benz	Westinghouse
1	Air compressor	optional	
		000 131 78 01 000 131 70 01	411 004 10* 0 415 701 100 0
1a	Suppl. air compressor	-	-
2	Pressure regulator with filter and tire inflation connection	000 431 79 06	475 304 201 0
2a	Pressure regulator	-	-
2b	Air cleaner with tire inflation connection	-	-
2c	Tire inflator cylinder	-	-
3	Antifreeze device or antifreeze pump	-	-
4	Compressed air tank (30 li)	421 432 08 15	-
4a	Suppl. compressed air tank	421 432 03 15	-
5	Mist or brake cylinder	001 430 64 01	-
6	Compressed air brake booster	000 431 74 14	462 007 042 0
7	Brake double pressure gauge	no data	-
8	Connector for actuating differential lock	BM 22 x 1.5	DIN 74 302
9	Trailer control valve	-	-
10	Changeover valve (green lever) / shutoff valve	-	-
11	Coupling head (black) for brake hose	-	-
12	Pressure control valve	001 429 66 44	434 403 000 0
13	Relay valve	000 429 65 44	473 010 000 0
14	Coupling head (red) for supply hose	-	-
15	Coupling head (yellow) for brake hose	-	-
16	Handbrake valve	000 431 02 10	461 704 025 0
17	Brake cylinder	-	-
18	Brake force regulator	000 431 32 12	475 601 014 0
19	Two-way valve	000 429 40 44	434 202 000 0
20	Three-way valve	-	-
21	Overflow valve	000 420 76 22	434 100 103 0
22	Pressure reduction valve	-	-
23	Check valve	-	-

Description of Compressed Air System

Brake System: Hydraulic single-circuit brake system with compressed air assistance and compressed air control for dual-line trailer brake system as well as separate booster brake

Installed in Model: 421 124/125

Acc. to Drawing No.: 421 001 19 43 (Italian version)

Special Version: 03E 349/10 Code 728
03E 324/D6/07 Code 780/M 30 with/without port for power steering pump

Pressure Layout: Cutout pressure = 7.3 ± 0.2 bar
Control range = $0.6 + 0.4$ bar

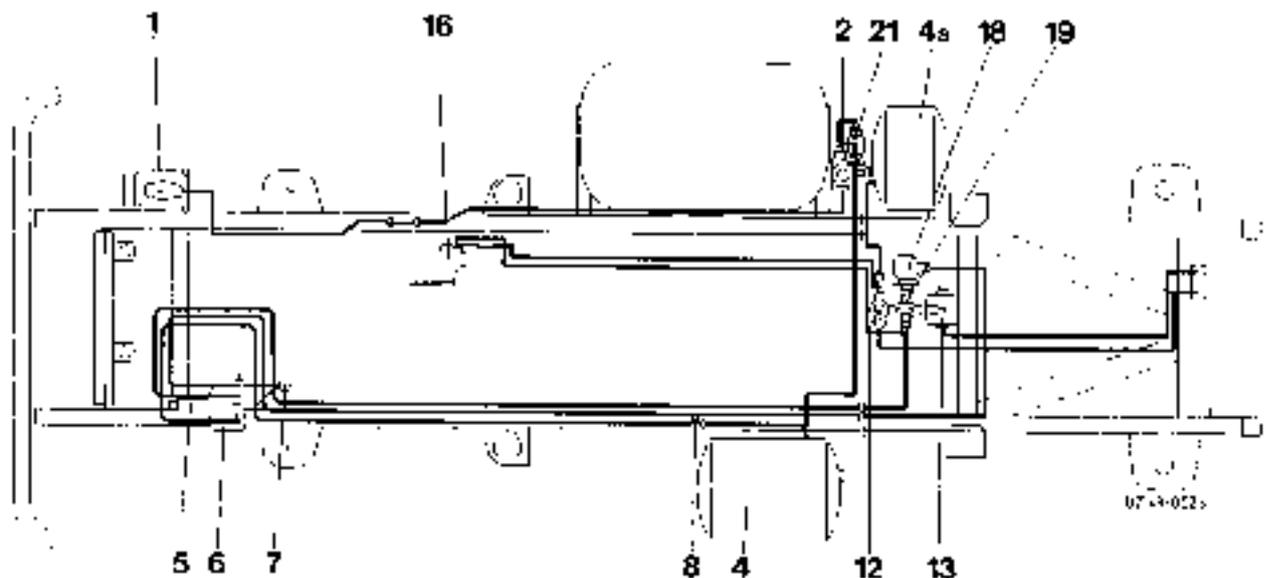
Installation Diagram:

43.3 General Information

Explanations re 1.9/46

Item	Designation of Unit	Part No.	
		Mercedes-Benz	Westinghouse
1	Air compressor optional	002 131 10 01 002 131 11 01	411 040 800 0 411 040 840 0
1a	Suppl. air compressor	-	-
2	Pressure regulator with filter and tire inflation connection	000 431 79 05	475 304 201 0
2a	Pressure regulator	-	-
2b	Air cleaner with tire inflation connection	-	-
2c	Tire inflation cylinder	-	-
3	Antifreeze device or antifreeze pump	-	-
4	Compressed air tank (30 l)	421 432 00 15	-
4a	Suppl. compressed air tank	421 432 03 15	-
5	Master brake cylinder	002 430 74 01	-
6	Compressed air brake booster	000 431 74 14	4E2 007 042 0
7	Brake double pressure gauge	no data	-
8	Connection for actuating differential lock	BM 22 x 1.5	DIN 74 302
9	Trailer control valve	-	-
10	Changeover valve (green lever) / shutoff valve	-	-
11	Coupling head (black) for brake hose	-	-
12	Pressure control valve	001 429 68 44	434 403 000 0
13	Relay valve	000 429 66 44	473 010 000 0
14	Coupling head (red) for supply hose	-	-
15	Coupling head (yellow) for brake hose	-	-
16	Handbrake valve	003 431 02 16	461 704 025 0
17	Brake cylinder	-	-
18	Brake force regulator	000 431 32 12	475 601 014 0
19	Two-way valve	000 429 40 44	434 202 000 0
20	Three-way valve	-	-
21	Overflow valve	000 429 76 44	434 100 103 0
22	Pressure reduction valve	-	-
23	Check valve	-	-

Description of Compressed Air System

Brake System: Hydraulic single-circuit brake system with compressed air assistance and compressed air control for dual-line trailer brake system as well as separate booster brake

Installed in Model: 421 124/125

Acc. to Drawing No.: 421 000 19 42 (Italian version)

Special Version: 035 567/02 Code 729
035 324/06/07 Code 780/M 30 with/without part for power steering pump

Pressure Layout: Cutout pressure = 7.3 ± 0.2 bar
Control range = $0.6 + 0.4$ bar

Installation Diagram:

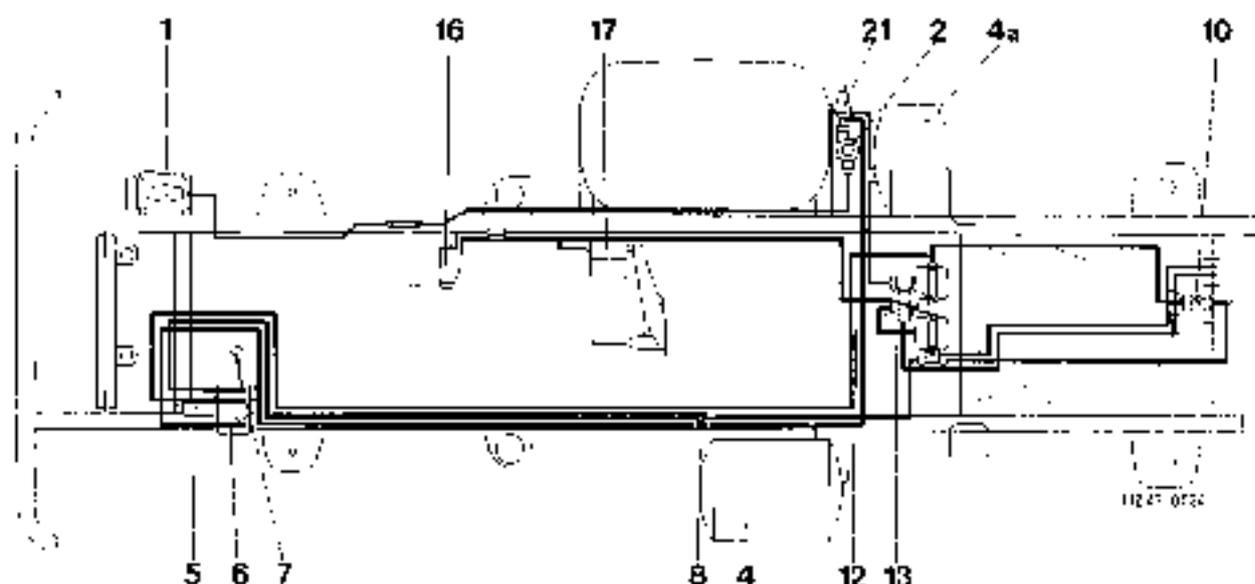

43.3 General Information

Explanations re 1.9/47

Item	Designation of Unit	Part No.	
		Mercedes-Benz	Westinghouse
1	Air compressor optional	002 131 10 01 002 131 11 01	411 040 800 0 411 040 640 0
1a	Suppl. air compressor	-	-
2	Pressure regulator with filter and tire inflation connector	030 431 79 06	475 304 201 0
2a	Pressure regulator	-	-
2b	Air cleaner with tire inflation connection	-	-
2c	Tire inflation cylinder	-	-
3	Anti-freeze device or antifreeze pump	-	-
4	Compressed air tank (30 li)	421 432 06 15	-
4a	Suppl. compressed air tank	421 432 03 15	-
5	Master brake cylinder	002 430 74 01	-
6	Compressed air brake booster	000 431 74 14	462 007 042 0
7	Brake coupler pressure gauge	no data	-
8	Connection for actuating differential lock	000 990 14 70	-
9	Trailer control valve	-	-
10	Changeover valve (green lever) / shutoff valve	000 429 15 31	952 002 030 0
11	Coupling head (black) for brake hose	-	-
12	Pressure control valve	001 429 66 44	434 403 000 0
13	Relay valve	001 429 21 44	473 017 000 0
14	Coupling head (red) for supply hose	-	-
15	Coupling head (yellow) for brake hose	-	-
16	Handbrake valve	000 431 02 16	461 704 025 0
17	Brake cylinder	000 420 70 24	421 021 009 0
18	Brake force regulator	-	-
19	Two-way valve	-	-
20	Three-way valve	-	-
21	Overflow valve	001 429 53 44	434 100 122 0
22	Pressure reduction valve	-	-
23	Check valve	-	-

Unit Connection Designations According to DIN 74254 (draft)
Scope

This standard applies to air brakes on motor vehicles (including systems with hydraulic power transmission) and their trailers.

The designations should be provided both on the actual units next to the connection and in the brake diagrams next to the line connections shown there.

Designation

The designations consist of one or two digits. The meanings of the **first digit** are:

- 0 Intake connection
- 1 Power inflow
- 2 Power outflow (not for outflow to atmosphere)
- 3 Connection to atmosphere (for bleeding and venting)
- 4 Control connection (input to unit)

A second digit must be used whenever several similar connections, e.g. for several circuits, are possible or provided. It is good practice to start the **second digit** at 1, e.g. 21, 22, 23 etc. Several similar connections from one chamber should be given one and the same designation.

If a connection is able to perform several functions, it requires to be identified by two (first) digits, separated by a dash. Refer to example.

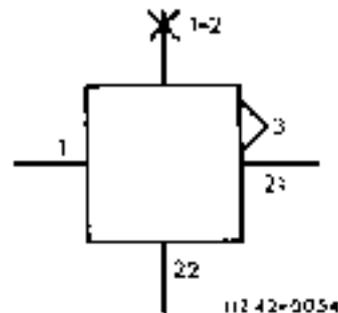
Example

Pressure regulator with charging and switching connections

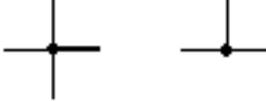
- 1 Power inflow from compressor
- 1-2 Power inflow for valve used to charge air brake system, or optionally power outflow for valve used to inflate tires.
- 3 Connection to atmosphere (for bleeding and venting)
- 21 Power outflow to accumulator (air tank)
- 22 Power outflow (switching connection)

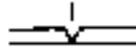
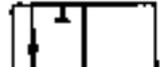
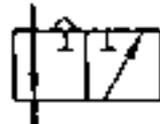
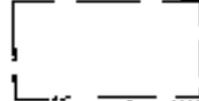
Designation	Symbol
Pressure source	
Power line	
Control line	
Pipe	
Electric line	
Line connector	
Line crossing	
Lever, rod, shaft	
Spring	
Muscular actuation	
a) General	
b) Button	
c) Lever	
d) Pedal	
Mechanical actuation	
a) Spring	
b) Button	

Designation	Symbol
Electrical actuation	
Pneumatic actuation	
a) Pressure rise	
b) Pressure drop	
Detent	
Pressure fluid designation	
a) Pneumatic	
b) Hydraulic	
Direction of flow	
<p>Valves with several fixed service positions (directional control valves) e.g. 2/2-way valve, 3/2-way valve etc.</p>	
<p>The number of squares corresponds to the number of service positions</p>	
<p>Within the squares, the lines indicate the actual lines and the arrows the directions of flow. Shutoffs are identified by means of crossing lines within the squares</p>	
<p>All other service positions are obtained by shifting the squares until the lines are aligned with the connections of the next square.</p>	
<p>A rectangle surrounded by a thin dash-dot line indicates several parts forming a block or assembly</p>	

Valves without fixed service positions

Valves which for a particular setting, are required to assume a number of intermediate positions between two end functions are represented by a plain square.



If, during a change in position, the inflow or outflow remains linked to a connection, the end of the arrow is provided with a crossing line which is left attached to the arrow when the square is relocated. The change in position is depicted in the same manner as for valves with several fixed positions so that the square, together with lines and arrows, is relocated at right angles to the connections.



Broken line = internal control path
(not an air line)

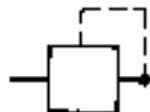

3/2-way valve means:
3 controlled ports
2 service positions

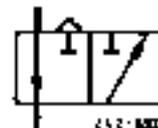

Survey

No	Designation
1	Compressor, pump and vacuum pump
2	Pressure regulator
3	Deflector
4	Protection valve
5	Power accumulator
6	Water separator and drier
7	Overflow valve
8	Check and shutoff valve
9	Warning light
10	Pressure switch, electric
11	Pressure gauge
12	Warning device, acoustic
13	Service brake valve
14	Parking brake valve
15	Brake valve, hand-operated
16	Relay valve
17	Trailer control valve for single-line brake system
18	Trailer control valve for dual-line brake system
19	Single-acting cylinder (hydraulic)
20	Single-acting cylinder (pneumatic)
21	Double-acting cylinder (pneumatic and hydraulic)
22	Double brake cylinder (pneumatic)
23	Brake booster
24	Pressure ratio valve
25	Pressure control valve
26	Brake pressure modulator, automatic
27	Brake servo unit
28	Non-return valve
29	Pressure reducing valve
30	Pressure limiting valve
31	(not yet specified)
32	Directional control valve with three positions
33	Directional control valve with two positions
34	Reservoir (hydraulic)
35	Counting head
36	Filter
37	Throttle valve
38	Pressure connection point
39	Bleed point
40	One-way restrictor
41	Directional control valve with three positions
42	Directional control valve with four positions
43	Air spring bellows
44	(not yet specified)
45	Directional control valve with two positions
46	Linkage

43.3 Symbols according to DIN 24 300 - Draft -

No.	Designation	Symbol
1 Compressor-pump and vacuum pump		
1.1	Single-cylinder-compressor	
1.2	Two-cylinder-compressor	
1.3	Vacuum pump	
1.4	Compressor hand operated	
1.5	Hydraulic pump (with 1 delivery direction)	

UZ 43-0147

2 Pressure regulator

2.1	- with combined filling and withdrawal connection and with switch connection	
2.2	- with combined filling and withdrawal connection	
2.3	- without additional connections	

UZ 43-0150

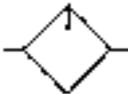
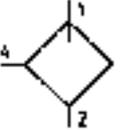
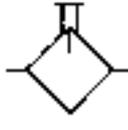
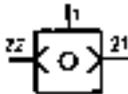
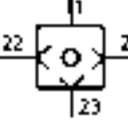
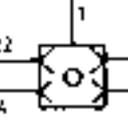
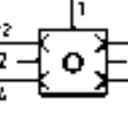
No	Designation	Symbol
3 Antifreeze pump		
3.1	with wick	
3.2	-, automatic with control connection	
3.3	-, hand operated	
UZ43-0151		
4 Safety valve		
4.1	Dual-circuit -	
4.2	Three-circuit	
4.3	Four circuit - with 5 connections	
4.4	Four circuit - with 7 connections	
UZ43-0152		

43.3 Symbols according to DIN 24 300 – Draft –

No.	Designation	Symbol
5 Energy collector		
5.1	Single-chamber-compressed air reservoir (DIN 74 291)	
5.2	Double-chamber-compressed air reservoir (DIN 74 291)	
5.3	Triple-chamber-compressed air reservoir (DIN 74 291)	 <p data-bbox="963 1245 1257 1301">Vessels may be arranged at random</p>
5.4	Single-chamber-vacuum reservoir	
5.5	Hydraulic reservoir	 <p data-bbox="1241 1794 1353 1816">J243-1153</p>

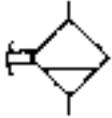
No.	Designation	Symbol
6 Water separator and drier		
6.1	Water separator hand operated	
6.2	Water separator with automatic drainage and control connection	
6.3	Water separator with automatic drainage	
6.4	Drier	

U 744-0154

7 Overflow valve

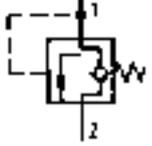
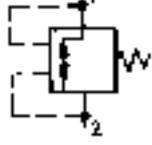
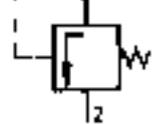
7.1	with return flow (DIN 74 279)	
7.2	with limit return flow (DIN 74 279)	
7.3	without return flow (DIN 74 279)	

U 241-0155

43.3 Symbols according to DIN 24 300 – Draft –

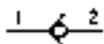
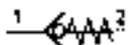
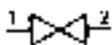
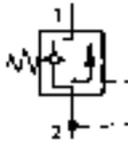
No.	Designation	Symbol
8 Non return and shut-off valve		
8.1	Non return valve	
8.2	Non return valve with counter pressure-spring	
8.3	Shut-off valve (DIN 74 203)	
8.4	Non return valve with limited return flow	 U 743=0156
9 Signal lamps (DIN 40 708)		
9.1	- red	
9.2	- white	
9.3	- brake light	
9.4	- green	
9.5	- yellow	
		U 243=0157

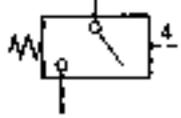
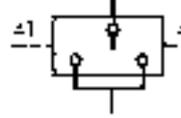
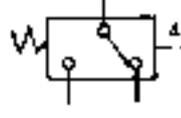
No.	Designation	Symbol
10 Pressure switch electric		
10.1	Off switch	
10.2	On switch	
10.3	Differential pressure switch	
10.4	Setpoint switch	

0243-0158

11 Pressure gauge

11.1	Single	
11.2	Double	

0243-0159

43.3 Symbols according to DIN 24 300 – Draft –

No.	Designation	Symbol
12 Signal generator, acoustic		
12.1	Buzzer (DIN 40 708)	
12.2	Horn (DIN 40 717)	

11743-0160

13 Service brake valve

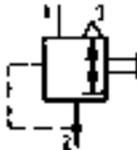
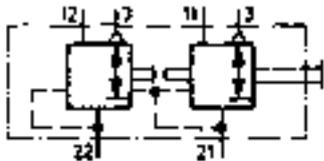
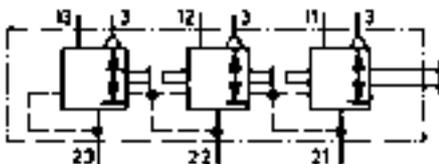
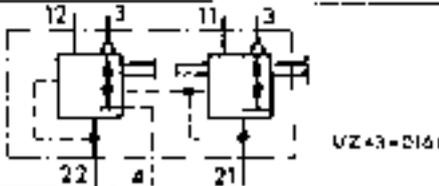
13.1	Single circuit	
13.2	Dual circuit	
13.3	Three-circuit	
13.4	Dual-circuit with ALB-regulation	

VZ 43-0161

No.	Designation	Symbol
14 Parking brake valve		
14.1	- for spring type (stepped)	
14.2	- for spring type (stepped) and trailer control valve (EC)	
14.3	- for spring type (stepped) and lrus stop brake	
14.4	- for spring type (stepped) with pressure limiter at outlet	
14.5	- for spring type, not stepped auxiliary brake stepped	
14.6	- for spring type with linkage actuation	
14.7	- for spring type (stepped) and additional valve (UK)	
14.8	- for spring type (stepped) and additional valve	

u243-0162

43.3 Symbols according to DIN 24 300 – Draft –

No.	Designation	Symbol
14.9	- for spring type (stepped) and trailer control and additional valve	

15 Stop brake valve

15.1	Stop brake valve	
15.2	Stop brake valve with pressure limiter at the exit	

16 Relay valve

16.1	admitting	
16.2	exhausting (control valve France)	
16.3	- admitting and with additional lever actuation	
16.4	- admitting and hydraulically controlled	

No	Designation	Symbol
17 Trailer control valve for single-line-brake system		
17.1	–, controlled with pressure limiter at outlet	
17.2	– controlled with pressure limiter at outlet and additional lever actuation	
17.3	–, controlled, without pressure limiter at outlet	
17.4	– controlled without pressure limiter at outlet and additional lever actuation	
17.5	–, hydraulically controlled with pressure limiter at outlet and additional lever actuation	
17.6	–, power controlled, without pressure limiter at outlet, pull actuated	
		UZ 43-01/03
18 Trailer control valve for dual-line-brake system		
18.1	–, three-circuit actuated (admitting and exhausting)	
		U 243-01/04

43.3 Symbols according to DIN 24 300 – Draft –

No	Designation	Symbol
18.2	-, dual circuit actuated (admitting)	<p>The symbol shows a rectangular box representing a valve. On the left side, there are two input ports labeled 41 and 42, each with a triangle pointing towards the box. On the top side, there are two ports labeled 3 and 11. On the bottom side, there is one port labeled 12. A dashed line on the right side indicates a connection to port 2.</p>
18.3	-, dual circuit actuated (admitting)	<p>The symbol is similar to 18.2, but it has an additional output port labeled 43 on the right side, with a triangle pointing away from the box. The other ports (41, 42, 3, 11, 12, 2) are the same as in 18.2.</p>
18.4	-, three-circuit actuated for truck (EC) (with breakaway device)	<p>The symbol is enclosed in a dashed rectangular box. It features a breakaway device symbol (a zigzag line) at the top. On the left side, there are two input ports labeled 41 and 42. On the right side, there are two ports labeled 21 and 22. On the bottom side, there is one port labeled 43. On the left side, there are also two ports labeled 3 and 12. A dashed line on the right side indicates a connection to port 2.</p>
18.5	-, three circuit actuated for articulated tractor unit (EC) (with breakaway device)	<p>The symbol is enclosed in a dashed rectangular box. It features a breakaway device symbol (a zigzag line) at the top. On the left side, there are two input ports labeled 41 and 42. On the right side, there are two ports labeled 21 and 22. On the bottom side, there is one port labeled 43. On the left side, there are also two ports labeled 3 and 12. A dashed line on the right side indicates a connection to port 2.</p>

UZ 43 = 01/16/1

No	Designation	Symbol
----	-------------	--------

19 Single-acting cylinder (hydraulic system)

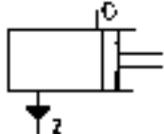
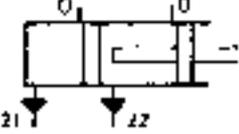
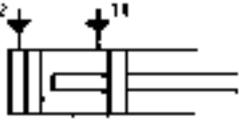
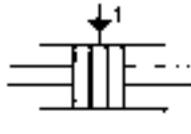
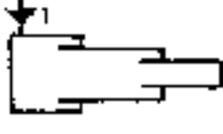
19.1	Master cylinder single-circuit	
19.2	Slave cylinder single-circuit	
19.3	Master cylinder dual-circuit	
19.4	Slave cylinder dual-circuit	
19.5	Wheel brake cylinder	
19.6	Telescopic cylinder	

UZ 43-0167

20 Single-acting cylinder (pneumatic system)

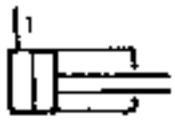
20.1	Single-circuit piston cylinder	
------	--------------------------------	---

UZ 43-0168

43.3 Symbols according to DIN 24 300 – Draft –

No.	Designation	Symbol
20.2	Single-circuit diaphragm cylinder	
20.3	Dual-circuit piston cylinder	
20.4	Spring-type brake cylinder, pressing	
20.5	Spring-type brake cylinder, pulling	
20.6	Dual-circuit diaphragm cylinder	
20.7	Telescopic cylinder	

UZ 43-01A8/1

21 Dual-acting cylinder (pneumatic and hydraulic system)

21.1	with piston rod on both sides	
21.2	- with piston rod on one side	

UZ43-01A9

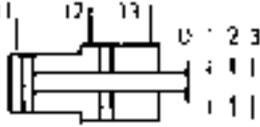
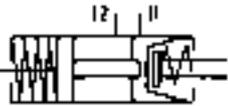
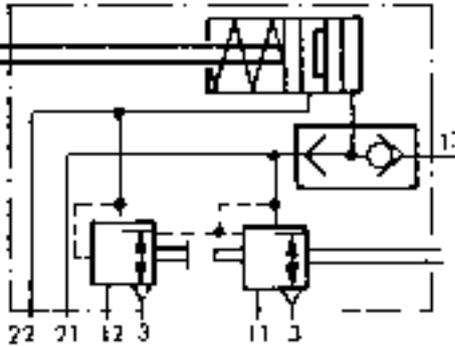
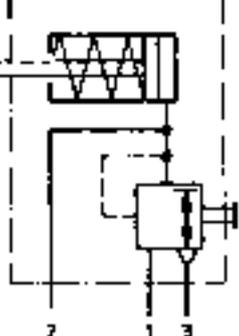
Nr	Designation	Symbol
21.3	4-position cylinder	 <p style="text-align: right;">UZ 43-0169/1</p>
22 Combined cylinder (pneumatics)		
22.1	Diaphragm-spring type brake cylinder with mechanical release device	 <p style="text-align: right;">UZ 43-0192</p>
23 Brake booster (power brake)		
23.1	-, dual-circuit with shuttle valve	
23.2	-, single-circuit	 <p style="text-align: right;">UZ 43-0170</p>

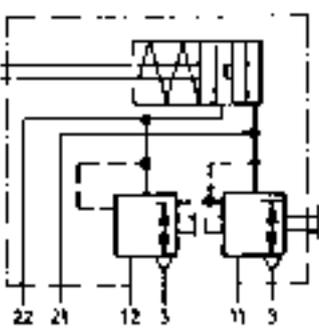
No.	Designation	Symbol
23.3	dual circuit	 <p style="text-align: right;">UZ 43-D120/1</p>

24 Pressure ratio valve

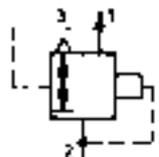
24.1	with special characteristic curve and bleed point	
24.2	- with special characteristic curve or bleed point	 <p style="text-align: right;">UZ 43-D191</p>

25 Pressure control valve

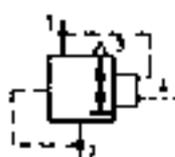
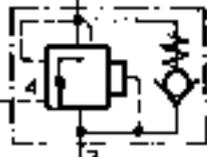
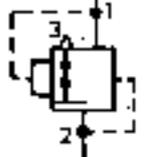
25.1	pneumatic	
25.2	-, with return flow	
25.3	-, Reduction valve	 <p style="text-align: right;">UZ 43-D171</p>

No.	Designation	Symbol
26 Brake pressure regulator, automatic		
26.1	- mechanically actuated for compressed-air brake	
26.2	- pneumatically actuated for compressed-air brake	
26.3	- mechanically actuated for hydraulic system	
26.4	- pneumatically actuated for hydraulic system	
26.5	- mechanically actuated with hydraulic control connection for pressure control	
26.6	- pneumatically actuated for continuous operating brake with 2 control connections (averaged pressure is modulated)	
26.7	- with relay valve	
26.8	- mechanically actuated for hydraulic system (tandem version)	

43.3 Symbols according to DIN 24 300 – Draft –

No	Designation	Symbol
27	Brake booster	
27.1	–, single-circuit (for auxiliary power brake, foot pressure fully applied)	
27.2	–, dual-circuit (for auxiliary power brake, foot pressure partially applied)	
27.3	– Vacuum single-circuit (for auxiliary power brake, foot pressure fully applied)	
27.4	– Vacuum single-circuit with additional cylinder (for auxiliary power brake, foot pressure fully applied)	

U243-0173

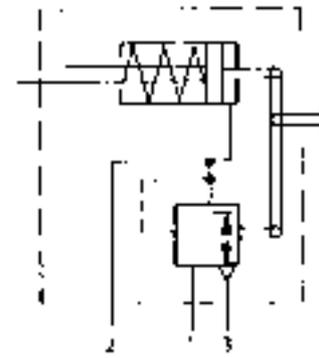
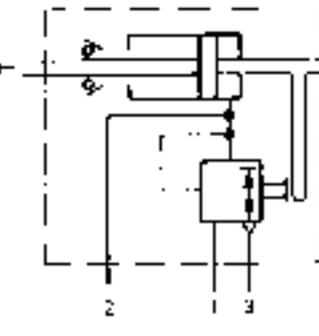
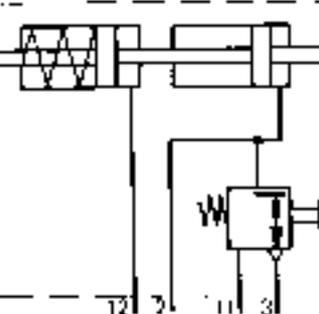
No.	Designation	Symbol
27.5	- single circuit (for auxiliary power brake, foot pressure partially applied)	
27.6	Handbrake booster (for parking brake)	
27.7	- single circuit with switchable additional cylinder (for auxiliary power brake, foot pressure fully applied)	

28 Non return valve

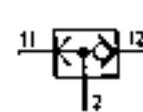
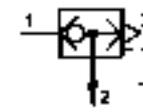
28.1	Shuttle valve	
28.2	Quick venting valve	

UZ43-0174

43.3 Symbols according to DIN 24 300 – Draft –

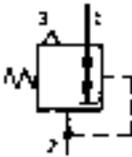
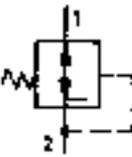
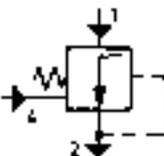
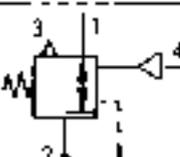
No	Designation	Symbol
29 Pressure regulating valve		
29.1	with bleed point	
29.2	- without bleed point (separator)	
29.3	- with control connection without cover opening	
29.4	- with control connection and bleed point	

UZ 43 - 0175

30 Pressure relief valve

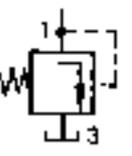
30.1	Safety valve	
30.2	Pressure relief valve	

UZ 43 - 0176

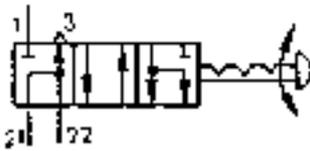
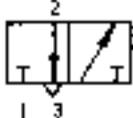
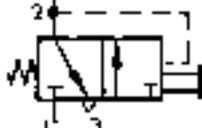
No.	Designation	Symbol
32 Directional control valve with 3 switch positions		
32.1	4/3-way valve, mechanically actuated	 <p data-bbox="1337 728 1458 748">UZ43-0177</p>
33 Directional control valve with 2 switch positions		
33.1	3/2-way valve	
33.2	Safety valve (Sweden)	 <p data-bbox="1337 1299 1458 1321">UZ43-0178</p>
34 Reservoir (hydraulic system)		
34.1	with connection below	 <p data-bbox="1337 1675 1458 1700">UZ43-0179</p>

43.3 Symbols according to DIN 24 300 – Draft –

No	Designation	Symbol
35 Coupling head		
35.1	- for truck brake [EC] (polarized without shut-off valve)	
35.6	- for 2-line brake [Pam-type] (brake and supply, without shut-off valve)	
35.2	- for articulated tractor unit supply [EC] (polarized with shut-off valve)	
35.3	- for articulated tractor unit brake [EC] (polarized with shut-off valve)	
35.5	- for 1-line brake (with shut-off valve)	
35.7	- for special version pneumatics, hydraulics (for tipper body, quick coupling)	
35.9	- for 1-line brake (with shut-off valve and 2/2-way valve)	
35.8	- Duplicate for 2 line brake (i.e., Italy, Sweden, Norway)	

UZ 43 - D180

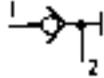
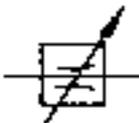
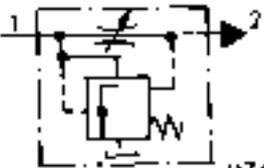
No.	Designation	Symbol
35.4	- for truck supply (EC) (polarized, with shut-off valve)	 <p data-bbox="1329 510 1476 537">UZ 43-018C/1</p>
36 Filler		
36.1	1 Line filter	 <p data-bbox="1361 891 1485 918">UZ 41-018D</p>
37 Throttle valve		
37.1	Throttle valve	
37.2	-, adjustable	
37.3	Control valve (connected in parallel)	 <p data-bbox="1385 1664 1497 1691">UZ 45-018E</p>

43.3 Symbols according to DIN 24 300 – Draft

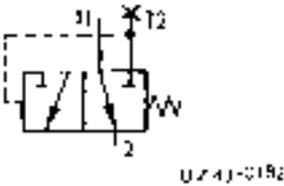
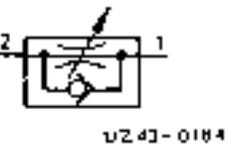
No.	Designation	Symbol
38 Pressure connection point		
38.1	Test connection Vg 8 (for pneumatics DIN 74 326)	
38.2	Test connection m 10 x 1.5 (for pneumatics DIN 74 326)	
38.3	Test connection m 18 x 1.5 (for hydraulics DIN 72 237)	
38.4	Test valve for pressure controlled ALB	
39 Bleeder point		
39.1	Bleeder point for hydraulics	
40 One-way restrictor		
40.1	One-way restrictor	
40.2	- adjustable	

Nr	Designation	Symbol
41 Directional control valve with 3 switch positions		
41.1	Height control valve	
UZ43-0145		
42 Directional control valve with 4 switch positions		
42.1	Relay valve single circuit for interchangeable bodies (4/4-way valve)	
42.2	Relay valve dual-circuit for interchangeable bodies (6/4-way valve)	
42.3	Height control valve with height limiter (4/4-way valve)	
42.4	Height control valve with height limiter and zero position adjustment (4/4-way valve)	
42.5	5/4-way valve	
42.6	6/4-way valve, hydraulic	
UZ43-0186		

43.3 Symbols according to DIN 24 300 – Draft –

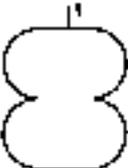
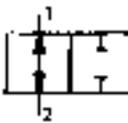
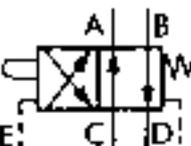
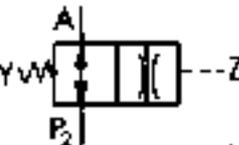
No.	Designation	Symbol
43 Pneumatic suspension bellows		
43.1	Tubular bellows	
43.2	Pleated bellows	
UZ 4.1 - 0187		
45 Directional control valve with 2 switch positions		
45.1	2/2-way valve	
45.2	4/2-way valve	
45.3	2/2-way valve with throttle	
UZ 4.1 - 0188		

No	Designation	Symbol
46 Linkages		
46.1	-, adjustable (divided)	
46.2	-, adjustable (undivided)	

q/243-0189

Brake Diagram

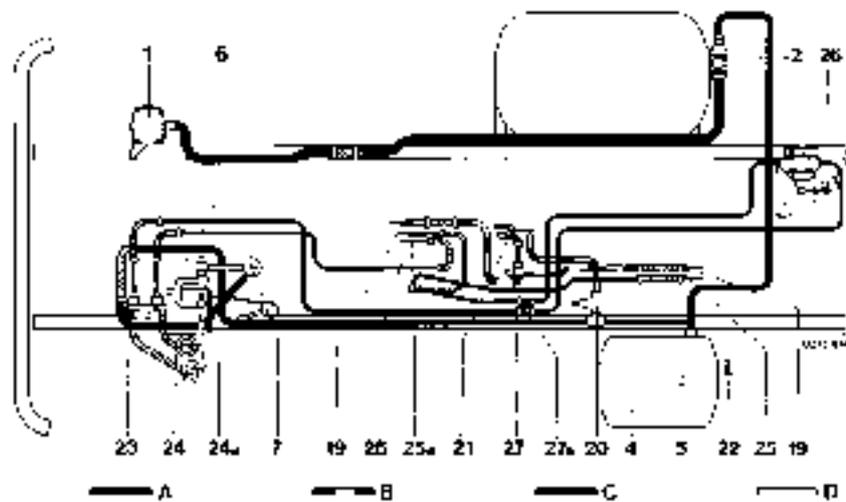

Dual-Circuit Hydraulic Brake Systems with Air Assistance

- | | | |
|--------------------------------|--|---------------------------------------|
| A Hydraulic brake line | 5 Directing valve | 24 Brake fluid reservoir (front) |
| B Air line, differential locks | 6 Air brake assembly | 24a Brake fluid reservoir (rear) |
| C Air supply line | 7 Double brake pressure gauge | 25 Hydraulic brake line (front) |
| D Air brake line | 10 Connection for differential lock | 25a Hydraulic brake line (rear) |
| 1 Air compressor | 20 Overload valve | 26 A/R modulator |
| 2 Pressure regulator | 21 Actuating valve for differential lock | 27 Test connection for A/R modulator |
| 4 Air tank | 22 Tire valance test connection | 27a Test connection for A/R modulator |
| | 23 Tandem master brake cylinder | |

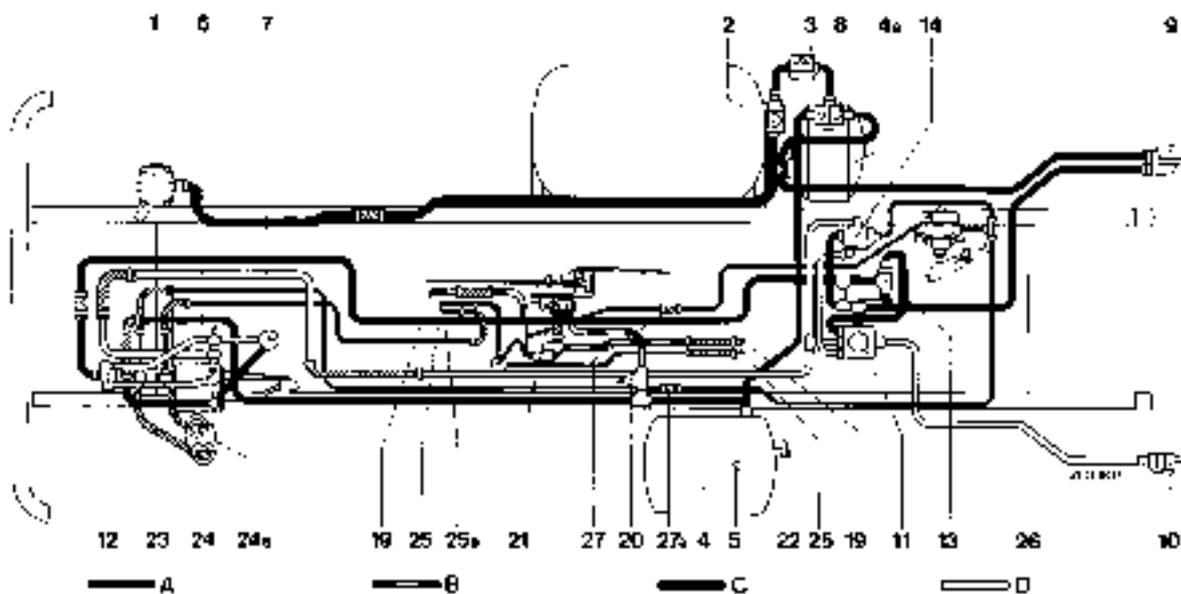

Dual-Circuit Hydraulic Brake System with Air Assistance and Air Control for Dual-Line Trailer Brake System

- | | | |
|--------------------------------|--|--|
| A Hydraulic brake line | 7 Double brake pressure gauge | 20 Directing valve |
| B Air line, differential locks | 8 Tandem master brake cylinder | 21 Actuating valve for differential lock |
| C Air supply line | 9 Coupling head for supply line (rear) | 22 Tire valance test connection |
| D Air brake line | 10 Coupling head to brake line (dual-line) | 23 Tandem master brake cylinder |
| 1 Air compressor | 11 Tandem control valve (aux-line) | 24 Brake fluid reservoir (front) |
| 2 Pressure regulator | 12 3/2-way valve | 24a Brake fluid reservoir (rear) |
| 4 Air tank | 13 Hydraulic valve | 25 Hydraulic brake line (front) |
| 4a Auxiliary air tank | 14 Hydrodynamic control valve | 25a Hydraulic brake line (rear) |
| 5 Air brake assembly | 15 Connection for differential lock, actuator, fuel and rear wheel | 26 A/R modulator |
| | 16 Directing valve | 27 Test connection for A/R modulator |
| | 17 Actuating valve for differential lock | 27a Test connection for A/R modulator |
| | 18 Tire valance test connection | |
| | 19 Tandem master brake cylinder | |
| | 20 Brake fluid reservoir (front) | |
| | 20a Brake fluid reservoir (rear) | |
| | 21 Hydraulic brake line (front) | |
| | 21a Hydraulic brake line (rear) | |
| | 22 A/R modulator | |
| | 23 Test connection for A/R modulator | |
| | 23a Test connection for A/R modulator | |

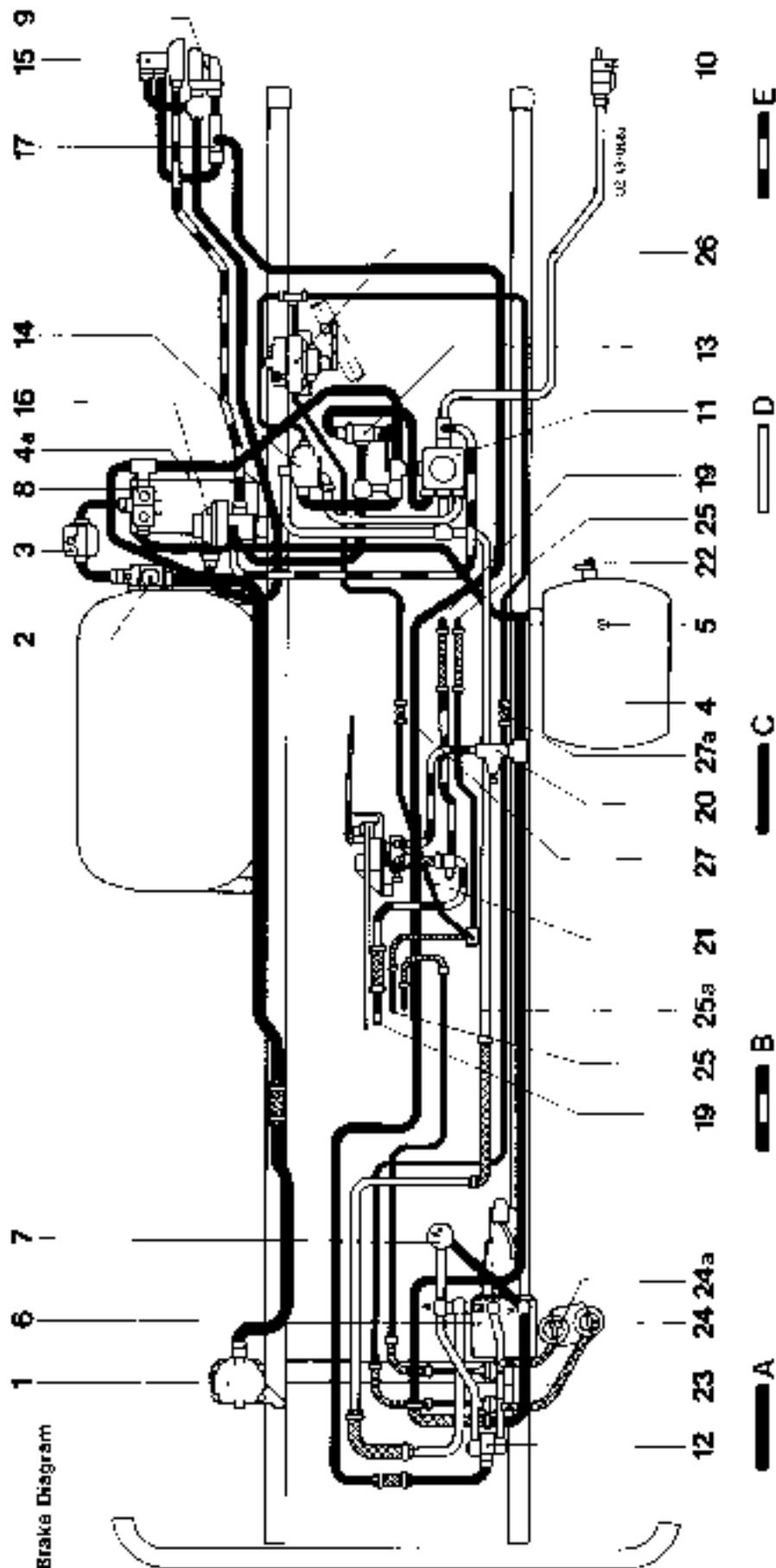

Hydraulic Dual-Circuit Brake System with Compressed Air Assistance and Compressed Air Control for Single- and Dual-Line Trailer Brake System

- | | | | |
|---|---|---|--|
| <ul style="list-style-type: none"> 1 Air compressor 2 Pressure regulator 3 Detector 4 Compressor control valve 5 Auxiliary compressed air tank | <ul style="list-style-type: none"> 6 Compressed air control valve 7 Brake air pressure gauge 8 Inverse check valve for valve 9 Coupling head for supply line (24) (1) 10 Coupling head for dual-line (24) (2) 11 Trailer control valve (24) (1-4) 12 9/2-way valve 13 Inverted valve 14 Proportional control valve 15 External hand supply line 16 Trailer valve (24) (1-4) 17 Pressure gauge | <ul style="list-style-type: none"> 18 2-way valve 19 Compressed air brake valve 20 Brake air pressure gauge 21 Inverse check valve for valve 22 Coupling head for supply line (24) (1) 23 Coupling head for dual-line (24) (2) 24 Trailer control valve (24) (1-4) 25 9/2-way valve 26 Inverted valve 27 Proportional control valve 28 External hand supply line 29 Trailer valve (24) (1-4) 30 Pressure gauge | <ul style="list-style-type: none"> 31 Connection through a hose to control unit and main valve 32 Control valve 33 Actuating valve for air brake lock 34 Two emergency connections 35 Inverse check valve for valve 36 6-1/2" air manual control valve 37 Brake air pressure gauge (1) 38 Brake air pressure gauge (2) 39 Hydraulic brake line (24) (1) 40 A/L indicator 41 Set connection for air line 42 Set connection for air line |
|---|---|---|--|

Brake Diagram

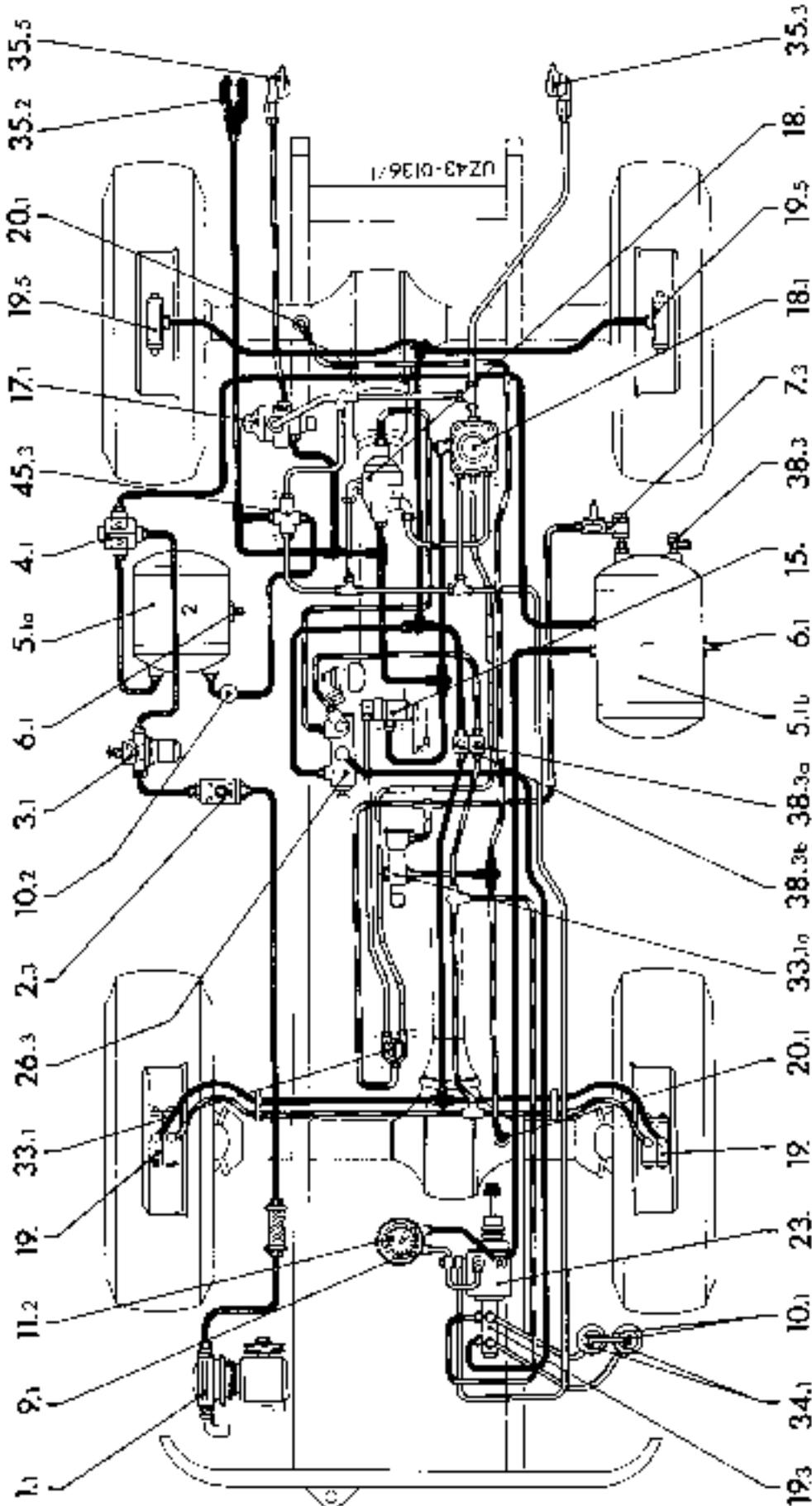

A B C D E F G

Hydraulic Dual-Circuit Brake with ALB Modulator and Compressed Air Assistance - Combined Single- and Dual-Line Trailer Brake System

- | | | | | | |
|-----|-------------------------|------|-------------------------------------|-------|-----------------------------------|
| 1.1 | Hydraulic brake circuit | 11.1 | Trailer control valve (single-line) | 35.3 | Control valve, emergency stop |
| 1.2 | Master brake control | 11.2 | Trailer control valve (dual-line) | 35.4 | Trailer control valve (dual-line) |
| 2 | Master brake control | 12 | Trailer control valve (dual-line) | 35.5 | Trailer control valve (dual-line) |
| 3 | Trailer control valve | 13 | Trailer control valve (dual-line) | 36.1 | Trailer control valve (dual-line) |
| 4 | Trailer control valve | 14 | Trailer control valve (dual-line) | 36.2 | Trailer control valve (dual-line) |
| 5 | Trailer control valve | 15 | Trailer control valve (dual-line) | 36.3 | Trailer control valve (dual-line) |
| 6 | Trailer control valve | 16 | Trailer control valve (dual-line) | 36.4 | Trailer control valve (dual-line) |
| 7 | Trailer control valve | 17 | Trailer control valve (dual-line) | 36.5 | Trailer control valve (dual-line) |
| 8 | Trailer control valve | 18 | Trailer control valve (dual-line) | 36.6 | Trailer control valve (dual-line) |
| 9 | Trailer control valve | 19 | Trailer control valve (dual-line) | 36.7 | Trailer control valve (dual-line) |
| 10 | Trailer control valve | 20 | Trailer control valve (dual-line) | 36.8 | Trailer control valve (dual-line) |
| 11 | Trailer control valve | 21 | Trailer control valve (dual-line) | 36.9 | Trailer control valve (dual-line) |
| 12 | Trailer control valve | 22 | Trailer control valve (dual-line) | 36.10 | Trailer control valve (dual-line) |
| 13 | Trailer control valve | 23 | Trailer control valve (dual-line) | 36.11 | Trailer control valve (dual-line) |
| 14 | Trailer control valve | 24 | Trailer control valve (dual-line) | 36.12 | Trailer control valve (dual-line) |
| 15 | Trailer control valve | 25 | Trailer control valve (dual-line) | 36.13 | Trailer control valve (dual-line) |
| 16 | Trailer control valve | 26 | Trailer control valve (dual-line) | 36.14 | Trailer control valve (dual-line) |
| 17 | Trailer control valve | 27 | Trailer control valve (dual-line) | 36.15 | Trailer control valve (dual-line) |
| 18 | Trailer control valve | 28 | Trailer control valve (dual-line) | 36.16 | Trailer control valve (dual-line) |
| 19 | Trailer control valve | 29 | Trailer control valve (dual-line) | 36.17 | Trailer control valve (dual-line) |
| 20 | Trailer control valve | 30 | Trailer control valve (dual-line) | 36.18 | Trailer control valve (dual-line) |
| 21 | Trailer control valve | 31 | Trailer control valve (dual-line) | 36.19 | Trailer control valve (dual-line) |
| 22 | Trailer control valve | 32 | Trailer control valve (dual-line) | 36.20 | Trailer control valve (dual-line) |
| 23 | Trailer control valve | 33 | Trailer control valve (dual-line) | 36.21 | Trailer control valve (dual-line) |
| 24 | Trailer control valve | 34 | Trailer control valve (dual-line) | 36.22 | Trailer control valve (dual-line) |
| 25 | Trailer control valve | 35 | Trailer control valve (dual-line) | 36.23 | Trailer control valve (dual-line) |
| 26 | Trailer control valve | 36 | Trailer control valve (dual-line) | 36.24 | Trailer control valve (dual-line) |
| 27 | Trailer control valve | 37 | Trailer control valve (dual-line) | 36.25 | Trailer control valve (dual-line) |
| 28 | Trailer control valve | 38 | Trailer control valve (dual-line) | 36.26 | Trailer control valve (dual-line) |
| 29 | Trailer control valve | 39 | Trailer control valve (dual-line) | 36.27 | Trailer control valve (dual-line) |
| 30 | Trailer control valve | 40 | Trailer control valve (dual-line) | 36.28 | Trailer control valve (dual-line) |
| 31 | Trailer control valve | 41 | Trailer control valve (dual-line) | 36.29 | Trailer control valve (dual-line) |
| 32 | Trailer control valve | 42 | Trailer control valve (dual-line) | 36.30 | Trailer control valve (dual-line) |
| 33 | Trailer control valve | 43 | Trailer control valve (dual-line) | 36.31 | Trailer control valve (dual-line) |
| 34 | Trailer control valve | 44 | Trailer control valve (dual-line) | 36.32 | Trailer control valve (dual-line) |
| 35 | Trailer control valve | 45 | Trailer control valve (dual-line) | 36.33 | Trailer control valve (dual-line) |
| 36 | Trailer control valve | 46 | Trailer control valve (dual-line) | 36.34 | Trailer control valve (dual-line) |
| 37 | Trailer control valve | 47 | Trailer control valve (dual-line) | 36.35 | Trailer control valve (dual-line) |
| 38 | Trailer control valve | 48 | Trailer control valve (dual-line) | 36.36 | Trailer control valve (dual-line) |
| 39 | Trailer control valve | 49 | Trailer control valve (dual-line) | 36.37 | Trailer control valve (dual-line) |
| 40 | Trailer control valve | 50 | Trailer control valve (dual-line) | 36.38 | Trailer control valve (dual-line) |
| 41 | Trailer control valve | 51 | Trailer control valve (dual-line) | 36.39 | Trailer control valve (dual-line) |
| 42 | Trailer control valve | 52 | Trailer control valve (dual-line) | 36.40 | Trailer control valve (dual-line) |
| 43 | Trailer control valve | 53 | Trailer control valve (dual-line) | 36.41 | Trailer control valve (dual-line) |
| 44 | Trailer control valve | 54 | Trailer control valve (dual-line) | 36.42 | Trailer control valve (dual-line) |
| 45 | Trailer control valve | 55 | Trailer control valve (dual-line) | 36.43 | Trailer control valve (dual-line) |

Circuit Diagram

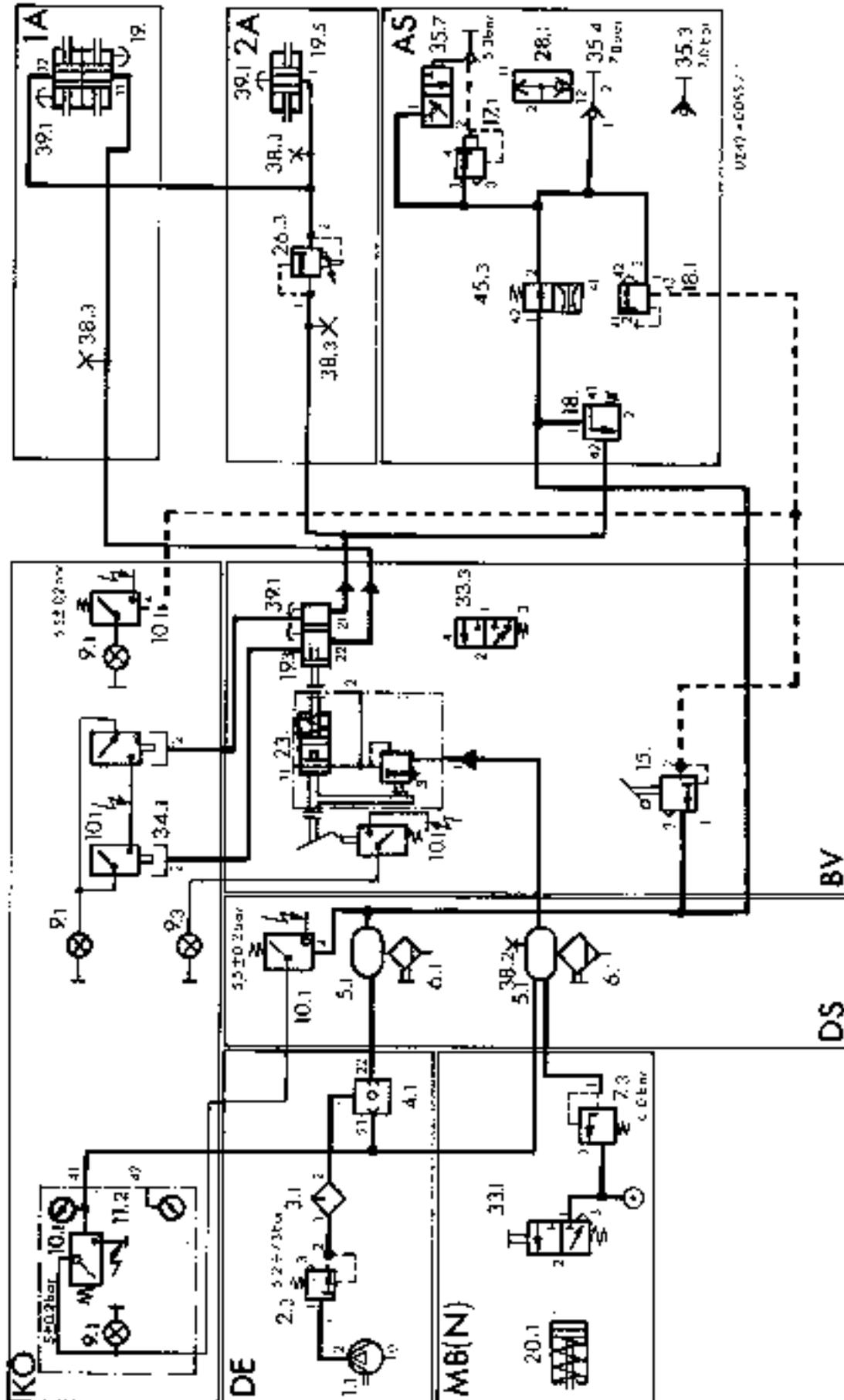

A ■ Hydraulics B □ Brake pressure C ■ Supply pressure

Hydraulic Dual-Circuit Brake with ALB Modulator and Compressed Air Assistance - Combined Single - and Dual-Line Trailer Brake System

43.3 General

SA 35 617

Key to 1.13/1

A Hydraulics
B Brake pressure
C Supply pressure

1. A - 1st axle
2. A - 2nd axle
AS = Trailer control
BV = Actuating valves
DS = Pressure reservoir
MD (N) = Engine brake
DR = Pressure generation
KU = Control switch

1.1 Air compressor
2.3 Pressure regulator
3.1 Defroster
4.1 Dual-circuit protection valve
5.1 Compressed air tank
6.1 Water separator
7.3 Overflow valve
9.1 Warning light, supply pressure
9.3 Brake light
10.5 Warning switch, brake fluid
11.2 Double pressure gauge
15 Handbrake valve
17.1 Trailer control valve (single-line)
18.1 Hydro-pneumatic control valve
18.2 Trailer control valve (dual-line)
19. Twin wheel brake cylinder
19.3 Tandem master brake cylinder
19.5 Wheel brake cylinder
20.1 Piston cylinder, differential lock
23. Compressed air brake booster
25.3 ALB modulator
28.1 Two-way valve
33.3 Control valve, differential lock
34.1 Brake fluid reservoir I and II
35.3 Coupling head, brake (dual-line)
35.4 Coupling head, supply (dual-line)
35.7 Coupling head (single-line)
35.2 Tire inflation/test connection
35.3 Test connection
39.1 Vent for hydraulic system
45.3 Breakaway valve, trailer brake

Function drawing

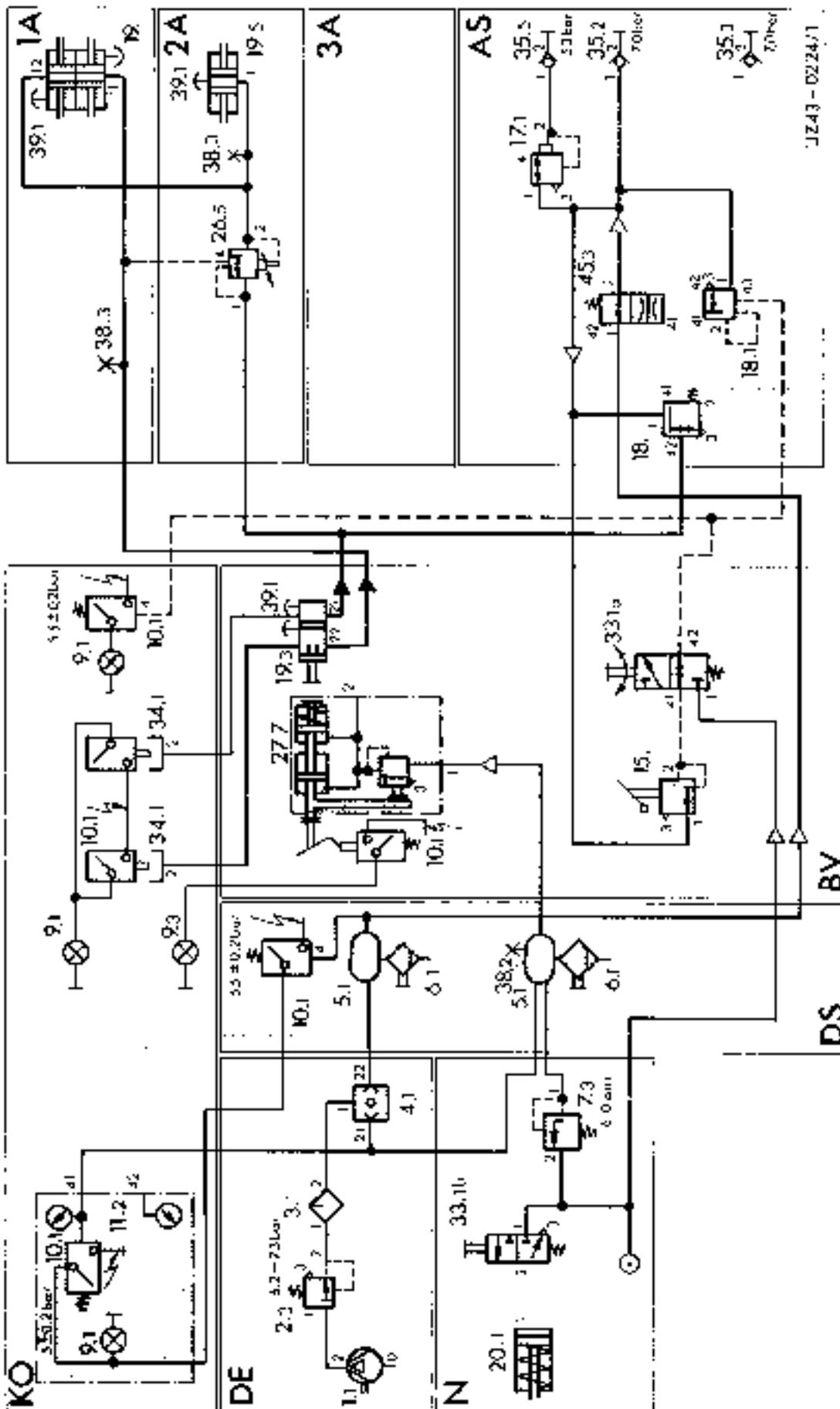

JZ43 - 0224/1

A B C D

Dual circuit hydraulic system with single circuit compressed air assistance. ALB at rear axle and 1/2 front axle, lever-type handbrake, single and dual-line trailer brakes.

Key to 1.13/3

A Hydraulic system

B Supply pressure

C Supply-control pressure

D Brake pressure

1 A First axle

2 A Second axle

AS Trailer control

BV Actuating valve

DS Accumulator

N Auxiliary consumer

DE Pressure generator

KO Inspection device

1.1 Air compressor

2.3 Pressure regulator

3.1 Air filter/dry pump

4.1 Dual circuit safety valve

5.1 Compressed air reservoir

6.1 Water separator

7.3 Overflow valve

9.1 Warning lamp

9.3 Braking light

10.3 Warning switch

11.2 Double pressure gauge

15. Handbrake valve

17.1 Trailer control valve (1-line)

18. Hydro-pneumatic control valve

18.1 Trailer control valve (2-line)

19. Twin-wheel brake cylinder

19.3 Tandem-master brake cylinder

19.5 Wheel brake cylinder

20.1 Piston cylinder, differential lock

27.7 Compressed air brake servo unit

26.5 ALB-regulator

33.1a Rotary knob valve, brake check

33.1b Switch valve, differential lock

34.1b Brake fluid reservoir circuit 1

34.1a Brake fluid reservoir circuit 2

35.2 Coupling head, supply (2-line)

35.3 Coupling head, brake (2-line)

35.5 Coupling head (1-line)

36.2 Tire inflation/test connection

36.2 ALB-test connection

39.1 Bleed point for hydraulic system

45.3 Breakaway valve, trailer brake

Pressure Regulator with Tire Inflation Connection

Operation

A coming from the compressor is forced via connection (2) through filter (3), inlet (4) via chamber (7) past check valve (13) into the line to the air tank. When the output pressure is attained, piston (11) is moved against spring (10). Breather (9) for chamber (7) is closed and intake (12) is opened. The pressure entering chamber (15) energizes the shut-off piston in open safety valve (1). The air compressor operates at no-load until pressure in chamber (8) drops below cut-in pressure. If this is the case, piston (11) returns, intake (12) is closed and chamber (15) evacuated. Safety valve (1) is closed and the air tank is filled.

To use tire inflation connection, unscrew cap (6). Valve (5) is opened when tire inflation hose is screwed on.

Note: For inflating tires, supply pressure must be below cut-in pressure 6.2 bar of pressure regulator.

Removal and Installation

- 1 Make system pressureless prior to starting
- 2 Loosen pipe connections of supply lines
- 3 Unscrew fastening bolts on bracket for pressure regulator
- 4 Remove pressure regulator
- 5 Reassembly takes place in the reverse sequence

Note: When reconnecting piping, use new sealing rings (fibre).

- 6 Check system for leaks (dab test points with soapy water)

Technical Data

Operating pressure			Thread connection	
Cut-out pressure	Cut-in pressure	Safety valve operates at bar	Air compressor	Compressed air tank
bar	bar		mm	mm
7.3 ± 0.2	6.2 p.ex. 6.6*	10 ± 1	M 22 x 1.5	M 22 x 1.5

* Pressure regulator without tire inflation connection

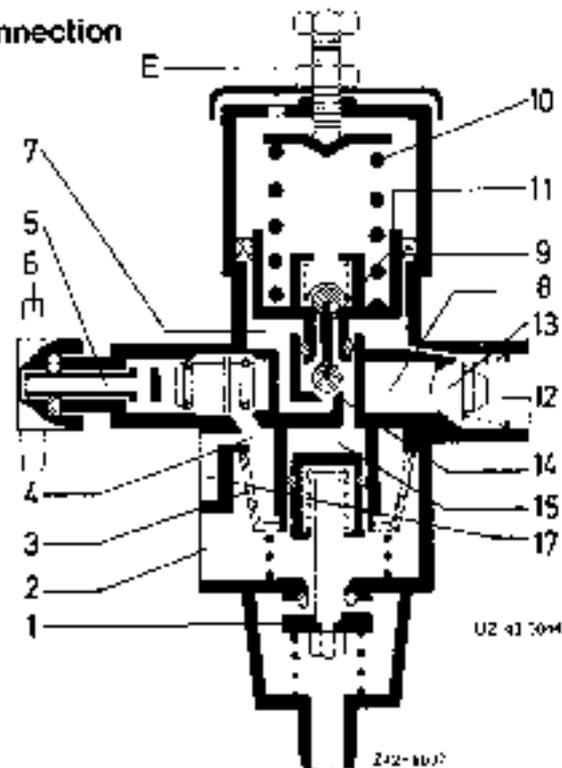

- | | |
|--------------------|---|
| 1 Safety valve | 6 Spring |
| 2 Compressor inlet | 11 Piston |
| 3 Filter | 12 Connection of tank |
| 4 Inlet | 13 Check valve |
| 5 Valve | 14 Tire |
| 6 Protective cap | 15 Chamber |
| 7 Chamber | 16 Connection point of hose and tire inflator |
| 8 Chamber | 17 Breather |

Disassembly, Inspection and Assembly

- 1 Clean unit externally (PB solution, compressed air)
- 2 Unscrew hose connection or filter housing after removing locking ring.
- 3 Remove filter element, carefully clean in Nitro N7 and re-install only when dry

Note: Apart from removing filter housing, further disassembly of pressure regulator is not required for cleaning filter element.

Unit should be replaced in preference to reconditioning in the event of any functional trouble or damage

Pressure Regulator without Tire Inflation Connection

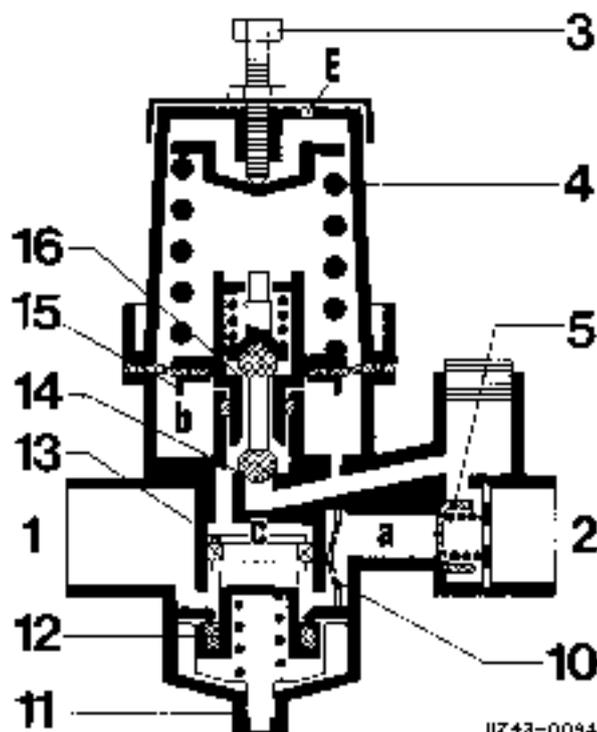

- | | |
|-------------------------|---------------------|
| 1 Connection | 12 Idle speed valve |
| 2 Connection to tank | 13 Piston |
| 3 Adjusting screw | 14 Inlet |
| 4 Compression spring | 15 Diaphragm piston |
| 5 Check valve | 16 Outlet |
| 10 Filter | E Breather opening |
| 11 Idle speed connector | |

Operation

Compressed air coming from compressor is forced via connection (1) through filter (10) into chamber a and check valve (5), past connection (2) into air tank.

Simultaneously, the pressure is built up in chamber b below diaphragm piston (15), which is moved upward against compression spring (4) when the cut-out pressure is reached.

Outlet (16) then closes and inlet (14) opens so that the compressed air in chamber b also flows into chamber c above piston (13). The subsequent downward movement of piston (13) opens idle speed valve (12). The air continuously supplied by the compressor can escape through the idle speed connector directly into the atmosphere. Piston (13) keeps idle speed valve (12) open due to the pressure still acting on the upper end in chamber c.

The air compressor continues operating at idle speed until the pressure in chamber b drops below the cut-in pressure of the pressure regulator due to the air consumed in the system. Diaphragm piston (15) is then pushed down again by compression spring (4). Inlet (14) closes and chamber c is evacuated via outlet (16) which opens as well as via breather opening E. The resulting relief of piston (13) closes idle speed valve (12) and the air tank is then filled up again to cut-out pressure.

Note: Tire inflation connector 000 431 14 3* is at the same time the test connection and is located on the compressed air tank.

Maintenance

Depending on operating conditions - normally every three months - remove filter (10) after taking off bottom of housing, carefully clean in Nitro N7 and reinstall only when dry. If the setting of the pressure regulator has changed, reset correct cut-off pressure 7.3 bar at adjusting screw (3).

Defroster

Part No.	Westinghouse Designation
000 431 21 15	432 198 010 0
000 431 26 15	432 198 030 0

Technical Data

Defroster	000 431 21 15	000 431 26 15
Oper. pressure max	10.0 bar	20.0 bar
Temperature range	-30° C to +70° C	-40° C to +90° C

Approved antifreeze:	Ethyl alcohol (fuel alcohol) or denatured alcohol
----------------------	---

Container capacity	200 cc
--------------------	--------

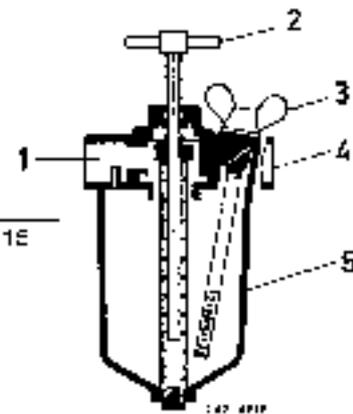

Defroster 00 431 21 15

- | | |
|-----------------------------------|------------------------------------|
| 1. Connection, pressure regulator | 4. Connection, compressed air tank |
| 2. Tommy handle | 5. Housing |
| 3. Dipstick | |

02 15004

Maintenance

For adding antifreeze and for checking the quantity of antifreeze still available – and in months free of frost – the rod is pushed with the Tommy handle against the throttle stop in housing and locked by turning 90°. The closing plug with dipstick is released and the antifreeze ethyl alcohol (fuel alcohol) is filled in. With the closing plug removed, a slight blowing-off caused by the pressure compensation bore is noticed. It is therefore recommended to use a funnel for filling,

which should be slightly raised so that air can escape from the container. The filter hole is then closed again, the rod is unlocked with the Tommy handle and moved into the antifreeze position. When in operation, the fluid level must be checked with the dipstick which has a mark to indicate the maximum permissible level. Completely drain contents at least once a year during the autumn inspection and renew. Check regularly after specified service intervals and top up, if necessary. Prior to start of frosty weather clean inner parts of antifreeze unit.

Compressed Air Tank

Removal and Installation

1. Make system pressureless
2. Unscrew pipeline from pressure regulator to tank.
3. Unscrew line to double pressure gauge and control valve.
4. Loosen exhaust pipe at rear on pipe clip and clamp at front and remove exhaust pipe.
5. Loosen clamps
6. Remove compressed air tank downward.
7. Re-install in the reverse sequence

Note: When reconnecting piping, use new seals (fibres)

8. Check system for leaks (dilat. test points with soapy water)

Inspection

Inspection essentially covers the following points:

1. General leak test (test pressure 9.0 bar in acc. with DIN 7428*)
2. No paint peeling off inside
3. No welding spots on tank.
4. Rating plate fitted
5. No dents or other external damage.

Note: A strict inspection should be made to eliminate any possibility of accidents caused by air brake failure. Do not exceed operating pressure of 7.3 bar.

Maintenance

Drain water from air tanks daily. The use of water drain valves is recommended, such valves are available for manual and for automatic operation.

Water Drain Valve

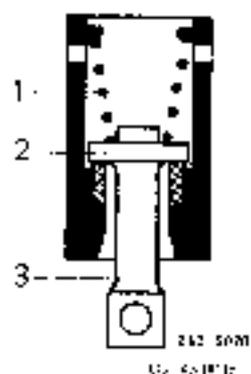

- 1. Spring
- 2. O-ring
- 3. Compression nut

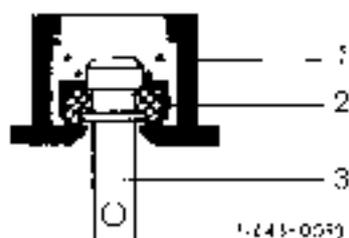

- 1. Spring
- 2. O-ring
- 3. Compression nut

Technical data	Fig. 1	Fig. 2
Part No.	004320207	004320807
Westinghouse Designation	43430-0000	034300010
Operating pressure in bar	6	20
Thread connection	M 22 x 1.5	

Installation Instruction

Water drain valve is screwed directly into bottom connection of tank and sealed by a compression and O-ring. To avoid risk of contamination from condensate, no equipment should be fitted below water drain valve.

Maintenance

The water drain valve does not require any special maintenance. In the event of contamination, unscrew from tank and clean.

Brake Booster

Part No.	Westinghouse Designation	
000 431 46 14	462 007 012 0	optional
000 431 74 14	462 007 042 0	optional

- 1 Stage 1
 2 Stage 2
 4 Outlet, collective
 M Outlet, individual
 7 MOC, body
 1 Backcheck pressure
 2 Control valve
 3 Plunger in master brake cylinder
 4 Breather
 5 Control pin

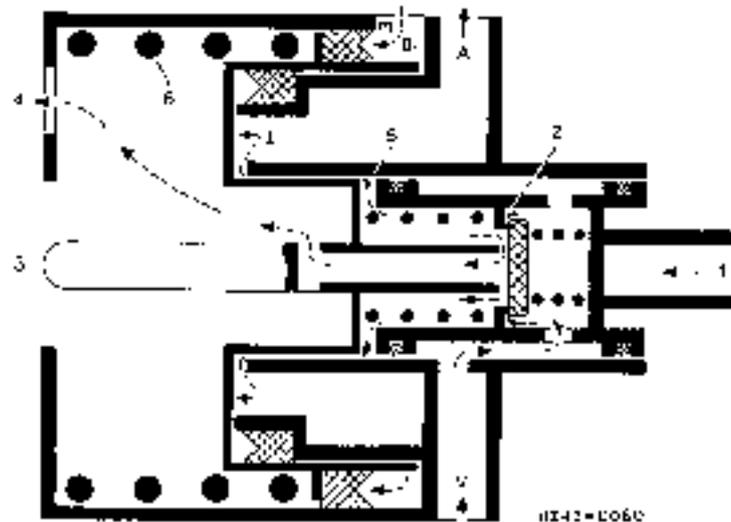

Brake Booster Diagram

Technical Data

Operating pressure max.	0.8 bar
Response pressure	0.4 bar
Volume of chambers I and II at max. stroke	0.6 l
Piston stroke	42 mm
Piston dia.	145 mm
Thread connection	M 18 x 1.5 15 deep

The pressure increase in chamber of stage 1 continues toward outlet A where the control line to changeover valve is connected to the end of the frame (must remain closed 3/2-way valve). If valve is closed, second stage M does not receive any overpressure via return line and remains vented, i.e. the pulling vehicle is braked with less overpressure than the trailer.

If the valve is not closed, the overpressure increase will also energize the second stage.

When the brake pedal pressure reduces, spring (6) pushes both piston members back into no-load position and the compressed air escapes from stage 2 via control line M-A and gap at (5) and (2) via breather bore (4) into the atmosphere.

If for any reason the compressed air vacuum does not operate, a slight increase in pedal pressure will actuate plunger (3) to the master brake cylinder as soon as piston (1) comes to rest at gap (6). Increased pedal pressure is required to overcome spring force (6).

Operation

If brake pedal pressure becomes effective at (1), the piston is displaced. After the piston has travelled 2.0–3.0 mm, valve (2) opens and permits compressed air coming from inlet connector V to enter chamber of stage 1. Previously, this valve had kept the passage toward breather (4) closed. This path becomes free only after the pedal pressure is released.

Installation Instructions

Brake pedal travel should always be long enough to ensure the minimum push-off travel is achieved so that in event of damage to hydraulic brake circuit the compressed air trailer line can be fully utilized. In the released position the clearance between

Brake Booster

the piston of the master hydraulic brake cylinder and the piston rod of the single-chamber brake booster **must be at least 1 mm** so that the compensating bore in the master cylinder is definitely open. The stroke of the master brake cylinder should never be less than that of the brake booster since otherwise damage would result to the inner parts of the master brake cylinder. When the brake is correctly adjusted, the piston stroke is approx. 1/3 of the specified total stroke.

Removal and Installation

- 1 Remove master brake cylinder
- 2 Loosen compressed air connections on brake booster
- 3 Booster is removed without disassembling brake pedal. The three fastening nuts are accessible from pedal end (pay attention to snap rings)

Partial Disassembly and Repair

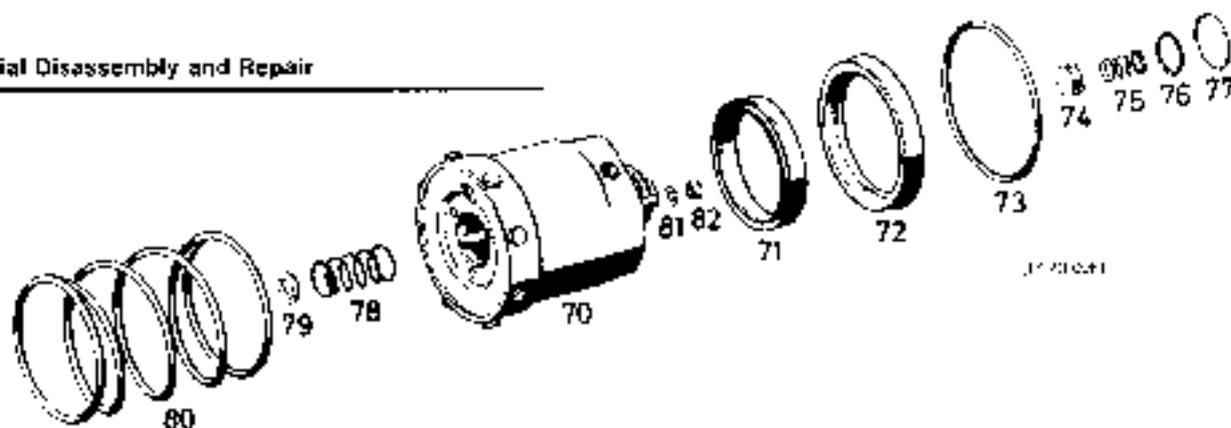

Spare parts for brake booster

- 1 Unscrew the eight fastening bolts M 8 for the cylinder base. (First mark position relative to housing)

Proceed carefully, since base is under spring pressure. If required, replace protective strainer in venting hole

- 2 Pull out entire piston group including plunger sleeve and sealing rings
- 3 Sleeve (71) can be pulled off and replaced

Clean internal parts only with ethyl alcohol!

- 4 Pull off large sleeve (72).
When assembling, this sleeve is introduced alone into housing which has previously been cleaned and slightly greased

- 5 Remove locking ring of control piston and pull thrust piece out of control piston (Pay attention to cord sealing ring)

6 Remove spring and valve disk or replace. No further disassembly is required. Return units with major damage to manufacturer for repairs

- 7 Assembly is performed in the reverse sequence after checking individual components. First grease sliding surfaces of sleeves with special grease.

Note: Ensure that inside paint coat is **not** damaged.

Regular bleeding of brake system is necessary to ensure that the brake booster operates properly

Trailer Control Valve, Air-Controlled

Part No.	Westinghouse Designation
GDG 431 70 05	471 200 112 0
GDG 431 71 05	471 200 113 0

Technical Data

Pressure drop in trailer control line at 1 bar in tractor brake system 2.0 – 2.5 bar

Trailer control line fully bled at tractor brake system pressure of 5.0 – 6.5 bar

Operating pressure max 7.35 bar

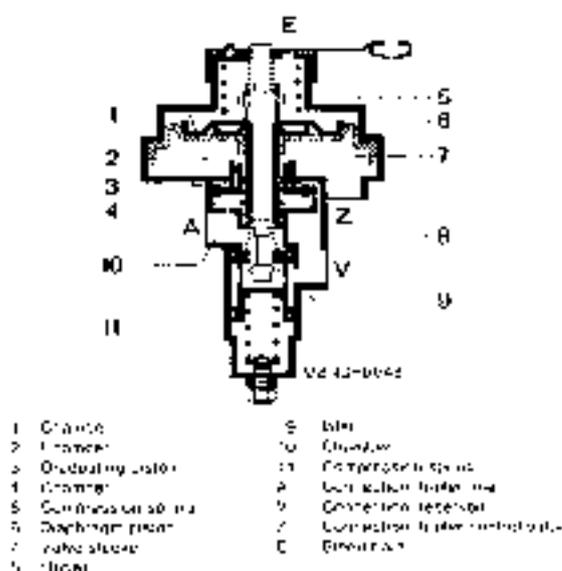

Trailer Control Valve

Removal and Installation

- 1 Make compressed air system pressureless.
- 2 Unscrew lines (3 off).
- 3 Force off actuating rod for handbrake at ball head after loosening locking clip.
- 4 Unscrew valve on bracket and remove.

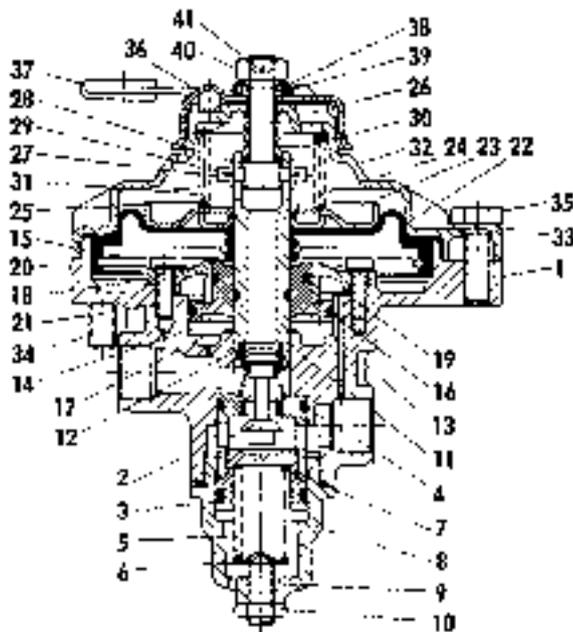
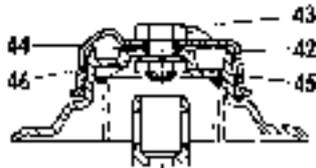

U2 45399

Air-Controlled Trailer Control Valve

- | | |
|-----------------------------|----------------------------|
| 1 Housing | 24 Locking ring 21 x 1.2 |
| 2 Seal O-ring 30 x 2.1 | 25 Diaphragm disk |
| 3 Seal | 26 Cap screw |
| 4 O-ring 20.2 x 3 | 27 Bolt 10 x 11 x 26 x 2.7 |
| 5 Compression spring** | 28 Washer 5 x 4 |
| 6 Cup spring | 29 Cuplock 10 x 8 |
| 7 Seal O-ring* | 30 Compression spring** |
| 8 Seal | 31 Compression spring** |
| 9 Seal 100 x 10 | 32 Cap |
| 10 Hexagon nut M 10 | 33 Spring 10 |
| 11 1-2 Valve tappet, hex 11 | 34 Hexagon nut M 10 x 20 |
| 12 Retaining* | 35 Bolt 10 |
| 13 O-ring 17 x 2.1* | 36 Hexagon nut M 10 x 36 |
| 14 Piston | 37 Bolt 10 |
| 15 O-ring 22.2 x 3* | 38 Lock screw** |
| 16 O-ring 4.2 x 3* | 39 Bolt 4.1* |
| 17 Locking ring 22 x 1.2 | 40 Retaining ring* |
| 18 Support | 41 Seal nut M 10 x 1 |
| 19 Spring ring | 42 Cap** |
| 20 Spring washer B C | 43 Hexagon nut M 10 x 10 |
| 21 Seal O-ring 6 x 1.5 | 44 Washer 10 x 5 |
| 22 Cup sleeve* | 45 Hexagon nut M 10 |
| 23 Diaphragm disk | 46 Snap ring 20 |

* Wear parts.
 ** These parts are suitable for use during repairs.

5 Reassembly is performed in the reverse sequence.

Note: Bleed trailer control line when handbrake reaches fourth detent. Adjustment is made by shortening or extending actuating rod between valve and handbrake intermediate lever.

(Reference dimension for adjustment: 115 mm between check nuts of actuating rod. Final adjustment depends on total of tolerances!)

6 Check system for leaks. (Dab test points with soapy water)

Note: Use only new sealing rings

Disassembly, Inspection and Assembly

- 1 Clean valve externally (P3 solution, compressed air)
- 2 Remove cotter pin on castle nut (handbrake lever end) and loosen castle nut.
- 3 Remove running ring with balls.
- 4 Remove lever.
- 5 Unscrew four hexagon bolts on housing and remove cover.

Note: Caution, cover is under spring pressure

- 6 Remove spring.
- 7 Remove cap screw. For this purpose, remove cotter pin, washer and bolt.
- 8 Remove large diaphragm disk, loosen locking ring, remove small diaphragm disk and remove cup sleeve
- 9 Unscrew exposed socket head bolts
- 10 Remove support with sealing rings and valve tappet.
- 11 Remove valve tappet from support
- 12 Unscrew cap.
- 13 Remove compression spring and spring disk.
- 14 Remove valve from housing
- 15 Check all parts for wear and replace, if necessary
- 16 Assembly takes place in the reverse sequence.

Trailer Control Valve (1-Line)

Part No.	Westinghouse Designation
000 431 49 05	471 200 008 0

Technical Data

Operating pressure and test pressure	bar 7.35
Pressure reduction for trailer	bar 5.2 + 0.2
Pressure drop at connection (A) with 1.0 bar at connection (Z)	bar 2-2.5
Pressure at connection (A) 0 bar with gauge pressure at connection (Z)	bar 5-5.5
Thread size	M 22 x 1.5

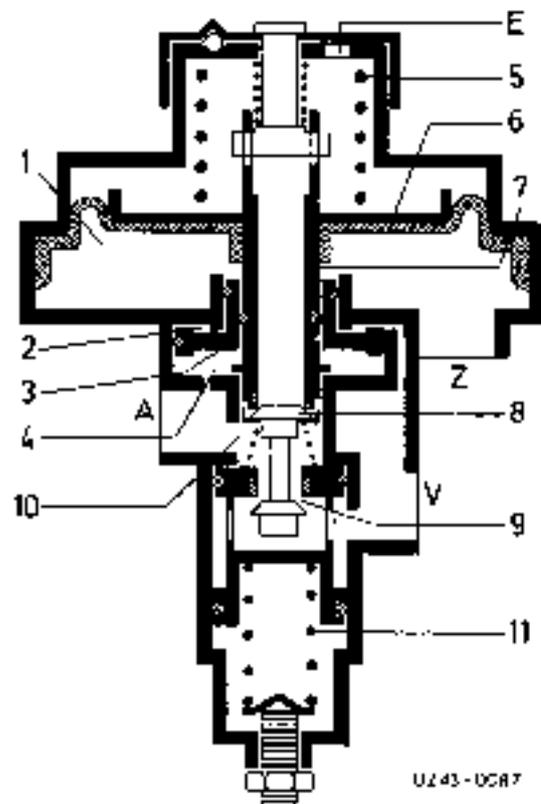

- | | |
|-----------------------|--|
| 1. Liner | 2. Nut |
| 2. O-ring | 10. O-ring |
| 3. Ground up piston | 11. Compression spring |
| 4. O-ring | A. Compression brake piston |
| 5. Compression spring | V. Lubrication connection |
| 6. O-ring | Z. Gauge inlet (gauge) tank to trailer |
| 7. Valve stem | E. Breather |
| 8. O-ring | |
| 9. O-ring | |

Trailer Control Valve (2-Line)

Part No.	Westinghouse Designation
000 431 37 05	073 002 402 0

Technical Data

Operating pressure max.	8.0 bar
Gauge pressure in trailer brake line (connection 2) at operating brake pressure (connection 4) of 1 bar	1.0 bar
Adjusting range of lead max.	1.0 bar
Thread of line connections	M 16 x 1.5 - 12 (deep)

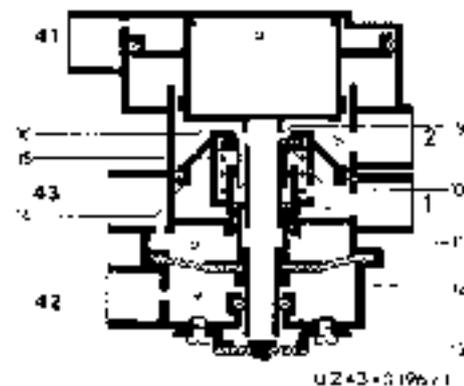

- | | |
|---------------------------|---------------------|
| 1. Seal | 16. Seal |
| 2. Trailer brake | 17. Adjusting screw |
| 3. Gauge (pressure) inlet | |
| 4. Gauge (pressure) inlet | |
| 5. Gauge (pressure) inlet | |
| 6. Hose end | |
| 7. Piston | |
| 8. Compression spring | |
| 9. O-ring | |
| 10. O-ring | |
| 11. Piston | |
| 12. O-ring | |
| 13. O-ring | |
| 14. Piston | |
| 15. Piston | |
| 16. Seal | |
| 17. Adjusting screw | |

43.3 Control Equipment

Shutoff Valve

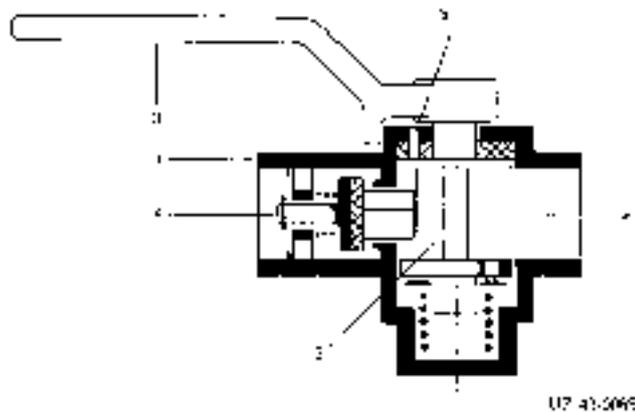

- 1 Housing
- 2 Camshaft
- 3 Handle
- 4 Valve
- 5 Evacuation

Part No

000 429 10 31
000 429 14 31

Westinghouse Designation

452 002 007 0
452 002 107 0

Technical Data

Operating pressure max	8 bar
Version	Handle deflects 90° in both directions
Thread connection	M 22 x 1.5

Installation Instructions

The shutoff valve is located in front of the rear coupling head of tractor unit. Observe flow rate (direction of arrow). Install in such a manner as to ensure access to and operate of handle.

Disassembly, Inspection and Assembly

(Shutoff valve removed;

- 1 Clamp shutoff valve in vice (input connection on top).
- 2 Unscrew guide nut for valve stem and remove valve assembly.
- 3 Change position of housing in vice (bottom closure up).
- 4 Unscrew closing plug (pay attention to sealing ring), remove spring.
- 5 Change position of housing in vice (handle up).
- 6 Force cross pin out of handle and knock camshaft out in downward direction including sealing washer.
- 7 Clean all parts, replace damaged parts.
- 8 Assembly takes place in the reverse sequence. Slightly grease all parts first.

Coupling head (1-line)

Part number	Westinghouse designation
000 429 27 30	133 986 09 E
000 429 28 30 optional	452 200 004 0

Technical data

Working pressure max.	8,0 bar
Complies with standard	A DIN 74 294

Maintenance

The coupling head needs no special maintenance. When coupling up ensure that the sealing surfaces are clean and close correctly. Damaged sealing rings are to be replaced.

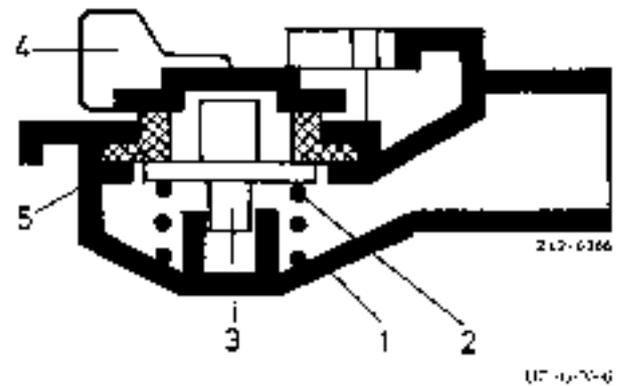

- | | |
|------------|------------------|
| 1. Housing | 4. Closing cone |
| 2. Spring | 5. Coupling ring |
| 3. Valve | |

Coupling head (1-line)

Part number	Knorr designation
000 429 48 30	KU 41 09

Technical data

Service overpressure max.	8,0 bar
---------------------------	---------

Maintenance

The coupling head needs no special maintenance. When coupling up ensure that the sealing surfaces are clean and close correctly.



IKR 43-00161

Installation instructions

Pointing in direction of travel, the coupling head is positioned to the right of the trailer coupling so that the opening points to left.

Coupling head automatic (1-line)

Part number	Westinghouse designation
00 429 68 30	452 303 0110

Technical data

Working pressure max.	8,0 bar
Thread connection	M22 x 1,5

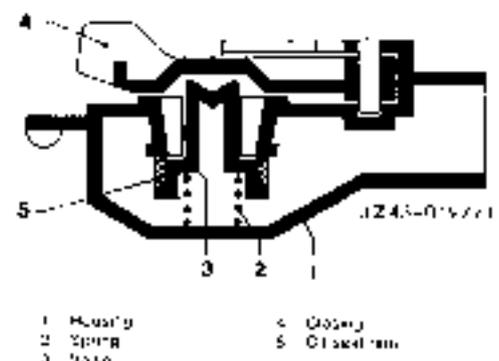

- | | |
|------------|------------------|
| 1. Housing | 4. Closing cone |
| 2. Spring | 5. Coupling ring |
| 3. Valve | |

Coupling head (2-line) with valve

Part number	Westinghouse designation *1)
000 429 80 30	952 200 221 0 Supply line
000 429 81 30	952 200 222 0 Brake line

Technical data

Working pressure max. 10 bar
 Threaded connector M 16 x 1.5

Supply line **Brake line**

Maintenance

When coupling up, ensure that the sealing surfaces which touch are clean. Damaged sealing rings are to be replaced.



*1 Bosch coupling heads may also be used optionally.

Coupling head (2-line) with valve and two connections

Part number	Westinghouse designation
000 429 78 30	952 200 2100



Supply line



- 1 Connection
- 2 Connection

UZ43-0207/1

*1 Bosch coupling heads may also be used optionally.

Technical data

Working pressure max. 10 bar
 Threaded connection M 16 x 1.5

Maintenance

When coupling up, ensure that the sealing surfaces which touch are clean. Damaged sealing rings are to be replaced.

Pressure Control Valve

Part No.	Westinghouse Designation
000 429 14 44	434 406 000 0

Technical Data

Operating pressure max.	5.0 bar
Free passage max.	12 mm dia. = 1.13 cm ²
Opening pressure	4.5 ± 0.2 bar
Closing pressure	4.0 ± 0.3 bar
Thread Connection	M 22 x 1.5

Installation Instructions

Install pressure control valve with adjusting screw pointing downward.

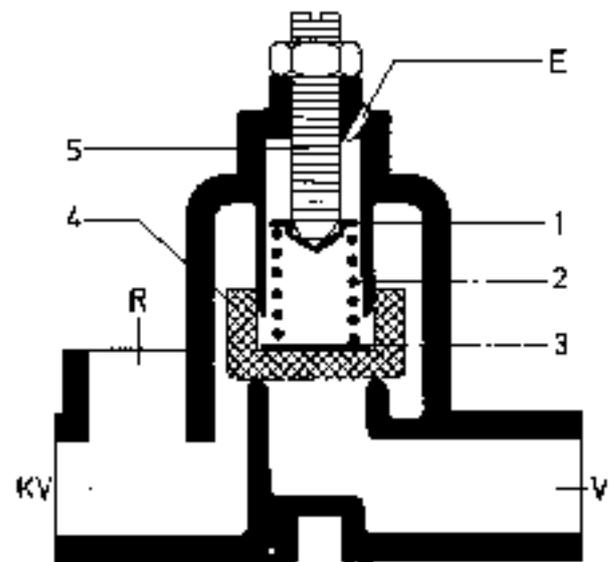

UZ-6034
LZ 42/008

- | | | | | | | |
|----------------------|----------------------|-----------------------|---------------|-------------------|----------------------|--------------|
| 1 Valve body | 2 Spring | 3 Spring plate | 4 Bleed | 5 Adjusting screw | 6 Conical valve seat | 7 Bleed hole |
| 8 Conical valve seat | 9 Conical valve seat | 10 Conical valve seat | 11 Bleed hole | | | |

Relay Valve

Part No.	Westinghouse Designation
000 429 64 44	473 910 000 0
000 429 66 44	473 011 000 0
001 429 21 44	473 017 000 0

Technical Data

Operating pressure max.	8.0 bar
Response range	0.2 - 0.4 bar
Nominal width	15 mm
Thread connection	M 22 x 1.5 - 14 deep

Installation Instructions

The relay valve must be installed close to coupling head so that trailer brake lines to be charged with air are as short as possible. The valve must be connected to the handbrake linkage and can be arranged vertically (bleed hole downward) or horizontally.

If required, the handbrake lever of the valve can be moved out of the basic position into two additional starting positions by swivelling 120° in each case.

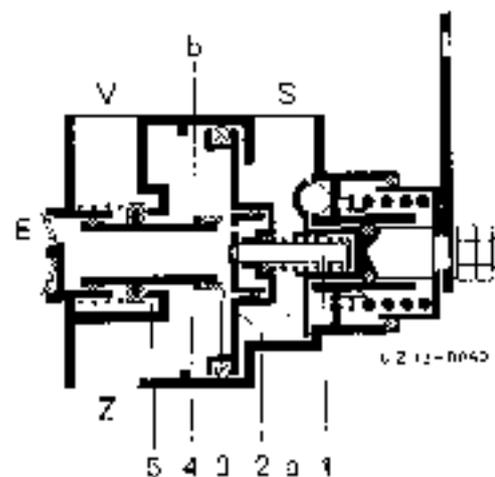

UZ 12-0040

- | | | | |
|-------------------|----------------------|-------------------|-------------------|
| 1 Valve body | 2 Trailer brake line | 3 Coupling head | 4 Handbrake |
| 5 Handbrake lever | 6 Handbrake lever | 7 Handbrake lever | 8 Handbrake lever |

Connections:

- | |
|----------------------|
| 1 Coupling head |
| 2 Trailer brake line |
| 3 Handbrake |

Handbrake Valve (Dual-Line)

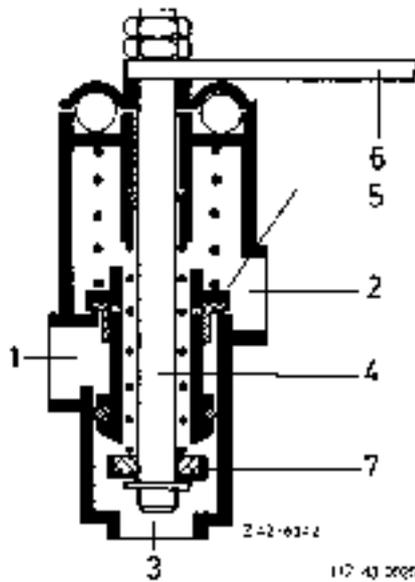

- | | |
|--|---------------|
| 1 Connection compressed air line | 4 Valve rod |
| 2 Connection relay valve or trailer brake line | 5 Brake cone |
| 3 Round lock | 6 Lever |
| | 7 Outlet cone |

Part No.	Westinghouse Designation
000 430 30 81	461 702 001 0

Technical Data

Operating pressure max	8,0 bar
Nominal width	12 mm \varnothing 113 mm ²
Thread connection	M 22 x 1,5 - 12 deep

Installation Instructions

Valve is installed in brake line toward relay valve as through valve and connected to handbrake linkage.

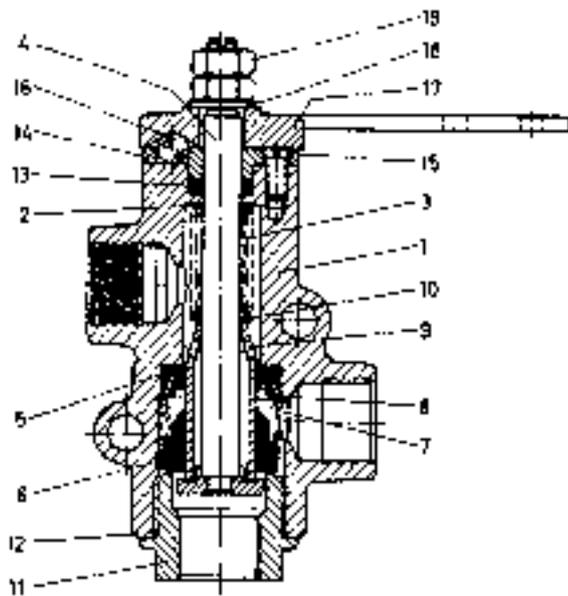

- | | |
|-------------------------|-----------------------------|
| 1 Housing comp | 11 O-Ring |
| 2 Washer | 12 Round conding 25 x 11 |
| 3 Compression spring** | 13 Round conding 9.5 x 2.5* |
| 4 Piston rod | 14 O-Ring** |
| 5 Slot ring 18 x 4 x 6* | 15 Hexagon nut M 5 x 12 |
| 6 Piston | 16 Anti-slag filter |
| 7 Compression spring** | 17 Lever** |
| 8 Slingshot valve | 18 Washer O-R |
| 9 Piston | 19 Hexagon nut M 8 |
| 10 Washer | |

* Also parts
 ** These parts should be replaced during repairs

Disassembly, Inspection and Assembly

- 1 Clean valve externally (P 3 solution, compressed air).
- 2 Clamp valve in vice (handbrake lever up)
- 3 Unscrew check nut and hexagon nut and remove lever.
- 4 Change position of valve in vice
- 5 Unscrew cap.
- 6 Pull out with rod with compression spring (large), valve, piston and compression spring (small)
- 7 Remove slot ring with supporting ring from housing
- 8 Check parts and, if necessary, replace.
- 9 Re-assembly takes place in the reverse sequence.

Handbrake Valve (Dual-Line)

Part No.	Westinghouse Designation
000 431 02 18	461 764 025 0

Technical Data

Operating pressure max.	7.5 bar
Transmitted pressure max.	4.5 ± 0.5 bar
Nominal width	8 mm
Thread connection	M 22 x 1.5 - 12 deep

Installation Instructions

Handbrake valve is installed as a through-valve in brake line toward relay valve and is connected to handbrake linkage via a brake cylinder.

A pipe or hose may be connected at connection E (bleed hole) to dissipate the air escaping when releasing the brake directly into the atmosphere to prevent any noise disturbance.

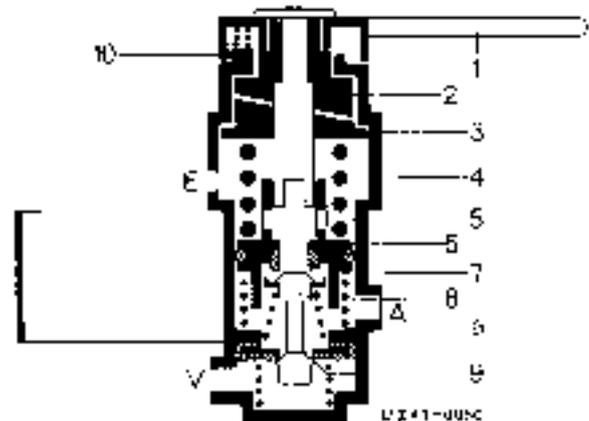

- | | |
|-----------------------|--------------------|
| 1. Inlet seat | 6. Piston |
| 2. Upper thread base | 7. O-ring |
| 3. Lower thread base | 8. Seal |
| 4. Compression spring | 9. O-ring |
| 5. Bore | 10. Clamping plate |
| 6. Piston | |
| 7. O-ring | |
| 8. Seal | |
| 9. O-ring | |
| 10. Clamping plate | |
- O-ring
 □ Connections
 ○ Supply tank
 Δ Tank air
 L Bleed hole

Single-Chamber Brake Cylinder (Piston Cylinder)

Part No.	Westinghouse Designation
000 420 67 24	421 002 000 0
000 420 70 24	421 021 000 0

Technical Data

Westinghouse Designation	Piston d. a. mm	Piston stroke mm	Piston force in N at 8.0 bar
421 002 000 0	80	110	2160
421 021 000 0	65	90	1450

Inspection

The brake cylinder is designed for a response pressure of 0.3 bar. If the response pressure exceeds 0.5 bar, an internal inspection is required. With the wheelbrake correctly set, the piston stroke is 1/3 of the possible total stroke. The angle between piston rod and brake wrench should be approx. 90° during full braking operation.

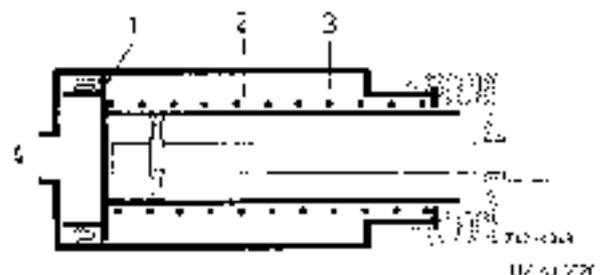

- | | |
|---------------|-----------------------|
| 1. Piston | 3. Spring |
| 2. Piston rod | 4. Compression spring |

Two-Way Valve

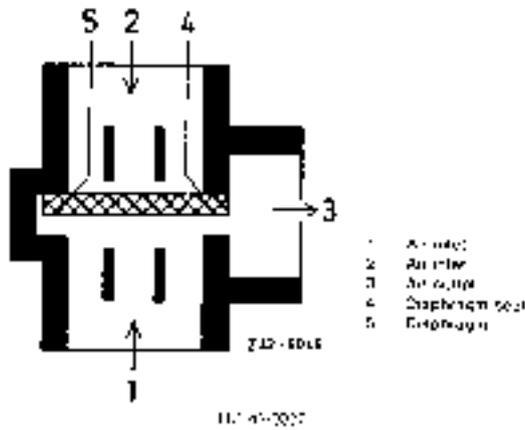

Part No. **Westinghouse**
Designation
 000 429 40 44 4.34 202 100 0

Technical Data

Operating pressure max. 15 bar

Three-Way-Valve

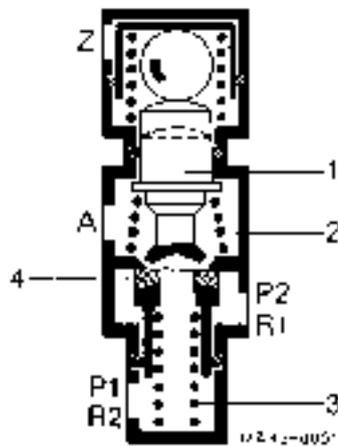

Part No. **Westinghouse**
Designation
 000 429 68 44 3.71 020 000 0

Technical Data

Operating pressure max. 10 bar

Connection 1: Pressure line
 Connection A: Operating line
 Connection 2: Control line
 Connection B: Discharge
 Pressure line of P1: Operating valve
 Pressure line of P2: Discharge valve

Overflow Valve**Technical Data**

Part No.	Westinghouse-Designation
000 429 03 44	434 100 104 0 without return flow
000 429 04 44	434 100 102 0 without return flow
000 429 72 44	434 100 203 0 with limited return flow
000 429 78 44	434 100 103 0 without return flow

Overflow pressure bar	Operating pressure max. bar
5.5	8.0
4.5	8.0
4.0	8.0
5.0	8.0

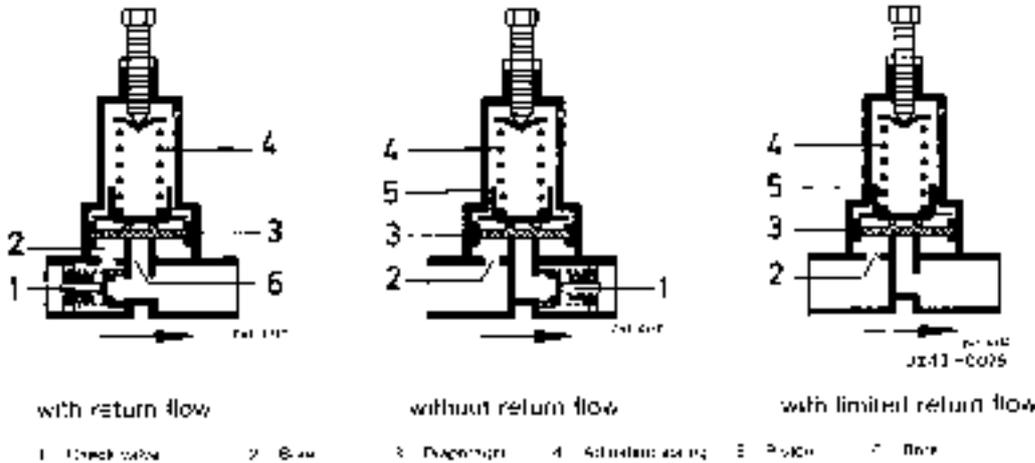
**Pressure Reduction Valve**

Part No.	Westinghouse-Designation
000 429 45 44	475 003 005 0
000 429 17 44	475 010 003 0

Technical Data

Operating pressure max. (high-pressure line)	10.0 bar
Transmitted overpressure (low-pressure line)	5.7 bar
Thread connection	M 22 x 1.5 - 12 deep

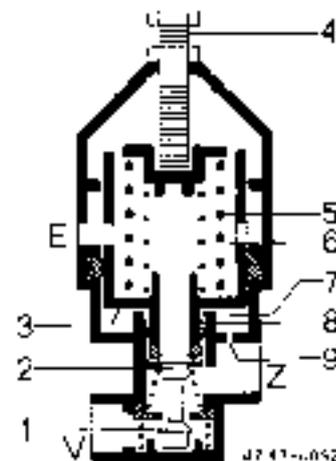
**Installation Instructions**

Always install valve vertically w. In adjusting screw on top.

If necessary, lower half of valve and valve cap can be offset by 90° each relative to each other.

1. Inlet valve	Connections
2. Outlet valve	5. High-pressure line
3. Ball	2. Low-pressure line
4. Adjusting screw	1. Breaker cone
5. Squaring screw	
6. Diaphragm	
7. Piston	
8. Piston tube	
9. Bolt	

Check Valve

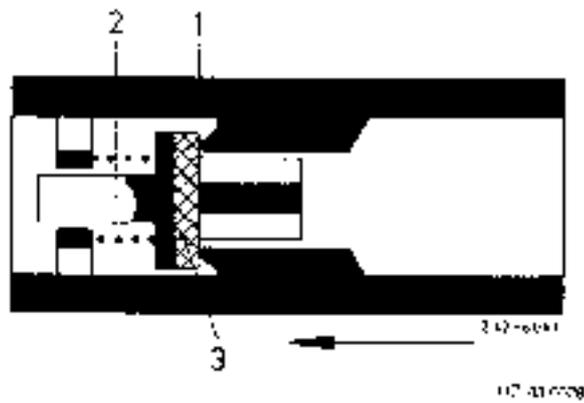

Part No.	Westinghouse Designation
300 479 D4 44	434 314 000 0

Technical Data

Operating pressure max	20 bar
Thread connection	M 22 x 1.5

1 Housing 2 Piston 3 Sleeve

Installation Instructions

The valve is installed in such a manner that the arrow in the housing indicates the direction of flow.

Engine Brake Valve

Part No. Westinghouse
000 434 05 01 Designation
463 013 010 0

Technical Data

Operating pressure max. 10.0 bar
Thread connection M 12 x 1.5

Inspection

Check unit for leaks in actuating and release position. A slight leak may show up during actualium of valve tappet (5).

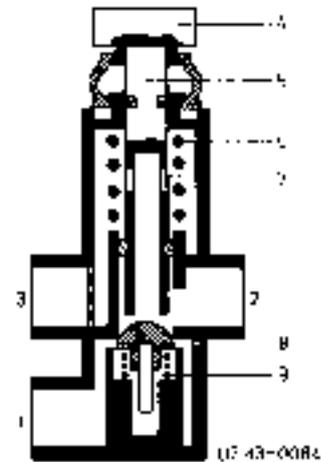

- | | |
|------------------------------------|-----------------|
| 1 Connection nut | 7 Release valve |
| 2 Connection housing tapered upper | 8 Spring |
| 3 Taper | 9 Spring |
| 4 Tappet | |
| 5 Spring | |
| 6 Cross pin | |

Charging Valve

Part No. Westinghouse
000 430 04 09 Designation
463 017 000 0

Technical Data

Operating pressure 8.0 bar
Thread connection M 12 x 1.5

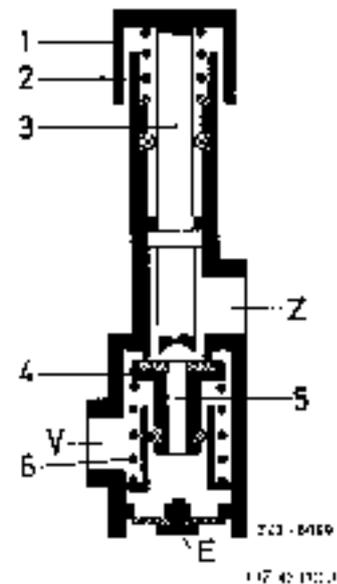

- | | |
|------------------------------------|-----------------------------|
| 1 Connection housing tapered upper | 4 Spring |
| 2 Taper | 5 Cross pin |
| 3 Tappet | 6 Body |
| 4 Spring | |
| 5 Cross pin | |
| 6 Body | |
| | V Connection compressed air |
| | E Release valve |

Brake Force Regulator

Part No. 004 431 32 12

Westinghouse Designation 475 601 014 0

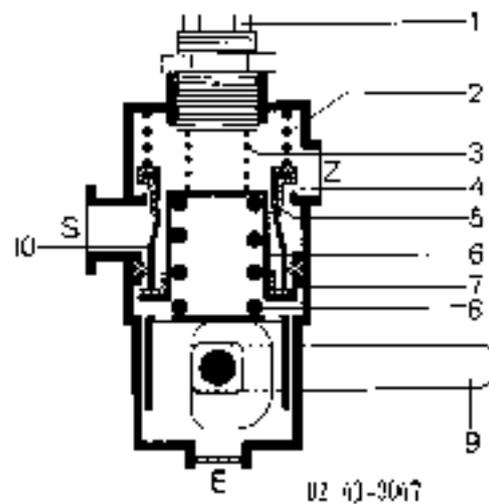
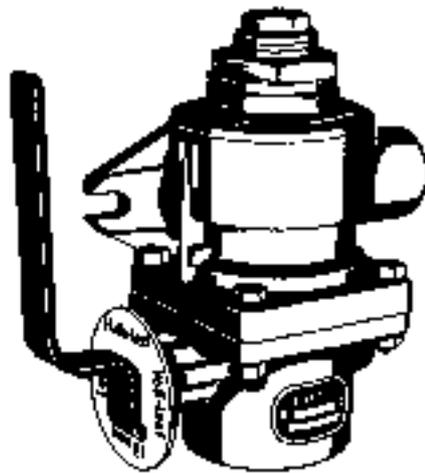

Technical Data

Operating pressure max	5.3 bar	7.35 bar
Brake cylinder pressure in position	"No load" 1.4 to 1.7 bar "Half load" 3.0 to 3.6 bar "Full load" Air tank pressure "Release" 0	2.0 to 2.3 bar 3.0 to 4.2 bar Air tank pressure 0
Adjusting range in position	"No load" 1.4 to 2.3 bar	1.4 to 2.5 bar
Thread connection	M 22 x 1.5 16 deep	

- 1 Adjusting screw
- 2 Spring
- 3 Seal O
- 4 O-Ring
- 5 Bonnet
- 6 Filter
- 7 Outlet
- 8 Spring
- 9 Adjusting lever
- 10 Valve body
- E Greater hole
- S Connection, brake hose valve
- Z Connection, brake hose valve

Three-Circuit Protection Valve

Part No.

Westinghouse Designation

001 431 26 05

324 701 040 0

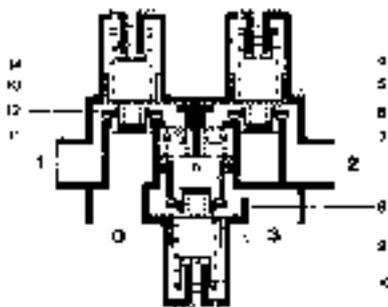

Version 1

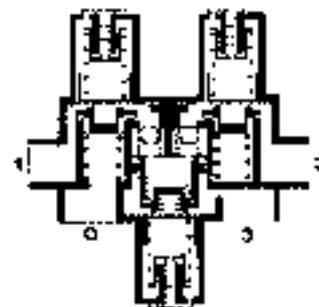

Version 2

- 1 Connection, pressure regulator
- 2 Connection, air tank pressure
- 3 Connection, air tank pressure I
- 4 Connection, circuit II
- 5 Compression spring
- 6 Diaphragm
- 7 Valve
- 8 Check valve
- 9 Valve
- 10 Diaphragm
- 11 Compression spring
- 12 Check valve
- 13 Valve
- 14 Compression spring

Technical Data

Operating pressure	max.	20 bar
Version II Opening pressure (assured pressure)	circuit I	5.0 bar
	circuit II	5.5 bar
	circuit III	5.5 bar

With the brake circuits intact, valves 10 and 12 are held open above preset opening pressure by means of compression springs acting in direction of opening (upward) so that with a slight pressure drop in circuit I or II the pressure may flow from the circuit with the higher pressure to the other one reducing the cut-in frequency of the pressure regulator.

Hydropneumatic Control Valve

Part No.	Westinghouse Designation
000 401 00 13	470 013 000 U

Technical Data

Operating pressure max	• 12 bar (compressed air) 149 bar (hydraulic)
Hydr. operating volume	1.3 cm ³
Thread connection	M 16 x 1.5/M 12 x 1

Operation

Normal: With the entire system intact, supply air flows in connection 5 from compressed air brake booster and continues to flow to trailer control valve via connection 2 compressed air.

Special: in the event of air failure (connection 5 pressureless), connection 4 is hydraulically actuated and since with trailer attached, connection 1 is always connected to supply air, compressed air is passed toward trailer control valve via connection 2.

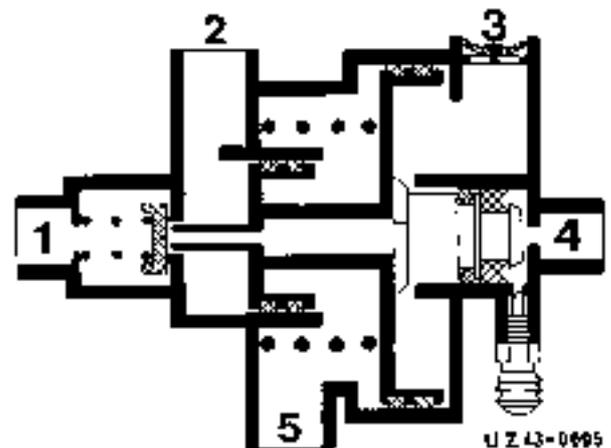

- 1 Supply compressed air
- 2 Compressed air to trailer control valve
- 3 Booster
- 4 Hydraulic control pressure (149 bar)
- 5 Pressure control (compressed air)

SurveyVersion

Electrical installation 421 (engine 61R)

54.9

Electrical installation 421,4'1

15/54

Contents

Chapter	Page
1 General	
Technical data	1.1/1
Fuse table	1.2/1
Bulb table	1.2/1
Key to circuit diagram	1.2/2
Electrical circuit diagram from chassis end-no. 006 090	1.2/3
Key to circuit diagram	1.2/4
Electrical circuit diagram model 128/129	1.2/5
Electrical circuit diagram rotating beacon	1.2/6
2 Batteries	
Removing and installing	2.1/1
Checking	2.2/1
Recharging	2.3/1

Technical data

Battery		Series	SA 35 613 until Sept. 81	SA 35 613 from Sept. 81
Voltage Volt		12	24	24
Capacity Ah		66	2 x 55	2 x 70
Electrolyte level over upper edge of electrode			10	12
Charging current	with first charge	max. 5%	of battery capacity	
	normal when recharging	** max. 10%		
	with quick charge	to 75%		
Maximum temperature			40 °C	
Maximum temperature	Tropics		50 °C	
	Fully charged		-70 °C (for tropics 40 °C)	
	Half charged		25 °C (for tropics 15 °C)	
	discharged		0 °C (for tropics -6 °C)	

Electrolyte density (normal)

The operability of the battery is closely recognizable from the electrolyte density

Electrolyte density after Baume	Specific weight	Charging state of the battery
32° Bé	1.285	Fully charged
22° Bé	1.18	Half charged
10.6° Bé	1.08	empty, immediately charge

* at electrolyte temperature of 170 °C

** at start of gas evolution only

Electrolyte density (tropics)

at 20 °C		at 30 °C		at 40 °C		Charging state
Electrolyte density	Specific weight	Electrolyte density	Specific weight	Electrolyte density	Specific weight	
27.9° Bé	1.24	26.9° Bé	1.23	26° Bé	1.22	well charged
22° - 21° Bé	1.19 - 1.17	22° - 20° Bé	1.18 1.16	21° - 19° Bé	1.17 1.15	half charged
14.2° - 10.6° Bé	1.11 - 1.08	13° - 9.40 Bé	1.10 1.07	11.2° - 8.0° Bé	1.09 - 1.06	empty immediately charge

Fuse boxes and cable connectors

- 1 to 12 fuses
- 13 Cable connector
- 14 Plug connection, warning lamp (brake fluid)
- 15 Plug connection, main cable harness
- 16 Plug connection, headlamp

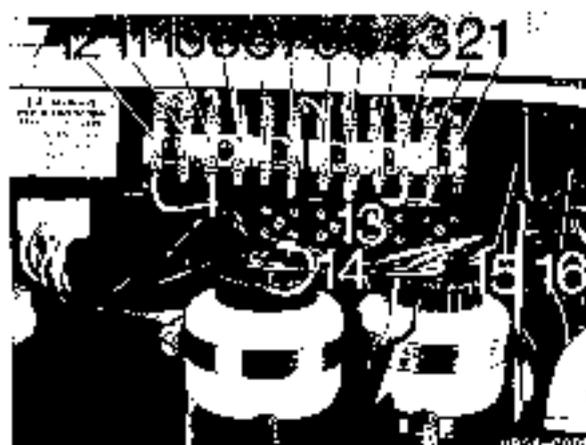

Fuses according to DIN 72581

No.	Power consumer	Current A
1	Parking/side-marker lamp, right	5
2	Parking/side-marker lamp, left	5
3	Headlamp-low beam, right	5
4	Headlamp-low beam, left	5
5	Headlamp-main beam, right	8
6	Headlamp-main beam, left	8
7	Brake lamp/rear lamp/taillamp	16 ¹⁾
8	Horn/windscreen wiper	2
9	Indicator lamp/transistor-pin counter	3
10	Rear lamp right, speedometer lamp	3
11	Rear lamp left, instrument cluster lamp	3
12	Hazard warning lamp/switch	5
-	Windscreen heated	25
1	in 24-volt system 8 Amp	-

Bulbs according to DIN 72601

Power consumer	Output at 12 V W	Output at 24 V W	Shape acc. to DIN /EN ¹⁾
Main headlamp	45/40	55/50	A
Auxiliary headlamp	45/40	-	A
Parking light	4	4	H1
Side-marker lamp	4	4	H1
Indicator lamp front	21	21	P25-1
Indicator lamp rear	21	21	P25-1
Rear lamp	10	10	G
Brake lamp	21	21	P25-1
Instrument cluster lamp	2	2	H
Speedometer lamp	2	2	H
Revolution counter lamp	2	2	H
Interior lamp	10	10	K
Working lamp at rear	25	-	F
Windscreen heater	1.2	1.2	W 5/12
Rotating beacon	45	45	U
Reversing lamp (1)	35	-	D
Reversing lamp (2)	21	-	P25-1
Position lamp (export)	2	4	H
(1) to chassis End no. _____			
(2) from chassis End no. _____			

Electrical circuit diagram

Key to 1.2/3

From chassis end no. 000090

1 Motor for windscreen washer	18 Engine	— Series
2a Main headlamp left	18a Oil pressure pickup	----- Special version
2b Main headlamp right	18b Cockpit temperature pick up	⊥ Ground
3 Windscreen wiper	19 Alternator	Colour codes of the leads
4 Warning lamp for telescopic cylinder	20 Starter motor	b blue
5a Indicator marker lamp left	21 Stop light switch	br brown
5b Indicator marker lamp right	22 Horn	ye yellow
6 Blower for heating and ventilation	23 Glow plug and starter switch	gr grey
7 Interior amp	24 Glow plug indicator	gn green
8 Plug connection	25 Plug connection	li lilac
9 Fuse box	26 Blink-horn-dimmer switch	rt red
10 Cable connector	27 Plug indicator connection	sw black
11 Windscreen wiper-switch	28 Fuel tank capacity pickup	ws white
12 Lamp for second trailer	29 Battery (12 V, 58 Ah)	
13 Switchbox	30 Pressure switch	
14 Transistor-rpm counter	31 Hazard warning flasher switch	
15 Tachograph	32 Warning flasher	
16 Instrument cluster	33a Indicator/rear/brake lamp left	
17 Regulator (not in alternator with an integrated regulator)	33b Indicator/rear/brake lamp right	
	34 Trailer socket	

Electrical circuit diagram¹ from chassis end no. 006 393

(to chassis end no. 006 089 see 15/54-0/3 and 15/54-0/4a)

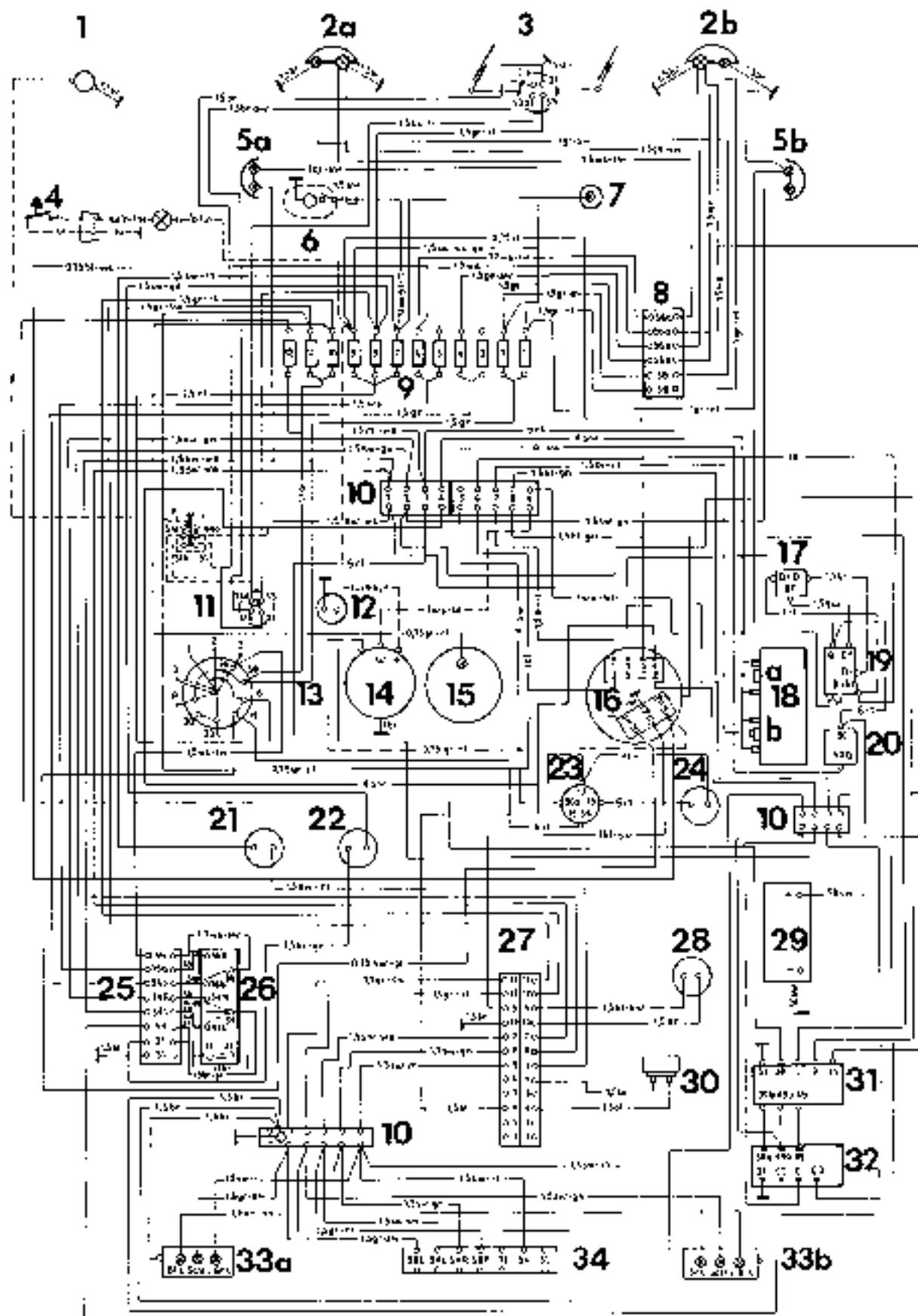

2014-10001

¹not valid for model 128/129

54.9 General

SA 35.613

Electrical circuit diagram

Model 128/129

Key to 1.1/4

1a	Main headlamp left	
1b	Main head lamp right	
2	Windscreen wiper	
3a	Indicator/marker lamp left	
3b	Indicator/marker lamp right	
4	Plug connection	
5	Fuse box	
6	Cable connector	
7	Windscreen wiper-switch	
8	Flasher unit	
9	Switchbox	
10	Speedometer	
11	Instrument cluster	
12	Regulator (not in alternator with integrated regulator)	
13	Engine	
13a	Oil pressure pickup	
13b	Coolant temperature pick-up	
14	Alternator	
15	Starter motor	
16	Brake lamp-switch	
17	Horn	
18	Glow plug and starter switch	Colour codes of leads
19	Glow plug indicator	bl blue
20	Plug connection	br brown
21	Indicator horn dimmer switch	ye yellow
22	Plug connection	gr grey
23	Fuel tank capacity pickup	gn green
24	Battery	li lila
25a	Indicator/rear/brake lamp left	rt red
25b	Indicator/rear/brake lamp right	sw black
26	Trailer socket	ws white
1	Ground	

Electrical circuit diagram

Model 128/129

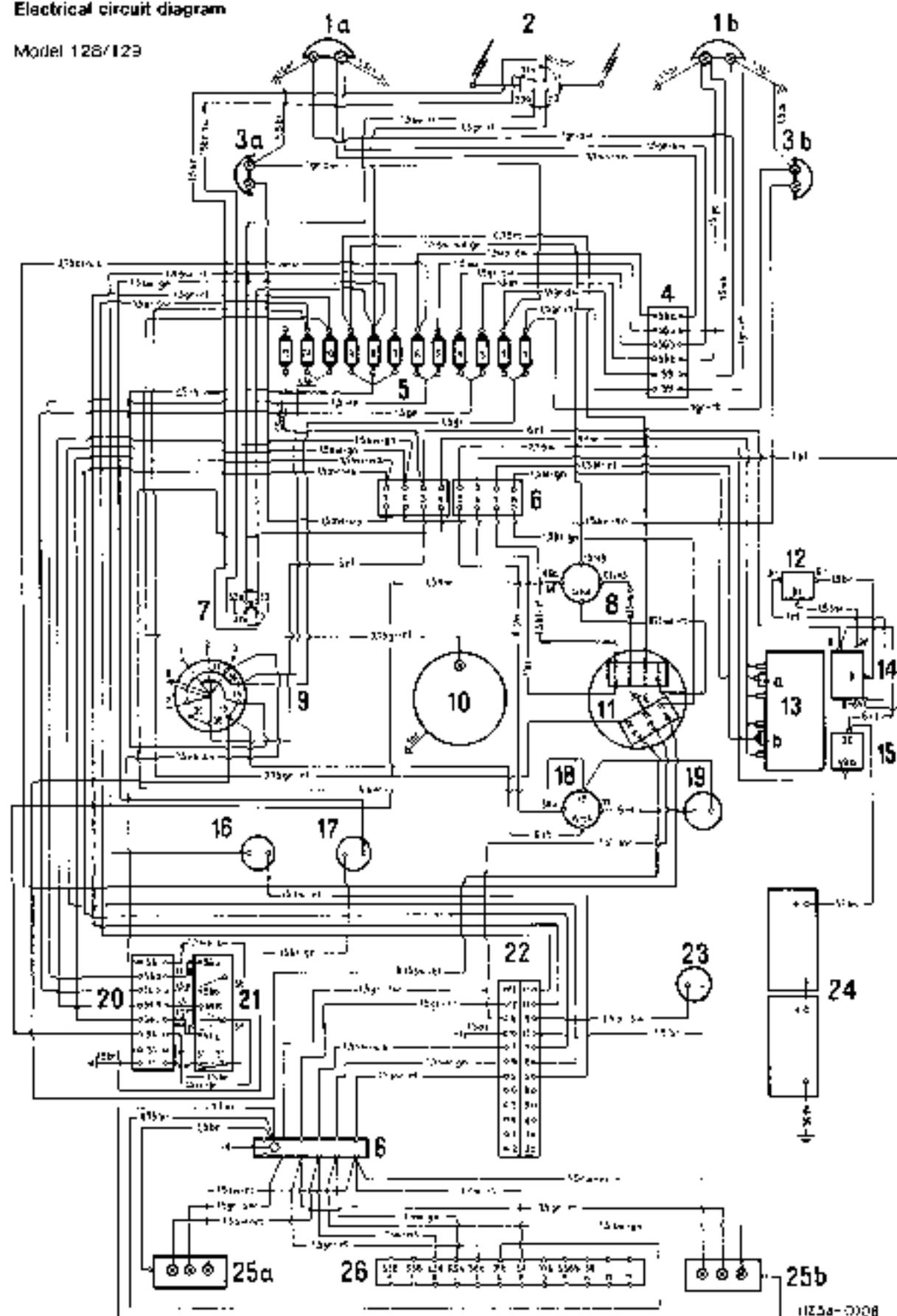

1125a-0008

54.9 General

SA 35 5B1

SA 35 5B2

Electrical circuit diagram

Rotating beacon

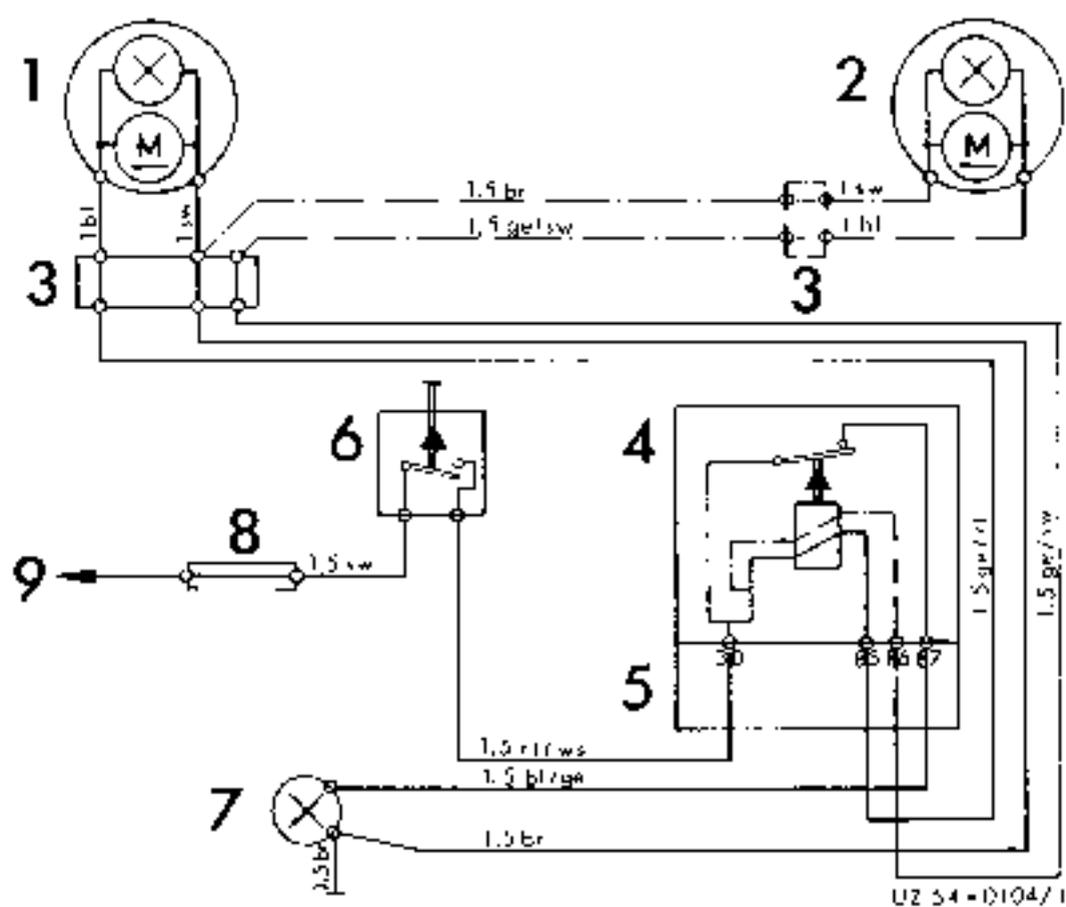

- 1 Rotating beacon left
- 2 Rotating beacon right
- 3 Cable connector
- 4 Relay
- 5 Socket housing

- 6 Switch
- 7 Indicator lamp
- 8 Fuse holder with fuse
- 9 to the terminal strip 30

Electrical circuit diagram

Windscreen heated

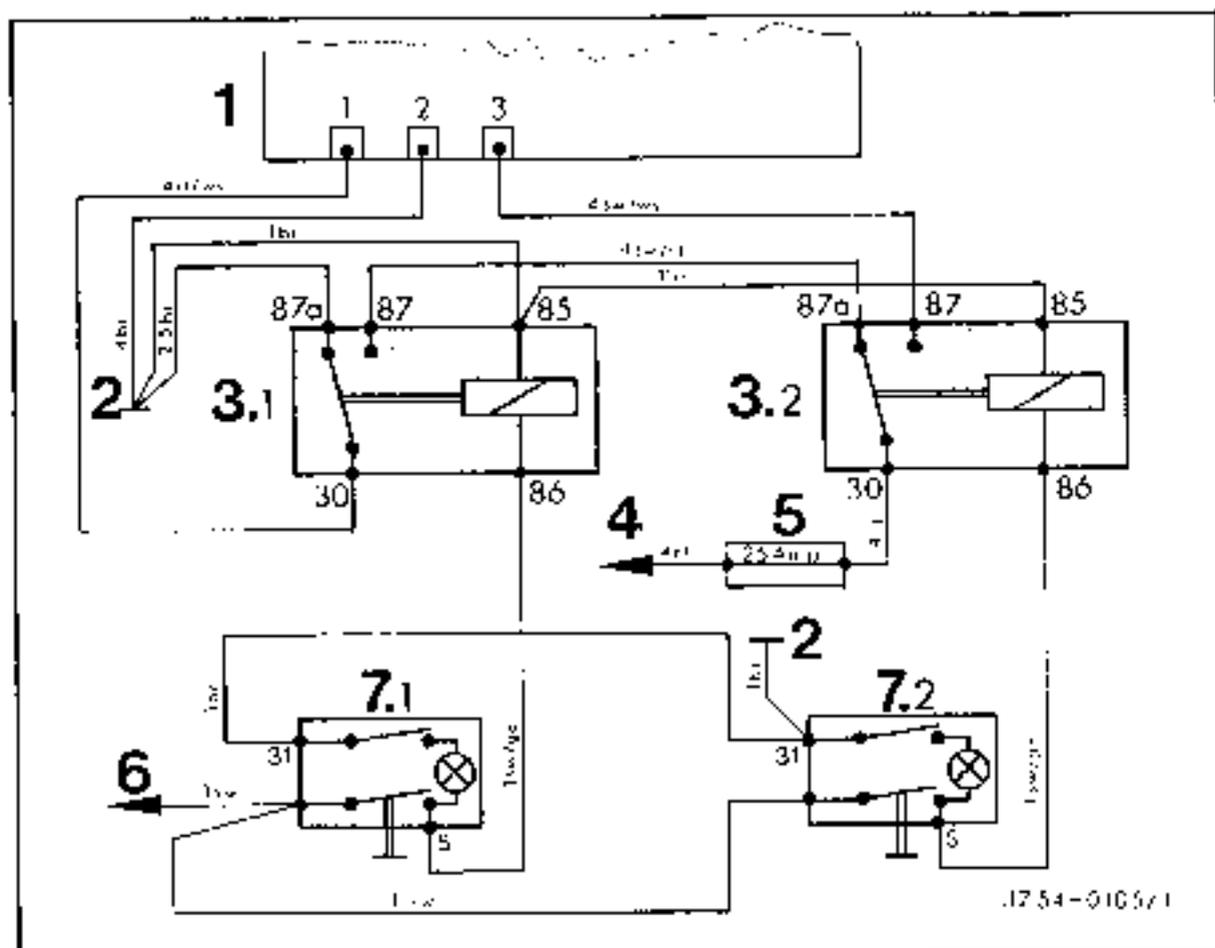

- | | | | |
|-----|--|-----|---|
| 1 | Windscreen | 4 | To switchbox |
| | Connection 1-2 driver's side | 5 | Fuse holder with fuse |
| | Connection 1-3 front passenger's side | 6 | To fuse (windscreen wiper) |
| | Connection 2-3 total heated area | 7.1 | Switch for heated area (driver's side) |
| 2 | Ground bulkhead | 7.2 | Switch for heated area (front passenger's side) |
| 3.1 | Relay for heated area (driver's side) | | |
| 3.2 | Relay for heated area (front passenger's side) | | |

Removing and installing

- 1 Unscrew screw plug at the battery case cover and fold down cover.
- 2 Remove terminal strip.
- 3 Remove battery so far that the battery terminals are exposed.
- 4 Release the bolts at the terminals and remove the connections from above the pole.
- 5 Remove battery
- 6 The installation takes place in reverse sequence.

Note:

When installing and connecting the battery observe: install first (+) terminal then (-) terminal. The positive pole has the larger diameter. Tighten battery terminals firmly. Then grease with acid-resistant grease to prevent oxidation.

Checking battery with hydrometer

Tests	Findings	Possible errors	Remedy
Checking electrolyte level (white acid mark)	ok	-	-
	too high	Acid escapes when charging	Electrolyte up to mark
	too low	Poor maintenance	Top up dist. water
Electrolyte density (measure in all cells)	1.27 - 1.28 Battery charged	none	Battery ok
	1.19 - 1.22 Battery semi-discharged	Power consumers switched on for lengthy period when standing, extensive stop-and-go driving, driving in town	Recharge battery
	1.12 - 1.18 Battery fully discharged	Power consumer not switched off, alternator does not charge, short circuits in electric leads	Immediately charge battery well. Electrolyte density must again be 1.28 at the end. Final charging voltage must be reached. Approx. 15.8 V 12 V battery
	Electrolyte density in cells varies	Defective cells	Replace battery

Checking battery with cell tester load current at 88 Ah battery = 4.4 Amp, max. 8.8 Amp.

Load of charged battery with cell tester	1.4 - 1.8 V/cells battery healthy		
	less than 1.4 V poss. varies	Defective cells	Replace battery

Recharging

Note:

If, when checking the battery, it was found that the electrolyte density (or the specific density) is less than 1.20 (or, in tropics, less than 1.17), the battery must be recharged. The charging current of the battery (11.0 Ah) is not more than 11.0 Amperes and must not be exceeded.

1. Before recharging battery, check electrolyte level (10 to 12 mm above upper edge of plates). Top up if necessary.
2. Connect battery to external source of DC current.
3. When charging, the electrolyte temperature increases from 15° C to 40° C. It is only possible to accurately measure the electrolyte density half an hour after charging.
4. When charging the battery, note that gas escapes evenly out of each cell and that the voltage of 2.6 to 2.7 Volts is reached at each cell. Gassing increases towards the end of charging.
5. Recharging is complete when the electrolyte density has reached 1.285 and the terminal voltage of each cell is 2.6 to 2.7. Measure the voltages with the charging current switched on and the electrolyte density at the specified electrolyte level.
6. Batteries with sulphated plates, recognizable from the white deposit or from the low specific density (below 1.12) must be charged for 40 hours with 2.5 Amperes followed by final charging at full charging current.

Batteries not in use require regular care to maintain them in a serviceable condition. Re-charge once at least every 8 weeks. Failure to do this will render the battery unusable.

A. Remove and install battery

1. Remove lock screws on battery box cover and cover itself.
2. Disconnect and remove the battery terminals.
3. Remove battery.
4. Instal vice-versa

Remark:

When installing and connecting a battery, look out for the following:

Before connecting terminals on battery, clean same with alcohol or soda solution.

B. Battery

1. Keep battery always dry and clean. Check acid level and density as per our luh sketch.
2. Do only clean battery outside, when battery acid filler plugs are screwed in.
Ventilation holes must be open, to allow the gas formation to escape while the battery is recharged when engine is running.
Never use an open light to check the battery, always use a flash light.
3. The acid must be approx. 10-12 mm over the upper edges of the plates.

To re-fill, use only clean distilled water.

[Water evaporates when battery is charged while engine is running.]

The terminals should be tightened good, dirty or oxidised ones are often the reason for bad functioning of electrical system. The current flow can be interrupted by loose terminals. Coat the terminals from time to time with acid protection grease Ft 40 v 1 [from Bosch] to avoid oxidise.

The inside of the terminal should not be greased with acid protection grease.

Attention:

When connecting, do not mix up the + and - terminals [marked].

Avoid spark formation, explosion danger, cover terminals with an insulating plate.



Picture 54-1/1
Check acid level

- 1 = Glass tube
- 2 = Mark for acid level
- 3 = Term only greased

For re-filling the battery with acid or distilled water, don't use metallic containers, use only plastic ones or glass containers.

4. **Check acid density at a temperature of $+20^{\circ}\text{C}$.**

Lift up just enough acid (use acid filler) to make the spindle float. The battery is well charged when the no. 1.285, stamped on

the spindle, is level with the acid upper edge. Picture 54-1/2 and 54-1/3. Page 15/54 Q12 lists the various functions for acid density and specific weight, also the load condition of the battery.

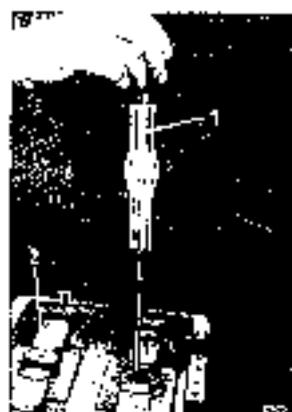

Picture 54-1/2

Check acid density

1. Acid filler: 37547 01 01 00
2. Test cover



Picture 54-1/3



Picture 54-1/4

Check battery cell

1. Cell no. 3: 002 00901 01 00

Remark:

Batteries not in use all the times, need special care to keep them alive. At least every 6-8 weeks recharge, if not done so, battery becomes unserviceable.

C. Battery recharge

Remark:

If noticed, the acid density, resp. the specific weight drops below 1.20 (in tropics below 1.17), the battery must be recharged.

The max. charging current of the battery is:

- a: On type 421 (38 Ah) 9.0 Amps.
- b: On type 411 (105 Ah) 9.5 Amps.

1. Before recharging the battery, check acid level (10-12 mm on top of upper edge of plates), if necessary, refill.
2. Connect battery on outside direct current supplier.
3. When charging, the acid temp. is going up from 15°C to 40°C .

An exact measurement can only be done when battery is cooled off.

4. Each cell of the battery must equally develop gas, each cell should have a current of 2.6 A/V. Picture 54-1/4. Gas developing increases when battery charging comes to its end.
5. Recharging is finished when acid density has reached 1.285 and the cells show 2.6 A/V. The current should be checked with switched-on charging current and the density with the recommended acid level.
6. Batteries with sulphated plates, to be recognized by white sediments and very low specific weight (below 1.12) should be charged with 2.5 A for 40 hours. After that finish with full load current.

Electrical system general

Job No

I. Type 421 with engine 621 and 615

15/54-0/1

Technical data

Electrical circuit diagram in chassis end-no. 002 228

15/54-0/4

Electrical circuit diagram from chassis end-no. 002 229 to chassis end-no. L06 089

15/54-0/5

II. Type 411

Technical data

15/54-0/5

Electrical circuit diagram

15/54-0/7

Removing and installing starter motor, partially repairing in type 421

15-1

Removing and installing starter motor, partially repairing in type 411

15-1 1

Removing and installing alternator in type 421

15-2

I. General

15-2

II. Removing and installing

Removing and installing alternator, partially repairing in type 411

15-2 1

Exchanging voltage regulator

15-3

Glow system

15-4

I Type 421

Starter motor

Engine-type	Bosch-designation	Idle-test		Number of revolutions	Minimum pull-in voltage (volt; solenoid switch)	Adjustment ± 0.2 mm
		Current Amp.	Voltage Volt			
621	EJD (R) 12 V 1.0 PS U 001 354 064	60-80	11.5	6000-7100	B	49.0 \pm 0.2
615	JF — 12 V 2.5 PS	80-95	11.5-12	7500-8500	B	49.0 \pm 0.2

a: = adjustment for starting-motor solenoid switch with link fork taken in



	Short-circuit test		Load-test		Number of revolutions 1/min
	Current Amp	Voltage Volt	Current Amp	Voltage Volt	
621	650-750	6	310-350	9	1250-1450
615	1000-1200	6	650-750	9	1000-1200

Alternator

Bosch-Order No	Type	Voltage	Number of revolutions 1/min	Maximum-current
-	K1 — 14 V 35 A 20	14 V	5752	35 Amp

Regulator

Bosch-Order-No	Type	Regulating voltage	Maximum field current (not continuous current)
-	AD 1/14 V	13.9 to 14.6 volts	3 Amp

Glow plugs

Order-number	Type	Thickness of the glow wire	Rated voltage
-	Bosch KE/GA 1/21	1.8 mm \varnothing	0.9 volts
-	Beru 381 GK	1.9 mm \varnothing	0.9 volts

Note: The part of the Beru glow plug out of which the glow wire projects is not fixed and thus not connected to ground!

Table of the power circuits 421 (to chassis end-no. 006 088)
(all fuses 8 Amp. according to DIN 75281)

Fuse no.	Consumer
1	Spare
2	Rear lamp, left
3	Rear lamp, right Instrument lamp
4	Indicator
5	Horn and windscreen wiper
6	Brake lamp
7	Main beam, left
8	Main beam, right
9	Low beam, left
10	Low beam, right
11	Parking light and position light, left
12	Parking light and position light, right

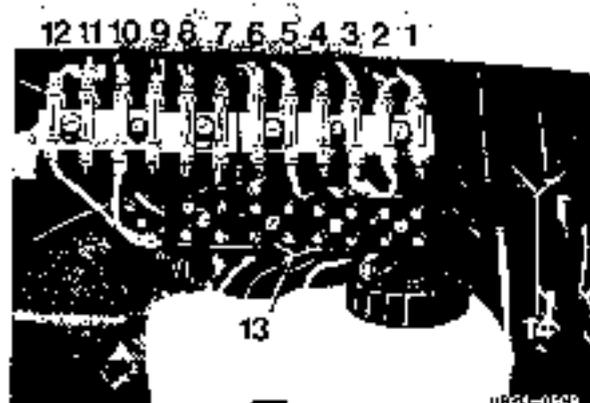

Arrangement of the fuses
1 to 12 Fuses
13 Cable connector
14 Fuse-socket connector

Key to the circuit diagrams see 15/54-0/4 and 16/54-05

1a/1b	Headlamp left and right	16	Trip and light switch
2a/2b	Indicator/lamps right and left	17	Instrument lamp
3	Wiper-motor with end cut-out	19	Combination-instrument
4	Domelight	19	Battery 12 volts/ 8R AH
5	Plug connection in the engine compartment	20	Glow plug and starter switch
6	Fuse box with locks 1-12	21	Glow plug indicator
7	Regulator for alternator	22	Stop light switch
8	Engine with glow plugs/oil pressure and water temperature pickup	23	Horn
9	Alternating current-generator	24	Switch for third brake (over 8 t)
10	Starter motor	25	Plug-and-socket connection at the steering column switch
11	Cable connector	26	Socket 12-pin
12	Push switch for windscreen wiper	27	Tank-gauge
13	Indicator lamp for first trailer	28	Cable connector at frame at rear
14	Glow resistance	29a	
15	Indicator signal flasher	29b	Rear/indicator brake lights left and right
		30	Trailer-socket 7-pole

Electrical circuit diagram type 421 with engine OM 621
(to chassis end-no. 002 228)

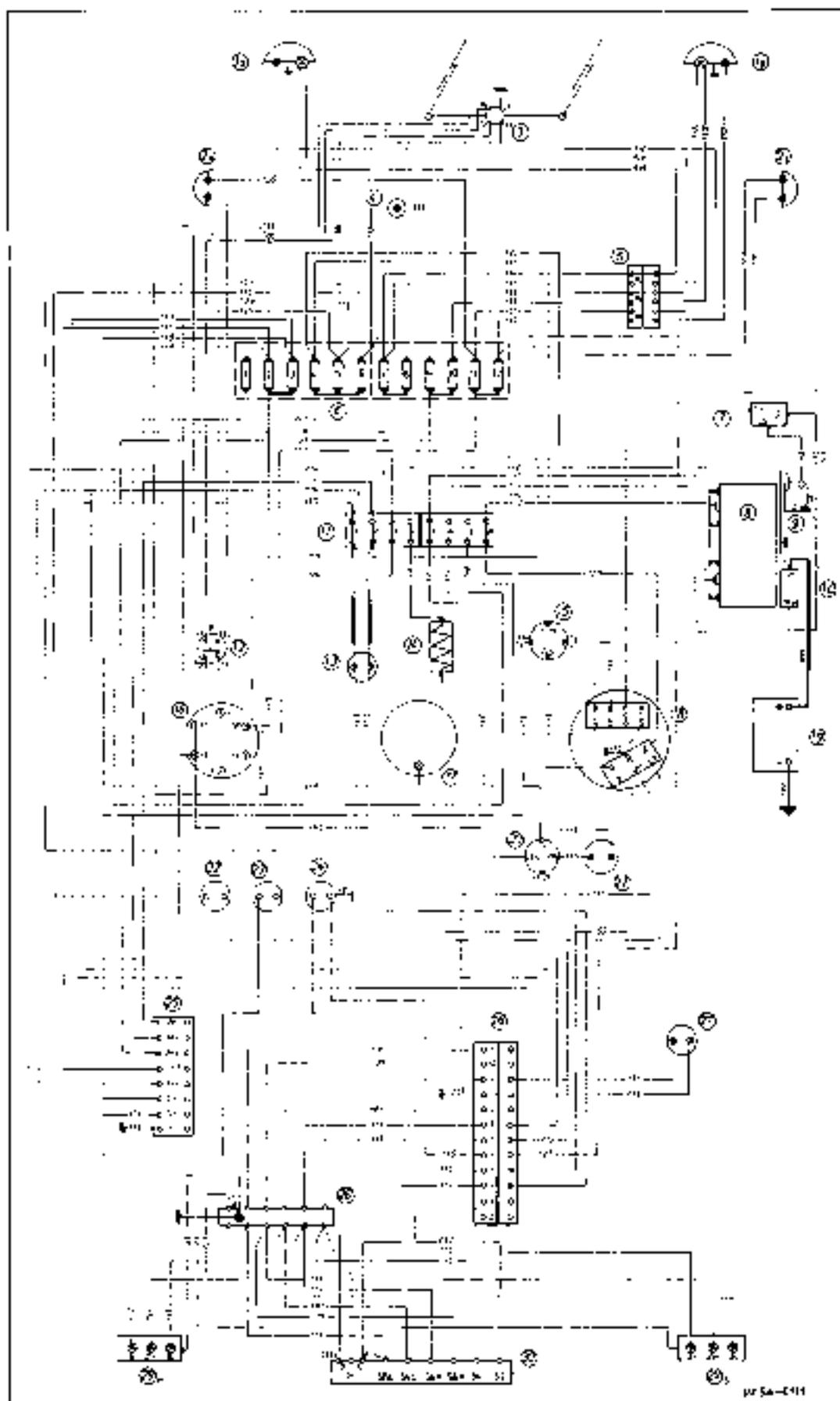

Electrical circuit diagram type 521 with engine OM 615
 (from chassis end-no. 022 229) to chassis end-no. 006 089
 (from chassis end no. 006 090) see 54 B-1,2/2 and 1,2/3)

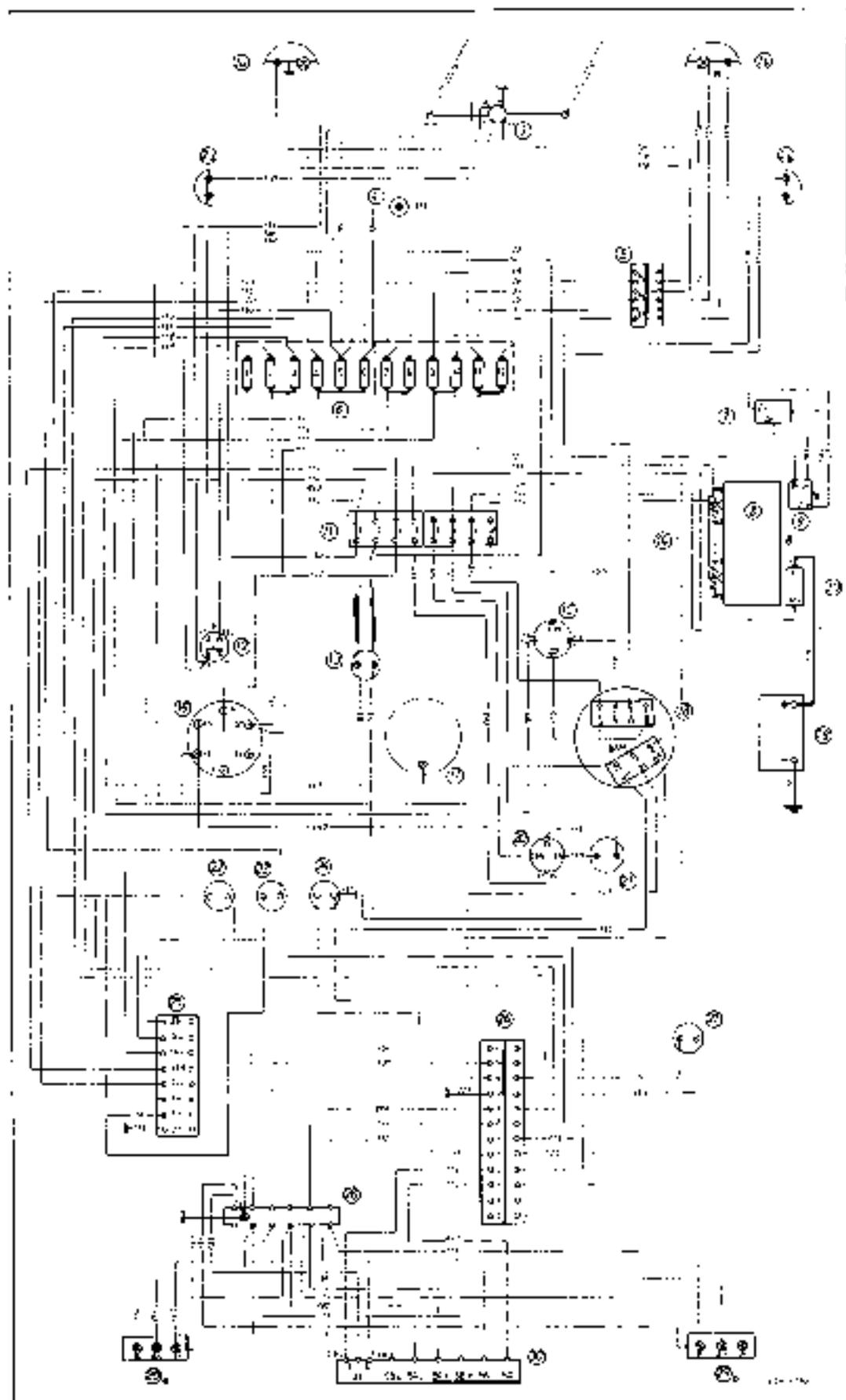

Electrical system

82

Contents

Chapter	Page
1 General	
2 Exchanging bulbs	
Exchanging bulb main headlamp	2.1/1
Exchanging bulb auxiliary headlamp	2.1/2
3 Adjusting headlamps	
Adjusting main headlamps	3.1/1
Adjusting auxiliary headlamps	3.1/2

Exchanging bulb main headlamp

Bulb-table see 54.0-1.2/1

1 Unscrew and remove main headlamp element

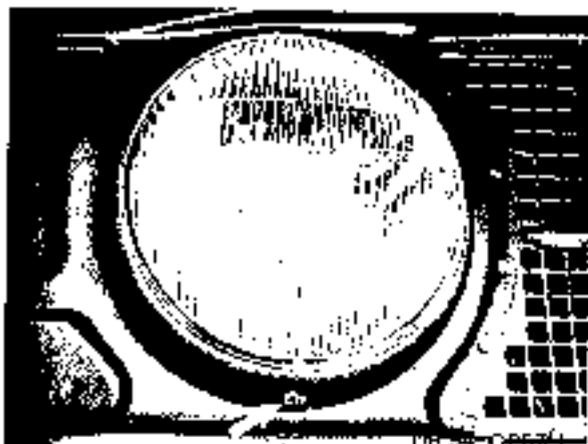

2 Pull off multiple connector of bulb

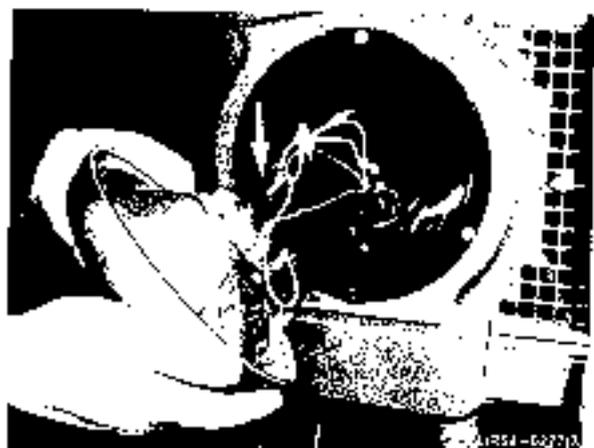

3 Press in bulb holder, turn and remove



4 Remove bulb



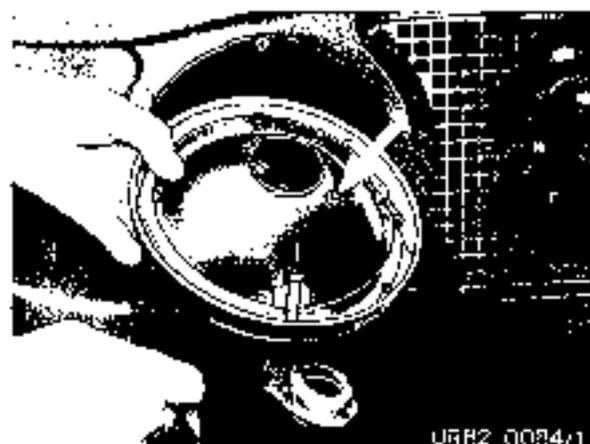

5 Remove bulb (parking light). Installation takes place in reverse sequence. Then check headlamp adjustment, adjust as required. See 3.1/1.

Note:

When exchanging a bulb do not work with dirty or greasy fingers, since the oil evaporates through the heat of the bulb and deposits itself on the headlamp reflectors so that the illumination of the headlamps is considerably weakened. In addition to this, the reflector of the headlamps must not be cleaned; any contact damages the highly polished reflector surface.

Exchanging bulb auxiliary headlamp

Bulb table, see 54.8 1.2/1.

- 1 Unscrew and remove
- 2 Pull off multiplex connector at bulb.
- 3 Press in, turn and remove bulb holder.



4 Remove bulb.

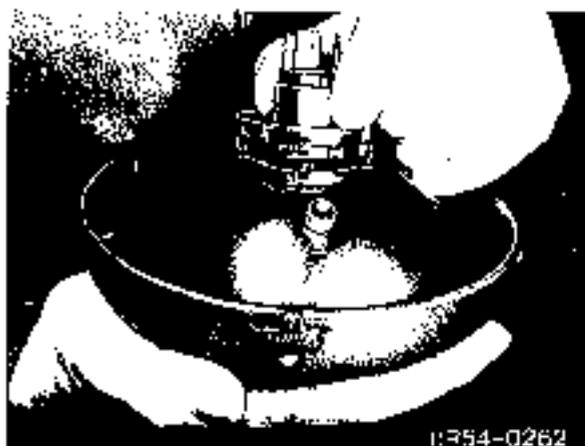

5 Remove bulb (parking light).

Installation takes place in reverse sequence. Then check headlamp adjustment, adjust as required. See 3.1/2.

Note:

When exchanging a bulb do not work with dirty or greasy fingers, since the oil evaporates through the heat of the bulb and deposits itself on the headlamp reflectors so that the illumination of the headlamps is considerably weakened. In addition to this, the reflector of the headlamps must not be cleaned; any contact damages the highly polished reflector surface.



Adjusting main headlamps

- 1 Check tyre pressure, adjust as required
- 2 Park vehicle on even surface.
- 3 Make headlamp adjuster ready for service according to instructions of the manufacturer

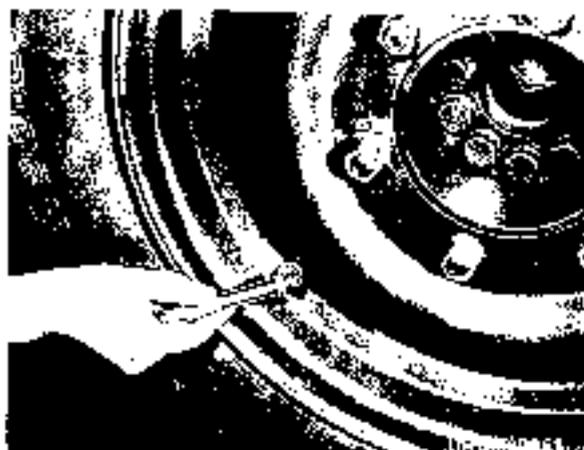

- 4 Check headlamp adjustment. If headlamps require to be adjusted, vary height adjusting screw (1) or side adjusting screw (2) appropriately

- 5 If no headlamp adjuster is available, place vehicle on an even surface 5 m distance from a vertical wall or other test surface. Position central and adjusting marks with division mark according to legend on wall (test surface)

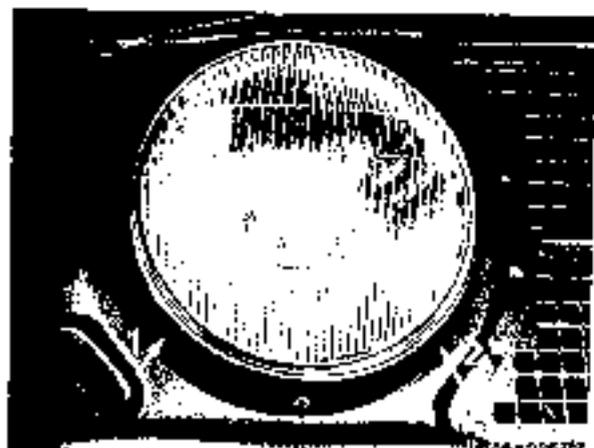

- H Height centre of headlamp
- h Height division mark
- e Adjustment 5 cm
- P Test surface
- S Standing surface
- Z Central mark
- E Adjusting mark
- T Division mark
- K Cutoff point 15°
- A Distance between centre of beams
- L Distance 5 m - test surface - headlamp

- 6 Switch on main beam and individually check headlamp adjustment. The centre of beams must lie on the central mark "Z", adjust headlamps as required.

- 7 Switch on low beam and individually check headlamp adjustment. The bright/dark boundary must lie on the division mark left to the adjusting mark "E" as horizontal as possible and then on the cutoff point line "K", adjust headlamps as required.

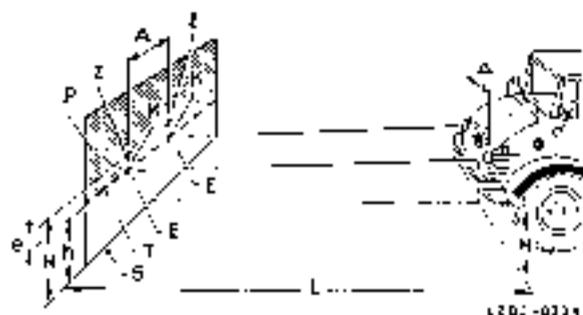
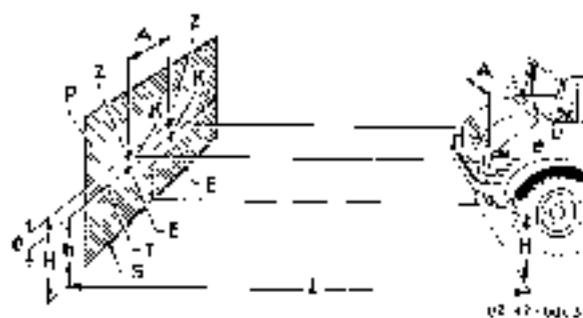

82.1 Adjusting headlamps

SA 35343

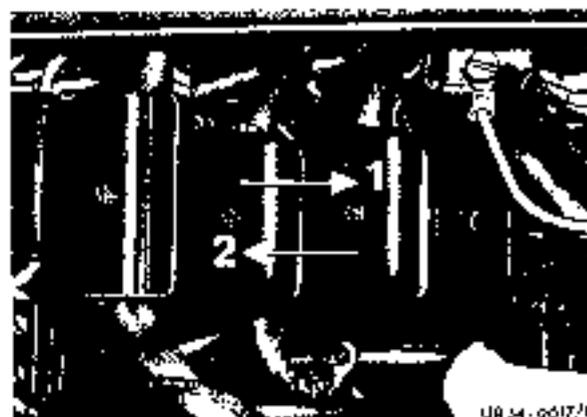

UR 34 - 6617/1



LR02-0079/1

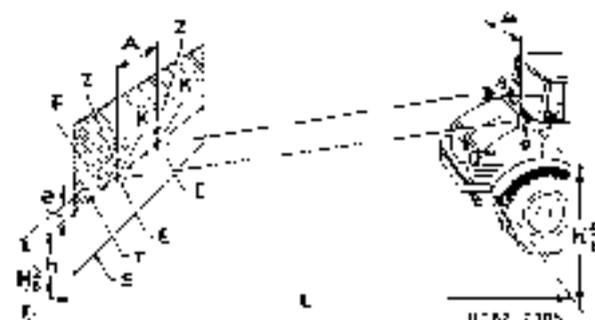
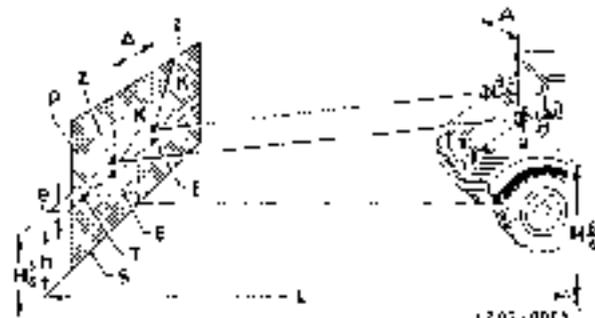

Adjusting auxiliary headlamps

- 1 Check tyre pressure, adjust as required.
- 2 Park vehicle on even surface
- 3 Make headlamp adjuster ready for service according to instructions of manufacturer
- 4 Exchange plug (1) against plug (2) in engine compartment
- 5 Check headlamp adjustment. If headlamps require to be adjusted, release nut and adjust accordingly
- 6 If no headlamp adjuster is available, set up vehicle on an even place 5 m distance from a vertical wall or other test surface. Position central and adjusting marks with division marks according to legend on wall (test surface).

H 5/6 Height centre of headlamp at test surface

H 6/6 Height centre of headlamp at vehicle

H Height division mark

e Adjustment 5 cm

P Test surface

S Standing surface

Z Central mark

E Adjusting mark

T Division mark

K Cutoff point 15°

A Distance between centre of beams

L Distance 5 m - test surface - headlamp

- 7 Switch on main beam and individually check headlamp adjustment. The centre of beams must lie on the central mark 'Z', adjust headlamps as required.

- 8 Switch on low beam and individually check headlamp adjustment. The bright/dark boundary must lie on the division mark left of the adjusting mark 'E' as horizontal as possible and then on the cutoff point line 'K', adjust headlamps as required.

Note:

The auxiliary headlamps may only be switched on if the main headlamps are concealed by front attachment.

Installed Special Requested Equipments

Group 55

Technical Data in General	55-0
I. Type 421	
II. Type 411	
Power Take-Off on Type 421 and 411	55-1
A. Remove and install pto. shafts	
B. Remove, install and repair pto. shaft bearinging	
Hydraulically Operated Power Lift System Type 421	55-2
A. Air compressor with gear type driven oil pump, remove and install	
B. Hydraulic cylinder, remove and install	
C. Oil storage tank with filter, remove and install	
Hydraulically Operated Power Lift System as of Typ 411a (Chassis no. 411.112.017 845)	55-2.1
A. Air compressor with gear type driven oil pump, remove and install	
B. Double acting operating valve and hydraulic cylinder, remove and install	
C. Oil storage tank with filter, remove and install	
Pneumatic Power Lift System up to Type 411a (Chassis no. 411.112.017 844)	55-3
A. Rotary slide valve, remove, install and repair	
B. Front power lift arm, remove, install and repair	
C. Rear power lift arms, remove, install and repair	
D. Power lift arm linkage, remove install and repair	
PTO Shaft Re-Locating Transmission	55-4
Repair Telescopic Cylinder of the Dump Bed	55-5
Hydraulic Pump with Air Compressor	55-6

I. Type 421

Hydraulic system

Gear type driven oil pump w. air compressor
 Gear type driven oil pump
 Oil pump rpm.
 Operating pressure
 Output of max. engine rpm. of 3000/min.
 without counter pressure
 Hydr. double operating valve with pressure
 relief valve
 Capacity of oil storage tank
 Tilting angle of loading platform

Westinghouse 415 701 100 0
 Designation 416 101 000 0
 2600/min.
 150 kp/cm²
 20 ltr./min.
 Designation 466 799 000 0
 approx. 13 ltr.
 max. 50°

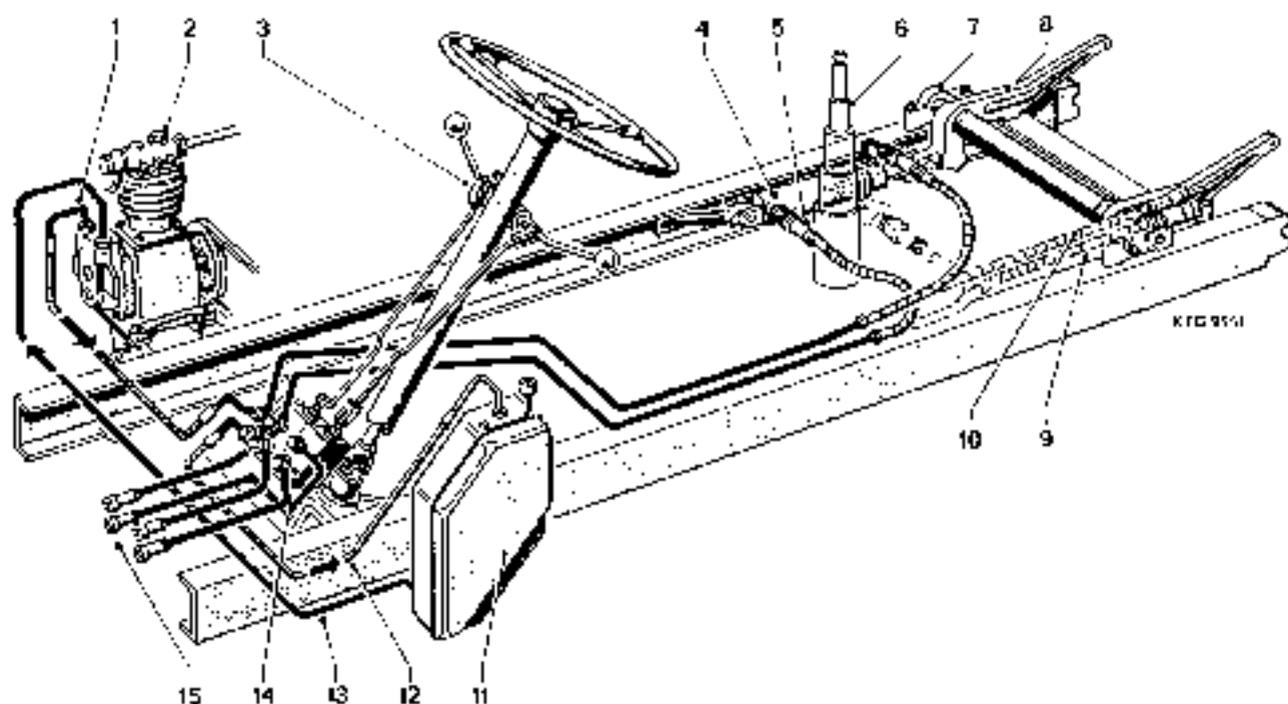

Picture 55-01
 Hydraulic system (Principle sketch)

- | | | |
|---|--|--|
| 1 = Pressure line from pump to double operating valve | 4 = Pressure line, 4 | 11 = Oil storage tank |
| 2 = Air comp. to oil pump | 6 = 4-fold telescopic cylinder | 12 = Return line from double oper. valve to oil tank |
| 3 = Operating lever (to be locked with ignition key) | 7 = Bearing | 13 = Suction line, oil tank to oil pump |
| 4 = Hydraulic cylinder | 8 = Rear power lift arm with mechanical lock | 14 = Double operating valve w. pres. relief valve |
| | 9 = Connection rear, press. line lift | 15 = Quick couplings front, for press. line |
| | 10 = Connection rear, press. line down | |

Lifting capacity

a) Rear power lift system

The lifting capacity is in the range of 470 to 525 mkp, depending upon the swivel point:

Lifting capacity on the implement mounting points of the 3-point linkage at 550 mm connecting height and a middle hub spindle length (of upper arm) of 100 mm free thread:

Center of gravity behind the swivel bearings (m)	Lifting power (kp)		Lifting height in center of gravity (mm)*	
	UL - front	UL - rear	UL - front	UL - rear
0	1190	1250	410	390
0.4	900	1010	555	520
0.8	750	850	710	610
1.0	690	790	775	640
1.2	630	730	825	675
1.4	580	680	850	690

Remark: UL = bottom arm

* The max. travel in center of gravity under consideration of vehicle spring action and tire flattening. However, losses occurring in floating position while operating the vehicle are not taken into consideration.

b) Front power lift system

Max. power at the most permissible piston \varnothing of the cylinder of 72 mm

Pressure 6000 kp
P_{all} 5000 kp

Installation survey hydraulic pump

Chassis model designation	Sales designation	Hydraulic pump Manufacturer	Type		Installation		special version
			Version 1	Version 2	Version 1	Version 2	
421	52 U 600 U 600 L U 600 T	Westinghouse	1 P 41	IPM 10625	starting ^{*)} up to chassis end No. ... 006 089	starting chassis end No. ... 00 090	35 323

*) begin of production

Technical data

Type		1 P 41	IPM 10625
Version		external-gear pump	internal-gear pump
Delivery flow	cc/min	7,8	10,2
Delivery volume	l/min	16/20	28/30
Engine speed	1/min	3000/3500	3000/3500
Pump speed	1/min	2450/2860	2840/3310
Pump gauge pressure	bar		150
Oil temperature	°C		50

Filling capacities

Hydraulic oil tank	Fluid	Capacity
— complete refill	engine oil SAE 10 W* or hydraulic oil	15,0 l
— during oil change		13,0 l
— perm. removal		7,0 l

*) in hot zones SAE 30
in cold zones SAE 5 W - 20/30

55-0 General information

SA 35 323

Installation survey hydraulic cylinder

Chassis		Hydraulic cylinder		
Model designation	Sales designation	Manufacturer	Type	Installation
403	U 800	Weber-Hydraulik	DZ 80/30/150	SA 35 223 ¹⁾
405	U 900			SA 35 630 ²⁾
416	U 1100			
421	U 600			
440, 162	MB trac 700	Hunger-Hydraulik	G 80/30/150	SA 35 651
440, 163	MB trac 800			SA 35 801 ³⁾
				SA 35 658
				SA 35 671
442	MB trac 1100			
443	MB trac 1300			SA 35 811

¹⁾ not valid for UN MDG 421

²⁾ not valid for UN MDG 416

³⁾ valid for MB trac 440 163 only

General view



UR35-D003

Technical data

Design	Double-acting hydraulic cylinder	
Piston dia.	mm	80
Piston rod dia.	mm	30
Stroke max.	mm	150
Perm. peak pressure (D 1 sl)	bar	400
Nominal gauge pressure	bar	180
Operating pressure	bar	180
Pressure at nominal gauge pressure	N	90 000
Pulling force at nominal gauge pressure	N	77 000
Stroke speed range	m/min	0 to 15
Oil temperature range	°C	-20 to +70

Installation survey double control valve

Chassis		Double control valve	
Model designation	Sales designation	Manufacturer	Installation
421	U 52 U 600 U 600 L U 600 T	Westinghouse	SA 35 323

Technical data

Design		Valve cell with pressure limiting valve
Control valve stroke	mm	11.5 ± 0.5
Rotary float position	°	40
Pressure limit	bar	150

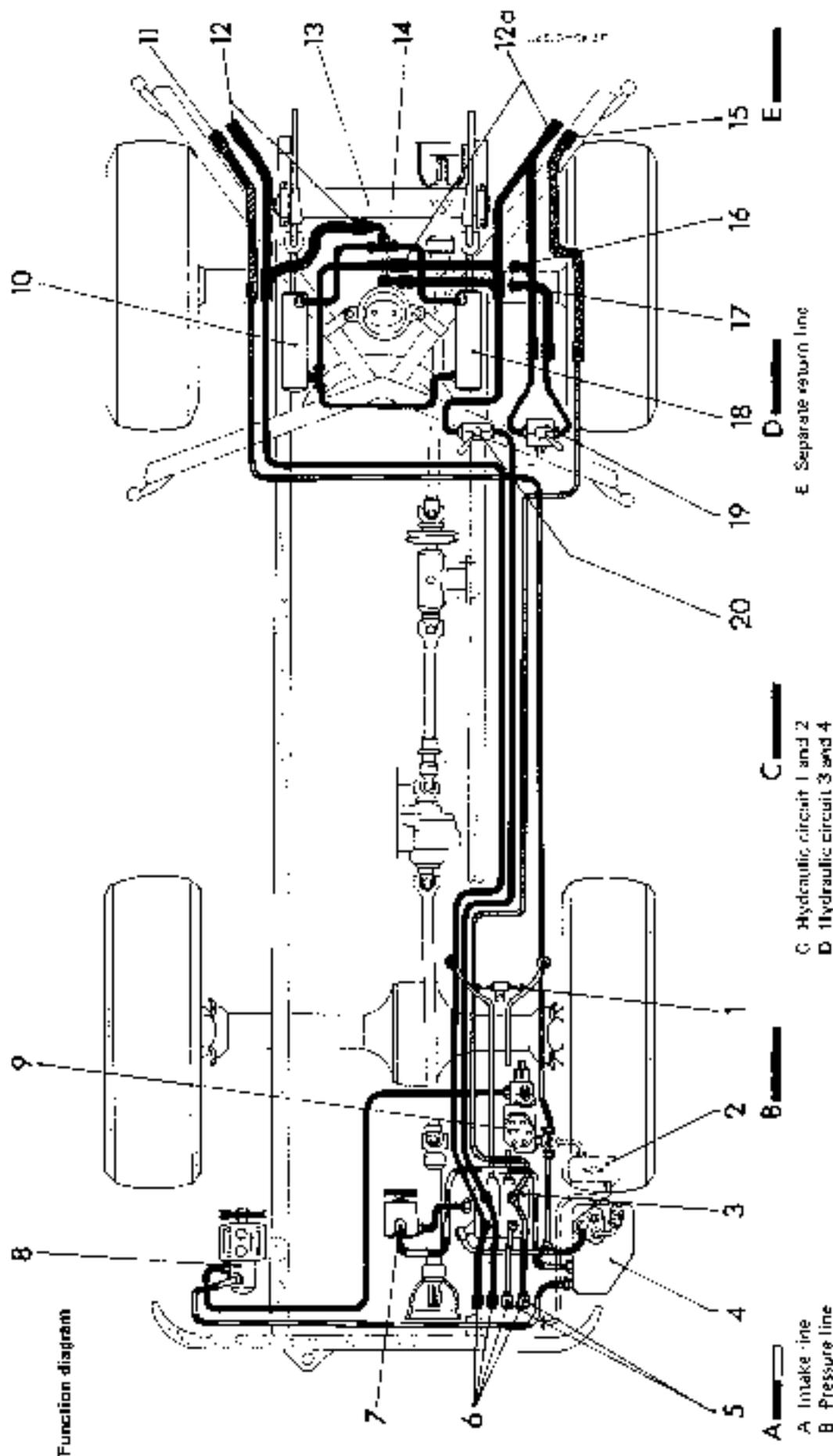

Hydraulic system -- steering system -- PTO shafts

- | | | | | | |
|---|-------------------------|-----|--|----|---|
| 1 | Actuating lever | 7 | Hydraulic pump | 17 | Connection 1 (lifting for tipping cylinder) |
| 2 | Steering oil tank | 8 | Steering pump | 18 | Powerlift cylinder |
| 3 | Control valve | 9 | Hydraulic steering control valve | 19 | 3-way valve, tipping cylinder |
| 4 | Hydraulic oil tank | 10 | Power lift cylinder | 20 | powerlift - detent position |
| 5 | Plug connection 2-point | 11 | Separate return line | 20 | 2-way valve, tipping cylinder |
| 6 | Plug connection 4-point | 12 | Plug connection 1 (lowering for powerlift or implement connection) | | only - or powerlift only - detent position |
| | | 12a | Plug connection 1 lifting for powerlift or implement connection | | |
| | | 13 | Power lift | | |
| | | 14 | Tipping cylinder | | |
| | | 15 | Plug connection 3 | | |
| | | 16 | Connection 1 (lifting for powerlift) | | |

II. Type 411

Hydraulic system (as of chassis no. 411.112.017 845)

Gear type driven oil pump with air compressor

Westinghouse 415 701 100 0

Gear type driven oil pump

Designation 416 101 000 0

Oil pump rpm.

2600/min

Operating pressure

150 kp/cm²

Output at max. engine rpm. of 2750/min.

20 ltr./min.

without counter pressure

Hydraulic double operating valve

Designation 466 799 000 0

with pressure relief valve

approx 8.5 ltr.

Capacity of oil storage tank

Tilting angle of loading platform

max. 50°

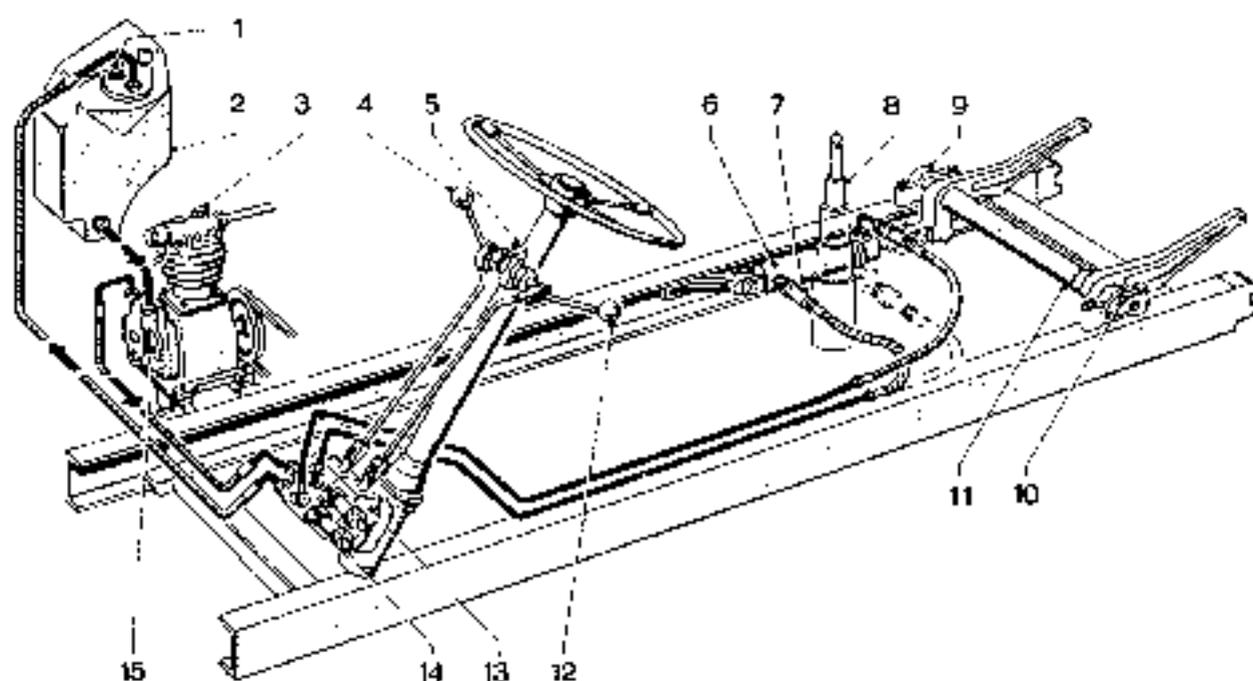

Picture 55-0/2 (Principle sketch)

1 = Filter plug w. dip stick

2 = Oil storage tank

3 = Air compressor

4 = Operating lever f. rear power tilt arm

5 = Ignition key for locking operating levers

6 = Hydraulic cylinder

7 = Male and female plug of hydraulic line

8 = 4-fold telescopic cyl. for tilting platform

9 = Bearing

10 = Lub. pipe

11 = Power tilt arm shaft

12 = Operating lever for front incl.

13 = Double acting operating valve

14 = Quick coupling for front incl.

15 = Oil pump

Lifting capacity of hydraulically operated power lift system (ns of class. no 411.112.017 845)

a) Rear power lift system

The lifting capacity of the power lift system is in the range of 470-525 mxxp depending upon the swivel point. The capacity on the implement mounting points of the 3-point linkage at 550 mm connecting height (and a middle hub spindle length (of upper arm) of 100 mm free thread:

Center of gravity behind the swivel bearings (m)	Lifting power (kpl)		Lifting height in center of gravity (mm)*	
	UL - front	11L - rear	UL - front	11L - rear
0	1190	1350	410	390
0.4	900	1010	555	520
0.8	750	850	710	610
1.0	690	790	775	640
1.2	630	730	825	675
1.4	580	680	850	690

Remark: UL - bottom arm

* The max travel in center of gravity under consideration of vehicle spring action and tire flattening. However, losses occurring in floating position while operating the vehicle are not taken into consideration

b) Front power lift system

Max. power at the most permissible piston ϕ of the cylinder of 72 mm

Pressure 6000 kp
Pull 5000 kp

Lifting capacity of pneumatic power lift system (up to class. no. 411.112.017 844)

a) Rear power lift arm

at the following distance of mounted implement.

Max. lifting capacity on the implement mounting points:

Center of gravity distance (cm)	Lifting capacity (kpl)	
	Type 401*	Type 411**
0	645	830
25	550	730
50	460	630
80	350	520
120	200	360
150	90	240

b) Front power lift arm (at 8.5 kp/cm² operating pressure)

Max. power lift capacity at 35 cm length (cylinder connection-shaft) at the following center of gravity distance of mounted-on implement in front of the turning shaft:

Center of gravity distance (cm)	
40	640
60	570
80	510
100	440
120	370
150	270

* = Good for the old power lift system with 7.5 kp/cm² (cyl. ϕ 170 mm)

** = Good for the new power lift system with 8.5 kp/cm² (cyl. ϕ 190 mm)

A. Remove and install shaft

If the grooved spline and sleeve is parted, the universals must be lined up again to have the same position of the universal joints before put together again. Arrow points to arrow.

Remark:

As of chass. no. 411.850.2175 the shafts and the bearings of pto's have been re-enforced. The formerly 10 hole connection. (Picture 55-1/1) have been changed into one with wedge and only 4 hole connection. The not yet re-enforced pto. shaft bearings still have the 3 mounting screw connection between the bearing housing and the frame.

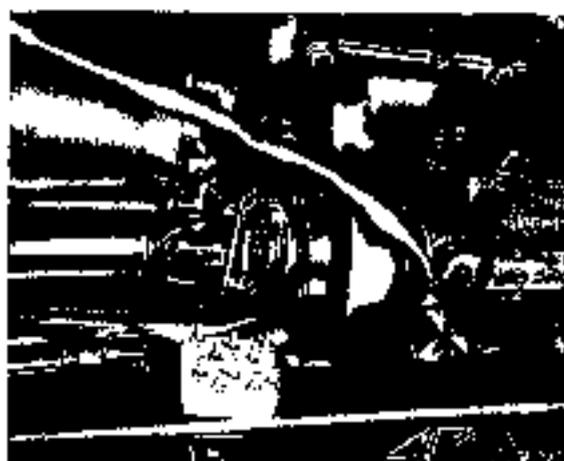

Picture 55-1/1

I. Remove and install front pto.

1. Remove 4 hex. head screws on the drive flange of the transmission, look out for toothed washers.
2. Remove 1 hex. screw M 10 and 2 hex. nut M 10 on front pto. bearing, also watch the toothed washers.

Remove the clamp.

3. Pull out complete pto. with pto. bearing to the front
4. Installation is done vice-versa.

II. Remove and install rear pto.

1. Tilt dump bed to the right and secure.
On vehicles without a dump bed remove the rear wall and the inserted floor piece
2. Remove 4 hex. screws M 8 on transmission

drive flange, do same on flange of rear pto. bearing. Look out for toothed washers. Now remove the shaft, bearing remains on frame.

3. Installation is done vice-versa

III. Remove and install intermediate drive for rear pto.

1. Tilt dump bed to the right and secure.
2. Remove 4 hex. screws each on drive flange of transmission and on flange of middle pto. bearing, look out for toothed washers. Ho'd on to the shaft and remove.
3. Remove the 4 hex. screw of the flange of

rear pto. shaft bearing look out for toothed washers.

4. Remove the pto. shaft after, loosening the grooved hub on middle pto. shaft bearing. The hub itself can also be loosened from the flange of the pto. shaft (4 hex. screws M 8)

5. Disconnect the middle pto. bearing on mounting bracket (one hex. screw M 10 and 2 hex. nuts; look out for toothed washers).
Remove U-clamp and pto. bearing
6. Remove rear pto. bearing (4 hex. head screws with nuts M 10).

Remark:

On type 411, the same mounting procedure as described under pos. no. 5.

7. Installation is done vice-versa.

B. Remove, install and repair pto. bearing

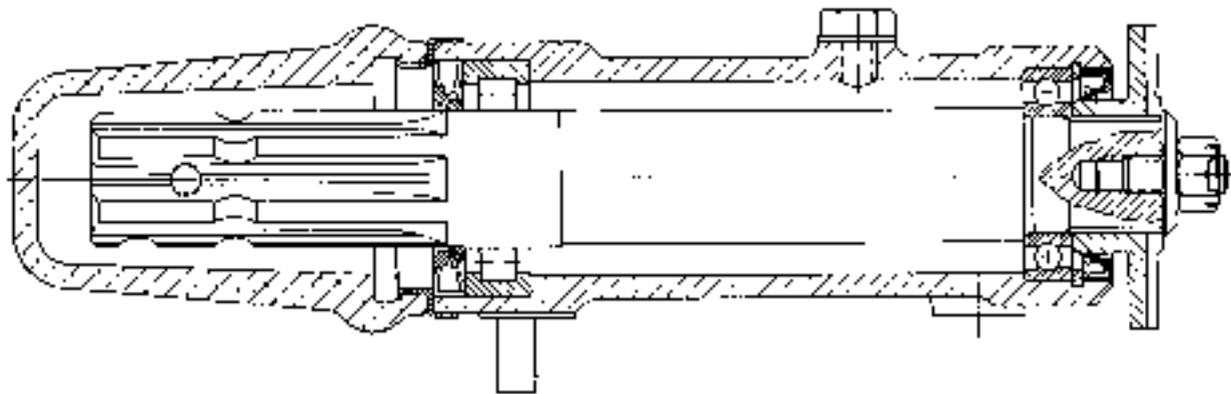

Picture 55-1/2

1. After the pto. shafts are disconnected on the flange of front and rear pto. bearings, remove one each hex. screw M 10 and 2 each nut from front and rear bearing. Take off bearings complete.

Remark:

On the type 421, the rear pto. bearing is mounted with 4 hex. head screws and nuts on the cross member.

2. Remove rubber cap.
3. Take out oil filler screw and drain oil.
4. Decolter castle nut on flange and remove with washer.
5. Pull off flange for pto. (use common type puller)

6. Press out shaft (from the flange side).
7. Remove sealing rings on both ends of bearing housing.
Prior, remove the shrinkage ring.
8. Remove the lock ring on the side of the oil filler hole.
9. Push out grooved ball bearing, use arbor.
10. The still remaining cylindrical roller bearing in the bearing housing can now be pulled out with a puller (opposite of oil filler hole).
11. Wash, clean and check all parts, replace unserviceable ones.
12. Reassembling and installation is done vice-versa.
13. Fill with transmission oil SAE 90, 0.08 lt. for each bearing.

1. Loosen nut for tensioner and remove tensioner, also take off sleeve and rubber buffer.
2. Remove V-belt.
3. Loosen and disconnect line.
4. Loosen the 4 mounting screws on the base of compressor, take out air compressor with oil pump.
5. Installation is done vice versa.

Remark: After installation, the V-belt should be tensioned until the rubber buffer is tightened together of a distance of 70 mm. Now tighten front counter nut.

6. Fill up hydraulic oil in pump to upper mark of dip stick.
7. Repair pump and air compressor, see job no. 55-6.

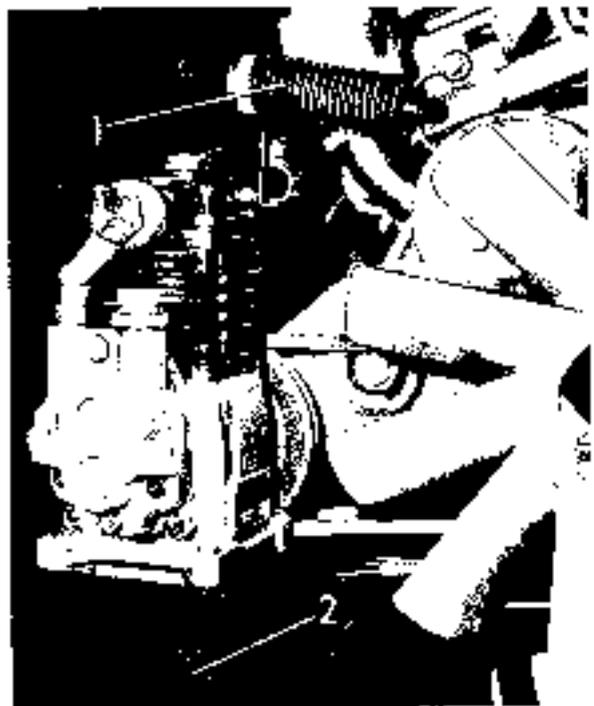

Picture 55-2/1

- 1 - Tension mechanism for V-belt
- 2 - Screw nut for air compressor mounting bracket

B. Remove and install hydraulic cylinder

1. Disconnect hoses on hydraulic cylinder (quick couplings).
2. Both pins (on frame mounting bracket and eye of shaft) to be unlocked by taking out 2 screws with lock ring M 8.
3. Remove both pins, Picture 55-2/2
4. Remove hydraulic cylinder.
5. Installation is done vice-versa
6. Refill hydraulic oil and do perform functioning test of the power lift system.

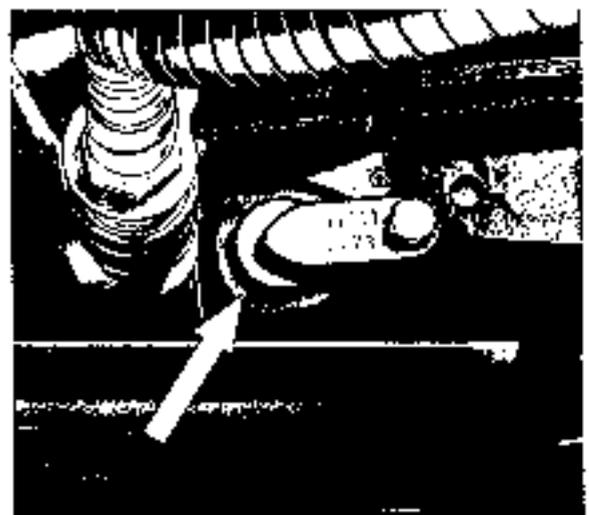

Picture 55-2/2

- 1 - Pin
- 2 - Screw - mounting pin

C. Remove and install oil tank

1. Drain hydraulic oil, look out for sealing ring.
2. Disconnect hose lines as well as ventilation filter.
3. Remove 2 hex. screws M 8 with nuts on bracket of cab and one same on cab itself, remove oil tank.
4. To remove the strainer basket, the cover with gasket must be taken off.
5. The installation is done vice-versa.
6. Fill up hydraulic oil.

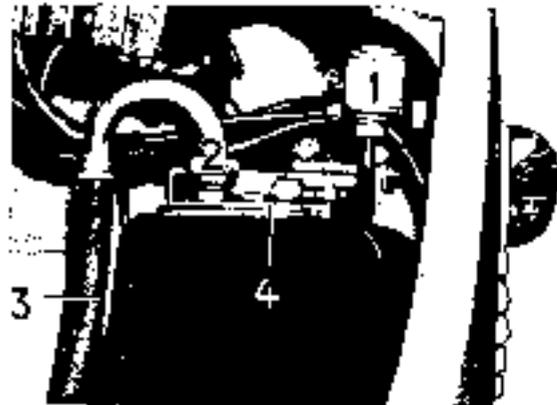

Picture 55-2/3

- 1 - Ventilation filter
- 2 - Return line
- 3 - Oil level check glass
- 4 - Tank cover

(as of chassis no. 411.112.017.845)

A. Air compressor with gear type driven oil pump, remove and reinstall

1. Loosen tension mechanism on air compressor.
2. Remove V-belt.
3. Remove lines.
4. Remove the 4 hex. screws on base of compressor, take out same with oil pump.
5. Installation is done vice-versa.

Remark: After installation, the tensioning of V-belt must be checked and if necessary corrected. One should be able to depress the V-belt 5-8 mm. Recommended axle tension is 60 kp.

5. Fill up hydraulic oil to the upper mark of dip stick. Check markings on dip stick. Correct distance from dip stick mounting to top marking is 56 mm.

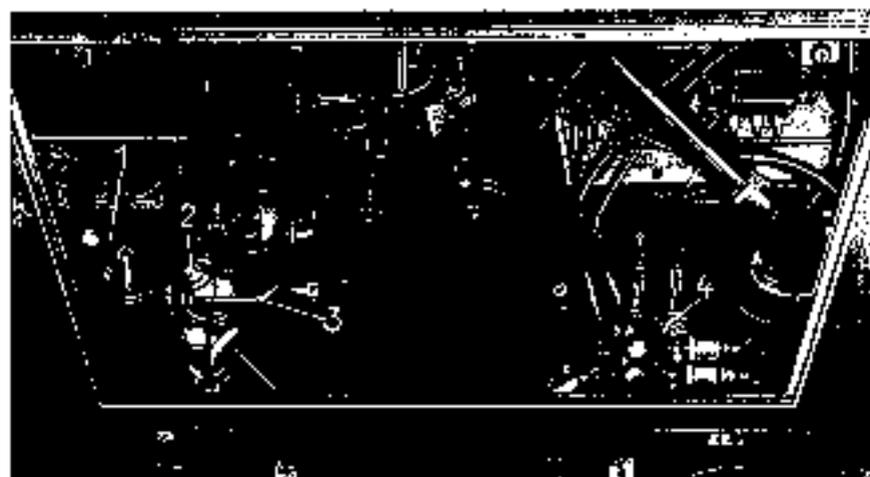

Picture 55-2.1/1 Hydraulic system in the engine compartment

- 1 = Oil tank
- 2 = Air compressor with oil pump
- 3 = V-belt tensioner
- 4 = Operating valve

B. Double acting operating valve and hydraulic cylinder, remove and install

1. Remove and install double acting valve

1. Disconnect hose lines.
2. Decolter operating linkage on fork head. Remove pin and washer, disconnect fork head.

Remark: For further dismantling of the operating linkage, decolter pin of operating lever and remove.

3. Unscrew counter sunk screws of mounting plate, remove operating valve.



Picture 55-2.1/2

- 1 = Locking device
- 2 = Lever for front manual implement
- 3 = Lever for rear manual implement and lifting platform

- Installation is done vice-versa, the operating lever on the steering column must be in normal position (resting position).

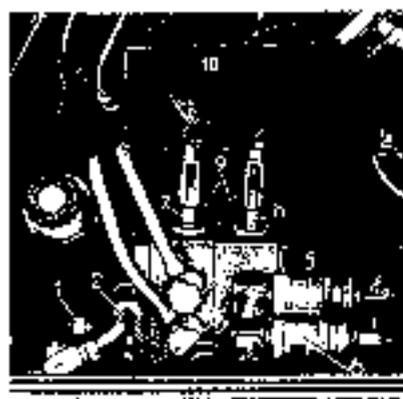

B. Remove and install hydraulic cylinder

- Disconnect hose lines on hydraulic cylinder (quick couplings).
- De-lock both pins on frame mounting bracket and mounting eye of -haft by taking out both M 8 screws with lock washers.
- Remove both pins.
- Remove hydraulic cylinder.
- Reinstall vice-versa.
- Refill with hydraulic oil and do perform functioning test of the hydraulic operated power lifts.

Picture 55-2.1/3

- Return line to the tank
- Pressure line from tank
- Pressure connect on 4. coupl. rear
- Same as no. 3
- Pressure connection 1. front impl.
- Same as no. 5
- Operating valve 1 rear power lift
- Operating valve for front power lift
- Oil filler plug 1 steering
- Flow test

C. Oil storage tank with filter, remove and install

- Drain hydraulic oil, look out for sealing ring
- Disconnect hose lines

3a) Open cab

Remove 2 hex. screws with lock rings on the cab and take off oil tank. Watch for sprayer.

Remark:

Prior, remove air compressor with hydraulic pump for lack of space (4 hex. screws M 8 with lock rings)

b) Closed cab

Remove 2 hex. head screws with lock rings on the support bracket.

Remove 2 same on cab wall, take out oil tank with bracket.

Disconnect bracket from tank by unscrewing both hex. nuts M 8.

- To remove the strainer, the cover with gasket must be removed (6 hex. screws with lock rings).

- Installation is done vice-versa. Watch guide pins on bottom of oil storage tank

- Refill hydraulic oil.



Picture 55-2.1/4

Oil storage tank with air compressor and oil pump

- Breather filter
- Filter plug with dip stick
- Return line to oil tank
- Connection for out on line
- Suction line
- Pressure line
- Tension retainer for V-Leit

(up to class no. 411.112.017/844)

A. Rotary slide valve, remove, install and repair

Remark:

Release the pressure in the system.

1. Disconnect the 3 tube connections
2. Remove pin from linkage connection.
3. Remove the 4 mounting screws (head screws) on the angle and take off valve.
4. Installation is done vice-versa. After the valve is mounted back on again, only the pressure connection is connected. The housing and the outlets in middle position must be checked for leaks (soapy water). After this, connect a check line with pressure gauge

on the different outlets. Place operating lever in the respective positions and check for max. pressure. On the free connections and on the breather hole, no air should escape.

Remark:

New operating system for power lift system.

As of class. no. 411-75 027 53, the old type rotary slide valve has to be replaced by two single valves. This valves are mounted on the transmission cover and the operating levers installed between driver seat and 4 wheel drive respectively differential lock operating lever. See picture 55-3/1

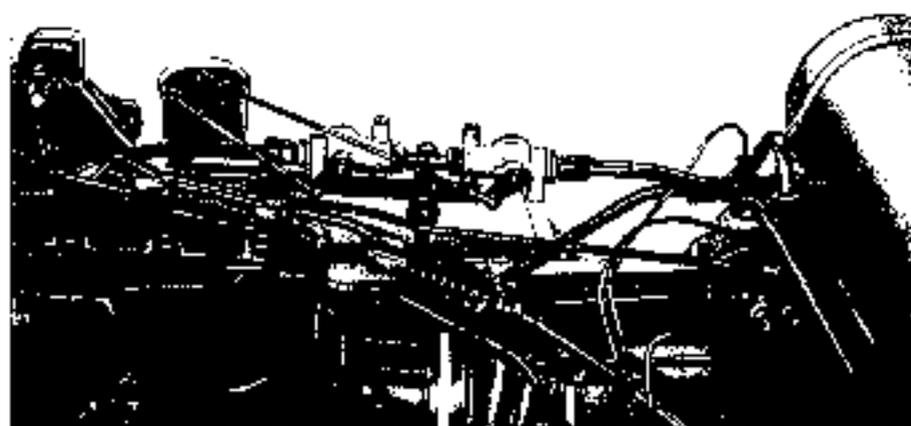

Picture 55-3/1

I. Remove and install operating levers for rotary slide valve

1. Remove pin on rotary slide valve.
2. Remove upper pin on universal.
3. Remove upper linkage with operating lever (to the top).
4. Pull off lower half of linkage from valve connection.
5. Clean linkage, if necessary straighten it.
6. Reassembly is done vice-versa, grease mounting connections. Check the position of operating lever, if need to be, correct with threaded piece.

II. Repair rotary valve

1. Place valve into vise. Bottom side pointing upwards. Remove the 4 head screws, carefully take off lower part. Now remove sealing ring, rotary spool, both cylindrical rollers, pressure piece and springs as well as operating spindle.
2. Check the remaining grooved ring in the housing upper part, if necessary renew.
3. Remove strainer screw on upper part, clean strainer. Remove both same in lower part (look out for seals), clean strainers. Unscrew, out of lower part, the threaded ring and clean the strainer and small filter being underneath.

4. Reassembly is done vice-versa, coat all sliding parts with grease before reassembling.

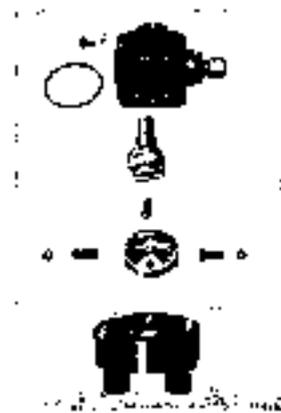

Picture 55-3/2
Rotary valve dismantled

B. Remove, install and repair the front power lift arm

(place lever in cab into position "down")

1. Disconnect tube line connection.
2. If an attachment is still mounted in front, remove the pin of the fork head.
3. Remove mounting screws on mounting bracket, lift out cylinder.
4. Installation into the vehicle is done vice-versa.

I. Repair front mounted lifting cylinder

1. Loosen connecting screw on cylinder, return spring in cylinder must be under tension and freed by taking off the last screw. Take off cylinder.
2. After loosening both tension rings, pull off bellows.
3. Put piston rod into vice and unscrew fork head, prior decollet.

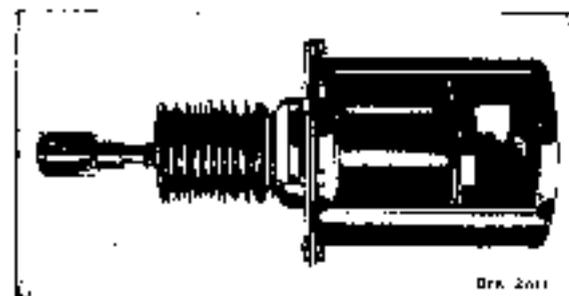

Picture 55-3/3

(Cutaway model of front power lift cylinder with out return spring.)

4. Piston sleeve and piston bottom must be loosened by taking out 6 hex screws. Now remove piston rod, guide tube and spring.
5. Clean all parts, renew unserviceable ones.
6. Reassembling is done vice-versa.

Remark:

The piston sleeve should be replaced from

time to time because its condition is responsible for the lifting capacity of the cylinder.

The cylinder inside, during reassembly, is coated with an acid free grease.

When inserting the piston sleeve, do not damage the edges of same.

C. Remove, install and repair rear power lift arms

a) For type 401



Picture 55-3/4

Picture represents the rear power lift system with removed loading platform.

1. Remove rear wall and insert floor.
2. Remove air line.
3. Decolter connection pin for lifting linkage on fork head and push power lift arms into upwards position.
4. Loosen 4 hex nut each on the mounting brackets and remove cylinder towards the middle of the vehicle.
5. Installation is done vice-versa.

Repair rear lifting cylinder

Same as mentioned in B/1.

Remark:

In the rear power lift cylinder, contrary to the front one, there are no return springs.

b) For type 411

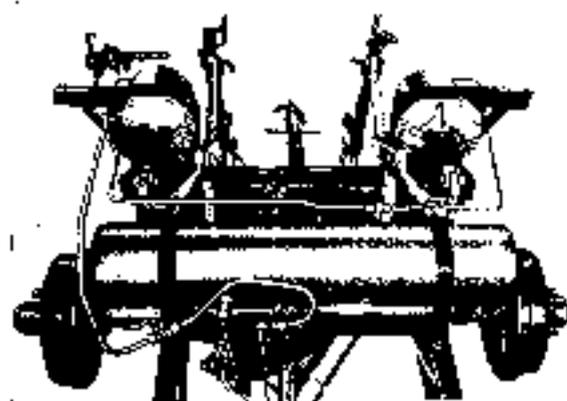

Picture 55-3/5

1. Breather filter

1. Remove loading platform.
2. Remove both cylinders in forward direction after removing the hex screws on the mounting bracket.
3. Installation is done vice-versa.

Remark:

As of class. no. 2010/3/02100/52, cylinders with a dia. of 170 mm have been installed instead the formerly ones with 150 mm dia. At the same time, the shafts and levers have been reinforced too.

Besides, pay attention for a gasket on the cylinder flange.

On the reinforced lifting cylinders, a breather filter is mounted, which should be cleaned when taken off (see picture 55-3/5).

D. Power lift arm linkage, remove, install and repair

1. Remove rear wall and inverted floor.
2. Decotter pin of fork head on lifting cylinder right and left. Now remove same.
3. Decotter nut right next to it (on both sides) and unscrew. Remove washer and connection piece for the lifting shaft.
4. Remove (on bottom side of frame) the mounting brackets for power lift arm shaft. 4 hex. screws each. Take off brackets, watch intermediate ring, the universal mostly remains on shaft, look out for shims.
5. Pull power lift arm shaft downwards, remove connection plate after taking off snap ring.
6. The forward located intermediate shaft (right and left) can be taken out by de-locking and removing a tightening screw on the outside lever. The shaft with intermediate levers can now be taken out.

Remark:

On the reinforced execution, as of chass. no. 5501620, both levers are united and can be removed to the outside, after taking off a lock ring.

7. The mounting bracket for intermediate shaft is tightened with two vertical positioned screws, after unscrewing both, the shaft can also be taken out.
- B. Installation is done vice-versa.

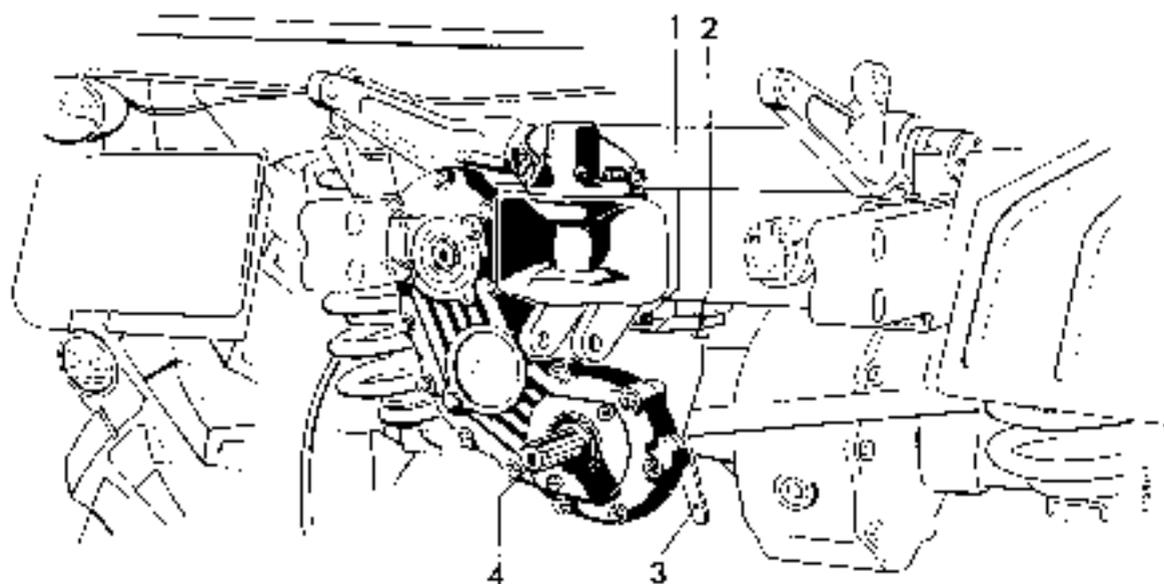

Picture 55-4/1

- 1 - Tension screw
- 2 - Mounting bracket with washer
- 3 - Tension lever, tensioned
- 4 - Re-located pto.

The pto. shaft re-locating transmission is a gear type driven one, running in oil in a closed housing. The pto. shaft splined outlet is of 1 $\frac{1}{2}$ " design.

Since this transmission is mostly installed on the pto. rear afterwards, we will describe a mounting installation procedure. Required is a right angle mounting to avoid unequal tension on the transmission housing.

1. Mount the clamping bracket for the quick coupling under the last cross member of chassis frame, use the included spacers too. This clamping bracket remains on the chassis frame even if the transmission is taken off from time to time.

A slot is in the middle of the clamping bracket which must be **showing to the right** with its narrowest spot of slot.

It is advisable, before installation of the clamping bracket, to fit the bracket into the support, described in the next chapter, possible regrinding.

2. The loose included parts for mounting the transmission onto the clamping bracket should be assembled first. Adjustment of the tensioning screw must be done on the first installation only, same goes for adjustment of the stop screw for tension lever.

The support itself is mounted on the transmission with 2 screws M. 10x20.

3. Adjustment of tension screw

- a) Slide transmission onto the well cleaned pto. shaft. Prior, turn the trailer coupling for 90°, otherwise transmission housing hits trailer coupling.
- b) Swing transmission to the right, place tension lever **to the left**. In this position, slide the tension screw into the left part of the slot in the mounting bracket. The ball shape tension screw head must rest exactly in the notch of the right side slot-end.
- c) Swing tension lever to the right and at the same time press tension screw head (with screw driver) **to the right**.

If the tension distance is not exact, some must be adjusted and the counter nut be tightened. Also adjust the side stop screw for the tension lever in a way that the lever goes only a little over the dead end for to get the utmost tension.

Important:

Every time after tensioning the connection screw **put pressure to the right** onto the tension screw head to check the correct and final seat of the bell head to avoid a self-loosening of the tension mechanism.

The transmission is delivered dry, no oil

Before the first installation, 0.4 ltr. transmission oil SAE 80 must be filled-in. More oil leads to over-heating. Temperatures up to 100° C of the oil means nothing and is normal under continuously max power flow.

The oil must be changed every 100 hours.

4. The removal is done in vice-verso sequences.

The following wear and tear parts can only be changed on a telescopic cylinder

A. Leaking swivel connection

- a) Remove lock ring.
- b) Take off swivel connection with the 2 lip rings. Picture 55-5/1

Remark:

The lip rings must be coated with acid free grease before inserted. Sealing lip pointing to the inner side. The pinion edge should not be sharp or damaged for not to destroy the sealing lips when inserting the swivel connection. Formation of rust must be removed.

B. Leaking floor plate

On type 411, there are 2 executions.

1. **Execution with O-ring in floor plate:** up to telescopic cylinder Z 605 (stamped on type designation plate of cylinder. Picture 55-5/2a.
2. **Execution with O-ring in cylinder sleeve:** as of telescopic cylinder Z 605/65. Picture 55-5/2b.

Remark:

On type 421, only the 2nd execution is installed.

- c) Remove snap ring.
- b) Remove floor plate by hitting cylinder sleeve or a smooth wooden board.
- a) Remove O-ring. When reassembling, look out for (as per execution).

1. **Execution:** Install new O-ring. Before installation, smoothen the rear edge of groove for snap ring in cylinder sleeve with fine sand paper, because this edge can damage the O-ring when inserting same. Before reassemble, coat parts with acid free grease.
2. **Execution:** Insert new grease coated O-ring into the groove of the cylinder sleeve, grease contact surface of floor plate and cylinder sleeve. Do not tilt floor plate when inserting. Install snap ring.

C. Change worn out ball head plates

- a) Loosen cylindrical screws (2 each), remove together with "Schnarr-Lock".

- b) Remove stop and pressure cone. Further dismantling of the telescopic cylinders is not possible.

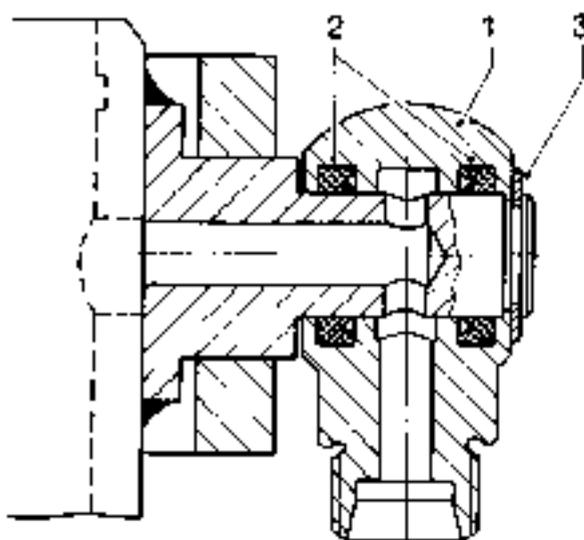

Picture 55-5/1
 1 = Swivel connection bush
 2 = Lip ring
 3 = Snap ring

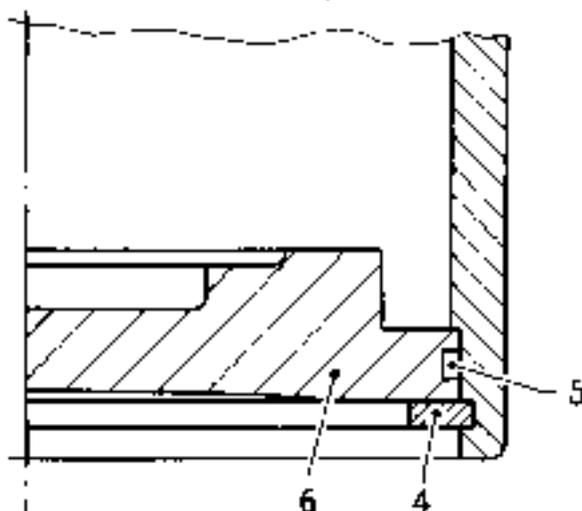

Picture 55-5/2a

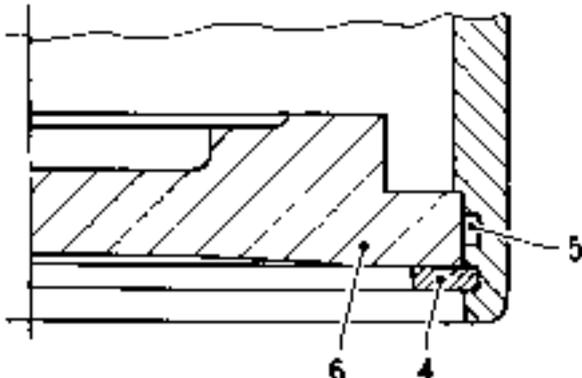

Picture 55-5/2b

4 = Snap ring
 5 = O-ring
 6 = Floor plate

I. Remove and install

1. Disconnect steel pipes and hose lines on oil pump and compressor.
2. Remove V-belt tension mechanism from bracket and take off V-belt.
3. Remove the 4 mounting bolts from base of compressor-oil pump, take out the unit.

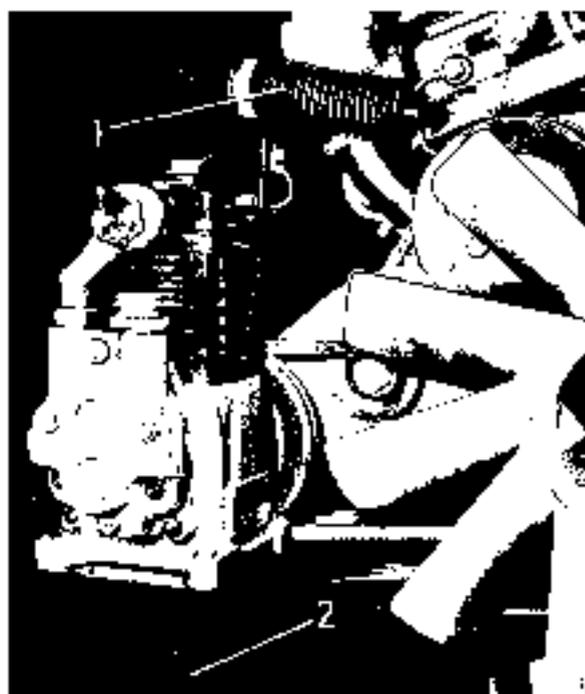

Picture 55-6/1

1 - Tension mechanism for V-belt
2 - Bracket part of unit (2.000)

4. Installation is done vice-versa.

Remark:

When installing, check for flexibility of the belt tension mechanism. The V-belt is correct tensioned when the same can hardly be pressed together by hand.

If necessary, check or change the spring.

Spring data:

Length, untensioned: 213 mm
Spring load: 30 kp for each 100 mm spring travel.

II. Repairing

The air compressor is repaired as mentioned in section 42-10.

1. Disconnect hydraulic pump. Three balls are exposed which serve as a clutch of the air compressor (resp. of the compressor's bottom part).

These balls must always be renewed when reassembled. They should be inserted with grease into the groove of the pump shaft. Turn same, until it slides into the opposite part of the air compressor.

Tighten mounting screws equally on pump flange.

Dismounting of a hydraulic pump for purpose of repairing is not allowed by the manufacturer. An exchange pump should always be available. There are complete combinations air compressor-oil pump of which the air compressor is an exchange unit.

Besides the combination air compressor-oil pump (Picture 55-6/1), there are oil pumps without air compressor (Picture 55-6/3), in which, instead of a crankshaft, a straight shaft is installed (Pictures 55-6/2 and 55-6/3).

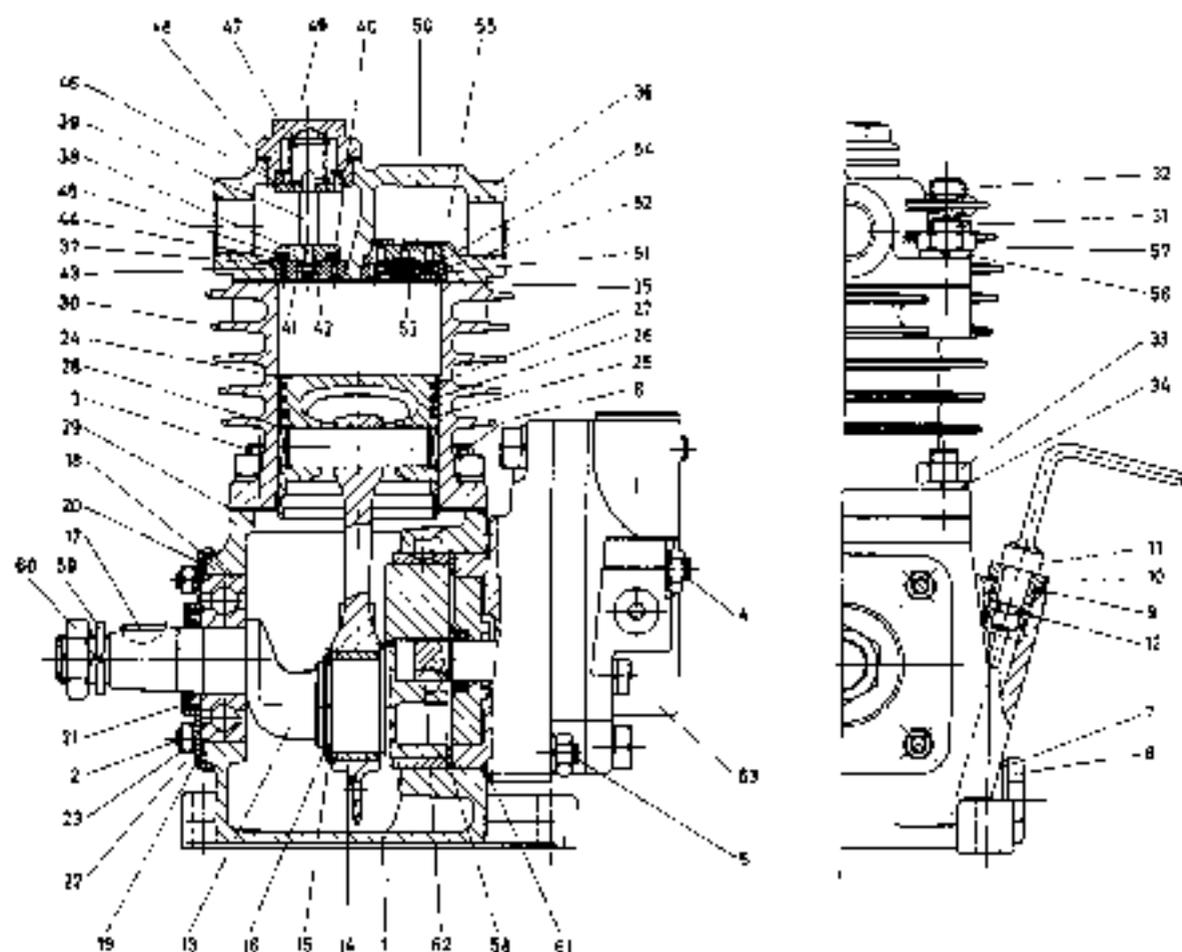

Picture 55-6/2

- | | | |
|--|-------------------------------|-------------------------------|
| 1-6 = Crankcase, compl. | 22 = Lock ring 6 | 47 = Lock washer 3.2 |
| 7 = Flange, compl. | 23 = Hex. nut M 6 | 48 = Sealing ring* |
| 8 = Stud bolt M 6 x 13 | 24 = Piston compl. 40-5 | 49 = Valve ring* |
| 9 = Stud bolt M 10 x 22 | 25 = Piston with piston pin | 50 = Washer* |
| 10 = Stud bolt M 8 x 25 | 26 = Retaining ring* | 51 = Sealing retainer |
| 11 = Stud bolt M 5 x 35 | 27 = Nose ring* | 52 = Pressure fitting |
| 12 = Breather screw | 28 = Top ring* | 53 = Sealing ring A 32 x 16 |
| 13 = Sealing ring* A 22 x 11 | 29 = Lock ring 13 x 11 | 54 = Cap |
| 14 = Locking screw | 30 = Gasket* | 55 = Section valve, compl. |
| 15 = Sealing ring* A 18 x 22 | 31-32 = Cylinder, comp. 63-4 | 56 = Valve seat* |
| 16 = Bushing | 33 = Stud bolt M 12 x 25 | 57 = Suction valve stop |
| 17+18 = Dip stick, compl. | 34 = Hex. nut M 12 | 58 = Washer* |
| 19 = Cover* | 35 = Lock ring 10 | 59 = Coil spring* |
| 20 = Crankshaft, compl. | 36 = Gasket* | 60 = Valve ring* |
| 21 = Crankshaft | 37-38 = Cylinder head, compl. | 61 = Suction valve stop |
| 22 = Rod, comp. | 39 = Cylinder cover | 62 = Washer* |
| 23 = Washer | 40 = Pressure valve, compl. | 63 = Valve seat* |
| 24 = Lock ring 32 x 1.5 | 41 = Valve seat* | 64 = Pressure valve stop* |
| 25 = Key 5 x 7 x 5 | 42 = Valve guide* | 65 = Valve spring* |
| 26 = Grooved ball bearing 52 x 52 x 17 | 43 = Sinus spring* | 66 = Washer |
| 27 = Gasket | 44 = Washer* | 67 = Lock ring A 18 |
| 28+29 = Cover, compl. | 45 = Valve seat* | 68 = Hex. nut M 10 x 1.5 |
| 30 = Cover | 46 = Sealing ring* | 69 = Washer |
| 31 = Sealing ring B 1* | 47 = Lock washer 3.2 | 70 = Lock ring A 18 |
| | 48 = Sealing ring* | 71 = Hex. nut M 12 |
| | 49 = Valve ring* | 72 = Washer |
| | 50 = Washer* | 73 = Lock ring A 18 |
| | 51 = Sealing retainer | 74 = Hex. nut M 10 x 1.5 |
| | 52 = Pressure fitting | 75 = Sealing ring* |
| | 53 = Sealing ring A 32 x 16 | 76 = Bolt 2 III |
| | 54 = Cap | 77 = Gasket type gunc* compl. |
| | 55 = Section valve, compl. | |
| | 56 = Valve seat* | |
| | 57 = Suction valve stop | |
| | 58 = Washer* | |
| | 59 = Coil spring* | |
| | 60 = Valve ring* | |
| | 61 = Suction valve stop | |
| | 62 = Washer* | |
| | 63 = Valve seat* | |
| | 64 = Pressure valve stop* | |
| | 65 = Valve spring* | |
| | 66 = Washer | |
| | 67 = Lock ring A 18 | |
| | 68 = Hex. nut M 10 x 1.5 | |
| | 69 = Washer | |
| | 70 = Lock ring A 18 | |
| | 71 = Hex. nut M 12 | |
| | 72 = Washer | |
| | 73 = Lock ring A 18 | |
| | 74 = Hex. nut M 10 x 1.5 | |
| | 75 = Sealing ring* | |
| | 76 = Bolt 2 III | |
| | 77 = Gasket type gunc* compl. | |

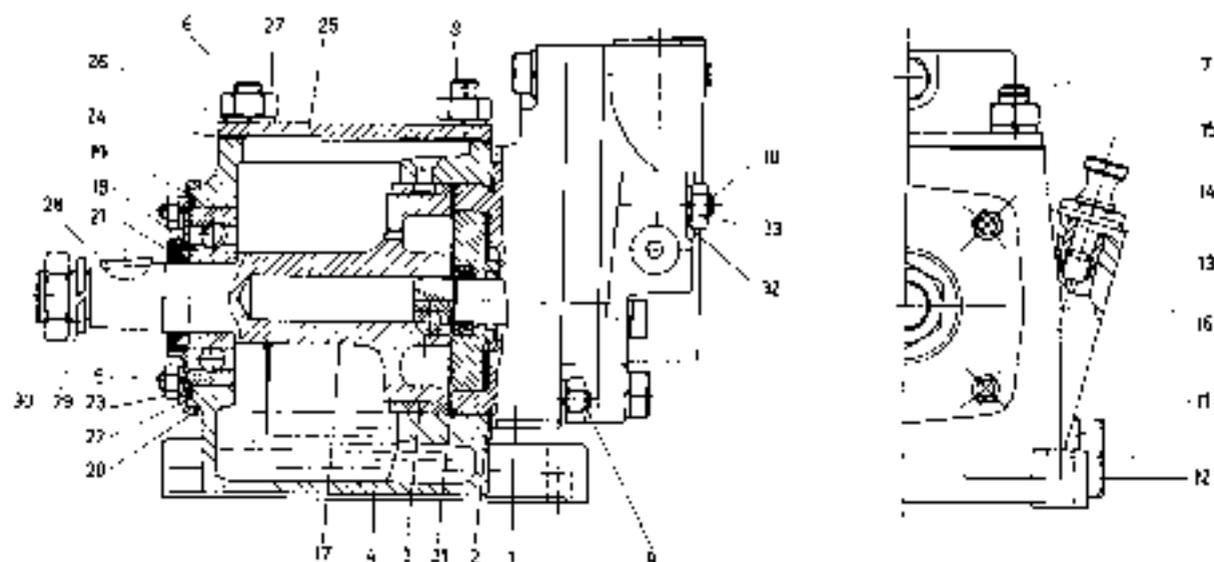

Picture 55-6/3

- | | | |
|-------------------------------|------------------------------------|------------------------|
| 1 = Gear type oil pump, comal | 11 = Sealing ring 4 22x37 | 22 = Lock ring 6 |
| 2 = Sealing ring* | 12 = Locking screw | 23 = Hex. nut M 6 |
| 3 = Bolt** 8 III | 13 = Sealing ring* A 13-22 | 24 = Gasket* |
| 4-21 = Temp. measuring comal | 14 = Gushing | 25 = Cover |
| 4-10 = Crankshaft, comal | 15 = Dip stick cover | 26 = Lock ring 10 |
| 4 = Crankcase, comp | 16 = O-ring | 27 = Hex. nut M 20 |
| 5 = Stud bolt M 6x17 | 17 = Shaft, comal. | 28 = Key 5x7.5 |
| 6 = Stud bolt M 10x22 | 18 = Grooved ball bearing 20/42x17 | 29 = Locking 4 "E |
| 7 = Stud bolt M 10x22 | 19 = Gearing ring* | 30 = Hex. nut M 16x1.5 |
| 8 = Breather screw | 20-21 = Cover compt. | 31 = Washer |
| 9 = Stud bolt M 8x26 | 22 = Cover | 32 = Lock ring 8 |
| 10 = Stud bolt M 9x25 | 23 = O-ring** M 1 25x37 | 33 = Hex. nut M 8 |

* Wear and parts

** This parts should be exchanged a way, when repairing compressor-oil pump. When ordering parts, give designation and order number.

Only the positions mentioned above should be dismantled and repaired. The dismantling of the gear type driven oil pump is not permissible, automatically, the warranty would be lost. If the pump does not function correct anymore, install an exchange pump. Always use, when changing the pump, 3 new balls (pos. no. 3). The groove of the balls should not be worn out.