









# Sprinter

Operator's Manual



Mercedes-Benz

## Symbols

-  Warning
-  Environmental note
-  Possible vehicle damage
-  Helpful hints or further information
-  Instructions
-  Continuation symbol
-  (▷ page) page reference
- Display** Messages in the display

## Trademarks®

ESP® is a registered trademark of Daimler.

## Vehicle Distributor

In the USA:	In Canada:
Mercedes-Benz USA LLC One Mercedes Drive Montvale, NJ 07645-0350 www.mbusa.com Customer Assistance Center: 1-877-762-8267	Mercedes-Benz Canada Inc. 98 Vanderhoof Avenue Toronto, ON M4G 4C9 www.mercedes-benz.ca Customer Relations Department: 1-800-387-0100

Mercedes-Benz USA LLC and Mercedes-Benz Canada Inc. are Daimler companies.

Canada only:

Authorized Sprinter Dealer is defined as an authorized Mercedes-Benz Sprinter Dealer.

## **Thank you for choosing the new Sprinter.**

Before your first journey, please familiarize yourself with your vehicle and how it operates, as well as its driving, control and convenience functions.

Before you drive off, read this Operator's Manual. This will help you to obtain the maximum pleasure from your vehicle and to avoid endangering yourself and others.

The equipment or product name for your vehicle may vary, depending on:

- model
- order
- country specification
- availability

Your vehicle's equipment may differ from some descriptions and illustrations. Items of optional equipment are also described in this manual, should you require a description of the way they work.

The manufacturer continuously updates its vehicles and equipment. We therefore reserve the right to make changes with regard to:

- design
- equipment
- technical features

Your nearest authorized Sprinter Dealer will be happy to assist you further if you have any other questions.

The Operator's Manual, Brief Instructions, Service and Warranty Information Booklet, Maintenance Booklet and equipment-related supplementary operator's manuals are integral parts of the vehicle.

Always keep these manuals in the vehicle. Pass them on to the new owner if you sell the vehicle.

We extend our best wishes for many miles of safe, pleasurable driving.



<b>Index</b> .....	<b>4</b>	<b>At a glance</b> .....	<b>21</b>
<b>Introduction</b> .....	<b>16</b>	<b>Safety</b> .....	<b>31</b>
		<b>Controls</b> .....	<b>51</b>
		<b>Operation</b> .....	<b>137</b>
		<b>Practical advice</b> .....	<b>181</b>
		<b>Wheels and tires</b> .....	<b>251</b>
		<b>Technical data</b> .....	<b>275</b>

- 1, 2, 3 ...**
- 12 V socket** ..... 133
- A**
- ABS (Anti-lock Brake System)**  
Display message ..... 201
- ABS (Anti-lock Braking System)**  
Function/notes ..... 47
- Accessories and conversions**  
see Add-on equipment
- Active Service System (ASSYST)** ..... 167
- Add-on equipment** ..... 276
- ADR**  
Working speed governor (ADR) ..... 117
- Air bags**  
Front air bag (driver, front passenger) ..... 39  
Important safety notes ..... 38  
Safety guidelines ..... 37  
Side impact air bag ..... 40  
Window curtain air bag ..... 41
- Air conditioning in the rear compartment**  
see Climate control ..... 97
- Air-conditioning system**  
Air vents in the roof duct ..... 102  
Refrigerant ..... 161  
see Climate control ..... 97
- Air distribution**  
Setting ..... 102
- Air filter**  
Indicator lamp ..... 195
- Airflow**  
Setting ..... 102
- Air pressure**  
see Tire pressure
- Air-recirculation mode** ..... 104
- Air vents**  
Setting ..... 101
- Alarm system**  
see ATA
- Antifreeze additives**  
see Coolant ..... 160
- Anti-lock Braking System**  
see ABS
- Anti-Theft Alarm system**  
see ATA
- Anti-theft system**  
ATA (Anti-Theft Alarm system) ..... 61
- Armrests** ..... 68
- Ashtray** ..... 128
- ASR (Acceleration Skid Control)** ..... 48  
Activating/deactivating ..... 49
- ASSYST**  
see Active Service System  
(ASSYST) ..... 167
- ATA (Anti-Theft Alarm)**  
ATA troubleshooting ..... 212
- ATA (Anti-Theft Alarm system)**  
Activating/deactivating ..... 62  
Function ..... 61  
Switching off the alarm ..... 62
- Audible warning signal** ..... 212
- Automatic car wash** ..... 164
- Automatic headlamp mode** ..... 90
- Automatic locking** ..... 55
- Automatic transmission** ..... 113  
Driving tips ..... 115  
Malfunction ..... 214  
Releasing the parking lock manually ..... 246  
Shift ranges ..... 114  
Touchshift ..... 114  
Transmission oil change ..... 158
- Auxiliary heater**  
see Auxiliary heating ..... 104
- Auxiliary heating** ..... 104  
Heater booster function ..... 107  
malfunction ..... 216  
Switch ..... 105  
Switch-on time ..... 106
- B**
- Backup lamp**  
Changing bulbs ..... 236, 237
- BAS (Brake Assist System)** ..... 48
- Battery** ..... 175  
Charge indicator lamp ..... 191  
Charging ..... 178  
Disconnecting ..... 176  
Display message ..... 205  
Isolating switch ..... 87

- Notes on care ..... 179
  - Reconnecting ..... 178
  - Removing/installing ..... 177
  - Belt**
    - see Seat belts
  - Bio-diesel** ..... 153
  - Bi-Xenon headlamps**
    - Driving abroad ..... 138
  - Brake fluid** ..... 159
    - Display message ..... 205
    - Fluid change ..... 159
    - Fluid level ..... 170
    - Warning lamp ..... 188
  - Brake lamp**
    - Changing bulbs ..... 236, 237
  - Brake lining**
    - Indicator lamp ..... 191
  - Brake linings**
    - Display message ..... 205
  - Brakes**
    - ABS ..... 47
    - BAS ..... 48
  - Brake system**
    - Fluid level ..... 170
    - Malfunction ..... 205
    - Warning lamp ..... 187, 188
  - Breakdown**
    - see Flat tire
  - Breaking-in** ..... 138
  - Bulb failure indicator** ..... 89
- C**
- Camera**
    - see Rear view camera ..... 122
  - Capacities** ..... 287
  - Care of the vehicle** ..... 162
  - Cargo tie-down ring**
    - Permissible tensile load ..... 283
  - Cargo tie-down rings** ..... 146
    - Installing ..... 148
  - CD player/CD changer** ..... 78
  - Center console** ..... 26
  - Central locking** ..... 54
    - Automatic locking ..... 55
    - Malfunction ..... 217
  - Central locking system**
    - see Key ..... 52
    - Troubleshooting ..... 217
  - Changing bulbs** ..... 233
    - Display message ..... 209
    - Doorway lamp ..... 238
    - Exterior lighting ..... 234
    - Headlamps ..... 234
    - Indicator and warning lamps ..... 197
    - Interior light ..... 238, 239
    - Perimeter lamp ..... 238
    - Tail lamp ..... 236, 237
  - Chassis number**
    - see Vehicle identification number .. 277
  - Child-proof locks**
    - Rear doors ..... 45
  - Children**
    - In the vehicle ..... 41
    - Restraint systems ..... 42
  - Child seat**
    - LATCH-type (ISOFIX ) child seat anchors ..... 43
    - Special seat belt retractor ..... 43
    - Top Tether ..... 44
  - Chock** ..... 183
  - Cigarette lighter** ..... 129
  - Cleaning**
    - After driving off-road or on construction sites ..... 165
    - Alloy wheels ..... 165
    - Automatic car wash ..... 164
    - Cleaning the engine ..... 165
    - High-pressure cleaning ..... 164
    - Vehicle exterior ..... 162
    - Vehicle interior ..... 162
  - Cleaning and care** ..... 162
  - Climate control** ..... 97
    - Adjusting the air vents ..... 101
    - Air conditioning in the rear compartment ..... 100
    - Air-conditioning system ..... 99
    - Air-recirculation mode ..... 104
    - Control panels ..... 97
    - Cooling with air dehumidification . . 100
    - Defrosting the windows ..... 103
    - Fogged up windows ..... 103
    - General notes ..... 98
    - Heating ..... 98

Heating in the rear compartment .....	99
Rear-compartment air conditioning .....	100
Rear-compartment heating .....	99
Reheat function (air dehumidification) .....	103
Setting the air distribution .....	102
Setting the airflow .....	102
Setting the temperature .....	100
Switching air-recirculation mode in the rear compartment on/off .....	104
Switching on/off .....	100
<b>Cockpit</b> .....	22
<b>Combination switch</b> .....	90
<b>Consumption statistics (vehicles with steering wheel buttons)</b> .....	85
<b>Control panel</b>	
Above the windshield .....	27
<b>Conversions and accessories</b>	
see Add-on equipment	
<b>Coolant</b> .....	160
Changing .....	160
Display message .....	206
Expansion tank .....	169
Level .....	169
Temperature gauge (vehicles with steering wheel buttons) .....	77
Topping up .....	169
Warning lamp .....	193
<b>Cornering lamps</b> .....	91
Changing bulbs .....	235
<b>Cruise control</b> .....	118
Display message .....	203
Malfunction .....	216
<b>Cup holder</b> .....	132

## D

<b>Daytime running lamp</b>	
see Daytime running lamp mode	
<b>Daytime running lamp mode</b> .....	89
Setting (vehicles without steering-wheel buttons) .....	74
Setting (vehicles with steering wheel buttons) .....	82
<b>DEF</b>	
See Diesel Exhaust Fluid (DEF) .....	155
<b>Delayed switch-off</b> .....	83

<b>Diesel</b>	
Consumption .....	140
Fuels .....	153
Low outside temperatures .....	154
Reserve fuel warning lamp .....	72, 193
Tank capacity .....	287
<b>Diesel engine</b>	
Preglow indicator lamp .....	194
Winter driving .....	154
<b>Diesel Exhaust Fluid (DEF)</b> .....	155
Capacities .....	287
Consumption .....	140
Display message .....	199, 202, 204
Exhaust gas aftertreatment .....	116
Indicator lamp .....	190
Level indicator .....	116
Ranges .....	116
Refilling .....	143
Storage .....	156
Tool for the tank filler cap .....	182
<b>Digital speedometer</b>	
Setting the unit (vehicles with steering wheel buttons) .....	80
<b>Display</b>	
Display messages .....	197
Outside temperature (vehicles with steering wheel buttons) .....	77
Outside temperature display (vehicles without steering wheel buttons) .....	73
see Indicator and warning lamps .....	24, 187
Standard display (vehicles without steering wheel buttons) .....	73
Standard display (vehicles with steering wheel buttons) .....	77
<b>Distance recorder</b> .....	73
see Odometer .....	73
<b>Door</b>	
Control panel .....	28
<b>Door lock</b>	
see Central locking .....	54
<b>Doors</b>	
Display message .....	208
Indicator lamp .....	197
Opening (from the inside) .....	56
see Central locking .....	54
Unlocking/locking with key .....	52



- Doorway lamp**
    - Changing bulbs ..... 238
  - Driver's door and co-driver's door** ..... 56
  - Driving abroad** ..... 138
  - Driving off-road** ..... 138
  - Driving on rough terrain**
    - see Driving off-road ..... 138
  - Driving safety system**
    - ASR (Acceleration Skid Control) ..... 48
    - EBD (Electronic Brake force Distribution) ..... 48
    - ESP® (Electronic Stability Program) ..... 50
    - Important safety information ..... 47
  - Driving safety systems**
    - ABS (Anti-lock Braking System) ..... 47
    - BAS (Brake Assist System) ..... 48
    - Overview ..... 47
  - Driving system** ..... 117
    - Malfunctions ..... 215
    - Rear view camera ..... 122
  - Driving systems**
    - Cruise control ..... 118
    - PARKTRONIC ..... 119
  - Driving tips** ..... 138
    - Driving abroad ..... 138
    - Pulling away ..... 110
    - Stopping the vehicle and switching off the engine ..... 111
    - Towing a trailer ..... 150
- E**
- EBD (Electronic Brake force Distribution)**
    - Function/notes ..... 48
    - Indicator lamps ..... 187
  - Electrical/electronic devices**
    - Communications equipment ..... 133
  - Electrical/electronic equipment**
    - Retrofitting ..... 277
  - Electrical closing assist** ..... 57
  - Electrical heater booster system** ..... 98
  - Electrical system** ..... 88
  - Electronic Brake force**
    - see EBD
  - Electronic Stability Program**
    - see ESP®
  - e mark** ..... 277
  - Emergency equipment** ..... 182
  - Emergency exit window** ..... 45
  - Emergency exit tensioning device**
    - Function ..... 35
    - Safety guidelines ..... 37
  - Engine**
    - Check engine indicator lamp ..... 194
    - Electronics ..... 276
    - Maximum speeds ..... 280
    - Wash ..... 165
  - Engine oil** ..... 156
    - Adding ..... 173
    - Checking the oil level (on-board computer) ..... 171
    - Checking the oil level using the dipstick ..... 172
    - Consumption ..... 141
    - Display message ..... 207
    - Mixing ..... 157
    - Oil change ..... 156
    - SAE classification ..... 157
    - Warning lamp ..... 192
  - Engine oil filler neck** ..... 169
  - Error memory**
    - see Message memory (vehicles with steering wheel buttons) ..... 78
  - ESP® (Electronic Stability Program)** ..... 50
  - Exhaust gas aftertreatment** ..... 116
    - DEF capacities ..... 287
    - DEF level indicator ..... 116
    - DEF reducing agent ..... 116, 155
    - Diesel Exhaust Fluid (DEF) ..... 155
    - Display message ..... 199, 202, 204
    - Indicator lamp ..... 190
    - Malfunction ..... 195, 199, 202, 204
    - Refilling DEF ..... 143
  - Exterior lighting**
    - Bulb failure indicator ..... 89
    - Changing bulbs ..... 233
    - Daytime running lamp mode (vehicles without steering wheel buttons) ..... 74
    - Daytime running lamp mode (vehicles with steering wheel buttons) ..... 82

Delayed switch-off (vehicles with steering wheel buttons) .....	83
Light switch .....	89
Locator lighting (vehicles with steering wheel buttons) .....	83
Surround lighting (vehicles with steering wheel buttons) .....	83
<b>Exterior mirrors</b> .....	70
<b>Eyeglasses compartment</b> .....	131

## F

<b>Fatty acid methyl ester FAME</b> .....	153
<b>Fire extinguisher</b> .....	184
<b>First-aid kit</b> .....	184
<b>flat tire</b>	
Notes .....	222
Wheel change .....	229
<b>Folding seat</b> .....	67
<b>Folding table</b> .....	132
<b>Front fog lamps</b> .....	90
Changing bulbs .....	235
<b>Front windshield</b>	
see Windshield .....	163
<b>Fuel</b> .....	153
Additives .....	154
Consumption .....	140
Display message .....	208
<b>Fuel filter with water separator</b> .....	221
Indicator lamp .....	196
<b>Fuel gauge</b> .....	72
<b>Fuel tank content</b>	
Reserve, display message .....	208
<b>Fuses</b> .....	239
Driver's seat fuse box .....	243
Fuse allocation .....	241, 244
Main fuse box .....	240

## G

<b>General driving tips</b> .....	110
<b>Genuine parts</b> .....	276
<b>Glove box</b> .....	131

## H

<b>Handbrake</b>	
see Parking brake .....	112
<b>Hazard warning lamps</b> .....	91

<b>Headlamp</b>	
Cleaning system .....	95, 171

<b>Headlamps</b>	
Changing bulbs .....	234
Cleaning .....	164
Fogged up .....	219
<b>Headlamps, automatic</b> .....	90
<b>Head restraints</b> .....	67
<b>Heater booster function</b> .....	107

<b>Heating</b>	
see Climate control .....	97

<b>High beam flasher</b> .....	90
<b>High-beam headlamps</b> .....	90

Changing bulbs .....	235
<b>High-pressure cleaning</b> .....	164

<b>Hood</b>	
Opening/closing .....	168

## I

<b>Ignition lock</b> .....	56
<b>Immobilizer</b> .....	61
<b>Indicator and warning lamps</b> .....	187
ABS .....	189
Air filter .....	195
ASR .....	187, 189
BAS .....	187, 189
Battery charge .....	191
Brakes .....	188
Brake wear .....	191
Bulbs .....	197
Check engine .....	194
Coolant .....	193
Doors .....	197
Engine oil level .....	192
ESP® .....	187, 190
Poly-V-belt .....	191
Preglow .....	194
Reserve fuel .....	193
SRS .....	191
Tire pressure monitor .....	195
Water separator .....	196
Windshield washer fluid .....	196

<b>Indicator lamps</b>	
see Warning and indicator lamps .....	24, 187

<b>Instrument cluster</b> .....	70
Lighting .....	72

Speedometer .....	71
Tachometer .....	71
<b>Instrument cluster illumination</b>	
see Instrument lighting .....	72
<b>Instrument lighting</b> .....	72
<b>Interior light</b>	
Changing bulbs .....	238, 239
<b>Interior lighting</b>	
Changing bulbs .....	233
Front .....	92
Rear .....	92
<b>Interior motion sensor</b> .....	62
<b>ISOFIX (LATCH-type child seat securing system)</b> .....	43

## J

<b>Jack</b> .....	182
Jacking points .....	230
Preparation .....	230
<b>Jump-starting</b> .....	247
<b>Jump-starting connection point in the engine compartment</b> .....	247

## K

<b>Key</b>	
Checking the batteries .....	53
Malfunction .....	217
<b>Kickdown</b> .....	115

## L

<b>Lamp</b>	
Failure indicator .....	89
<b>Language</b>	
Display (vehicles with steering wheel buttons) .....	81
<b>Lashing points and materials</b> .....	146
<b>Lashing points and tie downs</b>	
Permissible tensile load .....	283
<b>License plate lamp</b>	
Changing bulbs .....	236, 237
<b>Lighting</b>	
Bulb failure indicator .....	89
Changing bulbs .....	233, 234
Instrument .....	72
Light switch .....	89

## Lights

Automatic headlamp mode .....	90
Combination switch .....	90
Cornering light function .....	91
Daytime running lamp	
mode .....	74, 82, 89
Interior lighting .....	92
Light switch .....	89
<b>Load distribution</b> .....	146, 152
<b>Loading guidelines</b> .....	144

## Loads

Securing .....	146
Transporting .....	144, 146, 152

## Locator lighting

Setting (vehicles with steering wheel buttons) .....	83
--	----

## Locking

Automatic .....	55
With button .....	55
With key .....	52

## Locking system

see Central locking .....	54
---------------------------	----

## Low-beam headlamps

Automatic headlamps .....	90
Changing bulbs .....	235
Daytime running lamp mode (vehicles without steering wheel buttons) .....	74
Daytime running lamp mode (vehicles with steering wheel buttons) .....	74, 82
Driving abroad .....	138

## M

<b>M+S tires</b> .....	254
<b>Maintenance points under the hood</b> .....	169
<b>Malfunctions</b> .....	187
Message memory (vehicles with steering wheel buttons) .....	78
<b>Maximum speed</b> .....	141
<b>Menu (vehicles with steering wheel buttons)</b>	
Audio .....	77
Message memory .....	78
Operation .....	76
Settings .....	78

Telephone .....	86
Trip computer .....	85
<b>Message memory (vehicles with steering wheel buttons)</b> .....	78
<b>Messages</b>	
Vehicles without steering wheel buttons .....	199
Vehicles with steering wheel buttons .....	201
<b>Mirrors</b>	
Exterior mirrors .....	70
Rear-view mirror .....	69
<b>Mobile phone</b> .....	134
Display message .....	207
Installation .....	277
<b>Monitor</b>	
see Rear view camera .....	122

## O

<b>Occupant safety</b>	
Children in the vehicle .....	41
System overview .....	32
<b>Odometer</b>	
Setting the unit (vehicles with steering wheel buttons) .....	80
<b>On-board computer</b>	
Vehicles without steering wheel buttons .....	72
Vehicles with steering wheel buttons .....	74
<b>Opening/closing the windows</b> .....	60
<b>Outside temperature display</b>	
Vehicles without steering wheel buttons .....	73
Vehicles with steering wheel buttons .....	77
<b>Overhead control panel</b>	
Overview .....	27
<b>Overrevving range</b> .....	71
<b>Overview</b>	
Menus (Vehicles with steering wheel buttons) .....	76

## P

<b>Paint code number</b> .....	277
<b>Paper holder</b> .....	131

<b>Parking</b>	
see Stopping the vehicle and switching off the engine .....	111
<b>Parking aid</b>	
see PARKTRONIC	
<b>Parking brake</b> .....	112
Display message .....	206
<b>Parking lamp</b>	
Changing bulbs .....	235
<b>Parking lamps</b> .....	89
<b>PARKTRONIC</b> .....	119
Activating/deactivating .....	122
Cleaning the sensors .....	163
Indicator lamp .....	215
Malfunction .....	215
Range of the sensors .....	120
Roll-back warning .....	122
Trailer towing .....	122
Warning display .....	121, 215
<b>Partition sliding door</b> .....	59
<b>Perimeter lamp</b>	
Changing bulbs .....	237
<b>Perimeter lamps</b>	
Changing bulbs .....	238
<b>Poly-V-belt</b>	
Malfunction .....	191
<b>Power supply</b>	
Battery isolating switch .....	87
<b>Power supply (trailer)</b> .....	153
<b>Power windows</b> .....	60
<b>Practical advice</b>	
Auxiliary heating .....	216
Central locking system .....	217
Engine .....	212
Fuel and fuel tank .....	220
Headlamps and turn signals .....	219
Windshield wipers .....	219
<b>Preparing for a journey</b> .....	108
Checks in the vehicle .....	108
Visual check of the vehicle exterior .....	108

## R

**Radio**

- Changing stations (vehicles with steering wheel buttons) ..... 77
- Cleaning the display ..... 162
- Setting station selection (vehicles with steering wheel buttons) ..... 84

**Rain/light sensor**

- Setting the sensitivity (vehicles with steering wheel buttons) ..... 84
- Windshield wipers ..... 94

**Range (vehicles with steering**

**wheel buttons) ..... 86**

**Reading lamp ..... 92**

**Rear bench seat ..... 66**

**Rear-compartment air****conditioning**

- Changing the air filter ..... 173
- see Climate control ..... 97

**Rear-compartment heating**

- see Climate control ..... 97

**Rear doors ..... 57**

**Rear fog lamp ..... 90**

- Changing bulbs ..... 236, 237

**Rear lamp**

- Changing bulbs ..... 236, 237

**Rear view camera ..... 122**

- Malfunction ..... 216

- Monitor menu ..... 124

- Switching off the monitor while driving ..... 128

- Switching on ..... 123

- Switching the monitor on/off ..... 123

**Rear-view camera**

- Cleaning ..... 163

- Cleaning the monitor ..... 162

**Rear-view mirror ..... 69**

**Rear window defroster ..... 95**

**Rear window heating**

- Malfunction ..... 211

**Rear window wiper ..... 94**

**Refilling**

- Diesel Exhaust Fluid (DEF) ..... 143

- Tool for DEF tank filler cap ..... 182

**Refrigerant ..... 161**

**Refueling ..... 142**

**Remote control**

- see Key ..... 52

**Replacing bulbs**

- see Changing bulbs ..... 233, 234

**Reserve fuel**

- Tank ..... 72, 193

**Restraint system**

- Display message ..... 203

- Malfunction ..... 191

**Restraint systems**

- see SRS

**Reverse gear**

- Engaging (automatic transmission) ..... 114

**Reverse warning feature ..... 141**

**Rims ..... 280**

**Roll-back warning**

- see PARKTRONIC ..... 122

**Roof carrier ..... 149, 284**

**Roof load (maximum) ..... 284**

**Roof rack**

- see Roof carrier ..... 149, 284

**Roof ventilator in the cargo**

**compartment ..... 108**

## S

**SAE classification (engine oils) ..... 157**

**Safety**

- Children in the vehicle ..... 41

- Child restraint systems ..... 42

- Overview of occupant safety systems ..... 32

**Safety systems**

- see Driving safety systems

**Seat**

- Co-driver's seat ..... 63

- Driver's seat ..... 63

- Folding seat ..... 67

- Luxury seat ..... 63

- Rear bench seat ..... 66

- Standard seat ..... 63

- Suspension seat ..... 63

- Swivel seat ..... 65

- Twin co-driver's seat ..... 65

- Seat belt**
  - Cleaning ..... 162
  - Display message ..... 206
  - Warning lamp ..... 196
- Seat belts**
  - Adjusting the height ..... 35
  - Belt force limiters ..... 35
  - Correct usage ..... 33
  - Emergency Tensioning Devices ..... 35
  - Fastening ..... 34
  - Important safety guidelines ..... 32
  - Releasing ..... 35
  - Safety guidelines ..... 37
  - Special seat belt retractor ..... 43
  - Warning lamp (function) ..... 35
- Seat heating** ..... 68
  - Malfunction ..... 211
- Selector lever position** ..... 114
- Service indicator** ..... 167
- Service products**
  - Bio-diesel ..... 153
  - Brake fluid ..... 159
  - Capacities ..... 287
  - Coolant ..... 160
  - Diesel Exhaust Fluid (DEF) ..... 155
  - Engine oil ..... 156
  - Fuel ..... 153
  - Fuel additive ..... 154
  - Fuel additives ..... 154
  - Power steering fluid ..... 159
  - Refrigerant ..... 161
  - Transmission oil ..... 158
- Settings**
  - Resetting all (vehicles with steering wheel buttons) ..... 78
  - Resetting submenus (vehicles with steering wheel buttons) ..... 79
- Setting the clock**
  - Vehicles without steering wheel buttons ..... 73
- Setting the date**
  - Vehicles without steering wheel buttons ..... 73
  - Vehicles with steering wheel buttons ..... 82
- Setting the time**
  - Vehicles with steering wheel buttons ..... 82
- Shift ranges**
  - Automatic transmission ..... 114
- Side impact air bag** ..... 40
- Side windows**
  - Resetting ..... 61
- Sliding door** ..... 56
  - Cleaning ..... 164
  - Closing assist ..... 57
- Snow chains** ..... 255
- Socket** ..... 133
- Spare wheel**
  - Bracket ..... 185
  - see Spare wheel ..... 185
  - Wheel change ..... 229
- Speed**
  - Setting, see Cruise control ..... 119
- Speed limiter** ..... 141
- Speedometer** ..... 71
  - Setting the unit (vehicles with steering wheel buttons) ..... 80
- SRS (Supplemental Restraint System)**
  - Indicator lamp ..... 36
  - Introduction ..... 36
- Standing lamp**
  - Changing bulbs ..... 235, 236, 237
- Starting the engine** ..... 109
- Steering wheel** ..... 69
  - Adjusting ..... 69
  - Buttons (vehicles with steering wheel buttons) ..... 74
  - With buttons ..... 26
- Stowage spaces and stowage compartments** ..... 129
  - Eyeglasses compartment ..... 131
  - Glove box ..... 131
  - Paper holder ..... 131
  - Stowage compartment above the windshield ..... 130
  - Stowage compartment in the center console ..... 130
  - Stowage compartment in the dashboard ..... 129
  - Stowage compartment in the door ..... 130

- Stowage space above the headliner ..... 130
  - Stowage space under the twin co-driver's seat ..... 130
  - Submenu (on-board computer)**
    - Clock/Date ..... 82
    - Convenience ..... 85
    - Instrument cluster ..... 80
    - Lighting ..... 82
    - Selecting ..... 79
    - Settings overview ..... 79
    - Vehicle ..... 84
  - Summer tires** ..... 254
  - Supplemental Restraint System**
    - see SRS
  - Surround lighting**
    - Setting (vehicles with steering wheel buttons) ..... 83
  - Switching off the alarm (ATA)** ..... 62
  - Switch unit**
    - Additional ..... 28
    - Center console ..... 27
    - Driver's door ..... 28
  - Swivel seat** ..... 65
- T**
- Tachometer** ..... 71
  - Tank content**
    - Reserve fuel warning lamp ..... 193
  - Tank contents** ..... 72
    - Range (vehicles with steering wheel buttons) ..... 86
  - Technical data**
    - Capacities ..... 287
    - Speed ..... 280
    - Tire pressure ..... 281
    - Tires/wheels ..... 280
    - Vehicle dimensions ..... 280
    - vehicle weights ..... 280
  - Telephone** ..... 134
    - Operation (vehicles with steering wheel buttons) ..... 86
  - Temperature**
    - Setting (heating/air conditioning) . 100
    - Setting the unit (vehicles with steering wheel buttons) ..... 80
  - Theft deterrent locking system**
    - Immobilizer ..... 61
  - Tightening torque**
    - Wheel nuts/wheel bolts ..... 232
  - Time**
    - Setting the time (vehicles without steering wheel buttons) ..... 73
    - Setting the time (vehicles with steering wheel buttons) ..... 82
  - tire**
    - Wheel change ..... 229
  - Tire**
    - Labels ..... 279
  - Tire and Loading Information label** .. 279
  - Tire Inflation Pressure label** ..... 279
  - tire pressure**
    - Calling up (vehicles with steering wheel buttons) ..... 260
  - Tire pressure**
    - Calling up (on-board computer) .... 258
    - Checking manually ..... 258
    - Display message ..... 199, 203, 208
    - Maximum ..... 257
    - Recommended ..... 255, 281
    - Setting the unit (vehicles with steering wheel buttons) ..... 81
    - Tables ..... 281
    - Tire and Loading Information label ..... 279
    - Tire Inflation Pressure label ..... 279
    - Tire label ..... 256, 279
    - Warning lamp ..... 195
  - Tire pressure monitoring system**
    - Function/notes ..... 258
  - Tires**
    - Aspect ratio (definition) ..... 270
    - Average weight of the vehicle occupants (definition) ..... 269
    - Bar (definition) ..... 268
    - Characteristics ..... 268
    - Checking ..... 253
    - Definition of terms ..... 268
    - Direction of rotation ..... 272
    - Distribution of the vehicle occupants (definition) ..... 271
    - DOT, Tire Identification Number (TIN) ..... 268

- DOT (Department of Transportation) (definition) ..... 269
- Flat tire ..... 221
- GAWR (Gross Axle Weight Rating) (definition) ..... 269
- GVW (Gross Vehicle Weight) (definition) ..... 269
- GVWR (Gross Vehicle Weight Rating) (definition) ..... 269
- Increased vehicle weight due to optional equipment (definition) ..... 269
- Kilopascal (kPa) (definition) ..... 270
- Labeling (overview) ..... 266
- Load bearing index (definition) ..... 271
- Maximum loaded vehicle weight (definition) ..... 270
- Maximum load on a tire (definition) ..... 270
- Maximum permissible tire pressure (definition) ..... 270
- Maximum tire load ..... 265
- Maximum tire load (definition) ..... 270
- Optional equipment weight (definition) ..... 270
- PSI (pounds per square inch) (definition) ..... 270
- Replacing ..... 271
- Service life ..... 254
- Sidewall (definition) ..... 270
- Speed index (definition) ..... 269
- Storing ..... 273
- Structure and characteristics (definition) ..... 268
- TIN (Tire Identification Number) (definition) ..... 271
- Tire bead (definition) ..... 270
- Tire pressure (definition) ..... 270
- Tire pressures (recommended) ..... 269
- Tire size (data) ..... 280
- Tire size designation, load-bearing capacity, speed index ..... 266
- Tire tread ..... 253
- Tire tread (definition) ..... 270
- Total load limit (definition) ..... 271
- Traction (definition) ..... 271
- Uniform Tire Quality Grading Standards (definition) ..... 269
- Unladen weight (definition) ..... 270
- valve, Snap-In ..... 252
- Wear indicator (definition) ..... 271
- Wheel rim (definition) ..... 269
- Tires and wheels (important safety information)** ..... 252
- tire sealant**
  - Storage location ..... 184
  - Using ..... 222
- Tools**
  - see Vehicle tool kit ..... 182
- Top speed**
  - Technical data ..... 280
- Top Tether** ..... 44
- Touchshift** ..... 114
- Tow-away protection** ..... 62
- Towing** ..... 248
- Towing a trailer**
  - Driving tips ..... 150
- Towing eye** ..... 249
- Tow-starting** ..... 248
- Trailer**
  - Brake force booster malfunction ... 188
  - Coupling up ..... 150
  - Decoupling ..... 152
  - Power supply ..... 153
  - Towing ..... 151
  - Towing with PARKTRONIC ..... 122
  - Trailer tow hitch ..... 284
- Trailer coupling**
  - Permitted weights and loads ..... 285
- Trailer hitch** ..... 284
- Trailer loads and drawbar noseweights** ..... 152
- Transmission oil** ..... 158
- Transport by rail** ..... 140
- Transporting**
  - Load distribution ..... 146, 152
  - Loading ..... 144
  - Securing a load ..... 146
- Trip computer (vehicles with steering wheel buttons)** ..... 85
- Trip meter** ..... 73
  - see Trip odometer
- Trip odometer**
  - Resetting ..... 72



- Troubleshooting**
    - Automatic transmission ..... 214
    - Driving systems ..... 215
  - Turn signals** ..... 90
    - Changing bulbs ..... 235, 236, 237
  - Two-way radio**
    - Installation ..... 277
- U**
- Unlocking**
    - With button ..... 55
    - With key ..... 52
- V**
- Vehicle**
    - Assemblies ..... 174
    - Cleaning ..... 162
    - Dimensions ..... 280
    - Electronics ..... 276
    - Individual settings (vehicles with steering wheel buttons) ..... 78
    - Loading ..... 261
    - Towing ..... 248
    - Tow-starting ..... 248
    - Transporting ..... 250
    - Weights ..... 280
  - Vehicle identification number** ..... 277
  - Vehicle identification plates** ..... 277
  - Vehicle key**
    - Malfunction ..... 217
  - Vehicle tool kit** ..... 182
  - Voltage supply**
    - Fuses ..... 239
- W**
- Warning and indicator lamp**
    - Diesel Exhaust Fluid (DEF) ..... 190
  - Warning and indicator lamps** ..... 24
    - PARKTRONIC ..... 215
    - Seat belt ..... 196
  - Warning lamp** ..... 183
  - Warning tones** ..... 212
  - Warning triangle** ..... 183
  - Washer fluid**
    - Display message ..... 208
    - Indicator lamp ..... 196
    - Topping up ..... 171
    - Wiping with ..... 95
  - Wheel**
    - Changing ..... 229
    - Rim size ..... 280
    - Spare wheel ..... 185
  - Wheel chock** ..... 229
  - Wheel nuts/wheel bolts**
    - Retightening ..... 233
    - Tightening torque ..... 232
  - Wheels**
    - Changing/replacing ..... 271
    - Checking ..... 253
    - Storing ..... 273
    - Wheel size/tire size ..... 280
  - Window curtain air bag** ..... 41
  - Windows**
    - Cleaning ..... 162
    - Cleaning the windshield ..... 163
    - Washing system ..... 95, 171
  - Windshield**
    - Cleaning ..... 163
  - Windshield heater** ..... 95
  - windshield heating**
    - Malfunction ..... 211
  - Windshield washer fluid**
    - Indicator lamp ..... 196
  - Windshield wipers** ..... 94
    - Malfunction ..... 219
    - Rain/light sensor ..... 94
    - Replacing the wiper blades ..... 174
    - Setting the sensitivity (vehicles with steering wheel buttons and rain/light sensor) ..... 84
  - Winter diesel** ..... 154
  - Winter operation** ..... 153, 254
  - Winter tires**
    - M+S tires ..... 254
  - Working speed governor (ADR)** ..... 117
- X**
- Xenon headlamps**
    - see Bi-Xenon headlamps

## Vehicle equipment

-  Diese Betriebsanleitung beschreibt alle Modelle, Serien- und Sonderausstattungen Ihres Fahrzeugs, die zum Zeitpunkt des Redaktionsschlusses dieser Betriebsanleitung erhältlich waren. Länderspezifische Abweichungen sind möglich. Beachten Sie, dass Ihr Fahrzeug nicht mit allen beschriebenen Funktionen ausgestattet sein könnte. Dies betrifft auch sicherheitsrelevante Systeme und Funktionen.

## Environmental protection

### Environmental note

Our declared policy is one of comprehensive environmental protection.

Our objective is to use natural resources, which are the basis of our existence on this planet, sparingly and in a manner that takes the requirements of both nature and humanity into account.

You too can contribute to environmental protection by operating your vehicle in an environmentally responsible manner.

Fuel consumption and engine, transmission, brake and tire wear depend on these two factors:

- operating conditions of your vehicle
- your personal driving style

You can influence both factors.

Observe the following notes: Operating conditions:

- avoid driving short distances as this increases fuel consumption.
- make sure that the tire pressures are always correct.
- do not carry any unnecessary weight in/on the vehicle.
- keep an eye on the vehicle's fuel consumption.

- remove roof racks once you no longer need them.
- a regularly serviced vehicle will contribute to environmental protection. You should therefore adhere to the specified service intervals.
- always have maintenance work carried out at an authorized Sprinter Dealer.

Personal driving style:

- do not depress the accelerator pedal when starting the engine.
- do not warm up the engine when the vehicle is stationary.
- adopt an anticipatory style of driving and keep a sufficient distance from other vehicles.
- avoid frequent, sudden acceleration.
- switch off the engine in stationary traffic.

## Environmental concerns and recommendations

In this manual, whenever you see instructions to discard materials, you should first attempt to reclaim and recycle them. To preserve our environment, follow appropriate environmental rules and regulations when disposing of materials.

## Operating Safety

### Safety notes

#### Warning

Engine exhaust, some of its constituents, and certain vehicle components contain or emit chemicals known to the State of California to cause cancer and birth defects or other reproductive harm.

In addition, certain fluids contained in vehicles, and certain products of component wear contain chemicals known to the State of California to cause cancer and birth defects or other reproductive harm.

Emergency tensioning retractors, airbags and remote control batteries contain perchlorate, which may require special handling and regard for the environment. Check with your local government's disposal guidelines.

California residents: see

<http://www.dtsc.ca.gov/HazardousWaste/Perchlorate/index.cfm>.

### **Warning**

If work on electronic equipment and its software is carried out incorrectly, this equipment could stop working. The electronic systems are networked via interfaces. Tampering with these electronic systems could cause malfunctions in systems which have not been modified. Malfunctions such as these can seriously jeopardize the vehicle's operating safety and therefore your own safety.

You should therefore have all work and modifications to electronic components carried out at a qualified specialist workshop.

### **Warning**

A heavy impact to the underbody, tires or wheels, for example when bottoming out on rough terrain or driving over an obstacle at high speed, could damage your vehicle. This also applies to vehicles equipped with underbody protection.

In this case, have your vehicle checked at an authorized Sprinter Dealer. In particular, work relevant to safety or on safety-related systems must be carried out at an authorized Sprinter Dealer.

### **Warning**

Always have maintenance work carried out at an authorized Sprinter Dealer which has the necessary specialist knowledge and tools to carry out the work required. In particular, work relevant to safety or on safety-related systems must be carried out at an authorized Sprinter Dealer.

## **Service and warranty information**

The Service and Warranty Information Booklet contains detailed information about the warranties covering your Sprinter, including

- New Vehicle Limited Warranty
- Diesel Engine Limited Warranty
- Corrosion Warranty
- Restraint System Limited Warranty (vehicles sold and registered in the State of Kansas only)
- Emission Warranties required by law.

## **Registering your vehicle**

We may instruct our authorized Sprinter Dealer to carry out technical inspections on certain vehicles to improve their quality or safety.

If you did not purchase your vehicle from an authorized dealership and your vehicle has not yet been inspected at an authorized Sprinter Dealer, there is a possibility that your vehicle has not been registered in your name.

We will only be able to inform you about vehicle inspections if we are in possession of your registration data.

It is advisable to have your vehicle registered at an authorized Sprinter Dealer.

Inform us as soon as possible if your address has changed or if there has been a change of vehicle owner.

## **Digital speedometer and total distance recorder**

Do not allow the electronically stored total distance covered by your vehicle to be modified as a result of tampering with the electronics system.

This type of modification or failing to inform the buyer when selling the vehicle could constitute an offense punishable by law.

### Modifying the engine power output

Having the engine power output of your vehicle increased by tampering with the electronic engine management system will invalidate the vehicle's general operating permit and insurance coverage, as well as your New Vehicle Limited Warranty and warranty entitlement.

Modifications to the output of the engine must be reported to the insurance provider and require the vehicle to be recertified. The tires, chassis, brake and cooling systems must be adapted to the increased engine power output.

Tampering with the electronic engine management system modifies emission values and it will not be possible to guarantee the operating safety of the engine in every case. Increases in performance may lead to malfunctions and consequential damage to other assemblies.

If you sell the vehicle, failing to inform the buyer of the modified engine power output could constitute an offense punishable by law, depending on the country concerned.

### Diesel particle filter

**!** If the vehicle is predominantly used for short-distance driving, this could lead to a malfunction in the automatic cleaning function for the diesel particle filter. As a result, fuel may accumulate in the engine oil and cause engine failure.

Therefore, if you mainly drive short distances, you should drive on a highway or on rural roads for 20 minutes every 310 miles (500 km). This ensures sufficient regeneration of the diesel particle filter.

### Vehicle alterations

We recommend the use of genuine Sprinter parts and conversion parts as well as

accessories that have been expressly approved for your vehicle model.

These parts have been subjected to special tests in order to determine their safety, reliability and suitability.

**!** For safety reasons, have add-on equipment prepared and installed according to the Sprinter body/equipment mounting directives in force. These body/equipment mounting directives guarantee that the chassis and add-on equipment form a cohesive whole and that the highest possible level of operating and driving safety is reached.

We recommend for safety reasons that:

- you carry out no other modifications to the vehicle.
- you obtain the agreement of the distributor named on the inside of the front cover for any deviations from the approved body/equipment mounting directives.

Approval by official testing centers or permission given by authorities do not eliminate safety risks.

**!** The wooden or plastic cargo area floor fitted at the factory is an integral component of the vehicle structure. The vehicle body could be damaged if you have the load area floor removed. This then affects the securing of loads and the maximum loading capacity of the lashing points is no longer guaranteed.

Therefore, do not have the load area floor removed.

Even seemingly small changes to the vehicle, such as attaching a radiator cover for winter driving or as protection against insects, are not allowed. These could cause the engine diagnostics to register incorrect data. The recording of engine diagnostic data is a legal requirement, and must always be verifiable and accurate.

## Sprinter body builder guideline

If you intend on making any alterations to the vehicle, we strongly recommend that you contact the distributor named on the inside of the front cover in order to obtain all necessary information (there may be a charge).

Body builders and dealers who make any modifications which may affect the final certification of the engine, vehicle or equipment assume the sole responsibility for the vehicle, including labeling and documentation, affected by their modifications.

It is their responsibility to certify that the altered vehicle conforms to all applicable standards and regulations affected by the vehicle alteration or continues to comply with the motor vehicle safety standards and emissions regulations.

They are responsible for ensuring that modifications or equipment installation do not affect the safety of the vehicle.

### Warning

Any modifications or alterations of the Sprinter not in compliance with the Sprinter Body Builder Guideline and the Sprinter Operator's Manual may seriously inhibit its roadworthiness and safety and may lead to an accident resulting in serious injury or death. Consult the Sprinter Body Builder Guideline and the Sprinter Operator's Manual prior to initiating any alterations or modifications.

We are not responsible for any final certification or claims regarding product liability, or warranty claims, which result from any component, assembly, or system being altered, or which cause non-compliance with any of the emission control standards or motor vehicle safety standards, or which would otherwise cause the vehicle to be or to become defective or unsafe.

We do not assume responsibility as the final-stage manufacturer or the consequential product liability.

## Correct use

Observe the following information when using your vehicle:

- the safety notes in this manual
- the "Technical data" section in this manual
- traffic rules and regulations
- motor vehicle laws and safety standards

## Substances constituting a health hazard

Do not store or transport in the cab any substances that constitute a health hazard or react aggressively.

These include:

- solvents
- fuels
- oils and greases
- cleaning agents
- acids

### Warning

Do not store or transport in the cab any substances that constitute a health hazard or react aggressively. Gases and liquids may escape from containers that are completely sealed.

The driver's ability to concentrate while the vehicle is in motion and the driver's health could be affected. In addition, electrical components (e. g. control units and connectors) could be damaged. This can result in malfunctions, system failures, or short circuits which can start a fire.

You could cause an accident, thereby endangering yourself and others.

## Stickers and warning labels

### Warning!

Various warning labels are attached to your vehicle. These warning labels are intended to make you and others aware of various risks. Do not remove any of these warning labels

unless explicitly instructed to do so by information on the label itself.

Removing warning labels may cause you and others to be unaware of certain risks which may result in an accident and/or personal injury.

### Problems with your vehicle

If you should experience a problem with your vehicle, particularly one that you believe may affect its safe operation, we urge you to immediately contact an authorized Sprinter Dealer to have the problem diagnosed and corrected if required.

If the matter is not handled to your satisfaction, please discuss the problem with the Sprinter Dealer management, or if necessary contact the distributor named on the inside of the front cover.

### Reporting safety defects

#### In the USA:

In all 50 states and Washington, D.C.:

If you believe that your vehicle has a defect, which could cause a crash or cause injury or death, you should immediately inform the National Highway Traffic Safety Administration (NHTSA) in addition to notifying the distributor.

If NHTSA receives similar complaints, it may open an investigation, and if it finds that a safety defect exists in a group of vehicles, it may order a recall and remedy campaign. However, NHTSA cannot become involved in individual problems between you, your dealer and the vehicle distributor.

To contact NHTSA, you may either call the Auto Safety Hotline toll free at 1-888-327-4236 (TTY: 1-800-424-9153),

or go to <http://www.safercar.gov>

or write to:

Administrator, NHTSA, 400 Seventh Street, SW., Washington, DC 20590.

#### In Canada:

If you believe that your vehicle has a safety defect, you should contact immediately the Customer Service Department of the distributor named on the inside of the front cover.

### Information regarding electronic recording devices

(Including notice pursuant to California Code § 9951)

Please note that your vehicle is equipped with devices that can record vehicle system data. This information helps, for example, to diagnose vehicle systems after a collision and to continuously improve vehicle safety. We may access the information and share it with others:

- for safety research or vehicle diagnosis purposes
- with the consent of the vehicle owner or lessee
- in response to an official request by a law enforcement or other government agency
- for use in dispute resolution involving Daimler, its affiliates or sales / service organization and / or
- as otherwise required or permitted by law

Cockpit .....	22
Instrument cluster variants .....	24
Steering wheel with buttons .....	26
Center console .....	26
Switch units .....	27

## Cockpit

## Cockpit

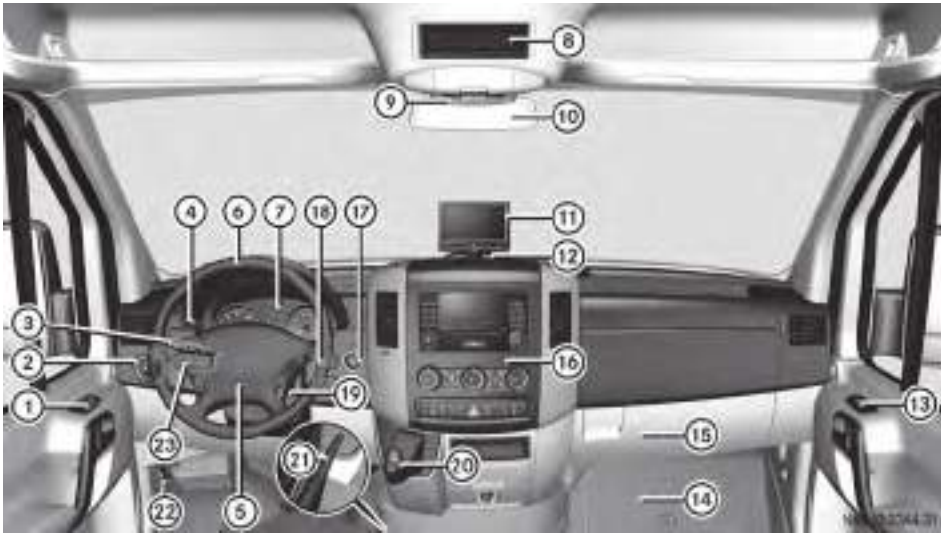

**1** This Operator's Manual describes all the standard and optional equipment available for your vehicle at the time of purchase. Country specific differences are possible. Please note that your vehicle might not be equipped with all the functions described here. This also includes safety relevant systems and functions.

	Function	Page
①	Door control panel	28
②	Light switch	89
③	Combination switch: <ul style="list-style-type: none"> <li>• turn signals</li> <li>• high-beam headlamps</li> <li>• windshield wipers</li> <li>• rear window wiper</li> </ul>	90 90 94 94
④	Cruise control lever	118
⑤	Horn	
⑥	Steering wheel without/ with buttons	26

	Function	Page
⑦	Instrument cluster	24
⑧	Stowage compartment	
⑨	• Stowage compartment with interior light • Overhead control panel	92 27
⑩	Rear-view mirror	69
⑪	Rear-view camera monitor	122
⑫	PARKTRONIC warning display	119
⑬	Opens/closes the right- hand side window	60
⑭	Jack and vehicle tool kit	182
⑮	Glove box	131
⑯	Center console	26
⑰	Ignition lock	56
⑱	Additional switch unit	28



	Function	Page
⑲	Steering wheel adjustment	69
⑳	Selector lever (automatic transmission)	109
㉑	Parking brake	112

	Function	Page
㉒	Opens the hood	168
㉓	Additional switch unit	28



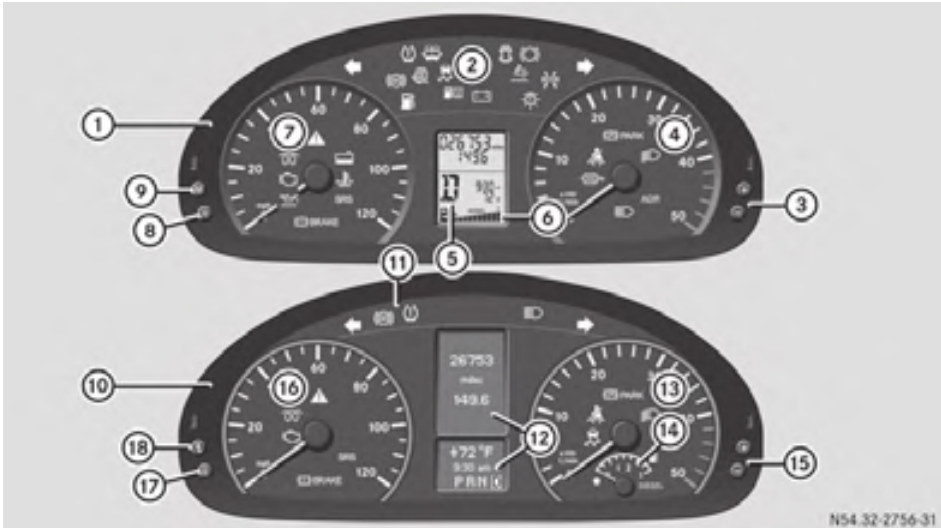













## Instrument cluster variants















N54.32-2756-31

	Function	Page
①	<b>Instrument cluster on vehicles without steering-wheel buttons</b>	70
②	Indicator and warning lamps	
③	⊕, ⊖ Brightens/dims the instrument cluster lighting	72
④	Tachometer with indicator and warning lamps	71
⑤	Display	73
⑥	Fuel gauge with fuel filler flap location indicator	72
⑦	Speedometer with indicator and warning lamps	71
⑧	Reset button ①	70
⑨	Ⓜ Menu button: • changes standard display • selects menus	73 73

	Function	Page
⑩	<b>Instrument cluster on vehicles with steering-wheel buttons</b>	70
⑪	Indicator and warning lamps	
⑫	Display	74
⑬	Tachometer with indicator and warning lamps	71
⑭	Fuel gauge with fuel filler flap location indicator	72
⑮	⊕, ⊖ Brightens/dims the instrument cluster lighting	72
⑯	Speedometer with indicator and warning lamps	71
⑰	Reset button ①	70
⑱	Ⓜ Service button Checks the engine oil level	171
	<b>Indicator and warning lamps</b>	

	Function	Page
	ESP® warning lamp	50, 187
	ASR warning lamp	48, 187
	Coolant level too low	193
	Coolant temperature too high	193
	Restraint systems malfunction	191
	Brake fluid level too low	188
	EBD malfunction	187
	Trailer brake force booster malfunction	188
	Engine oil level warning	192
	Engine diagnostics indicator lamp	194
	Exhaust gas aftertreatment malfunction	195
	Preglow system	194
	Left-hand turn signal	90
	Tire pressure loss or the tire pressure monitor is malfunctioning (USA only)	195
	Tire pressure loss (Canada only)	195
	Fluid level too low in windshield washer/headlamp cleaning system	196
	Door open	197
	Brake pads/linings worn	191
	Right-hand turn signal	90
	ABS malfunction	189
	ASR malfunction	189
	BAS malfunction	189
	ESP® malfunction	187

	Function	Page
	DEF supply low or contaminated/thinned	199
	Exhaust gas aftertreatment malfunction	200
	Dirt accumulation in air filter	195
	Reserve fuel	193
	Fuel filler cap open	194
	Water in the fuel	196
	Battery charging malfunction	191
	Bulb defective	197
	Parking brake applied	112
	Low-beam headlamps on	89
	Working speed governor (ADR) on	117
	High-beam headlamps on	90
	Reserve fuel	193
	Fuel filler cap open	194
	Fasten seat belt	196

**i** Vehicles with steering-wheel buttons: Corresponding messages may also be shown in display ⑫ (> page 24).

## Steering wheel with buttons

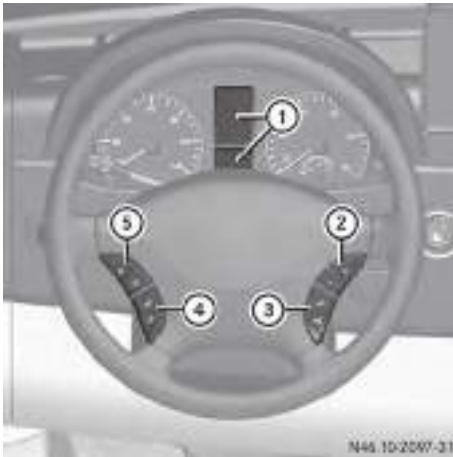

	Function	Page
①	Display	74
	<b>Controls the on-board computer</b>	
②	Selects a submenu or adjusts the volume <input type="checkbox"/> Up/increases the volume <input type="checkbox"/> Down/reduces the volume	74
③	Using the telephone <input type="checkbox"/> Accepts a call/starts dialing <input type="checkbox"/> Ends a call/rejects an incoming call	86
④	Scrolling from one menu to another <input type="checkbox"/> Forwards <input type="checkbox"/> Back	74
⑤	Scrolling from one submenu to another <input type="checkbox"/> Forwards <input type="checkbox"/> Back	74

## Center console



	Function	Page
①	Stowage compartment	130
②	Radio; see the separate operating instructions	
③	Air-conditioning control panel	97
④	Center console switch unit	27
⑤	<ul style="list-style-type: none"> <li>• Stowage compartment or</li> <li>• CD changer; see the separate operating instructions</li> </ul>	
⑥	Cup holder with <ul style="list-style-type: none"> <li>• ashtray</li> <li>• cigarette lighter</li> </ul>	132 128 129
⑦	12 V socket	133

## Switch units

## Center console



	Function	Page
	Switches the left/right-hand seat heating on/off	68
	Switches the windshield heating on/off	95
	Switches the rear window defroster on/off	95
	Activates/deactivates PARKTRONIC	122
	Switches the hazard warning lamps on/off	91
	Activates/deactivates ASR	48
	Central locking, interior/rear compartment	54

## Roof

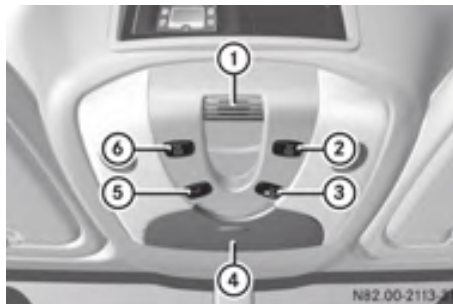

	Function	Page
①	Microphone for the telephone	134
②	Switches the right-hand reading lamp on/off	92
③	Switches the automatic interior lighting on/off	92
④	<ul style="list-style-type: none"> <li>• Eyeglasses compartment or</li> <li>• Anti-theft alarm system (ATA)</li> </ul>	131 61
⑤	Switches the interior lighting on/off	92
⑥	Switches the left-hand reading lamp on/off	92

## Driver's door



	Function	Page
①	Adjusts the exterior mirrors	70
②	Selects an exterior mirror	70
③	Opens/closes the left-hand side window	61
④	Opens/closes the right-hand side window	61

## Additional switch units





Switch unit between the light switch and the steering wheel

	Function	Page
	Switches the auxiliary heating on/off	104
	Switches the heater booster function on/off	104
	Sets the working speed	117
	Switches the working speed governor (ADR) on/off	117
	Ventilates the cargo compartment	108



Switch unit between the steering wheel and ignition lock

	Function	Page
	Switches the rear-compartment convenience lighting on/off	92
		





Vehicle equipment .....	32
Occupant safety .....	32
Emergency exit .....	45
Driving safety systems .....	47

## Vehicle equipment

- i** Diese Betriebsanleitung beschreibt alle Modelle, Serien- und Sonderausstattungen Ihres Fahrzeugs, die zum Zeitpunkt des Redaktionsschlusses dieser Betriebsanleitung erhältlich waren. Länderspezifische Abweichungen sind möglich. Beachten Sie, dass Ihr Fahrzeug nicht mit allen beschriebenen Funktionen ausgestattet sein könnte. Dies betrifft auch sicherheitsrelevante Systeme und Funktionen.

## Occupant safety

### Restraint systems

In this section you will learn the most important facts about the restraint system components of the vehicle.

The restraint systems are:

- Seat belts
- Child restraint systems
- LATCH-type (ISOFIX) child seat securing system

Additional protection potential is provided by SRS (Supplemental Restraint System) and the air bag system.

The protective functions of the systems work in conjunction with each other. The systems are, however, autonomous.

### Warning

Modifications to or work improperly conducted on restraint system components or their wiring, as well as tampering with interconnected electronic systems, can lead to the restraint systems no longer functioning as intended.

Air bags or Emergency Tensioning Devices (ETDs), for example, could deploy inadvertently or fail to deploy in accidents although the deceleration threshold for air bag deployment is exceeded. Therefore, never modify the restraint systems. Do not

tamper with electronic components or their software.

- i** More information on the subject of children in the vehicle and child restraint systems can be found in the "Children in the vehicle" section (▷ page 41).

## Seat belts

### Important safety notes

The use of seat belts and infant or child restraints is required by law in all 50 states, the District of Columbia, the U.S. territories and all Canadian provinces.

Even if this is not the case, all vehicle occupants should have their seat belts fastened when the vehicle is in motion.

- i** See "Children in the vehicle" (▷ page 41) for further information on infants and children traveling in the vehicle as well as on child restraint systems.

### Warning!

Always fasten your seat belt before driving off. Always make sure all of your passengers are properly restrained. You and your passengers should always wear seat belts.

Failure to wear and properly fasten and position your seat belt greatly increases your risk of injuries and their likely severity in an accident.

If you are ever in an accident, your injuries can be considerably more severe without your seat belt properly buckled. Without your seat belt buckled, you are much more likely to hit the interior of the vehicle or be ejected from it. You can be seriously injured or killed.

In the same crash, the possibility of injury or death is lessened if you are properly wearing your seat belt. The air bags can only protect as intended if the occupants are properly wearing their seat belts.

 **Warning**

Never ride in a moving vehicle with the seat backrest in an excessively reclined position as this can be dangerous. You could slide under the seat belt in a collision. If you slide under it, the seat belt would apply force at the abdomen or neck. That could cause serious or even fatal injuries. The seat backrest and seat belt provide the best restraint when the wearer is in a position that is as upright as possible and the seat belt is properly positioned on the body.

 **Warning**

Never let more people ride in the vehicle than there are seat belts available. Make sure everyone riding in the vehicle is correctly restrained with a separate seat belt. Never use a seat belt for more than one person at a time.

 **Warning**

Damaged seat belts or seat belts that have been subjected to stress in an accident must be replaced and their anchoring points must also be checked.

Only use seat belts which have been approved by the distributor named on the inside of the front cover.

Do not make any modifications to the seat belts. This can lead to unintended activation of the ETDs or to their failure to activate when necessary.

Do not bleach or dye seat belts as this may severely weaken them. In a crash they may not be able to provide adequate protection.

Have all work carried out only by qualified technicians. Contact an authorized Sprinter Dealer.

**Proper use of the seat belts** **Warning****USE SEAT BELTS PROPERLY**

- Seat belts can only protect when used properly. Never wear seat belts in any other way than as described in this section, as that could result in serious injuries in case of an accident.
- Each occupant should wear their seat belt at all times, because seat belts help reduce the likelihood of and potential severity of injuries in accidents, including rollovers. The integrated restraint system includes SRS (driver's front air bag, front-passenger front air bag, side impact air bags, window curtain air bags for door windows), Emergency Tensioning Devices, seat belt force limiters, and front seat knee bolsters. The system is designed to enhance the protection offered to properly belted occupants in certain frontal (front air bags and ETDs) and side (side impact air bags, window curtain air bags, and ETDs) impacts which exceed preset deployment thresholds and in certain rollovers (window curtain air bags and ETDs).
- Never wear the shoulder belt under your arm, across your neck or not routed across your shoulder. In a frontal crash, your body would move too far forward. That would increase the chance of head and neck injuries. The seat belt would also apply too much force to the ribs or abdomen, which could severely injure internal organs such as your liver or spleen.

Adjust the seat belt so that the shoulder section is located as close as possible to the middle of the shoulder. It should not touch the neck. Never pass the shoulder portion of the seat belt under your arm. For this purpose, you can adjust the height of the seat belt outlet.

- Position the lap belt as low as possible on your hips and not across the abdomen. If the lap belt is positioned across your

abdomen, it could cause serious injuries in a crash.

- Never wear seat belts over rigid or breakable objects in or on your clothing, such as eyeglasses, pens, keys etc., as these might cause injuries.
- Make sure the seat belt is always routed snugly. Take special care of this when wearing loose clothing.
- Never use a seat belt for more than one person at a time. Do not fasten a seat belt around a person and another person or other objects at the same time.
- Seat belts should not be worn twisted. In a crash, you would not have the full width of the seat belt to distribute impact forces. The twisted seat belt against your body could cause injuries.
- Pregnant women should also always use a lap-shoulder belt. The lap belt portion should be positioned as low as possible on the hips to avoid any possible pressure on the abdomen.
- Place the seat backrest in a position that is as upright as possible.
- Check your seat belt during travel to make sure it is properly positioned.
- Never place your feet on the instrument panel, dashboard, or on the seat. Always keep both feet on the floor in front of the seat.
- When using a seat belt to secure infant restraints, toddler restraints, or children in booster seats, always follow the child seat manufacturer's instructions.

### Warning

Do not pass seat belts over sharp edges. They could tear.

Do not allow the seat belt to get caught in the door or in the seat adjustment mechanism. This could damage the seat belt.

Never attempt to make modifications to seat belts. This could impair the effectiveness of the seat belts.

## Fastening seat belts

### Warning

According to accident statistics, children are safer when properly restrained on the rear seats than on the front-passenger seat. Thus, we strongly recommend that children be placed in the rear seat whenever possible. Regardless of seating position, children 12 years old and under must be seated and properly secured in an appropriately sized child restraint system or booster seat recommended for the size and weight of the child. For additional information, see the "Children in the vehicle" section.

A child's risk of serious or fatal injuries is significantly increased if the child restraints are not properly secured in the vehicle and/or the child is not properly secured in the child restraint.

- ▶ Adjust the seat and move the backrest to an almost vertical position (> page 63).



- ▶ Pull the seat belt smoothly through belt sash guide ①.

- ▶ Without twisting it, place the shoulder section of the seat belt over the center of the shoulder and the lap section across the hips.
- ▶ Engage belt tongue ② in buckle ④.
- ▶ If necessary, adjust the seat belt to the appropriate height (▷ page 35).
- ▶ If necessary, pull upwards on the shoulder section of the seat belt to tighten the belt across your body.

All seat belts in the vehicle, except the driver's seat belt, are equipped with a special seat belt retractor to secure child restraint systems properly. For further information on "Special seat belt retractors", see (▷ page 43).

For more information about releasing the seat belt with release button ④, see "Releasing seat belts" (▷ page 35).

### Adjusting the seat belt height

You can adjust the seat belt height on the driver's seat and the outer co-driver's seat.

Adjust the belt to a height that allows the upper part of the seat belt to be routed across the center of your shoulder.



- ▶ **To raise:** slide belt sash guide ① upwards. The belt sash guide engages in various positions.

- ▶ **To lower:** press and hold belt sash guide release ⑤.
- ▶ Slide belt sash guide ① downwards.
- ▶ Release belt sash guide release ⑤ and make sure that belt sash guide ① has engaged.

### Releasing seat belts

- ▶ Press release button ③ and guide belt tongue ② back towards belt sash guide ①.

⚠ Make sure that the seat belt retracts fully. The seat belt or belt buckle may otherwise become trapped in the door or the seat adjustment mechanism. This could damage the door, door trim panels and the seat belt. Damaged seat belts can no longer provide the intended degree of protection and must be replaced. Contact an authorized Sprinter Dealer.

### Belt warning for drivers and co-drivers

Regardless of whether the driver's and co-driver's seat belts have already been fastened, the  seat belt warning lamp lights up for six seconds each time the engine is started. It then goes out once the driver and the front passenger have fastened their seat belts.

If the driver's seat belt is not fastened after the engine is started, an additional warning tone will sound. The warning tone goes out after approximately six seconds or once the driver's seat belt is fastened.

### Emergency Tensioning Devices, seat belt force limiters

If the vehicle is equipped with a driver's front air bag, the seat belts on the driver's and co-driver's seats have ETDs.

⚠ If the front-passenger seat is not occupied, do not engage the seat belt tongue in the buckle on the front-passenger seat. Otherwise, the Emergency

Tensioning Device could be triggered in the event of an accident.

ETDs help remove slack in the seat belts in an accident, pulling the seat belt close against the occupant's body.

ETDs do not correct incorrect seat positions or incorrectly fastened seat belts.

ETDs do not pull vehicle occupants back towards the backrest.

If the seat belt is also equipped with a seat belt force limiter and this is triggered, the force exerted by the seat belt on the vehicle occupant is reduced.

The seat belt force limiters are synchronized with the front air bags, which take on a part of the deceleration force in an accident. Thus, the force exerted on the occupant is distributed over a greater area.

The ETDs can only be triggered if the ignition is switched on and the restraint systems are operational, see "SRS warning lamp" .

The ETDs are triggered depending on the type and severity of an accident:

- in the event of a head-on or rear-end collision, if the vehicle decelerates or accelerates rapidly in a longitudinal direction during the initial stages of the impact
- in the event of a side impact if the vehicle decelerates or accelerates rapidly in a lateral direction and the vehicle is equipped with side impact air bags and/or window curtain air bags
- in certain situations, if the system detects that the vehicle will overturn

If the ETDs are triggered, you will hear a bang and powder may also be released. In rare cases the bang may temporarily affect your hearing. The power emitted is generally not hazardous to health. The **SRS** SRS indicator lamp lights up.

#### **Warning**

Pyrotechnic ETDs that were activated must be replaced.

For your safety, when disposing of the pyrotechnic ETDs always follow our safety instructions. These are available at any authorized Sprinter Dealer.

## **SRS (Supplemental Restraint System)**

### **Introduction**

SRS reduces the risk of occupants hitting the vehicle interior in the event of an accident. In addition, it can reduce the forces the occupants are subjected to during an accident.

SRS consists of:

- the **SRS** SRS indicator lamp
- air bags
- air bag control unit (with crash sensors)
- ETDs for the driver's and co-driver's seat
- seat belt force limiters, for the driver's and co-driver's seat

### **SRS** indicator lamp

The SRS system conducts a self-test when the ignition is switched on and in regular intervals while the engine is running. This facilitates detection of system malfunctions.

The **SRS** SRS indicator lamp in the instrument cluster comes on when the ignition is switched on.

It goes out no later than a few seconds after the engine has been started.

The SRS components are in operational readiness when the **SRS** SRS indicator lamp is not lit while the engine is running.

#### **Warning**

The SRS self-check has detected a malfunction if the **SRS** SRS indicator lamp:

- does not come on at all
- fails to go out approximately 4 seconds after the engine was started
- comes on after the engine was started or while driving

For your safety, we strongly recommend having the system checked by an authorized Sprinter Dealer immediately. Otherwise SRS may not be activated when it is needed in an accident, which could result in serious or fatal injury. SRS might also deploy unexpectedly and unnecessarily which could also result in injury.

In addition, improper work on SRS creates a risk of rendering SRS inoperative or causing unintended air bag deployment. Work on SRS must therefore be performed by qualified technicians. Contact an authorized Sprinter Dealer.

If it is necessary to modify an air bag system to accommodate a person with disabilities, contact an authorized Sprinter Dealer for details.

USA only: for detailed information, please consult our Customer Assistance Center at 1-877-762-8267.

## Safety guidelines for the seat belts, the Emergency Tensioning Devices and the air bags

### Warning

- Damaged seat belts or seat belts that have been subjected to stress in an accident must be replaced and their anchoring points must also be checked. Only use seat belts which have been installed or supplied by an authorized Sprinter Dealer.
- Air bags and pyrotechnic Emergency Tensioning Devices (ETDs) contain perchlorate material, which may require special handling and regard for the environment. Check with your local government's disposal guidelines. California residents, see [www.dtsc.ca.gov/HazardousWaste/Perchlorate/index.cfm](http://www.dtsc.ca.gov/HazardousWaste/Perchlorate/index.cfm).
- Air bags and ETDs are designed to function on a one-time-only basis. An air bag or ETD that has deployed must be replaced.
- Do not pass seat belts over sharp edges. They could tear.
- Do not make any modification that could change the effectiveness of the seat belts.
- Do not bleach or dye seat belts as this may severely weaken them. In a crash they may not be able to provide adequate protection.
- No modifications of any kind may be made to any components or wiring of the SRS.
- Do not change or remove any component or part of the SRS.
- Do not install additional paneling, seat covers, badges etc. over the steering wheel hub, co-driver's front air bag cover, outboard sides of the seat backrests, door trim panels, or door frame trims.
- Do not install additional electrical/ electronic equipment on or near SRS components and wiring.
- Keep the area between air bags and occupants free of objects (e.g. packages, purses, umbrellas etc.).
- Do not hang items such as coat hangers from the coat hooks or handles over the door. These items may be thrown around in the vehicle and cause head and other injuries when the window curtain air bag is deployed.
- Air bag system components will be hot after an air bag has inflated. Do not touch them.
- Never place your feet on the instrument panel or on the seat. Always keep both feet on the floor in front of the seat.
- Improper repair work creates a risk of rendering the SRS inoperative or causing unintended air bag deployment. Work on the SRS must therefore only be performed by qualified technicians. Contact an authorized Sprinter Dealer.
- For your protection and the protection of others, when scrapping the air bag unit or ETD, our safety instructions must be

followed. These instructions are available from any authorized Sprinter Dealer.

- Given the considerable deployment speed, required inflation volume, and the material of the air bags, there is the possibility of abrasions or other, potentially more serious injuries resulting from air bag deployment.

If you sell your vehicle, we strongly recommend that you inform the subsequent owner that the vehicle is equipped with SRS. Also refer them to the applicable section in the Operator's Manual.

## Air bags

### Important safety notes

#### Warning

Air bags are designed to reduce the incidence of injuries and fatalities in certain situations:

- frontal impacts (driver's and front-passenger front air bags)
- side impacts (side impact air bags and window curtain air bags)
- rollover (window curtain air bags)

However, no system available today can completely eliminate injuries and fatalities.

When the air bags are deployed, a small amount of powder is released. The powder generally does not constitute a health hazard and does not indicate that there is a fire in the vehicle. In order to prevent potential breathing difficulties, you should leave the vehicle as soon as it is safe to do so. If you have any breathing difficulty but cannot get out of the vehicle after the airbag inflates, then get fresh air by opening a window or door.

#### Warning

To reduce the risk of injury when the front air bags inflate, it is very important for the driver and co-driver to always be in a properly seated

position and to wear their respective seat belt.

For maximum protection in the event of a collision always be in normal seated position with your back against the seat backrest. Fasten your seat belt and make sure it is properly positioned on your body.

Since the air bag inflates with considerable speed and force, a proper seating position and correct positioning of the hands on the steering wheel will help to keep you at a safe distance from the air bag. Occupants who are not wearing their seat belt, are not seated properly or are too close to the air bag can be seriously injured or killed by an air bag as it inflates with great force instantaneously:

- Sit with the seat belt properly fastened in a position that is as upright as possible with your back against the seat backrest.
- Move the driver's seat as far back as possible, still permitting proper operation of vehicle controls. The distance from the center of the driver's chest to the center of the air bag cover on the steering wheel must be at least 10 inches (25 cm) or more. You should be able to accomplish this by adjusting the seat and steering wheel. If you have any difficulties, please contact an authorized Sprinter Dealer.
- Do not lean your head or chest close to the steering wheel or instrument panel.
- Keep hands on the outside of the steering wheel rim. Placing hands and arms inside the rim can increase the risk and potential severity of hand/arm injury when the driver front air bag inflates.
- Move the co-driver's seat as far as possible away from the instrument panel when the seat is occupied.
- Occupants, especially children, should never place their bodies or lean their heads in the area of the door where the side impact air bag inflates. This could result in serious injuries or death should the side impact air bag be deployed. Always sit as upright as possible, wear the seat belt



properly and use an appropriately sized infant restraint, toddler restraint, or booster seat recommended for the size and weight of the child.

- Children twelve years old and under must never travel on the co-driver's seat. They will otherwise be struck by the co-driver's front air bag when it inflates in a crash. This could result in serious or fatal injury.

Failure to follow these instructions can result in severe injuries to you or other occupants. If you sell your vehicle, it is important that you make the buyer aware of this safety information. Be sure to give the buyer this Operator's Manual.

### Warning

Accident research shows that the safest place for children in an automobile is in a rear seat. A side impact air bag related injury may occur if occupants, especially children, are not properly seated or restrained when next to a side impact air bag which needs to deploy rapidly in a side impact in order to do its job. To help avoid the possibility of injury, please follow these guidelines:

- (1) Occupants, especially children, should never place their bodies or lean their heads in the area of the door where the side impact air bag inflates. This could result in serious injuries or death should the side impact air bag be deployed.
- (2) Always sit as upright as possible and use the seat belts properly. Make sure that children 12 years old and under use an appropriately sized child restraint, infant restraint, or booster seat recommended for the size and weight of the child.
- (3) Always wear seat belts properly.

The air bags are only deployed if the air bag control unit detects the need for deployment.

Only in the event of such a situation will they provide their supplemental protection.

The driver and passenger should always wear their seat belts. Otherwise, it is not possible for the air bags to provide their supplemental protection.

In the event of other types of impacts and impacts below air bag deployment thresholds, air bags will not deploy. The driver and passengers will then be protected to the extent possible by a properly fastened seat belt. A properly fastened seat belt is also needed to provide the best possible protection in a rollover.

Air bags provide supplemental protection, but are not a substitute for the seat belts. All vehicle occupants must fasten their seat belts regardless of whether your vehicle is equipped with air bags or not.

It is important for your safety and that of your passengers to have deployed air bags replaced and to have any malfunctioning air bags repaired. This will help to make sure the air bags continue to perform their protective function for the vehicle occupants in the event of a crash.

### Front air bags

#### Warning

Observe "Important safety notes" ( page 38).

The front air bags increase the degree of protection afforded to the driver and co-driver against head and chest injuries.

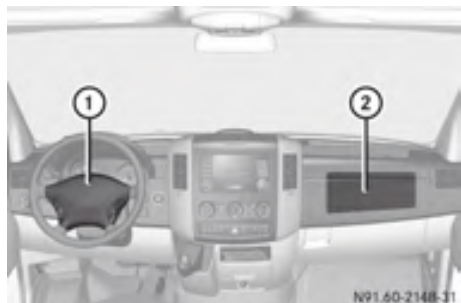

N91.60-2148-31

Driver's front air bag ① deploys in front of the steering wheel; co-driver's front air bag ② deploys in front of and above the glove box. They are deployed:

- in the event of certain frontal impacts
- if the system determines that air bag deployment can offer additional protection to that provided by the seat belt
- if the respective seat belt is fastened
- independently of other air bags in the vehicle

If the event of a rollover, the front air bags are generally not deployed unless the system detects high vehicle deceleration in a longitudinal direction.

The air bags will not deploy in impacts which do not exceed the system's preset deployment thresholds. You will then be protected by the seat belt, provided that it is fastened.

### Side impact air bags

#### Warning

Observe "Important safety notes" (▷ page 38).

#### Warning

If you wish to use seat covers, we recommend for safety reasons that you use only those approved for Sprinter vehicles.

The seat covers must feature a special tear seam for the side impact air bags. The side impact air bag may otherwise not deploy correctly and may fail to provide the intended degree of protection in the event of a collision. Suitable seat covers can be obtained from any authorized Sprinter Dealer.

#### Warning

The pressure sensors for side impact air bag control are located in the doors. Do not modify any components of the doors or door trim panels including, for example, the addition of door speakers.

Improper repair work on the doors or the modification or addition of components to the doors creates a risk of rendering the side impact air bags inoperative or causing unintended air bag deployment. Work on the doors must therefore only be performed by qualified technicians. Contact an authorized Sprinter Dealer.

#### Warning

Only use seat covers which have been tested and approved for your vehicle type by the distributor named on the inside of the front cover. Using other seat covers may interfere with or prevent the deployment of the front side impact air bags. Contact an authorized Sprinter Dealer for availability.

When deployed, the side impact air bags offer additional protection for the thorax of the vehicle occupants on the side of the vehicle on which the impact occurs. However, they do not protect the:

- head
- neck
- arms



Side impact air bags ① deploy next to the outer seat cushions.

Side impact air bags ① are deployed:

- on the side on which the impact occurs
- at the start of an accident with a high rate of lateral vehicle deceleration or acceleration, e.g. in a side impact
- whether or not the seat belt is fastened

- independently of the front air bags
- independently of the Emergency Tensioning Devices

The side impact air bags are generally not deployed in the event of a rollover, unless the system detects high vehicle deceleration or acceleration in a lateral direction and determines that they can offer additional protection to that provided by the seat belt.

The side impact air bags are not deployed in side impacts which do not exceed the system's deployment threshold.

### Window curtain air bags

#### Warning

Observe "Important safety notes" (▷ page 38).

The window curtain air bags enhance protection for the head (but not the chest or arms) of the vehicle occupants on the side of the vehicle on which the impact occurs.

The window curtain air bags are installed in the side of the roof frame above the front doors.



Window curtain air bags ① are deployed:

- on the side on which the impact occurs
- at the start of an accident with a high rate of lateral vehicle deceleration or acceleration, e.g. in a side impact
- regardless of whether the co-driver's seat is occupied
- whether or not the seat belt is fastened

- in the event of a rollover where the system determines that air bag deployment can offer additional protection to that provided by the seat belt

- independently of the front air bags
- independently of the Emergency Tensioning Devices

The window curtain air bags will not deploy in impacts which do not exceed the system's preset thresholds. You will then be protected by the seat belt, provided that it is fastened.

### Children in the vehicle

#### Important safety notes

If an infant or child is traveling in the vehicle:

- ▶ Secure the child using an infant or child restraint system appropriate to the age and weight of the child.
- ▶ Make sure that the infant or child is properly secured at all times while the vehicle is in motion.

#### Warning

When leaving the vehicle, always remove the key from the ignition lock. Always take the key with you and lock the vehicle. Do not leave children unattended in the vehicle, even if they are secured in a child restraint system, or with access to an unlocked vehicle. A child's unsupervised access to a vehicle could result in an accident and/or serious personal injury.

Children could injure themselves on parts of the vehicle or could suffer severe or fatal injury due to extreme heat or cold.

If children open a door, they could injure other persons or get out of the vehicle and injure themselves or be injured by following traffic.

Do not expose the child restraint system to direct sunlight. This could cause, for example, metal parts of the child restraint system to become very hot. Touching these parts could cause burns.

**⚠ Warning**

Do not carry heavy or hard objects in the passenger compartment unless they are firmly secured in place.

Unsecured or improperly positioned cargo increases a child's risk of injury in the event of:

- strong braking maneuvers
- sudden changes of direction
- an accident

**Child restraint systems****Important safety notes****⚠ Warning**

Observe "Important safety notes" (▷ page 41).

We recommend all infants and children be properly restrained using the child restraint systems at all times while the vehicle is in motion.

The use of infant or child restraints is required by law in all 50 states, the District of Columbia, the U.S. territories and all Canadian provinces.

Infants and small children should always be seated in an infant or child seat restraint system appropriate for the size and weight of the child. They must be properly secured in accordance with the manufacturer's installation instructions for the infant or child seat restraint system. All infant and child seat restraint systems must comply with the US Federal Motor Vehicle Safety Standards 213 and 225 and Canadian Motor Vehicle Safety Standards 213 and 210.2.

A statement by the child restraint manufacturer of compliance with these standards can be found on the instruction label on the child restraint system. You will also find the statement in the instruction manual provided with the child restraint system.

When using any infant restraint, child restraint or booster seat, make sure to carefully read and follow all manufacturer's instructions for installation and use.

Please read the warning labels affixed to the interior of the vehicle or to the infant restraint system or child restraint system.

**⚠ Warning**

Accident statistics show that children secured in the rear seats are safer than children secured in the co-driver's seat. For this reason, we strongly advise that you always secure children in the rear seats. Regardless of the seat position, children under 12 years must be secured correctly in a suitable infant or child restraint system or booster seat suitable for the size and weight of the child.

The infant or child restraint must be properly secured with the vehicle's seat belt, the seat belt and Top Tether strap, or lower anchors and Top Tether strap, fully in accordance with the child seat manufacturer's instructions.

Occupants, in particular children, must sit as upright as possible, fasten the seat belt correctly and use a suitable infant restraint system, child restraint system or booster seat suitable for the size and weight of the child.

Children can be seriously or even fatally injured by an air bag deploying. Observe the following important information if it is absolutely necessary to carry a child on the co-driver's seat:

- The co-driver's front air bag is not deactivated.
- Never secure your child in a rearward-facing child restraint system on the co-driver's seat. Only install a rearward-facing child restraint system on a suitable rear seat.
- Where permitted by law, if you secure your child in a forward-facing child restraint system on the co-driver's seat, move the co-driver's seat as far back to the rear as possible.

- Never place anything between the seat cushion and child seat (e.g. pillow). The bottom of the child seat must make full contact with the vehicle seat cushion. An incorrectly mounted child seat could cause injuries to the child in the event of an accident, instead of protecting the child.
- Observe the manufacturer's instructions when installing special child restraint systems.

### **Warning**

Infants and small children should never share a seat belt with another occupant. During an accident, they could be crushed between the occupant and seat belt.

A child's risk of serious or fatal injuries is significantly increased if the child restraints are not properly secured in the vehicle and/or the child is not properly secured in the child restraint.

Children too big for a toddler restraint must ride in seats using regular seat belts. Position the shoulder belt across the chest and shoulder, not face or neck. A booster seat may be necessary to achieve proper seat belt positioning for children over 41 lb (18 kg) until they reach a height where a lap/shoulder belt fits properly without a booster.

When the child restraint is not in use, remove it from the vehicle or secure it with the seat belt to prevent the child restraint from becoming a projectile in the event of an accident.

### **Special seat belt retractor**

#### **Warning**

Observe "Important safety notes" (▷ page 41).

All seat belts in the vehicle, except the driver's seat belt, are equipped with a special seat belt retractor. When activated, the special seat belt retractor ensures that the seat belt cannot slacken once the child seat is secured.

Installing a child restraint system:

- ▶ Always comply with the manufacturer's installation instructions.
- ▶ Pull the seat belt smoothly from the inertia reel.
- ▶ Engage the seat belt tongue in the belt buckle.

Activating the special seat belt retractor:

- ▶ Pull the seat belt out fully and let the inertia reel retract it again. While the seat belt is retracting, you should hear a ratcheting sound. The special seat belt retractor function is enabled.
- ▶ Push down on the child restraint system to take up any slack.

Removing a child restraint system/ deactivating the special seat belt retractor:

- ▶ Always comply with the manufacturer's installation instructions.
- ▶ Press the seat belt release button and guide the belt tongue to the belt outlet. The special seat belt retractor function is deactivated.

### **Warning**

Never release the seat belt buckle while the vehicle is in motion, since the special seat belt retractor will be deactivated.

### **LATCH-type (ISOFIX) child seat securing system in the rear compartment**

#### **Warning**

Observe "Important safety notes" (▷ page 41).

#### **Warning**

Children too big for a toddler restraint must ride in seats using regular seat belts. Position the shoulder belt across the chest and shoulder, not face or neck.

In order to attain the correct seating position for children weighing over 41 lb (18 kg), it may be necessary to use a booster seat until they reach a height where a normal lap/shoulder

seat belt lies properly across their bodies without the need for a booster seat.

Install the child restraint system according to the manufacturer's instructions.

The child restraint system must be installed firmly on both brackets.

An incorrectly installed child restraint system can come loose in the event of an accident, causing the child to be severely or fatally injured.

Child restraint systems/child restraint retaining brackets that are damaged or have suffered damage due to an impact must be replaced.

LATCH-type (ISOFIX) is a standardized securing system for special child restraint systems on the rear seats.

The securing rings for two LATCH-type (ISOFIX) child restraint systems are located between the seat cushions and the backrest:

- on the left and right outer sides on a narrow rear bench seat with three seats
- on the outer left side on a rear bench seat with two seats

Install child restraint systems without the LATCH-type (ISOFIX) securing system using the vehicle's seat belts. Follow the manufacturer's instructions for installation of child restraint systems.

- ❗ When installing the child restraint system, make sure that the seat belt for the center seat does not get trapped. Otherwise, the seat belt could be damaged.



#### ① Securing rings

- ▶ Install the LATCH-type (ISOFIX) child restraint system. Comply with the manufacturer's instructions when installing the LATCH-type (ISOFIX) child restraint system.

#### Top Tether

##### ⚠ Warning

Observe "Important safety notes" (▷ page 41).

Top Tether provides an additional attachment point between the "LATCH" type child seat mount (ISOFIX) child restraint system and the rear seat. It helps reduce even further the risk of injury.

The Top Tether anchorages are located on the feet at the rear of the rear bench seats.

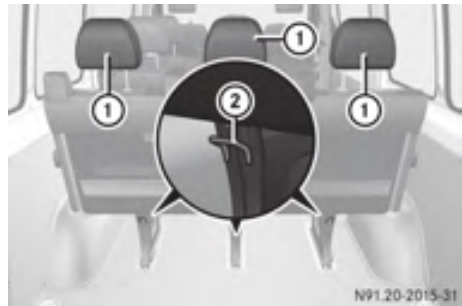

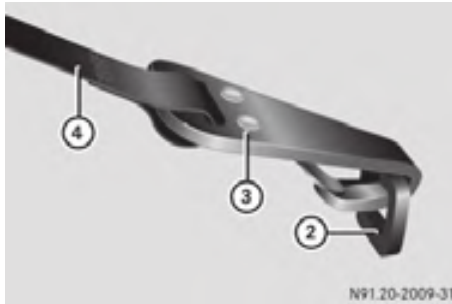

- ▶ Move head restraint ① upwards.
- ▶ Install the "LATCH" child seat mount with Top Tether. Comply with the manufacturer's installation instructions when doing so.
- ▶ Route Top Tether belt ④ under head restraint ① between both head restraint bars.
- ▶ Hook Top Tether hook ③ of Top Tether belt ④ into Top Tether anchorage ②. Make sure that:
  - Top Tether hook ③ is hooked into Top Tether anchorage ②, as illustrated.
  - Top Tether belt ④ is not twisted.
- ▶ Tension Top Tether belt ④. Comply with the manufacturer's installation instructions when doing so.
- ▶ If necessary, push the head restraint back down slightly. Make sure that the routing of Top Tether belt ④ is not impaired.

### Child-proof locks for the rear doors

#### Warning

Observe "Important safety notes" (▷ page 41).

#### Warning

Children could open a rear door from inside the vehicle. This could result in serious injuries or an accident. Therefore, when children ride in the rear always secure the rear doors with the child-proof locks.

You can use the child-proof locks in the doors to secure the sliding door and the rear door individually.

A door with an activated child-proof lock cannot be opened from the inside. It can only be opened from the outside if the vehicle is unlocked.

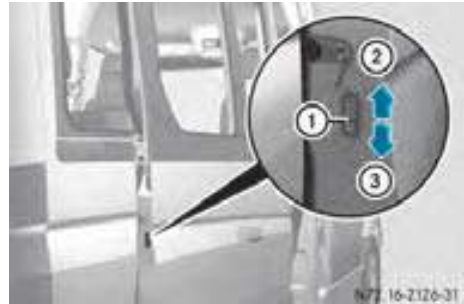

Child-proof lock for the sliding door

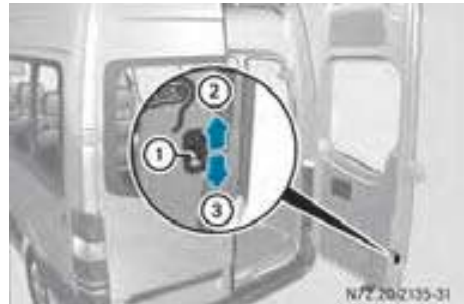

Child-proof lock for the rear door

- ① Latch
- ② To activate
- ③ To deactivate

- ▶ **To activate/deactivate:** push latch ① in the corresponding direction.
- ▶ Then, make sure that the child-proof locks are working properly.

### Emergency exit

#### Emergency exit window

The vehicle may feature an emergency exit window. The emergency exit window is intended for use in an emergency only and

must not be opened unless the vehicle is stationary.

In an emergency, or after an accident, the vehicle occupants can exit the vehicle through the emergency exit window.

The emergency exit window is the first window behind the driver's seat on the driver's side. It is marked by the "Emergency Exit" label.

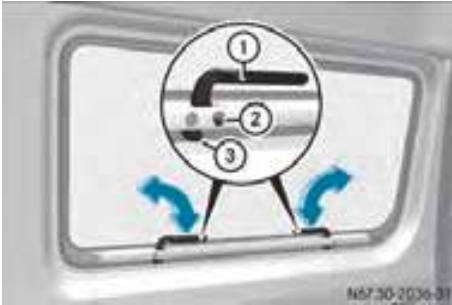

### Warning

Observe the following notes to make sure that the emergency exit window can be used safely in the event of an emergency:

- Before beginning a journey, inform the vehicle occupants of the emergency exit window and explain how to use it. Make sure to explicitly point out the risks described here.
- Only vehicle occupants who know how to use the emergency exit window are permitted to sit next to it.
- Access to the emergency exit window must remain unobstructed. Do not place any large or heavy objects on or in front of the seats next to the emergency exit window.
- The window handles must not be used as hooks, e.g. to hang up light objects, bags or items of clothing.

### Warning

To reduce the risk of accident or injury when exiting the vehicle through the emergency exit window, observe the following notes:

- Only open the emergency exit window when the vehicle is stationary.
- Make sure that nobody becomes trapped, both when closing and when opening the emergency exit window. The emergency exit window must be held open by one person.
- Pay attention to the traffic conditions and make sure that there is sufficient space when exiting through the emergency exit window.
- Pay attention to the traffic conditions when exiting the vehicle. Also pay attention to the vehicle height and the local surroundings.

Be especially careful if there are children in the vicinity.

### Warning

An open or unlocked emergency exit window can be torn from its anchorages when the vehicle is in motion and can thereby cause an accident.

For this reason, always check the lock and the locking pins of the emergency exit window before driving off.

Never open the emergency exit window while the vehicle is in motion.

- ❗ Make sure there is sufficient clearance when opening the emergency exit window. Hold the open window in position. You could otherwise damage the emergency exit window.

- ▶ **To open:** turn both handles ① to a vertical position. Locking pins ② will break in the process.  
The window is unlocked.
- ▶ Swing the window outwards by the handles and hold it in this position. Make sure there is sufficient clearance when doing so.
- ▶ **To close:** close the window.



- ▶ Turn both handles ① to a horizontal position. Make sure that locks ③ are in front of the window frame on the inside. The window is locked.
- ▶ Replace locking pins ② before beginning a new journey at the latest.  
You may obtain information about this from any authorized Sprinter Dealer.

## Driving safety systems

### Important safety notes

#### Warning

The following factors increase the risk of accidents:

- Excessive speed, especially in turns
- Wet and slippery road surfaces
- Following another vehicle too closely

The driving safety systems described in this section cannot reduce these risks or prevent the natural laws of physics from acting on the vehicle. They cannot increase braking or steering efficiency beyond that afforded by the condition of the vehicle brakes and tires or the traction afforded.

Only a safe, attentive, and skillful driver can prevent accidents.

The capabilities of a vehicle equipped with the driving safety systems described in this section must never be exploited in a reckless or dangerous manner which could jeopardize the user's safety or the safety of others.

Always adjust your driving style to the prevailing road and weather conditions and keep a safe distance to other road users and objects on the street.

If a driving system malfunctions, other driving safety systems may also switch off. Observe indicator and warning lamps that may come on as well as messages in the multifunction display that may appear.

- ① In wintry driving conditions, always use winter tires (M+S tires) and if necessary,

snow chains. Only in this way will the driving safety systems described in this section work as effectively as possible.

### Overview

In this section, you will find information about the following driving safety systems:

- ABS (**A**nti-**l**ock **B**raking **S**ystem)
- BAS (**B**rake **A**ssist **S**ystem)
- ESP® (**E**lectronic **S**tability **P**rogram)
- ASR (Acceleration Skid Control)
- EBD (**E**lectronic **B**rake force **D**istribution)

### ABS (Anti-lock Braking System)

#### Important safety notes

#### Warning

Observe "Important safety notes" (▷ page 47).

#### Warning!

Do not pump the brake pedal. Use firm, steady brake pedal pressure instead. Pumping the brake pedal reduces the braking effect.

ABS regulates brake pressure in such a way that the wheels do not lock during braking. This allows you to maintain the ability to steer your vehicle.

ABS works from a speed of about 3 mph (5 km/h) upwards, regardless of road-surface conditions. ABS works on slippery surfaces, even when you only brake gently.

The  warning lamp in the instrument cluster lights up when the ignition is switched on. It goes out when the engine is running.

### Braking

If ABS intervenes when braking, you will feel a pulsating in the brake pedal.

If the  warning lamp flashes, this may indicate dangerous road conditions and

serves as a reminder to take extra care while driving.

- ▶ **If ABS intervenes:** continue to depress the brake pedal with force until the braking situation is over.
- ▶ **To make a full brake application:** depress the brake pedal with full force.

#### Warning

If the ABS malfunctions, other driving systems such as the BAS or the ESP® are also switched off. Observe indicator and warning lamps that may come on as well as messages in the multifunction display that may appear.

If the ABS malfunctions, the wheels may lock during hard braking, reducing the steering capability and extending the braking distance.

### BAS (Brake Assist System)

#### Warning

Observe "Important safety notes" (▷ page 47).

BAS operates in emergency braking situations. If you depress the brake pedal quickly, BAS automatically boosts the braking force, potentially reducing the stopping distance.

- ▶ Keep the brake pedal firmly depressed until the emergency braking situation is over. ABS prevents the wheels from locking.

The brakes will function as usual once you release the brake pedal. BAS is deactivated.

#### Warning

If the BAS malfunctions, the brake system still functions, but without the additional brake boost available that the BAS would normally provide in an emergency braking maneuver. Therefore, the braking distance may increase.





### EBD (Electronic Brake force Distribution)

#### Warning

Observe "Important safety notes" (▷ page 47).

EBD monitors and controls the brake pressure on the rear wheels to improve driving stability while braking.

#### Warning

If the , ,  and  indicator lamps light up while the vehicle is in motion, EBD may be defective.

If EBD malfunctions, the brake system will still function with full brake boost. However, the rear wheels could lock up during emergency braking situations, for example. You could lose control of the vehicle and cause an accident.

Adapt your driving style to the changed driving characteristics.

### ASR (acceleration skid control)

#### Important safety notes

#### Warning

Observe "Important safety notes" (▷ page 47).

ASR can significantly improve traction, i.e. the transmission of power from the tires to the road surface, and thus may increase the vehicle's driving stability. ASR assists in pulling away and accelerating, particularly on smooth and slippery surfaces.

ASR can brake individual wheels and limits the engine torque to help prevent the drive wheels from spinning.

If ASR intervenes, the  warning lamp flashes in the instrument cluster.

**Warning**

Never switch off ASR when you see the  warning lamp flashing in the instrument cluster. In this case proceed as follows:

- when driving off, apply as little throttle as possible.
- while driving, ease off the accelerator pedal.
- adapt your speed and driving style to the prevailing road conditions.

Failure to observe these guidelines could cause the vehicle to skid. ESP® cannot prevent accidents resulting from excessive speed.

If, taking tires, cargo load and gradient into consideration, the surface driven on still provides insufficient traction, you may experience difficulties in pulling away despite ASR.

Vehicles without steering-wheel buttons: the  indicator lamp in the instrument cluster lights up when you switch on the ignition. It goes out when the engine is running.

**Activating/deactivating ASR****Warning**

ASR should not be switched off during normal driving other than in the circumstances described below. Deactivating the system will reduce vehicle stability in driving maneuvers. Do not switch off ASR when a spare wheel is mounted.

ASR is activated automatically when the engine is running.

It may be best to deactivate ASR briefly in the following situations:

- when using snow chains
- in deep snow
- on sand or gravel

If you deactivate ASR:

- the engine's torque is no longer limited and the drive wheels can spin. The spinning of the wheels results in a cutting action, which provides better grip.
- brake intervention will continue to improve traction where a drive wheel begins to spin, e.g. if only the side of the road is slippery. The wheel will be braked to increase traction under such circumstances.
- active brake intervention by ESP® to increase driving stability remains active.

**Warning**

Even with ASR deactivated, ESP® remains active and continues to perform brake interventions where this is necessary to improve driving stability. The  warning lamp flashes.

With ASR deactivated, there is an increased risk of your vehicle's brake system overheating and suffering damage due to prolonged application. A hot brake system will also result in increased stopping distance. Therefore, only deactivate ASR when absolutely necessary.



- ▶ Press button ①.

When ASR is deactivated, the  warning lamp in the instrument cluster lights up.

**ESP® (Electronic Stability Program)** **Warning**

Observe "Important safety notes"  
(▷ page 47).

If ESP® detects that the vehicle is deviating from the direction desired by the driver, one or more wheels are braked to help stabilize the vehicle. If necessary, the engine output is also modified to help keep the vehicle on the desired course within physical limits. ESP® assists the driver when pulling away on wet or slippery roads. ESP® can also help stabilize the vehicle during braking.



If ESP® intervenes, the  warning lamp flashes in the instrument cluster.

 **Warning**

If the  indicator lamp remains lit, ESP® is not available due to a malfunction. Vehicle stability in standard driving maneuvers is reduced.

Adapt your speed and driving style to the prevailing road conditions and to the non-operating status of ESP®.

If ESP® is malfunctioning, the engine output may be reduced.

-  Only operate the vehicle for a maximum of ten seconds on a brake test dynamometer. Switch off the ignition. Application of the brakes by ESP® may otherwise destroy the brake system.
-  Do not operate the vehicle on a dynamometer (e.g. for a performance test). If you would like to operate the vehicle on a dynamometer, consult an authorized Sprinter Dealer beforehand. The drive train or brake system could otherwise be damaged.
-  Only use wheels with the recommended tire sizes. Only then will ESP® function properly.

Vehicle equipment .....	52
Opening and closing .....	52
Anti-theft systems .....	61
Seats .....	63
Steering wheel .....	69
Mirrors .....	69
Instrument cluster .....	70
On-board computer without steering wheel buttons .....	72
On-board computer with steering wheel buttons .....	74
Power supply .....	87
Lighting .....	88
Good visibility .....	94
Climate control .....	97
Driving and parking .....	108
Brakes .....	112
Automatic transmission .....	113
Driving the vehicle .....	116
Driving systems .....	117
Features .....	128
Communications .....	133

## Vehicle equipment

- i** Diese Betriebsanleitung beschreibt alle Modelle, Serien- und Sonderausstattungen Ihres Fahrzeugs, die zum Zeitpunkt des Redaktionsschlusses dieser Betriebsanleitung erhältlich waren. Länderspezifische Abweichungen sind möglich. Beachten Sie, dass Ihr Fahrzeug nicht mit allen beschriebenen Funktionen ausgestattet sein könnte. Dies betrifft auch sicherheitsrelevante Systeme und Funktionen.

## Opening and closing

### Vehicle key

The vehicle comes equipped with 2 or 4 remote controls with an integrated folding key, or 4 keys.

You must have any keys that are not delivered with the vehicle programmed before use. Further information can be obtained at any authorized Sprinter Dealer.

Always take the key with you when leaving the vehicle, even if you are only leaving it for a short time.

Information on unlocking and locking the vehicle with a key can be found in the "Locking/unlocking the vehicle using the remote control with integrated key"

(▷ page 54)

### Warning

Do not leave children unsupervised in the vehicle, even if they are secured in a child restraint system. Children could otherwise injure themselves on parts of the vehicle. They could be severely or even fatally injured by prolonged exposure to intense heat or cold.

If children open a door, they could:

- injure other people
- get out of the vehicle and thereby injure themselves or be injured by a passing vehicle
- severely injure themselves by falling down, in particular due to the vehicle height

Always take the key with you when leaving the vehicle, even if you are only leaving for a short time.

### Key with remote control

The vehicle comes equipped with two or four remote controls with an integrated folding key, which are referred to simply as key in this manual. You must have any keys that are not delivered with the vehicle programmed before use. Further information can be obtained at any authorized Sprinter Dealer.

The key's remote control conforms to the FCC regulations (part 15) and the Canadian Industrial Standard RSS-210 and has a range of up to 32 ft (10 m).

The key's remote control locks/unlocks the driver's door and/or the vehicle centrally, if set at the factory:

- the driver's and the co-driver's door
- the sliding doors
- the rear doors

- i** If the driver's or co-driver's door is not closed, the corresponding door is not locked. If a sliding door or a rear door is not closed properly, none of the rear doors are locked.

If there is a key in the ignition lock, the remote control is inoperative. Always observe the turn signal flashing sequence and check the door locking knobs when locking/unlocking the vehicle.

### Warning

Do not leave children unsupervised in the vehicle, even if they are secured in a child

restraint system. Children could otherwise injure themselves on parts of the vehicle. They could be severely or even fatally injured by prolonged exposure to intense heat or cold.

If children open a door, they could:

- injure other people
- get out of the vehicle and thereby injure themselves or be injured by a passing vehicle
- severely injure themselves by falling down, in particular due to the vehicle height

Always take the key with you when leaving the vehicle, even if you are only leaving for a short time.



Remote control with an integrated folding key

- ① To unlock the sliding doors and the rear door
- ② To unlock the driver's door only or the vehicle centrally
- ③ To lock the vehicle centrally
- ④ Key release button
- ⑤ Battery check lamp

**!** Do not expose the key to high levels of electromagnetic radiation since this could interfere with the operation of the key.

Protect the key from moisture to prevent malfunctions.

- ① To prevent vehicle theft, you should only use the remote control in the immediate vicinity of the vehicle.

You can also unlock the driver's door and the rear door using the folding key (▷ page 54).

### Checking the batteries

- ▶ Press the button for longer than two seconds.

If the battery indicator lamp lights up briefly, the batteries in the remote control still have sufficient charge. Otherwise, change the batteries immediately (▷ page 246).

- ① When you are testing the batteries and your vehicle is within the range of the remote control, the vehicle is unlocked/locked each time you operate the respective button.

### Unlocking/locking the vehicle using the remote control

- ▶ **To unlock the driver's door:** press the button.  
The turn signals flash once. The anti-theft alarm system (ATA) is deactivated.
- ▶ **To unlock the sliding doors and rear door:** press the button.  
The turn signals flash once.
- ▶ **To unlock centrally:** unlock the driver's door.  
Press the unlocking button again within two seconds.  
The turn signals flash once.
- ① Cargo vans and crew vans only: if you unlock the vehicle using the remote control and do not open a door within 40 seconds, the vehicle is automatically relocked.
- ▶ **To lock centrally:** press the locking button.  
The turn signals flash three times when the drive authorization system or the Anti-Theft Alarm system (ATA) is activated and all the doors are closed.
- ① Make sure that the locking knobs have dropped down.

## Locking the vehicle using the folding key

You can also unlock/lock the driver's door and the rear door using the folding key.

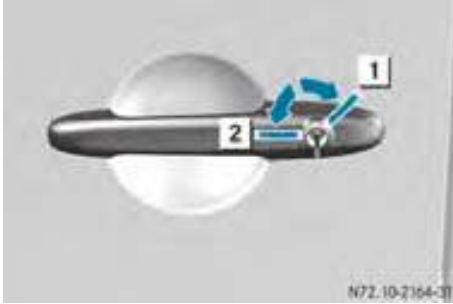

Driver's door

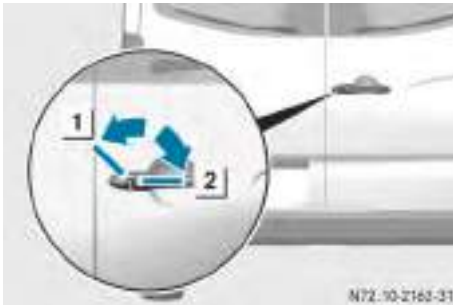

Rear door

**1** To lock

**2** To unlock

► **To unlock the driver's or rear door:** press the key release button on the remote control.

The key folds out.

► Slide the key into the door lock as far as it will go and turn to position **2**.

The door is unlocked.

**i** The Anti-Theft Alarm system (ATA) is triggered when you open the vehicle using the folding key.

The alarm can be disabled in the following ways:

► Press  or  on the remote control.

or

► Insert the key into the ignition lock.

► **To lock the vehicle:** lock all doors except the driver's door and, if necessary the rear door, from inside. To do this, press down the door locking buttons.

► Press the key release button on the remote control.

The key folds out.

► Insert the key into the door lock of the rear door as far as it will go and turn to position **1**.

The rear doors are locked.

► Insert the key into the door lock of the driver's door as far as it will go and turn to position **1**.

The driver's door is locked.

## Central locking

### Safety notes

You can open a locked door from the inside at any time.

#### Warning

Do not leave children unsupervised in the vehicle, even if they are secured in a child restraint system. Children could otherwise injure themselves on parts of the vehicle. They could be severely or even fatally injured by prolonged exposure to intense heat or cold.

If children open a door, they could:

- injure other people
- get out of the vehicle and thereby injure themselves or be injured by a passing vehicle
- severely injure themselves by falling down, in particular due to the vehicle height

Always take the key with you when leaving the vehicle, even if you are only leaving for a short time.



## Locking and unlocking manually

Using the central locking button, you can centrally lock/unlock either the entire vehicle or just the sliding doors and rear doors from the inside.

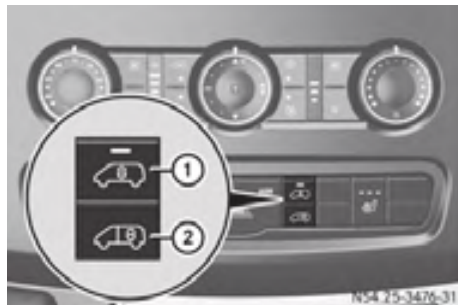

► **To lock/unlock the entire vehicle:** press upper section ① of the central locking button when the doors are closed. When the entire vehicle is locked, the indicator lamp in the central locking button lights up.

❗ If the key is in position **0** or no longer in the ignition lock, the indicator lamp in the central locking button remains lit for five seconds.

► **To lock/unlock the sliding doors and rear doors:** press lower section ② of the central locking button when the doors are closed.

When the sliding doors and rear doors are locked, the indicator lamp in the central locking button lights up.

## Automatic locking

### General notes

The vehicle locks automatically as standard once a speed of 9 mph (15 km/h) has been reached. Depending on the vehicle's equipment, the doors may be locked automatically once the ignition is switched on. You can find out more about the automatic locking mechanism of your vehicle at any authorized Sprinter Dealer.

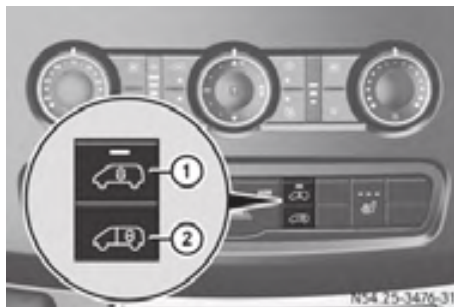

❗ When the automatic locking when driving function is activated, there is a risk of being locked out if the vehicle is being pushed or towed.

For this reason, deactivate the automatic locking when driving function:

- before pushing the vehicle
- before towing the vehicle
- if you are only leaving the vehicle for a brief period

If activated, automatic locking is deactivated when the vehicle is unlocked or locked using the central locking button.

Automatic locking is reactivated after the ignition is switched off or a door is opened with the vehicle stationary.

### Activating automatic locking when driving

- Turn the key to position **1** or **2** in the ignition lock when the doors are closed.
- **For the entire vehicle:** press the upper section ① of central locking button until the indicator lamp in the button flashes twice.
- **For the sliding doors and rear doors only:** press lower section ② of the central locking button until the indicator lamp in the button flashes four times.

### Deactivating automatic locking when driving

- ▶ Turn the key to position **1** or **2** in the ignition lock when the doors are closed.
- ▶ **For the entire vehicle:** press upper section **①** of central locking button until the indicator lamp in the button flashes twice.
- ▶ **For the sliding doors and rear doors only:** press lower section **②** of the central locking button until the indicator lamp in the button flashes twice.

### Ignition lock



- 0** To insert/remove the key, to lock the steering wheel
  - 1** To unlock the steering wheel, power supply for some consumers (e.g. the radio)
  - 2** To switch on the ignition, power supply for all consumers preglow and drive position
  - 3** To start the engine
- i** To unlock the steering wheel, move the steering wheel slightly while turning the key to position **1**.
- On vehicles with a battery isolating switch, you must first switch on the electrical system (▷ page 87).

### Driver's door and co-driver's door

#### Warning

Make sure that nobody can become trapped as you close and open the doors. Exercise particular care, especially if children are near the vehicle.

Only open the doors when road and traffic conditions permit. Make sure that there is sufficient clearance when opening the doors. You could otherwise cause injury to yourself and others.

You can open the driver's or co-driver's door from the inside at any time, even if it is locked.



- ▶ Pull door handle **①**.  
Locking knob **②** pops up.  
The door opens.

### Sliding door

#### General notes

#### Warning

Make sure that nobody can become trapped as you close and open the doors. Exercise particular care, especially if children are near the vehicle.

Only open the doors when road and traffic conditions permit. Make sure that there is sufficient clearance when opening the doors. You could otherwise cause injury to yourself and others.

**Warning**

If the vehicle is parked on an incline, the sliding door may move of its own accord if it is open but not engaged. You and others could then become trapped.

Make sure that the sliding door is engaged in the active retainer.

The sliding door is equipped with an active retainer, which engages the door at the end stop when opened.

- ① You can also lock the sliding door in place around halfway when opening/closing. If you do this, the door does not have to be opened fully when getting into or out of the vehicle. The intermediate detent does not fully engage the sliding door.

**Opening/closing the sliding door from the outside**

- ▶ **To open:** pull door handle ① to open the sliding door.
- ▶ Slide the sliding door by handle ① back to the stop.
- ▶ Check the sliding door detent. The sliding door must be engaged.
- ▶ **To close:** pull door handle ① in the "close door" direction, to release the sliding door from the detent.
- ▶ Holding door handle ①, slide the door firmly towards the front until it engages.

**Opening/closing the sliding door from the inside**

- ▶ **To unlock:** pull locking knob ④ upwards. Only this sliding door unlocks. All other doors that were previously locked remain locked.
- ▶ **To open:** press button ② to open the unlocked sliding door.
- ▶ Slide the sliding door by handle ③ back to the stop.
- ▶ Check the sliding door detent. The sliding door must be engaged.
- ▶ **To close:** slide the sliding door firmly forwards by handle ③ until it engages.
- ▶ **To lock:** press locking knob ④ down. Only the sliding door is locked. All other doors that were previously unlocked remain unlocked.

**Electrical closing assist**

If your vehicle is fitted with electrical closing assist, you will require less force to close the sliding door.

**Warning**

Make sure that nobody can become trapped as you close the sliding door.

If there is a risk of entrapment, pull the outside door handle or press the button on the inside door handle and open the door.

**Rear doors**

You can lock the rear doors at an angle of 90°, 180° and 270°. Always make sure that the open rear door is correctly engaged in the detent.

- ❗ Make sure that there is sufficient clearance when opening the rear doors. You could otherwise damage the vehicle and objects in close range of the rear doors.

**⚠ Warning**

Always make sure that there is sufficient room for approaching traffic when opening the rear doors and that nobody can become trapped. You could otherwise injure yourself or others by opening the rear doors.

**⚠ Warning**

If you open the rear doors to 90° (detent position), the rear lamps are no longer visible. The vehicle is no longer sufficiently visible from the rear and will only be recognized as an obstacle at a late stage by other road users. This could lead to an accident. Therefore, in such a situation, ensure that the vehicle is visible from the rear according to the respective national regulations, e.g. with a warning triangle.

**Opening the rear doors from the outside****Opening the right-hand rear door**

- ▶ Pull handle ①.
- ▶ Swing the rear door to the side until it engages.

**Opening the left-hand rear door**

- ▶ Make sure that the right-hand rear door is open and engaged.
- ▶ Pull release handle ① in the direction of the arrow.
- ▶ Swing the rear door to the side until it engages.

**Opening the rear doors to an angle of 180° or 270°**

- i** Vehicles with 270° pivoting rear doors: If you prefer to keep door retainer ① out of the loading area when loading the vehicle, you can swivel it 180° against the spring force and onto the door and engage it. The door retainer remains in this position and will not swivel back to its original position. Before closing the door, release door retainer ① from the detent and return it to its original position.

- ▶ Open the rear door to about 45°.
- ▶ Pull and hold door retainer ① in the direction of the arrow.
- ▶ Open the rear door more than 90°, so that the door retainer cannot engage.
- ▶ Release the door retainer and open the door to an angle of 180° or 270°.

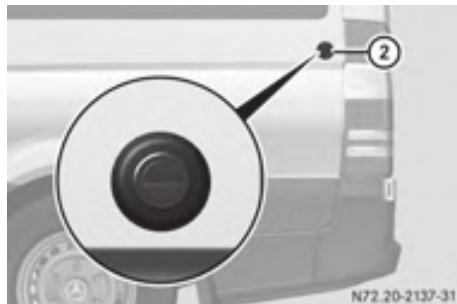

- ▶ With the rear door opened to an angle of 270°, push it against magnetic door retainer ② on the side wall. When the magnet on the rear door is in contact with magnetic door retainer ②, the rear door is held in this position.

### Closing the rear doors from the outside

#### Warning

Make sure that nobody can become trapped as you close the rear doors.

- ▶ Pull the rear door away from magnetic door retainer ②.
- ▶ Close the left-hand rear door firmly from the outside.
- ▶ Close the left-hand rear door firmly from the outside.
- i** Door retainer ① is automatically released from its detent.

### Opening/closing the rear doors from the inside

The handle is on the inside of the right-hand rear door. If a white marking is visible, this indicates that the rear door is unlocked.



Rear door

- ▶ **To unlock:** slide latch ② to the left. You will see a white marking. Only the rear door unlocks. All other doors that were previously locked remain locked.
- ▶ **To open:** pull opening lever ① and open the unlocked rear door.

#### Warning

Make sure that nobody can become trapped as you close the rear doors.

- ▶ **To close:** make sure that the left-hand rear door is closed.
- ▶ Pull the rear door firmly by the door handle to close it.
- ▶ **To lock:** slide latch ② to the right. The white section is no longer visible. Only the rear door is locked. All other doors that were previously unlocked remain unlocked.

### Partition sliding door

The partition sliding door is in the partition between the cab and the load compartment.

#### Warning

If the partition sliding door is open and not engaged, it could move automatically while the vehicle is in motion. You or others could become trapped or could be distracted from the traffic conditions, thus causing an accident.

Before driving off, make sure that the partition sliding door is closed and that the lock is engaged.

### Warning

Make sure that nobody can become trapped as you close the partition sliding door.

## Opening/closing the partition sliding door from the cab

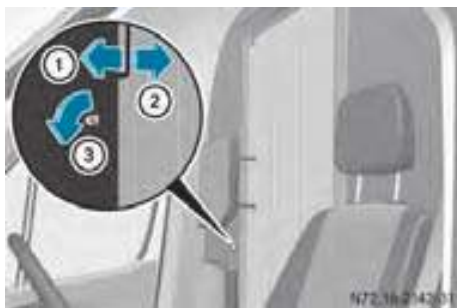

- ▶ **To open:** turn the key anti-clockwise ③.  
The sliding door is unlocked.
- ▶ Slide the sliding door to the stop in the direction of arrow ②.
- ▶ **To close:** slide the sliding door in the direction of arrow ① until it engages.  
The sliding door can be locked using the key.

## Opening/closing the partition sliding door from the load compartment

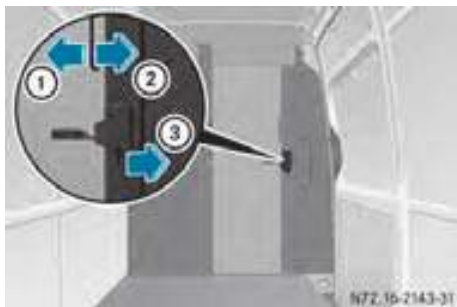

- ▶ **To unlock:** press the catch in the direction of arrow ③.  
The sliding door is unlocked.
- ▶ Slide the sliding door to the stop in the direction of arrow ①.
- ▶ **To close:** slide the sliding door in the direction of arrow ② until it engages.

## Opening/closing the windows

### Side windows

You can open and close the side windows electrically.

Reset the side windows if there has been a malfunction or an interruption in the voltage supply (▷ page 61).

### Warning

Make sure that nobody can become trapped between the side window and the door frame when a side window is opened. Do not touch or lean against the side window during the opening procedure. You could become trapped between the side window and the door frame as the side window moves down. If there is a risk of becoming trapped, release the switch or pull the switch upwards to close the side window again.

### Warning

Make sure that nobody can become trapped as you close the side windows. If there is a risk of somebody becoming trapped, release the switch or push the switch again to reopen the side window.

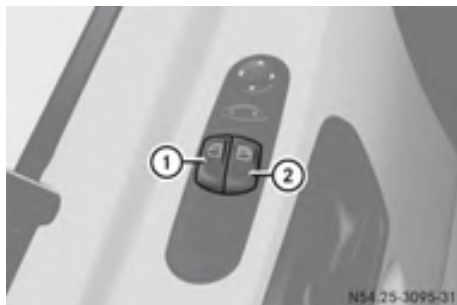

Control panel (example, driver's door)

- ① Power window, left
  - ② Power window, right
- ▶ Turn the key to position **2** in the ignition lock.
  - ▶ **To open/close:** pull or press switch ① or ② until the window has reached the desired position.

If you press the switch beyond the pressure point and then release it, the window opens automatically. To stop the movement, press or pull the switch again.

### **Warning**

Do not leave children unsupervised in the vehicle, even if they are secured in a child restraint system. Children could otherwise injure themselves on parts of the vehicle. They could be severely or even fatally injured by prolonged exposure to intense heat or cold.

If children open a door, they could:

- injure other people
- get out of the vehicle and thereby injure themselves or be injured by a passing vehicle
- severely injure themselves by falling down, in particular due to the vehicle height

Always take the key with you when leaving the vehicle, even if you are only leaving for a short time.

### **Resetting the side windows**

Reset the side windows if there has been a malfunction or an interruption in the voltage supply.

- ▶ Pull the two power window switches and hold for approximately one second after closing the side window.

## **Anti-theft systems**

### **Immobilizer**

The immobilizer prevents the vehicle from being started without the correct key.

When leaving the vehicle, always take the key with you and lock the vehicle. The engine can be started by anyone if the key is left inside the vehicle.

- ▶ **To activate:** remove the key from the ignition lock.
- ▶ **To deactivate:** insert the key into the ignition lock and turn to position **2**.

**i** The immobilizer is always deactivated when you start the engine.

In the event that the engine cannot be started when the starter battery is fully charged, the immobilizer may be defective. Contact an authorized Sprinter Dealer or call 1-877-762-8267 (USA) or 1-800-387-0100 (Canada).

### **Anti-theft alarm system (ATA)**

If the alarm system is armed, a visual and audible alarm is triggered when the following are opened:

- a door
- the hood

The alarm is not switched off, even if you close the open door that triggered it, for example.

- ▶ **To arm:** close all doors.
- ▶ Lock the vehicle using the  button on the key.  
The indicator lamp in the upper central locking button (▷ page 55) flashes.

- ▶ **To deactivate:** unlock the vehicle using the  button on the remote control.  
The indicator lamp in the upper central locking button (▷ page 55) goes out.

- i** Cargo van and passenger van only:  
Unless you open a door within 40 seconds after unlocking the vehicle:

- the vehicle will be locked again.
- the anti-theft alarm system will be re-armed.

- i** The alarm system will be triggered if the vehicle was previously locked with the key and is then unlocked from the inside.

- ▶ **To stop the alarm:** insert the key into the ignition lock.

or

- ▶ Press the  button on the remote control.  
The alarm is switched off.

### Tow-away alarm

A visual and audible alarm is triggered if the inclination of the vehicle changes when tow-away protection is armed.

- i** The alarm signal is triggered, for example if the vehicle is being jacked up on one side, shortly before the wheel leaves the ground.

Tow-away protection is automatically armed approximately 20 seconds after you lock the vehicle.

Tow-away protection is automatically deactivated when you unlock the vehicle.

Deactivate tow-away protection if the vehicle is being transported or loaded onto another vehicle. This will prevent a false alarm.



- ▶ **To deactivate when transporting the vehicle:** turn the key to position **0** or **1** in the ignition lock or remove the key.
- ▶ Press button **1**.  
Indicator lamp **2** lights up for approximately five seconds after the button is released.
- ▶ Lock the vehicle with the key.  
Tow-away protection remains deactivated until you lock the vehicle again.

### Interior motion sensor

If the anti-theft alarm system is armed and the vehicle is locked, a visual and audible alarm is triggered if one of the side windows or the rear window on your vehicle is smashed and someone reaches into the interior, for example.

- i** If the interior motion sensor is armed and the auxiliary heating system (▷ page 104) switches on, a false alarm may occur as a result of interior temperature monitoring. In this case, switch off either the interior motion sensor or the auxiliary heating.

### Arming the interior motion sensor

- ▶ Close the side windows.  
This will prevent false alarms.
- ▶ Lock the vehicle.  
The interior motion sensor is armed after approximately 40 seconds.
- i** Do not leave anything (e.g. mascots or coat hangers) hanging on the rear-view



mirror or on the grab handles on the headliner. This will prevent a false alarm.

### Deactivating the interior motion sensor

Deactivate the interior motion sensor if people or animals remain in the vehicle or you are having the vehicle transported, e.g. by ferry. This will prevent a false alarm.

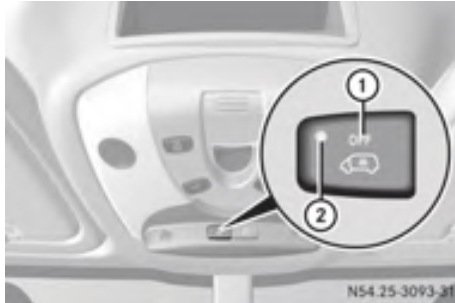

- ▶ Turn the key to position **0** or **1** in the ignition lock or remove the key.
- ▶ Press button ①.  
Indicator lamp ② lights up for approximately five seconds after the button is released.
- ▶ Lock the vehicle with the key.  
The interior motion sensor remains deactivated until you lock the vehicle again.

## Seats

### Driver's and co-driver's seat

#### Standard/luxury/suspension seat

#### Warning

If you adjust the driver's seat while the vehicle is in motion, your attention will be distracted from the traffic conditions. You could lose control of the vehicle as a result of sudden seat movements and, thereby, cause an accident.

Therefore, only adjust the driver's seat when the vehicle is stationary and the parking brake is applied.

#### Warning

Make sure that nobody can become trapped as you adjust the seat. Never place your hands under the seat or in the vicinity of moving parts.

Your seat must be adjusted in such a way that you can wear the seat belt correctly.

Observe the following points:

- Position the backrest in an almost vertical position so that you are sitting virtually upright.
- Avoid seat positions that prevent the seat belt from being routed correctly. The shoulder section of the belt must be routed over the middle of your shoulder and be pulled tight against your upper body. The lap belt must always pass across your lap as low down as possible, i.e. over your hip joints. Do not drive or ride with the backrest reclined too far back.
- Your arms should be slightly bent when you are holding the steering wheel.
- The distance from the pedals should be such that you can depress them fully.
- Adjust your head restraint so that its upper edge is at the same level as the top of your head.
- Make sure that you hear the seat engage. Otherwise, the seat is not correctly locked in place.

Failing to observe these instructions may lead to injury.

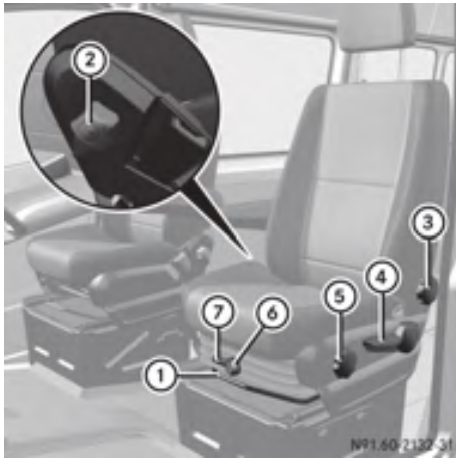

- ① Seat fore-and-aft adjustment
- ② Lumbar support adjustment
- ③ Seat backrest adjustment
- ④ Seat height adjustment
- ⑤ Seat cushion angle adjustment
- ⑥ Seat suspension adjustment
- ⑦ Seat suspension lock

**i** Depending on the seat model, some adjustments may not be available.

- ▶ **To adjust the seat fore-and-aft position:** pull lever ① up.
- ▶ Slide the seat forwards or back until you can depress the pedals.
- ▶ Release lever ①.
- ▶ Slide the seat forwards or back until you hear it engage.
- ▶ **To adjust the seat backrest:** turn handwheel ③ forwards.  
The seat backrest moves to a vertical position.
- ▶ Turn handwheel ③ towards the rear.  
The seat backrest tilts towards the rear.
- ▶ **To adjust the seat height:** press or pull lever ④ repeatedly until you have reached the desired seat height.

- ▶ **To adjust the seat cushion angle:** turn handwheel ⑤ forwards.  
The front of the seat cushion is lowered.
- ▶ Turn handwheel ⑤ towards the rear.  
The front of the seat cushion is raised.

**i** The lumbar support allows you to use the backrest to increase the support provided to the lumbar spine.

When the lumbar support is correctly adjusted, it reduces strain on your back while driving.

- ▶ **To adjust the lumbar support:** turn handwheel ② upwards.  
This increases the support provided to the lumbar region.
- ▶ Turn handwheel ② down.  
This reduces the support provided to the lumbar region.

The seat suspension must be adapted to your body weight. Adjust the seat suspension only while the seat is unoccupied.

- ▶ **To adjust the seat suspension:** take your weight off the seat.
- ▶ Use handwheel ⑥ to select the body weight (between 40 and 120 kg) for optimal seat suspension.  
The seat suspension will become more rigid the higher you set the weight. It will then not move as far.

If the seat moves up and down frequently and to a great extent, you can lock the seat in the lower movement range..

- ▶ **To engage the seat suspension lock:** turn handle ⑦ downwards.  
When it next moves, the seat will lock in position.

**i** The seat suspension lock will only engage if your body weight equals or exceeds the weight selected for the seat suspension.

- ▶ **To release the seat suspension lock:** turn lever ⑦ upwards.  
The seat can now move up and down again.

## Swiveling front seats

### Warning

Do not start the engine unless the driver's and co-driver's seats are facing in the direction of travel and are locked in position. Only adjust the seats when the vehicle is stationary and the parking brake is applied. You could otherwise lose control of the vehicle as a result of sudden seat movements and thereby cause an accident.

The safety systems only work when the driver's and co-driver's seats are facing in the direction of travel.

The driver's seat and co-driver's seat can be rotated through 180°.

The seats engage when facing in the direction of travel as well as when facing in the opposite direction and also engage at an angle of 50° to the door.

**!** When rotating the seats, make sure that there is sufficient space to do so.

Move the seat forward or back first. This will help to avoid contact with other parts of the interior.

Push the handbrake lever down to the stop.

The parking brake or handbrake lever could otherwise be damaged.

**i** Always slide the co-driver's seat forwards before rotating it (▷ page 64).

- ▶ Make sure that the parking brake has been engaged and that the handbrake lever has been pushed down to the stop (▷ page 112).
- ▶ Adjust the steering wheel to provide the necessary space to rotate and adjust the driver's seat (▷ page 69).

### Warning

When releasing and rotating the seats, make sure that you do not trap yourself or others. Never place your hands under the seat or in the vicinity of moving parts.



Seat release (example co-driver's seat)

- ▶ **To rotate the seat:** push lever ① on the rear of the seat towards the center of the vehicle and slightly rotate the seat inwards. The swiveling mechanism is now released.
- ▶ Release lever ①.
- ▶ Rotate the seat inwards to the desired position.

### Warning

When the seat is facing in the opposite direction to the direction of travel and has been moved to the rearmost position, you could knock against the exposed frame and be injured.

Therefore, always move the seat to a central position above the seat base when leaving it unoccupied. Inform others traveling with you of this risk.

## Twin co-driver's seat



- ▶ **To fold the seat cushions forwards:** lift the seat cushion out of front anchorage ①.
  - ▶ Pull the seat cushion forwards slightly and out of rear anchorage ②.
  - ▶ Fold the rear edge of the seat cushion up.
- i** You can stow various articles in the space under the twin co-driver's seat.
- ▶ **To fold the seat cushion back:** fold down the seat cushion by the rear edge.
  - ▶ Slide the seat cushion under the seat backrest into rear anchorage ②.
  - ▶ Push down on the seat cushion at the front until it engages in front anchorage ①.

### Rear bench seat

#### **⚠ Warning!**

The unlocking levers at the foot of the rear bench seat must lie parallel to the vehicle floor. You may only install a rear bench seat with two seats on the driver's side. Information about this can be found at any authorized Sprinter dealer.

The integral seat belts can only protect you as intended if you correctly install the prescribed rear bench seats. For this reason, have a rear bench seat with four seats installed only at a qualified specialist workshop, e.g. an authorized Sprinter dealer.

Keep the mounting shells of the bench seats on the floor free from dirt and other objects. The secure engaging of the locks is guaranteed only in this way.

For safety reasons, have bench seat mounting shells retrofitted only at an authorized Sprinter dealer.

- i** Do not exceed the maximum permissible number of seats for models registered as passenger vehicles.
- !** For safety reasons, the rear bench seat with four seats must be installed or removed only at a qualified specialist

workshop, e.g. an authorized Sprinter dealer.

### Removing two-seat or three-seat rear benches

The locking lever is located on the feet underneath the bench seat.



#### ① Lever

- ▶ Turn all levers ① for the bench seat fully upwards. The rear bench seat moves back into the seat mounting recesses on the vehicle floor.
- ▶ Lift the rear bench seat upwards out of the seat mounting recesses.

## Installing two-seat or three-seat rear benches

- ▶ Observe the prescribed installation position of the bench seat. Install the two-seat rear bench only on the driver's side.

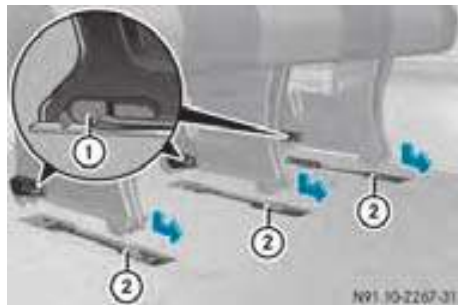

- ① Lever
- ② Seat mounting recesses

- ▶ Examine seat mounting recesses ② on the vehicle floor. Seat mounting recesses ② must be kept free from dirt and foreign objects.
- ▶ Position the rear bench seat in the direction of travel in seat mounting recesses ②.
- ▶ Slide the rear bench seat forwards until you hear the locking mechanisms engage.
- ▶ Check levers ① on the feet of the bench seat. All levers ① must be flush to the vehicle floor.

## Folding seat



Folding seat (example with partition sliding door)

### Warning

When folding down the seat cushion, make sure that nobody can become trapped. If the key is inserted in the lock of the partition sliding door the risk of injury to the co-driver in the case of steering movements and in the event of an accident is increased. Remove the key of the partition sliding door before using the folding seat.

- ▶ Remove key ① from the partition sliding door.
- ▶ Fold seat cushion ② down or up. The seat cushion is held in the corresponding position.

## Head restraints

### Warning

Only drive with the head restraints installed and adjusted correctly. You could otherwise suffer serious or fatal injuries in the area of the upper spinal column.

Adjust your head restraint so that its upper edge is at the same level as the top of your head. The back of your head should be as close as possible to the head restraint when relaxed, so that your head can be properly supported in the event of an accident.

The head restraint must be engaged in a detent.

## Adjusting the head restraints

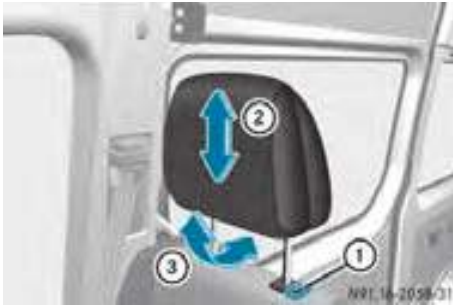

- ① Release button
  - ② Height adjustment
  - ③ Angle adjustment (luxury head restraints only)
- ▶ **To raise:** pull the head restraint up to the desired position.
  - ▶ **To lower:** press release button ① and slide the head restraint down to the desired position.
  - ▶ **To adjust the angle:** hold the head restraint by the lower edge and tilt it to the desired position.

## Removing the head restraints

- ▶ Pull the head restraint up to the stop.
- ▶ Press release button ① and pull out the head restraint.

## Installing the head restraints

- ❗ Install the head restraints with the front side facing forwards (luxury head restraints).
- ▶ Insert the head restraint so that the rod with the detents is on the left.
- ▶ Push the head restraint down until it engages.

## Armrests



- ▶ **To set the armrest angle:** fold the armrest upwards ② to an angle of more than 45°. The armrest is released.
- ▶ Fold the armrest forwards ③ to the stop.
- ▶ Slowly fold the armrest upwards to the desired position.
- ▶ **To fold the armrest up:** fold the armrest upwards ① to an angle of more than 90°.

## Seat heating

### ⚠ Warning!

Repeatedly setting the seat heating to level **3** may result in excessive seat temperatures. The health of passengers that have limited temperature sensitivity or a limited ability to react to excessively high temperatures may be affected or they may even suffer burn-like injuries. Therefore, do not use seat heating level **3** repeatedly.



The three red indicator lamps in button ① show the activated heating level 1 to 3.

The system automatically switches down from level 3 to level 2 after approximately five minutes.

The system automatically switches down from level 2 to level 1 after approximately ten minutes.

**!** When you leave your seat, do not place anything on the seat and switch off the seat heating. Do not switch the seat heating on when the seat is not occupied, e.g. when driving without a co-driver. The seat heating may otherwise overheat, causing damage to the seat.

At level 1, the seat heating remains in continuous operation.

- ▶ **To switch on:** make sure that the key is in position 1 in the ignition lock.
- ▶ Press button ① repeatedly until the desired heating level is set.
- ▶ **To switch off:** press button ① repeatedly until all indicator lamps go out.

## Steering wheel

### Warning

Only adjust the steering wheel when the vehicle is stationary. Only drive with the steering wheel locked in position.

An incorrectly secured steering wheel could make it more difficult to steer the vehicle safely since the steering wheel could move unexpectedly when turned. This could result in you losing control of the vehicle and causing an accident, thereby endangering yourself and others.

### Warning

Never leave children unsupervised in the vehicle. They could become trapped if they try to adjust the steering column.

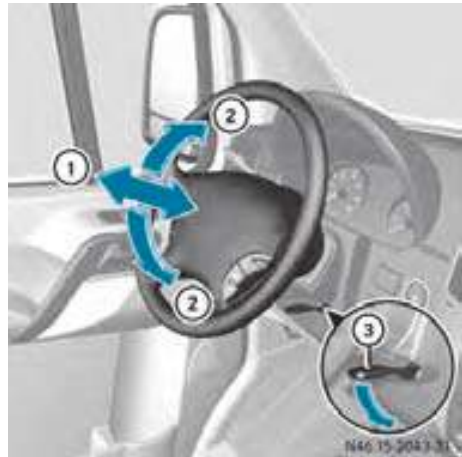

- ① Steering column fore-and-aft adjustment
- ② Steering column height
- ③ Lever
- ▶ Push lever ③ down to the stop. The steering wheel is unlocked.
- ▶ Move the steering wheel to the desired position.
- ▶ Pull lever ③ up to the stop. The steering wheel is locked again.

## Mirrors

### Rear-view mirror

- ▶ Before starting off, adjust the rear-view mirror by hand in such a way that you can get a good overview of road and traffic conditions.



N46 40-2010-31

- ▶ **Anti-glare mode:** push anti-glare lever ① in the direction of the arrow.

## Exterior mirrors

### Important safety notes

#### Warning

The additional mirrors in the exterior mirrors reduce the size of the image. The objects are actually closer than they appear. You could cause an accident if you only observe the traffic through the additional mirrors.

Therefore, pay particular attention to traffic behind you when maneuvering or passing using the main mirror in the exterior mirrors also and, if necessary, the rear-view mirror.

### Adjusting manually

- ▶ Before starting off, manually adjust the exterior mirrors in such a way that you can get a good overview of road and traffic conditions.

### Adjusting electrically

- i** The exterior mirrors are automatically heated at low outside temperatures.



Button and switch for mirror adjustment

- ▶ Before pulling away, turn the key to position 2 in the ignition lock.
- ▶ Press the switch to position ① for the left-hand exterior mirror or to position ② for the right-hand exterior mirror.
- ▶ Press button ③ at the top, bottom, right or left.

Adjust the exterior mirrors in such a way that you can get a good overview of road and traffic conditions.

## Instrument cluster

### Overview

You will find a full overview of the instrument cluster in the "At a glance" section (▷ page 24).



- ① Instrument cluster on vehicles without steering wheel buttons
- ② Instrument cluster on vehicles with steering-wheel buttons
- ③ Adjustment buttons (+/-), menu button (M), reset button (O), service button (⚡) (engine oil level check)

You will find information on the engine oil level check in the "Maintenance" section (▷ page 171).



The display in the instrument cluster is activated when you:

- open the driver's door
- turn the key to position **2** in the ignition lock
- press the  reset button
- switch on the lights

The display switches off automatically after approximately 30 seconds if:

- the vehicle lighting is not switched on.
- the key is in position **0** in the ignition lock.

### **Warning**

No messages can be displayed if the instrument cluster and/or the display fails.

You will then not be able to see information about the vehicle status, such as speed and outside temperature, warning/indicator lamps and display messages or the failure of systems. Handling characteristics may be affected. Adapt your speed and driving style accordingly.

Immediately consult a qualified specialist workshop. The qualified specialist workshop must have the necessary specialist knowledge and tools to carry out the work required. We recommend an authorized Sprinter Dealer for this purpose. In particular, all work relevant to safety or on safety-related systems must be carried out at a qualified specialist workshop.

### **Warning**

Only use the adjustment buttons on the instrument cluster when the traffic conditions permit. You would otherwise be too distracted and could cause an accident.

Do not reach through the steering wheel to operate the adjustment buttons. The movement of the steering wheel would be significantly impeded. Your attention would also be diverted from road and traffic conditions. This could cause you to lose control of the vehicle, and lead to an accident.

Do not rest your head or chest on the steering wheel or dashboard when operating the adjustment buttons.

You will find page references for further information in the index under "Air bag".

## **Speedometer**

-  In some countries, a warning sounds when the vehicle reaches the maximum speed limit, e.g. at 75 mph (120 km/h).

The speed can also be shown in the display. You can find information on the digital speedometer for vehicles without steering wheel buttons under (> page 73) and for vehicles with steering wheel buttons under (> page 77).

## **Tachometer**

The red band in the tachometer indicates the engine's overrevving range.

To protect the engine, the fuel supply is interrupted when the red band is reached.

-  Do not drive in the overrevving range, as this could damage the engine.

## **Environmental information**

Avoid driving at high engine revs. This driving style causes an unnecessary increase in vehicle fuel consumption and, therefore, damage to the environment due to increased emission of pollution.

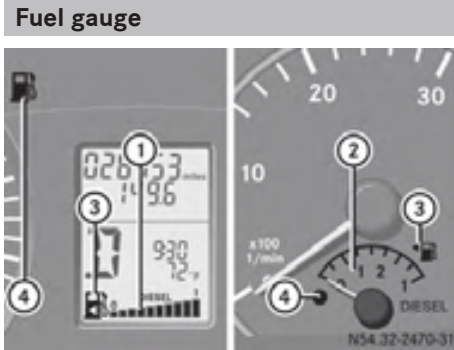

- ① Fuel gauge on vehicles without steering wheel buttons
- ② Fuel gauge on vehicles with steering wheel buttons
- ③ Fuel filler flap location indicator : the fuel filler cap is on the left-hand side Fuel filler flap location indicator : the fuel filler cap is on the right-hand side
- ④ Reserve fuel warning lamp (▷ page 193)



Information on the Diesel Exhaust Fluid (DEF) gauge can be found in the "Driving" section (▷ page 116).



### Trip odometer

#### Resetting

- ▶ On vehicles with steering wheel buttons: make sure that the display is showing the trip odometer (▷ page 77).
- ▶ Press and hold the  reset button until the trip odometer is reset to 0.0.

### Instrument lighting

With the lights switched on, you can adjust the brightness of the instrument lighting using the  and  buttons.

- ▶ **Brighter:** press the  button.
- ▶ **Dimmer:** press the  button.

- ▶ **i** Vehicles with automatic headlamp mode: the instrument lighting also adapts to automatic headlamp mode.

### On-board computer without steering wheel buttons

#### Layout and controls

The on-board computer is activated as soon as you turn the key to position **1** in the ignition lock.

#### Warning

Only use the adjustment buttons on the instrument cluster when the traffic conditions permit. You would otherwise be too distracted and could cause an accident.

Do not reach through the steering wheel to operate the adjustment buttons. The movement of the steering wheel would be significantly impeded. Your attention would also be diverted from road and traffic conditions. This could cause you to lose control of the vehicle, and lead to an accident.

Do not rest your head or chest on the steering wheel or dashboard when operating the adjustment buttons.

You will find page references for further information in the index under "Air bag".

The on-board computer shows vehicle information and settings in the display.

You can control the display and the settings in the on-board computer using the adjustment buttons on the instrument cluster.

## Standard display

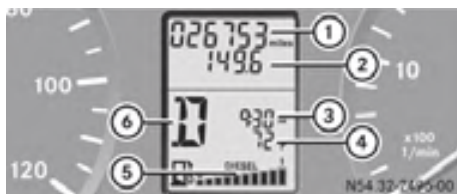

- ① Odometer
- ② Trip meter
- ③ Clock
- ④ Outside temperature or digital speedometer
- ⑤ Fuel gauge (▷ page 72)
- ⑥ Selector lever position or current shift range with automatic transmission

## Changing the standard display

- ▶ Turn the key to position **2** in the ignition lock.
- ▶ Press the **(M)** menu button for longer than one second.  
The information shown in the display changes from the outside temperature to the digital speedometer.

## Outside temperature display

### Warning

When the temperature displayed is just above freezing point, the road surface may be icy, especially in wooded areas or on bridges. The vehicle could skid if you fail to adapt your driving style. Always adapt your driving style and drive at a speed to suit the prevailing weather conditions.

Changes in outside temperature are displayed with a slight delay.

## Menus

Using the **(+)**, **(-)**, **(M)** or **(O)** adjustment buttons, you can select the following functions:

- calls up the service due date (▷ page 167)
- checking the engine oil level (▷ page 171)
- preselecting/setting the auxiliary heating switch-on time (▷ page 104)
- tire pressure monitor
- setting the time (▷ page 73)
- setting the date (▷ page 73)
- setting daytime running lamp mode (▷ page 74)

▶ **To return to the standard display:** press the **(M)** menu button for longer than one second.

or

- ▶ Do not press any button for 10 seconds. The display accepts the changed settings.





## Setting the time

- ▶ Turn the key to position **2** in the ignition lock.
- ▶ Press the **(M)** menu button repeatedly until the hours figure flashes.
- ▶ Press **(+)** or **(-)** to set the hours.
- ▶ Press reset button **(O)**.  
The minute display flashes.
- ▶ Press **(+)** or **(-)** to set the minutes.

**(i)** If you keep the **(+)** or **(-)** button pressed, the value will change continuously.

## Setting the date





- ▶ Turn the key to position **2** in the ignition lock.
- ▶ Press the **(M)** menu button repeatedly until the day flashes.
- ▶ Press **(+)** or **(-)** to set the day.
- ▶ Press reset button **(O)**.  
The month display flashes.
- ▶ Press **(+)** or **(-)** to set the month.

- ▶ Press reset button . The year display flashes.
  - ▶ Press  or  to set the year.
- i** If you keep the  or  button pressed, the value will change continuously.



### Setting daytime running lamp mode

If you have switched daytime running lamp mode on and the light switch is in the  position, the following light up automatically when the engine is running: the parking lamps, the low-beam headlamps, the tail lamps and the license plate lamps.



For safety reasons, it is only possible to change this setting when the vehicle is stationary. The factory setting is **ON** in countries in which daytime running lamp mode is mandatory.

- ▶ Turn the key to position **2** in the ignition lock.
- ▶ Press the  menu button repeatedly until the  indicator lamp in the instrument cluster flashes and the message **ON** or **OFF** appears in the display.
- ▶ Press  or  to activate or deactivate daytime running lamp mode.

**i** USA only:

If you turn the light switch to  or , the corresponding light is switched on. Daytime running lamp mode remains activated if the light switch is turned to **AUTO**.

Canada only:

If you turn the light switch to , the low-beam headlamps are switched on. Daytime running lamp mode remains activated if the light switch is turned to  or **AUTO**.

## On-board computer with steering wheel buttons

### Layout and controls

The on-board computer is activated as soon as you turn the key to position **1** in the ignition lock.

 **Warning**

Only use the on-board computer when road and traffic conditions permit. You would otherwise be distracted and unable to concentrate properly on driving, and could cause an accident.

The on-board computer shows vehicle information and settings in the display.

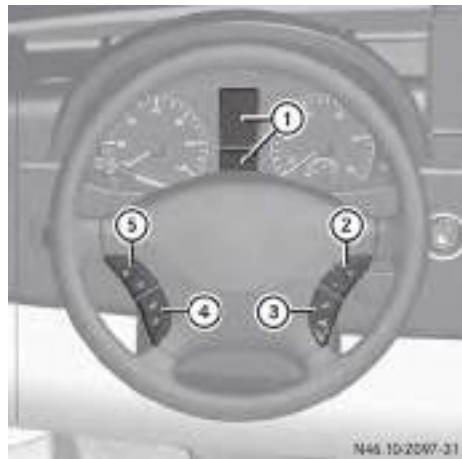

### Steering wheel with buttons









You can control the display and the settings in the on-board computer with the buttons on the steering wheel.

① Display

#### On-board computer operation

- ②  and 
- Selects submenus
  - Changes values
  - Adjusts the volume

③	Using the telephone  Accepts a call  Ends a call
④	Scrolls from one menu to another  Forwards  Back
⑤	Scrolls within a menu  Forwards  Back





Several functions are combined thematically in the menus.

The display changes when you press one of the buttons on the steering wheel.

For example, the **Audio** menu has functions for controlling the radio or CD player. You can use a function to call up information or to change the settings for the vehicle.

- ① Operation of the audio equipment using the steering wheel buttons and making settings using the **AUDIO** menu only function as described if Sprinter audio equipment is installed. If you are using audio equipment from another manufacturer, the described functions may be restricted or not available at all.

You can think of the order of the menus and of the functions within a menu as a circle:

- ▶ Press the  or  button repeatedly to call up the menus in succession.
- ▶ Press the  or  button repeatedly to call up the functions within a menu in succession.

Unlike other menus, you will find submenus within the **Settings** menu. For information on how to use these submenus, see the "Settings menu" section .

The number of menus depends on the optional equipment installed in your vehicle.

## Menu overview

## Diagrams

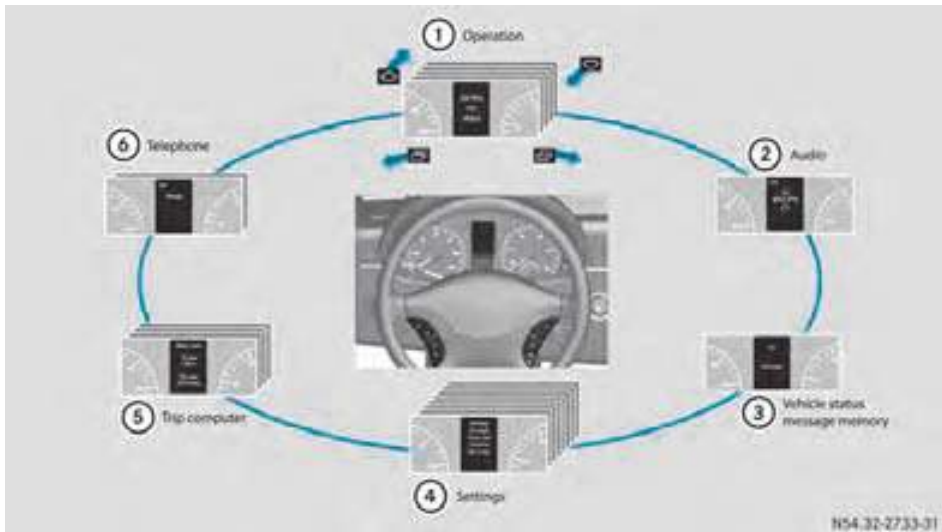

## Generic terms

This is what the displays look like when you scroll through the menus.

- ① The generic terms in the tabular overview should make orientation easier for you. However, they are not always shown on the display.

On Sound 5/Audio 20, the on-board computer always shows the **AUDIO** and **TEL** (telephone) menus in English. This is the case even if a different language is selected for the display.

	Operation
①	Operation menu (▷ page 77) <ul style="list-style-type: none"> <li>• Standard display</li> <li>• Calls up the service due date (▷ page 167)</li> <li>• Tire pressure monitor</li> <li>• Checks the engine oil level (▷ page 171)</li> </ul>
②	Audio menu (▷ page 77)

## Operation

③	Message memory menu (▷ page 78)
④	Settings menu
⑤	Trip computer menu
⑥	Telephone menu

## Operation menu

Press or to select the following functions in the **Operation** menu:

- trip meter and total distance recorder (standard display)
- display the coolant temperature (▷ page 77)
- calling up the service due date (▷ page 167)
- tire pressure monitor
- checking the engine oil level (▷ page 171)

## Standard display

In the basic setting, the odometer and the trip meter are shown in the upper part of the display. This is referred to as the standard display.

Using the steering wheel buttons



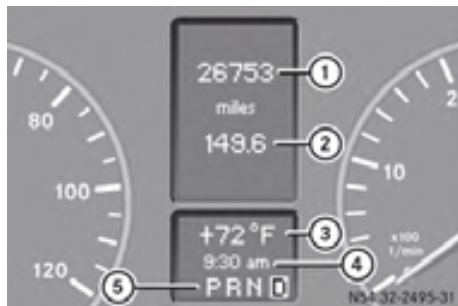

- ▶ Press the  or  button repeatedly until the standard display appears.



- ① Odometer
- ② Trip meter
- ③ Outside temperature or digital speedometer
- ④ Clock
- ⑤ Selector lever position or current shift range

## Displaying the coolant temperature

Using the steering wheel buttons

- ▶ Press the  or  button repeatedly until the standard display appears.
- ▶ Press  or  to select the coolant temperature.



The temperature displayed may climb to 250 °F (120 °C) when the vehicle is being driven in normal conditions, and if the coolant contains the correct concentration of

corrosion inhibitor and antifreeze. At high outside temperatures and when driving in mountainous terrain, the coolant temperature may rise to the end of the scale.

## Audio menu



You can use the functions in the **AUDIO** menu to control the audio equipment that you have just switched on.

Operation of the audio equipment using the steering wheel buttons and making settings using the **AUDIO** menu only function as described if Sprinter audio equipment is installed. If you are using audio equipment from another manufacturer, the described functions may be restricted or not available at all.

If no audio equipment (Sound 5 or Audio 20) is switched on, you will see the **AUDIO off** message.

## Selecting a radio station

Using the steering wheel buttons

- ▶ Switch on the radio (see the separate operating instructions).
- ▶ Press the  or  button repeatedly until the display shows the currently selected station.

The kind of search depends on the setting for radio station selection. The nearest stored station will be selected or the station search starts (except on Audio 20).

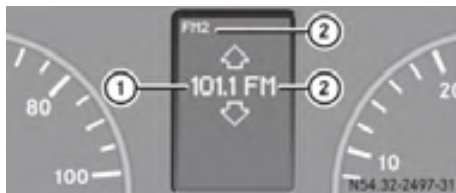

- ① Reception frequency
- ② Waveband or waveband with memory preset number



- ▶ Press  or  to select the desired station.

**i** It is only possible to store new stations using the audio system. See the separate operating instructions.



You can also operate the radio in the same way as usual.

### Operating the CD player

Using the steering wheel buttons

- ▶ Switch on the radio (see the separate operating instructions) and select the CD player.
- ▶ Press the  or  button repeatedly until the settings for the current CD appear in the display.



- ① Current CD (with CD changer)
- ② Current track
- ▶ Press  or  to select a CD track.



### Message memory menu

The on-board computer stores certain display messages. In the **Message memory** menu, you can call up stored display messages.

#### Warning





The on-board computer only records and displays malfunctions and warnings from certain systems. For this reason, you should always make sure that your vehicle is safe to use. You could otherwise cause an accident by driving an unsafe vehicle.

Using the steering wheel buttons

- ▶ Press the  or  button repeatedly, until the number of stored display

messages, e.g. **2 messages**, appears in the display.

If no malfunctions have occurred, the **No messages** message appears.



- ▶ Press  or  to scroll through the stored display messages. Potential display messages are described in the "Practical advice" section (▶ page 201).
- ▶ Press the  or  button to change to a different display.

**i** The message memory is cleared when you switch off the ignition.

### Settings menu

You will find two functions in the **Settings** menu: the **To reset: Press the 0 button for 3 sec.** function, with which you can reset all settings to the factory defaults. You will also find submenus which you can use to make individual settings on the vehicle.

Using the steering wheel buttons

- ▶ Press the  or  button repeatedly until the **Settings** menu appears in the display.

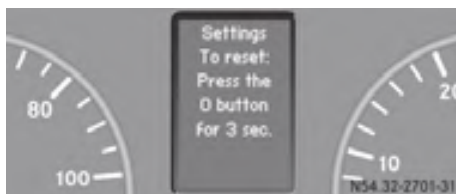





Settings menu

### Resetting all settings

You can reset the functions in all submenus to the factory settings.



Using the steering wheel buttons









- ▶ Press the  or  button repeatedly until the **Settings** menu appears in the display.
- ▶ Press the  reset button for about three seconds.  
You will see a message in the display prompting you to press the  reset button again to confirm.
- ▶ Press the  reset button again.  
The functions of all submenus are reset to the factory settings.

- i** If you do not press the  reset button a second time to confirm, the settings are retained. The **Settings** menu appears again after approximately five seconds. For safety reasons, it is not possible to reset all of the functions while the vehicle is in motion. For example, the **HdImp mode** function in the **Lighting** submenu remains unchanged.

### Resetting the functions of a submenu

You can reset the functions of an individual submenu to the factory settings.

Using the steering wheel buttons

- ▶ Press the  or  button repeatedly until the **Settings** menu appears in the display.
- ▶ Press  to switch to the submenu selection.
- ▶ Press  or  to select a submenu.
- ▶ Press the  reset button for about three seconds.  
You will see a message in the display prompting you to press the  reset button again to confirm.
- ▶ Press the  reset button again.  
All functions of the submenu are reset to the factory settings.



- i** If you do not press the  reset button a second time to confirm, the settings are

retained. The **Settings** menu appears again after approximately five seconds.

For safety reasons, it is not possible to reset all of the functions while the vehicle is in motion. For example, the **HdImp mode** function in the **Lighting** submenu remains unchanged.





### Submenus in the Settings menu

Using the steering wheel buttons

- ▶ Press the  or  button repeatedly until the **Settings** menu appears in the display.
- ▶ Press  to switch to the submenu selection.

You will see the collection of submenus. There are more submenus than can be displayed at the same time.



- ▶ Press  or  to select a submenu. The submenu currently selected is highlighted.
  - ▶ Press  to select the function within a submenu.
  - ▶ Change the setting by pressing  or .
- The changed setting is saved.

You can select the following submenus:







- Instrument cluster (▷ page 80)
  - Units and language settings
  - Status bar settings
- Clock/Date (▷ page 82)

- Lighting (▷ page 82)
  - Activating/deactivating daytime running lamp mode and surround lighting (locator lighting)
  - Setting the exterior lighting delayed switch-off
- Vehicle (▷ page 84)
  - Setting the radio station selection
  - Setting the windshield wiper sensitivity
- Auxiliary heating (▷ page 104)
- Convenience (▷ page 85)
  - Key-dependent settings



### Instrument cluster submenu

#### Selecting the unit for temperature

Using the steering wheel buttons







- ▶ Press the  or  button repeatedly until the **Settings** menu appears in the display.
- ▶ Press  to switch to the submenu selection.
- ▶ Press  or  button to select the **Inst. cluster** submenu.
- ▶ Press  to select the **Temperat.** function.  
The selection marker is on the current setting.





- ▶ Press  or  to select the unit for all messages in the display: °C (degrees Celsius) or °F (degrees Fahrenheit).

#### Selecting the unit for the digital speedometer

Using the steering wheel buttons







- ▶ Press the  or  button repeatedly until the **Settings** menu appears in the display.
- ▶ Press  to switch to the submenu selection.
- ▶ Press  or  button to select the **Inst. cluster** submenu.
- ▶ Press  to select the **Dig. speedo.** function.  
The selection marker is on the current setting.



- ▶ Press  or  to select the unit for the digital speedometer: **km/h** or **mph**.

#### Selecting the unit for the odometer

Using the steering wheel buttons

- ▶ Press the  or  button repeatedly until the **Settings** menu appears in the display.
- ▶ Press  to switch to the submenu selection.
- ▶ Press  or  button to select the **Inst. cluster** submenu.
- ▶ Press  to select the **Trip** function.  
The selection marker is on the current setting.



- ▶ Press **+** or **-** to select the unit for all messages in the display: **km** (kilometers) or **miles**.

### Selecting the language

Using the steering wheel buttons

- ▶ Press the **☰** or **☷** button repeatedly until the **Settings** menu appears in the display.
- ▶ Press **⬆** to switch to the submenu selection.
- ▶ Press **+** or **-** button to select the **Inst. cluster** submenu.
- ▶ Press **⬆** to select the **Language** function.  
The selection marker is on the current setting.



- ▶ Use **+** or **-** to set the language for all messages.

The languages available are:

- German
- British English
- US English
- French
- Italian
- Spanish

### Selecting the display for the status bar

Using the steering wheel buttons

- ▶ Press the **☰** or **☷** button repeatedly until the **Settings** menu appears in the display.
- ▶ Press **⬆** to switch to the submenu selection.

- ▶ Press **+** or **-** button to select the **Inst. cluster** submenu.
- ▶ Press **⬆** to select the **Select disp.** function.  
The selection marker is on the current setting.

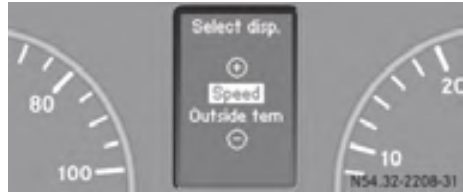

- ▶ Press **+** or **-** to select whether to display the outside temperature or the speed (digital speedometer).  
The selected display is then shown permanently in the lower part of the display (▶ page 77).

### Selecting the unit for the tire pressure

Using the steering wheel buttons

- ▶ Press the **☰** or **☷** button repeatedly until the **Settings** menu appears in the display.
- ▶ Press **⬆** to switch to the submenu selection.
- ▶ Press **+** or **-** button to select the **Inst. cluster** submenu.
- ▶ Press **⬆** to select the **Tire pres.** function.  
The selection marker is on the current setting.









- ▶ Press **+** or **-** to select the unit for the tire pressure in the display: **bar** or **psi**.



## Clock/Date submenu

### Setting the clock

Using the steering wheel buttons







- ▶ Press the  or  button repeatedly until the **Settings** menu appears in the display.
- ▶ Press  to switch to the submenu selection.
- ▶ Press  or  to select the **Clock/Date** submenu.
- ▶ Press  to select the **Set cLock Hours** or **Minutes** function.





- ▶ Press  or  to set the values.

### Selecting the time format

Using the steering wheel buttons







- ▶ Press the  or  button repeatedly until the **Settings** menu appears in the display.
- ▶ Press  to switch to the submenu selection.
- ▶ Press  or  to select the **Clock/Date** submenu.
- ▶ Press  to select the **12/24 h** function. The selection marker is on the current setting.





- ▶ Press  or  to select the **12 h** or **24 h** clock format.

### Setting the date

Using the steering wheel buttons

- ▶ Press the  or  button repeatedly until the **Settings** menu appears in the display.
- ▶ Press  to switch to the submenu selection.
- ▶ Press  or  to select the **Clock/Date** submenu.
- ▶ Press  to select the **Date Day** or **Month** or **Year** function.



- ▶ Press  or  to set the values.



## Lighting submenu



### Setting daytime running lamp mode

If you have set daytime running lamp mode and the light switch is in the  position, the following light up automatically when the engine is running: the parking lamps, the low-beam headlamps, the tail lamps and the license plate lamps.



For safety reasons, it is only possible to change this setting when the vehicle is stationary. The factory setting is **Constant** in countries in which daytime running lamp mode is mandatory.



Using the steering wheel buttons

- ▶ Press the  or  button repeatedly until the **Settings** menu appears in the display.
- ▶ Press  to switch to the submenu selection.



- ▶ Press  or  to select the **Lighting** submenu.
- ▶ Press  to select the **HdImp mode** function.  
The selection marker is on the current setting.



- ▶ Press  or  to select the **Manual** or **Constant** (daytime running lamp mode) setting.
- i** USA only:

If you turn the light switch to  or , the corresponding light is switched on. Daytime running lamp mode remains activated if the light switch is turned to **AUTO**.

Canada only:

If you turn the light switch to , the low-beam headlamps are switched on. Daytime running lamp mode remains activated if the light switch is turned to  or **AUTO**.

- i** For safety reasons, it is not possible to reset the **HdImp mode** function to the factory setting while the vehicle is in motion. You will see the following message in the display: **Setting only possible at standstill**

### Switching surround lighting (locator lighting) on/off







If you switch the surround lighting to **On**, the following lamps light up in the dark after you have unlocked the vehicle using the key:

- the parking lamps
- the tail lamps
- the license plate lamps
- the fog lamp



The surround lighting automatically switches off after 40 seconds or when you:

- open the driver's door
- insert the key into the ignition lock
- lock the vehicle using the key

Using the steering wheel buttons

- ▶ Press the  or  button repeatedly until the **Settings** menu appears in the display.
- ▶ Press  to switch to the submenu selection.
- ▶ Press  or  to select the **Lighting** submenu.
- ▶ Press  to select the **Loc. lighting** function.  
The selection marker is on the current setting.



- ▶ Press  or  to switch the surround lighting (locator lighting) to **On** or **Off**.

### Setting the exterior lighting delayed switch-off

The **Headlamps** (delayed headlamp shut-off) function enables you to set whether and for how long the exterior lighting is to remain on in the dark after closing the doors.

If you have set the delayed switch-off and switch off the engine, the following remain lit:







- the parking lamps
- the tail lamps
- the license plate lamps
- the fog lamp

- i** You can reactivate this function by opening a door within 10 minutes.



The exterior lighting is switched off after 60 seconds if you do not open a door or if

you do not close an opened door after the engine has been switched off.

Using the steering wheel buttons

- ▶ Press the  or  button repeatedly until the **Settings** menu appears in the display.
- ▶ Press  to switch to the submenu selection.
- ▶ Press  or  to select the **Lighting** submenu.
- ▶ Press  to select the **Headlamps** function. The selection marker is on the current setting.



- ▶ Press  or  to select whether and for how long you wish the exterior lighting to remain on.



## Vehicle submenu



### Setting the radio station selection

The **Search** function enables you to determine whether the radio should search for a new station or a previously stored station each time the radio is operated using the steering wheel buttons (not with Audio 20).



The **Frequency** setting starts the station search. The **Memory** setting selects the next stored station.

Using the steering wheel buttons

- ▶ Press the  or  button repeatedly until the **Settings** menu appears in the display.
- ▶ Press  to switch to the submenu selection.

- ▶ Press  or  to select the **Vehicle** submenu.
- ▶ Press  to select the **Search** function. The selection marker is on the current setting.









- ▶ Press  or  to select the station search mode.

### Setting the windshield wiper sensitivity



You can use the **Wipe sensor** function to set the sensitivity of the rain/light sensor:

- **Level 1**: high sensitivity – wiping begins even in light rain
- **Level 2**: moderate sensitivity
- **Level 3**: low sensitivity – wiping only begins in heavy rain

Using the steering wheel buttons

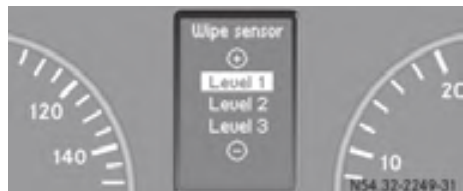
- ▶ Press the  or  button repeatedly until the **Settings** menu appears in the display.
- ▶ Press  to switch to the submenu selection.
- ▶ Press  or  to select the **Vehicle** submenu.
- ▶ Press  to select the **Wipe sensor** function. The selection marker is on the current setting.



- ▶ Press  or  to set the sensitivity of the rain/light sensor.





## Convenience submenu

### Key-dependent settings



The **Key** function allows you to define whether settings for the following submenus are stored with a key dependence:

- **Inst. cluster** (instrument cluster)
- **Lighting**
- **Vehicle**

Using the steering wheel buttons

- ▶ Press the  or  button repeatedly until the **Settings** menu appears in the display.
- ▶ Press  or  to select the **Convenience** submenu.
- ▶ Press the  button to select the **Key** function. The selection marker is on the current setting.



- ▶ Press  or  to activate or deactivate key dependency.
- ❗ For safety reasons, it is not possible to set the **Key** function while the vehicle is in motion. You will see the following message in the display: **Setting only possible at standstill**

### Trip computer menu



You can call up or reset statistical data for the vehicle in the **Trip computer** menu.

### Consumption statistics after start

Using the steering wheel buttons

- ❗ When you call up the trip computer again, it displays the last function called up.

The units of the statistical information displayed are set permanently for each specific country, and are therefore independent of the units selected in the **Settings** menu.

- ▶ Press the  or  button repeatedly until the display shows the **After start** message.

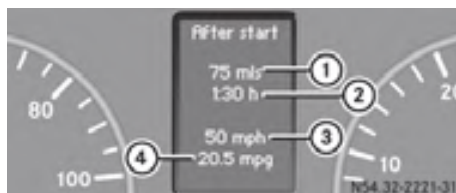





- ① Distance driven since start
- ② Time elapsed since start
- ③ Average speed since start
- ④ Average fuel consumption since start

- ❗ If you turn the key to position **0** in the ignition lock or remove it, all the values are reset after approximately four hours.

The values will not be reset if you turn the key back to position **1** or **2** during this time.

### Consumption statistics after reset

Using the steering wheel buttons



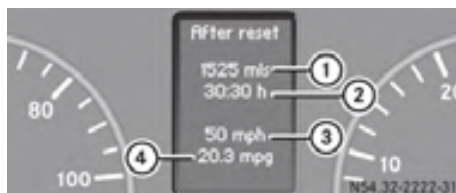

- ▶ Press the  or  button repeatedly until the display shows the **After start** message.
- ▶ Press  or  repeatedly until the **After reset** message appears.



- ① Distance driven since last reset
- ② Time elapsed since last reset
- ③ Average speed since last reset
- ④ Average fuel consumption since last reset

## Calling up the range





Using the steering wheel buttons

- ▶ Press the  or  button repeatedly until the display shows the **After start** message.
- ▶ Press the  or  button repeatedly until the **Range** message appears. The approximate distance which can be covered with the tank's current contents and your current style of driving is shown.

- ❗ If the fuel tank is almost empty, the  **Please refuel** message is shown instead of the range.

## Resetting the consumption statistics

Using the steering wheel buttons

- ▶ Press the  or  button repeatedly until the display shows the **After start** message.
- ▶ Press  or  to select the function you would like to reset.
- ▶ Press and hold the  reset button until the values are reset to "0".

- ❗ The consumption statistics **After start** are automatically reset after 999 hours or 9,999 miles (kilometers). The consumption statistics **After Reset** are automatically reset after 9,999 hours or 99,999 miles (kilometers).

## Telephone menu

You can operate the mobile phone using the functions in the **TEL** menu, provided it is connected to the Sprinter hands-free system.

### **Warning**



A driver's attention to the road must always be his/her primary focus when driving. For your safety and the safety of others, we recommend that you pull over to a safe location and stop before placing or taking a telephone call. If you choose to use the

telephone while driving, please use the hands-free device and only use the telephone when weather, road and traffic conditions permit.

Some jurisdictions prohibit the driver from using a mobile phone while driving a vehicle. Bear in mind that at a speed of just 30 mph (approximately 50 km/h), your vehicle is covering a distance of 44 feet (approximately 14 m) every second.

## Switching the mobile phone on

Using the steering wheel buttons

- ▶ Switch on the mobile phone and the audio system; see the separate operating instructions.
- ▶ Press the  or  button repeatedly until the **TEL** menu appears in the display. The information in the display depends on the status of the mobile phone:
  - **Mobile phone off:** the display shows the **TEL off** (Audio 20) message.
  - **PIN not entered:** the display shows the **TEL PIN** (Audio 20) message.
- ▶ Enter the PIN code using the mobile phone or audio system.

The mobile phone searches for a network. The display remains blank during this time. You will see the operational readiness display as soon as the mobile phone has found a network.

Once the operational readiness symbol is shown, you can operate the mobile phone using the steering wheel buttons.

- ❗ If the operational readiness symbol goes out, your vehicle is outside the transmission/reception range.

## Accepting a call

You can accept a call at any time, provided the mobile phone is ready to receive calls. You will see the following message in the display:













- ▶ Press . The display shows the call duration.

### Rejecting or ending a call

- ▶ Press . The caller then hears the engaged tone. The display shows the operational readiness symbol again.

### Dialing a number from the phone book

You may select and dial a number from the phone book at any time, provided the mobile phone is ready to receive calls.







- ▶ **i** It is only possible to create new phone number entries in the phone book using the mobile phone itself. See the separate operating instructions.
- ▶ Press the  or  button repeatedly until the **TEL** menu appears in the display. The operational readiness display is shown.
- ▶ Press  or  to switch to the phone book. The on-board computer reads the phone book stored on the SIM card or in the mobile phone. This may take more than a minute. The display shows the **Processing** (Audio 20) message. Reading is complete when the message disappears.
- ▶ Press  or  to select the desired name. The display shows the stored names in alphabetical order.
- ▶ **i** The display scrolls through the names rapidly if you press  or  for longer than one second. Releasing the button stops the rapid scroll. If you do not wish to make a call, press the  button.
- ▶ Press . The on-board computer dials the corresponding phone number. The display shows the **dialing** (Audio 20) message.

The on-board computer stores the phone numbers in the redial memory.

When a connection is made, the display shows the name of the other person and the call duration.

### Redialing

The on-board computer stores the last phone numbers dialed. This means that you do not have to search through the entire phone book.

- ▶ Press the  or  button repeatedly until the **TEL** menu appears in the display. The operational readiness display is shown.
- ▶ Press . The display shows the most recently dialed numbers or names in the redial memory.
- ▶ Press the  or  button repeatedly until the number or name you are looking for is displayed.
- ▶ Press . The on-board computer dials the corresponding phone number. If a connection is made, the display shows the call duration and name of the person you are calling, if stored in the phone book, or the number you are dialing continues to be displayed.

### Power supply

#### Battery isolating switch

You can use the battery isolating switch to disconnect the power supply to all your vehicle's consumers. This will prevent uncontrolled battery discharge caused by off-load current consumption.

#### **Warning**

If the vehicle is equipped with an additional battery in the engine compartment, it is necessary to disconnect both batteries when working on the vehicle electrical circuit. Only

then is the electrical system fully disconnected from the power supply.

- i** Only disconnect the vehicle electrical system from the power supply using the battery isolating switch if the vehicle is to be parked up for a long period or if it is absolutely necessary. After the power supply has been activated, you must reset the side windows (▷ page 61).



Battery isolating switch in the driver's footwell, on the right-hand side next to the accelerator pedal

- !** Make sure that the key is in position **0** in the ignition lock and wait at least 20 seconds before disconnecting or connecting the battery isolating switch. You could otherwise damage electrical system components.

### Switching off the electrical system

- ▶ Remove the key from the ignition lock and wait for about 20 seconds.
- ▶ Press and hold button **2** and unplug connector **1** from the earth pin.
- ▶ Clamp connector **1** under the accelerator pedal so that it cannot make contact with the earth pin.  
All starter battery consumers are disconnected from the power supply.

- !** When you clamp the connector under the accelerator pedal, make sure that the connector does not become damaged or dirty. It may otherwise not be possible to

restore the electrical connection when the parts are reassembled.

### Switching on the electrical system

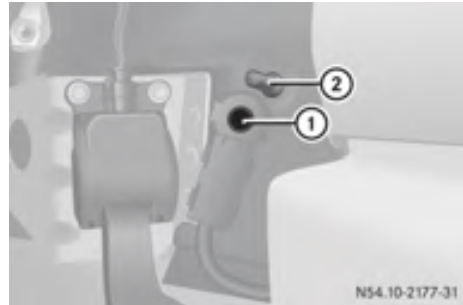

- ▶ Insert the key into the ignition lock.
- ▶ Press connector **1** onto earth pin **2** until you feel it engage and the lock inhibitor is released.  
The connector must be in full contact with earth pin **2**.

All consumers are reconnected to the DC power supply.

## Lighting

### General notes

Legal requirements may impose variations in certain countries.

- i** When driving in countries in which traffic drives on the opposite side of the road to the country where the vehicle is registered, the oncoming traffic may be dazzled. On vehicles with halogen headlamps you must have the headlamps partially masked. On vehicles with Bi-Xenon headlamps you must have the headlamps switched over beforehand.

You will find further information in the "Operation" section (▷ page 138).

## Lamp failure indicator

The bulb failure indicator monitors all lamps of the exterior lighting with the exception of the front position lamps and the trailer lighting. If a bulb fails, either the  (▷ page 197) indicator lamp lights up or a corresponding message is shown in the display (▷ page 209).

- ① Depending on the equipment, the bulb failure indicator can be omitted for all lamps with the exception of the turn signal lamps.

### Warning

The bulb failure indicator is only an aid. You are responsible for the proper functioning of the vehicle lighting. Insufficient or non-functioning vehicle lighting puts the operating safety of the vehicle at risk. You could cause an accident and injure yourself or others.

Therefore, check the lighting equipment of the vehicle before each journey and, if necessary, check the operation and condition of the trailer lighting equipment.

## Light switch

### Configuration



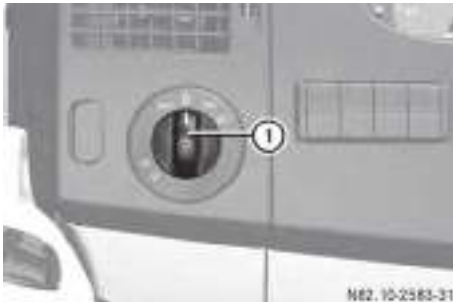

You can switch the vehicle lighting on or off using the light switch.

The light switch is located between the driver's door and the steering wheel.





① Light switch

The symbols on the light switch have the following meanings:

-  Automatic headlamp mode
-  Lights off/daytime running lamp mode
-  Parking lamps, license plate lamp and instrument lighting on
-  Low-beam/high-beam headlamps (depending on the position of the combination switch)

### Low-beam headlamps



- ▶ Turn the key to position **1** in the ignition lock.
- ▶ Turn the light switch to . The  indicator lamp in the instrument panel lights up.

### Daytime running lamp mode



You can adjust daytime running lamp mode in the on-board computer:

- vehicles with steering wheel buttons (▷ page 74)
- vehicles without steering wheel buttons (▷ page 74)



This is not possible in countries where daytime running lamp mode is a legal requirement.

- ▶ Turn the light switch to . The low-beam headlamps, parking lamps and license plate lamp are switched on when the engine is running. The  indicator lamp in the instrument panel lights up.

#### ① USA only:

When you turn the light switch to  or , the respective light comes on. When the light switch is turned to **AUTO**, daytime running lamp mode remains switched on.

#### ① Canada only:

When you turn the light switch to , the low-beam headlamps are switched on. When the light switch is turned to  or

**AUTO**, daytime running lamp mode remains switched on.

### Automatic headlamp mode

Parking lamps, low-beam headlamps and the license plate lamp are switched on automatically depending on the ambient light.

#### **Warning!**





If the light switch is set to **AUTO**, the low-beam headlamps will not come on automatically if it is foggy. This could endanger you and others. Therefore, turn the light switch to  in fog.

The automatic headlamp feature is only an aid. The driver is responsible for the vehicle's lighting at all times.

- ▶ Turn the light switch to **AUTO**.  
The parking lamps are switched on/off automatically when the key is in position **1** in the ignition lock.

Parking lamps, low-beam headlamps and the license plate lamp are switched on/off automatically, depending on ambient light conditions, when the engine is running.

### Front fog lamps/rear fog lamp

- ▶ Turn light switch ① to  or .
- i** If your vehicle is only equipped with rear fog lamps, you must turn the light switch to .
- ▶ **Front fog lamps:** pull light switch ① out to the first stop.  
The green  indicator lamp next to the light switch lights up.
- ▶ **Rear fog lamp:** pull light switch ① out to the second stop.  
The yellow  indicator lamp next to the light switch lights up.

### Combination switch

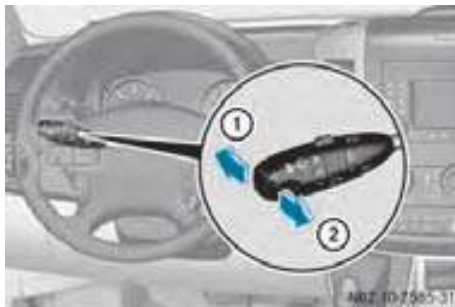

- ① High-beam headlamps
- ② High beam flasher

### High-beam headlamps

- ▶ **To switch on:** switch on the low-beam headlamps (▷ page 89).
- ▶ Press combination switch ① forwards.  
The  indicator lamp on the instrument panel comes on.

### High beam flasher

- ▶ Turn the key to position **1** or **2** in the ignition lock.
- ▶ Pull the combination switch briefly in direction ②.

### Turn signals

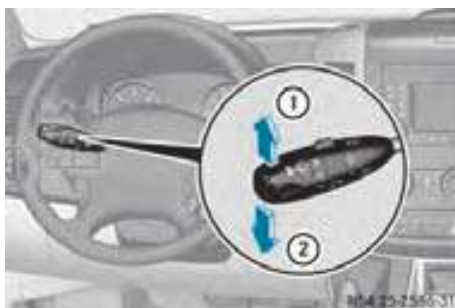

- ① To indicate a right turn
- ② To indicate a left turn

- ▶ **To indicate:** press the combination switch in desired direction ① or ②, until it engages. The combination switch automatically returns to its original position after large steering movements.
- ▶ **To indicate briefly:** press the combination switch briefly in desired direction ① or ②. The corresponding turn signal flashes three times.

### Cornering light function (vehicles with Bi-Xenon headlamps)

When the low-beam headlamps are switched on, the cornering light function improves the illumination of the road in the direction you are turning.

#### The cornering light function switches on automatically, if:

- you are traveling at a speed of less than 25 mph (40 km/h) and you switch on the indicator lamp or turn the steering wheel.
- you are traveling at a speed of between 25 mph (40 km/h) and 43 mph (70 km/h) and you turn the steering wheel.

The cornering light may continue to be lit for a short time, but is deactivated automatically after a maximum of three minutes.

### Hazard warning lamps

The hazard warning lamps work even when the ignition is switched off. They are activated automatically when an air bag is deployed or after heavy brake application from a speed of more than 43 mph (70 km/h) that brings the vehicle to a standstill.



- ▶ **To switch on/off:** press button ①.

- ❗ If you have indicated a turn while the hazard warning lamps are switched on, only the turn signal lamps on the side of the vehicle selected will light up. If the hazard warning lamps have been switched on automatically, press the hazard warning lamp switch to switch them off.

#### ⚠ Warning

If you open the rear doors 90° (detent position) or fold down the platform tailgate on vehicles with a platform, the rear lights are covered.

The vehicle will then be unsafe as its rear lights will not be visible for approaching traffic. Other road users may not realize until too late that it is an obstruction. This could lead to an accident.

You should ensure that the vehicle is visible from the rear in accordance with the relevant national regulations, by using the warning triangle for instance.

## Front interior lighting

### Standard front interior lighting



- ① To switch on the interior lighting
- ② Automatic control
- ③ To switch off the interior lighting

### Front interior lighting with overhead control panel

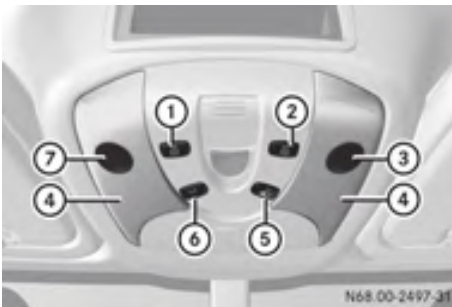

- ① To switch the left-hand reading lamp on/off
- ② To switch the right-hand reading lamp on/off
- ③ Right-hand reading lamp
- ④ Interior light
- ⑤ To switch the automatic control system on/off
- ⑥ To switch the interior lighting on/off
- ⑦ Left-hand reading lamp

If you switch on interior lights or the reading lamps manually, they switch off automatically after about twenty minutes.

## Automatic control

The interior lighting comes on when you:

- unlock the vehicle
- open a door
- remove the key from the ignition lock

The interior lighting switches off automatically. If a door is left open, the interior lighting switches off after approximately 20 minutes.

## Rear interior lighting

### Switching the standard interior lighting on/off

In cargo vans/passenger vans equipped with standard interior lighting, the switch for the interior lighting is located on the rear lights in the cargo compartment/vehicle interior.



Interior light with switch

- ① To switch on the interior lighting
- ② To switch off the interior lighting
- ③ Automatic control

### Switching convenience interior lighting on/off

In passenger vans equipped with convenience interior lighting, the central control switch for the rear interior lighting is located between the steering wheel and the ignition lock.

In addition, there is also a switch on each interior light, which can be used to switch the

lights on/off separately, depending on the position of the central control switch.



Central control switch for the rear interior lighting

- ① To switch on the interior lighting
- ② Automatic control
- ③ To switch off the interior lighting

► **To activate:** press upper section ① on the switch.

The interior lights are switched on if the switches on the interior lights (► page 92) have not been switched to off ②.

► **To deactivate:** press lower section ③ of the switch.

The interior lights are all switched off, regardless of the position of the switch on the interior light.

### Automatic control

► **To switch on:** move the central control switch for the rear interior lighting to position ②.

If the switches on the interior lights (► page 92) are set to automatic control ③, the interior lights come on as soon as you open a door or unlock the vehicle.

❗ The interior lights switch off automatically after twenty minutes.

In order to switch the interior lights on again, you must:

- open a door
- switch on the ignition again

### Cargo compartment motion detector

The interior lighting is also switched on by the motion detector in the cargo compartment on cargo vans equipped with this feature.

#### ⚠ Warning

Motion detectors use the invisible infrared radiation emitted by LEDs (light emitting diodes).

Do not view invisible infrared radiation, laser class 1M, directly using optical instruments, such as eyeglasses.

Your eyes could be injured.

If the motion detector detects a movement in the cargo compartment when the vehicle is stationary, the interior lighting switches on for approximately two minutes.

The interior lighting can be switched on by the motion detector within four seconds if:

- the interior light switch (► page 92) is set to "Automatic control"
- the vehicle is stationary, the parking brake is applied and the brake pedal is not being depressed  
or
- the selector lever is in position **P** on vehicles with automatic transmission and the brake pedal is not being depressed and
- the vehicle has not been locked from the outside using the key

The motion detector switches off automatically if no change is detected in the vehicle for several hours, e.g. door opened, ignition key turned, etc. This prevents the battery from becoming discharged.

## Good visibility

### Windshield wipers

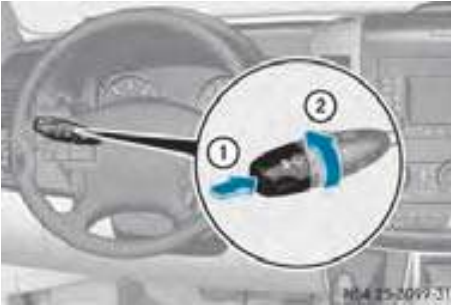

- ① Single wipe/to wipe with washer fluid  
(▶ page 95)
- ② To switch on the windshield wipers

### Switching on the windshield wipers

- ▶ Turn the key to position **1** or **2** in the ignition lock.
- ! Vehicles with rain/light sensor:  
Switch the wipers off in dry weather. Otherwise, dirt or optical effects may cause undesired windshield wiper sweeps. This could then damage the windshield wiper blades or scratch the windshield.
- ▶ Turn the combination switch in the direction of arrow **②** to the appropriate setting depending on the intensity of the rain.

The detent positions of the combination switch correspond to the following wiper speeds:

- 0 Windshield wipers off
- I Intermittent wipe
- II Normal wipe
- III Rapid wipe

- i Canada only:  
If the windshield wipers are switched on and you stop the vehicle, the windshield wiper speed is reduced. For example, if you have selected level **II** and stop the vehicle,

wiping continues with intermittent wipe while the vehicle is stationary. If intermittent wipe is selected, the intervals become longer.

**Vehicles with a rain/light sensor:** you can use level **I** as the universal setting. The rain/light sensor sets the appropriate wiping frequency automatically, according to the intensity of the rain. When you stop the vehicle, levels **III** and **II** are switched down to level **I** automatically.

The windshield wipers will return to the original level when you drive faster than 5 mph (8 km/h) again.

Setting the sensitivity of the rain/light sensor .

### Rear window wiper

The rear window wiper switches on automatically if you engage reverse gear and the windshield wipers are on.

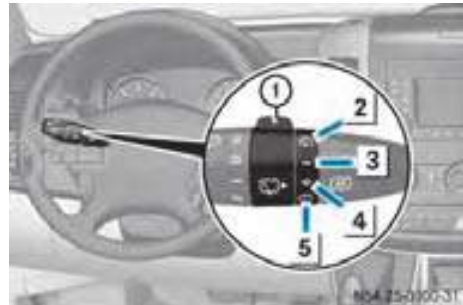

- ① Switch
- ② To wipe with washer fluid
- ③ Intermittent wipe
- ④ To switch off the windshield wiper
- ⑤ To wipe with washer fluid

- ▶ Turn the key to position **1** or **2** in the ignition lock.
- ▶ Turn switch **①** to the corresponding position



- ① Use washer fluid to wipe the rear window even when it is raining. This prevents the rear window from smearing.

### Windshield washer system

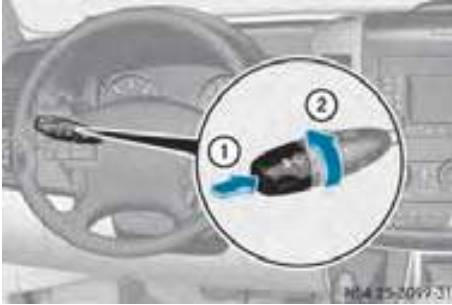

- ① To wipe with washer fluid
  - ② To switch on the windshield wipers
- ▶ Press the combination switch beyond the pressure point in the direction of arrow ①.
- The windshield wipers wipe with washer fluid.

- ① Wipe the windshield using washer fluid even if it is raining. By doing so, you will prevent smears on the windshield.

### Headlamp cleaning system

- ▶ Switch on the low-beam headlamps.
- ▶ Switch on the windshield washer system. The headlamps are cleaned with a high-pressure water jet.

### Windshield heater

#### Important safety notes

#### Warning

Clear all windows of ice and snow before driving off. Reduced visibility can, otherwise, endanger you or others.

### Windshield heater

The windshield heater is operational when the engine is running.

The windshield heater consumes a lot of power. You should therefore switch off the heater as soon as the windshield is clear. The heating switches off automatically after five minutes.



Windshield heater switch

- ▶ Start the engine.
- ▶ **To switch on/off:** press the ① switch. The indicator lamp in the switch comes on when the windshield heater is switched on.

### Rear window defroster

The rear window defroster is operational when the engine is running. The rear window defroster consumes a lot of power. You should therefore switch the rear window defroster off as soon as the window is clear. The heating switches off automatically after approximately twelve minutes.

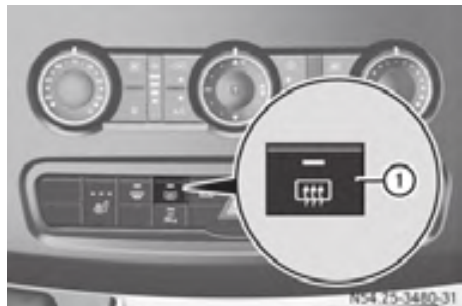

Rear window defroster switch

- ▶ Start the engine.
- ▶ **To switch on/off:** press the ① switch.  
The indicator lamp in the switch comes on when the rear window defroster is switched on.

## Climate control

### Overview of climate control systems

The vehicle is equipped with one of the following climate control systems:

#### Heating



The heating system is a heating and ventilation system, without a cooling system (▷ page 98).

#### Air-conditioning system



The air-conditioning system is a combination of a heating and ventilation system, together with a cooling system (▷ page 99).

#### Rear-compartment heating



The separately activated rear-compartment heating allows a separate temperature and airflow setting for the rear compartment (▷ page 99).

#### Rear-compartment air-conditioning system



The separately activated rear-compartment air conditioning allows a separate temperature and airflow setting for the rear compartment (▷ page 100).

On vehicles without rear-compartment air conditioning, the control unit is equipped with a paper holder (▷ page 131).

## General notes

### Warning

A driver's attention to the road and traffic conditions must always be his/her primary focus when driving.

For your safety and the safety of others, we recommend that the driver should only select functions through the control panel of the climate control system when traffic and road conditions permit it to be done safely.

Bear in mind that at a speed of just 30 mph (approximately 50 km/h), your vehicle is covering a distance of 44 feet (approximately 14 m) every second.

The air-conditioning system regulates the temperature and humidity of the vehicle interior and filters undesired particles out of the air.

The heating/air-conditioning system can only be operated when the engine is running. The system only functions optimally when the side windows are closed.

The installed filter removes most dust particles, pollen and unpleasant odors drawn in from the outside air. A clogged filter reduces the airflow into the vehicle interior. The interval for replacing the filter depends on environmental influences. The interval may be shorter than that indicated in the Maintenance Booklet.

-  Ventilate the vehicle for a brief period during warm weather or briefly switch to air-recirculation mode to quickly cool down the vehicle if you have air conditioning/automatic climate control. In this way, you will accelerate the cooling process and achieve the desired temperature faster.

### Warning

Observe the settings recommended on the following pages. The windows could otherwise fog up. This may obstruct your view of the traffic situation and, as a result, you may cause an accident.

## Electrical heater booster system

The vehicle can be equipped with an electrically-powered heater booster system. The heater booster system ensures that the vehicle interior is heated up very quickly during the engine's warm-up phase.





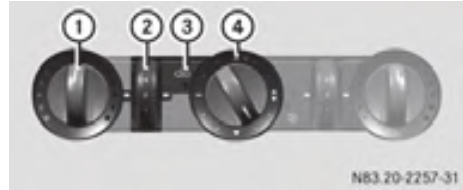

-  The heater booster system switches on automatically as required.

## Overview of the functions of the climate control system

### Heating



Control panel, left-hand-drive vehicles

Operation	
①	Sets the temperature (▷ page 100)
	 Defrosts the windshield
②	 Sets the airflow (▷ page 102)
	 Defrosts the windshield
③	 Switches air-recirculation mode on/off (▷ page 104)
④	Sets the air distribution (▷ page 102)
	  Defrosts the windshield

Recommendations for optimum climate control:

- set the temperature control to the middle level. Only change the temperature in small increments.
- only use the defrosting function until the windshield is clear again (▷ page 103).
- only use air-recirculation mode briefly, e.g. in a tunnel. The windows could otherwise fog up, because the flow of fresh air is cut off and the air inside the vehicle is circulated.

### Rear-compartment heating

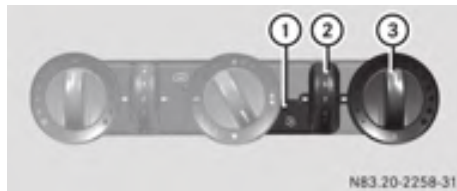

Operation	
①	Switches air-recirculation mode on/off (▷ page 100)
②	Sets the airflow (▷ page 102)
③	Sets the temperature (▷ page 100)

For optimum climate control, set the temperature control to the middle level. Only change the temperature in small increments.

### Air-conditioning system

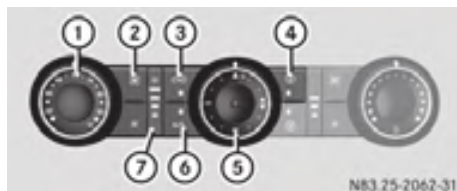

Operation	
①	Sets the temperature (▷ page 100) Defrosts the windshield
②	Sets the airflow (▷ page 102) Increases the airflow Decreases the airflow
③	Switches air-recirculation mode on/off (▷ page 104)
④	Switches the reheat function (window air dehumidification) on/off (▷ page 103)
⑤	Sets the air distribution (▷ page 102) Defrosts the windshield
⑥	Switches cooling with air dehumidification on/off (▷ page 100)
⑦	Blower setting bar display Defrosts the windshield



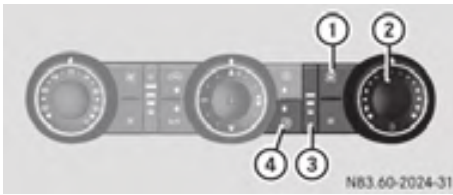

Recommendations for optimum climate control:

- Set the temperature to 72 °F (22 °C) . Only change the temperature in small increments.
- Switch on cooling with air dehumidification. The indicator lamp in the switch comes on.
- Only use the defrosting function until the windshield is clear again (▷ page 103).
- Only use the reheat function until the fogged up windows are clear again.
- Only use air-recirculation mode briefly, e.g. in a tunnel. The windows could otherwise fog up, because the flow of fresh air is cut off and the air inside the vehicle is circulated.

## Rear-compartment air-conditioning system



### Operation



- |   |   |
|---|---|
| ① | Sets the airflow (▷ page 102)<br> Increases the airflow<br> Decreases the airflow |
| ② | Sets the temperature (▷ page 100)   |
| ③ |  Blower setting bar display  |
| ④ |  Activates/deactivates the rear-compartment air-conditioning system (▷ page 100)   |

For optimum climate control, set the temperature control to the middle level. Only change the temperature in small increments.

### Switching the climate control on/off

When the climate control is switched off, air intake and air circulation also stop. Only select this setting briefly, as otherwise, the windows may fog up.

### Air-conditioning system

- ▶ **To activate:** press the  button and adjust the blower setting to at least the first level.  
The blower speeds are shown in bars next to the button.
- ▶ **To switch off:** press the  button and after reaching the lowest blower setting, press it again.

## Rear-compartment heating/rear-compartment air conditioning

- ▶ Press the  button.  
If the indicator lamp in the button lights up, the rear-compartment heating/rear-compartment air conditioning is switched on.

### Switching cooling with air dehumidification on/off

If you want to cool the air inside the vehicle to the set temperature, you must switch on cooling with air dehumidification in vehicles with an air-conditioning system. The air inside the vehicle is then cooled and dehumidified. This prevents the windows from misting up. Condensation may appear on the underside of the vehicle when in cooling mode.

### Warning

If you switch off the cooling function, the vehicle will not be cooled when weather conditions are warm. The windows can fog up more quickly. This may prevent you from observing the traffic conditions, thereby causing an accident.

- ▶ Press the  button.  
If the indicator lamp in the button lights up, cooling with air dehumidification is switched on.

### Setting the temperature

#### Heating/air-conditioning system

- ▶ Turn temperature control ① clockwise to increase the temperature or counterclockwise to reduce the temperature (▷ page 98), (▷ page 99). Begin in the center position or at 22 °C. Only change the temperature in small increments.

## Rear-compartment heating/rear-compartment air conditioning

- ▶ Make sure that the rear-compartment climate control (rear-compartment heating/air conditioning) is switched on (▷ page 100).
  - ▶ Turn rear-compartment heating temperature control ③ (▷ page 99) or rear-compartment air conditioning temperature control ② (▷ page 100) clockwise to increase or counterclockwise to reduce the temperature. Only change the temperature in small increments.
- i** Your vehicle may be equipped with rear-compartment heating and rear-compartment air conditioning. If you set the temperature control to the center position, only one of the two climate control systems is activated in the rear compartment and set to air-recirculation mode (▷ page 104).

## Setting the air vents

### General notes

#### Warning

Air flowing out of the air vents may be very hot or very cold. Therefore, there is a risk of frostbite or burns to exposed skin in the immediate proximity of these air vents. Keep exposed parts of the body away from these air vents. If necessary, direct the airflow to a different area of the vehicle interior.

You can set the center and side air vents. The entire vehicle interior is ventilated via the air vents.

Observe the following instructions so air can flow freely through the air vents:

- keep the air inlet on the hood free from ice and snow.
- never cover the vents or air inlet and outlet grilles in the vehicle interior.
- for virtually draft-free ventilation, move the sliders on the center air vents to the central position.

### Center air vents



- ① Center air vent, left
- ② Center air vent, right
- ③ Thumbwheel for center air vent, right
- ④ Thumbwheel for center air vent, left

- ▶ Turn thumbwheel ③ or ④ to the right to open and to the left to close to close the center air vent.

### Side air vents



Side air vent (example, right-hand side of the vehicle)

- ▶ Turn thumbwheel ③ up to open and down to close side air vent ①.

If the  symbol can be seen on thumbwheel ③, defroster vent ② is open.

### Air vents

You can use the air vents to ventilate the vehicle interior on the left and right, in the rear and the headroom.



Air vents (example, right-hand side of the vehicle)

- ① Air vent thumbwheel, left-hand side of the vehicle
- ② Air vent thumbwheel, right-hand side of the vehicle
- ▶ Turn thumbwheel ① or ② to the right to open and to the left to close the air vents.

### Air vent in the roof duct

On vehicles with rear-compartment air conditioning, adjustable air vents are integrated into the roof duct.







- ▶ Set the airflow by opening/closing the air flaps.
- ▶ Set the air distribution by turning air vents ①.

**!** Always leave at least one air vent open.

If the rear-compartment air conditioning is switched on and all the air vents are closed, the air-conditioning system may be damaged.

### Setting the air distribution

The air distribution symbols have the following meanings:

-  Directs air through the center and side air vents
-  Directs air to the windshield and the air vents
-  Directs air to the windshield, the air vents and into the footwell
-  Directs air to the air vents and into the footwell

### Heating/air-conditioning system

- ▶ Set air-distribution control for the heating ④ (▷ page 98) or air conditioning ⑤ (▷ page 99) to the corresponding symbol.



### Setting the airflow

#### Heating/rear-compartment heating

- ▶ On vehicles with rear-compartment heating, make sure that the rear-compartment climate control is activated (▷ page 100).
- ▶ Set airflow control ② to the desired level (▷ page 98), (▷ page 99).



## Air-conditioning system/rear-compartment air conditioning

- ▶ On vehicles with rear-compartment air conditioning, make sure that the rear-compartment climate control is activated (▷ page 100).
- ▶ Press the  button to reduce or the  button to increase the airflow. The blower speeds are shown in bars next to the buttons.

### Defrosting the windows



#### Warning

Clear all windows of ice or snow before setting off. Otherwise, impaired visibility could endanger you and others.



Only use the following settings until the windows are clear again.



- ▶ **Vehicles with window heating:** switch on the front and/or rear window defroster (▷ page 95).

### Heating

- ▶ Set temperature control ① and airflow control ② to  (▷ page 98).
- ▶ Set air-distribution control ④ to   (▷ page 98).
- ▶ Close the center air vents and the air outlets for the headroom and the rear compartment (▷ page 101).
- ▶ Direct the side air vents towards the side windows and open the demister vents for the side windows (▷ page 101).

### Air-conditioning system

- ▶ Set temperature control ① to  (▷ page 99).
- ▶ Press the  button until the maximum blower output is reached. All bars in the display next to the button light up.

- ▶ Set air-distribution control ⑤ to   (▷ page 99).
- ▶ Close the center air vents and the air outlets for the headroom and the rear compartment (▷ page 101).
- ▶ Direct the side air vents towards the side windows and open the demister vents for the side windows (▷ page 101).



### Defrosting windows

#### Windows fogged up on the inside

Only use the following settings until the windows are clear again.



- ▶ **Vehicles with window heating:** switch on the front and/or rear window defroster (▷ page 95).
- ▶ Switch off air-recirculation mode (▷ page 104).

### Heating

- ▶ Set temperature control ① to a higher temperature (▷ page 98).
- ▶ Set airflow control ② to a higher blower setting. It should be set at least to level two (▷ page 98).
- ▶ Set air-distribution control ④ to   (▷ page 98).

If the windows still fog up, set the control as described for defrosting (▷ page 103).

### Air-conditioning system

- ▶ Activate cooling with air dehumidification (▷ page 100).
- ▶ Press the  button. The reheat function is switched on. The indicator lamp in the switch lights up. To switch off the reheat function, press the  button again. The indicator lamp in the button goes out.

## Windows fogged up on the outside

Only use the following settings until the windshield is clear again.

- ▶ Switch on the windshield wipers (▷ page 94).
- ▶ Adjust air distribution to the footwell (▷ page 102).
- ▶ Close the air vents (▷ page 101).

### Switching air-recirculation mode on/off

You can deactivate the intake of fresh air if unpleasant odors enter the vehicle from outside. The air inside the vehicle will only be circulated.

#### Warning

At low outside temperatures, only switch over to air-recirculation mode for brief periods. Otherwise, the windows could fog up, thus impairing visibility and endangering yourself and others. This may prevent you from observing the traffic conditions and thereby cause an accident.

## Heating/air-conditioning system

- ▶ Press the  button.  
If the indicator lamp in the button lights up, air-recirculation mode is activated.

Air-recirculation mode switches off automatically after about 10 to 30 minutes, depending on the outside temperature.

## Rear-compartment heating/rear-compartment air conditioning

If your vehicle is equipped with rear-compartment heating and rear-compartment air conditioning, you can activate/deactivate the air-recirculation mode of the rear-compartment climate control.

- ▶ **To activate:** set temperature control of the rear-compartment heating ③ (▷ page 99) or or temperature control of the rear-

compartment air conditioning ② (▷ page 100) to the center position. Only one of the two climate control systems in the rear compartment is activated and is in air-recirculation mode.

- ▶ **To deactivate:** turn temperature control of the rear-compartment heating ③ (▷ page 99) or temperature control of the rear-compartment air conditioning ② (▷ page 100) clockwise or counterclockwise. Only change the temperature in small increments.

## Auxiliary heating

### Important safety notes

#### Warning

Exhaust fumes are produced while the auxiliary heating system is in operation. If you breathe in these exhaust fumes, you could be poisoned. Therefore, always switch off the auxiliary heating in enclosed spaces without an extraction system, e.g. a garage.

#### Warning

Parts of the vehicle can become very hot during operation of the auxiliary heating. Make sure that the exhaust system does not under any circumstances come into contact with highly flammable material such as dry grass or fuels. Otherwise, the highly flammable material could ignite and set the vehicle alight.

Auxiliary heating operation is prohibited at gas stations or when your vehicle is being refueled. Therefore, the auxiliary heating must be switched off at gas stations.

#### Warning

When transporting hazardous materials, always observe the relevant safety regulations.

Spray canisters and gas cartridges or other pressurized containers carried in the vehicle

may be highly flammable and could explode if heated.

In particular, make sure that the containers described above are not placed in the hot air flow from the auxiliary heating system. Do not stow such containers directly next to or on top of the heater.

You could otherwise endanger yourself and others.

The auxiliary heating system operates independently of the engine and complements the vehicle heating or air conditioning.

You can set the auxiliary heating at an outside temperature of up to 39 °F (4 °C) in order to:

- pre-heat the vehicle interior
- additionally warm the coolant, thereby conserving the engine and saving fuel
- support the vehicle's heating system while the engine is running and outside temperatures are low (heater booster function)

**i** If the outside temperature rises above 39 °F (4 °C), the auxiliary heating and heater booster function switch off automatically.

**!** Switch on the auxiliary heating system at regular intervals (at least once a month) for approximately 10 minutes.

Make sure that the flow of hot air is not blocked. Otherwise, the auxiliary heating will overheat and switch off.

**i** If the interior motion sensor (▷ page 62) is armed and the auxiliary heating is switched on, it is possible that the interior temperature monitoring may cause a false alarm. In this case, either deactivate the interior motion sensor or switch off the auxiliary heating.

## Before switching on

- ▶ The fuel tank must be at least one-quarter full.
  - ▶ Set the desired temperature using the temperature control of the heating or the air-conditioning system (▷ page 100).
  - ▶ Set the air distribution as required (▷ page 102).
  - ▶ Open the center and side air vents and set them to the middle position (▷ page 101).
- i** The auxiliary heating automatically switches to heater booster mode after the engine is started.

## Operating using the switch

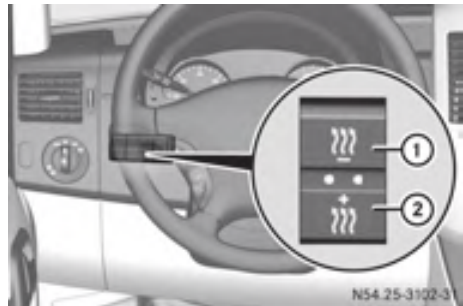

- ① To switch the auxiliary heating on/off
- ② To switch the heater booster function on/off (▷ page 107)

▶ **To switch on the auxiliary heating:** press the  switch for longer than two seconds.

- The auxiliary heating heats or ventilates the interior to the temperature that you have set.
- The blower switches to the lowest speed.
- The red indicator lamp in the switch comes on.

- ▶ **To switch off the auxiliary heating:** press the  switch.







or

- ▶ Turn the key to position **0** in the ignition lock.  
The red indicator lamp in the switch goes out.  
The auxiliary heating operates for about another two minutes and then switches off automatically.

### Selecting a switch-on time

You can use the on-board computer to define up to three switch-on times, one of which can be selected.

#### On-board computer without steering wheel buttons

- ▶ Turn the SmartKey to position **2** in the ignition lock.
  - ▶ Press the  switch.  
The  symbol in the display flashes.
- or
- ▶ Press the  menu button on the instrument cluster repeatedly until the  symbol flashes in the display.
  - ▶ Use the  or  buttons on the instrument cluster to select switch-on time **1** to **3**.  
The switch-on time selected is displayed.
  - ▶ Wait 10 seconds for the standard display to appear.  
The switch-on time is selected. The yellow indicator lamp in the  switch comes on.

If you have not preselected a switch-on time and **-- : --** is shown in the display, this means that automatic switch-on mode is deactivated. The yellow indicator lamp in the  switch goes out.

- i** If you turn the key to position **0** in the ignition lock, the yellow indicator lamp in the  switch goes off after 30 minutes.





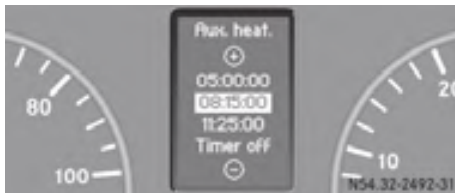

The red indicator lamp in the  switch comes on when the auxiliary heating switches on.

#### On-board computer with steering wheel buttons

- ▶ Turn the SmartKey to position **2** in the ignition lock.
- ▶ Press the  switch.  
The **Aux. heating** submenu is shown in the display.







The selection marker highlights the preselected switch-on time, or **Timer off**, if no switch-on time has been preselected.









- i** You can also access the **Aux. heating** submenu via the **Settings** (> page 79) menu.
- ▶ Use the  or  buttons on the steering wheel to select the desired switch-on time.  
Use the **Timer off** setting to deactivate automatic switch on.
- ▶ Press the  menu button on the steering wheel.  
The switch-on time is selected. The yellow indicator lamp in the  switch comes on.
- i** If you turn the key to position **0** in the ignition lock, the yellow indicator lamp in the  switch goes off after 30 minutes.  
The red indicator lamp in the  switch comes on when the auxiliary heating switches on.

## Setting the switch-on time

### On-board computer without steering wheel buttons

- ▶ Use the same method to select a switch-on time as described in the "Preselecting a switch-on time" section.
- ▶ Press the  reset button on the instrument cluster to set the desired switch-on time.  
The hour display flashes.
- ▶ Use the  and  buttons on the instrument cluster to set the hours.
- ▶ Press the  reset button.  
The minute display flashes.
- ▶ Use the  and  buttons to set the minutes.

### On-board computer with steering wheel buttons

- ▶ Use the same method to select a switch-on time as described in the "Preselecting a switch-on time" section.
- ▶ Press the  menu button on the steering wheel.  
The **Hours** submenu is shown in the display.
- ▶ Press the  or  button on the steering wheel to set the hours.
- ▶ Press the  button.  
The **Minutes** submenu is shown in the display.
- ▶ Press the  or  button to set the minutes.
- ▶ Press the  button.  
The switch-on time is set and selected.

### Heater booster function

If the outside temperature is lower than 39 °F (4 °C), the fuel-operated auxiliary heating heats the vehicle as quickly as possible when the engine is running.

The auxiliary heating automatically switches to heater booster mode after the engine is started.

- ❗ If the outside temperature rises above 39 °F (4 °C), the auxiliary heating and heater booster function switch off automatically.

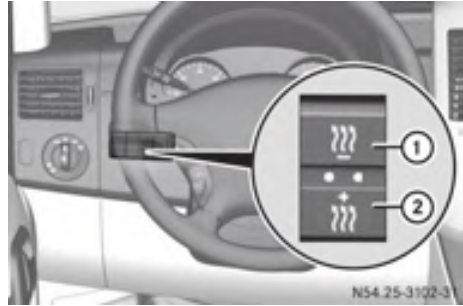

Vehicles with auxiliary heating

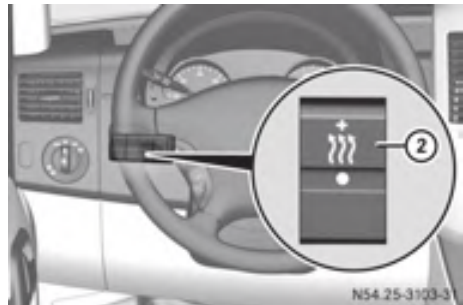

- ① To switch the auxiliary heating on/off
- ② To switch the heater booster function on/off

- ▶ **To switch on/off:** press the  switch. The indicator lamp in the switch lights up if the heater booster function is switched on.



After switching off, the auxiliary heating operates for about another two minutes and then switches off automatically.

If you switch off the engine without switching off the heater booster function, the system will be switched on the next time the engine is started (memory function).

## Roof ventilator in the cargo compartment

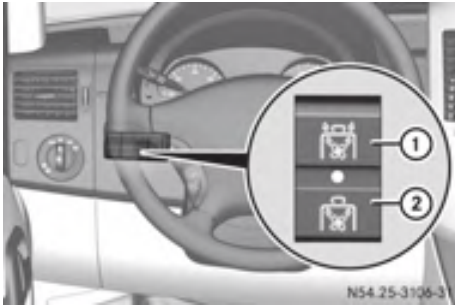
The roof ventilator can be used to ventilate or extract air from the cargo compartment.



- ▶ Turn the SmartKey to position **2** in the ignition lock.
- ▶ **To extract air:** press upper section ① of the  switch. The roof ventilator removes used air from the cargo compartment.
- ▶ **To ventilate:** press lower section ② of the  switch. The roof ventilator feeds fresh air into the cargo compartment.
- ▶ **To switch off:** set the switch to the middle position.

## Driving and parking

### Preparing for a journey

#### Visual check of the vehicle exterior

- ▶ In particular, check the following components on the vehicle, and on the trailer as necessary:
  - license plates, vehicle lighting, turn signals, brake lamps and wiper blades for dirt and damage
  - tires and wheels for firm seating, correct tire pressure and general condition
  - trailer tow hitch for play and security
- ▶ **i** The towing device is one of the most important components on the vehicle with

regard to road safety. The separate instructions issued by the manufacturer pertaining to operation, care and maintenance should be observed.

- ▶ Rectify any noticeable defects before commencing the journey.

#### Checks in the vehicle

##### Emergency equipment/first-aid kit

The equipment for first aid and breakdown assistance is located in the storage compartment in the driver's/co-driver's door and behind the driver's seat.

- ▶ Check the equipment to make sure that it is accessible, complete and ready for use.

##### Vehicle lighting

- ▶ Turn the key to position **2** in the ignition lock.
- ▶ Check the lighting system with the aid of a second person.
- ▶ Replace defective bulbs (▶ page 234).

#### Before driving off

##### Warning

Free movement of the pedals must not be impaired. This would otherwise jeopardize the operating and road safety of the vehicle.

Objects could get caught between the pedals if you accelerate or brake suddenly. You will then be unable to brake, declutch or accelerate as intended. You could cause an accident, thereby endangering yourself and others.

- If you are using floor mats and carpets, make sure that they are properly secured in the driver's footwell so that they do not

slip or obstruct the pedals. Do not place floor mats on top of one another.

- Do not put any objects in the driver's footwell.
- Stow and secure all loose objects in such a way that they cannot get into the driver's footwell while the vehicle is in motion.

### Warning

If they are not properly closed, the doors could open while the vehicle is in motion. This may, for example, cause you to lose your load and injure passengers or endanger other road users.

For this reason, please make sure that all the doors are properly closed and can be locked before starting your journey.

- ▶ Close all doors.
- ▶ Secure the load according to the loading guidelines (▷ page 144).
- ▶ Make sure that the floor mats and carpets are properly secured so that they cannot slip and obstruct the pedals.

## Starting the engine

### Warning

Do not place any objects in the driver's footwell. If you use a floor mat or carpet in the driver's footwell, make sure that it is correctly secured and that there is sufficient clearance for the pedals.

Do not place several floor mats on top of one another.

Loose objects or the floor mats could otherwise get caught between the pedals if you accelerate or brake suddenly. You will then not be able to brake or accelerate as intended. This could lead to accidents and injury.

### Warning

Never leave the engine running in enclosed spaces. The exhaust gases contain toxic

carbon monoxide. Breathing in exhaust fumes is a health hazard and can lead to unconsciousness or death.

- ❗ Do not depress the accelerator pedal when starting the engine.
- ❗ If you depress the brake pedal when starting the engine, the pedal travel is short and the pedal resistance is high. Pedal travel and resistance return to normal when you depress the brake pedal again.
- ▶ Before starting the engine, make sure that:
  - all the doors are closed.
  - all the vehicle occupants are wearing their seat belts correctly.
  - the parking brake is applied.
  - the selector lever is in position **P**.
- ❗ You can also start the engine in neutral **N**.

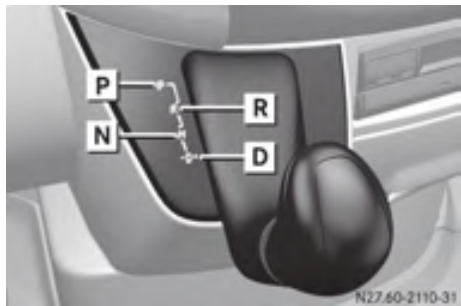



Automatic transmission gearshift pattern

- P** Park position with selector lever lock
- R** Reverse gear
- N** Neutral
- D** Drive

## Starting the engine

- ▶ Turn the key to position **2** in the ignition lock.
 

The  preglow indicator lamp in the instrument cluster lights up.
- ▶ When the  preglow indicator lamp goes out, turn the key to position **3** in the ignition lock and release it as soon as the engine is running.
- i** You can start the engine without preglow when the engine is warm.
- i** Depending on the equipment installed, the vehicle either automatically locks centrally after switching on the ignition or after pulling away. The locking knobs in the doors drop down.
 

You can open the doors from the inside at any time.

Automatic door locking can be deactivated (▷ page 55).

## Driving off

### Warning

Do not downshift for additional engine braking on a slippery road surface. This could cause the drive wheels to lose their grip and the vehicle could skid. You could lose control of the vehicle and cause an accident.

- i** After pulling away or switching on the ignition, the vehicle automatically locks centrally. The locking knobs in the doors drop down.
 

You can open the doors from the inside at any time.

Automatic door locking can be deactivated (▷ page 55).

- ▶ Depress the brake pedal and keep it depressed.
 

The selector lever lock is released.
- ▶ Release the parking brake (▷ page 112).
 

The  indicator lamp in the instrument cluster goes out.
- ▶ Move the selector lever to position **D** or **R**.
- i** On vehicles with a reverse warning feature, a warning signal sounds when reverse gear is engaged to alert other road users.
- !** Only shift into reverse gear when the vehicle is stationary. You could otherwise damage the transmission.
- ▶ Release the brake pedal.
- ▶ Carefully depress the accelerator pedal.

## General driving tips

### Steering

#### Warning

Do not switch off the engine while the vehicle is in motion.

There is no power assistance for the steering or the service brake when the engine is not running.

Steering and braking require significantly more effort and you could lose control of the vehicle and cause an accident as a result.

- !** Do not hold the steering wheel at full steering angle for a long time, e.g. when turning or maneuvering.
 

The hydraulic pump could be damaged if the hydraulic fluid temperature increases.

### Overrun cut-off

If you take your foot off the accelerator pedal, the diesel fuel supply is cut off in overrun mode when the engine speed is out of the idle speed control range.



## Driving in wet conditions

### Warning

There is a danger of hydroplaning occurring, even if you are driving slowly and your tires have sufficient tread depth, depending on the depth of water on the road.

For this reason, avoid tire ruts and brake carefully.

## Driving on flooded roads

If you have to drive on stretches of road on which water has collected, the water level must not rise above the bottom edge of the bumper. The maximum speed at which you may drive is walking speed.

 Note that vehicles in front or oncoming vehicles create waves. This could mean that the maximum permitted water depth is exceeded.

You must observe these notes. Otherwise, damage may occur to the engine, electrics or transmission.

## Driving in winter

Drive particularly carefully on slippery roads in winter. Avoid sudden acceleration, steering and braking maneuvers.

### Warning

Do not downshift for additional engine braking on a slippery road surface. This could cause the drive wheels to lose their grip and the vehicle could skid. You could lose control of the vehicle and cause an accident.

If the vehicle threatens to skid or cannot be stopped when moving at low speed, shift to the neutral position **N**. Try to maintain control of the vehicle using corrective steering

 Vehicles with automatic transmission may roll only briefly in the neutral position **N**. Prolonged rolling of the wheels, e.g. when being towed, will result in transmission damage.

Road salt may adversely affect braking performance. Consequently, you may need to depress the brake pedal more forcefully in order to achieve normal braking force. Apply the brakes regularly when driving for longer periods on gritted or salted roads. This will restore the brakes to their normal level of performance.

When stopping the vehicle after traveling on roads that have been salted, make sure that the brakes are fully functional before proceeding further.

 Fit snow chains to the outside rear wheels (driven axle) in good time for driving on snow, slush or ice. Comply with the manufacturer's fitting instructions.

You will find information about winter tires and about driving with snow chains in the "Operation" section .

## Tire grip

Whereas the vehicle can be fully controlled at a certain speed on a dry road surface, you must reduce your speed on a wet or icy surface to maintain the same degree of safety.

Pay particular attention to the road conditions at temperatures around freezing point. When ice forms on the road surface (e.g. due to fog), applying the brakes can cause a thin layer of water to form rapidly on the ice and tire grip will be greatly reduced. Drive with particular care in such weather conditions.

## Stopping the vehicle and switching off the engine

### Warning

Always switch off the engine and apply the parking brake before leaving the vehicle. Otherwise, the vehicle could roll away if it is not secured.

On gradients steeper than 15%:

- secure an unladen vehicle at the front axle, e.g. using a wheel chock or similar object.
- additionally, secure a laden vehicle at the rear axle, e.g. using a wheel chock or similar object.

#### Warning

Make sure that the exhaust system does not under any circumstances come into contact with easily ignitable material such as dry grass or gasoline. Do not park the vehicle on dry grassland or harvested grain fields. Otherwise, the flammable material may ignite and set the vehicle on fire.

#### Warning

Only remove the key from the ignition lock when the vehicle is stationary, since you cannot steer the vehicle with the key removed.

Never leave children unsupervised in the vehicle. They could release the parking brake. This could lead to a serious or fatal accident.

- !** When the vehicle is parked, always remove the key to prevent the battery from becoming discharged.

On vehicles with a battery isolating switch, switch off the power supply if the vehicle is to be out of use for a longer period of time.

#### Warning

You must use the parking lamps to enable your vehicle to be recognized on public roads when it is dark. You can also use reflective night parking signs in built-up areas.

Observe legal requirements.

- ▶ Stop the vehicle.
- ▶ Shift the automatic transmission to position **P**.
- ▶ Apply the parking brake.

- i** On steep slopes, turn the front wheels towards the curb.

- !** If the coolant temperature is very high, e.g. after driving on mountain roads, leave the engine running at idle speed for about two minutes before turning it off.

This allows the coolant temperature to return to normal.

- ▶ **To switch off the engine:** turn the key to position **0** in the ignition lock and remove it.  
The immobilizer is activated.
- ▶ Switch on the parking lamps if necessary.
- ▶ On uphill or downhill gradients, secure the vehicle additionally against rolling away at the axle with the heaviest load, e.g. by using a wheel chock or similar object.  
Use the wheel chock (▷ page 183) for this purpose.

## Brakes

### Parking brake

#### Warning

Never leave children unsupervised in the vehicle. They could release the parking brake. This could lead to a serious or fatal accident.

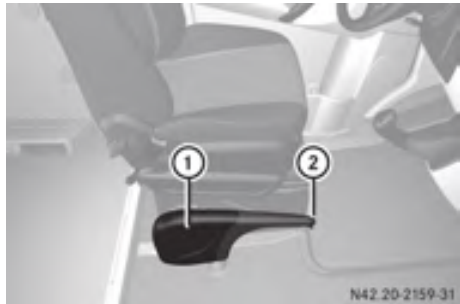

- i** Only apply the parking brake when the vehicle is stationary.

## Applying the parking brake

- ▶ Pull brake lever ① up as far as the last possible detent.  
The  indicator lamp in the instrument cluster lights up.

**i** On vehicles with a folding brake lever, you can then press lever ① down to the stop.

## Releasing the parking brake

- i** On vehicles with a folding brake lever, you must first pull brake lever ① up to the stop.
- ▶ Raise brake lever ① slightly and press release knob ②.
- ▶ Guide brake lever ① down to the stop.  
The  indicator lamp in the instrument cluster goes out.

## Emergency braking

As a rule, you may only apply the parking brake when the vehicle is stationary.

In exceptional cases, the parking brake can be used for emergency braking if the service brake fails.

- ▶ Keep release knob ② pressed and carefully apply brake lever ①.

### Warning

If the brake lever is applied abruptly, the rear wheels could lock. The vehicle could then go into a skid.

Make sure that you apply the brake lever carefully to ensure that braking application is moderated.

operating or driving conditions change, the automatic transmission reacts by adjusting the gearshift program.

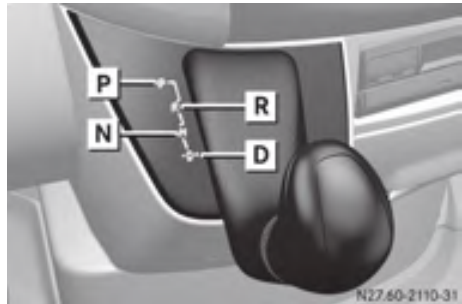

The automatic transmission selects the individual gears automatically. This depends on:

- the selector lever position **D** with shift ranges **4, 3, 2** and **1** (▷ page 115)
- the position of the accelerator pedal
- the road speed

The selector lever position or the current shift range is shown in the display. Display on vehicles with steering wheel buttons (▷ page 77) and without steering wheel buttons (▷ page 73).

When the selector lever is in position **D**, you can influence the gearshifts made by the automatic transmission. You can restrict the shift range or you can perform gearshifts yourself.

## Automatic transmission

### Overview

The automatic transmission adapts to your individual driving style by continuously adjusting its shift points. These shift point adjustments take into account the current operating and driving conditions. If the

### Selector lever positions

**P**

#### Park position

This prevents the vehicle from rolling away when stopped. Only move the selector lever to **P** when the vehicle is stationary.

You can only remove the key when the selector lever is in position **P**. The selector lever is locked in position **P** when the key is removed.

**R**

#### Reverse gear

Only move the selector lever to **R** when the vehicle is stationary.

**N**

#### Neutral

No power is transmitted from the engine to the drive wheels. Releasing the brakes will allow you to move the vehicle freely, e.g. by pushing or towing.

Do not move the selector lever to **N** while driving. The automatic transmission could otherwise be damaged.

If ASR is deactivated or ESP® has malfunctioned: only move the selector lever to **N** if the vehicle is in danger of skidding, e.g. on icy roads.

**D**

#### Drive

The automatic transmission changes gear automatically. All five forward gears are available.

### Touchshift

When the selector lever is in position **D**, you can perform gearshifts yourself.

- ▶ **To shift down:** press the selector lever to the left towards **D-**.  
The automatic transmission shifts to the next gear down, depending on the gear

currently engaged. This will also restrict the shift range.

### Warning

Do not change down for additional engine braking on a slippery road surface. This could cause the drive wheels to lose their grip and the vehicle could skid.

- i** The automatic transmission does not shift down if you press the selector lever towards **D-** while traveling at too high a speed. The engine could otherwise overrev.
- ▶ **To shift up:** briefly press the selector lever to the right towards **D+**.  
The automatic transmission shifts to the next gear up, depending on the current gearshift program. This also extends the shift range.
- ▶ **To derestrict the shift range:** press and hold the selector lever towards **D+** until **D** is shown once more in the display.  
The automatic transmission shifts from the current shift range directly to **D**.
- ▶ **To select the optimum shift range:** press and hold the selector lever to the left towards **D-**.  
The automatic transmission will shift to a range which allows easy acceleration and deceleration. To do this, the automatic transmission will shift down one or more gears.

### Shift ranges

When the selector lever is in position **D** you can restrict or derestrict the shift range for the automatic transmission.

- ▶ Press the selector lever briefly to the right towards **D+** or left towards **D-**.  
The set shift range is shown in the display.
- i** If the maximum engine speed for the shift range is reached and you depress the accelerator pedal, the automatic

transmission will not shift up if the shift range is restricted.

<b>D</b>	The automatic transmission shifts through all five gears.
<b>4</b>	The automatic transmission shifts only as far as fourth gear.
<b>3</b>	The automatic transmission shifts only as far as third gear. This position allows you to use the braking effect of the engine.
<b>2</b>	The automatic transmission shifts only as far as second gear. This position is for journeys in arduous conditions, in mountainous terrain or on steep mountain roads. You can use the engine's braking effect on downhill gradients.
<b>1</b>	The automatic transmission only works in first gear. The braking effect of the engine can be utilized on extremely steep downhill gradients and long downhill stretches.

### Driving tips

#### Accelerator pedal position

Your style of driving influences how the automatic transmission shifts gear:

- little throttle: early upshifts
- lots of throttle: later upshifts

#### Kickdown

Use kickdown for maximum acceleration:

- ▶ Depress the accelerator pedal beyond the pressure point.  
The automatic transmission shifts to the next gear down, depending on the engine speed.
- ▶ Ease off on the accelerator pedal once the desired speed is reached.  
The automatic transmission shifts up again.

#### Stopping

If you only need to stop briefly:

- ▶ Leave the selector lever in the drive position.
- ▶ Secure the vehicle against rolling away using the brake pedal.

#### Maneuvering

Maneuvering in a tight space:

- ▶ Control the vehicle's speed by braking carefully.
- ▶ Accelerate only slightly and avoid jolting.

**i** For rapid maneuvering (e.g. to rock the vehicle out of snow or slush), you can shift back and forth between drive position **D** and reverse gear **R** at low speeds without applying the brakes.

#### Towing a trailer

- ▶ Run the engine in the moderate engine speed range on steep uphill gradients.
- ▶ Depending on the uphill or downhill gradient, shift down to shift range **3** or **2** (> page 115), even if cruise control is switched on.

#### Working on the vehicle

##### Warning

Apply the parking brake and move the selector lever to **P** when working on the

vehicle. Otherwise, the vehicle could roll away.

## Driving the vehicle

### Exhaust gas aftertreatment

The exhaust gas aftertreatment requires a reducing agent, Diesel Exhaust Fluid (DEF), in order to function correctly. Filling up the DEF tank is usually part of the service scope. DEF consumption depends on operational and driving conditions; the supply does not have to suffice until the next scheduled service. For this reason, refill the DEF tank regularly during vehicle operation, or, at the latest, after the first warning message has been received from the on-board computer.

To conform with emission regulations, you must operate the vehicle with DEF and refill the supply regularly. If you try to operate the vehicle without DEF, with diluted DEF, or with a different reduction agent, the engine management detects this and issues a warning message, after which the engine cannot be restarted.

If the DEF supply drops below 1.5 US gal (5.5 l), you receive the first warning message and you hear a warning tone. After the first message appears, the remaining DEF supply suffices for approximately 1000 miles (1600 km) in normal driving conditions.

Then, the reserve range of 0.8 US gal (3.0 l) is reached. Once the reserve range has been reached, you receive the next warning message and you hear a series of warning tones. After the first message appears, the DEF reserve suffices for approximately 1200 miles (1900 km). You can, however, only start the engine another 16 times.

You should now, at the latest, fill up with at least 2.0 US gal (7.6 l) of DEF (▷ page 143) or have the DEF tank filled at a qualified specialist workshop.

When the number of remaining engine starts is 0, the engine management prevents the engine from being started.

If the  check engine indicator lamp lights up, the exhaust gas aftertreatment is faulty or an emission-relevant malfunction has occurred (▷ page 195). You can then drive a maximum of 50 miles (80 km) before the engine management limits the number of remaining engine starts.



If the exhaust gas aftertreatment is faulty, have it checked and repaired at a qualified specialist workshop. We recommend that you use an authorized Sprinter Dealer for this purpose.



You will find further information on DEF in the "Service products" section (▷ page 155).

### Level indicator

You will find further information about DEF consumption in the "Driving tips" section (▷ page 140).

### Vehicles without steering wheel buttons

If the DEF supply is less than 1.5 US gal (5.5 l), the  indicator lamp in the instrument cluster lights up and the  DEF Chk message appears in the display.

If the DEF supply drops below the reserve level of 0.8 US gal (3.0 l), the  indicator lamp in the instrument cluster lights up and the  StArtS RE xx message is shown in the display. xx refers to the number of remaining engine starts (from 16 to 0).

### Vehicles with steering wheel buttons

If the DEF supply is less than 1.5 US gal (5.5 l), the **Check Diesel Exhaust Fluid See Operator's Manual** message appears in the display.

If the DEF supply drops below the reserve level of 0.8 US gal (3.0 l), the  xx starts remaining message appears in the display. xx refers to the number of remaining engine starts (from 16 to 0).

## ADR (working speed governor)

When activated, the working speed governor (ADR) automatically increases the engine speed to a preset or adjustable speed (▷ page 117).



- i** After a cold start, the idling speed of the engine is increased automatically. If the preset working speed is lower than the increased idling speed, the working speed is only reached once the engine has completed the warm-up phase.

It is only possible to activate ADR with the vehicle stationary and the parking brake applied.

The selector lever must be in position **P**.

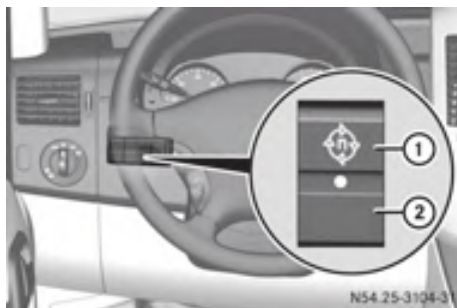
## Activating/deactivating ADR





- ▶ **To activate:** press upper section ① of the  switch while the engine is running. The indicator lamp in the switch comes on. Vehicles without steering wheel buttons: The **ADR** indicator lamp in the instrument cluster lights up. Vehicles with steering wheel buttons: The **Operating speed governor active** message appears in the display.
- ▶ **To deactivate:** press lower section ② of the  switch while the engine is running. The indicator lamp in the switch goes out.

- i** ADR is automatically deactivated when:
- you release the parking brake.
  - the brake pedal is depressed.
  - the vehicle moves.
  - the control unit detects a malfunction.

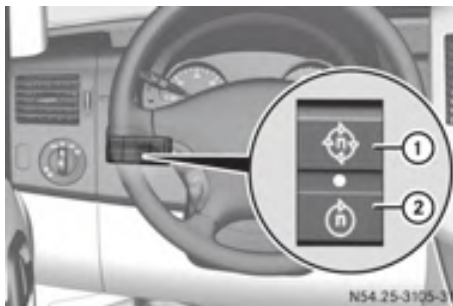
## Setting the working speed



- ▶ Activate ADR (▷ page 117).
- ▶ **To increase:** press upper section ① of the  switch.
- ▶ **To decrease:** press lower section ② of the  switch.
- i** On vehicles with cruise control, you can use the cruise control lever to increase or decrease the engine speed in the same way as for the road speed. Set the speed using the cruise control lever (▷ page 119).

- i** After a cold start, the idling speed of the engine is increased automatically. You can only reduce the working speed to the level of the current idling speed.

## Driving systems

### Overview

The following pages describe driving systems that may be a component in your vehicle:

- Cruise control (▷ page 118) which you can use to control the speed of your vehicle
- PARKTRONIC (▷ page 119) and the rear view camera (▷ page 122) which assist you with parking and maneuvering

## Cruise control

### General notes

Cruise control maintains the speed of the vehicle for you.

Use cruise control if road and traffic conditions make it appropriate to maintain a steady speed for a prolonged period. You can set any speed from 20 mph upwards in increments of 1 mph.

- ❶ If you have set km/h as the unit for the digital speedometer, you can set any speed from 30 km/h upwards in increments of 1 km/h.

### Warning

Cruise control is unable to take account of road and traffic conditions.

Always pay attention to the traffic conditions, even when cruise control is activated.

Cruise control is only an aid designed to assist driving. You are always responsible for the vehicle's speed and for braking in good time.

If there is a change of drivers, make sure that you inform the new driver about the set cruise speed. Otherwise, sudden acceleration or braking could endanger you or others.

### Warning

Do not use cruise control:

- in road and traffic conditions which do not allow you to maintain a constant speed (e.g. heavy traffic or winding roads). You could otherwise cause an accident.
- on slippery roads. Braking or accelerating could cause the drive wheels to lose traction and the vehicle could then skid.
- when there is poor visibility, e.g. due to fog, heavy rain or snow

- ❶ Cruise control may not be able to maintain the stored speed on uphill or downhill gradients. The stored speed is resumed if the gradient evens out and the vehicle's speed does not fall below 20 mph (30 km/h).

## Cruise control lever

The cruise control lever is the uppermost lever on the left of the steering column.

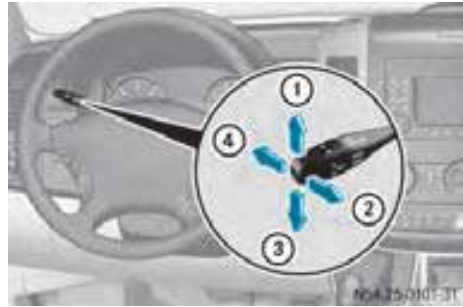

- ❶ To store the current speed or a higher speed
- ❷ To resume the last speed stored
- ❸ To store the current speed or a lower speed
- ❹ To deactivate cruise control

## Storing the current speed

- ▶ Accelerate/decelerate the vehicle to the speed desired above 20 mph (30 km/h).
- ▶ Briefly push the cruise control lever up ❶ or down ❸.
- ▶ Release the accelerator pedal. Cruise control is activated. The current speed is stored.

You cannot activate cruise control if:

- you are driving slower than 20 mph (30 km/h).
- you depress the brake pedal.
- you apply the parking brake and the  indicator lamp in the instrument cluster lights up.

- ❶ Other drive and brake systems not described in this Operator's Manual, such as a retarder, may affect cruise control. You can find information on this in the separate operating instructions provided by the body manufacturer.



## Resuming the stored speed

### Warning

Only select a stored speed if you know what that speed is and whether it is suitable for the current driving and traffic situation. You can otherwise endanger yourself and others by unintentionally triggering sudden acceleration or braking.

- ▶ Briefly pull the cruise control lever in the direction of arrow ②.
  - ▶ Release the accelerator pedal.  
Cruise control is activated and resumes the vehicle's speed to the last speed stored.
- i** When you first move the cruise control lever in the direction of arrow ② after starting the engine, cruise control is activated and the current road speed is stored.

## Setting the speed

### Warning

The rate at which you increase the speed in increments of 1 mph (1 km/h) may be faster than your vehicle is able to accelerate. Your vehicle may then continue to accelerate up to the newly set speed even after you have released the cruise control lever.

Only increase the speed as the prevailing conditions permit. Sudden acceleration could otherwise endanger you and others.

- ▶ Briefly push the cruise control lever upwards ① to increase the speed or downwards ③ to reduce the speed.  
The last speed stored is increased/reduced in increments of 1 mph (1 km/h).
- or
- ▶ Press and hold the cruise control lever up ① or down ③ until the desired speed has been reached.
  - ▶ Release the cruise control lever.  
The current speed is stored.

- i** Cruise control is not deactivated if you depress the accelerator pedal. If you accelerate briefly, e.g. to overtake, and then ease off the accelerator pedal again, cruise control adjusts the vehicle's speed to the last speed stored.

## Deactivating cruise control

There are various ways to deactivate cruise control:

- ▶ Briefly push the cruise control lever forwards ④.

or

- ▶ Apply the brakes.

The last speed set remains stored.

- i** The last speed set is deleted when you switch off the engine.
- i** Cruise control is deactivated automatically when:
- you apply the brakes.
  - you apply the parking brake and the  indicator lamp in the instrument cluster lights up.
  - you are driving slower than 20 mph (30 km/h).
  - ESP® or ASR intervenes.
  - you shift the automatic transmission to neutral position **N** while the vehicle is in motion.
  - there is a malfunction in the ESP®, ASR or ABS system.

## PARKTRONIC

### General notes

#### Warning

PARKTRONIC is only an aid and may not detect all obstacles. It is not a substitute for attentive driving.

You are always responsible for safety and must continue to pay attention to your

immediate surroundings when parking and maneuvering. You could otherwise endanger yourself and others.

### Warning

Make sure that no persons or animals are in the maneuvering range. Otherwise, they could be injured.

PARKTRONIC is an electronic parking aid. PARKTRONIC indicates visually and audibly the distance between your vehicle and an object.

Your vehicle features two sound emitters with different frequencies for the warning tones. The warning ranges in front of and behind the vehicle are indicated by different warning tones.

PARKTRONIC is automatically activated when the key is turned to position **2** in the ignition lock, the parking brake is released and the selector lever is moved to position **D**, **N** or **R**. PARKTRONIC is deactivated automatically at speeds above 11 mph (18 km/h). PARKTRONIC is reactivated automatically at speeds below 10 mph (16 km/h).

PARKTRONIC monitors the area around your vehicle with sensors in the front and rear bumpers.

### Range of the sensors

The sensors must be free of dirt, ice and slush; otherwise, they may not function correctly. Clean the sensors regularly, taking care not to scratch or damage them (> page 163).

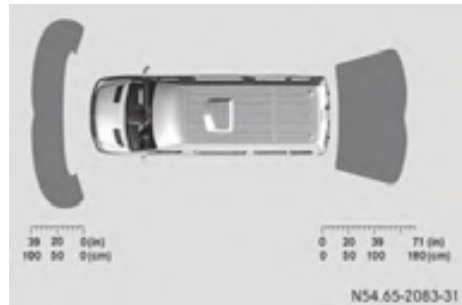
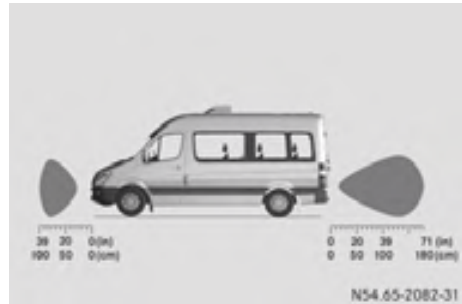

### Front sensors

Center	Approximately 39 in (100 cm)
Corners	Approximately 26 in (65 cm)

### Rear sensors

Center	Approximately 71 in (180 cm)
Corners	Approximately 39 in (100 cm)

### Minimum distance

Center	Approximately 12 in (30 cm)
Front corner sensors	Approximately 10 in (25 cm)
Rear corner sensors	Approximately 12 in (30 cm)

If an obstacle is within this range, all segments of the warning displays light up and you hear a warning tone. If the distance between the vehicle and the obstacle falls below the minimum range, it is possible that the distance may no longer be displayed.

**!** Pay particular attention to obstacles above or below the sensors when parking, such as flower pots or trailer towbars. PARKTRONIC does not recognize such objects when they are in the immediate vicinity of the vehicle. You could damage the vehicle or objects.

PARKTRONIC can suffer interference from:

- ultrasonic sources such as a lorry's compressed-air brakes, an automatic car wash or a pneumatic drill
- attachments to the vehicle, e.g. rear mounted racks
- number plates (vehicle license plates) that are not affixed flat against the bumper
- dirty or icy sensors

## Warning displays

The warning displays show the distance between the sensor and the obstacle.

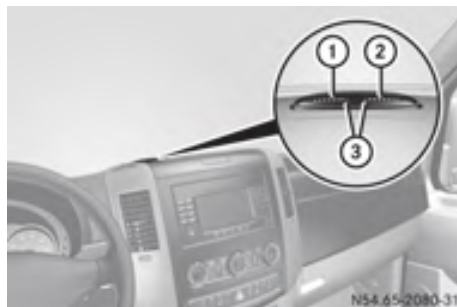

Warning display, front area

- ① Left-hand side of vehicle
- ② Right-hand side of vehicle
- ③ Segments

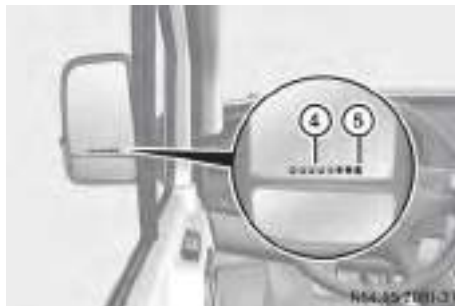

Warning display for the left-hand rear area in the left-hand exterior mirror

- ④ Warning display segments
- ⑤ Readiness indicator segment

The warning display is divided into five yellow and two red segments for each side of the vehicle. PARKTRONIC is operational if yellow indicator segments ③ and ⑤ light up.

There is a malfunction if only the red segments of the warning display light up (▷ page 215).

The position of the selector lever determines whether the front and/or rear area is monitored.

Selector lever position	Monitoring
D	Front area
R or N	Front and rear area
P	No areas activated

One or more segments light up as the vehicle approaches an obstacle, depending on the vehicle's distance from the obstacle.

From the:

- sixth segment, an intermittent warning tone sounds for approximately two seconds.
- seventh segment, a continuous warning tone sounds. You have reached the minimum distance.

## Roll-back warning

PARKTRONIC automatically monitors the area behind the vehicle if the vehicle begins to roll backwards without reverse gear engaged, e.g. after stopping on an uphill gradient.

If PARKTRONIC recognizes an obstacle at a distance of at most 31 in (80 cm), all the segments in the warning display light up. A continuous warning tone also sounds as the vehicle approaches the obstacle and for a further two seconds after the vehicle has come to a halt.

## Activating/deactivating PARKTRONIC

You can activate/deactivate PARKTRONIC manually.

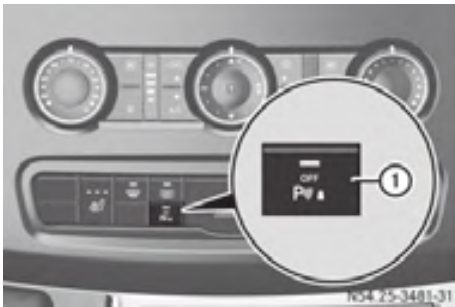

- ▶ Press button ①.  
If PARKTRONIC is deactivated, the indicator lamp in the switch lights up.

## Towing a trailer

If your vehicle is equipped with the electric wiring required for towing a trailer and you attach a trailer, PARKTRONIC is deactivated for the rear area as soon as you have established an electrical connection between your vehicle and the trailer. If you use an adapter for the socket, remove it from the socket after detaching the trailer. Otherwise, PARKTRONIC remains deactivated for the rear area.

If the trailer coupling is detachable, remove it when it is no longer required. PARKTRONIC

measures the minimum detection range to an obstacle from the bumper, not the ball coupling.

## Rear view camera

The rear view camera is a visual parking aid. It shows you the area behind the vehicle on a separate monitor on the center console.

The rear view camera is activated when you engage reverse gear.

The camera is in the middle of the roof above the high-mounted brake lamp (▷ page 163).



- ① Monitor for rear view camera

## ⚠ Warning

The rear-view camera is only a driving aid and may display obstacles as foreshortened, incorrectly or not at all. It cannot replace your attentiveness.

The rear-view camera cannot display all objects located very near and/or under the rear bumper. It does not warn you of a collision, persons or objects.

You are responsible for safety at all times and must continue to pay attention to your immediate surroundings during parking and maneuvering. This applies not only to the area behind, but also to the area in front of and beside your vehicle.

You may otherwise not recognize people or objects, if any, and by driving onwards, injure people or damage objects and the vehicle. We recommend also using PARKTRONIC at all times during parking.

**Warning**

Make sure that no persons or animals are in the maneuvering range. Otherwise, they could be injured.

**Warning!**

The rear-view camera could either stop functioning or function incorrectly if:

- it is raining very heavily or snowing, or it is foggy.
- the parking space is located in a very dark place.
- the camera is exposed to very strong white light. White stripes may appear on the display.
- the surrounding area is illuminated with fluorescent light. The display may flicker.
- there is a rapid change in temperature, e.g. if you drive out of the cold during winter into a heated garage.
- ambient temperatures are very high.
- the camera lens is dirty or obstructed.
- the rear of the vehicle is damaged. In this case, have the position and setting checked at a qualified specialist workshop that has the necessary specialist knowledge and tools to carry out the work required. For this reason, we recommend an authorized Sprinter Dealer.

You will find information about cleaning the camera in the "Operation" section (> page 163).

**Switching on the rear view camera**

- ▶ Make sure that the ignition is switched on.
- ▶ Engage reverse gear.  
The rear view camera is switched on.

**Using the monitor**

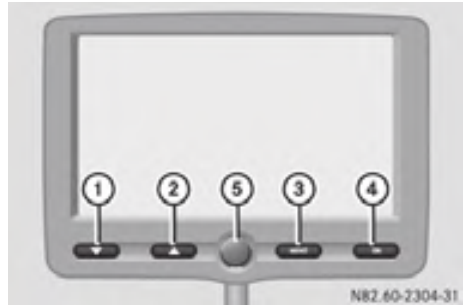

Monitor buttons

- ① Down button
- ② Up button
- ③ MENU Menu/Confirm button
- ④ ON Monitor on/off switch
- ⑤ Speaker cover

**Switching on the monitor**

You can switch on the monitor by:

- engaging reverse gear  
The rear view camera is activated. This then switches the monitor on.
  - pressing the button  
The input for auxiliary equipment (AUX) on the monitor is activated.
- i** If you have switched the monitor off using the button, you must press the button after engaging reverse gear. Only then is the monitor switched on.



Input for auxiliary equipment (AUX)

If you engage reverse gear while using auxiliary equipment, the monitor switches to the rear view camera.

When you disengage reverse gear, the monitor continues to show the picture from

the rear view camera for around 15 seconds before switching back to the auxiliary device input (AUX).

### Switching off the monitor

If the monitor was switched on by engaging reverse gear, it switches off automatically 15 seconds after you disengage reverse gear. You can switch off the monitor by pressing the **ON** button. In this case, the following message is shown for seven seconds before it switches off.



## Menu system

### Setting the volume

- ▶ Press the **▼** or **▲** button. The volume of the integrated loudspeaker is adjusted in increments.
- i** The volume of the optional infrared headphones is adjusted on the headphones themselves.
- ▶ Press the **MENU** button to exit the volume adjustment.
- i** If you do not press a button for seven seconds, the monitor switches off the volume adjustment.

### Selecting the main menu

- ▶ Press the **MENU** button. The menu selection for the main menu (menu level 1) is displayed.

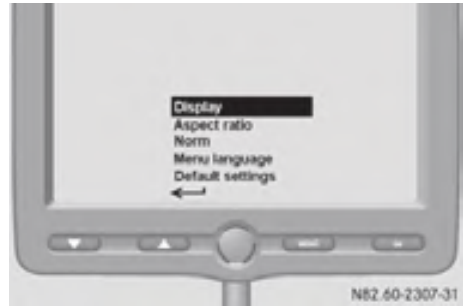

- ▶ Press the **▼** or **▲** button until the menu you want is highlighted.
- ▶ Press the **MENU** button. The menu is selected.

You can select the following menus:

- Display (▷ page 125)
- Picture format (▷ page 126)
- Standard (▷ page 127)
- Menu language (▷ page 127)
- Factory setting (▷ page 128)
- Back **◀** (▷ page 124)

### Skipping back a menu



- ▶ Press the **▼** or **▲** button until the **◀** symbol is highlighted.
- ▶ Press the **MENU** button. The higher-level menu is displayed.

## Display menu



You can customize the monitor display in the **Display** menu.

You can select the following submenus:



- ▶ Lighting (▷ page 125)
- ▶ Brightness (▷ page 125)
- ▶ Contrast (▷ page 125)
- ▶ Color (▷ page 126)
- ▶ Tint
- ▶ Back  (▷ page 124)

## Lighting submenu



You can adjust the background illumination of the monitor in the **Lighting** submenu.

- ▶ Press the **MENU** button.  
The main menu (menu level 1) is displayed (▷ page 124).
- ▶ Press the  or  button until the **Display** menu is highlighted.  
The **Display** menu is selected.
- ▶ Press the **MENU** button.  
The submenu (menu level 2) are displayed.

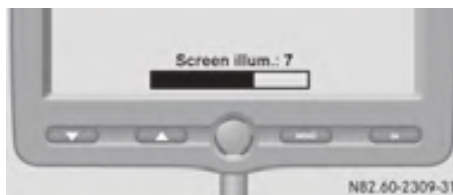

- ▶ Press the  or  button until the **Lighting** submenu is highlighted.
- ▶ Press the **MENU** button.  
The lighting setting is displayed.









- ▶ Press the  or  button.  
The background lighting is adjusted in increments.
- ▶ Press the **MENU** button.  
The submenu (menu level 2) are displayed.

**i** If you do not press a button for seven seconds, the menu is automatically closed.

## Brightness submenu

You can adjust the brightness of the monitor in the **Brightness** submenu.

- ▶ Press the **MENU** button.  
The main menu (menu level 1) is displayed (▷ page 124).
- ▶ Press the  or  button until the **Display** menu is highlighted.  
The **Display** menu is selected.
- ▶ Press the **MENU** button.  
The submenu (menu level 2) are displayed.
- ▶ Press the  or  button until the **Brightness** submenu is highlighted.
- ▶ Press the **MENU** button.  
The brightness setting is displayed.
- ▶ Press the  or  button.  
The brightness is adjusted in increments.
- ▶ Press the **MENU** button.  
The submenu (menu level 2) are displayed.

## Contrast submenu

You can adjust the picture contrast of the monitor in the **Contrast** submenu.

- ▶ Press the **MENU** button.  
The main menu (menu level 1) is displayed (▷ page 124).
- ▶ Press the **▼** or **▲** button until the **Display** menu is highlighted.  
The **Display** menu is selected.
- ▶ Press the **MENU** button.  
The submenus (menu level 2) are displayed.
- ▶ Press the **▼** or **▲** button until the **Contrast** submenu is highlighted.
- ▶ Press the **MENU** button.  
The contrast setting is displayed.
- ▶ Press the **▼** or **▲** button.  
The contrast is adjusted in increments.
- ▶ Press the **MENU** button.  
The submenus (menu level 2) are displayed.

### Color submenu

You can adjust the color setting of the monitor in the **Color** submenu.

- ▶ Press the **MENU** button.  
The main menu (menu level 1) is displayed (▷ page 124).
- ▶ Press the **▼** or **▲** button until the **Display** menu is highlighted.  
The **Display** menu is selected.
- ▶ Press the **MENU** button.  
The submenus (menu level 2) are displayed.
- ▶ Press the **▼** or **▲** button until the **Color** submenu is highlighted.
- ▶ Press the **MENU** button.  
The color setting is displayed.
- ▶ Press the **▼** or **▲** button.  
The contrast is adjusted in increments.
- ▶ Press the **MENU** button.  
The submenus (menu level 2) are displayed.

### Tint submenu (NTSC color balance)

In the NTSC standard you can adjust the color balance of the monitor in the **TINT** submenu.

- ▶ Press the **MENU** button.  
The main menu (menu level 1) is displayed (▷ page 124).
- ▶ Press the **▼** or **▲** button until the **Display** menu is highlighted.  
The **Display** menu is selected.
- ▶ Press the **MENU** button.  
The submenus (menu level 2) are displayed.
- ▶ Press the **▼** or **▲** button until the **TINT** submenu is highlighted.
- ▶ Press the **MENU** button.  
The color balance setting is displayed.
- ▶ Press the **▼** or **▲** button.  
The color balance is adjusted in increments.
- ▶ Press the **MENU** button.  
The submenus (menu level 2) are displayed.

### Picture format menu

You can set the display format for the monitor in the **Picture format** menu.

- ▶ Press the **MENU** button.  
The main menu (menu level 1) is displayed (▷ page 124).
- ▶ Press the **▼** or **▲** button until the **Picture format** menu is highlighted.
- ▶ Press the **MENU** button.  
The submenu (menu level 2) is displayed.
- i** The current picture format is marked with the ▶ symbol.





- ▶ Press the or button until the format you want is highlighted.
  - ▶ Press the button.  
Your selected format is activated.
- i** The 16:9 format fills the entire monitor screen. The rear view camera generates a 16:9 format. Regular video signals usually require the 4:3 format.
- i** If you select and press the button, the monitor goes back to the main menu (menu level 1).

### Standard menu

You can set the video standard for the monitor in the **Standard** menu.

- ▶ Press the button.  
The main menu (menu level 1) is displayed (▷ page 124).
  - ▶ Press the or button until the **Standard** menu is highlighted.
  - ▶ Press the button.  
The submenu (menu level 2) is displayed.
- i** The current standard is marked with the ▶ symbol.



- ▶ Press the or button until the required standard is highlighted.
  - ▶ Press the button.  
The selected standard is activated.
- i** The video signal from the rear view camera uses the NTSC standard. Normal video signals generally use the PAL standard.
- i** If you select and press the button, the monitor goes back to the main menu (menu level 1).

### Menu language menu

You can set the language for the monitor menus in the **Menu language** menu.

- ▶ Press the button.  
The main menu (menu level 1) is displayed (▷ page 124).
  - ▶ Press the or button until the **Menu language** menu is highlighted.
  - ▶ Press the button.  
The submenu (menu level 2) is displayed.
- i** The current language is marked with the ▶ symbol.
- ▶ Press the or button until the language you want is highlighted.
  - ▶ Press the button.  
The selected language is activated.
- i** If you select and press the button, the monitor goes back to the main menu (menu level 1).

### Factory setting menu

You can reset the monitor to the factory settings in the **Factory setting** menu.

- ▶ Press the **MENU** button.  
The main menu (menu level 1) is displayed (▷ page 124).
- ▶ Press the **▼** or **▲** button until the **Factory setting** menu is highlighted.
- ▶ Press the **MENU** button.  
The monitor displays the following message:



- ▶ Press the **▼** or **▲** button until the required setting is highlighted.
  - **Yes**: all settings are overwritten with the factory settings.
  - **←**: return to the main menu without accepting the factory settings.
- i** If you select **←** and press the **MENU** button, the monitor goes back to the main menu (menu level 1).

### Switching off the monitor while driving

If you drive faster than 6 mph (10 km/h), the monitor switches off for safety reasons.

You will see the following message for seven seconds until the monitor switches off.



If the speed falls below 5 mph (8 km/h), the monitor switches on again.

## Features

### Ashtray

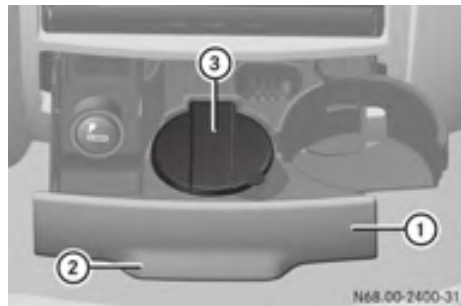

Ashtray insert in the ashtray compartment in the center console

- ▶ Pull ashtray compartment **①** out by recess **②**.
- ▶ **To open**: fold cover **③** upwards.
- ▶ **To remove the insert**: hold the ashtray by the recesses on the left and right and pull the insert out to empty it.
- ▶ **To replace the insert**: press it down into the holder.

## Ashtrays in the passenger compartment



Ashtrays on the left and right in the side trim panels

- ▶ **To open:** fold out the ashtray.
- ▶ **To remove the insert:** press retaining clip ① down and remove the ashtray from the trim.
- ▶ **To replace the insert:** insert the ashtray down into the trim and close it.

## Cigarette lighter

### Warning

Only hold the hot cigarette lighter by its knob. Otherwise, you might burn yourself. Make sure that children traveling in the vehicle are not able to injure themselves on the hot cigarette lighter or cause a fire with it.

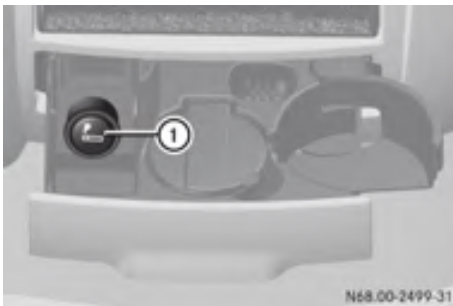

Ashtray compartment in the center console

- ▶ Turn the key to position **1** in the ignition lock.
- ▶ Press in cigarette lighter ①. The cigarette lighter will pop out automatically when the heating element is red-hot.

### Warning

Do not press the cigarette lighter in too forcefully. The ashtray compartment could close and your fingers could become trapped.

## Stowage spaces and stowage compartments

### Warning

You should only load the stowage spaces in such a way that the occupants cannot be injured by objects being thrown around the passenger compartment in the event of an accident, braking or sudden change in direction.

Therefore, do not carry heavy, bulky, pointed or sharp-edged objects in the stowage spaces or stowage compartments.

## Dashboard stowage compartment



Example, right-hand side

### Warning

Do not store objects in the stowage space above the co-driver's air bag if they protrude out of the stowage space. This ensures that the co-driver's air bag can inflate fully.

**!** The right and left storage spaces may be loaded with a maximum of 11 lbs (5 kg) each.

### Stowage compartment above the windshield

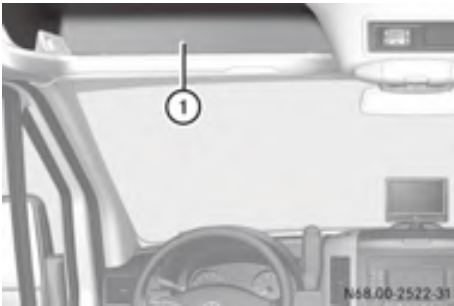

Example, left-hand side

① Stowage compartment

**!** The right and left storage spaces may be loaded with a maximum of 5.5 lbs (2.5 kg) each.

### Stowage space above the headliner



On vehicles with a partition, stowage space ① can be loaded from the cargo compartment.

**!** The entire storage space may be loaded with a maximum of 66 lbs (30 kg).

Do not place high, bulky loads in the stowage space. You could otherwise damage the headliner in the event of sharp braking.

### Stowage compartment in the center console



Stowage compartment with lid above the center console

► **To open:** pull release handle ②.

Lid ① swings up.

► **To close:** close lid ① and engage it.

The lid of the stowage compartment must remain closed while the vehicle is in motion to ensure that stowed objects are contained safely.

### Stowage compartment in the door

You can use these stowage compartments to store small, light items.

### Stowage compartment under the twin co-driver's seat

On vehicles with a twin co-driver's seat, the stowage compartment is under the seat cushion (▷ page 65).

You can use the stowage compartment to safely store tools and other small parts.

## Glove box

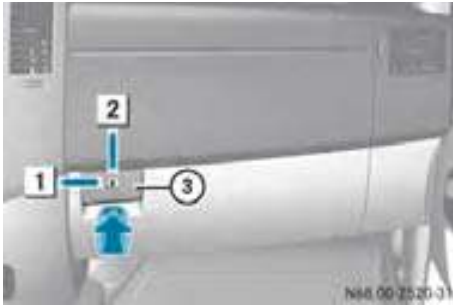

- ① Locked
- ② Unlocked
- ③ Glove box handle

- ① You can lock and unlock the glove box using the vehicle key.
- ▶ **To open:** pull glove box handle ③ in the direction of the arrow.

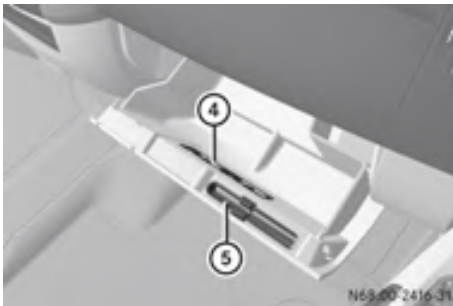

- ④ Card holder
- ⑤ Pen holder

- ▶ **To close:** fold the cover up and press it until it engages.

## Eyeglasses compartment in the overhead control panel



- ▶ **To open:** press cover ① of the eyeglasses compartment. The eyeglasses compartment folds out.
- ▶ **To close:** press cover ① of the eyeglasses compartment into the overhead control panel until it engages.

## Paper holder



- ▶ Press the top of paper holder ①.

### Folding table



- ▶ Pull folding table ① forwards by the tab.
- ▶ Fold folding table ① down in the direction of the arrow and onto the seat cushion.
- ❗ The folding table is equipped with a pen holder and cup holders.

### Cup holder

- ❗ Do not use the cup holder recesses as ashtrays. You could otherwise damage the cup holders.

### Cup holders in the front

#### ⚠ Warning

Do not leave loose objects in the cup holder while the vehicle is in motion. Otherwise, the loose objects could injure you or other passengers in the event of:

- an accident
- braking
- a sudden change of direction

Only use drinks containers that can be sealed and that are of the correct size. The drinks could otherwise spill.

Cup holders should not be used for hot drinks. Otherwise, you may scald yourself.



Cup holder (example: right-hand side of vehicle)

- ① Cup holder in the dashboard stowage compartment



Cup holder (example: right-hand side of vehicle)

- ② Bottle holder in the front door

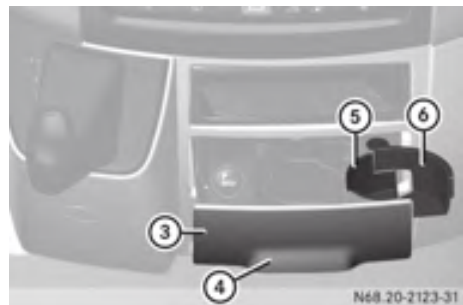

Cup holder in the center console

- ▶ Pull cup holder compartment ③ out by recess ④.
- Cup holder ⑤ opens fully.

- ❗ You can adjust the diameter of the cup holder.

- ▶ Place the beverage container in cup holder ⑤.
- ▶ Push clamping arm ⑥ against the container.

### Cup holders in the rear



- ▶ Pull out cup holder ①.

#### **Warning**

Slide the cup holders back under the seats before leaving the vehicle. You and others could otherwise injure yourselves on the protruding cup holders.

### Socket

The 12 V sockets for accessories are

- at the bottom of the center console (12 V, 25 A)
- on the inside of the driver's seat frame (12 V, 15 A)
- in the corner lining next to the rear doors in the passenger compartment (12 V, 15 A)
- in the cargo compartment next to the left rear door (12 V, 15 A)



Socket on the lower section of the center console

- ① 12 V socket, 25 A

You can use the 12 V sockets (15 A) for accessories with a maximum power consumption of 180 W. You can connect accessories with a maximum power consumption of 300 W to the 12 V socket (25 A) on the lower section of the center console.

**!** Only use the 12 V socket (25 A) on the center console for connecting the electric air pump (premium tire sealant). You may otherwise damage the electrical systems of the vehicle.

**i** The sockets are supplied with power even when the key is removed from the ignition lock. Please be aware that the battery may become discharged if accessories, e.g. a coolbox, remain connected while the engine is not running.

### Communications

#### Electronic communications equipment

#### **Warning**

Always pay attention to road and traffic conditions.

Only operate electronic equipment when road and traffic conditions permit. Bear in mind that at a speed of only 30 mph (approximately 50 km/h), your vehicle covers about 44 ft (approximately 14 m) every second.

A navigation system does not supply information on the load-bearing capacity of bridges or the overhead clearance of underpasses.

The driver remains responsible for the safety of the vehicle at all times.

Observe legal requirements.

Telephones, two-way radios and fax machines without an exterior antenna could interfere with the vehicle electronics and thus compromise the operational safety of the vehicle. There is an increased risk of accident.

Do not use this equipment while the vehicle is in motion.

Failure to observe the Sprinter installation specifications can result in the invalidation of your vehicle's operating permit.

You will find information on retrofitting electrical or electronic equipment in the "Technical data" section (▷ page 277).

### Telephone

#### Warning

A driver's attention to the road must always be his/her primary focus when driving. For your safety and the safety of others, we recommend that you pull over to a safe location and stop before placing or taking a telephone call. If you choose to use the telephone while driving, please use the hands-free device and only use the telephone when weather, road and traffic conditions permit.

Some jurisdictions prohibit the driver from using a mobile phone while driving a vehicle.

Bear in mind that at a speed of just 30 mph (approximately 50 km/h), your vehicle is covering a distance of 44 feet (approximately 14 m) every second.

#### Warning

Excessive electromagnetic radiation may constitute a health hazard to yourself and others. Use of an exterior antenna gives

consideration to scientific discussion surrounding the possible health risk posed by electromagnetic fields.

The exterior antenna should only be installed at a qualified specialist workshop which has the necessary specialist knowledge and tools to carry out the work required. We recommend that you use an authorized Sprinter Dealer for this purpose. In particular, work relevant to safety or on safety-related systems must be carried out at a qualified specialist workshop.

We recommend the use of an approved exterior antenna for operating the mobile phone. Only in this way can optimal mobile phone reception quality in the vehicle be ensured and mutual interference between the vehicle electronics and mobile phones minimized.

Observe the legal requirements for each individual country.

The mobile phone fitting includes a hands-free system integrated into the vehicle. The microphone for the hands-free system is installed in the overhead control panel or in the overhead stowage compartment together with the front interior light.

In order to use the hands-free system, you will need a special bracket. The Sprinter range of accessories includes brackets for various mobile phone models.

-  Mobile phone brackets which are available from various manufacturers on the open market are not compatible with the Sprinter telephone system. You can recognize suitable phone brackets for your mobile, by the printed star and the B6 in the part number on the rear of the phone bracket.

Detailed instructions for use can be found in the operating instructions for the mobile phone bracket and in the separate operating instructions for the mobile phone fittings.

-  The mobile phone battery is charged depending on the condition of charge



status and the position of the key in the ignition lock. The mobile phone display indicates the charging status.



<b>Vehicle equipment .....</b>	<b>138</b>
<b>Driving tips .....</b>	<b>138</b>
<b>Refueling .....</b>	<b>142</b>
<b>Transporting loads with the vehicle</b>	<b>144</b>
<b>Operation in winter .....</b>	<b>153</b>
<b>Service products .....</b>	<b>153</b>
<b>Cleaning and care .....</b>	<b>161</b>
<b>Maintenance .....</b>	<b>166</b>

## Vehicle equipment

- i** Diese Betriebsanleitung beschreibt alle Modelle, Serien- und Sonderausstattungen Ihres Fahrzeugs, die zum Zeitpunkt des Redaktionsschlusses dieser Betriebsanleitung erhältlich waren. Länderspezifische Abweichungen sind möglich. Beachten Sie, dass Ihr Fahrzeug nicht mit allen beschriebenen Funktionen ausgestattet sein könnte. Dies betrifft auch sicherheitsrelevante Systeme und Funktionen.

## Driving tips

### Breaking-in

It is of decisive importance for the operating life, reliability and economy of the vehicle that the engine is not subjected to its full rated load during the breaking-in period.

#### Up to 1000 miles (1500 km)

- Run the vehicle in carefully. Drive at varying road and engine speeds.
- Avoid heavy loads (driving at full throttle) and high engine speeds. Do not exceed  $\frac{3}{4}$  of the maximum speed for each gear.
- Do not change down a gear manually in order to brake.
- Avoid depressing the accelerator pedal beyond the pressure point (kickdown) and only engage gear **4**, **3**, **2** or **1** while driving slowly.

#### After 1000 miles (1500 km)

- Gradually bring the vehicle up to full road and engine speeds.
- i** These instructions must also be observed if you have the engine, the transmission, or the rear axle differential of your vehicle replaced.

## Driving abroad

An extensive network of authorized Sprinter Dealers is also at your disposal when you are traveling abroad. The respective workshop directories are available from any authorized Sprinter Dealer.

In some countries, only fuels with a lower octane rating or a higher sulfur content are available.

You will find information about fuel in the "Service products" section (▷ page 153).

If you are traveling in countries where vehicles are driven on the opposite side of the road to that in which the vehicle is registered, you must have the headlamps:

- partially masked (halogen headlamps)
- switched over (Bi-Xenon headlamps)

### Warning

Masking the headlamps incorrectly can impair your visibility when driving with the headlamps switched on. You could also impede other road users. Oncoming traffic may be dazzled.

Always have the headlamps masked/switched over at a qualified specialist workshop which has the necessary specialist knowledge and tools to carry out the work required.

For this we recommend an authorized Sprinter Dealer. All work relevant to safety or on safety-related systems must be carried out at a qualified specialist workshop.

## Driving off-road

When driving the vehicle, particularly on rough terrain, ensure that the driven wheels always have sufficient traction.

Avoid letting the drive wheels spin. Spinning drive wheels can damage the differential.

- !** Always observe the ground clearance of the vehicle and avoid obstacles, e.g. deep ruts.

Obstacles could damage the vehicle, for example:

- the axles
- the propeller shafts and the transmission
- the tanks and supply reservoirs

For this reason, you should always drive slowly when driving off-road. If you have to drive over obstacles, have the co-driver direct you.

#### Warning

If you drive too fast off-road, you may not recognize obstacles in good time or you may underestimate the roughness of the ground. When driving off-road, always drive slowly to avoid damaging the vehicle.

The vehicle may slip to the side, tip and roll over. Always drive along the line of fall when you are on a slope. Never drive across a slope. Never turn the vehicle around on a slope. If the vehicle cannot manage an uphill slope, drive back down the slope in reverse gear.

You could lose control of the vehicle if you shift the transmission to neutral or disengage the clutch on an incline and then try to brake the vehicle using only the service brake. Never let the vehicle roll.

Overloading the vehicle will increase the risk of the vehicle tipping over. Never exceed the maximum permissible axle loads under any circumstances. Keep the vehicle's center of gravity as low as possible when the vehicle is laden.

If the vehicle is frequently or mainly operated in muddy or marshy terrain, substances that impair braking efficiency, such as sand or oil mixed with water, could get into the brake system. This may lead to excessive wear and a reduction in braking efficiency. In an emergency, there is a risk that full braking power may no longer be available.

After driving off-road, always carry out a short brake test. If you detect a reduced braking effect or hear grinding noises, have the brake system checked at a qualified specialist

workshop, for example at an authorized Sprinter Dealer.

#### Warning

When driving off-road, your body is subject to forces from all directions, due to the uneven surface. There is a danger that you could be thrown out of your seat and be injured. Always wear a seat belt, even when driving off-road.

### Rules for driving off-road

#### Warning

If you drive over obstacles or in ruts, the steering wheel may jerk out of your grip and you could injure the thumbs on both hands. Always hold the steering wheel cross firmly with both hands. When driving over obstacles, you must expect steering forces to increase briefly and suddenly.

- Before driving off-road, stop the vehicle and shift to a low gear.
- Only drive off-road with the engine running and a gear engaged.
- Drive slowly and smoothly. Walking pace is necessary in many situations.
- Make sure that the wheels always remain in contact with the ground.
- Drive with extreme care over unknown terrain where you can only see for a short distance. As a precaution, get out of the vehicle to take a look at the route to be taken first.
- Check the water depth before fording.
- Watch out for obstacles (e.g. rocks, holes, tree stumps and ruts).
- Avoid edges where the surface could crumble or break away.

### Before driving off-road

- ▶ If the surface demands it, temporarily deactivate acceleration skid control (ASR) when pulling away (▷ page 49).
  - ▶ Safely stow or secure any items of luggage or loads (▷ page 144).
- i** We recommend that you additionally carry a shovel and a recovery rope with shackle in the vehicle.

### After driving off-road

#### Warning

Damage caused to the vehicle when driving off-road may cause consequential damage, the failure of mechanical assemblies as well as accidents. Clean and inspect the vehicle after any off-road use. Repair any damage before using the vehicle again.

- ▶ Activate the acceleration skid control system (ASR) (▷ page 49).
- ▶ Clean the vehicle (▷ page 165).
- ▶ Check the vehicle for damage.

### Transport by rail

Transporting your vehicle by rail may be subject to certain restrictions or require special measures to be taken in some countries due to varying tunnel heights and loading standards.

You may obtain information about this from any authorized Sprinter Dealer.

### Fuel consumption

Fuel consumption depends on:

- the vehicle version
- the style of driving
- the operating conditions
- the type or quality of the fuel used

The vehicle will use more fuel than usual in the following situations:

- at very low temperatures
- in city traffic
- on short trips
- when towing a trailer
- in mountainous terrain

Observe the advice in the "Protection of the environment" section to keep fuel consumption low .

The following components of the different vehicle versions influence fuel consumption:

- tire sizes, tire tread, tire pressure, tire condition
- body
- drive unit gear ratios
- additional equipment (e.g. air-conditioning system, auxiliary heating system).

Details concerning fuel consumption are recorded in the on-board computer; use the steering wheel buttons to call up the [Trip computer](#) menu (▷ page 85).

### DEF consumption

Depending on the vehicle version, the DEF consumption of:

- a Cargo Van/Passenger Van is approximately 2322 MPG (0.10 l/100 km)
- a Chassis Cab is approximately 1720 MPG (0.14 l/100 km)

In each case, the stated consumption figure is a mean value between urban and extra-urban driving cycles. The consumption figure does not refer to a specific vehicle, but is provided for the purposes of comparison between different vehicle types.

DEF consumption, like fuel consumption, is very dependent on the driving style and the operating conditions. This means that the real consumption figures during operation of your vehicle may deviate from those stated.

## Engine oil consumption

**!** If the vehicle is predominantly used for short-distance driving, this could lead to a malfunction in the automatic cleaning function for the diesel particle filter. As a result, fuel may accumulate in the engine oil and cause engine failure.

Therefore, if you mainly drive short distances, you should drive on a highway or on rural roads for 20 minutes every 310 miles (500 km). This ensures sufficient regeneration of the diesel particle filter.

Depending on the driving style, the vehicle consumes a maximum of 1.0 US qt (1.0 l) of oil over a distance of 620 miles (1000 km).

Engine oil consumption may be higher if:

- the vehicle is new.
- you mainly operate the vehicle under arduous operating conditions.
- you frequently drive at high engine speeds.

Regular maintenance is one of the preconditions for moderate rates of consumption.

You can only estimate the engine oil consumption after you have driven a considerable distance.

Check the engine oil level on a regular basis, e.g. weekly or each time you refuel (▷ page 171).

## Speed limiter

You can permanently limit the maximum speed of your vehicle to 75 mph (120 km/h).

We recommend that you have the maximum speed programmed at an authorized Sprinter Dealer. This has the necessary specialist knowledge and tools to carry out the required work.

### Warning

Exceeding the permissible maximum speed can cause tire damage, which could lead to loss of control of the vehicle.

As the driver, you must find out about the maximum speed of the vehicle and the resulting permissible maximum speed of the tires (tire and tire pressure).

You must not exceed the speed limit for the tires listed in the tire pressure tables.

- i** You will find information about tire pressure in the "Technical data" section (▷ page 280).

## Reverse warning device

On vehicles with a reverse warning feature, a warning signal sounds when reverse gear is engaged to alert other road users. The volume of this warning signal can be reduced for night-time driving.

### Warning

Other road users could fail to hear or could ignore the reverse warning feature warning signal. For this reason, the reverse warning feature cannot guarantee that there are no people or objects behind your vehicle.

The reverse warning feature is a system designed to assist you in ensuring the safety of other road users. It does not, however, relieve you of your responsibility to make sure that there are no persons or objects behind your vehicle while you are maneuvering.

For this reason, always observe the road and traffic conditions with due caution. To avoid damage and injury, make sure that there are no persons or objects behind the vehicle while you are maneuvering. Have a second person assist you when maneuvering if necessary.

- **To set the warning signal to quiet:** engage the reverse gear twice in brief succession.

The volume of the warning signal is reduced.

- i** The warning signal sounds at normal volume by default and will need to be

reduced in volume each time reverse gear is engaged.

## Refueling

### Warning

Fuel is highly flammable. Fire, naked flames and smoking as well as the use of auxiliary heaters (sparks) are therefore prohibited when handling fuel.

Switch off the engine and the auxiliary heating before refueling.

### Warning

Avoid any contact with fuels.

You can damage your health if your skin comes into direct contact with fuel or if you inhale fuel vapors.

### Environmental note

If fuels are handled improperly, they pose a danger to persons and the environment. Do not allow fuels to run into the sewage system, the surface waters, the ground water or into the ground.

**!** Filter the fuel before transferring it to the vehicle if you are refueling the vehicle from barrels or containers.

This will prevent malfunctions in the fuel system due to contaminated fuel.

### Warning

Do not use gasoline to refuel vehicles with a diesel engine. Never mix diesel with gasoline. This causes damage to the fuel system and engine and could result in the vehicle catching fire.

**!** Do not use gasoline to refuel vehicles with a diesel engine. Even small amounts of gasoline will cause damage to the fuel system and engine. Damage resulting from adding gasoline is not covered by the New Vehicle Limited Warranty.

**!** If the wrong fuel has been added by mistake, do not switch on the ignition. If you do, the fuel could enter the fuel lines. The tank and the fuel lines must then be drained. Inform a qualified specialist workshop and have the tank and the fuel lines drained completely.

The fuel filler flap is beside the front left-hand door when viewed in the direction of travel. It is only possible to open the fuel filler flap when the front door is open.

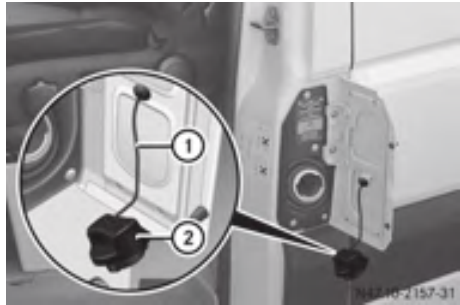

- ▶ Remove the key from the ignition lock.
- ▶ Switch off the auxiliary heating system (▷ page 104).
- ▶ Open the front left-hand door first, and then the fuel filler flap.
- ▶ Close all vehicle doors to prevent fuel vapors from entering the vehicle.
- ▶ Turn tank filler cap (2) counter-clockwise, remove it and let it hang from retaining strap (1).
- ▶ Only fill the tank until the pump nozzle switches off.
- ▶ Replace tank filler cap (2) and turn clockwise.
  - You will hear a click when the fuel filler cap is closed fully.
- ▶ Open the front left-hand door first, and then close the filler flap.

You will find information about fuel in the "Service products" section (▷ page 153).



## Diesel Exhaust Fluid (DEF)

The exhaust gas aftertreatment requires a reducing agent, Diesel Exhaust Fluid (DEF), in order to function correctly.

### Warning

If you open the DEF reservoir cap at high temperatures, ammonia vapors could be released.

Ammonia vapors have a pungent odor and are particularly irritating for your skin, respiratory organs and eyes. This may result in burning eyes, nose and throat, as well as coughing and watering eyes.

Do not inhale ammonia vapors.

### Warning

Avoid contact with DEF.

DEF is hazardous to health. Do not allow DEF to come into contact with your skin. Rinse affected areas with plenty of clean water and consult a doctor if necessary.

### Environmental note

Dispose of DEF in an environmentally responsible manner.

 Only use DEF in accordance with ISO 2224 1. The exhaust gas aftertreatment system may otherwise be damaged.

Observe the MB Specifications for Service Products, Sheet No. 352.0.

Damage caused by the use of other reducing agents will result in the loss of your New Vehicle Limited Warranty entitlements.

 If DEF comes into contact with a painted or aluminum surface, wash the surface off immediately with plenty of water.

 DEF is not a diesel additive and must not be mixed with fuel in the tank. Even small amounts of DEF can cause engine damage. Damage resulting from adding DEF is not covered by the New Vehicle Limited Warranty.

 If the DEF level drops below the reserve level, the second warning message (▷ page 116) appears and at this point, at the latest, you must add at least 2.0 US gal (7.6 l) of DEF.

You will find further information on DEF in the "Service products" section (▷ page 155).

## DEF filler neck in the engine compartment

- ▶ Remove the key from the ignition lock.
- ▶ Close all vehicle doors so that no ammonia vapors can enter the vehicle.

 Do not inhale any ammonia vapors which may escape when you unscrew the tank filler cap. Ammonia vapors have a pungent odor. However, they are neither toxic nor hazardous to health in this concentration.

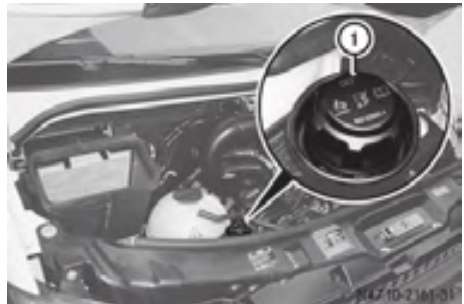

- ▶ Turn tank filler cap ① counter-clockwise and remove it.
- ▶ Only fill the tank via the filler neck until the DEF level can be seen in the filler neck.
- ▶ Replace DEF tank filler cap ① on the filler neck and turn clockwise. You will hear a click when tank filler cap ① is closed fully.

## DEF filler neck on the right-hand vehicle side

- ▶ Remove the key from the ignition lock.
- ▶ Close all vehicle doors so that no ammonia vapors can enter the vehicle.

- ❶ Do not inhale any ammonia vapors which may escape when you unscrew the tank filler cap. Ammonia vapors have a pungent odor. However, they are neither toxic nor hazardous to health in this concentration.



DEF tank on the right-hand side of the vehicle (example: Chassis Cab)

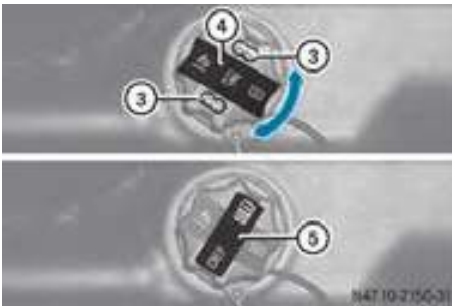

DEF tank filler cap

- ▶ Remove tool ⑤ for unlocking tank filler cap ② from the footwell on the co-driver's side (▶ page 182).
- ▶ Pull cover ④ up, turn 90° and release.
- ▶ Insert tool ⑤ into hole ③ of tank filler cap ②.
- ▶ Turn tank filler cap ② counter-clockwise, remove it and let it hang from retaining strap ①. Make sure that tool ⑤ remains in tank filler cap ② while doing so.
- ▶ Only fill the tank via the filler neck until the DEF level can be seen in the filler neck.
- ▶ Replace tank filler cap ② and turn clockwise.

- ▶ Pull tool ⑤ out of tank filler cap ② and stow with the vehicle tool kit in the footwell on the co-driver's side.
- ▶ Pull cover ④ up over hole ③ of tank filler cap ②, turn and release.
- ▶ Turn tank filler cap ②.  
If tank filler cap ② turns freely, the DEF tank is closed.

## Transporting loads with the vehicle

### Loading guidelines

#### ⚠ Warning

Secure and position the load as described in the loading guidelines. You or others could otherwise be injured by the load slipping or being thrown around in the event of sharp braking, sudden changes in direction or on poor road surfaces. This also applies to seats which have been removed if they remain in the vehicle.

Even if you follow all loading guidelines, the load increases the risk of injury in the event of an accident. Observe the tips in the "Securing a load" section.

#### ⚠ Warning

Do not allow the load, including passengers, to exceed the permissible gross vehicle weight or the gross axle weight rating for your vehicle.

If the gross axle weight rating or permissible gross vehicle weight is exceeded during transport, tire durability and road safety are adversely affected. The vehicle's handling and steering characteristics change noticeably. Braking and stopping distances are significantly longer.

The vehicle's driving, steering and braking characteristics change as the gross vehicle weight increases or when the center of gravity is raised.

Always make sure that the distribution of the load is correct and adapt your driving style according to the load.

### Warning

If you have installed a roof carrier, the vehicle's handling, steering and braking characteristics may change due to the higher center of gravity. This is the case particularly if the roof carrier is laden. Adapt your driving style according to the vehicle load.

Observe the manufacturer's installation instructions. An incorrectly secured roof carrier and/or load could come loose, fall off and thereby endanger you or others.

Observe the maximum roof load and maximum roof carrier load. Loads transported on the roof must always be secured with particular care.

Do not allow the load, including passengers, to exceed the permissible gross vehicle weight or the gross axle weight rating for your vehicle.

### Warning

When using suitable load securing aids and lashing material, always follow the manufacturer's operating instructions, in particular the notes on discard criteria contained therein.

Load securing aids and lashing material may not be used, for example, if:

- identification marks are missing or illegible
- there are yarn breakages, damage to bearing seams or other signs of tearing
- there are signs of shearing, deformation, pinching or other damage
- there is damage to clamping or connecting elements

Load securing aids and lashing material in this condition are ready for discard and must be replaced.

If you use load securing aids or lashing materials that are ready for discard, the load is not correctly secured and could cause

serious injuries to you and others and cause material damage.

### Warning!

After an accident, have a damaged cargo floor or cargo area, lashing eyelets and lashing material checked at a qualified specialist workshop that has the necessary specialist knowledge and tools to carry out the work required. The cargo could otherwise be insufficiently secured during the next transport and could lead to serious injury to you and other persons or material damage.

For this reason, we recommend an authorized Sprinter Dealer. In particular, all work relevant to safety or on safety-related systems must be carried out at a qualified specialist workshop.

- ❗ If you are using a roof carrier, observe the maximum roof load and maximum roof carrier load.

You will find information about the maximum roof load in the "Technical data" section (▷ page 283) and information about roof carriers in the "Carrier systems" section (▷ page 149).

## Before loading

- ▶ **Tire pressure:** check the tire pressure and correct if necessary (▷ page 281).
- ▶ **Cargo floor:** clean the cargo floor.
  - The cargo floor must be free from oil and dust, dry and clean swept to prevent the load from slipping.
- ▶ Place non-slip mats (anti-slip mats) on the cargo floor if necessary.

- ❗ As soon as the non-slip mats show signs of deformation or develop squashed areas, or traces of cracking/cutting, they can no longer be used to secure a load and must be replaced.

### During loading

- ▶ Observe the gross axle weight rating and permissible gross vehicle weight for your vehicle.
- ❗ On passenger van versions with maximum seating layout, the permissible rear axle load would be exceeded if the full payload were to be loaded in the cargo compartment.
- ℹ Bear in mind that the curb weight of the vehicle is increased by installing optional equipment and accessories.
- ▶ Observe the information about load distribution (▷ page 146).
- ▶ Secure the load (▷ page 146). Always observe the relevant national regulations.

### Checks after loading

- ▶ **Securing loads:** check that the load is secure before every journey and at regular intervals during a long journey, and correct if necessary.
- ▶ **Doors:** close the sliding doors and rear doors.

#### Warning

Make sure that the sliding doors and rear doors are always closed when the engine is running.

Exhaust fumes could otherwise enter the vehicle interior and poison you.

- ▶ **Tire pressure:** adjust the tire pressures according to the vehicle load (▷ page 281).
- ▶ **Driving style:** adapt your driving style according to the vehicle load.

### Load distribution

The overall center of gravity of the load should always be as low as possible, centered and between the axles near the rear axle.

- ❗ Excessive loads on individual points of the cargo floor or on the load surface impair vehicle handling characteristics and could cause damage to the floor covering.

On crewbuses:

- ▶ Always transport loads in the cargo compartment.
- ▶ Always place the load against the backrests of the rear bench seat.
- ▶ Move large and heavy loads as far towards the front of the vehicle as possible against the rear bench seat. Stow the load flush with the rear bench seat.
- ▶ Always additionally secure the load with suitable load securing aids or tie down.

ℹ Observe the following notes:

- Do not stack loads higher than the upper edge of the backrests.
- Transport loads behind seats that are not occupied.
- If the rear bench seat is not occupied, insert the seat belts crosswise into the buckle of the opposite seat belt.

### Securing loads

#### General notes

As the driver, you are responsible for ensuring that the cargo is secured against sliding, tipping, rolling or falling. This applies to general traffic situations as well as evasive maneuvers or full brake application and on poor stretches of road.

If your load is not secured in accordance with applicable requirements and guidelines regarding the securing of loads, you may be liable to prosecution, depending on the local legislation and the consequences of inadequately secured loads.

You should therefore observe the respective legal requirements for the relevant country. Check that the load is secure before every journey and at regular intervals during a long

journey, and correct an incorrectly or inadequately secured load if necessary.

- ① You can obtain information about securing the load correctly from the manufacturer of the load securing aids or tie down for securing the load.
- ▶ Fill spaces between the load and the cargo compartment walls or wheel arches (form-locking). Use rigid load securing aids, such as wedges, wooden fixings or padding.
- ▶ Attach secured and stabilized loads in all directions to the cargo tie-down points, cargo tie-down rings and loading rails in the cargo compartment or on the load surface, depending on the equipment in the vehicle. Only use tie downs, such as lashing rods or lashing nets and lashing straps, that have been tested in accordance with current standards (e.g. DIN EN).

Always use the cargo tie-down rings closest to the load to secure it and pad sharp edges for protection.

- ① Tie-downs which have been tested in accordance with current standards (e.g. DIN EN) can be obtained from specialist firms or an authorized Sprinter Dealer. Loads, and heavy loads in particular, should preferably be secured using the cargo tie-down rings.

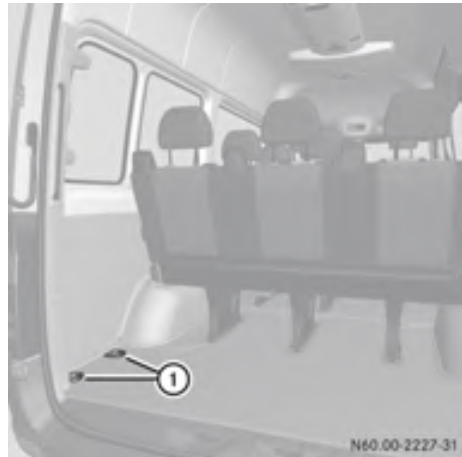

Cargo tie-down points (example: Passenger Van)

- ① Cargo tie-down rings

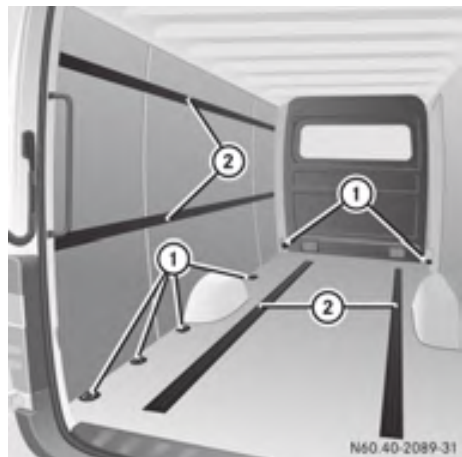

Cargo tie-down points (example: Cargo Van)

- ① Cargo tie-down rings
- ② Load rails

### **Warning**

You may not transport anyone in the cargo compartment or on the load surface. Never let more people ride in the vehicle than there are seat belts available. Make sure everyone riding in the vehicle is correctly restrained with a separate seat belt. Never use a seat belt for more than one person at a time.

**⚠ Warning**

Do not attempt to modify or repair the lashing points, cargo tie-down rings or tie downs. The load or the cargo tie-down rings could work loose and cause serious injury to you and other people as well as material damage.

Spread the load evenly between the lashing points or cargo tie-down rings.

Observe the loading guidelines.

- i** Secure loose loads with a tested lashing net or a tarpaulin.
- ▶ Always fasten the lashing net or tarpaulin to all available cargo tie-down points. Make sure that the retaining hooks are secured against accidental opening.

- !** Observe the information on the maximum loading capacity of the lashing points.

If you use multiple lashing points to secure a load, you should observe the maximum loading capacity of the weakest lashing point.

When you brake hard, for example, forces apply that can be far higher than the weight force of the transported load. Always use multiple lashing points to distribute these forces, and distribute the load equally among them.

Information about the maximum loading capacity of the cargo tie-down points can be found in the "Technical data" section (> page 283).

- i** If your vehicle is equipped with loading rails in the cargo floor, you should place lashing rods directly in front of and behind the load. The lashing rods directly absorb the potential shifting forces.

**⚠ Warning**

If you tension the lashing straps between the side walls, or between a side wall and the cargo floor, the maximum permissible load for the loading rails or lashing points or eyelets could be exceeded if the brakes are applied

suddenly, if the vehicle's direction is changed abruptly or in the event of an accident.

The load would no longer be secured, resulting in a risk of serious injury being caused by the load slipping.

For this reason, do not tension a lashing strap between the side walls or between a side wall and the cargo floor.

Only lashing rods are to be used between the loading rails on the side walls. Observe the operating instructions of the lashing rod manufacturer.

- i** Securing loads on the cargo floor by lashing them down is only recommended for lightweight loads. Place non-slip mats (anti-slip mats) on the cargo floor to increase load security.

**⚠ Warning**

Before releasing the lashing straps, you must make sure that the load is standing firmly and that it cannot tip over once the straps have been removed. Otherwise, you or others could be injured by the load slipping.

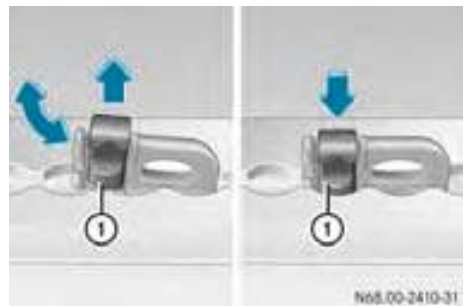
**Installing/removing cargo tie-down points for the loading rails**

- ▶ **To install:** slide the cargo tie-down ring through a recess in the loading rail close to the load until locking mechanism ① engages in the recess.

- i** When you pull locking mechanism ① up and out of the recess, the cargo tie-down ring is able to move within the loading rail.

Make sure that locking mechanism ① is always engaged in a recess.

### Warning

If not firmly anchored in the loading rail, the cargo tie-down ring may slip or be torn out of the loading rail in the event of sudden braking. The load would no longer be secured, resulting in a risk of serious injury being caused by the load slipping. For this reason, always check the cargo tie-down ring for firm seating after installing.

- ▶ Check the cargo tie-down ring for firm seating.
- ▶ **To remove:** pull locking mechanism ① up and pull the cargo tie-down ring towards the locking mechanism and out of the loading rail through a recess.

### Carrier systems

It is possible to install a roof carrier if your vehicle is equipped with securing rails on the roof.

Special mountings (sliding blocks) are available as accessories. These are available from any authorized Sprinter Dealer.

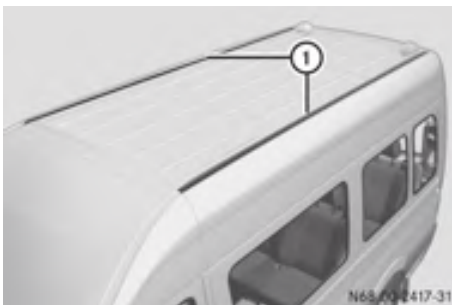

① Securing rails

### Warning

If you have installed a roof carrier, the vehicle's handling, steering and braking characteristics may change due to the higher center of gravity. This is the case particularly

if the roof carrier is laden. Adapt your driving style according to the vehicle load.

Observe the manufacturer's installation instructions. An incorrectly secured roof carrier and/or load could come loose, fall off and thereby endanger you or others.

Observe the maximum roof load and maximum roof carrier load. Loads transported on the roof must always be secured with particular care.

Do not allow the load, including passengers, to exceed the permissible gross vehicle weight or the gross axle weight rating for your vehicle.

You can find information about the maximum roof load in the "Technical data" section (> page 283).

### Make sure that:

- the roof rack mounting bolts are tightened in the slot nuts provided with a torque of 6.0 – 7.4 lb-ft (8 – 10 Nm).
- the bolts, when tightened, do not touch the rails.
- the slot nuts are not located in the area of the plastic caps.
- the slot nuts have the right cross-section.
- the mounting rails in the interior are free of dirt.
- retighten the mounting bolts evenly after approximately 300 miles (500 km).

We recommend that you only use roof racks tested and approved by Sprinter. These help avoid vehicle damage.

 If you would like to have the mounting rails retrofitted, have them installed at a qualified specialist workshop which has the necessary specialist knowledge and tools to carry out the work required. You could otherwise damage the vehicle.

For this reason, we recommend an authorized Sprinter Dealer.

## Towing a trailer

### Notes on trailer towing

#### Important safety notes

The trailer coupling is one of the most important vehicle parts with regard to road safety. The notes on operation, care and maintenance issued by the manufacturer should be observed.

#### Warning!

Improper equipment or driving technique while driving with a trailer can cause you to lose control of your vehicle.

Improper towing or failure to observe the Operator's Manual can lead to vehicle damage and/or serious injuries. Observe the following guidelines in order to guarantee safe driving with trailers.

Contact an authorized Sprinter Dealer if you require any explanation of the information contained in the Operator's Manual.

#### General notes

- Install only an approved trailer coupling on your vehicle.  
Further information about availability and installation of trailer couplings can be obtained from any authorized Sprinter Dealer.
- The bumpers of your vehicle are not suitable for installing detachable trailer couplings.
- Do not install rented trailer couplings or other detachable trailer couplings to the bumpers.
- To reduce the risk of damage to the ball coupling when using a detachable trailer coupling, remove the ball coupling from its mounting when it is not needed.

#### Coupling up a trailer

Observe the maximum permissible trailer dimensions (width and length).

Most federal states and all Canadian provinces require by law:

- safety chains between the towing vehicle and the trailer. The chains should be cross-wound under the trailer drawbar. They must be fastened to the vehicle's trailer coupling, not to the bumper or the axle. Allow for enough play in the chains to facilitate turning tight corners.
- a separate brake system for certain types of trailer.
- a safety switch for braked trailers. Check the specific legal requirements applicable to your federal state.  
If the trailer detaches from the towing vehicle, the safety switch applies the trailer's brakes.

-  The vehicle's subharness has an electric cable to the brake light indicator lamp.

#### Warning

Follow the manufacturer's operating instructions for the trailer tow hitch when using a detachable trailer tow hitch.

Couple and decouple the trailer carefully. A trailer which is incorrectly coupled to the towing vehicle could break away. A correctly coupled trailer must be positioned horizontally behind the vehicle.

Ensure that the following weights are not exceeded:

- the permissible noseweight
- the permissible trailer load
- the permissible rear axle load of the towing vehicle
- the permissible gross weight for both the towing vehicle and the trailer

The permissible values, which must not be exceeded, can be found in your vehicle documents and on the trailer tow hitch type plates for the trailer and the vehicle. Where the values differ, the lowest is valid.



- ▶ Make sure that the automatic transmission is set to position **P**.
- ▶ Engage the vehicle's parking brake.
- ▶ Close the rear doors.
- ▶ Couple the trailer.
- ▶ Establish all electrical connections.

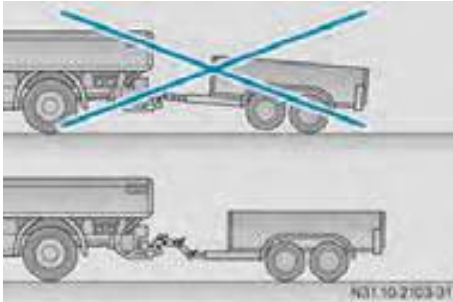

Trailer coupled ready for use

### Towing a trailer

There are numerous legal requirements concerning the towing of a trailer, e.g. speed restrictions. Make sure that your vehicle/trailer combination complies with the local requirements not only in your area of residence but also at any location to which you are traveling. The police and local authorities can provide reliable information. Please observe the following when towing a trailer:

- To acquaint yourself with driving with a trailer and with the resulting changes to handling, you should practice cornering, stopping and reversing in a traffic-free location.
- Before driving, check:
  - trailer coupling
  - safety switch for braked trailers
  - safety chains
  - electrical connection
  - lights
  - wheels

- Adjust the exterior mirrors to provide an unobstructed view of the rear section of the trailer.
- If the trailer has electronically controlled brakes, pull away slowly, brake manually using the brake controller and check that the brakes are functional.
- Secure any objects on the trailer to prevent the cargo from slipping when the vehicle is in motion.
- If you couple up a trailer, regularly check that the cargo is secure and make sure that the trailer lamps and (if applicable) the trailer brakes are functioning correctly.
- Bear in mind that the handling will be less stable when towing a trailer than when driving without one. Avoid sudden steering movements.
- The vehicle/trailer combination is heavier, accelerates more slowly and has a decreased gradient climbing capability and a longer braking distance. It is more susceptible to crosswinds and requires cautious steering.
- If possible, do not brake abruptly; apply the brakes moderately to begin with to allow the trailer to activate its brakes. Then increase the pressure on the brake pedal.
- If the automatic transmission repeatedly shifts between gears when driving on inclines, restrict the shift range. Select shift range **4, 3, 2** or **1**.  
Driving in a low gear and at a low speed reduces the risk of damaging the engine.
- When driving on a downhill gradient, shift to a low gear and take advantage of the engine's braking effect.  
Avoid continuous brake application as this may overheat the vehicle brakes and, if installed, the trailer brakes.
- If the coolant temperature increases dramatically while the air-conditioning system is switched on, switch off the air-conditioning system.

Coolant heat can additionally be dissipated by opening the windows and by setting the blower fan and the interior temperature to maximum.

- When overtaking, pay particular attention to the extended length of your vehicle/trailer combination.

Due to the length of your vehicle/trailer combination, you will have to travel an additional distance beyond the vehicle you are overtaking before returning to the original lane.

If the trailer begins to swing from side to side:

- ▶ do not accelerate.
- ▶ do not counter-steer.
- ▶ brake if necessary.

#### Warning

Under no circumstances try to straighten the vehicle/trailer combination by increasing the speed.

- i** You can reduce the risk of the trailer swinging and snaking by retrofitting anti-roll bars or trailer stability programs. You can obtain further information from an authorized Sprinter Dealer.

### Uncoupling a trailer

- ▶ Make sure that the automatic transmission is set to position **P**.
- ▶ Engage the vehicle's parking brake.
- ▶ Remove the trailer cable and uncouple the trailer.
- ▶ Engage the trailer's parking brake.

### Load distribution

The Gross Trailer Weight (GTW) is the combined weight of the trailer together with the cargo and equipment loaded on the trailer. The maximum permissible gross weight is vehicle-specific and depends on the equipment level: 5000 lbs (2268 kg) or 7500 lbs (3402 kg).

The permissible Trailer drawbar Weight Rating (TWR) is the maximum weight permitted on the trailer drawbar: 750 lbs (340 kg) or 500 lbs (227 kg) is the limit for trailer couplings approved by the vehicle distributor named on the inside of the front cover.

The Gross Combined Weight Rating (GCWR) is the sum of the Gross Trailer Weight and the vehicle weight, including a driver weight of approximately 150 lbs (68 kg). The permissible GCWR is vehicle-specific and depends on the equipment level.

When driving with a trailer, you should not exceed the permitted Gross Combination Weight Rating (GCWR).

You must distribute the load on the vehicle and trailer so that the permitted maximum values for the vehicle (GCWR) and trailer (GTW) weight as well as permitted axle loads (GAWR) and noseweight (TWR) of your vehicle are not exceeded.

- i** Take into account that the vehicle's permissible payload must be reduced to compensate for the noseweight.

The applicable permissible values, which must not be exceeded, can be found in your vehicle documents and on the type plates for the trailer tow hitch, trailer and vehicle (▶ page 277). You will also find a list of the permissible values in the "Technical data" (▶ page 284) section. Where the values differ, the lowest is valid.

- !** The permissible gross combination weight is less than the sum of the permissible gross vehicle weight plus the permissible trailer load. Exceeding the permissible gross combination weight can lead to damage to the drivetrain, to the transmission or to the trailer tow hitch. For this reason, applicable values for the permissible gross vehicle weight or the permissible trailer load are reduced accordingly if either the vehicle or the trailer is fully loaded. In this case, the trailer or the vehicle may only be partially loaded.

Verify compliance with weight limitations on a weighbridge.

## Trailer power supply

Your vehicle may be equipped with various electrical fittings for trailer towing. Depending on your trailer, you may need an adapter to allow your trailer to be connected to the vehicle. Information about your vehicle's electrical equipment is available from any authorized Sprinter Dealer.

**!** Faulty wiring of the connector plug could in certain circumstances cause other electronic systems to malfunction. For this reason, we recommend having the wiring of the connector plug performed at an authorized Sprinter Dealer.

## Operation in winter

### General notes

Have your vehicle winterized at a qualified specialist workshop, e.g. an authorized Sprinter Dealer, at the onset of winter.

This service includes the following:

- oil change, if the engine oil currently used does not have adequate low temperature characteristics or if these are no longer sufficient due to aging
- the antifreeze/anticorrosion concentration in the coolant is checked.
- the addition of a concentrated cleaning agent to the water in the windshield washer/headlamp cleaning system
- battery check
- a tire change

Prior to the onset of winter, ensure that snow chains are available in the vehicle.

Do not cover the surface of the radiator or the radiator grill, even in winter. Doing so could cause the engine diagnostics to record false or incorrect data. Recording of engine diagnostic data is legally prescribed and must

therefore be correct, clear and comprehensible at all times.

You will find information about diesel fuel for use at low outside temperatures in the "Operation" section (▷ page 154).

Please also observe the information about winter driving (▷ page 111).

You will find information about winter tires and about driving with snow chains in the "Wheel and tires" section (▷ page 153).

## Service products

### Fuel

#### Warning

Fuel is highly flammable. Fire, naked flames and smoking as well as the use of auxiliary heaters (sparks) are therefore prohibited when handling fuel.

Switch off the engine and the auxiliary heating before refueling.

#### Warning

Avoid any contact with fuels.

You can damage your health if your skin comes into direct contact with fuel or if you inhale fuel vapors.

**!** Filter the fuel before transferring it to the vehicle if you are refueling the vehicle from barrels or containers.

This will prevent malfunctions in the fuel system due to contaminated fuel.

**!** Refuel only with commercially available vehicle diesel fuel, ULTRA-LOW SULFUR DIESEL with a sulfur content no greater than 15 ppm. Fuels such as fatty acid methyl ester FAME (bio-diesel fuels), marine diesel, heating oil etc. may not be used as a diesel fuel mixture.

Refuel with B5 bio-diesel only if it fulfills the requirements listed under "Fuel quality".

Do not use any fuel additives, and use approved flow improvers only when necessary.

There is otherwise a risk of impaired engine performance or engine and catalytic converter damage. The use of fuel additives is always the responsibility of the vehicle operator and may result in the restriction or loss of your New Vehicle Limited Warranty entitlements.

### Fuel grade

- i** You will generally find information about the fuel grade on the filling pump. Otherwise, ask the gas station attendant.

Refuel only with commercially available ULTRA-LOW SULFUR DIESEL (ULSD, maximum sulfur content of 15 ppm) that conforms to the ASTM D975 standard.

We approve the use of B5 bio-diesel (ULSD with a maximum bio-diesel content of 5% by volume ) for all Sprinter diesel engines with Common-rail Direct Injection (CDI).

You may refuel with B5 bio-diesel if the bio-diesel content is in accordance with the ASTM standard D675 1. It must also have the necessary oxidation stability (at least 6 h in accordance with the EN 14112 standard) to avoid damage caused by deposits and/or corrosion.

Pure bio-diesel and diesel fuels that have a higher percentage of bio-diesel, such as B20, may damage the fuel system and the engine and are therefore not approved. Please contact gas station personnel for more information. The B5 bio-diesel marking on the pump must state unequivocally that the ULSD standard is fulfilled. If the marking does not make this clear, do not refuel from that pump.

**!** You can damage the engine and diesel particle filter (DPF) by refueling with the following diesel fuels:

- LOW SULFUR DIESEL with a sulfur content of maximum 500 ppm
- diesel fuel with a sulfur content greater than 15 ppm
- diesel fuel with a bio-diesel content of more than 5%
- diesel fuel with a bio-diesel content up to 5% but that does not conform to the requirements listed under "Fuel quality"

Damage caused by the use of such diesel fuels is not covered by the New Vehicle Limited Warranty.

### Diesel at low temperatures

Refuel only with commercially available ULTRA-LOW SULFUR DIESEL (ULSD, maximum sulfur content of 15 ppm) that conforms to the ASTM D975 standard.

To prevent operating problems, diesel with better flow qualities is available during the winter months. You can obtain information at the gas station or from your fuel supplier.

At very low outside temperatures, paraffin may separate from the diesel fuel and prevent it from flowing freely.

Your vehicle is equipped with a fuel preheating system. This system also improves the flow characteristics of the diesel fuel by about 46 °F(8 °C). ULTRA-LOW SULFUR DIESEL can therefore be used at outside temperatures of down to 14 °F(-10 °C) without any impairment.

### Fuel additives

Flow improvers are fuel additives used to improve the flow characteristics of diesel fuels.

The effectiveness of flow improvers cannot be guaranteed with all fuels. Observe the manufacturer's recommendations.

Information about approved flow improvers is available from any authorized Sprinter Dealer.

**!** Do not use fuel additives (with the exception of flow improvers), since this could lead to malfunctions or engine damage. Damage caused by the use of such additives is not covered by the New Vehicle Limited Warranty.

**!** Do not add gasoline or kerosene to diesel fuel to improve its flow characteristics. Gasoline or kerosene impairs the lubricating properties of the diesel fuel. This may cause damage to the injection system, for example.

At outside temperatures below 14 °F(-10 °C) and with less cold-resistant winter diesel fuel, add the amount of flow improver appropriate to the outside temperature.

Add this additive to the diesel in time, i.e. before the flow properties of the diesel are affected by paraffin separation. Malfunctions caused by paraffin separation can only be rectified by heating the entire fuel system, e.g. by parking the vehicle in a heated garage.

#### **Warning**

If you heat up the fuel system with a heat gun, for example, you may damage parts of the fuel system. Fuel could escape, be ignited, and cause a fire.

Never heat the fuel system with a heat gun or with a naked flame.

### **Diesel Exhaust Fluid (DEF)**

DEF is the reducing agent for the exhaust gas aftertreatment. DEF is a nonflammable, nontoxic, colorless, odorless and water-soluble liquid.

**!** Only use DEF in accordance with ISO 22241. The exhaust gas aftertreatment may otherwise be damaged.

Observe the MB Specifications for Service Products, Sheet No. 352.0.

Damage caused by the use of other reducing agents will result in the loss of

your New Vehicle Limited Warranty entitlements.

**!** If DEF comes into contact with a painted or aluminum surface, wash the surface off immediately with plenty of water.

### **High ambient temperatures**

If DEF in the DEF reservoir heats up to temperatures over 122 °F(50 °C) for a long period of time (e.g. due to direct sunlight), ammonia vapors form.

#### **Warning**

If you open the DEF reservoir cap at high temperatures, ammonia vapors could be released.

Ammonia vapors have a pungent odor and are particularly irritating for your skin, respiratory organs and eyes. This may result in burning eyes, nose and throat, as well as coughing and watering eyes.

Do not inhale ammonia vapors.

### **Low ambient temperatures**

DEF freezes at a temperature of approximately 12 °F(-11 °C). The vehicle is equipped with a DEF preheating system at the factory. This ensures that the vehicle can be operated in winter, even at temperatures below 12 °F(-11 °C).

### **Additives and tap water**

**!** Do not mix DEF with any additives and do not dilute DEF with tap water. Otherwise, the exhaust gas aftertreatment may be damaged.

Observe the MB Specifications for Service Products, Sheet No. 352.0.

Damage caused by the use of additives or tap water is not covered by the New Vehicle Limited Warranty.

## Storage

Only store DEF in containers made of high-alloy Cr-Ni steel or Mo-Cr-Ni steel in accordance with DIN EN 10 088-1/2/3 or plastic containers made of polypropylene or polyethylene.

**!** Containers made of aluminum, copper, copper alloys as well as unalloyed or galvanized steel are not suitable for storing DEF. If stored in these types of containers, DEF could cause constituents of these metals to dissolve and cause irreparable damage to the exhaust gas aftertreatment. Damage caused by dissolved components of the storage container will result in a loss of your New Vehicle Limited Warranty entitlements.

## Disposal

Observe country-specific laws and regulations when disposing of DEF.

### Environmental note

Dispose of DEF in an environmentally responsible manner.

## Purity

The purity of DEF is essential to prevent malfunctions in the exhaust gas aftertreatment.

If DEF is pumped out of the DEF tank, e.g. during repair work, the same liquid must not be used to refill the tank. Its purity is no longer guaranteed.

**!** Impurities in DEF (e.g. caused by other service products, cleaning agents, dust, etc.) result in increased emissions, malfunctions, catalytic converter damage or engine damage.

## Engine oils

Use only approved engine oil that complies with the MB Specifications for Service Products.

**!** The bottles of the various engine oil types are marked with ACEA (Association des Constructeurs Européens d'Automobiles) and/or API (American Petroleum Institute) classifications. Only use approved engine oils that conform to the following MB Specifications for Service Products and the prescribed ACEA and/or API classifications. Using engine oils of another quality is not permitted and may lead to a loss of your New Vehicle Limited Warranty entitlements.

The use of other, non-approved engine oils for diesel engines can cause damage to the diesel particle filter (DPF).

The MB Specifications for Service Products apply to your vehicle<sup>1</sup>

- 228.51
- 229.51

These engine oils are of high quality and have a beneficial effect on:

- engine wear
- fuel consumption
- emissions

Multi-grade engine oils of the prescribed SAE class (viscosity) may be used all year round, taking the outside temperatures into account.

## Oil change

Oil change intervals depend on the vehicle's operating conditions and the quality of the engine oil used.

The on-board computer automatically shows the date for the next oil change as an event message in the display.

<sup>1</sup> If the quality level for diesel engines is not available, you may refill with engine oils that comply with the MB Specifications for Service Products, Sheet No. 228.5, 229.3 and 229.5. The refill quantity is then limited to a maximum of 1 qt (1 l).

Select the SAE class (viscosity) of the engine oil in accordance with the outside temperature.

**!** If the SAE viscosity class of the engine oil used does not cover the outside temperature range in which you are operating the vehicle, it must be changed in good time, in particular before the cold season commences. Using an engine oil that does not have adequate temperature characteristics can lead to engine damage. The temperature range information of the SAE classification always refers to that of fresh oil. The temperature characteristics of the engine oil may deteriorate significantly due to aging in use, especially at low outside temperatures.

For this reason, we recommend that the engine oil be changed before the cold season commences. Use an approved engine oil of the specified SAE class.

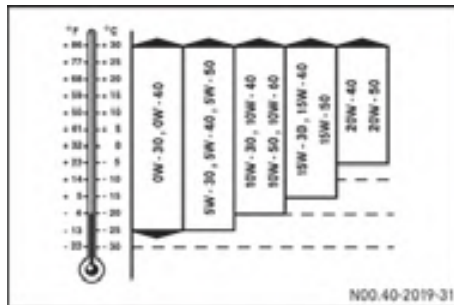

Engine oil SAE classification

**i** Only by using engine oil with a particularly high quality grade, e.g. according to Sheet Number 228.51 of the MB Specifications for Service Products, can the maximum interval for oil change be achieved.

We recommend that you only add engine oil of the same quality grade and SAE class as used when the engine oil was last changed.

You can obtain further information from any authorized Sprinter Dealer.

**!** Do not add too much oil. Adding too much oil can result in damage to the engine or the

catalytic converter. Have excess oil siphoned off.

### Miscibility of engine oils

If, in exceptional cases, oil of the type in the engine is not available, top up using another approved mineral or synthetic engine oil.

Engine oils are differentiated according to:

- engine oil brand
- quality grade (sheet number)
- SAE class (viscosity)

Subsequently have the engine oil changed at the earliest possible opportunity.

**!** Mixing oils reduces the benefits of using high grade engine oils.

**i** The sheet number (quality grade) and the SAE classification (viscosity) can be found on the designation on the oil bottle.

### Change intervals for engine oil

Service product	Maintenance interval	Product name/number	MB Sheet No.
Engine oil for diesel engines	2 years or 10,000 miles (16,000 km) <sup>2</sup>	See approved engine oils	228.51 229.51

### Transmission and steering oils

#### Automatic transmission

Service product	Maintenance interval	Product name/number	MB Sheet No.
Automatic transmission oil	every second maintenance service	Shell ATF 3403/M-115	236.10
		Fuchs/Shell ATF 3353	236.12

You can obtain further information from any authorized Sprinter Dealer.

#### Rear axle

Service product	Maintenance interval	Product name/number	MB Sheet No.
Transmission oil	every sixth maintenance service or every 10 years <sup>3</sup>	BP Energear Hypo DC 80W-90	235.20
		Mobil Delvac Synthetic Gear Oil 75W-90	235.8

You can obtain further information from any authorized Sprinter Dealer.

<sup>2</sup> The interval – time or distance – that is first reached applies.

<sup>3</sup> The maintenance interval criterion that occurs first applies.



## Steering

Steering, no maintenance required.

Service product	Maintenance interval	Product name/number	MB Sheet No.
Power steering fluid	-	Mobil ATF-D, Exxon Mobil Corporation or equivalent	236.3

You can obtain further information from any authorized Sprinter Dealer.

### Brake fluid

#### Warning

Brake fluid is hazardous to health. Do not swallow brake fluid. See a doctor immediately if you swallow brake fluid.

Make sure that brake fluid does not come into contact with skin, clothing or eyes. Rinse affected areas with plenty of clean water and consult a doctor if necessary.

Always wear gloves and eye protection when topping up brake fluid.

Store brake fluid only in the original closed container and keep it out of the reach of children. Comply with safety regulations when handling brake fluid.

Use only approved brake fluids that comply with the MB Specification for Service Products, Sheet No. 331.0. You must observe the boiling points (DOT 4 plus).

The brake fluid must have the following characteristics in accordance with the FMVSS 116 and ISO 4925 standards:

- boiling point (ERBP) of at least 500 °F(260 °C)
- wet boiling point (WERBP) of at least 356 °F(180 °C)
- viscosity of a maximum of 1500 mm<sup>2</sup>/s

Over a period of time, the brake fluid absorbs moisture from the air. This reduces its boiling point.

#### Warning

If the boiling point of the brake fluid is too low, vapor pockets may form in the brake system when the brakes are subjected to a heavy load (e.g. on long downhill stretches). This would impair braking efficiency. The vehicle's stopping distance may then be longer. This increases the risk of an accident.

Have the brake fluid replaced every **two years** with brake fluid approved by the distributor named on the inside of the front cover and have the replacement confirmed in the Maintenance Booklet.

-  There is usually a notice in the engine compartment to remind you when the next brake fluid change is due.

You can obtain further information from any authorized Sprinter Dealer.

## Change intervals for brake fluid

Service product	Maintenance interval	Product name/number	MB Sheet No.
Brake fluid	2 years	Intac B026E <ul style="list-style-type: none"> <li>• Boiling point: 500 °F(260 °C)</li> <li>• Wet boiling point: 356 °F(180 °C)</li> </ul>	331.0

## Coolant

 **Warning**

Coolant contains glycol and is therefore toxic. Do not swallow the coolant. See a doctor immediately if you swallow coolant.

Make sure that coolant does not come into contact with skin, eyes or clothing. In case of contact with eyes, rinse immediately with plenty of clean water. Clean affected areas of skin and clothing with soap and water immediately. Change any affected clothing immediately.

Coolant is a mixture of water and antifreeze/corrosion inhibitor.

In the coolant, the antifreeze/corrosion inhibitor is responsible for:

- corrosion protection
- antifreeze protection
- raising the boiling point

The coolant must remain in the cooling system all year round for corrosion protection purposes and to increase the boiling point – even in countries with hot climates.

At the factory, the vehicle is filled with a coolant that ensures protection against frost and corrosion and which can be mixed with approved antifreeze/corrosion inhibitors.

**!** Use only approved antifreeze/corrosion inhibitors that comply with the MB Specification for Service Products, Sheet No. 325. Using other, non-approved antifreeze/corrosion inhibitors may cause

damage to the coolant system and reduce the engine's service life.

Check the antifreeze/corrosion inhibitor concentration in the coolant every six months.

When the coolant is being renewed, the coolant must contain 50 % by volume of anticorrosion/antifreeze agent. This provides antifreeze protection down to -34.6 °F(-37 °C).

Do not exceed a proportion of 55 % by volume (antifreeze protection down to approximately -49.0 °F (-45 °C)), otherwise heat dissipation is reduced.

If there is a loss of coolant, do not replenish with water only, but also add an approved corrosion inhibitor/antifreeze agent. The water in the coolant must meet certain requirements, which are often fulfilled by drinking water. If the water quality is not sufficient, you must treat the water.

Observe the MB Specifications for Service Products, Sheet Number 325.

You can obtain further information from any authorized Sprinter Dealer.

## Change intervals for coolant

Service product	Maintenance interval	Product name/number	MB Sheet No.
Coolant, antifreeze/ corrosion inhibitor	every sixth maintenance interval or every 15 years	EURO Peak Coolant/Antifreeze, OLD WORLD INDUSTRIES	325.0
		Zerex G05, The Valvoline Company	325.0
		Zerex G48, The Valvoline Company	325.0
		Glysantin G05, BASF AG	325.0

## Refrigerant

The air-conditioning system uses the refrigerant R-134a. This refrigerant does not damage the ozone layer.

You can obtain further information from any authorized Sprinter Dealer.

Service product	Maintenance interval	Product name/number	MB Sheet No.
Refrigerant	—	Refrigerant R-134a	36 1.0

## Cleaning and care

### General notes

Regular care serves to maintain the value of your vehicle.

It is advisable to use care products from the distributor named on the inside of the front cover. They are designed specifically for Sprinters and represent the state of the art. These care products are available from any authorized Sprinter Dealer.

Do not cover the surface of the radiator or the radiator grill, e.g. with a protective screen. Doing so could cause the engine diagnostics to record false or incorrect data. The recording of specific engine diagnostic data is legally prescribed and must therefore be correct, clear and comprehensible at all times.

### Warning

Always keep care products sealed and out of the reach of children.

Always follow the instructions for use of the care products.

Do not use fuel as a cleaning agent. Fuel is highly flammable and constitutes a health hazard.

### Environmental note

Wash the vehicle only at a properly equipped wash bay. Dispose of empty containers and used cleaning materials in an environmentally-responsible manner.

**⚠ Warning**

Never use openings in the bodywork as steps. You may otherwise damage the vehicle or lose your footing and injure yourself or others.

If you have to clean the upper areas of the vehicle, always use suitable ladders or other secure climbing aids.

**⚠ Warning**

Dirty or iced-up steps and entrances create a risk of slipping or falling.

Keep steps, entrances and footwear free from dirt (e.g. mud, clay, snow and ice).

**Cleaning the interior of the vehicle****Seat belts**

**!** Observe the following notes on cleaning the seat belts:

- Remove any stains or dirt immediately. This will avoid residue or damage.
- Do not bleach or dye the seat belts. This could impair the function of the seat belts.
- Do not dry the seat belts in direct sunlight or at temperatures above 176 °F (80 °C).

**Steering wheel boss and cockpit****⚠ Warning!**

When cleaning the steering wheel boss and dashboard, do not use cockpit sprays or cleaning agents containing solvents. Cleaning agents containing solvents cause the surface to become porous, and as a result, plastic parts may break away and be thrown around the interior when an air bag is deployed, which may result in severe injuries.

Use a damp, clean and lint-free cloth to clean the plastic components and the cockpit. If particularly dirty, use a mild detergent.

**!** Do not use dry, coarse or hard cloths and do not scrub. You could otherwise scratch or damage the surfaces.

**Radio and monitor display**

- ▶ Switch off the radio or rear-view camera monitor and let it cool.
- ▶ Clean the display surface with a commercially available microfiber cloth and cleaner for TFT/LCD displays.
- ▶ After drying, polish the display surface with a dry microfiber cloth, applying only light pressure.

**!** Do not use dry, rough or hard cloths or abrasive products, solvents or cleaning agents containing solvents. Do not scrub. Only apply light pressure when cleaning. Otherwise, you will damage the display surface, as it is sensitive to pressure and susceptible to scratches.

**Windows**

**!** Do not use dry cloths, abrasive products, solvents or cleaning agents containing solvents to clean the inside of the windows. Clean the inside of the windows with a damp cloth or a commercially available glass cleaner.

Do not touch the inside of the rear and side windows with hard objects, e.g. an ice scraper or ring. You could otherwise damage the windows or the rear window defroster.

**Cleaning the exterior of the vehicle****General notes**

Scratches, corrosive deposits, areas affected by corrosion and damage caused by neglect or inadequate care cannot always be completely remedied. In this case, visit a qualified specialist workshop, e.g. the nearest authorized Sprinter Dealer.

**!** In order to avoid consequential damage, repair damage caused by loose chippings and remove any dirt immediately, in particular:

- insect remains
- bird droppings
- flash rust
- tree resin
- oils and grease
- fuels
- tar stains
- salt residue

Wash your vehicle more frequently if it gets dirty more often.

**!** Do not park the vehicle for an extended period right after cleaning it, particularly after having cleaned the wheels with wheel cleaner. Wheel cleaners could cause increased corrosion of the brake discs and brake pads/linings. Generally, park the vehicle at operating temperature after cleaning.

### PARKTRONIC sensors



PARKTRONIC sensors (example: front bumper, left side of vehicle)

- ① Sensors

Clean all the sensors in the front and rear bumpers with water, shampoo and a soft cloth.

**!** Do not use dry, coarse or hard cloths and do not scrub. You will otherwise scratch or damage the sensors.

If you clean the sensors with a power washer or steam cleaner, observe the information provided by the manufacturer regarding the distance to be maintained between the vehicle and the nozzle of the power washer.

### Rear-view camera lens



Rear-view camera in the middle of the roof above the high-mounted brake lamp

- ① Rear-view camera lens
- ② Microphone openings

Make sure not to put any wax on the lens of rear-view camera ① when waxing the vehicle. If necessary, remove the wax using water, shampoo and a soft cloth.

**!** Do not use dry, coarse or hard cloths and do not scrub. You could otherwise scratch or damage the lens of the rear-view camera.

When cleaning the vehicle with a high-pressure or steam cleaner, observe a minimum distance of 1.6 ft (50 cm) to the rear-view camera.

To avoid damaging the rear-view camera, do not aim directly at the rear-view camera or the microphone openings on the bottom of the rear-view camera.

### Outside of the windshield and wiper blades

**⚠ Warning**

Before cleaning the windshield or wiper blades, turn the key to **0** in the ignition lock.

The windshield wipers may otherwise move and injure you.

- ▶ Turn the key to position **0** in the ignition lock or remove it.
- ❗ Do not fold the windshield wipers away from the windshield unless the hood is closed. Otherwise, you could damage the hood.
- ▶ Fold the wiper arms away from the windshield until you feel them engage.
- ▶ Clean the windshield and the wiper blades.
- ▶ Fold the windshield wipers back again before switching on the ignition.

### Headlamps

Wipe the headlamp lenses with a wet sponge.

- ❗ Only use washer fluid which is suitable for plastic lamp lenses. Unsuitable washer fluid could damage the plastic lamp lenses of the headlamps.

Therefore, do not use:

- dry cloths
- abrasive products
- solvents
- cleaning products containing solvents

You could otherwise scratch or damage the surface of the lenses.

### Sliding door

Clean the contact plates and the tips of the contact pins around the sliding door with water, shampoo and a soft cloth.

Do not oil or grease the contact plates and contact pins.

Remove foreign objects.

### Power washers

- ❗ Maintain the following minimum distances between the high-pressure nozzle and the object being cleaned:

- approximately 2.2 ft (70 cm) when using round-jet nozzles
- approximately 1 ft (30 cm) when using 25° flat-spray jets and concentrated-power jets

Keep the water jet moving while cleaning. To avoid causing damage, do not point the water jet directly at:

- door joints
- brake hoses
- electrical components
- plug connections
- seals
- the drive train, especially not at the intermediate bearing of the propeller shaft
- the rear-view camera or the microphone opening on the bottom of the rear-view camera. Keep a minimum distance of 1.6 ft (50 cm).

#### Warning

Do not use round-jet nozzles to clean the tires.

The pulsating water jet can cause damage to the substructure of the tires that is not visible from the outside. This type of damage only becomes noticeable at a much later stage and can cause the tires to burst. This could cause you to lose control of the vehicle, resulting in an accident and injuring yourself or others. Replace damaged tires immediately.

### Automatic car wash

If the vehicle is very dirty, prewash it before you put it through an automatic car wash.

#### Warning

If a wax preservative is applied after the vehicle is washed, you should remove the wax

from the windshield and the wiper blades to prevent smearing. Smears impair the driver's view, and their effect is made worse in conditions where visibility is poor (e.g. glare, mist, darkness, snow). You may therefore fail to recognize dangers, or not recognize them in time, and thereby cause an accident.

- ❗ Make sure that the automatic car wash is suitable for the size of the vehicle.

Before washing the vehicle in an automatic car wash, fold in the exterior mirrors and remove the radio/telephone antenna.

Otherwise, the exterior mirror, antenna or the vehicle itself could be damaged.

Make sure that the antenna is installed and that the exterior mirrors are fully folded out again when you leave the automatic car wash.

- ❗ Make sure that the side windows are completely closed, that the ventilation/heating is switched off and that the windshield wiper switch is set to **0**. Otherwise, the rain/light sensor could be activated, triggering unintended wiper movements. This can cause damage to the vehicle.

After putting the vehicle through an automatic car wash, wipe off wax from:

- the rear-view camera lens (▷ page 163)
- the windshield and the wiper blades. This prevents smears and reduces wiping noise which can be caused by residue on the windshield.

### Cleaning the engine

- ❗ Water must not enter intake or ventilation openings. When cleaning with high pressure water or steam cleaners, the spray must not be aimed directly at electrical components or the terminals of electrical lines.

Preserve the engine after the engine has been cleaned. Protect the belt drive system from exposure to the preservative agent.

### Alloy wheels

Clean the alloy wheels regularly.

- ❗ Do not use any acidic or alkaline cleaning agents. They can cause corrosion on the wheel bolts (wheel nuts) or the retainer springs for the wheel-balancing weights.

### After driving off-road or on construction sites

#### Warning

Dirt on the vehicle can affect road and operating safety.

#### It can specifically result in the following dangers:

**Stone impact.** Stones trapped between the tires can be thrown out while driving. This could injure other road users or damage other vehicles (especially windscreens).

**Risk of skidding.** Dirt and mud on the tires/on the road reduce the grip of the tires on the road. This especially applies when the surface is wet. The vehicle could then start to skid.

**Risk of injury.** Dirt and mud on the steps and entrance can make the steps unsafe. This could cause you to slip off the steps and be injured.

For this reason, you should always clean your vehicle carefully after driving off-road or on construction sites before driving on public roads. Observe the corresponding safety notices in this chapter if you use a power washer or an automatic car wash to clean your vehicle.

- ▶ Clean the vehicle, paying special attention to the following:
  - Lighting system
  - Windows and exterior mirrors
  - Access steps and entrances

- Grab handles
  - Wheels, tires and wheel arches
  - License plates
- ▶ Remove any trapped foreign objects, e.g. stones.
- ▶ Check the wheel suspension for damage.

### Warning

Dirty brake discs and brake pads/linings can impair braking performance (up to the point of total failure). This could lead to an accident. Check the brake system for operating safety by testing the brakes before driving the vehicle on public roads.

In the event of impaired braking, stop the vehicle while paying attention to the traffic conditions and contact a qualified specialist workshop which has the necessary specialist knowledge and tools for the work required.

For this, we recommend an authorized Sprinter Dealer. In particular, work relevant to safety or on safety-related systems must be carried out at a qualified specialist workshop.

After driving in mud, sand, water or in similar conditions:

- check the brake system for operating safety.
- clean the wheels, chassis and brake system.
- check the wheels, chassis and brake system for damage. Have any damage repaired at a qualified specialist workshop, e.g. an authorized Sprinter Dealer.

## Maintenance

### General notes

The scope and regularity of the maintenance work primarily depend on the often diverse operating conditions.

The vehicle Maintenance Booklet describes the scope and frequency of maintenance work and contains additional notes on the

New Vehicle Limited Warranty and on service products.

Specialist knowledge beyond the scope of these Operating Instructions is required when carrying out testing and maintenance work. Have this work carried out by trained personnel.

-  Maintenance services must be carried out in accordance with the provisions and recommendations in the Maintenance Booklet.

Not doing so could void the warranty claim and lead to refusal of goodwill gestures after the manufacturer has submitted a damage report.

### Warning

Before carrying out maintenance operations and repairs, you must read the sections referring to maintenance operations and repairs:

- this includes relevant sections of the technical documentation, such as the operating instructions and workshop information.
- you should also familiarize yourself with the legal requirements, such as work safety regulations and accident prevention measures.

You could otherwise fail to recognize dangers and thereby injure yourself or others.

You must secure the vehicle on axle stands of sufficient load bearing capacity if work is being carried out beneath it.

Never use the vehicle jack instead of stands. The jack could slip and the vehicle could drop. This could result in serious injury to yourself or others.

The vehicle jack is intended only to raise the vehicle for a short time.

Always have maintenance work carried out at a qualified specialist workshop. The workshop must have the necessary specialist knowledge and tools to carry out the work required. For this, we recommend an



authorized Sprinter Dealer. All work relevant to safety or on safety-related systems must be carried out at a qualified specialist workshop.

Observe the notes on parts in the "Technical data" section (▷ page 276).

### Environmental note

Observe measures to protect the environment when working on the vehicle. You must observe the legal requirements when disposing of service products, e.g. engine oil. This also includes all components, e.g. filters, which have come into contact with service products.

Any qualified specialist workshop, e.g. an authorized Sprinter Dealer, can provide information about this.

Dispose of empty containers, cleaning cloths and care products in an environmentally-responsible manner. Comply with the instructions for use of the care products.

Do not run the engine for longer than necessary when the vehicle is stationary.

### Active Service System (ASSYST)

The ASSYST service indicator informs you of the next service due date.

A service that is due is displayed about a month in advance. A message is then displayed while the vehicle is in motion or while the ignition is switched on.

**i** Periods when the battery is disconnected will not be recorded by ASSYST. To make sure that you have the vehicle serviced at the correct time, you should therefore subtract periods when the battery is disconnected from the days shown.

The service indicator does not provide information about the oil level. The service indicator should therefore not be confused with the  engine oil level display.

**i** The service due date is displayed in days or miles (kilometers), depending on the total distance driven.

The symbols or letters in the service indicator show the service due.



 or **A** for a minor service

 or **B** for a major service

### Service due date indicator



#### Vehicles with steering wheel buttons

The following messages may be displayed:

-  Service A in ... days
-  Service A in ... mi (km)
-  Service A due now

#### Vehicles without steering wheel buttons

The following messages may be displayed:

-  for service A
-  for service B



Additionally you will see the remaining distance in miles (**mi**) or kilometers (**km**) or the remaining time in days (**d**).

### Service due date exceeded

A qualified specialist workshop, e.g. an authorized Sprinter Dealer, resets the service indicator when the service has been carried out.



#### Vehicles with steering wheel buttons

If you have missed the service due date, one of the following messages appears in the display:

-  Service A overdue by ... days
-  Service A overdue by ... mi (km)

Additionally a warning tone sounds.

#### Vehicles without steering wheel buttons







If the service due date has been exceeded, ten seconds after switching on the ignition the  or  symbol flashes for the

service. You will also see a minus sign before the service due date.



### Calling up the service due date

- ▶ Turn the key to position **2** in the ignition lock.  
The display is activated.

### Vehicles with steering wheel buttons

- ▶ Press the  or  button on the steering wheel repeatedly until you see the standard display (▷ page 77).
- ▶ Press the  or  button on the steering wheel repeatedly until you see the following in the display, for example:
  -  Service A in ... days
  -  Service A in ... mi (km)

### Vehicles without steering wheel buttons

- ▶ Press the  menu button on the instrument cluster repeatedly until the  or  symbol for the service appears.  
Additionally you will see the remaining distance in miles (mi) or kilometers (km) or the remaining time in days (d).

## Hood

### Opening the hood

#### Warning

Do not pull the release lever while the vehicle is in motion. If you do so, the hood may open up and block your view.

#### Warning!

There is a risk of injury if the hood is open, even if the engine is not running.  
Some engine components can become very hot.

To avoid the risk of burns, only touch those components described in the Operator's Manual and observe the relevant safety notes.

#### Warning

The radiator fan between the radiator and the engine can start automatically, even if the key has been removed from the ignition lock. Keep away from the area of rotation of the fan blades. You could otherwise be injured.

The electronic injector control operates at high voltage. For this reason, you must never touch injection system components while:

- the engine is running.
- the engine is being started.
- the ignition is switched on.

You could otherwise receive an electric shock and be severely or fatally injured.



Hood release lever in the driver's footwell

- ▶ Pull release handle ①.  
The hood is released.

- ❗ Make sure that the windshield wipers are not folded away from the windshield. You could otherwise damage the windshield wipers or the hood.

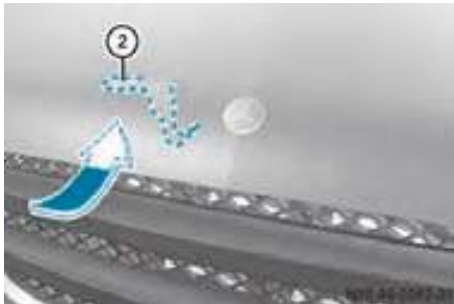

- ▶ Push hood catch release handle ② upwards.



- ▶ Swing the hood upwards until support strut ③ engages and the hood is supported.

### Closing the hood

#### Warning

When closing the hood be careful that nobody becomes trapped.

- ▶ Lift the hood slightly.
- ▶ Press support strut ③ towards the back.

**!** When you press the support strut back, make sure that you do not press it against the detent position and cause it to bend.

- ▶ Lower the hood and let it drop shut from a height of approximately 1 ft (30 cm). The hood engages audibly. If the hood can be raised slightly, it is not properly engaged.
- ▶ If the hood is not properly engaged, open it once more and allow it to drop shut from a slightly greater height.

**!** Do not use your hands to push the hood down. You could damage it otherwise.

### Maintenance points under the hood

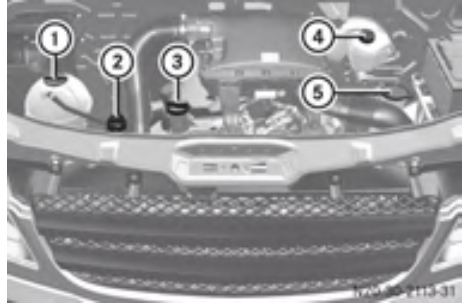

- ① Coolant tank cap (▶ page 169)
- ② Diesel Exhaust Fluid (DEF) filler neck cap<sup>4</sup>(▶ page 143)
- ③ Engine oil filler neck cap (▶ page 171)
- ④ Brake fluid reservoir cap (▶ page 170)
- ⑤ Washer fluid reservoir cap (▶ page 171)

### Coolant level

Only add coolant with the vehicle standing on a level surface and with the engine switched off. The coolant temperature must have dropped below 122 °F (50 °C).



#### Warning

When opening the coolant expansion tank, there is a risk of scalding from hot coolant spraying out. The cooling system and the coolant expansion tank are pressurized when the engine is at normal operating temperature. Wear gloves and eye protection.

<sup>4</sup> Only on Cargo Van/Passenger Van.

Only open the coolant expansion tank when the coolant temperature is below 122 °F (50 °C).

### Warning

Coolant contains glycol and is therefore toxic. Do not swallow the coolant. See a doctor immediately if you swallow coolant.

Make sure that coolant does not come into contact with skin, eyes or clothing. In case of contact with eyes, rinse immediately with plenty of clean water. Clean affected areas of skin and clothing with soap and water immediately. Change any affected clothing immediately.

- ▶ Slowly turn cap ① counter-clockwise and allow the excess pressure to escape.
- ▶ Turn cap ① further and remove it.
- ▶ Add coolant until it is at the **MAX** mark. Observe the correct coolant mixture ratio and the required water quality (▷ page 160).
- ▶ Replace cap ① and tighten it until the stop.

- ❗ Check the cooling and heating system regularly for leaks.

If a large quantity of coolant is lost, have the cause traced and rectified at a qualified specialist workshop, e.g. an authorized Sprinter Dealer.

## Clutch mechanism and brake system

### Warning

Brake fluid is hazardous to health. Do not swallow brake fluid. See a doctor immediately if you swallow brake fluid.

Make sure that brake fluid does not come into contact with skin, clothing or eyes. Rinse affected areas with plenty of clean water and consult a doctor if necessary.

Always wear gloves and eye protection when topping up brake fluid.

Store brake fluid only in the original closed container and keep it out of the reach of children. Comply with safety regulations when handling brake fluid.

### Warning

If the boiling point of the brake fluid is too low, vapor pockets may form in the brake system when the brakes are subjected to a heavy load (e.g. on long downhill stretches). This would impair braking efficiency. The vehicle's stopping distance may then be longer. This increases the risk of an accident.

Have the brake fluid renewed every two years.

The brake fluid reservoir is located in the engine compartment.

Check the brake fluid level:

- regularly, e.g. weekly or when refueling
  - only with the vehicle standing on a level surface and with the engine switched off
- ❗ Brake fluid corrodes paint, plastic and rubber. If paint, plastic or rubber has come into contact with brake fluid, rinse with water immediately.

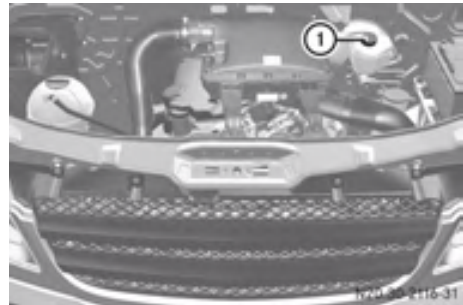

- ① Brake fluid reservoir cap

The brake fluid level must be between the **MIN** and **MAX** marks.

- ❗ If the brake fluid does not reach the **MIN** mark, the vehicle's hydraulic system could be faulty. Do not add brake fluid under any circumstances. This will not rectify the malfunction.

Do not drive any further.

Have the system checked immediately at a qualified specialist workshop, e.g. at an authorized Sprinter Dealer.

- 1 There is usually a notice in the engine compartment to remind you when the next brake fluid change is due.

### Windshield washer system/ headlamp cleaning system

Add windshield washer concentrate to the washer fluid all year round.

#### Warning

Windshield washer concentrate is highly flammable.

Fire, naked flames and smoking are therefore prohibited when you are handling windshield washer concentrate.

- ! Only use washer fluid concentrate which is suitable for plastic lenses. Unsuitable washer fluid concentrate could damage the plastic lenses of the headlamps.

Adapt the mixing ratio to the ambient temperature. If the temperature is above freezing, use Summerwash to prevent smearing. If there is a risk of frost, use Winterwash to prevent the water from freezing on the windshield.

The washer fluid reservoir has a capacity of approximately 6.3 US qt (6.0 l).

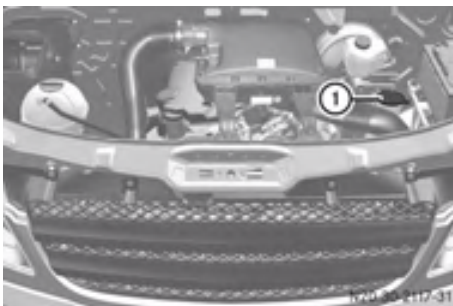

- ▶ Mix the washer fluid to the appropriate mixing ratio in a container beforehand.
- ▶ Remove washer fluid reservoir cap ①.

- ▶ Add washer fluid.
- ▶ Replace cap ①.

### Engine oil level

You will find information about engine oil consumption in the "Driving tips" section (> page 141).

Check the engine oil level on a regular basis, e.g. weekly or each time you refuel.

### Checking the engine oil level in the display

Depending on the vehicle's equipment, in vehicles with a diesel engine, the engine oil level is shown in the display.

Only check the engine oil level when the engine is at operating temperature.

- ▶ Park the vehicle on a level surface.
- ▶ Switch off the engine.
- ▶ Wait for five minutes.

- ▶ Turn the key to position **2** in the ignition lock.



The display is activated.

- i If at extremely low temperatures no engine oil level is displayed after five minutes, repeat the engine oil level check after a further five minutes.

If an oil level reading is still not displayed, check the engine oil level with the dipstick.

Have the oil level display checked at a qualified specialist workshop, e.g. at an authorized Sprinter Dealer.

### Vehicles without steering wheel buttons

- ▶ Press the  menu button on the instrument cluster repeatedly until the display shows the  symbol. The -- : -- display flashes while the oil level is being measured.

The following messages may be displayed:

	
OK	▶ Do not add oil.
- 1.0 qts	▶ Add the amount of oil shown (▷ page 173). ▶ Check the engine oil level again after a few minutes.
- 1.5 qts	
- 2.0 qts	
HI	▶ Have excess oil removed. The oil level is too high.

Measurement units in the display:

- qts USA only
- ltr Canada only

#### Vehicles with steering wheel buttons

- ▶ Press the  button on the instrument cluster (▷ page 70).

The following message is displayed for the duration of the measurement process:

 Engine oil level Measuring in progress

The following messages may be displayed:

	
Engine oil level OK	▶ Do not add oil.
Engine oil Add 1.0 quart	▶ Add the amount of oil shown (▷ page 173). ▶ Check the engine oil level again after a few minutes.
Engine oil Add 1.5 quarts	
Engine oil Add 2.0 quarts	

Engine oil level Reduce oil level

- ▶ Have excess oil removed. The oil level is too high.

Eng. oil lev. Turn ignition on for level

- ▶ Turn the key to position **2** in the ignition lock.

Observe wait. period

- ▶ Repeat the measurement after about five minutes if the engine is at normal operating temperature.
- ▶ Repeat the measurement after about 30 minutes if the engine is not at normal operating temperature.

Engine oil level Not when eng. running

- ▶ Switch off the engine and wait for approximately five minutes, if the engine is at normal operating temperature, before performing the measurement.

Measurement units in the display:

- quart(s) USA only
- liter(s) Canada only

#### Checking the engine oil level using the dipstick

Vehicles with a red oil dipstick: only check the oil level when the engine is at normal operating temperature.

- ▶ Park the vehicle on a level surface.
- ▶ Switch off the engine.
- ▶ Wait for five minutes.

Vehicles with a yellow oil dipstick: only check the oil level when the engine is cold.

- ▶ Park the vehicle on a level surface.

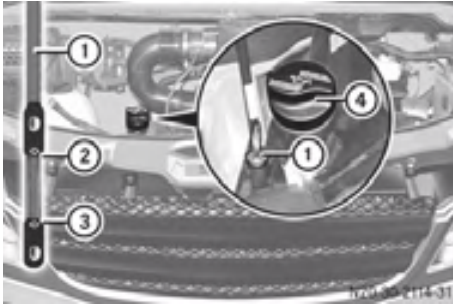

- ▶ Pull out oil dipstick ①.
- ▶ Wipe oil dipstick ① using a lint-free cloth.
- ▶ Reinsert oil dipstick ① into the dipstick tube to the stop and remove it again.
- ▶ Check the oil level on oil dipstick ①. The oil level must be between **MIN** mark ③ and **MAX** mark ②. The difference in quantity between marks ② and ③ is approximately 2 US quarts (2 l).
- ▶ Add engine oil if necessary.

### Adding engine oil

You will find information about approved engine oils in the "Service products" section (> page 156).

- ▶ Unscrew cap ④ of the filler neck and remove it.
- ⚠ The alternator is located below the engine oil filler neck. If engine oil spills onto the alternator, there is a danger of alternator damage. Be very careful when adding engine oil.
- ▶ Add the amount of oil required.
- ⚠ Do not add too much oil. If the oil level is above the **MAX** mark on the dipstick, too much oil has been added. This can lead to

engine damage or catalytic converter damage. Have excess oil siphoned off.

### Environmental note

When adding oil, take care not to spill any. If oil enters the soil or waterways, it is harmful to the environment.

- ▶ Place cap ④ on the filler neck and tighten.

### Air filter for the rear-compartment air conditioning

An increased amount of sand or dust may collect in the air filter when you drive on dusty or sandy roads.



Air filter in the roof in the rear compartment

- ⚠ If the air filter is visibly dirty, it must be cleaned or replaced. The dirt can otherwise damage the air-conditioning system. Such damage is not covered by the New Vehicle Limited Warranty.

For this reason, check the air filter regularly for visible dirt.

- ▶ **To remove the air filter:** carefully prize cover ① out of recesses ② and remove.
- ▶ Remove the filter mat.
- ▶ **To clean the filter mat:** wash the filter mat with clear water.
- ▶ Leave the filter mat to dry.

- ⓘ The filter mat must not be cleaned or dried in a machine.

- ▶ **To install the air filter:** insert the filter mat.
- ▶ Put cover ① on.

### Vehicle assemblies

Check the assemblies regularly for leaks. If fluid is being lost (e.g. there are oil stains where the vehicle is parked), have the cause found and rectified immediately at a qualified specialist workshop, e.g. an authorized Sprinter Dealer.

### 🌿 Environmental note

When used improperly, service products are harmful to the environment.

Do not allow service products to enter the sewage system, surface waters, ground water or soil.

### Replacing the wiper blades

#### ⚠ Warning

If the windshield wipers are set to intermittent wipe or the rain/light sensor is active, the windshield wipers could start moving at any time and injure you or others.

Always remove the key from the ignition lock before replacing the wiper blades.

#### ⚠ Warning

Wiper blades are wear parts. Change the wiper blades every six months, ideally in the spring and fall. Otherwise, the windshield and rear window will not be wiped properly. This may prevent you from observing the traffic conditions, thereby causing an accident.

- ❗ Do not open the hood when a wiper arm is folded away from the windshield. Otherwise, you could damage the hood.
- Do not fold the wiper arms back onto the windshield without wiper blades fitted as this could scratch the windshield.

- ❗ Only touch the windshield wiper where it connects to the wiper arm. You could otherwise damage the wiper blade inserts.

### Removing

- ▶ Apply the parking brake.
- ▶ On vehicles with automatic transmission, move the selector lever to position **P**.
- ▶ Turn the key to position **1** in the ignition lock.

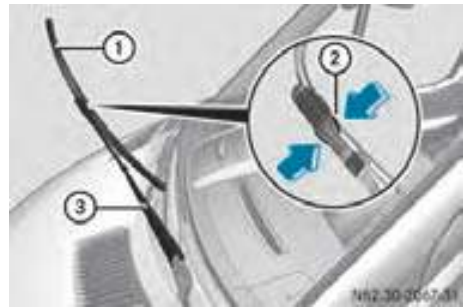

Front wiper arm with windshield wiper

- ▶ Fold wiper arm ③ away from the windshield.
- ▶ Set windshield wiper ① at right angles to the wiper arm.
- ▶ Press two retaining clips ② together in the direction of the arrow and swing windshield wiper ① away from wiper arm ③.
- ▶ Pull windshield wiper ① up and out of the retainer on wiper arm ③.

### Installing

- ▶ Slide windshield wiper ① into the retainer on wiper arm ③.
- ▶ Press windshield wiper ① onto wiper arm ③ until you hear retaining clips ② engage.
- ▶ Fold wiper arm ③ onto the windshield again.



## Batteries

 Warning

Risk of explosion. Explosive oxyhydrogen is produced when batteries are being charged. Only charge batteries in well-ventilated areas.



Risk of explosion. Avoid creating sparks. Avoid naked flames and do not smoke in the vicinity of the battery.



Battery acid is caustic. Wear acid-proof protective gloves. If skin or clothes are splashed with acid, neutralize the splashes immediately with soapy water or an acid neutralizer, and then clean the affected areas with water.



Wear eye protection. When mixing water and acid, the liquid can splash into your eyes. Rinse acid splashes to the eyes immediately with clean water and contact a doctor immediately.



Keep children at a safe distance. Children are not able to assess the dangers posed by batteries and acid.

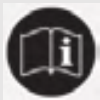

When handling batteries, observe the safety precautions and special protective measures contained in these Operating Instructions.

 Environmental note

Batteries contain pollutants. It is against the law to dispose of them with the household garbage. They must be collected separately and recycled to protect the environment.



Dispose of batteries in an environmentally responsible manner. Take discharged batteries to a qualified specialist workshop, e.g. an authorized Sprinter Dealer, or to a special collection point for old batteries.

In order for the batteries to achieve their maximum possible service life, they must always be sufficiently charged.

Have the battery charge checked more frequently if you use the vehicle mainly for short trips or if you leave it parked up for a lengthy period.

If you intend to leave your vehicle parked up for a long period, seek advice from an authorized Sprinter Dealer or switch off the electrical system using the battery isolating switch (▷ page 87).

Your vehicle may be equipped with two batteries, depending on the equipment version:

- a starter battery in the battery case in the driver's footwell
- an additional battery in the engine compartment

Have the batteries removed at a qualified specialist workshop which has the necessary specialist knowledge and tools to carry out the work required. We recommend that you use an authorized Sprinter Dealer for this purpose.

## Disconnecting the battery

### Warning

There is a risk of a short circuit if the positive terminal of the connected battery comes into contact with any part of the vehicle. This could cause the flammable gas mix to ignite. You and others could be seriously injured.

- Do not place any metal objects or tools on the batteries.
- When disconnecting the batteries, always disconnect the negative terminal clamp before the positive terminal clamp.
- When connecting the batteries, always connect the positive terminal clamp before the negative terminal clamp.
- Do not disconnect or connect the batteries when the engine is running.

**!** Switch off the engine and remove the key from the ignition lock before you loosen or disconnect the terminal clamps. You may otherwise destroy electronic components such as the alternator.

Always disconnect the starter battery in the battery case in the driver's footwell first.

**!** Always disconnect the battery in the order described below. Never swap the terminal clamps. You may otherwise damage the vehicle electronics.

- ▶ Switch off all electrical consumers.

## Disconnecting the starter battery

The starter battery is located in the battery case in the driver's footwell.

## Removing/installing the floor covering in the driver's footwell

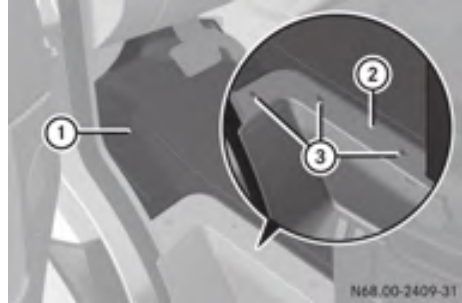

- ▶ **To remove:** remove screws ③ and take off trim ②.
- ▶ Remove floor covering ①.
- ▶ **To install:** replace floor covering ① in the driver's footwell.

### Warning

Free movement of the pedals must not be impaired. This would otherwise jeopardize the operating and road safety of the vehicle.

Make sure that the floor covering is pushed under the carrier of the accelerator pedal and cannot slide between the carrier and the accelerator pedal when you install it.

This would otherwise prevent you from depressing the accelerator pedal completely, thereby restricting your vehicle's acceleration, e.g. during overtaking.

- ▶ Slide floor covering ① underneath the carrier for the accelerator pedal and align it at the base of the driver's seat and at the door sill.

Make sure that the floor covering does not obstruct the accelerator pedal.

- ▶ Put trim ② in place and screw the screws ③ back in.

## Removing the battery cover in the driver's footwell

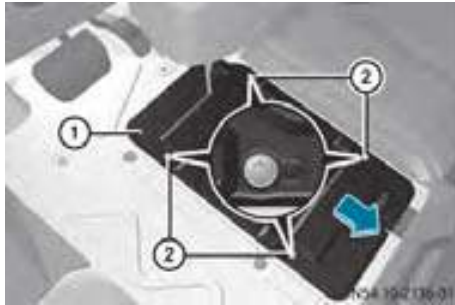

- ▶ Remove screws ② and slide cover ① in the direction of the arrow. The screws must protrude beyond the recesses.
- ▶ Remove cover ① upwards.



### Starter battery in the driver's footwell

- ▶ First loosen and remove the negative terminal clamp so that it is no longer in contact with the terminal.
- ▶ Remove the cover from the positive terminal.
- ▶ Loosen the positive terminal clamp and fold it up to the side together with the pre-fuse box.

## Disconnecting the additional battery

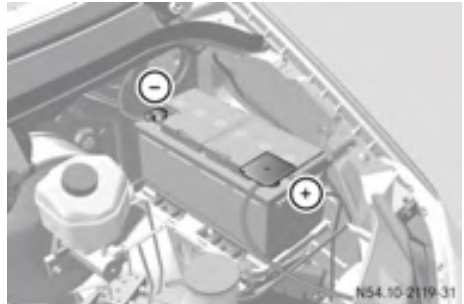

### Additional battery in the engine compartment

- ▶ Remove the key from the ignition lock.
- ▶ Open the hood (▷ page 168).
- ▶ First loosen and remove the negative terminal clamp so that it is no longer in contact with the terminal.
- ▶ Remove the cover from the positive terminal.
- ▶ Loosen and remove the positive terminal clamp.

## Removing the battery

### Starter battery

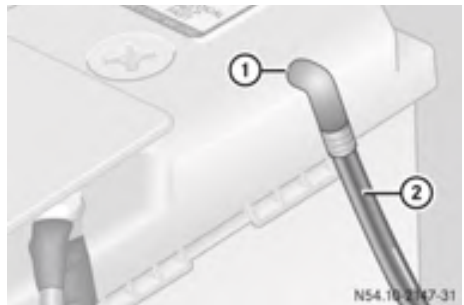

- ▶ Disconnect the battery (▷ page 176).
- ▶ Pull breather hose with connector bracket ② from connection ① on the degassing cover.



- ▶ Loosen the bolts holding retainer ③, which prevents the battery from moving around.



- ▶ Pull retainer ③ upwards and slide the battery out of its anchorage in the direction of travel.
- ▶ Fold the bar upwards and remove the battery from the battery case.

### Additional battery in the engine compartment

- ▶ Disconnect the battery (▷ page 177).
- ▶ Loosen the bolts holding the retainer that prevents the battery from moving around.
- ▶ Remove the battery holder and take out the battery.

### Charging the battery

#### Warning

Only charge the battery in a well-ventilated area. As the battery is being charged, gases can escape and generate minor explosions, which can injure you and others or may cause

damage to the paintwork or acid corrosion on the vehicle.

There is a risk of acid burns during the charging process due to the gases which escape from the battery. Do not, therefore, lean over the battery while it is being recharged.

- ▶ Recharge the removed battery. Observe the notes in the operating instructions for your battery charger.
- ▶ Follow the above steps in the reverse order to install the battery again.

**!** Only charge the installed battery with a battery charger that has been tested and approved by the distributor named on the inside front cover. This device allows the battery to be charged when it is installed in the vehicle. The vehicle's electronics system may otherwise be damaged.

**i** It is also possible to charge the starter battery using the jump-starting connection point in the engine compartment (▷ page 247).

### Reconnecting the battery

**!** Always connect the battery in the order described below. Never mix up the terminal clamp disconnection/connection order and never mix up the terminal clamps. You may otherwise damage the vehicle electronics.

- ▶ Switch off all electrical consumers.
- ▶ Connect the positive terminal clamp.
- ▶ Attach the cover to the positive terminal.
- ▶ Connect the negative terminal clamp.

**i** After the battery has been reconnected, you must reset the side windows (▷ page 61).

## Battery care

---

- !** Please always observe the following notes:
- dirty battery clamps and battery surfaces cause leak currents, which lead to the batteries discharging. Always keep the battery terminals and battery surfaces clean and dry. Grease the battery terminals, particularly the terminal undersides, with a light coating of acid-resistant grease.
  - cleaning agents containing fuel corrode the battery housing. Only clean the battery housing with commercially available cleaning agents.
  - only clean the batteries when the caps are screwed on. Dirt may otherwise enter the battery cells and damage the battery.
  - the breathers in the caps and the cell ventilation tubes must be open. Otherwise, gas cannot escape. Unscrew blocked breathers and clean them with a suitable tool such as a piece of wire. If you do not unscrew the caps for cleaning, there is a risk of short circuit.
  - regularly check the battery terminals and the fastening of the negative cable to the chassis to ensure that they are firmly seated.
  - if batteries are not being used, you should charge them once a month.



Vehicle equipment .....	182
Where will I find...? .....	182
Troubleshooting .....	187
Engine .....	221
Wheels and tires .....	221
Electrical system .....	233
Batteries for the remote control .....	245
Automatic transmission .....	246
Jump starting, tow-starting and towing away .....	247

## Vehicle equipment

- i** Diese Betriebsanleitung beschreibt alle Modelle, Serien- und Sonderausstattungen Ihres Fahrzeugs, die zum Zeitpunkt des Redaktionsschlusses dieser Betriebsanleitung erhältlich waren. Länderspezifische Abweichungen sind möglich. Beachten Sie, dass Ihr Fahrzeug nicht mit allen beschriebenen Funktionen ausgestattet sein könnte. Dies betrifft auch sicherheitsrelevante Systeme und Funktionen.

## Where will I find...?

### Vehicle tool kit and emergency equipment

The jack and the vehicle tool kit are located in the co-driver's footwell.

#### Warning

To reduce the risk of serious or fatal injuries and to avoid damage to the vehicle, observe the following:

- the jack is designed only to raise the vehicle for a short time, e.g. while a wheel is being changed. It is not designed to enable work to be carried out underneath the vehicle.
- the jack must be placed on a firm, level surface.
- never change a wheel on uphill or downhill gradients.
- never lie under the raised vehicle.
- make sure that no persons are present in the vehicle when the vehicle is raised.
- never start the engine when the vehicle is raised.

- make sure that the distance between the underside of the tires and the ground does not exceed 1.2 in (30 mm).
- if you intend to work under the vehicle, place the vehicle on stands.

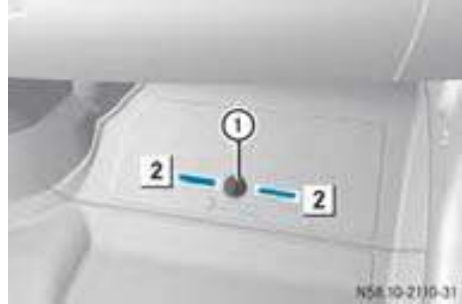

- ▶ **To unlock:** turn quick-release fastener ① counter-clockwise or clockwise ②.
- ▶ Remove the cover.
- ▶ **To lock:** press quick-release lock ① down until it engages.

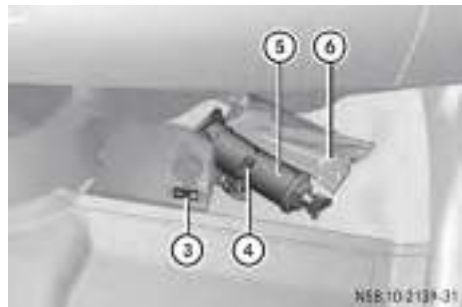

- ▶ If necessary, use tool<sup>5</sup> ③ for the DEF tank fuel filler cap to remove the fixture.
- ▶ Remove vehicle tool kit ⑥.
- ▶ Pull up quick-release lever ④ and unhook the retaining strap of jack ⑤.
- ▶ Lift jack ⑤ upwards out of the holder.

- i** When stowing away the jack, place it in the holder as shown in the illustration. Make sure that the retaining strap of the jack is hooked in and tensioned.

<sup>5</sup> Chassis only.



### Warning lamp

The warning lamp is behind the cover in the storage compartment of the driver's door.

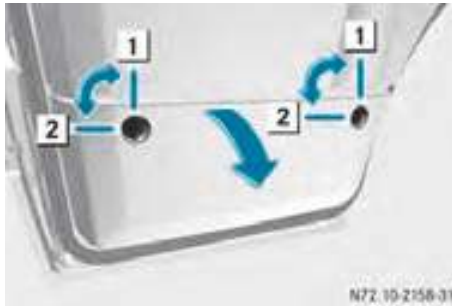

- 1 Locked
- 2 Unlocked



- ▶ Unlock quick-release fasteners 2 and fold out the cover.
- ▶ Take warning lamp 3 out of the retainer.

### Warning triangle

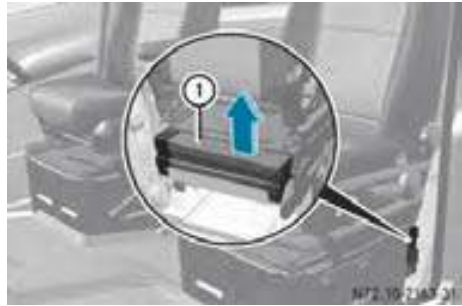

Warning triangles at the back of the driver's seat base

- 1 Warning triangles
- ▶ Pull warning triangles 1 up and out of the holder.

### Wheel chock

#### Cargo Van/Passenger Van

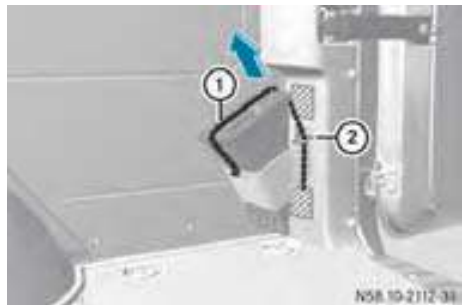

Wheel chock in the load/passenger compartment

- ▶ Pull restraining cable 1 down slightly and then remove it from bracket 2.
- ▶ Remove the chock.
- i** When stowing it away, make sure that the chock is secured in the retainer by the restraining cable.

## Chassis Cab

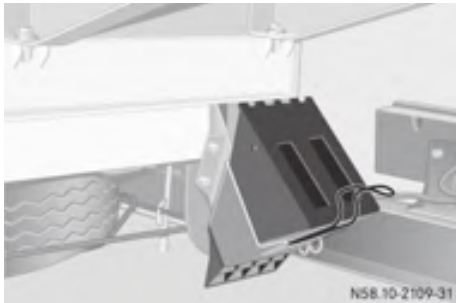

Wheel chock on the left-hand side of the vehicle

- ▶ Pull the retainer spring downwards and remove the chock.
- ❶ When stowing it away, make sure that the chock is secured in the retainer by the retainer springs.

## First-aid kit

The first-aid kit is located in the stowage compartment in the co-driver's door.

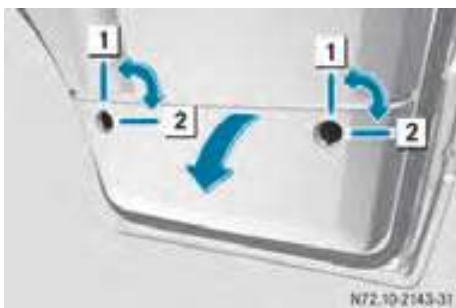

- ❶ Locked
- ❷ Unlocked



- ❸ First-aid kit
- ▶ Unlock quick-release fasteners ❷ and fold out the cover.
- ❶ Check the expiration date of the first-aid kit annually, and replace the contents when necessary.

## Fire extinguisher

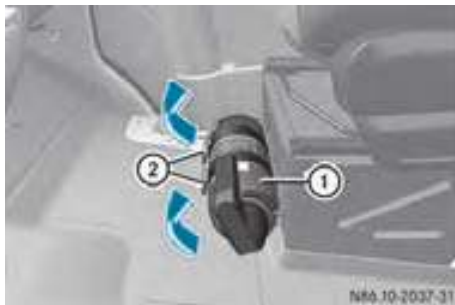

Fire extinguisher at the front of the base of the co-driver's seat

- ▶ Pull shackles ❷ upwards.
- ▶ Take fire extinguisher ❶ out of its holder.
- ❶ Please read the instructions on the fire extinguisher carefully and familiarize yourself with its operation.

## Tire sealant

The Premium tire sealant is located in the stowage compartment in the right-hand door sill.

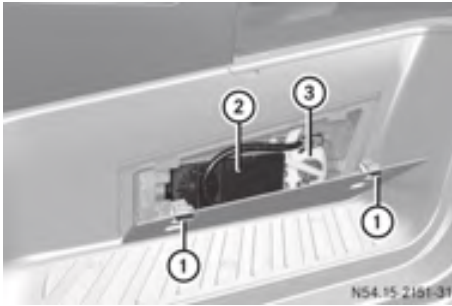

- ① Catch spring
- ② Electric air pump
- ③ Premium tire sealant

### Spare wheel

If you are replacing the tires on the vehicle, you may use the spare wheel as a road wheel provided that:

- the tire is no more than six years old.
- the wheel and tire are of the prescribed design.

The spare wheel is located in a spare wheel bracket under the rear of the vehicle.

**!** Check the spare wheel regularly to see that it is secure and has the prescribed tire pressure.

### Cargo Van/Passenger Van

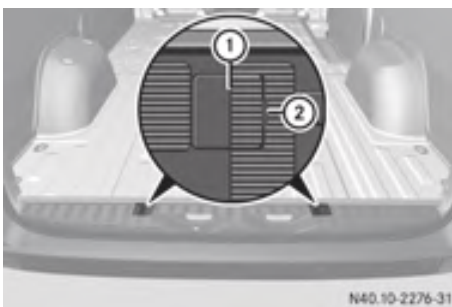

- ▶ Open the tailgate.
- ▶ Apply a screwdriver to recesses ② and then pry off covers ①.
- ▶ Using the lug wrench from the vehicle tool kit (▷ page 182), unscrew the now visible bolts by approximately 20 turns counter-clockwise.

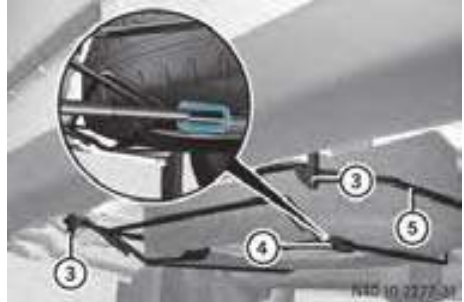

- ▶ Slightly raise spare wheel bracket ⑤ and unhook left-hand safety catch ③.
- ▶ Assemble the pump lever for the jack and slide it into sleeve ④ on spare wheel bracket ⑤.
- ▶ Raise spare wheel bracket ⑤ with the pump lever and unhook right-hand safety catch ③.
- ▶ Slowly lower spare wheel bracket ⑤ down to the ground.
- ▶ Lift spare wheel bracket ⑤ slightly and pull the pump lever out of sleeve ④.



- ▶ Use the pump lever to lever the spare wheel beyond the rear of the spare wheel bracket.
- ▶ Carefully remove the spare wheel from the bracket.

### Warning

When the spare wheel is removed, the center of gravity changes due to the heavy weight of the wheel. The spare wheel could slip off or tip and cause injury to yourself or others. Pull the spare wheel out carefully. Take care not to trap your fingers when lifting out the spare wheel.



- ▶ Use the pump lever to lever the spare wheel beyond the rear of the spare wheel bracket.
- ▶ Carefully remove the spare wheel from the bracket.

### Warning

When the spare wheel is removed, the center of gravity changes due to the heavy weight of the wheel. The spare wheel could slip off or tip and cause injury to yourself or others. Pull the spare wheel out carefully. Take care not to trap your fingers when lifting out the spare wheel.

## Cab chassis

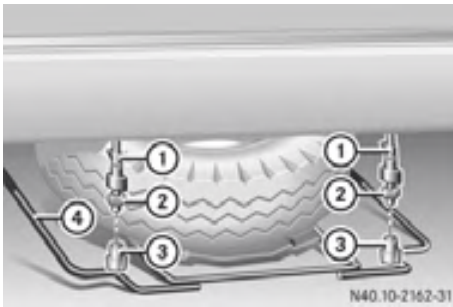









- ▶ Loosen fender nuts ③ manually and then remove them.
- ▶ Loosen nuts ② as far as the thread end.
- ▶ Slightly raise spare wheel bracket ④ and unhook left-hand safety catch ①.
- ▶ Assemble the pump lever for the jack and slide it into sleeve on the right-hand side of spare wheel bracket ④.
- ▶ Raise spare wheel bracket ④ with the pump lever and unhook right-hand safety catch ①.
- ▶ Slowly lower spare wheel bracket ④ down to the ground.
- ▶ Lift spare wheel bracket ④ slightly and pull the pump lever out of sleeve.



Troubleshooting











Indicator and warning lamps in the instrument cluster







 **Warning**

The operating safety of your vehicle could be jeopardized if maintenance work is carried out incorrectly. As a result, you could lose control of the vehicle and cause an accident. In addition, the safety systems may no longer be able to protect you or others as they are designed to do. Always have maintenance work carried out at a qualified specialist workshop. The qualified specialist workshop must have the necessary specialist knowledge and tools to carry out the work required. We recommend visiting an authorized Sprinter Dealer. In particular, work relevant to safety or on safety-related systems must be carried out at a qualified specialist workshop.









Problem	Possible causes/consequences and ► Solutions
 The yellow ASR/ESP <sup>®</sup> warning lamp flashes while the vehicle is in motion.	<p> <b>Warning!</b></p> <p>ESP<sup>®</sup> or ASR is intervening because at least one of the wheels has reached its tire grip limit. Cruise control is deactivated for the duration of the intervention.</p> <ul style="list-style-type: none"> <li>► Adapt your driving style to suit the road and traffic conditions. Do not use too much throttle.</li> <li>► Drive slowly.</li> </ul>
 The yellow ASR/ESP <sup>®</sup> warning lamp is lit while the engine is running.	<p> <b>Warning!</b></p> <p>ASR is deactivated.</p> <ul style="list-style-type: none"> <li>► Activate ASR again. Exceptions (► page 49).</li> </ul>
    The yellow ESP <sup>®</sup> , ABS and ASR/BAS warning lamps, and the red brake system warning lamp light up while the engine is running.	<p> <b>Warning!</b></p> <p>EBD has malfunctioned. The rear wheels could lock sooner than expected when you apply the brakes.</p> <ul style="list-style-type: none"> <li>► On vehicles with steering wheel buttons, also observe the messages in the display (► page 197).</li> <li>► Stop the vehicle as soon as possible, paying attention to road and traffic conditions.</li> <li>► Do not drive on.</li> <li>► Consult a qualified specialist workshop.</li> </ul>



Problem	Possible causes/consequences and ► Solutions
 <p>The yellow ESP<sup>®</sup>, ABS and ASR/BAS warning lamps, and the red brake system warning lamp light up while the engine is running.</p>	<p><b>⚠ Warning!</b></p> <p>EBD has been deactivated due to undervoltage. It is possible that the battery is not being charged. The rear wheels could lock sooner than expected when you apply the brakes.</p> <ul style="list-style-type: none"> <li>► On vehicles with steering wheel buttons, also observe the messages in the display (▷ page 197).</li> <li>► Stop the vehicle as soon as possible, paying attention to road and traffic conditions.</li> <li>► Do not drive on.</li> <li>► Consult a qualified specialist workshop.</li> </ul>
 <p>The red brake system indicator lamp is lit while the engine is running. A warning tone also sounds.</p>	<p><b>⚠ Warning!</b></p> <p>There is insufficient brake fluid in the supply reservoir.</p> <ul style="list-style-type: none"> <li>► On vehicles with steering wheel buttons, also observe the messages in the display (▷ page 197).</li> <li>► Stop the vehicle as soon as possible, paying attention to road and traffic conditions.</li> <li>► Check the brake fluid level in the supply reservoir (▷ page 170).</li> <li>► If the brake fluid is below the MIN mark: do not drive on!</li> <li>► Do not add brake fluid. This does not solve the problem.</li> <li>► Consult a qualified specialist workshop.</li> </ul>
 <p>When towing a trailer: The red brake system warning lamp is lit while the engine is running. A warning tone also sounds.</p>	<p><b>⚠ Warning!</b></p> <p>The brake force booster in the trailer is faulty. The driving and braking characteristics of your vehicle could change. There is a risk of the trailer overbraking and of you losing control over the truck/trailer combination.</p> <ul style="list-style-type: none"> <li>► On vehicles with steering wheel buttons, also observe the messages in the display (▷ page 197).</li> <li>► Stop the vehicle as soon as possible, paying attention to road and traffic conditions.</li> <li>► Do not drive on.</li> <li>► Consult a qualified specialist workshop.</li> </ul>





Problem	Possible causes/consequences and ► Solutions
 The yellow ASR/BAS indicator lamp is lit while the engine is running.	<p> <b>Warning!</b></p> <p>ASR has been deactivated due to a malfunction. The engine power output may be reduced.</p> <ul style="list-style-type: none"> <li>► Drive on with care.</li> <li>► Consult a qualified specialist workshop as soon as possible.</li> </ul>
 The yellow ASR/BAS indicator lamp is lit while the engine is running.	<p> <b>Warning!</b></p> <p>BAS has been deactivated due to a malfunction. The brake system continues to function normally, but without electronic support.</p> <ul style="list-style-type: none"> <li>► Drive on with care.</li> <li>► Consult a qualified specialist workshop as soon as possible.</li> </ul>
 The yellow ASR/BAS indicator lamp is lit while the engine is running.	<p> <b>Warning!</b></p> <p>ASR and BAS have been deactivated due to undervoltage. It is possible that the battery is not being charged. The brake system is still available with the normal braking effect.</p> <ul style="list-style-type: none"> <li>► Drive on with care.</li> <li>► Visit a qualified specialist workshop immediately.</li> </ul>
 The yellow ABS indicator lamp is lit while the engine is running.	<p> <b>Warning!</b></p> <p>ABS has been deactivated due to a malfunction. ESP®, ASR and BAS, as well as cruise control, have also been deactivated as a result. The brake system continues to function normally, but without electronic support. The wheels could therefore lock, e.g. if the brakes are applied with maximum force.</p> <ul style="list-style-type: none"> <li>► On vehicles with steering wheel buttons, also observe the messages in the display (► page 197).</li> <li>► Drive on with care.</li> <li>► Visit a qualified specialist workshop immediately.</li> </ul>
 The yellow ABS indicator lamp is lit while the engine is running.	<p> <b>Warning!</b></p> <p>ABS is temporarily unavailable. Self diagnosis may not have been completed yet. The brake system is still available with the normal braking effect.</p> <ul style="list-style-type: none"> <li>► Drive on for a short distance at a speed of more than 13 mph(20 km/h). ABS is available again if the message goes out.</li> </ul>





Problem	Possible causes/consequences and ► Solutions
 The yellow ABS indicator lamp is lit while the engine is running.	<p> <b>Warning!</b></p> <p>ABS has been deactivated due to undervoltage. It is possible that the battery is not being charged.</p> <p>The brake system continues to function normally, but without electronic support. The wheels could therefore lock, e.g. if the brakes are applied with maximum force.</p> <ul style="list-style-type: none"> <li>► Drive on with care.</li> <li>► Visit a qualified specialist workshop immediately.</li> </ul>
 The yellow DEF indicator lamp lights up while the engine is running.	<p>The exhaust gas aftertreatment is malfunctioning or the current Diesel Exhaust Fluid (DEF) supply is limiting the vehicle range.</p> <ul style="list-style-type: none"> <li>► Observe the messages in the display (► page 199).</li> </ul>
 The yellow ESP <sup>®</sup> warning lamp is lit while the engine is running.	<p> <b>Warning!</b></p> <p>ESP<sup>®</sup> has been deactivated due to a malfunction. This also deactivates cruise control.</p> <p>The vehicle's stability is no longer automatically regulated at an early stage. Engine power output may be reduced.</p> <ul style="list-style-type: none"> <li>► On vehicles with steering wheel buttons, also observe the messages in the display (► page 197).</li> <li>► Drive on with care.</li> <li>► Consult a qualified specialist workshop as soon as possible.</li> </ul>
 The yellow ESP <sup>®</sup> warning lamp is lit while the engine is running.	<p> <b>Warning!</b></p> <p>ESP<sup>®</sup> has been deactivated due to undervoltage. This also deactivates cruise control.</p> <p>It is possible that the battery is not being charged.</p> <p>The vehicle's stability is no longer automatically regulated at an early stage. Engine power output may be reduced.</p> <ul style="list-style-type: none"> <li>► Drive on with care.</li> <li>► Consult a qualified specialist workshop as soon as possible.</li> </ul>











Problem	Possible causes/consequences and ► Solutions
<p> The red SRS indicator lamp does not go out approximately four seconds after switching on the ignition, or lights up again.</p>	<p> <b>Warning!</b></p> <p>The restraint systems have malfunctioned. The air bags or belt tensioners could be triggered unintentionally or might not be triggered at all in the event of an accident.</p> <ul style="list-style-type: none"> <li>► Drive on with care.</li> <li>► Visit a qualified specialist workshop immediately.</li> </ul>
<p> The red battery charge indicator lamp lights up while the engine is running.</p>	<p> <b>Warning!</b></p> <p>The battery is not being charged. Possible causes are a defective alternator or a torn poly-V-belt.</p> <ul style="list-style-type: none"> <li>► Stop the vehicle as soon as possible, paying attention to road and traffic conditions.</li> <li>► Check the poly-V-belt. <b>If it is torn:</b> do not drive on. Consult the nearest qualified specialist workshop. <b>If it is not damaged:</b> have the vehicle checked at a qualified specialist workshop.</li> </ul>
<p> The red battery charge indicator lamp lights up while the engine is running.</p>	<p> <b>Warning!</b></p> <p>The battery is faulty.</p> <ul style="list-style-type: none"> <li>► Stop the vehicle as soon as possible, paying attention to road and traffic conditions.</li> <li>► Do not continue driving under any circumstances.</li> <li>► Contact a breakdown service, e.g. an authorized Sprinter Dealer.</li> </ul>
<p> The yellow brake pad wear indicator lamp lights up after the engine is started or while the vehicle is in motion.</p>	<p> <b>Warning!</b></p> <p>The brake pads/linings have reached their wear limit.</p> <ul style="list-style-type: none"> <li>► Have the brake pads/linings replaced as soon as possible at a qualified specialist workshop.</li> </ul>



Problem	Possible causes/consequences and ► Solutions
 The yellow engine oil level warning lamp lights up after the engine is started or while the vehicle is in motion.	<p>The oil level has dropped to the minimum level.</p> <ul style="list-style-type: none"> <li>► Check the engine oil level and top up at the nearest gas station (▷ page 171).</li> <li>► If there is visible oil loss from the engine, have the malfunction rectified immediately at a qualified specialist workshop.</li> </ul>
 The yellow engine oil level warning lamp flashes, the <b>-2.0 qts</b> (Canada: <b>-2.0 ltr</b> ) engine oil level message, for example, appears in the display and the warning buzzer sounds after the engine is started or while the vehicle is in motion.	<p>There is not enough or no oil in the engine. There is a danger of engine damage.</p> <ul style="list-style-type: none"> <li>► Stop the vehicle as soon as possible, paying attention to road and traffic conditions.</li> <li>► Check the oil level using the oil dipstick (▷ page 172). <b>If the engine oil level is correct:</b> have the malfunction rectified immediately at a qualified specialist workshop. <b>If the engine oil level is too low:</b> have the vehicle towed to a qualified specialist workshop.</li> </ul>
 The yellow engine oil level warning lamp lights up, the <b>HI</b> engine oil level message, for example, appears in the display and the warning buzzer sounds after the engine is started or while the vehicle is in motion.	<p>The engine oil level is above the maximum level.</p> <ul style="list-style-type: none"> <li>► Check the oil level. If the oil level is too high, have engine oil siphoned off at the nearest gas station (▷ page 173). You could otherwise damage the engine or the catalytic converter.</li> </ul> <p>If the oil level is correct, have the malfunction rectified as soon as possible at a qualified specialist workshop.</p>

Problem	Possible causes/consequences and ► Solutions
 The yellow engine oil level warning lamp lights up repeatedly while the vehicle is in motion.	<p>There is a malfunction in the engine oil level display.</p> <ul style="list-style-type: none"> <li>► Have the vehicle checked immediately at a qualified specialist workshop.</li> </ul>
 The yellow coolant level warning lamp lights up while the engine is running.	<p>The coolant level is too low. Never run the engine if the coolant level is too low. The engine could overheat and be damaged.</p> <ul style="list-style-type: none"> <li>► Stop the vehicle as soon as possible, paying attention to road and traffic conditions.</li> <li>► Switch off the engine and let it cool down.</li> <li>► Add coolant and be sure to observe the warning notes (► page 169).</li> <li>► If you need to add coolant frequently, have the cooling system checked at a qualified specialist workshop.</li> </ul>
 The red coolant warning lamp lights up while the engine is running.	<p>The coolant temperature is too high.</p> <ul style="list-style-type: none"> <li>► Stop the vehicle as soon as possible, paying attention to road and traffic conditions.</li> <li>► Consult a qualified specialist workshop.</li> </ul>
 The red coolant warning lamp lights up while the engine is running.	<p>The coolant temperature is too high. If the vehicle is stopped after being subjected to extreme loads (e.g. driving in mountainous terrain, trailer towing), the coolant warning lamp may light up when the ignition is switched on or the engine is restarted.</p> <ul style="list-style-type: none"> <li>► Run the engine for approximately one minute at idling speed.</li> <li>► Consult a qualified specialist workshop if the coolant warning lamp remains lit.</li> </ul>
 The yellow reserve fuel warning lamp lights up while driving.	<p>The fuel level has fallen into the reserve range.</p> <ul style="list-style-type: none"> <li>► Refuel at the nearest gas station (► page 142).</li> </ul>

Problem	Possible causes/consequences and ► Solutions
 The yellow reserve fuel warning lamp lights up while the engine is running and the display for the tank content shows 0, even though there is still fuel in the tank.	<p>The fuel filler cap is not closed.</p> <ul style="list-style-type: none"> <li>► Close the fuel filler cap. You will hear a click when the fuel filler cap is closed fully.</li> <li>► If the malfunction continues to be displayed, have it rectified immediately at a qualified specialist workshop.</li> </ul>
 The yellow preglow indicator lamp lights up while the engine is running.	<p>There is a malfunction in the preglow system.</p> <ul style="list-style-type: none"> <li>► Consult a qualified specialist workshop.</li> </ul>
 The yellow check engine indicator lamp lights up or flashes while the engine is running.	<p>You have used up all fuel in the tank. The engine is running in emergency mode.</p> <ul style="list-style-type: none"> <li>► Refuel at the nearest gas station (▷ page 142).</li> <li>► Bleed the fuel system .</li> <li>► Start the engine three to four times in succession after refueling. Emergency running mode will be canceled. The vehicle does not need to be checked.</li> </ul>
 The yellow check engine indicator lamp lights up or flashes while the engine is running.	<p>The injection system is malfunctioning. The engine is running in emergency mode. Engine power output may be reduced.</p> <ul style="list-style-type: none"> <li>► Have the vehicle checked as soon as possible at a qualified specialist workshop.</li> </ul> <p>In some states it is legally prescribed that after the check engine indicator lamp lights up you must contact a qualified specialist workshop immediately. Observe legal requirements.</p>

Problem	Possible causes/consequences and ► Solutions
 The yellow check engine indicator lamp lights up while the engine is running.	<p>The exhaust gas aftertreatment system is defective or an emissions-relevant malfunction has occurred. This malfunction or defect can damage the exhaust gas aftertreatment.</p> <p>After the first message and under normal operating conditions, you can drive on for up to approximately 500 miles (800 km). Then a warning tone sequence sounds and the engine can only be started 20 times.</p> <ul style="list-style-type: none"> <li>► Observe the messages in the display:             <ul style="list-style-type: none"> <li>• on vehicles without steering-wheel buttons (▷ page 199)</li> <li>• on vehicles with steering-wheel buttons (▷ page 202) and (▷ page 204).</li> </ul> </li> <li>► Have the exhaust gas aftertreatment checked as soon as possible at a qualified specialist workshop.</li> </ul> <p>In some states it is legally prescribed that after the check engine indicator lamp lights up you must contact a qualified specialist workshop immediately. Observe legal requirements.</p>
 The yellow air filter indicator lamp lights up while the engine is running.	<p>The service limit for the air filter has been reached. The air filter is dirty.</p> <ul style="list-style-type: none"> <li>► Have the air filter element replaced as soon as possible at a qualified specialist workshop.</li> </ul>
 The yellow tire pressure monitor warning lamp comes on.	<p> <b>Warning!</b></p> <p>The tire pressure monitor indicates a rapid or severe loss of pressure in at least one tire.</p> <ul style="list-style-type: none"> <li>► Stop the vehicle without making any extreme steering maneuvers or braking suddenly. Pay attention to the traffic conditions while doing so.</li> <li>► Check the tires and correct the tire pressure. If a tire continues to lose pressure, it must be replaced. Replace damaged tires immediately.</li> </ul> <p>The warning lamp goes out after you have been driving for a few minutes with the malfunction rectified.</p> <ul style="list-style-type: none"> <li>► On vehicles with steering wheel buttons, also observe the messages in the display (▷ page 197).</li> </ul>

Problem	Possible causes/consequences and ► Solutions
 US vehicles only: The yellow tire pressure monitor warning lamp flashes for 60 seconds and then remains lit.	The tire pressure monitor has malfunctioned. ► Have the tire pressure monitor and the wheels checked at a qualified specialist workshop.
 The yellow water separator indicator lamp lights up when the ignition is started.	The water that has collected in the water separator has reached the maximum level. ► Drain the water separator (▷ page 221).
 The yellow washer fluid level indicator lamp for the windshield washer/headlamp cleaning system lights up after the engine is started or while the vehicle is in motion.	The water level is too low. ► Top up washer fluid (▷ page 171).
 The red seat belt warning lamp lights up for approximately six seconds when the key is turned to position <b>2</b> in the ignition lock. A warning tone also sounds.	The warning lamp is to remind you to fasten your seat belt. ► Fasten seat belt (▷ page 34).

Problem	Possible causes/consequences and ► Solutions
 The yellow bulb indicator lamp lights up when the key is turned to position <b>2</b> in the ignition lock.	A bulb in the exterior lighting (with the exception of the front position lamps and trailer lighting) is defective <sup>6</sup> . ► Change defective bulbs as soon as possible (► page 233).
 The yellow door indicator lamp lights up while you are driving.	The vehicle is moving without all doors or the hood being closed. ► Close the doors or hood.

### Notes on display messages

#### Warning

No messages can be displayed if the instrument cluster and/or the display fails. You will then not be able to see information about the vehicle status, such as speed and outside temperature, warning/indicator lamps and display messages or the failure of systems. Handling characteristics may be affected. Adapt your speed and driving style accordingly.

Immediately consult a qualified specialist workshop. The qualified specialist workshop must have the necessary specialist knowledge and tools to carry out the work required. We recommend an authorized Sprinter Dealer for this purpose. In particular, all work relevant to safety or on safety-related systems must be carried out at a qualified specialist workshop.

#### Warning

The operating safety of your vehicle could be jeopardized if maintenance work is carried out incorrectly. As a result, you could lose control of the vehicle and cause an accident. In addition, the safety systems may no longer

be able to protect you or others as they are designed to do.

Always have maintenance work carried out at a qualified specialist workshop. The qualified specialist workshop must have the necessary specialist knowledge and tools to carry out the work required. We recommend visiting an authorized Sprinter Dealer. In particular, work relevant to safety or on safety-related systems must be carried out at a qualified specialist workshop.

-  If you turn the key to position **2** in the ignition lock, all warning/indicator lamps (except the turn signal indicator lamps) and the display are activated. Please make sure that they are working properly before commencing a journey.

### Vehicles without steering wheel buttons

Warnings, malfunctions or additional information may also be shown in the display. The following tables show all the display messages. For certain display messages, a warning tone or a continuous tone will also sound.





<sup>6</sup> The lamp failure indicator may, depending on equipment, be omitted for all lamps with the exception of turn signals.

## Vehicles with steering wheel buttons

---

The on-board computer shows warnings, malfunctions or additional information in the display. For certain display messages, a warning tone or a continuous tone will also sound. Display messages of a high priority are shown in red.

Please respond in accordance with the display messages and follow the additional notes in this Operator's Manual.

You can hide low-priority display messages using the , ,  or  button on the steering wheel or the reset button on the instrument cluster.

You cannot hide display messages of the highest priority. These messages will continue to be shown in the display until their cause has been eliminated.



The on-board computer stores certain display messages in the **message memory** (> page 78).







The following tables show all the display messages. They are divided into alphabetically sorted text messages (> page 201) and symbol messages (> page 204).







Display messages



Display messages on vehicles without steering wheel buttons



Display messages	Possible causes/consequences and ► Solutions
<p>NO TPMS</p>	<p>The <b>NO</b> message is displayed for 30 seconds. The <b>TPMS</b> message is also displayed after 30 seconds.</p> <p>The tire pressure monitor has malfunctioned.</p> <p>► Have the tire pressure monitor and the wheels checked at a qualified specialist workshop.</p>
<p>NO TPMS</p>	<p>The <b>NO</b> message is displayed for 30 seconds. The <b>TPMS</b> message is also displayed after 30 seconds.</p> <p>The tire pressure monitor is not receiving signals from one or more wheels because:</p> <ul style="list-style-type: none"> <li>• a wheel has been replaced with the spare wheel without wheel electronics.</li> <li>• the maximum temperature on one of the wheel electronics units has been exceeded.</li> <li>• the wheel electronics are malfunctioning.</li> </ul> <p>► Have wheels with suitable wheel electronics units installed at a qualified specialist workshop.</p>
<p>— — TPMS</p>	<p>The <b>—</b> message is displayed for 30 seconds. The <b>TPMS</b> message is also displayed after 30 seconds.</p> <p>The pressure in one or more tires is too low or there is a significant difference between tire pressures on individual wheels.</p> <p>► Check the tire pressure at the next opportunity and correct it if necessary (► page 281).</p>
<p> dEF Chk</p>	<p>In addition, the yellow  engine diagnosis indicator lamp and the yellow  DEF indicator lamp light up and a warning tone sounds.</p> <p>The DEF reducing agent is contaminated, diluted or is not compliant with ISO 22241.</p> <p>After the message appears for the first time, and under normal driving conditions, you can continue driving for approximately 50 miles (80 km). After this, a warning tone sequence sounds. The engine can then only be started another sixteen times.</p> <p>► Have the DEF tank cleaned and refilled at a qualified specialist workshop as soon as possible.</p>

Display messages	Possible causes/consequences and ► Solutions
 <p>dEF Chk</p>	<p>In addition, the yellow  DEF indicator lamp lights up and a warning tone sounds.</p> <p>The DEF supply has dropped below 1.5 US gal (5.5 l).</p> <p>After the message appears for the first time and under normal driving conditions, the remaining DEF supply will last for approximately 1000 miles (1600 km).</p> <p>After that, the 0.8 US gal (3.0 l) reserve mark is reached. A warning tone sequence sounds. The engine can then only be started another sixteen times.</p> <p>► add DEF supply (► page 143). After topping up, the system check takes approximately 20 seconds. The  DEF indicator lamp then goes out.</p>
 <p>StArtS RE xx</p>	<p>In addition, the yellow  engine diagnosis indicator lamp and the yellow  DEF indicator lamp light up and a warning tone sounds. A warning tone sequence sounds.</p> <p>After the message appears for the first time, the engine can only be started another sixteen times.</p> <p>The number of remaining engine starts xx (16 to 0) is shown in the message every time the engine is started. Once the number 0 is shown, the engine can no longer be started.</p> <p>The DEF reducing agent is contaminated, diluted or is not compliant with ISO 22241.</p> <p>► Have the DEF tank cleaned and refilled at a qualified specialist workshop as soon as possible.</p>

Display messages	Possible causes/consequences and ► Solutions
	<p>The exhaust gas aftertreatment system is defective or an emissions-relevant malfunction has occurred. The defect or malfunction can result in damage to the exhaust gas aftertreatment system.</p> <p>► Visit a qualified specialist workshop immediately.</p>
 StArTS RE xx	<p>In addition, the yellow  DEF indicator lamp lights up and a warning tone sequence sounds.</p> <p>The DEF supply has dropped below the 0.8 US gal (3.0 l) reserve mark.</p> <p>After the message appears for the first time, the remaining DEF supply will last for approximately 1200 miles (1900 km). The engine can then only be started another sixteen times.</p> <p>The number of remaining engine starts xx (16 to 0) is shown in the message every time the engine is started. Once the number 0 is shown, the yellow  engine diagnosis indicator lamp lights up and the engine can no longer be started.</p> <p>► Add at least 2.0 US gal (7.6 l) of DEF (► page 143).                      After topping up, the system check takes approximately 20 seconds. The  DEF indicator lamp then goes out.</p>







**Text messages on vehicles with steering wheel buttons**





Display messages	Possible causes/consequences and ► Solutions
ABS Visit workshop	<p> <b>Warning!</b></p> <p>ABS has been deactivated due to a malfunction. ESP®, ASR and BAS, as well as cruise control, have also been deactivated as a result.</p> <p>The brake system is still available with complete brake boosting effect but without ABS.</p> <p>► Drive on carefully.                      ► Visit a qualified specialist workshop immediately.</p>
ABS Unavailable	<p> <b>Warning!</b></p> <p>ABS is temporarily unavailable. Self diagnosis may not have been completed yet.</p> <p>The brake system is still available with the normal braking effect.</p> <p>► Drive a short distance at a speed above 13 mph (20 km/h).                      ABS is available again if the display message goes out.</p>









Display messages	Possible causes/consequences and ► Solutions
ABS Unavailable	<p> <b>Warning!</b></p> <p>ABS has been deactivated due to undervoltage. The battery might not be charging.</p> <p>The brake system is still available with the normal braking effect.</p> <ul style="list-style-type: none"> <li>► Drive on carefully.</li> <li>► Visit a qualified specialist workshop immediately.</li> </ul>
Check Diesel Exhaust Fluid see Operator's Manual	<p>The Diesel Exhaust Fluid (DEF) supply has dropped below 1.5 US gal (5.5 l).</p> <p>After the message appears for the first time and under normal driving conditions, the remaining DEF supply will last for approximately 1000 miles (1600 km).</p> <p>After that, the 0.8 US gal (3.0 l) reserve mark is reached. A warning tone sequence sounds. The engine can then only be started another sixteen times.</p> <ul style="list-style-type: none"> <li>► add DEF supply (► page 143).              After topping up, the system check takes approximately 20 seconds. The display message then disappears.</li> </ul>
Check Diesel Exhaust Fluid see Operator's Manual	<p>If the yellow  engine diagnosis indicator lamp lights up in addition, the DEF reducing agent is contaminated, diluted or not compliant with ISO 22241.</p> <p>After the message appears for the first time, and under normal driving conditions, you can continue driving for approximately 50 miles(80 km). After this, a warning tone sequence sounds. The engine can then only be started another sixteen times.</p> <p>Have the DEF tank cleaned and refilled at a qualified specialist workshop as soon as possible.</p>
ESP Visit workshop	<p> <b>Warning!</b></p> <p>ESP® has been deactivated due to a malfunction. This also deactivates cruise control.</p> <p>The vehicle's stability is no longer automatically regulated at an early stage. Engine power output may be reduced.</p> <ul style="list-style-type: none"> <li>► Drive on carefully.</li> <li>► Visit a qualified specialist workshop immediately.</li> </ul>

Display messages	Possible causes/consequences and ► Solutions
<p>ESP Unavailable</p>	<p>ESP® has been deactivated due to undervoltage. This also deactivates cruise control. The battery might not be charging. The vehicle's stability is no longer automatically regulated at an early stage. Engine power output may be reduced.</p> <ul style="list-style-type: none"> <li>► Drive on carefully.</li> <li>► Visit a qualified specialist workshop as soon as possible.</li> </ul>
<p>Tire pres. Adj. pres.</p>	<p>The pressure in one or more tires is too low or there is a significant difference between tire pressures on individual wheels.</p> <ul style="list-style-type: none"> <li>► Check the tire pressure at the next opportunity and correct it if necessary (▷ page 281).</li> </ul>
<p>Tire pres. monitor inoperative</p>	<p>The tire pressure monitor has malfunctioned.</p> <ul style="list-style-type: none"> <li>► Have the tire pressure monitor and the wheels checked at a qualified specialist workshop.</li> </ul>
<p>Tire press. monitor currently unavail.</p>	<p>The tire pressure monitor function is temporarily unavailable due to radio interference or undervoltage.</p> <ul style="list-style-type: none"> <li>► As soon as the causes have been remedied, the tire pressure monitor activates itself automatically.</li> </ul>
<p>Tire press. monitor inoperative No wheel sensors</p>	<p>The tire pressure monitor is not receiving signals from one or more wheels because:</p> <ul style="list-style-type: none"> <li>• a wheel has been replaced with the spare wheel without wheel electronics.</li> <li>• the maximum temperature on one of the wheel electronics units has been exceeded.</li> <li>• the wheel electronics are malfunctioning.</li> </ul> <ul style="list-style-type: none"> <li>► Have wheels with suitable wheel electronics units installed at a qualified specialist workshop.</li> </ul>
<p>Cruise control Visit workshop</p>	<p>Cruise control has been deactivated due to a malfunction.</p> <ul style="list-style-type: none"> <li>► Have cruise control checked at a qualified specialist workshop.</li> </ul>
<p>SRS Restraint system Visit workshop</p>	<p> <b>Warning!</b></p> <p>The restraint systems have malfunctioned. The air bags or belt tensioners could be triggered unintentionally or might not be triggered at all in the event of an accident.</p> <ul style="list-style-type: none"> <li>► Drive on carefully.</li> <li>► Visit a qualified specialist workshop as soon as possible.</li> </ul>









## Symbol messages on vehicles with steering wheel buttons







Display messages	Possible causes/consequences and ► Solutions
 <p>xx starts remaining</p>	<p>The Diesel Exhaust Fluid (DEF) supply has dropped below the 0.8 US gal (3.0 l) reserve mark.</p> <p>After the message appears for the first time, the remaining DEF supply will last for approximately 1200 miles (1900 km). The engine can then only be started another twenty times.</p> <p>The number of remaining engine starts <b>xx (20 to 0)</b> is shown in the message every time the engine is started. Once the number <b>0</b> is shown, the yellow  engine diagnosis indicator lamp lights up and the engine can no longer be started.</p> <ul style="list-style-type: none"> <li>► Add at least 2.0 US gal (7.6 l) of DEF (► page 143). After topping up, the system check takes approximately 20 seconds. The display message then disappears.</li> </ul>
 <p>xx starts remaining</p>	<p>In addition, the yellow  engine diagnosis indicator lamp lights up.</p> <p>After the message appears for the first time, the engine can only be started another twenty times.</p> <p>The number of remaining engine starts <b>xx (20 to 0)</b> is shown in the message every time the engine is started. Once the number <b>0</b> is shown, the engine can no longer be started.</p> <p>The DEF reducing agent is contaminated, diluted or is not compliant with ISO 22241.</p> <ul style="list-style-type: none"> <li>► Have the DEF tank cleaned and refilled at a qualified specialist workshop as soon as possible.</li> </ul> <p>The exhaust gas aftertreatment system is defective or an emissions-relevant malfunction has occurred. The defect or malfunction can result in damage to the exhaust gas aftertreatment system.</p> <ul style="list-style-type: none"> <li>► Visit a qualified specialist workshop immediately.</li> </ul>
 <p>Visit workshop</p>	<p> <b>Warning!</b></p> <p>ASR has been deactivated due to a malfunction. The engine power output may then be lower.</p> <ul style="list-style-type: none"> <li>► Drive on carefully.</li> <li>► Visit a qualified specialist workshop immediately.</li> </ul>











Display messages	Possible causes/consequences and ► Solutions
 <p>Visit workshop</p>	<p><b>Warning!</b></p> <p>BAS has been deactivated due to a malfunction. The brake system continues to function normally, but without electronic support.</p> <ul style="list-style-type: none"> <li>► Drive on carefully.</li> <li>► Visit a qualified specialist workshop immediately.</li> </ul>
 <p>Unavailable</p>	<p>ASR and BAS have been deactivated due to undervoltage. The battery might not be charging. The brake system is still available with the normal braking effect.</p> <ul style="list-style-type: none"> <li>► Drive on carefully.</li> <li>► Visit a qualified specialist workshop immediately.</li> </ul>
 <p>Battery/ Alternator Visit workshop</p>	<p>The battery is not being charged. This could be caused by a defective alternator or a torn poly-V-belt.</p> <ul style="list-style-type: none"> <li>► Pull over immediately, paying attention to road and traffic conditions.</li> <li>► Check the poly-V-belt.</li> </ul> <p><b>If it is torn:</b> do not drive any further. Consult the nearest qualified specialist workshop.</p> <p><b>If it is undamaged:</b> have the vehicle checked as soon as possible at a qualified specialist workshop.</p>
 <p>Brake wear Visit workshop</p>	<p><b>Warning!</b></p> <p>The brake pads/linings have reached their wear limit.</p> <ul style="list-style-type: none"> <li>► Have the brake pads/linings replaced as soon as possible at a qualified specialist workshop.</li> </ul>
 <p>Brake fluid Visit workshop</p>	<p><b>Warning!</b></p> <p>There is insufficient brake fluid in the brake fluid reservoir.</p> <ul style="list-style-type: none"> <li>► Pull over immediately, paying attention to road and traffic conditions.</li> <li>► Check the brake fluid level in the supply reservoir (► page 170).</li> <li>► If the brake fluid level is below the MIN mark: do not drive any further.</li> <li>► Do not add brake fluid. This will not rectify the problem.</li> <li>► Consult a qualified specialist workshop.</li> </ul>

Display messages	Possible causes/consequences and ► Solutions
 <p>Brake force distribution</p>	<p> <b>Warning!</b></p> <p>EBD has been deactivated due to undervoltage. The battery might not be charging. The rear wheels could lock sooner than expected when you apply the brakes.</p> <ul style="list-style-type: none"> <li>► Pull over immediately, paying attention to road and traffic conditions.</li> <li>► Do not continue driving.</li> <li>► Visit a qualified specialist workshop.</li> </ul>
 <p>Brake force distribution Visit workshop</p>	<p> <b>Warning!</b></p> <p>EBD has malfunctioned. The rear wheels could lock sooner than expected when you apply the brakes.</p> <ul style="list-style-type: none"> <li>► Pull over immediately, paying attention to road and traffic conditions.</li> <li>► Do not continue driving.</li> <li>► Consult a qualified specialist workshop.</li> </ul>
 <p>Parking brake Release brake</p>	<p>A warning tone also sounds. You are driving with the parking brake applied.</p> <ul style="list-style-type: none"> <li>► Release the parking brake (► page 112).</li> </ul>
 <p>Seatbelt sys. Visit workshop</p>	<p> <b>Warning!</b></p> <p>The belt system has malfunctioned.</p> <ul style="list-style-type: none"> <li>► Visit a qualified specialist workshop as soon as possible.</li> </ul>
 <p>Coolant Stop, turn engine off</p>	<p>The coolant temperature is too high.</p> <ul style="list-style-type: none"> <li>► Pull over immediately, paying attention to road and traffic conditions.</li> <li>► Consult a qualified specialist workshop.</li> </ul>
 <p>Coolant Stop, turn engine off</p>	<p>The coolant temperature is too high. If the vehicle is stopped after being subjected to extreme loads (e.g. driving in mountainous terrain, trailer towing, etc.), this display message may be shown when the ignition is switched on or the engine is restarted.</p> <ul style="list-style-type: none"> <li>► Run the engine for approximately one minute at idling speed.</li> <li>► Consult a qualified specialist workshop if the display message continues to be shown.</li> </ul>















Display messages	Possible causes/consequences and ► Solutions
 <p>Check coolant level</p>	<p>The coolant level is too low.</p> <p>Never run the engine if the coolant level is too low. The engine could overheat and be damaged.</p> <ul style="list-style-type: none"> <li>► Add coolant, observing the warning notes while doing so (► page 169).</li> <li>► Have the coolant system checked at a qualified specialist workshop if the coolant needs topping up more often than usual.</li> </ul>
 <p>Hood open</p>	<p>You are already driving at walking pace, even though the hood is not closed.</p> <ul style="list-style-type: none"> <li>► Close the hood.</li> </ul>
 <p>Engine oil Add 1.0 quart(Canada: 1.0 liter)</p>	<p>The oil level is too low.</p> <ul style="list-style-type: none"> <li>► Check the oil level the next time you refuel (► page 171), and top up the oil.</li> </ul>
 <p>Engine oil level Not when eng. running</p>	<p>You want to check the oil level even though the engine is running.</p> <ul style="list-style-type: none"> <li>► Switch off the engine.</li> <li>► Check the oil level (► page 171).</li> </ul>
 <p>Engine oil level Reduce oil level</p>	<p>You have added too much engine oil. There is a risk of damaging the engine or catalytic converter.</p> <ul style="list-style-type: none"> <li>► Siphon off excess oil until the oil is at the specified level. Observe the legal requirements.</li> </ul>
 <p>Engine oil level Stop, turn engine off</p>	<p>There is not enough oil, or no oil in the engine. There is a danger of engine damage.</p> <ul style="list-style-type: none"> <li>► Pull over immediately, paying attention to road and traffic conditions.</li> <li>► Check the oil level with the oil dipstick (► page 172).  <b>If the oil level is OK:</b> have the malfunction repaired immediately at a qualified specialist workshop.  <b>If the oil level is too low:</b> have the vehicle towed to a qualified specialist workshop.</li> </ul>
 <p>Oil sensor Visit workshop</p>	<p>The measuring system is malfunctioning.</p> <ul style="list-style-type: none"> <li>► Have the measuring system checked at a qualified specialist workshop.</li> </ul>
 <p>Please enter PIN:</p>	<p>You have not yet entered your PIN in the mobile phone.</p> <ul style="list-style-type: none"> <li>► Enter the PIN for the SIM card.</li> </ul>



Display messages	Possible causes/consequences and ► Solutions
 <p data-bbox="108 225 275 252">Check tire(s)</p>	<p data-bbox="365 172 1044 260">The pressure of one or more tires has dropped significantly. If the tire pressure monitor has detected the affected wheel, the wheel position is also displayed.</p> <ul style="list-style-type: none"> <li data-bbox="365 272 985 325">► Pull over immediately, paying attention to road and traffic conditions.</li> <li data-bbox="365 336 553 363">► Check the tires.</li> <li data-bbox="365 375 950 402">► Repair or change the wheel if necessary (▷ page 222).</li> <li data-bbox="365 413 910 466">► Check the tire pressure and correct it if necessary (▷ page 280).</li> </ul> <p data-bbox="389 467 1044 520">The display message disappears automatically after driving for a few minutes with the corrected tire pressure.</p>
 <p data-bbox="108 596 348 624">Warning Tire defect</p>	<p data-bbox="365 544 1044 632">One or more tires is losing air rapidly. If the tire pressure monitor has detected the affected wheel, the wheel position is also displayed.</p> <ul style="list-style-type: none"> <li data-bbox="365 644 1044 732">► Stop the vehicle without making any sudden steering or braking maneuvers, paying attention to the traffic conditions as you do so.</li> <li data-bbox="365 743 820 770">► Repair or change the wheel (▷ page 222).</li> </ul>
 <p data-bbox="108 839 326 898">Check Immobilizer Visit workshop</p>	<p data-bbox="365 786 667 813">The key is no longer working.</p> <ul style="list-style-type: none"> <li data-bbox="365 825 765 852">► Visit a qualified specialist workshop.</li> </ul>
 <p data-bbox="108 967 338 1026">Reserve fuel Drive to a gas station</p>	<p data-bbox="365 914 847 941">The fuel level has fallen into the reserve range.</p> <ul style="list-style-type: none"> <li data-bbox="365 952 871 979">► Refuel at the nearest gas station (▷ page 142).</li> </ul>
 <p data-bbox="108 1094 239 1121">Doors open</p>	<p data-bbox="365 1042 1020 1094">You are already driving at walking pace, even though not all the doors are closed.</p> <ul style="list-style-type: none"> <li data-bbox="365 1106 559 1133">► Close the doors.</li> </ul>
 <p data-bbox="108 1222 289 1281">Water in fuel Visit workshop</p>	<p data-bbox="365 1169 1027 1222">The water that has collected in the water separator has reached the maximum level.</p> <ul style="list-style-type: none"> <li data-bbox="365 1233 800 1260">► Drain the water separator (▷ page 221).</li> </ul>
 <p data-bbox="108 1350 326 1409">Check wash. fluid level</p>	<p data-bbox="365 1297 1012 1350">The washer fluid level has dropped to approximately <math>\frac{1}{3}</math> of the reservoir capacity.</p> <ul style="list-style-type: none"> <li data-bbox="365 1361 710 1388">► Add washer fluid (▷ page 171).</li> </ul>

Display messages	Possible causes/consequences and ► Solutions
 <p>Low beam left</p>	<p>The left-hand low beam is faulty<sup>7</sup>.</p> <ul style="list-style-type: none"> <li>► <b>Halogen headlamps:</b> replace the bulbs as soon as possible (▷ page 233).</li> <li>► <b>Bi-Xenon headlamps:</b> consult a qualified specialist workshop as soon as possible.</li> </ul>
 <p>Low beam right</p>	<p>The right-hand low beam is faulty<sup>7</sup>.</p> <ul style="list-style-type: none"> <li>► <b>Halogen headlamps:</b> replace the bulbs as soon as possible. (▷ page 233)</li> <li>► <b>Bi-Xenon headlamps:</b> consult a qualified specialist workshop as soon as possible.</li> </ul>
 <p>Cornering lt. left</p>	<p>The left-hand cornering light is faulty<sup>7</sup>.</p> <ul style="list-style-type: none"> <li>► Visit a qualified specialist workshop as soon as possible.</li> </ul>
 <p>Cornering lt. right</p>	<p>The right-hand cornering light is faulty<sup>7</sup>.</p> <ul style="list-style-type: none"> <li>► Visit a qualified specialist workshop as soon as possible.</li> </ul>
 <p>Lights on automatic. Remove key</p>	<p>The automatic headlamp feature is active: the light switch is in the <b>AUTO</b> position and you have forgotten to remove the key.</p> <ul style="list-style-type: none"> <li>► Remove the key from the ignition lock.</li> </ul>
 <p>Turn signal left</p>	<p>The left-hand turn signal is faulty.</p> <ul style="list-style-type: none"> <li>► Replace the bulb as soon as possible (▷ page 233).</li> </ul>
 <p>Turn signal right</p>	<p>The right-hand turn signal is faulty.</p> <ul style="list-style-type: none"> <li>► Replace the bulb as soon as possible (▷ page 233).</li> </ul>
 <p>Brake lamp left</p>	<p>The left-hand brake lamp is faulty<sup>7</sup>.</p> <ul style="list-style-type: none"> <li>► Replace the bulb as soon as possible (▷ page 233).</li> </ul>
 <p>Brake lamp right</p>	<p>The right brake lamp is faulty<sup>7</sup>.</p> <ul style="list-style-type: none"> <li>► Replace the bulb as soon as possible (▷ page 233).</li> </ul>
 <p>Third brake lamp</p>	<p>The high-mounted brake lamp is faulty<sup>7</sup>. This display message will only appear if all LEDs have failed.</p> <ul style="list-style-type: none"> <li>► Visit a qualified specialist workshop as soon as possible.</li> </ul>

<sup>7</sup> Depending on the equipment, the bulb-failure indicator may not be featured for any lamps other than the turn signals.

Display messages	Possible causes/consequences and ► Solutions
 High beam left	The left-hand high-beam is faulty <sup>7</sup> . ► Replace the bulb as soon as possible (▷ page 233).
 High beam right	The right-hand high beam is faulty <sup>7</sup> . ► Replace the bulb as soon as possible (▷ page 233).
 License plate lamp	A license plate lamp is faulty <sup>7</sup> . ► Replace the bulb as soon as possible (▷ page 233).
 Switch off lights	You have forgotten to switch off the lights when leaving the vehicle. ► Turn the light switch to <input type="text" value="0"/> .
 Fog lamp front left	The left-hand front fog lamp is faulty <sup>7</sup> . ► Replace the bulb as soon as possible (▷ page 233).
 Fog lamp front right	The right-hand fog lamp is faulty <sup>7</sup> . ► Replace the bulb as soon as possible (▷ page 233).
 Rear fog lamp	The rear fog lamp is faulty <sup>7</sup> . ► Replace the bulb as soon as possible (▷ page 233).
 Parking lamp front left	The front left parking lamp/standing lamp is faulty <sup>7</sup> . ► Replace the bulb as soon as possible.
 Parking lamp front right	The front right parking lamp/standing lamp is faulty <sup>7</sup> . ► Replace the bulb as soon as possible (▷ page 233).
 Reverse lamp	A backup lamp is faulty <sup>7</sup> . ► Replace the bulb as soon as possible (▷ page 233).
 Tail lamp left	The left-hand tail lamp is faulty <sup>7</sup> . ► Replace the bulb as soon as possible (▷ page 233).
 Tail lamp right	The right-hand tail lamp is faulty <sup>7</sup> . ► Replace the bulb as soon as possible (▷ page 233).



<sup>7</sup> Depending on the equipment, the bulb-failure indicator may not be featured for any lamps other than the turn signals.

Display messages	Possible causes/consequences and ► Solutions
 Marker lamp	A perimeter lamp is faulty <sup>7</sup> . ► Replace the bulb as soon as possible (▷ page 233).
 Additional ind. lamps	An additional turn signal is faulty <sup>7</sup> . ► Visit a qualified specialist workshop as soon as possible.

### Indicator and warning lamps in switches and buttons

#### Warning

The operating safety of your vehicle could be jeopardized if maintenance work is carried out incorrectly. As a result, you could lose control of the vehicle and cause an accident. In addition, the safety systems may no longer be able to protect you or others as they are designed to do. Always have maintenance work carried out at a qualified specialist workshop. The qualified specialist workshop must have the necessary specialist knowledge and tools to carry out the work required. We recommend visiting an authorized Sprinter Dealer. In particular, work relevant to safety or on safety-related systems must be carried out at a qualified specialist workshop.

Problem	Possible causes/consequences and ► Solutions
One or more indicator lamps in the  button for the seat heating are flashing.	Insufficient voltage is available because too many consumers are switched on. The seat heating has switched off automatically. ► Switch off non-essential consumers, e.g. reading lamps, interior lighting. The seat heating will automatically switch back on as soon as there is sufficient voltage.
The indicator lamp in the switch for the windshield heating  and/or the switch for the rear window defroster  are flashing.	Insufficient voltage is available because too many consumers are switched on. The windshield heating and/or rear window defroster have switched off automatically. ► Switch off non-essential consumers, e.g. reading lamps, interior lighting. If sufficient voltage is available again within 30 seconds, the windshield heating and/or rear window defroster automatically switch on again. Otherwise, they remain switched off.





<sup>7</sup> Depending on the equipment, the bulb-failure indicator may not be featured for any lamps other than the turn signals.

## Warning tones

### Warning

The operating safety of your vehicle could be jeopardized if maintenance work is carried out incorrectly. As a result, you could lose control of the vehicle and cause an accident. In addition, the safety systems may no longer be able to protect you or others as they are designed to do.

Always have maintenance work carried out at a qualified specialist workshop. The qualified specialist workshop must have the necessary specialist knowledge and tools to carry out the work required. We recommend visiting an authorized Sprinter Dealer. In particular, work relevant to safety or on safety-related systems must be carried out at a qualified specialist workshop.



Problem	Possible causes/consequences and ► Solutions
The anti-theft alarm system is suddenly triggered.	<p>You opened the vehicle using the key without first deactivating the anti-theft alarm system.</p> <ul style="list-style-type: none"> <li>► Press the  or  button on the remote control.</li> <li>or</li> <li>► Insert the key into the ignition lock. The anti-theft alarm system is deactivated.</li> </ul>
A warning tone sounds.	<p>A message is shown in the display.</p> <ul style="list-style-type: none"> <li>► Observe the information for the messages (► page 197).</li> </ul>
A warning tone sounds.	<p>You are driving with the parking brake applied.</p> <ul style="list-style-type: none"> <li>► Release the parking brake (► page 112).</li> </ul>
A warning tone sounds.	<p>You have opened the driver's door and forgotten to switch off the lights.</p> <ul style="list-style-type: none"> <li>► Turn the light switch to .</li> </ul>
A warning tone sounds.	<p> <b>Warning!</b></p> <p>You have not fastened your seat belt.</p> <ul style="list-style-type: none"> <li>► Fasten your seat belt (► page 32).</li> </ul>

## Engine

### Warning

The operating safety of your vehicle could be jeopardized if maintenance work is carried out incorrectly. As a result, you could lose control of the vehicle and cause an accident. In addition, the safety systems may no longer be able to protect you or others as they are designed to do.

Always have maintenance work carried out at a qualified specialist workshop. The qualified specialist workshop must have the necessary specialist knowledge and tools to carry out the work required. We recommend visiting an authorized Sprinter Dealer. In particular, work relevant to safety or on safety-related systems must be carried out at a qualified specialist workshop.

Problem	Possible causes/consequences and ► Solutions
<p>The engine does not start. The starter motor can be heard.</p>	<p>There is air in the fuel system.</p> <ul style="list-style-type: none"> <li>► Turn the key back to position <b>0</b> in the ignition lock before attempting to start the engine again.</li> <li>► Start the engine again. Please bear in mind that lengthy and frequent starting attempts will drain the battery.</li> </ul> <p>If the engine does not start after several attempts:</p> <ul style="list-style-type: none"> <li>► Consult a qualified specialist workshop.</li> </ul>
<p>The engine does not start. The starter motor can be heard. The reserve fuel warning lamp is lit and the fuel gauge is at <b>0</b>.</p>	<p>The fuel tank has been run dry.</p> <ul style="list-style-type: none"> <li>► Refuel the vehicle.</li> <li>► Bleed the fuel system .</li> </ul>
<p>The engine does not start. The starter motor cannot be heard. The  yellow engine diagnostic lamp and the yellow DEF indicator lamp <sup>8</sup> lights up.</p>	<p>The exhaust gas aftertreatment is faulty, an emission-relevant malfunction has occurred or the DEF reserve has been used up. The engine management prevents the engine from starting. This malfunction or malfunction can damage the exhaust gas aftertreatment.</p> <ul style="list-style-type: none"> <li>► Observe the messages in the display:                             <ul style="list-style-type: none"> <li>• on vehicles without steering-wheel buttons (&gt; page 199)</li> <li>• on vehicles with steering-wheel buttons (&gt; page 202) and (&gt; page 204).</li> </ul> </li> </ul>
<p>The engine does not start. The starter motor cannot be heard.</p>	<p>The battery isolating switch is switched off.</p> <ul style="list-style-type: none"> <li>► Switch on the power supply (&gt; page 88).</li> </ul>
<p>The engine does not start. The starter motor cannot be heard.</p>	<p>The on-board voltage is too low (the battery is too weak or discharged).</p> <ul style="list-style-type: none"> <li>► Jump-start the vehicle (&gt; page 247).</li> </ul> <p>If the engine does not start despite attempts to jump-start it:</p> <ul style="list-style-type: none"> <li>► Consult a qualified specialist workshop.</li> </ul>

<sup>8</sup> Only vehicles without steering-wheel buttons.

Problem	Possible causes/consequences and ► Solutions
The engine does not start. The starter motor cannot be heard.	The battery is discharged or faulty. ► Check the battery for damage. ► Charge the battery (▷ page 178).
The engine does not start. The starter motor cannot be heard.	The starter is faulty. ► Have the starter checked at a qualified specialist workshop.

### Automatic transmission

#### Warning

The operating safety of your vehicle could be jeopardized if maintenance work is carried out incorrectly. As a result, you could lose control of the vehicle and cause an accident. In addition, the safety systems may no longer be able to protect you or others as they are designed to do. Always have maintenance work carried out at a qualified specialist workshop. The qualified specialist workshop must have the necessary specialist knowledge and tools to carry out the work required. We recommend visiting an authorized Sprinter Dealer. In particular, work relevant to safety or on safety-related systems must be carried out at a qualified specialist workshop.



Problem	Possible causes/consequences and ► Solutions
The transmission no longer changes gear correctly.	The transmission is losing oil. ► Have the transmission checked immediately at a qualified specialist workshop.
The acceleration characteristics have deteriorated noticeably. The transmission does not shift.	The transmission is in emergency mode. It is only possible to shift into second gear or reverse gear. ► Stop the vehicle. ► Depress the brake pedal. ► Move the selector lever to position <b>P</b> . ► Switch off the engine. ► Wait at least 10 seconds before restarting the engine. ► Depress the brake pedal. ► Move the selector lever to position <b>D</b> or <b>R</b> . ► In position <b>D</b> , the transmission shifts into second gear; in position <b>R</b> , the transmission shifts into reverse gear. ► Have the transmission checked immediately at a qualified specialist workshop.



**Driving systems**

 **Warning**

The operating safety of your vehicle could be jeopardized if maintenance work is carried out incorrectly. As a result, you could lose control of the vehicle and cause an accident. In addition, the safety systems may no longer be able to protect you or others as they are designed to do. Always have maintenance work carried out at a qualified specialist workshop. The qualified specialist workshop must have the necessary specialist knowledge and tools to carry out the work required. We recommend visiting an authorized Sprinter Dealer. In particular, work relevant to safety or on safety-related systems must be carried out at a qualified specialist workshop.

<b>Problem</b>	<b>Possible causes/consequences and ► Solutions</b>
<p>Only the red segments in the PARKTRONIC warning displays are lit. A warning tone also sounds for approximately two seconds.</p> <p>PARKTRONIC is deactivated after approximately 20 seconds.</p> <p>The indicator lamp on the  switch lights up and the red segments in the PARKTRONIC warning display go out.</p>	<p>PARKTRONIC has malfunctioned and has switched itself off. When you press the  switch, the red segments in the PARKTRONIC warning displays light up again and the warning tone sounds for approximately two seconds.</p> <ul style="list-style-type: none"> <li>► Have PARKTRONIC checked as soon as possible at a qualified specialized workshop.</li> </ul>
<p>The PARKTRONIC warning displays implausible distances. For example, all the segments may be lit even though there is no obstacle present.</p>	<p>The PARKTRONIC sensors are dirty or iced up.</p> <ul style="list-style-type: none"> <li>► Clean the PARKTRONIC sensors (► page 163).</li> <li>► Turn the key to position <b>2</b> again in the ignition lock.</li> </ul>
<p>The PARKTRONIC warning displays implausible distances. For example, all the segments may be lit even though there is no obstacle present.</p>	<p>An external radio or ultrasonic source may be causing interference.</p> <ul style="list-style-type: none"> <li>► Check PARKTRONIC functions in a different location.</li> </ul>

Problem	Possible causes/consequences and ► Solutions
<p>The PARKTRONIC warning displays implausible distances. For example, all the segments may be lit even though there is no obstacle present.</p>	<p>The license plate or other parts attached near the sensors may not be secured correctly.</p> <ul style="list-style-type: none"> <li>► Check the license plate and attachment parts near the sensors for correct seating.</li> </ul>
<p>The speed cannot be set when cruise control is activated<sup>9</sup>.</p>	<p>The display is showing a message of high priority and cannot therefore show a change in speed.</p> <ul style="list-style-type: none"> <li>► Proceed as instructed by the message in the display.</li> <li>► Deactivate cruise control</li> </ul>
<p>White stripes appear on the rear view camera's monitor display or the picture flickers.</p>	<p>The rear view camera is exposed to very bright white light or fluorescent light.</p> <ul style="list-style-type: none"> <li>► Check whether the rear view camera works at another location.</li> </ul>
<p>The rear view camera is functioning incorrectly or not at all.</p>	<ul style="list-style-type: none"> <li>• The surrounding area is very dark.</li> <li>• The outside temperature has changed rapidly or is very high.</li> <li>• The camera lens is dirty or obstructed.</li> </ul> <p>► Check the rear view camera and clean the camera lens if necessary (► page 163).</p>

## Auxiliary heating

### Warning

The operating safety of the vehicle can be compromised if maintenance work is carried out incorrectly. In particular, work that is carried out incorrectly on the heater jeopardizes its operating safety. This could cause you to lose control of the vehicle and cause an accident. The safety systems may also not be able to protect you or others as they are designed to do.

Always have maintenance work carried out at a qualified specialist workshop. The qualified specialist workshop must have the necessary specialist knowledge and tools to carry out the work required. We recommend that you use an authorized Sprinter Dealer for this purpose. In particular, work relevant to safety or on safety-related systems must be carried out at a qualified specialist workshop.

<sup>9</sup> Only on vehicles with steering wheel buttons.

Problem	Possible causes/consequences and ► Solutions
The auxiliary heating does not switch on.	The outside temperature is above 39 °F (4 °C). The auxiliary heating switches off automatically.
The auxiliary heating does not switch on.	Lack of fuel The tank is less than one quarter full. The auxiliary heating switches off automatically. <ul style="list-style-type: none"> <li>► Refuel at the nearest gas station.</li> <li>► Then, start the auxiliary heating several times until the fuel lines are full.</li> </ul>
The auxiliary heating does not switch on.	The undervoltage protection circuit integrated in the control unit switches off the auxiliary heating because the on-board voltage is less than 10 V. <ul style="list-style-type: none"> <li>► Have the alternator and battery checked.</li> </ul>
The auxiliary heating does not switch on.	The fuse is blown. <ul style="list-style-type: none"> <li>► Replace the fuse (► page 239).</li> <li>► Have the cause of the blown fuse determined at a qualified specialist workshop.</li> </ul>
The auxiliary heating does not switch on.	The heater is faulty. <ul style="list-style-type: none"> <li>► Have the auxiliary heating checked at a qualified specialist workshop.</li> </ul>
The auxiliary heating is overheated.	The coolant level is too low. <ul style="list-style-type: none"> <li>► Check the coolant level and top up if necessary (► page 169).</li> </ul>

### Central locking system

#### Warning

The operating safety of your vehicle could be jeopardized if maintenance work is carried out incorrectly. As a result, you could lose control of the vehicle and cause an accident. In addition, the safety systems may no longer be able to protect you or others as they are designed to do. Always have maintenance work carried out at a qualified specialist workshop. The qualified specialist workshop must have the necessary specialist knowledge and tools to carry out the work required. We recommend visiting an authorized Sprinter Dealer. In particular, work relevant to safety or on safety-related systems must be carried out at a qualified specialist workshop.

Problem	Possible causes/consequences and ► Solutions
<p>It is no longer possible to lock the vehicle using the remote control.</p> <p>The turn signals do not flash when the vehicle is locked.</p>	<p>The doors are not closed properly.</p> <ul style="list-style-type: none"> <li>► Close the doors properly and lock the vehicle again.</li> </ul>
<p>It is no longer possible to lock the vehicle using the remote control.</p> <p>The turn signals do not flash when the vehicle is locked.</p>	<p>The central locking system has malfunctioned.</p> <ul style="list-style-type: none"> <li>► Lock the vehicle using the folding key (► page 54).</li> <li>► Have the central locking system checked as soon as possible at a qualified specialist workshop.</li> </ul>
<p>It is no longer possible to lock or unlock the vehicle using the remote control.</p>	<p>The remote control batteries are weak or discharged.</p> <ul style="list-style-type: none"> <li>► Point the remote control at the driver's door handle at close range and try again.</li> </ul> <p>If this does not work:</p> <ul style="list-style-type: none"> <li>► Lock or unlock the vehicle with the folding key (► page 54).</li> <li>► Check the batteries of the remote control (► page 53).</li> </ul>
<p>It is no longer possible to lock or unlock the vehicle using the remote control.</p>	<p>The remote control is faulty.</p> <ul style="list-style-type: none"> <li>► Lock or unlock the vehicle with the folding key (► page 54).</li> <li>► Have the central locking system checked as soon as possible at a qualified specialist workshop.</li> </ul>
<p>You have lost a key.</p>	<ul style="list-style-type: none"> <li>► Have the key deactivated at an authorized Sprinter Dealer.</li> <li>► Report the loss immediately to the vehicle insurers.</li> <li>► If necessary, have the mechanical locks replaced.</li> </ul> <p>Your qualified specialist workshop will be happy to provide you with a replacement.</p>

Problem	Possible causes/consequences and ► Solutions
<p>The key cannot be turned in the ignition lock.</p>	<p>The vehicle voltage is too low.</p> <ul style="list-style-type: none"> <li>► Switch off all non-essential consumers, e.g. the seat heating, interior lighting, and try to turn the key again.</li> </ul> <p>If this does not work:</p> <ul style="list-style-type: none"> <li>► Check and, if necessary, replace the starter battery.</li> </ul> <p>or</p> <ul style="list-style-type: none"> <li>► Jump-start the vehicle.</li> </ul> <p>or</p> <ul style="list-style-type: none"> <li>► Consult a qualified specialist workshop.</li> </ul>
<p>The key cannot be turned in the ignition lock.</p>	<p>The steering lock has jammed mechanically.</p> <ul style="list-style-type: none"> <li>► Remove the key and insert it again into the ignition lock. Turn the steering wheel from side to side while doing so.</li> </ul>

### Headlamps and turn signals

#### Warning

The operating safety of your vehicle could be jeopardized if maintenance work is carried out incorrectly. As a result, you could lose control of the vehicle and cause an accident. In addition, the safety systems may no longer be able to protect you or others as they are designed to do. Always have maintenance work carried out at a qualified specialist workshop. The qualified specialist workshop must have the necessary specialist knowledge and tools to carry out the work required. We recommend visiting an authorized Sprinter Dealer. In particular, work relevant to safety or on safety-related systems must be carried out at a qualified specialist workshop.

Problem	Possible causes/consequences and ► Solutions
<p>The headlamps are fogged up on the inside.</p>	<p>Air humidity is very high.</p> <ul style="list-style-type: none"> <li>► Drive with the headlamps switched on.</li> </ul> <p>The headlamps are clear after a short distance.</p>
<p>The headlamps are fogged up on the inside.</p>	<p>The headlamp housing is not sealed and moisture has been able to enter.</p> <ul style="list-style-type: none"> <li>► Have the headlamps checked at a qualified specialist workshop.</li> </ul>

### Windshield wipers

#### Warning

The operating safety of your vehicle could be jeopardized if maintenance work is carried out incorrectly. As a result, you could lose control of the vehicle and cause an accident. In addition, the safety systems may no longer be able to protect you or others as they are designed to do.

Always have maintenance work carried out at a qualified specialist workshop. The qualified specialist workshop must have the necessary specialist knowledge and tools to carry out the work required. We recommend visiting an authorized Sprinter Dealer. In particular, work relevant to safety or on safety-related systems must be carried out at a qualified specialist workshop.

Problem	Possible causes/consequences and ► Solutions
The windshield wipers are jammed.	<p>The wiper movement is obstructed, e.g. by leaves or snow. The wiper motor has been deactivated.</p> <ul style="list-style-type: none"> <li>► Stop the vehicle as soon as possible. For safety reasons, remove the key from the ignition lock.</li> <li>► Remove the cause of the obstruction.</li> <li>► Switch on the windshield wipers again.</li> </ul>
The windshield wipers have stopped working completely.	<p>There is a malfunction in the windshield wiper drive.</p> <ul style="list-style-type: none"> <li>► Select another wiper speed on the combination switch.</li> <li>► Have the windshield wipers checked at a qualified specialist workshop.</li> </ul>

## Fuel and fuel tank

### Warning

The operating safety of your vehicle could be jeopardized if maintenance work is carried out incorrectly. As a result, you could lose control of the vehicle and cause an accident. In addition, the safety systems may no longer be able to protect you or others as they are designed to do.

Always have maintenance work carried out at a qualified specialist workshop. The qualified specialist workshop must have the necessary specialist knowledge and tools to carry out the work required. We recommend visiting an authorized Sprinter Dealer. In particular, work relevant to safety or on safety-related systems must be carried out at a qualified specialist workshop.

Problem	Possible causes/consequences and ► Solutions
The fuel tank has run completely dry.	<p>There is air in the fuel system.</p> <ul style="list-style-type: none"> <li>► Bleed the fuel system .</li> </ul>
Fuel is leaking from the vehicle.	<p> <b>Warning!</b></p> <p>The fuel line or the fuel tank is damaged. Leaking fuel creates a risk of fire or explosion.</p> <ul style="list-style-type: none"> <li>► Switch off the ignition immediately.</li> <li>► Remove the key from the ignition lock.</li> <li>► Do not restart the engine under any circumstances.</li> <li>► Consult a qualified specialist workshop.</li> </ul>

## Engine

### Draining the fuel filter

If the  indicator lamp lights up, you must drain the fuel filter.

**!** When the  indicator lamp lights up, drain the fuel filter with water separator immediately. Otherwise, the engine may be damaged.

#### Environmental note

When handling, storing and disposing of diesel and diesel mixtures, please observe the relevant regulations.

To this end, have the fuel filter with water separator drained at a qualified specialist workshop which has the necessary specialist knowledge and tools to carry out the work required, e.g. an authorized Sprinter Dealer.

The fuel filter with water separator is in the engine compartment.

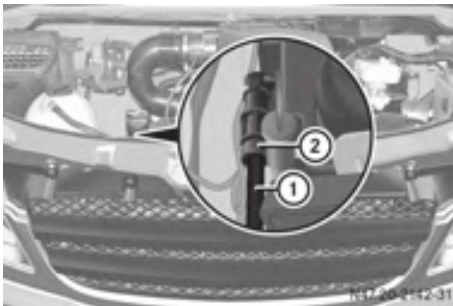

- ▶ Apply the parking brake and move the automatic transmission selector lever to **P**.
- ▶ Switch off the diesel engine and open the hood (▷ page 168).
- ▶ Place a suitable receptacle under drain hose ①.
- ▶ Turn the key to position **2** in the ignition lock.
- ▶ Open drain plug ② immediately until liquid flows out of drain hose ①. Make sure that

the liquid flows into the receptacle under drain hose ①.

- ▶ Screw in drain plug ② as soon as approximately 0.2 US qt (0.2 l) of liquid have been collected.

**i** The electric fuel pump stops the flow of liquid automatically after 30 seconds.

- ▶ After draining, turn the key back to position **0** in the ignition lock.
- ▶ Dispose of the liquid in an environmentally responsible manner.

#### Environmental note

Have the drained liquid disposed of at a qualified specialist workshop, e.g. an authorized Sprinter Dealer.

- ▶ Drain the fuel filter again if the  indicator lamp remains lit.

**!** If the  indicator lamp remains lit even after draining for the second time, have the cause checked immediately at a qualified specialist workshop, e.g. at an authorized Sprinter Dealer.

### Bleeding the fuel system

## Wheels and tires

### General notes

The vehicle is equipped either with a spare wheel or with Premium tire sealant. The spare wheel is under the rear of the vehicle (▷ page 185). The Premium tire sealant is located in the stowage compartment in the right-hand door sill (▷ page 184).

#### Warning

Defective or worn tires, and underinflated or overinflated tires, can cause significant changes in the vehicle's handling and braking characteristics. There is an increased risk of an accident.

Replace the tires, including the spare wheel, at least every six years. They should be replaced regardless of the degree of tread wear. Check the tire pressure on the spare wheel at regular intervals.

If you replace a tire, we also recommend that you replace the tire valve.

### **Warning!**

Only for vehicles without a tire pressure monitor:

For safety reasons, we recommend that you only use tire valves manufactured by Schrader. These have been tested for use on your vehicle.

Use only tire valves of type:

- TR 600 for the vehicle types 2500
- TR 418 for the vehicle types 3500

Using other tire inflation valves or valves made by other manufacturers can result in tire pressure loss and thereby impair the operating safety of the vehicle.

You will find safety-relevant information on tires and wheels in the "Tires and wheels" section (▷ page 252).

### **Preparing the vehicle**

- ▶ Stop the vehicle as far away as possible from traffic and on a level, firm and non-slip surface.
- ▶ Switch on the hazard warning lamps.
- ▶ Apply the parking brake.
- ▶ Move the selector lever of the automatic transmission to position **P**.
- ▶ Any passengers should leave the vehicle, ensuring that they are not endangered as they do so.
- ▶ Place the warning triangle or hazard warning lights at a suitable distance. Observe legal requirements.

### **Using tire sealant**

You can use the Premium tire sealant to seal small punctures, particularly those in the tire tread. Tire sealant can be used at outside temperatures down to  $-22\text{ }^{\circ}\text{F}$  ( $-30\text{ }^{\circ}\text{C}$ ).

### **Warning**

Smoking, fire and naked flames are prohibited when handling tire sealant. Avoid creating sparks. The tire sealant could otherwise ignite and cause a fire.

### **Warning**

Your safety is at particular risk and the tire sealant is unable to repair a tire in the following situations:

- if there are cuts or punctures in the tire larger than 0.23 inches (6 mm)
- if the rim is damaged
- if you have driven with very low tire pressures or with flat tires

Do not drive any further. Consult a qualified specialist workshop which has the necessary specialist knowledge and tools to carry out the work required.

For this reason, we recommend an authorized Sprinter Dealer. In particular, work relevant to safety or on safety-related systems must be carried out at a qualified specialist workshop.

- ▶ Prepare the vehicle as described (▷ page 222).
- ▶ Before using Premium tire sealant, you should stop the vehicle so that the damage on the tire is at the bottom.
- ▶ It is beneficial to the sealing process if you remove the foreign body that has pierced the tire, e.g. a screw or a nail.
- ▶ Remove the Premium tire sealant, the accompanying "max. 50 mph" ("max. 80 km/h") sticker and the tire inflation compressor from the stowage



compartment in the right-hand doorway (▷ page 184).

- ▶ Affix the sticker within the driver's field of vision.

**Warning**

It is essential to comply with the manufacturer's safety notice on the sticker on the electric air pump and the tire sealant bottle. You could otherwise fail to recognize dangers and injure yourself and others.

**Warning**

Tire sealant must not come into contact with your skin, eyes or clothing. Do not inhale the fumes.

- If tire sealant comes into contact with your eyes or skin, immediately rinse thoroughly with clean water.
- Immediately change out of clothing that has been in contact with tire sealant.
- If an allergic reaction occurs, consult a doctor immediately.

Keep tire sealant away from children.

- If tire sealant is swallowed, immediately rinse your mouth out thoroughly and drink plenty of water.
- Do not induce vomiting. Consult a doctor immediately.

- 1** The tire sealant is water-soluble. If tire sealant escapes, you can wash it away with water.

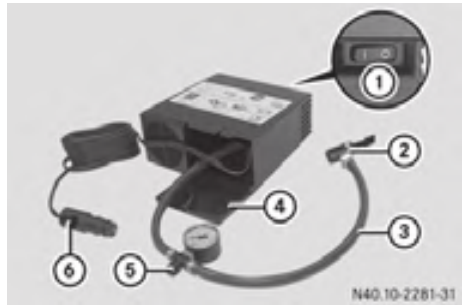

Tire inflation compressor

- ① Switch
- ② Angled connecting piece
- ③ Tire inflation compressor hose
- ④ Flap
- ⑤ Pressure gauge with pressure release screw
- ⑥ Connector with cable

- ▶ Open flap ④ of the tire inflation compressor.
- ▶ Pull connector ⑥ and hose ③ with pressure gauge ⑤ from the housing.

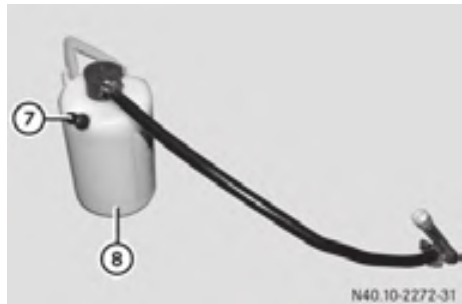

Tire sealant bottle for single tires

- ⑦ Valve
- ⑧ Tire sealant bottle with hook, hose and valve core extractor

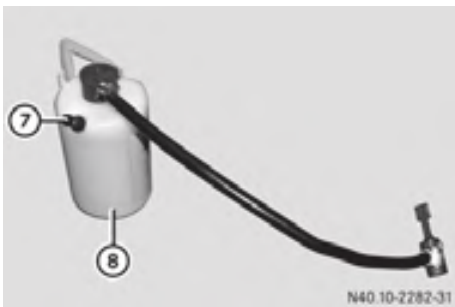

Tire sealant bottle for twin tires

⑦ Valve

⑧ Tire sealant bottle with hook, hose and angled connecting piece

- ▶ Shake tire sealant bottle ⑧.
- ▶ Unscrew and remove the cap from valve ⑦ of tire sealant bottle ⑧.
- ▶ Push angled connecting piece ② located on hose ③ of the tire inflation compressor as far as it will go onto valve ⑦ of tire sealant bottle ⑧ and fix in place.

The following steps differ depending on the vehicle tires.

- Single tire (▷ page 224)
- Twin tires, inner wheels (▷ page 225)
- Twin tires, outer wheels (▷ page 226)

### Single tire

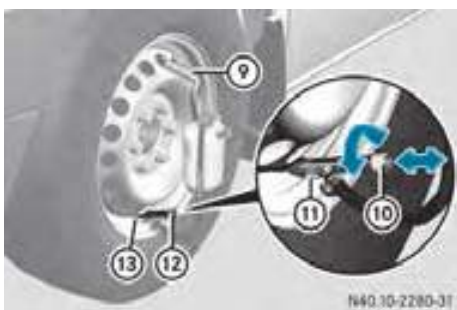

⑨ Hook

⑩ Button

⑪ Lever

⑫ Valve core extractor

⑬ Tire valve

- ▶ Pull knob ⑩ out of valve core extractor ⑫ as far as it will go.
- ▶ Remove the cap from valve ⑬ on the defective tire.
- ▶ Hook tire sealant bottle ⑧ into the upper vent hole in the wheel using hook ⑨.
- ▶ Keep pressing lever ⑪, place valve core extractor ⑫ firmly onto tire valve ⑬ and then release lever ⑪.
- ▶ Press knob ⑩ into the valve core of valve ⑬, turning it gently as you do so, until the shaft of valve core extractor ⑫ engages.
- ▶ Turn knob ⑩ counter-clockwise until the valve core is unscrewed.
- ▶ Pull knob ⑩ out of valve core extractor ⑫ as far as it will go.

This pulls the valve core into the valve core extractor and seals it against the valve core extractor stop.

- ▶ Make sure that the pressure release screw on pressure gauge ⑤ is closed.
- ▶ Connect connector ⑥ to the 12 V socket (12 V, 25 A, 300 W) on the center console (▷ page 133).

**!** Only use the 12 V socket on the center console to connect the electric air pump. You could otherwise damage the vehicle's electrics.

- ▶ Start the engine.
- ▶ Press I on tire inflation compressor switch ①.

The tire inflation compressor is activated. The tire sealant is then pumped into the tire and the tire pressure is increased. Let the tire inflation compressor run for at least 10 minutes until tire sealant bottle ⑧ is completely empty and the tire pressure is at least 43.5 psi (3.0 bar).

**!** Do not run the electric air pump for longer than 20 minutes without a break; otherwise it may overheat.

The air pump can be used again once it has cooled down.

- ▶ Inflate the tire using the tire inflation compressor until the recommended tire pressure (▷ page 281) is reached.
- ▶ Then, press **0** on tire inflation compressor switch ①.
- The tire inflation compressor is deactivated.
- ▶ Slide knob ⑩ quickly to the stop in valve core extractor ⑫.
- ▶ Turn knob ⑩ clockwise until the valve core is firmly screwed into tire valve ⑬.

**i** Do not pull the valve core extractor from the tire valve while the valve core is unscrewed from the tire valve. Tire sealant could otherwise escape and make you dirty.

The tire sealant is water-soluble. If tire sealant escapes, you can wash it away with water.

- ▶ Press lever ⑪ and pull valve core extractor ⑫ from tire valve ⑬.
- ▶ Screw the valve cap onto tire valve ⑭.

After filling with tire sealant, (▷ page 228).

### Twin tires, inner wheels

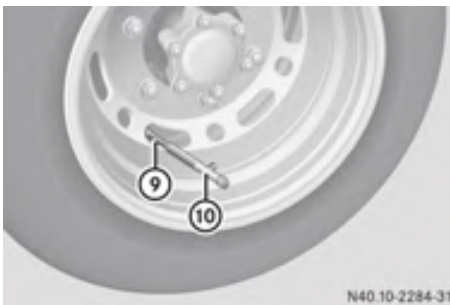

- ⑨ Valve extension
- ⑩ Valve core extractor

- ▶ Unscrew the valve cap from valve extension ⑨ on the defective wheel.
- ▶ Screw valve core extractor ⑩ clockwise as far as it will go onto valve extension ⑨.
- ▶ Screw valve core extractor ⑩ approximately a further half turn to release the valve extension.
- ▶ Unscrew the valve extension and the valve core extractor counter-clockwise from the tire valve.
- ▶ Unscrew the valve extension from the valve core extractor.

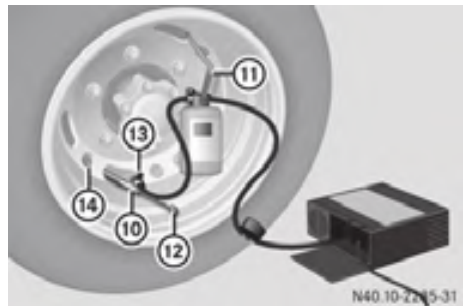

- ⑩ Valve core extractor
  - ⑪ Hook
  - ⑫ Button
  - ⑬ Angled connecting piece
  - ⑭ Tire valve
- ▶ Pull knob ⑫ out of valve core extractor ⑩ as far as it will go.
  - ▶ Screw valve core extractor ⑩ clockwise onto tire valve ⑭.
  - ▶ Press knob ⑫ into the valve core of valve ⑭, turning it gently as you do so, until the shaft of valve core extractor ⑩ engages.
  - ▶ Turn knob ⑫ counter-clockwise until the valve core is unscrewed.
  - ▶ Pull knob ⑫ out of valve core extractor ⑩ as far as it will go.
- This pulls the valve core into the valve core extractor and seals it against the valve core extractor stop.

- ▶ Hook tire sealant bottle (8) into the upper vent hole in the wheel using hook (11).
- ▶ Push angled connecting piece (13) located on the hose of tire sealant filler bottle (8) as far as it will go on to valve core extractor (10) and fix it in place.
- ▶ Make sure that the pressure release screw on pressure gauge (5) is closed.
- ▶ Connect connector (6) to the 12 V socket (12 V, 25 A, 300 W) on the center console (▶ page 133).

**!** Only use the 12 V socket on the center console to connect the electric air pump. You could otherwise damage the vehicle's electrics.

- ▶ Start the engine.
- ▶ Press **I** on tire inflation compressor switch (1).

The tire inflation compressor is activated. The tire sealant is then pumped into the tire and the tire pressure is increased. Let the tire inflation compressor run for at least 10 minutes until tire sealant bottle (8) is completely empty and the tire pressure is at least 43.5 psi (3.0 bar).

**!** Do not run the electric air pump for longer than 20 minutes without a break; otherwise it may overheat.

The air pump can be used again once it has cooled down.

- ▶ Inflate the tire using the tire inflation compressor until the recommended tire pressure (▶ page 281) is reached.
- ▶ Then, press **0** on tire inflation compressor switch (1).  
The tire inflation compressor is deactivated.
- ▶ Slide knob (12) quickly to the stop in valve core extractor (10).
- ▶ Turn knob (12) clockwise until the valve core is firmly screwed into tire valve (14).

**i** Do not pull the valve core extractor from the tire valve while the valve core is unscrewed from the tire valve. Tire sealant could otherwise escape and make you dirty.

The tire sealant is water-soluble. If tire sealant escapes, you can wash it away with water.

- ▶ Pull knob (12) out of valve core extractor (10) as far as it will go.
- ▶ Unscrew valve core extractor (10) counter-clockwise from tire valve (14).
- ▶ Screw valve extension (9) onto tire valve (14) and tighten it.
- ▶ Screw the valve cap onto valve extension (9).

After filling with tire sealant, (▶ page 228).

### Twin tires, outer wheel

The tire valve is located on the inside of the outer wheel and should be positioned horizontally on the left side of the wheel for the repair process.

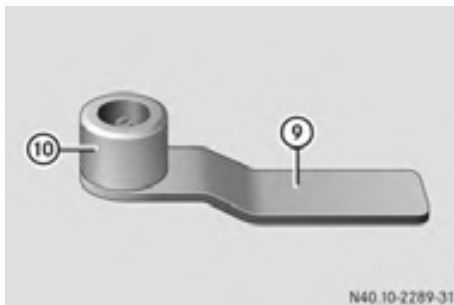

Valve tool with handle and turning piece

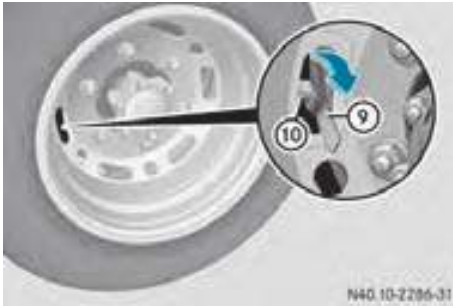

- ⑨ Handle
- ⑩ Turning piece

- ▶ Remove the cap from valve ⑪ on the defective tire.
- ▶ Guide the valve tool through the gap in the wheel and push it onto tire valve ⑪.
- ▶ Hold handle ⑨ of the valve tool with one hand and unscrew the valve core with the other hand using turning piece ⑩ of the valve tool.
- ▶ Remove the valve tool through the gap carefully, so that the valve core remains engaged in the valve tool.

**i** If the valve insert is damaged or lost when it is unscrewed, you can use the valve insert of the tire sealant bottle after you have used the tire sealant (▷ page 228).

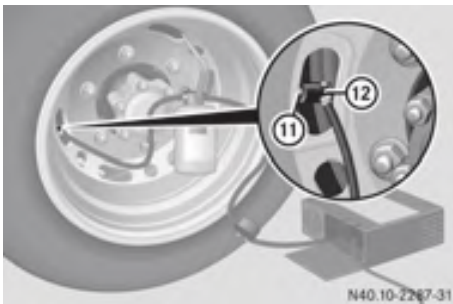

- ⑪ Tire valve
- ⑫ Angled connecting piece

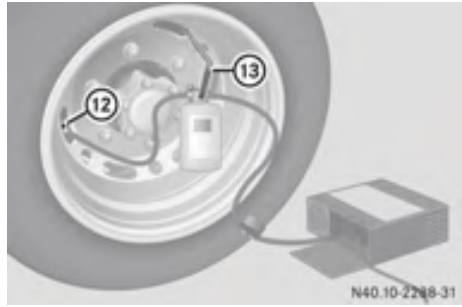

- ⑫ Angled connecting piece
- ⑬ Hook

- ▶ Hook tire sealant bottle ⑧ into the upper vent hole in the wheel using hook ⑬.
- ▶ Push angled connecting piece ⑫ located on the hose of tire sealant filler bottle ⑧ as far as it will go onto valve ⑪ and fix it in place.
- ▶ Make sure that the pressure release screw on pressure gauge ⑤ is closed.
- ▶ Connect connector ⑥ to the 12 V socket (12 V, 25 A, 300 W) on the center console (▷ page 133).

**!** Only use the 12 V socket on the center console to connect the electric air pump. You could otherwise damage the vehicle's electrics.

- ▶ Start the engine.
- ▶ Press **I** on the ① switch on the tire inflation compressor. The tire inflation compressor is activated. The tire sealant is then pumped into the tire and the tire pressure is increased. Run the tire inflation compressor until tire sealant bottle ⑧ is completely empty.
- ▶ Press **0** on tire inflation compressor switch ① after about 15 seconds.
- ▶ Loosen angled connecting piece ⑫ from tire valve ⑪ and remove it.
- ▶ Screw in the valve core again using the valve tool and remove the valve tool through the opening.

- i** If the valve insert is damaged or lost when it is unscrewed, you can use the valve insert of the tire sealant bottle after you have used the tire sealant.
- ▶ Unscrew the valve insert from the valve of the tire sealant bottle using the valve extractor.
- !** Do not run the electric air pump for longer than 20 minutes without a break; otherwise it may overheat.  
The air pump can be used again once it has cooled down.
- ▶ Push angled connecting piece ② located on tire inflation compressor hose ③ as far as it will go onto valve ⑪ and fix it in place.
- ▶ Push **I** on tire inflation compressor switch ① and inflate the tire to the recommended tire pressure (▷ page 281).
- ▶ Then, press **0** on tire inflation compressor switch ①.  
The tire inflation compressor is deactivated.
- i** The tire sealant is water-soluble. If tire sealant escapes, you can wash it away with water.
- ▶ Screw the valve cap onto tire valve ⑪.

After filling with tire sealant, (▷ page 228).

### After filling with tire sealant

- ▶ Turn the pressure release screw on pressure gauge ⑤ counter-clockwise and bleed the system.
- ▶ Turn the key to position **0** in the ignition lock.
- ▶ Pull the tire inflation compressor connector out of the 12 V socket.
- ▶ Stow the tire inflation compressor, tire sealant bottle ⑧ with the valve core extractor and/or valve tool, the warning

triangle and hazard warning lights inside the vehicle.

- ▶ Remove angled connecting piece ② from valve ⑦ of tire sealant filler bottle ⑧ and screw the valve cap onto the valve.

### Warning

You must not exceed a maximum speed of 50 mph (80 km/h).

The "max. 50 mph" (80 km/h) sticker must be affixed within the driver's field of vision.

The vehicle's handling characteristics may be affected.

- ▶ Pull away immediately.  
This enables the tire sealant to distribute inside the tire and create a more effective seal.
- ▶ Stop after driving for about three minutes and check the tire pressure using the tire inflation compressor, for example.
- i** You must connect the angled connecting piece on hose ③ of the tire inflation compressor directly to the tire valve on the tire.
- ▶ Correct the tire pressure accordingly if it does not correspond to the recommended tire pressure (▷ page 281).
- ▶ **To increase the tire pressure:** switch on the tire inflation compressor.
- ▶ **To reduce the tire pressure:** open the pressure release screw on pressure gauge ⑤.
- ▶ Drive to the nearest workshop and have the tire repaired or replaced.
- ▶ Clean the valve core extractor with clean water.
- ▶ Have tire sealant bottle ⑧ replaced as soon as possible at a qualified specialist workshop, e.g. an authorized Sprinter Dealer.

 **Warning**

If the minimum tire pressure of 43.5 psi (3 bar) still cannot be achieved, the tire is too badly damaged.

Do not drive any further. Consult a qualified specialist workshop which has the necessary specialist knowledge and tools to carry out the work required.

For this reason, we recommend an authorized Sprinter Dealer. In particular, work relevant to safety or on safety-related systems must be carried out at a qualified specialist workshop.

 **Environmental note**

Have the used tire sealant disposed of at a qualified specialist workshop, e.g. an authorized Sprinter Dealer.

-  Have the tire sealant bottle replaced every eight years at a qualified specialist workshop, e.g. an authorized Sprinter Dealer.

**Changing a wheel in the event of a flat tire** **Warning**

To avoid the risk of serious or even fatal injury and to avoid damage to the vehicle, observe the following:

- the vehicle's jack is intended only to raise the vehicle for a short time when changing a wheel.
- position the jack on the appropriate jacking point only. Make sure that the jack is correctly positioned under the jacking point before raising the vehicle.
- the jack must be placed on a firm, flat surface.
- before raising the vehicle, you should also secure it against rolling away, e.g. by placing chocks under the wheels. Never release the parking brake while the vehicle is raised.

- make sure that the distance between the underside of the tires and the ground does not exceed 1.2 in (3 cm). The vehicle could otherwise slip off the jack or tip over.
- never place your hands or feet under the raised vehicle.
- never start the engine, and prevent other jolts or vibrations while the vehicle is raised. The vehicle could otherwise slip off the jack.

**Preparing to change a wheel**

- ▶ Prepare the vehicle as described (▷ page 222).
- ▶ Secure the vehicle against rolling away using chocks or similar items. Use the chock (▷ page 183) to do so.

 **Warning**

The vehicle could slip off the jack on uphill and downhill gradients.

To avoid the risk of causing serious or even fatal injury or damage to the vehicle, do not change wheels on uphill and downhill gradients.

On a level road:

- ▶ Place chocks in front of and behind the wheel which is diagonally opposite the wheel you wish to change.
- ▶ Take the vehicle tool kit and the jack from the footwell on the co-driver's side (▷ page 182).
- ▶ Remove the spare wheel from the spare wheel bracket (▷ page 185).
- ▶ On wheels with wheel bolts, remove the hub cap.
- ▶ Assemble the lug wrench extension using the middle rod and the rod with the largest diameter from the three-piece jack pump lever.
- ▶ Starting with the middle rod, slide the lug wrench extension as far as it will go onto the lug wrench.

**!** Only use the jack pump lever middle rod and the rod with the largest diameter as a lug wrench extension. Only slide the middle rod as far as it will go onto the lug wrench. The rods may otherwise bend and be distorted to such an extent that they can no longer be used as a pump lever for the jack.

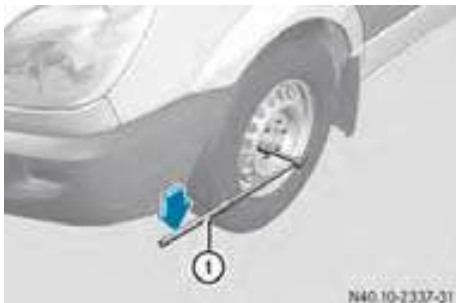

► Loosen the wheel nuts or wheel bolts on the wheel to be changed by about one turn using extended lug wrench (1). Do not unscrew the wheel bolts or wheel nuts completely.

### Hydraulic jack

► Insert the third rod of the jack pump lever into the lug wrench extension. The jack pump lever is assembled.

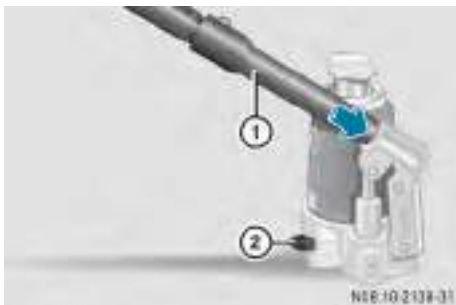

► Close pressure release screw (2).  
 ► To do this, use the flattened section on pump lever (1) to turn pressure release screw (2) clockwise to the stop.

**i** Never turn pressure release screw (2) more than 1 or 2 full turns. Hydraulic fluid could otherwise escape.

- Insert pump lever (1) into the recess on the jack and secure by turning it clockwise.
- Make sure that the jack is positioned directly under the jacking points described below.
- Raise the vehicle by pumping the lever until the wheel is raised clear of the ground. Make sure that the distance between the underside of the tires and the ground does not exceed 1.2 in (3 cm).

### Jacking point at the front axle

The vehicle jacking point is located under the longitudinal member in front of the front axle.

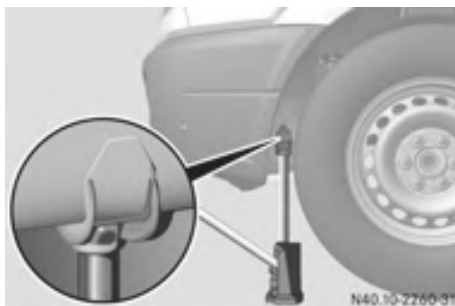

### Jacking point at the rear axle

The jacking point is located under the longitudinal member in front of the rear axle.

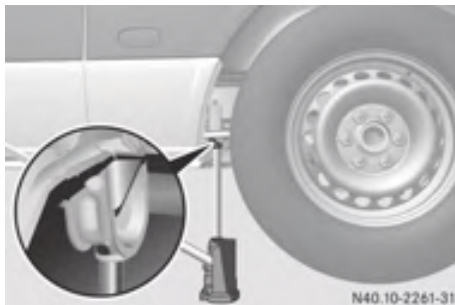

Jacking point (example: vehicle type 2500)



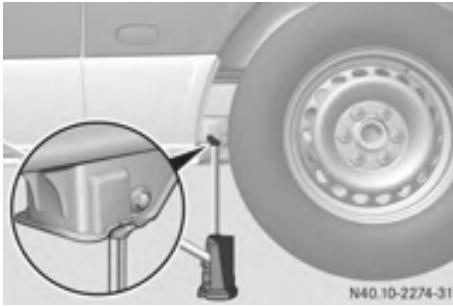

Jacking point (example: vehicle type 3500)

**!** Do not place the jack on the leaf spring or the differential case.

On cab chassis vehicles, the jacking point is located next to the front leaf spring support.

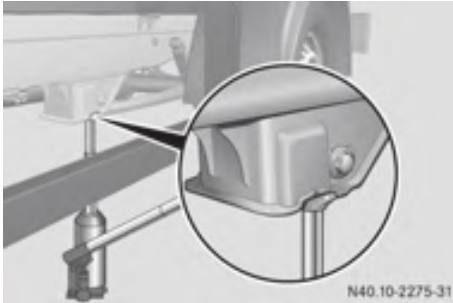

Jacking point (example: platform vehicle)

**!** Only position the jack on the jacking points intended for this purpose. You could otherwise damage the vehicle.

## Removing a wheel

► Unscrew the wheel bolts or nuts.

**!** Do not place the wheel bolts or the wheel nuts in sand or dirt. The threads of the wheel bolts and wheel nuts could otherwise be damaged when being installed.

- On front wheels with wheel nuts, remove the wheel nut cover.
- Remove the wheel.

## Mounting a new wheel

### **!** Warning

To avoid the risk of serious or even fatal injury and to avoid damage to the vehicle, observe the following:

- replace the wheel bolts and wheel nuts if they are damaged or have become rusty.
- never oil or grease wheel bolts or wheel nuts.
- if a wheel hub thread is damaged, you must not drive the vehicle.

Consult a qualified specialist workshop which has the necessary specialist knowledge and tools to carry out the work required.

For this reason, we recommend an authorized Sprinter Dealer. In particular, all work relevant to safety or on safety-related systems must be carried out at a qualified specialist workshop.

- For safety reasons, we recommend that you only use wheel bolts and wheel nuts which have been approved for Sprinter vehicles. Other wheel bolts or wheel nuts could work loose.

- Clean the wheel and wheel hub contact surfaces.
- Push the wheel onto the wheel hub or the adapter for the spare wheel and press it on.

**!** If your vehicle is equipped with the tire pressure monitor, each wheel has an electronic component.

Tire-mounting tools should not be applied in the area of the valve. Otherwise, the electronic components could be damaged.

Only have the tires changed at a qualified specialist workshop, e.g. an authorized Sprinter Dealer.

### **!** Warning

Do not tighten the wheel bolts and wheel nuts completely while the vehicle is still jacked up. The vehicle could otherwise tip.

Wheels with centering by wheel bolts:

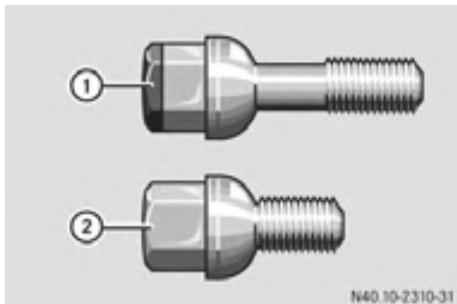

- ① Wheel bolt for alloy wheel
- ② Wheel bolt for steel wheel

**!** For a steel wheel, only use the short wheel bolts to install the steel spare wheel. Using other wheel bolts to install the steel spare wheel could damage the brake system.

▶ Screw in the wheel bolts and tighten them lightly.

**i** On vehicles with alloy wheels, you will find short wheel bolts suitable for the steel spare wheel in the vehicle tool kit.

For wheels with wheel nuts:

- ▶ On the front wheels, push the wheel nut cover onto the wheel bolts.
- ▶ Screw in three wheel nuts over the fixing discs of the wheel nut cover.
- ▶ Turn the wheel so that the wheel bolts are in the middle of the holes.
- ▶ Screw on the rest of the wheel nuts.
- ▶ Slightly tighten all the wheel nuts.

### Lowering the vehicle

- ▶ Open the pressure release screw on the jack with pump lever slowly by one turn (▶ page 230).
- ▶ Carefully lower the vehicle.
- ▶ Put the jack aside.

- ▶ Pull the rod with the smallest diameter off the pump lever.  
The shortened pump lever serves as a lug wrench extension.
- ▶ Starting with the middle rod, slide the lug wrench extension as far as it will go onto the lug wrench.

**!** Only use the jack pump lever middle rod and the rod with the largest diameter as a lug wrench extension. Only slide the middle rod as far as it will go onto the lug wrench. The rods may otherwise bend and be distorted to such an extent that they can no longer be used as a pump lever for the jack.



Tightening torque pattern

①—⑥ Wheel bolts or wheel nuts

▶ Tighten all the wheel bolts or wheel nuts evenly in the sequence indicated using the extended lug wrench.

**!** The tightening torque is:

- for wheel bolts: 177 lb-ft (240 Nm) (steel wheel)/ 133 lb-ft (180 Nm) (alloy wheel)
- for wheel nuts: 133 lb-ft (180 Nm)

You can now install the hub caps on steel wheels with wheel bolts. The installing procedure depends on whether the hub cap covers the whole wheel or just the center.

**!** With a hub cap that covers the whole wheel, make sure the opening for the tire valve is positioned over the valve.

- ▶ Push the edge of the hub cap with both hands against the wheel until it clicks into place.
- ❗ With a hub cap for the middle of the wheel, make sure that the clamping lugs of the cover are positioned over the wheel bolts.
- ▶ Hit the middle of the hub cap to engage it on the wheel.
- ▶ Push the piston on the hydraulic jack in again and close the pressure release screw.
- ▶ Secure the faulty wheel in the spare wheel bracket (▷ page 185).
- ▶ Stow the jack and the vehicle tool kit.
- ▶ Check the tire pressure and correct if necessary (▷ page 280).
- ▶ Retighten the wheel bolts or wheel nuts to the specified tightening torque after the vehicle has been driven for 30 miles (50 km).

### Retightening wheel nuts/wheel bolts

#### Warning

After changing a wheel, for safety reasons you must:

- have the tightening torque checked. For wheel bolts, the tightening torque is 177 lb-ft (240 Nm) (steel wheel)/ 133 lb-ft (180 Nm) (alloy wheel). For wheel nuts, the tightening torque is 133 lb-ft (180 Nm). The wheels could otherwise work loose.
- check the tire pressure and correct it if necessary.
- have the wheel bolts/wheel nuts retightened after driving a distance of 30 miles (50 km). The tightening torque for wheel bolts is 177 lb-ft (240 Nm)(steel wheel)/ 133 lb-ft (180 Nm) (alloy wheel). The tightening torque for wheel nuts is 133 lb-ft (180 Nm).
- if using new or painted rims, have the wheel bolts and wheel nuts retightened at the

specified tightening torque after the vehicle has been driven for approximately 600 to 3000 miles (1000 to 5000 km).

- have the direction of rotation corrected, if reversed, as soon as possible at a qualified specialist workshop, e.g. an authorized Sprinter Dealer. The vehicle handling characteristics could otherwise be affected.

Otherwise, the operating reliability and road safety of the vehicle could be jeopardized.

This could cause you to lose control of your vehicle, resulting in an accident and injuring yourself or others.

### Electrical system

#### Notes on changing bulbs

The bulbs and lamps are an essential component of vehicle safety. Therefore, make sure that each bulb is always working.

#### Warning

Bulbs and lamps can become very hot. For this reason, allow them to cool down before changing them. Otherwise, you could burn yourself when you touch them.

Keep bulbs out of the reach of children. Otherwise, they could, for example, damage the bulbs and injure themselves.

Never use a bulb which has been dropped. Such a bulb may explode and injure you.

Halogen bulbs are pressurized and could explode when you change them, especially if they are very hot. You should therefore wear eye protection and gloves when you are changing them.

#### Warning

Xenon bulbs are under high voltage. You could get an electric shock and be seriously or even fatally injured if you touch the electric contacts on Xenon bulbs. Therefore, do not remove the cover on Xenon bulbs.

Do not change Xenon bulbs yourself, but have them replaced at a qualified specialist workshop which has the necessary specialist knowledge and tools to carry out the work required.

We recommend an authorized Sprinter Dealer for this purpose. In particular, work relevant to safety or on safety-related systems must be carried out at a qualified specialist workshop.

- To prevent short circuits, switch off the lighting system before changing a bulb.
- Only touch new bulbs with a clean, lint-free cloth or similar. Do not work with wet or greasy fingers.
- Only install 12 V bulbs of the same type and of the correct wattage.
- Have the headlamp setting checked regularly.
- If the new bulb still does not light up consult a qualified specialist workshop, e.g. an authorized Sprinter Dealer.
- Have the following LEDs and bulbs replaced at a qualified specialist workshop, e.g. an authorized Sprinter Dealer:
  - the additional turn signals in the exterior mirrors
  - the high-mounted brake lamp
  - the Bi-Xenon bulbs
  - the fog lamps

**!** Make sure the bulbs are always securely installed.

## Changing bulbs

### Front bulbs



N82.10-2747-31

	Lights	Bulb type
①	Additional turn signal lamps in the exterior mirrors	PY 16 W
②	Turn signal lamps	PY 21 W
③	Halogen headlamps: low-beam headlamps	H7 55 W
	Bi-Xenon headlamps: low-beam/high-beam headlamps	D1S-35 W
④	Halogen headlamps: high-beam headlamps	H7 55 W
	Cornering lamps	H7 55 W
⑤	Fog lamps	H11 55 W
⑥	Parking lamps/standing lamps	WY 5 W

### High-beam headlamps/cornering lamps, low-beam headlamps, fog lamps



- ▶ Switch off the lights.
- ▶ Open the hood (▶ page 168).
- ▶ Press catches ① down.
- ▶ Lift housing cover ② in the direction of the arrow and remove it.

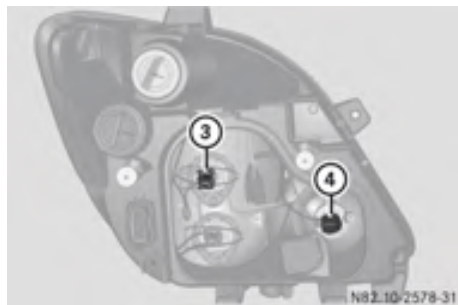

- ③ Low-beam headlamps
- ④ Halogen low-beam headlamp/Xenon cornering lamp headlamp
- ▶ Disconnect the connector from the bulb.
- ▶ Detach the retainer spring and remove the bulb.
- ▶ Insert the new bulb so the base fits into the recess of the socket.
- ▶ Attach the retainer spring and connect the plug to the bulb.
- ▶ Insert housing cover ② into the lower mounting points.

- ▶ Fold housing cover ② against the headlamp casing.
- ▶ Push catches ① up until you feel them engage.

### Turn signal lamps



- ▶ Switch off the lights.
- ▶ Open the hood (▶ page 168).
- ▶ Turn bulb holder ① counter-clockwise and remove it.
- ▶ Turn the bulb counter-clockwise by pressing lightly and pull it out of bulb holder ①.
- ▶ Press a new bulb into bulb holder ① and screw in clockwise.
- ▶ Insert bulb holder ① into the lamp and turn it clockwise.

### Parking lamps and standing lamps

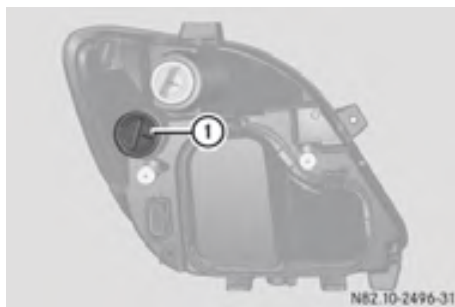

- ▶ Switch off the lights.
- ▶ Open the hood (▶ page 168).
- ▶ Turn cap ① counter-clockwise and remove it.

- ▶ Pull out the bulb holder with the bulb.
- ▶ Pull the bulb out of the bulb holder.
- ▶ Press a new bulb into the bulb holder.
- ▶ Insert the bulb holder into the reflector.
- ▶ Replace cap ① and turn it clockwise to the stop.

### Rear bulbs

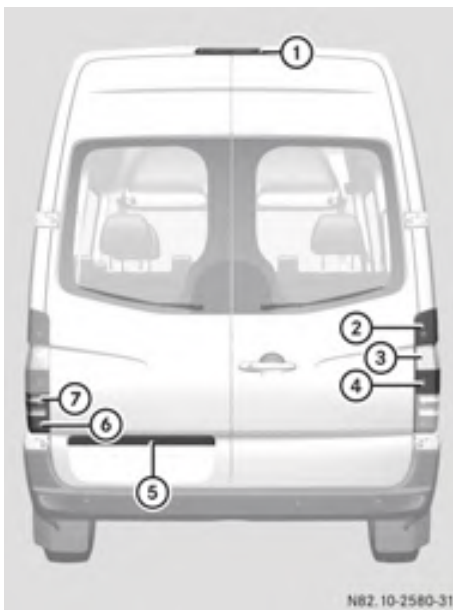

Cargo van/passenger van

	Lights	Bulb type
①	High-mounted brake lamp	LED
②	Brake lamps	P 21 W
③	Turn signal lamps	PY 21 W
④	Tail lamps/standing lamps	R 5 W
⑤	License plate lamp	W 5 W
⑥	Rear fog lamps (driver's side)	P 21 W
⑦	Backup lamps	P 21 W

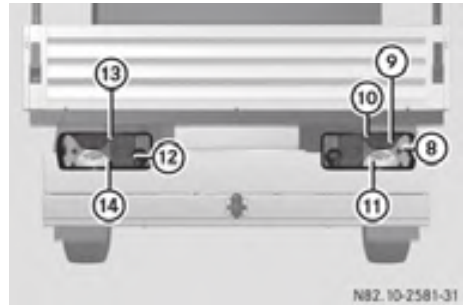

Example platform

	Lights	Bulb type
⑧	Perimeter lamp/standing lamp	R 5 W
⑨	Turn signal lamps	PY 21 W
⑩	Brake lamps	P 21 W
⑪	Backup lamps	P 21 W
⑫	Rear fog lamps (driver's side)	P 21 W
⑬	Tail lamps	R 5 W
⑭	License plate lamp	R 5 W

### Changing the rear bulbs (cargo van/passenger van)

#### Rear light cluster

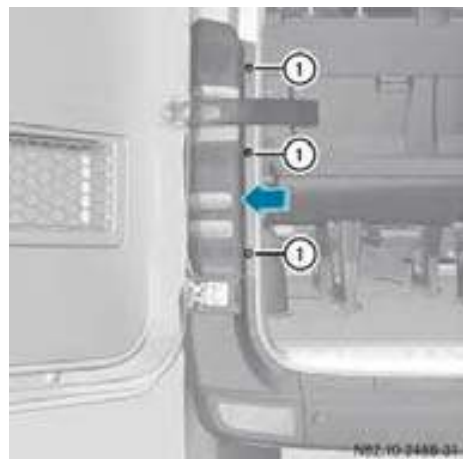

- ▶ Switch off the lights.
- ▶ Undo screws ① and remove the rear lamp lens in the direction of the arrow.
- ▶ Pull the connector off the bulb holder.

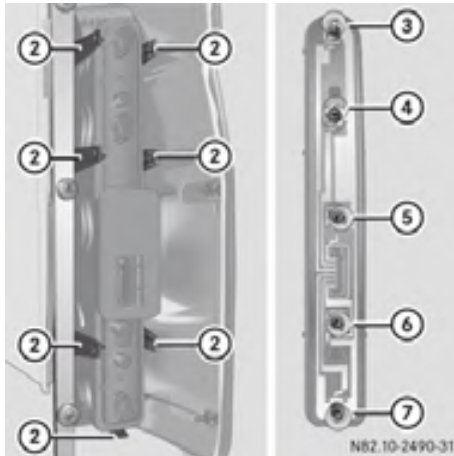

- ② Retaining lugs
- ③ Brake lamps
- ④ Standing lamp/tail lamp
- ⑤ Backup lamps
- ⑥ Turn signal lamps
- ⑦ Rear fog lamps

- ▶ Release retaining lugs ② and take the bulb holder out of the rear lamp cluster.
- ▶ Turn the bulb counter-clockwise by pressing lightly and pull it out of the bulb holder.
- ▶ Press a new bulb into the bulb holder and screw in clockwise.
- ▶ Press the connector into the bulb holder.
- ▶ Insert the lamp lens.

To do this, clip the bulb holder into the three holes provided at the side and tighten screws ①.

### License plate lamp

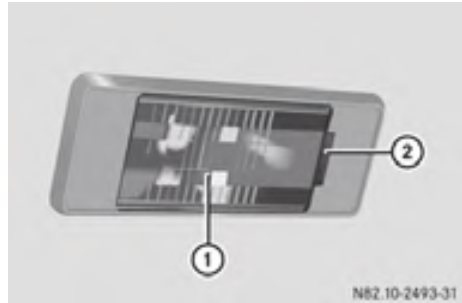

- ▶ Switch off the lights.
- ▶ Insert a screwdriver or similar implement into recess ② and carefully pry off lamp lens ①.
- ▶ Pull the bulb out of the bulb holder.
- ▶ Insert a new bulb.
- ▶ Align lamp lens ① and clip it in so that it engages.

### Changing the rear bulbs (platform)

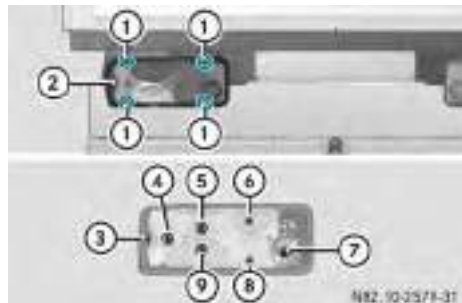

- ① Screws
- ② Lamp lens
- ③ Perimeter lamp/standing lamp
- ④ Turn signal lamps
- ⑤ Brake lamps
- ⑥ Tail lamp
- ⑦ Rear fog lamp
- ⑧ License plate lamp
- ⑨ Backup lamps

- ▶ Switch off the lights.
- ▶ Undo screws ① and remove lamp lens ②.

- ▶ Turn the bulb counter-clockwise by pressing lightly and pull it out of the bulb holder.
- ▶ Push a new bulb into the bulb holder and screw in clockwise.
- ▶ Position lamp lens ② and tighten screws ① again.

### Changing additional bulbs

#### Outline lamp W 5 W (cab platform only)

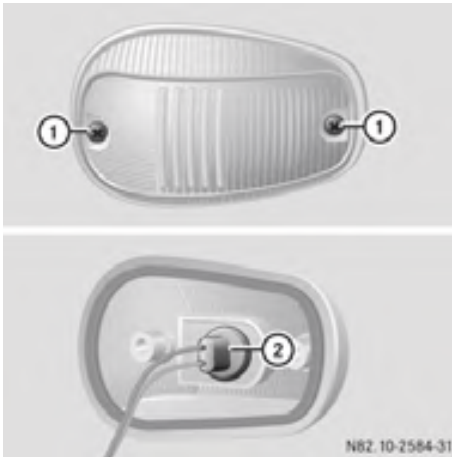

- ▶ Switch off the lights.
- ▶ Undo screws ① and remove the lamp unit.
- ▶ Turn bulb holder ② and remove it.
- ▶ Pull the bulb out of bulb holder ②.
- ▶ Press a new bulb into bulb holder ②.
- ▶ Screw bulb holder ② into the lamp unit.
- ▶ Carefully position the lamp housing and tighten screws ① again.

#### Entry lamp W 5 W

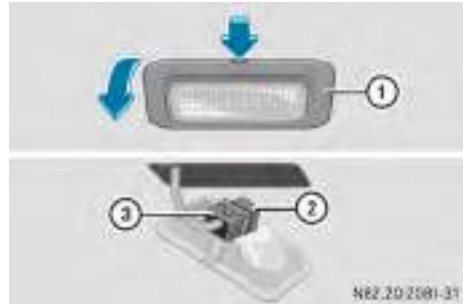

- ▶ Switch off the lights.
- ▶ Press in the latching spring of lamp housing ① with a suitable implement, e.g. a screwdriver.
- ▶ Pry off lamp housing ①.
- ▶ Disconnect cable connector ③.
- ▶ Pull out bulb holder ②.
- ▶ Pull the bulb out of bulb holder ②.
- ▶ Press a new bulb into bulb holder ②.
- ▶ Screw bulb holder ② into lamp unit ①.
- ▶ Connect cable connector ③.  
The connector locking spring must engage.
- ▶ Align and engage lamp housing ①.

#### Front interior light K 18 W

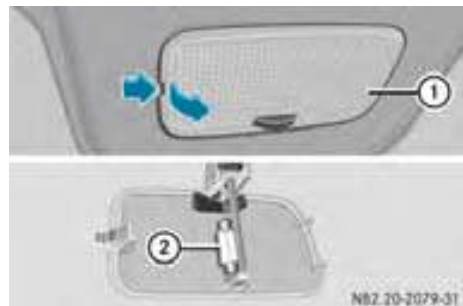

- ▶ Switch off the lights.
- ▶ Press in the latching spring of lamp housing ① with a suitable implement, e.g. a screwdriver.
- ▶ Pry off lamp housing ①.
- ▶ Pull bulb ② out of the bulb holder.



- ▶ Insert new bulb ②.
- ▶ Align and engage lamp housing ① on the right-hand side.

**!** Have the bulbs for the overhead control panel interior lights changed at a qualified specialist workshop which has the necessary specialist knowledge and tools to carry out the work required. We recommend an authorized Sprinter Dealer for this purpose.

You could otherwise damage the overhead control panel.

### Rear interior lights K 15 W



Interior light with switch

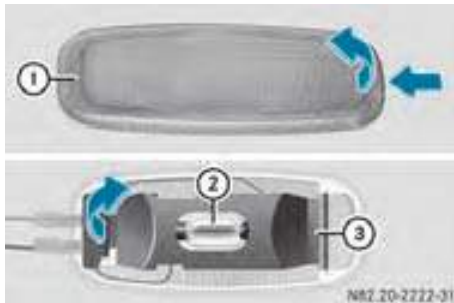

Interior light without switch

- ▶ Switch off the lights.
- ▶ Press in the latching spring of lamp housing ① with a suitable implement, e.g. a screwdriver.
- ▶ Pry off lamp housing ①.
- ▶ For interior lights without a switch, fold back protective cover ③.

- ▶ Pull bulb ② out of the bulb holder.
- ▶ Insert new bulb ②.
- ▶ For interior lights without a switch, fold back protective cover ③.
- ▶ Align lamp housing ① on the left-hand side and engage.

### Rear interior lights W 5 W



- ▶ Switch off the lights.
- ▶ Undo screws ① and remove the lamp lens.
- ▶ Push bulb ② into the bulb holder and remove by turning counter-clockwise.
- ▶ Push new bulb ② into the bulb holder and screw in by turning clockwise.
- ▶ Position the lamp lens and tighten screws ① again.

### Fuses

- i** Blown fuses must be replaced with fuses of the same rating (which can be recognized by the color and amperage) and which have the amperage specified in the fuse allocation chart. An authorized Sprinter Dealer will be happy to advise you.

### **⚠ Warning!**

Only use fuses approved for Sprinter with the fuse rating specified for the respective

systems. Do not repair or bypass defective fuses. A fire may otherwise result through overload. Have the problem assessed and resolved only at a qualified specialist workshop, e.g. an authorized Sprinter Dealer.

The fuses and relays for the standard equipment are located in the main fuse box in the footwell on the left-hand side of the vehicle.

Additional fuses and relays for the items of optional equipment are located in the fuse box under the driver's seat.

### Practical advice

- ❶ The fuse allocation chart for the fuse boxes is in the vehicle document wallet in the glove box and shows all numbered fuses.
- ▶ Switch off the ignition and the electrical consumers before changing a fuse.

### Main fuse box



The fuse box is located in the footwell on the left-hand side of the vehicle.

❶ Unlocked

❷ Locked

- ▶ **To open:** unlock ❶ the quick-release fastener and remove the cover.
- ▶ **To close:** install the bottom edge of the cover and fold upwards.  
The cover must engage.
- ▶ Lock ❷ the quick-release fastener.

## Arrangement

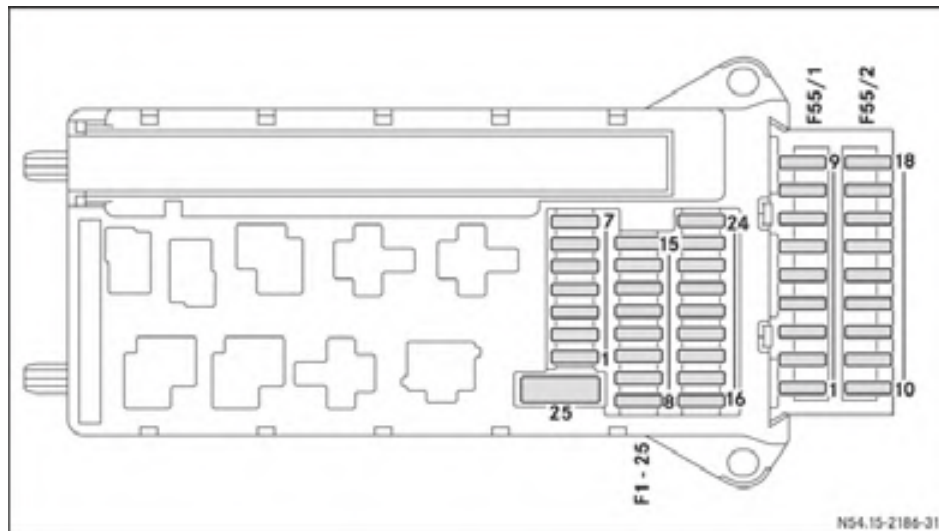

## Fuses

Fuse-relay box (SRB)

No.	Consumer	Fuse rating
1	Horn	15 A
2	Electronic steering lock (electronic ignition/start switch)	25 A
3	Electronic ignition/start switch	10 A
4	Light switch/switch unit on center console	5 A
5	Windshield wipers	30 A
6	Fuel pump	15 A
7	MRM (jacket tube module)	5 A
8	Terminal 87 (2)	20 A
9	Terminal 87 (3)	25 A
10	Terminal 87 (4)	10 A
11	Terminal 15 R vehicle	15 A

No.	Consumer	Fuse rating
12	Air bag control unit	10 A
13	Cigarette lighter/glove box lamp/radio	15 A
14	Diagnostics socket/light switch/instrument cluster	5 A
15	Front-compartment heating	5 A
16	Terminal 87 (1)	10 A
17	Air bag control unit	10 A
18	Terminal 15 vehicle, brake light switch	7.5 A
19	Interior lighting	7.5 A
20	Front-passenger power window switch/terminal 30/2 signal acquisition and actuation module	25 A
21	Engine control unit	5 A

No.	Consumer	Fuse rating
22	Brake system (ABS)	5 A
23	Starter motor	20 A
24	Engine components	10 A
25	12 V socket in the center console	25 A

## Fuse block F55/1

No.	Consumer	Fuse rating
1	Left door control unit	25 A
2	Diagnostics socket	10 A
3	Brake system (valves)	25 A
4	Brake system (delivery pump)	40 A
5	Terminal 87 (5) engine	7.5/10 A
6	Terminal 87 (6) engine	7.5/10 A
7	Headlamp cleaning system	30 A
8	Anti-theft alarm system (ATA)	15 A
9	Additional turn signal module	10 A

## Fuse block F55/2

No.	Consumer	Fuse rating
10	Radio	15 A
11	Mobile phone	7.5 A
12	Blower, front/auxiliary heating blower setting 1	30 A
13	Auxiliary heating digital timer, radio receiver/basic wiring DIN-slot	7.5 A

No.	Consumer	Fuse rating
14	Seat heating	30 A
15	Unassigned	—
16	Heating, rear-compartment heating/front-compartment air conditioning/CD player	10 A
17	Motion detector/convenience lighting	10 A
18	Rear-compartment air-conditioning system	7.5 A

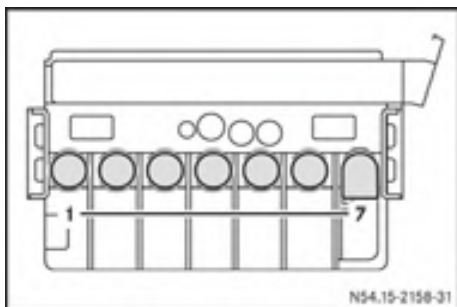

Prefuse box in the battery compartment in the driver's footwell F59

No.	Consumer	Fuse rating
1	Preglow relay/secondary air pump	80/40 A
2	Air-conditioning system cooling fan, cab	60/40 A
3	Signal acquisition and actuation module (SAM)/fuse-relay box (SRB)	80 A
4	Auxiliary battery/retarder	150 A

No.	Consumer	Fuse rating
5	Terminal 30 fuse box, signal acquisition and actuation module (SAM)/fuse-relay box (SRB)	150 A
6	Connection point on the base of the seat	Bridge
7	PTC heater booster	150 A

### Fuse box under the driver's seat

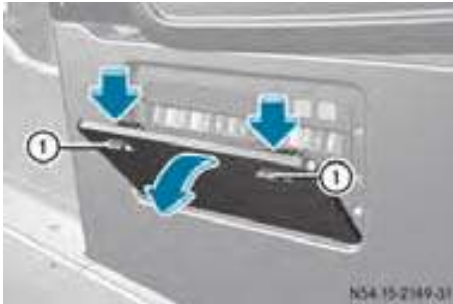

The fuse box is located on the outside of the base of the driver's seat.

① Catch spring

- ▶ **To open:** move the seat to the highest position (> page 63).
- ▶ Press both latching springs ① down and remove the cover.
- ▶ **To close:** install the bottom edge of the cover and fold upwards.

The cover must engage.

## Arrangement

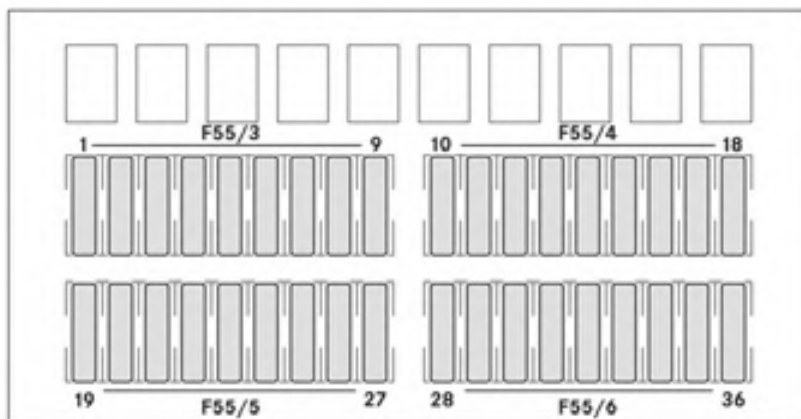

NS4.15-2187-31

## Fuses

Fuse block F55/3

No.	Consumer	Fuse rating
1	Mirror setting/rear window defroster	5 A
2	Rear window wiper	30 A
3	Rear view camera/ mobile phone/DIN-slot basic wiring (roof)	5 A
4	Working speed governor (ADR)/power take-off/ trailer control unit AAG	7.5 A
5	Electronic transmission control, ETC control unit	10 A
6	Unassigned	—
7	Electronic selector lever module	10 A

No.	Consumer	Fuse rating
8	Terminal 15 body manufacturer/loading tailgate/tipper	10 A
9	Roof ventilator/siren	15 A

Fuse block F55/4

No.	Consumer	Fuse rating
10	Terminal 30, body/ equipment manufacturer	25 A
11	Terminal 15, body/ equipment manufacturer	15 A
12	D+, body/equipment manufacturer	10 A
13	Rear-compartment air conditioning	30 A
14	Trailer power socket	20 A

No.	Consumer	Fuse rating
15	Trailer recognition unit	25 A
16	Tire pressure monitor/ PARKTRONIC	7.5 A
17	PSM control unit	25 A
18	PSM control unit	25 A

## Fuse block F55/5

No.	Consumer	Fuse rating
19	Overhead control panel	5 A
20	Perimeter lamp	7.5 A
21	Rear window defroster 1	30 A
22	Rear window defroster 2	15 A
23	12 V socket rear left, cargo compartment/ passenger compartment/non-MB body electrics	15 A
24	12 V socket under the base of driver's seat	15 A
25	12 V socket rear right, cargo compartment/ passenger compartment	15 A
26	Auxiliary heating	25 A
27	Heater booster system	25 A

## Fuse block F55/6

No.	Consumer	Fuse rating
28	Exhaust gas aftertreatment – SCR <sup>10</sup> control unit	10 A
29	Unassigned	–

<sup>10</sup> Selective Catalytic Reduction.

No.	Consumer	Fuse rating
30	Brake booster	30 A
31	Rear-compartment heating blower/sliding door closing assistance, left	30/15 A
32	Exhaust gas aftertreatment – SCR <sup>10</sup> relay power supply	10 A
33	Sliding door closing assistance, right	15 A
34	Exhaust gas aftertreatment – SCR <sup>10</sup> heater 1 tank	15 A
35	Exhaust gas aftertreatment – SCR <sup>10</sup> heater 2 hose	15 A
36	Exhaust gas aftertreatment – SCR <sup>10</sup> heater 3 delivery pump	10 A

## Batteries for the remote control

## Notes on changing the batteries

 **Warning!**

Batteries are toxic and contain caustic substances. For this reason, keep batteries out of the reach of children.

If a battery has been swallowed, visit a doctor immediately.

 **Environmental note**

Batteries contain toxic substances. It is illegal to dispose of them with household waste. Batteries must be collected separately and be

recycled in an environmentally responsible manner.



Dispose of old batteries in an environmentally responsible manner. Take discharged batteries to a qualified specialist workshop, e.g. an authorized Sprinter Dealer, or to a special collection point for old batteries.

### Key with remote control

You need two CR 2025 3 V cell batteries. When changing the batteries, do not press any of the buttons on the remote control.



① Battery cover

② Key release button

- ▶ Press key release button ②. The key folds out.
- ▶ Remove battery cover ① in the direction of the arrow.

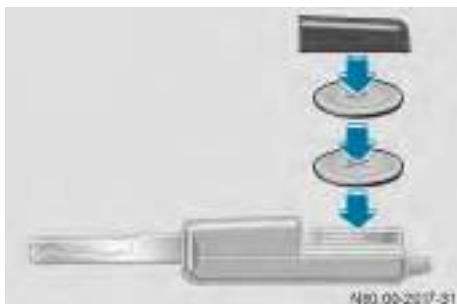

- ▶ Remove old batteries from the battery tray.

**i** When inserting the batteries, make sure that they are clean and lint-free.

- ▶ Insert the new batteries with the positive terminal facing upwards. Use a lint-free cloth to do so.
- ▶ Position battery cover ① and press down until it engages noticeably.
- ▶ Check the function of all the remote control buttons on the vehicle.

### Automatic transmission

In the event of a malfunction, it is possible to manually release the selector lever from the lock in parking position **P**, e.g. to have the vehicle towed away.



- ▶ Remove cover ①.



- ▶ Slide implement ② as far as it will go into the opening.
- ▶ Push the implement in and simultaneously move the selector lever out of position **P**.



- ▶ Remove implement (2).
- ▶ Refit cover (1).

## Jump starting, tow-starting and towing away

### Jump-starting

#### General notes

If the vehicle battery is flat, the engine can be started from another vehicle using jumper cables. For this purpose, the vehicle has a jump-starting connection point in the engine compartment.

The additional battery in the engine compartment is not suitable for jump-starting operations. If your vehicle requires jump-starting, or if you use it to jump-start another vehicle, use the jump-starting connection point in the engine compartment.

#### Warning

Explosive oxyhydrogen is produced when batteries are being charged. When working on batteries, always make sure that the work area is well ventilated.

Keep flames and naked lights away from the battery, and do not smoke.

Prevent the creation of sparks (e.g. when disconnecting the batteries). Sparks can ignite the oxyhydrogen gas and cause the batteries to explode. You and others could be seriously injured.

#### Warning

Due to the gases which escape from batteries, there is a risk of acid burns when jump-starting a vehicle. Do not lean over the battery while the engine is being jump-started.

- !** Avoid repeated and lengthy starting attempts.

Do not use a rapid-charging device to start the engine.

When jump-starting, observe the following points:

- jump-starting must only be performed when the engine and catalytic converter are cold.
  - do not start the engine if the battery is frozen. Let the battery thaw first.
  - when jump-starting, use only batteries with the same nominal voltage and a similar capacity.
  - only use jump leads protected against polarity reversal, with adequate cross-section and with insulated battery terminal clamps.
- ▶ Make sure that the two vehicles do not touch.
  - ▶ Apply the parking brake.
  - ▶ Move the selector lever of the automatic transmission to position **P**.
  - ▶ Switch off all electrical consumers.
  - ▶ Switch on the battery isolating switch (▷ page 87).
  - ▶ Remove the key from the ignition lock.
  - ▶ Open the hood (▷ page 168).

#### Connecting the jumper cable

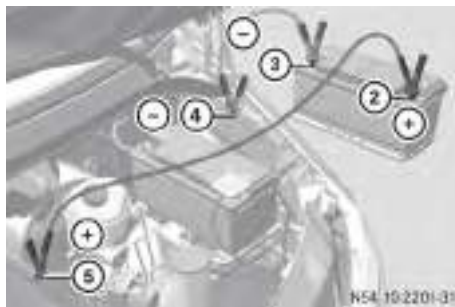

Connection plan

- ▶ Remove the cover from positive terminal (2) of the donor battery.
- ▶ First connect one of the positive terminal clamps of the jumper cable to positive terminal (2) of the donor battery.

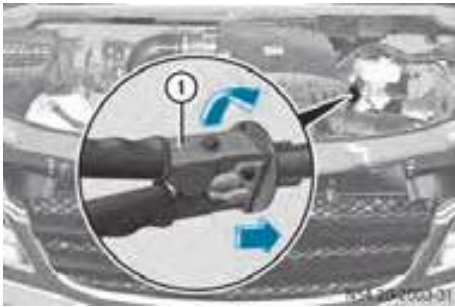

Jump-starting connection point left of the air filter

- ▶ Then, use other positive terminal clamp ① of the jumper cable to turn the red protective cap of the jump-starting connection point clockwise and slide it back and connect positive terminal clamp ① to positive terminal ⑤ of the jump-starting connection point.

**i** Do not connect the jumper cable to the additional battery in the engine compartment. The additional battery is not suitable for jump-starting operations.

- ▶ Run the donor vehicle's engine at idling speed.
- ▶ First, connect the negative terminal clamps of the jumper cable to negative terminal ③ of the donor battery and then to earth contact ④ of your own vehicle.
- ▶ Start the engine.
- i** You can now switch electrical consumers back on but do not switch on the lights.
- ▶ First, disconnect the negative terminal clamps of the jumper cable from earth contact ④ and then from negative terminal ③ of the donor battery.
- ▶ First disconnect the positive terminal clamps of the jumper cable from positive terminal ⑤ of the jump-starting connection point and then from positive terminal ② of the donor battery.

The red protective cap springs back to its initial position when positive terminal clamp ① is removed from the jump-starting connection point.

- ▶ Place the cover on positive terminal ② of the donor battery.
- i** You can now switch the lights on.
- ▶ Have the battery checked at a qualified specialist workshop, e.g. an authorized Sprinter Dealer.

### Tow-starting

You cannot tow-start your vehicle as it has an automatic transmission.

### Towing

#### General notes

#### **⚠ Warning**

Tow the vehicle using a rigid towing bar if:

- the engine is not running.
- the voltage supply or the vehicle's electrical system is malfunctioning.

There is no power assistance for the steering and braking when the engine is not running. You must then use significantly greater force to steer the vehicle and brake.

Do not tow the vehicle if the key cannot be turned in the ignition lock. The steering is then locked and it will not be possible to steer the vehicle.

When towing another vehicle, its weight should not be greater than the permissible gross weight of your vehicle.

Comply with national regulations when towing.

It is preferable to have the vehicle transported on a transporter or trailer instead of towing it. When towing the vehicle, use a rigid towing bar.

**!** Only secure the tow cable or tow bar to the towing eyes. You could otherwise damage the vehicle.

**i** Before towing, deactivate the automatic locking while driving function (▶ page 55).

You could otherwise become locked out when pushing or towing the vehicle.

- ❗ Do not exceed the towing speed of 31 mph (50 km/h). You could otherwise damage the transmission.
- ▶ Turn the key to position **2** in the ignition lock.
- ▶ For a towing distance of up to 30 miles (50 km), move the selector lever to position **N**.

### Warning

A propeller shaft could fall off as it is being removed and injure you. Secure the propeller shaft before removal to prevent it from falling down, e.g. with the aid of another person or by tying the propeller shaft up.

- ▶ For a towing distance greater than 30 miles (50 km), remove the propeller shafts to the driven axles.
- ❗ Always use new bolts when installing the propeller shafts.

### Front towing eye



The fixture for the front towing eye is located in the bumper.

- ▶ **To install the towing eye:** press on cover ① in the direction of the arrow and remove cover ①.  
You will see the fixture for the towing eye.
- ▶ Take the towing eye and lug wrench from the vehicle tool kit (▶ page 182).

- ▶ Screw in the towing eye clockwise to the stop.
- ▶ Insert the lug wrench handle into the towing eye and tighten.
- ▶ **To remove the towing eye:** take the lug wrench from the vehicle tool kit.
- ▶ Insert the lug wrench handle into the towing eye and turn the wrench counter-clockwise.
- ▶ Unscrew the towing eye.
- ▶ Insert cover ① with the lug at the bottom and press it in at the top until it engages.
- ▶ Place the towing eye and lug wrench back in the vehicle tool kit.

### Rear towing eye

If your vehicle is equipped with a rear towing eye, this is installed to the rear of the chassis on the right-hand side when viewed in the direction of travel.

- ❗ If your vehicle has a trailer coupling, use this for towing.

### Recovering a vehicle that is stuck

If the drive wheels are dug in to loose or muddy ground, tow the vehicle with extreme care, particularly if it is laden.

Pull the vehicle smoothly and straight ahead. There is otherwise a risk of damage to the chassis.

Do not tow the vehicle out with a trailer attached.

Tow the vehicle out backwards in the tracks already made, if possible.

### Towing the vehicle in the event of particular malfunctions

#### With transmission damage

### Warning

A propeller shaft could fall off as it is being removed and injure you. Secure the propeller shaft before removal to prevent it from falling

down, e.g. with the aid of another person or by tying the propeller shaft up.

- ▶ Always remove the propeller shafts leading to the driven axles.

**!** Always use new bolts when installing the propeller shafts.

### With front axle damage

- ▶ Turn the key to position **1** in the ignition lock.
- ▶ Raise the front axle.

#### Warning

A propeller shaft could fall off as it is being removed and injure you. Secure the propeller shaft before removal to prevent it from falling down, e.g. with the aid of another person or by tying the propeller shaft up.

**!** The ignition must be switched off if the vehicle is being towed with the front or rear axle raised. Otherwise, ESP<sup>®</sup> may intervene and damage the brake system.

### With rear axle damage

- ▶ Turn the key to position **1** in the ignition lock.
- ▶ Raise the rear axle.

### Malfunction in the electrical system

If the battery is defective, the automatic transmission will be locked in position **P**. To shift the automatic transmission to position **N**, you must provide power to the vehicle's electrical system in the same way as jump-starting (> page 247).

Have the vehicle transported on a transporter or trailer.

### Transporting the vehicle

The towing eye can be used to pull the vehicle onto a special transporter or trailer for transportation.

**!** Only lash the vehicle down by the wheels or rims, not by vehicle parts such as axle or

steering components. There is otherwise a risk of damage to the vehicle.

- ▶ Move the selector lever of the automatic transmission to position **N**.

Vehicle equipment .....	252
Important safety notes .....	252
Operation .....	253
Operation in winter .....	254
Tire pressure .....	255
Loading the vehicle .....	261
Maximum tire load .....	265
Tire labeling .....	266
Definition for tires and loading .....	268
Changing wheels .....	271

## Vehicle equipment

- i** Diese Betriebsanleitung beschreibt alle Modelle, Serien- und Sonderausstattungen Ihres Fahrzeugs, die zum Zeitpunkt des Redaktionsschlusses dieser Betriebsanleitung erhältlich waren. Länderspezifische Abweichungen sind möglich. Beachten Sie, dass Ihr Fahrzeug nicht mit allen beschriebenen Funktionen ausgestattet sein könnte. Dies betrifft auch sicherheitsrelevante Systeme und Funktionen.

## Important safety notes

Contact an authorized Sprinter Dealer if you require information on tested and recommended tires and wheels for summer and winter driving. Advice on purchasing and caring for tires is also available there.

### Warning

Replace rims or tires with the same designation, manufacturer and type as shown on the original part. For further information, contact an authorized Sprinter Dealer. If incorrectly sized rims and tires are mounted, the wheel brakes or suspension components can be damaged. Also, the operating clearance of the wheels and the tires may no longer be correct.

### Warning!

Worn, old tires can cause accidents. If the tire tread is worn to minimum tread depth, or if the tires have sustained damage, replace them.

When replacing rims, only use genuine Sprinter wheel bolts specified for the particular rim type. Failure to do so can result in the bolts loosening and possibly an accident.

Retreaded tires are not tested or recommended by the dealer named on the inside cover page, since previous damage

cannot always be recognized on retreads. The operating safety of the vehicle cannot be assured when such tires are used.

### Warning!

Only for vehicles without a tire pressure monitor:

For safety reasons, we recommend that you only use tire valves manufactured by Schrader. These have been tested for use on your vehicle.

Use only tire valves of type:

- TR 600 for the vehicle types 2500
- TR 418 for the vehicle types 3500

Using other tire inflation valves or valves made by other manufacturers can result in tire pressure loss and thereby impair the operating safety of the vehicle.

- !** Do not screw additional weights (check valves, etc.) onto the tire valves. The electronic components could thus be damaged.

### Warning

If you feel a sudden significant vibration or ride disturbance, or you suspect that possible damage to your vehicle has occurred, you should turn on the hazard warning lamps, carefully slow down, and drive with caution to an area which is a safe distance from the road. Inspect the tires and the vehicle underbody for possible damage. If the vehicle appears unsafe, have the vehicle towed to the nearest authorized Sprinter Dealer for repairs.

### Warning

Do not drive with a flat tire. A flat tire affects the ability to steer or brake the vehicle. You might lose control of the vehicle. Continued driving with a flat tire or driving at high speed with a flat tire will cause excessive heat build-up and possibly a fire.

## Operation

### Notes on driving

- If the vehicle is heavily laden, check the tire pressures, and correct them, if necessary.
- When parking your vehicle, make sure that the tires do not get deformed by the curb or other obstacles. If it is necessary to drive over curbs, speed humps or similar elevations, try to do so slowly and at an obtuse angle. Otherwise, the tires, particularly the sidewalls, can get damaged.

### Notes on regularly inspecting wheels and tires

#### Warning

Regularly check the tires for damage. Damaged tires can cause tire inflation pressure loss. As a result, you could lose control of your vehicle.

Worn, old tires can cause accidents. If the tire tread is worn to minimum tread depth, or if the tires have sustained damage, replace them.

- Regularly check the wheels and tires of your vehicle for damage (e.g. cuts, punctures, tears, bulges on tires and deformation or severe corrosion on wheels), at least once a month, as well as after driving off-road or on rough roads. Damaged wheels can cause a loss of tire pressure.
- Regularly check the tire tread depth and the condition of the tread across the whole width of the tire (▷ page 253). If necessary, turn the front wheels to full lock in order to inspect the inner side of the tire surface.
- All wheels must have a valve cap to protect the valve against dirt and moisture. Do not install anything onto the valve (such as tire pressure monitoring systems) other than

the standard valve cap or other valve caps approved for your vehicle.

- Regularly check the pressure of all the tires including the spare wheel, particularly prior to long trips, and correct the pressure (▷ page 255).

### Tire tread

#### Warning

Although the applicable federal motor vehicle safety laws consider a tire to be worn when the tread wear indicators (TWI) become visible at approximately  $\frac{1}{16}$  in (1.6 mm), we recommend that you do not allow your tires to wear down to that level. As tread depth approaches  $\frac{1}{8}$  in (3 mm), the adhesion properties on a wet road are sharply reduced. Depending upon the weather and/or road surface (conditions), the tire traction varies widely.

Replace tires before they become excessively worn, as the tire traction on wet road surfaces decreases significantly when the tread depth is less than  $\frac{1}{8}$  in (3 mm).

Tread wear indicators (TWIs) are required by law. Six indicators are positioned over the tire tread. They are visible once the tread depth is approximately  $\frac{1}{16}$  in (1.6 mm). If this is the case, the tire is so worn that it must be replaced.

The recommended tread depth for summer tires is at least  $\frac{1}{8}$  in (3 mm). The recommended tread depth for winter tires is at least  $\frac{1}{6}$  in (4 mm).



Bar marking ① for tread wear is integrated into the tire tread.

### Notes on selecting, mounting and replacing tires

- Only mount tires and wheels of the same type and make.
- Only mount tires of the correct size onto the wheels.
- After mounting new tires, run them in at moderate speeds for the first 60 miles (100 km) as they only reach their full performance after this distance.
- Do not use tires that are excessively worn as the tire traction on wet road surfaces decreases significantly when the tread depth is less than  $\frac{1}{8}$  in (3 mm).
- Replace the tires after six years at the latest, regardless of wear. This also applies to the spare wheel.

The service life of tires depends, among other things, on the following factors:

- driving style
- tire pressure
- mileage

Permissible wheel/tire combinations and instructions for tires can be found under "Tires and wheels" in the "Technical data" section (▷ page 280).

## Operation in winter

### Please bear the following in mind

Have your vehicle winterproofed at a qualified specialist workshop, e.g. at an authorized Sprinter Dealer, at the onset of winter.

Observe the notes under "Winter driving" in the "Operation" section (▷ page 271).

### Driving with summer tires

At temperatures below 45 °F(+7 °C), summer tires lose a lot of their elasticity, and thus also lose grip and braking effect – equip your vehicle with M+S tires. Summer tires may develop cracks leading to permanent damage if they are used at very low temperatures. We cannot accept responsibility for this type of damage.

### M+S tires

At temperatures below 45 °F(+7 °C), use winter tires or all-season tires – both are marked M+S.

In wintry road conditions, only winter tires with the snowflake symbol  in addition to the M+S marking offer the best possible grip. Only these tires allow driving safety systems such as ABS and ESP® to continue to work optimally in winter, as these tires have been designed specifically for driving on snow.

For safe driving, use M+S tires of the same make and tread pattern on all wheels.

### Warning

M+S tires with a tread depth of less than  $\frac{1}{16}$  inch (4 mm) must be replaced. They are no longer suitable for winter operation.

Always observe the maximum permissible speed specified for the M+S tires you have mounted.



When you have mounted M+S tires:

- ▶ Check the tire pressure (> page 255).
- ▶ Restart the tire pressure monitor (> page 258).

### Warning

If you use your spare wheel when M+S tires are fitted on the other wheels, be aware that the difference in tire characteristics may very well impair turning stability and that overall driving stability may be reduced. Adapt your driving style accordingly.

Have the spare wheel replaced by a regular road wheel with an M+S tire at the nearest authorized Sprinter Dealer.

## Snow chains

Snow chains increase traction on roads in wintry conditions.

We recommend, for safety reasons, that you only use class U snow chains or traction aids that conform to the SAE type U specification and are approved for Sprinters. You can obtain information about snow chains from any authorized Sprinter Dealer.

- Only use snow chains when the road is covered by a layer of snow. Do not exceed the maximum permissible speed of 30 mph (50 km/h). Remove the snow chains as soon as possible once the road is no longer covered with snow.
  - The use of snow chains may be restricted by local regulations. Observe the relevant regulations when mounting snow chains.
- !** Check the snow chains for damage before mounting them. Damaged or worn snow chains may break, causing damage to wheels, wheel arches or wheel suspension. For this reason, you must use only snow chains that are free of defects. Observe the manufacturer's mounting instructions.

If you intend to mount snow chains, please bear the following points in mind:

- You may not mount snow chains on all wheel/tire combinations. When mounting the snow chains, note the permissible tire and snow chain dimensions.
  - Mount snow chains only in pairs and only to the rear wheels. Observe the manufacturer's mounting instructions.
  - Check the chain tension after driving approximately 0.5 miles (1.0 km).
- i** You can deactivate ASR when pulling away with snow chains mounted. (> page 49). This allows the wheels to spin in a controlled manner, generating more tractive force (friction effect).

## Tire pressure

### Notes about tire pressure

### Warning

Follow recommended tire inflation pressures. Do not underinflate tires. Underinflated tires wear excessively and/or unevenly, adversely affect handling and fuel economy, and are more likely to fail from being overheated.

Do not overinflate tires. Overinflated tires can adversely affect handling and ride comfort, wear unevenly, increase stopping distance, and result in sudden deflation (blowout) because they are more likely to become punctured or damaged by road debris, potholes etc.

Do not overload the tires by exceeding the specified load limit as indicated on the Tire and Loading Information placard on the driver's door B-pillar. Overloading the tires can overheat them, possibly causing a blowout. Overloading the tires can also result in handling or steering problems, or brake failure.

A table of recommended tire pressures can be found on the Tire & Loading Information placard<sup>11</sup> or the tire pressure plate on the B-pillar on the driver's side of the vehicle (> page 256).

Use a tire pressure gauge intended for this purpose. The outer appearance of a tire does not permit any reliable conclusion about the tire pressure. On vehicles equipped with the electronic tire pressure monitor, the tire pressure can be checked using the on-board computer.

### Warning!

If the tire pressure drops repeatedly:

- check the tires for foreign objects
- check whether the wheel is losing air or the valve is leaking
- make sure that only a valve cap approved by the dealer listed on the inside of the cover page is on the tire valve

Underinflated tires have a negative effect on vehicle safety, which could lead you to cause an accident.

Correct the tire pressure only when the tires are cold. Tires are cold when the vehicle has been parked for at least three hours or has been driven less than 1 mile (1.6 km). Tire temperature changes depending on the ambient temperature, driving speed and tire load. If the tire temperature changes by 18 °F (10 °C), the tire pressure changes by approximately 10 kPa (0.1 bar/ 1.5 psi). Take this into consideration if you are checking tire pressure when the tires are warm, and correct the tire pressure only if it is too low for current operating conditions. If you check the tire pressure when the tires are warm, it results in a higher value than when the tires are cold. This is normal. Do not under any circumstances release the air in order to adjust the pressure to the prescribed value for cold tires. Tire pressure would then be too low.

Take note of the recommended tire pressure data for cold tires on the Tire & Loading Information placard<sup>11</sup> or the tire pressure plate on the B-pillar on the driver's side of the vehicle.

 The data shown on the following tire data labels are examples. Tire pressure data are vehicle-specific and may deviate from the data illustrated here. The tire pressure data applicable to your vehicle can be found on the Tire & Loading Information placard or tire pressure plate of your vehicle.

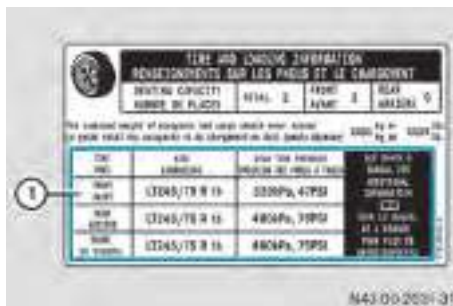

Tire & Loading Information placard<sup>11</sup>

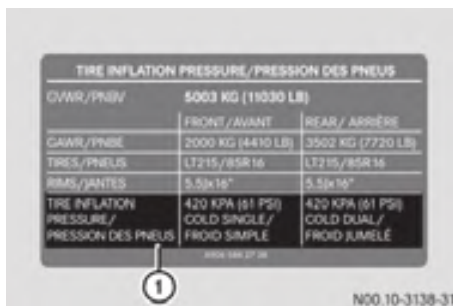

Tire pressure plate

You will find recommended tire pressure specifications  for cold tires and for a fully loaded vehicle on the Tire & Loading Information placard or on the tire pressure plate. The tire pressure specifications apply to the factory-mounted tires.

<sup>11</sup> Only for vehicles with a gross weight of less than 10,000 lbs (4536 kg).

## Tire pressure too low or too high

### Underinflated tires

#### Warning

Follow recommended tire inflation pressures. Do not underinflate tires. Underinflated tires wear excessively and/or unevenly, adversely affect handling and fuel economy, and are more likely to fail from being overheated.

Underinflated tires can:

- wear excessively and/or unevenly
- adversely affect fuel economy
- fail from being overheated
- adversely affect handling

### Overinflated tires

#### Warning

Follow recommended tire inflation pressures. Do not overinflate tires. Overinflated tires can adversely affect handling and ride comfort, wear unevenly, increase stopping distance, and result in sudden deflation (blowout) because they are more likely to become punctured or damaged by road debris, potholes etc.

Overinflated tires can:

- adversely affect handling
- wear excessively and/or unevenly
- be more likely to become damaged
- adversely affect ride comfort
- increase stopping distance

### Maximum tire pressures

#### Warning

Never exceed the maximum tire inflation pressure. Follow recommended tire inflation pressures.

Do not underinflate tires. Underinflated tires wear excessively and/or unevenly, adversely

affect handling and fuel economy, and are more likely to fail from being overheated.

Do not overinflate tires. Overinflated tires can adversely affect handling and ride comfort, wear unevenly, increase stopping distance, and result in sudden deflation (blowout) because they are more likely to become punctured or damaged by road debris, potholes etc.

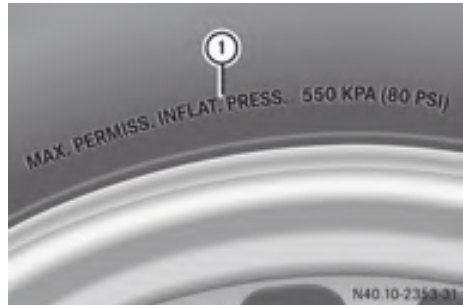

① Maximum permitted tire pressure (example)

**i** The actual values for tires are specific to each vehicle and may deviate from the values in the illustration.

When adjusting the tire pressures always observe the recommended tire pressure for your vehicle (▷ page 255).

### Checking the tire pressure

#### Warning

Follow recommended tire inflation pressures. Do not underinflate tires. Underinflated tires wear excessively and/or unevenly, adversely affect handling and fuel economy, and are more likely to fail from being overheated.

Do not overinflate tires. Overinflated tires can adversely affect handling and ride comfort, wear unevenly, increase stopping distance, and result in sudden deflation (blowout) because they are more likely to become punctured or damaged by road debris, potholes etc.

Do not overload the tires by exceeding the specified load limit as indicated on the Tire and Loading Information placard on the driver's door B-pillar. Overloading the tires can overheat them, possibly causing a blowout. Overloading the tires can also result in handling or steering problems, or brake failure.

Check the tire pressure at least once a month. Only check and correct tire pressures when the tires are cold.

### Checking the tire pressure manually

In order to determine and adjust the tire pressures, proceed as follows:

- ▶ Remove the valve cap of the tire you wish to check.
- ▶ Press the tire pressure gauge securely onto the valve.
- ▶ Read the tire pressure and compare it with the recommended value on the Tire and Loading Information placard<sup>12</sup> or on the tire pressure plate on the B-pillar on the driver's side of the vehicle.
- ▶ If necessary, increase the tire pressure to the recommended value.
- ▶ If the tire pressure is too high, release air by pressing down the metal pin in the valve using the tip of a pen, for example. Then, check the tire pressure again using the tire pressure gauge.
- ▶ Screw the valve cap onto the valve.
- ▶ Repeat the steps for the other tires.



### Tire pressure monitor

#### Important safety notes

If a tire pressure monitor is installed, the vehicle's wheels have sensors installed that monitor the tire pressures in all four tires. The tire pressure monitor warns you when the

pressure drops in one or more of the tires. The tire pressure monitor only functions if the correct wheel electronics units are installed in all wheels.

The tire pressure monitor has a yellow  warning lamp in the instrument cluster for indicating pressure loss/malfunctions (USA) or pressure loss (Canada). Depending on how the warning lamp flashes or lights up, an underinflated tire or a malfunction in the tire pressure monitor is displayed:

- if the  warning lamp is lit continuously, the tire pressure on one or more tires is significantly too low. The tire pressure monitor is not malfunctioning.
- USA only: if the  warning lamp flashes for 60 seconds and then remains lit constantly, the tire pressure monitor is malfunctioning.

#### Warning

Each tire, including the spare (if provided), should be checked at least once a month when cold and inflated to the inflation pressure recommended by the vehicle manufacturer on the Tire and Loading Information placard on the driver's door B-pillar or the tire inflation pressure label on the inside of the fuel filler flap. If your vehicle has tires of a different size than the size indicated on the Tire and Loading Information placard or the tire inflation pressure label, you should determine the proper tire inflation pressure for those tires.

As an added safety feature, your vehicle has been equipped with a tire pressure monitoring system (TPMS) that illuminates a low tire pressure telltale when one or more of your tires are significantly underinflated. Accordingly, when the low tire pressure telltale illuminates, you should stop and check your tires as soon as possible, and inflate them to the proper pressure. Driving on a significantly underinflated tire causes the tire to overheat and can lead to tire failure.

<sup>12</sup> Only for vehicles with a gross vehicle weight rating of less than 10,000 lbs(4536 kg).

Underinflation also reduces fuel efficiency and tire tread life, and may affect the vehicle's handling and stopping ability. Please note that the TPMS is not a substitute for proper tire maintenance, and it is the driver's responsibility to maintain correct tire pressure, even if underinflation has not reached the level to trigger illumination of the TPMS low tire pressure telltale.

USA only:

Your vehicle has also been equipped with a TPMS malfunction indicator to indicate when the tire pressure monitoring system is not operating properly. The TPMS malfunction indicator is combined with the low tire pressure telltale. When the system detects a malfunction, the telltale will flash for approximately one minute and then remain continuously illuminated. This sequence will continue upon subsequent vehicle start-ups as long as the malfunction exists. When the malfunction indicator is lit, the system may not be able to detect or signal low tire pressure as intended.

TPMS malfunctions may occur for a variety of reasons, including the installation of incompatible replacement or alternate tires or wheels on the vehicle that prevent the TPMS from functioning properly. Always check the TPMS malfunction telltale after replacing one or more tires or wheels on your vehicle to ensure that the replacement or alternate tires and wheels allow the TPMS to continue to function properly.

**i** USA only:

If the tire pressure monitor is malfunctioning, it may take more than 10 minutes for the  tire pressure warning lamp to inform you of the malfunction by flashing for 60 seconds and then remaining lit.

When the malfunction has been rectified, the tire pressure warning lamp goes out after driving for a few minutes.

Information on tire pressures is displayed in the on-board computer. After a few minutes of driving, the current tire pressure of each tire is shown in the on-board computer

**i** The tire pressure values indicated by the on-board computer may differ from those measured at a gas station with a pressure gauge. The tire pressures shown by the on-board computer refer to those measured at sea level. At high altitudes, the tire pressure values indicated by a pressure gauge are higher than those shown by the on-board computer. In this case, do not reduce the tire pressures.

**i** If radio transmitting equipment (e.g. wireless headphones, two-way radios) is operated inside the vehicle or in the vicinity of the vehicle, this can interfere with the operation of the tire pressure monitor.

**i** USA only:

This device complies with Part 15 of the FCC Rules. Operation is subject to the following two conditions:

1. This device may not cause harmful interference, and
2. This device must withstand any interference received, including interference that may cause undesired operation.

Unauthorized modifications to the device could void the user's authority to operate the equipment.

**i** Canada only:

This device complies with the RSS-210 Rules from Industry Canada. Operation is subject to the following two conditions:





1. This device may not cause harmful interference, and
2. This device must accept any interference received, including interference that may cause undesired operation.

Unauthorized modifications to the device could void the user's authority to operate the equipment.

## Calling up tire pressure using the on-board computer

### Vehicles with steering wheel buttons

Using the steering wheel buttons

- ▶ Turn the key to position **2** in the ignition lock.
- ▶ Press the  or  button repeatedly until the standard display (▷ page 77) is shown.
- ▶ Press the  or  button repeatedly until the current tire pressure for the individual tires is displayed.



If the vehicle has been parked for more than 20 minutes or you have not then driven faster than 18 mph (30 km/h), you will see the following message:

### tire press. displayed after driving for several minutes

- ❗ The tire pressure values indicated by the on-board computer may differ from those measured at a gas station using a pressure gauge. The on-board computer will generally give you a more exact value.

## Tire pressure loss warning system

### Vehicles without steering wheel buttons

The  tire pressure warning lamp in the instrument cluster comes on if the pressure of one or more tires drops significantly.

- ❗ USA only:

If the  tire pressure warning lamp flashes for just 60 seconds and then is lit permanently, the tire pressure monitor is malfunctioning (▷ page 196).

If a malfunction of the tire pressure monitor is recognized, the  tire pressure warning lamp shows this at the latest after ten minutes.

### Vehicles with steering wheel buttons

A message is displayed and the  tire pressure warning lamp in the instrument cluster comes on if the pressure of one or more tires drops significantly.

The tire pressure is shown in two red rectangles. The pressure of the tire concerned is shown in one of the rectangles (▷ page 199). A warning tone also sounds.

- ❗ USA only:

If the  tire pressure warning lamp flashes for just 60 seconds and then is lit permanently, the tire pressure monitor is malfunctioning (▷ page 196).

If a malfunction of the tire pressure monitor is recognized, the  tire pressure warning lamp shows this at the latest after ten minutes.

## Reactivating the tire pressure monitor

In most cases, the tire pressure monitor detects the new reference values automatically, e.g. after you have:

- changed the tire pressure
- changed wheels or tires
- installed new wheels or tires

If you wish to define new reference values manually:

- ▶ Refer to the table on the tire data labels (▷ page 256) to make sure that the pressure of all four tires is set correctly. Observe the notes on tire pressures in the "Tires and wheels" section (▷ page 280).

### Vehicles without steering wheel buttons





- ▶ Turn the key to position **2** in the ignition lock.
- ▶ Press the **(M)** menu button on the instrument cluster repeatedly until the following message is displayed:  
**+CAL- TPMS**
- ▶ Press the **(+)** button on the instrument cluster.  
The following message is displayed:  
**OK TPMS**

The tire pressure monitor activation process has begun. The tire pressures measured for the individual wheels are stored as the new reference values, provided that the tire pressure monitor considers them to be plausible.

If you wish to cancel the activation process:

- ▶ Press the **(-)** button or the **(M)** menu button on the instrument cluster.  
The activation process is canceled automatically if 30 seconds elapse with no input.

### Vehicles with steering wheel buttons

- ▶ Turn the key to position **2** in the ignition lock.
- ▶ Press the  or  button on the steering wheel repeatedly until the standard display (▶ page 77) appears.
- ▶ Press the  or  button on the steering wheel repeatedly until the current pressure of the individual tires is displayed, or the display shows the following message:  
**tire press. displayed after driving for several minutes**
- ▶ Press the **(0)** reset button on the instrument cluster.  
The following message is displayed:  
**Monitor current tire pressure?**
- ▶ Press the **(+)** button on the steering wheel.  
The following message is displayed:

### tire press. monitor reactivated

The tire pressure monitor activation process has begun. The tire pressures measured for the individual wheels are stored as the new reference values, provided that the tire pressure monitor considers them to be plausible.

If you wish to cancel the activation process:

- ▶ Press the  button on the steering wheel.

## Loading the vehicle

### Instruction labels for tires and loads

#### **Warning!**

Do not overload the tires by exceeding the specified load limit as indicated on the Tire and Loading Information placard on the B-pillar on the driver's side or on the vehicle identification plate on the driver seat frame. Overloading the tires can overheat them, possibly causing a blowout. Overloading the tires can also result in handling or steering problems, or brake failure.



The Tire and Loading Information placard on the driver's door B-pillar

The following instruction labels on your vehicle show the maximum possible load.

- (1) Only for vehicles with a gross vehicle weight rating of less than 10,000 lbs(4536 kg):

Tire and Loading Information placard ① is on the B-pillar on the driver's side. The Tire and Loading Information placard shows the permissible number of occupants and the maximum permissible vehicle load. It also contains details of the tire sizes and corresponding pressures for tires mounted at the factory.

- (2) The vehicle identification plate is located on the driver's seat frame. The vehicle identification plate informs you of the gross vehicle weight rating. It is made up of the vehicle weight, all vehicle occupants, the fuel and the cargo. You can also find information about the maximum gross axle weight rating of the front and rear axle.

The maximum gross axle weight rating is the maximum weight that can be carried by one axle (front or rear axle). Never exceed the maximum load or the maximum gross axle weight rating for the front or rear axle.

### Tire and Loading Information placard

Only for vehicles with a gross vehicle weight rating of less than 10,000 lbs(4536 kg).

### Maximum permissible gross vehicle weight rating

- ① The details on the Tire and Loading Information placard illustration are only an example. The maximum permissible gross vehicle weight rating is vehicle-specific and may differ from that which is illustrated. You can find the valid maximum permissible gross vehicle weight rating for your vehicle on the Tire and Loading Information placard.



- ① Maximum number of seats  
 ② Maximum permissible gross vehicle weight rating
- The Tire and Loading Information placard gives you details on maximum permissible gross vehicle weight rating ②: "The gross weight of occupants and luggage must never exceed XXX kilograms or XXX pounds."

The gross weight of all vehicle occupants, cargo, luggage and trailer load/noseweight (if applicable) must not exceed the specified value.

### Number of seats

- ① The details on the Tire and Loading Information placard illustration are only an example. The number of seats is vehicle-specific and can differ from the details shown. The number of seats in your vehicle can be found on the Tire and Loading Information placard.





- ① Maximum number of seats
- ② Maximum permissible gross vehicle weight rating

Maximum number of seats ① determines the maximum number of occupants allowed to travel in the vehicle. This information can be found on the Tire and Loading Information placard.

## Determining the maximum load

### Individual steps

The following steps have been developed as required of all manufacturers under Title 49, Code of U.S. Federal Regulations, Part 575 pursuant to the "National Traffic and Motor Vehicle Safety Act of 1966".

- ▶ **Step 1:** Locate the statement "The combined weight of occupants and cargo should never exceed XXX kg or XXX lbs." on your vehicle's Tire and Loading Information placard.
- ▶ **Step 2:** Determine the combined weight of the driver and passengers that will be traveling in your vehicle.
- ▶ **Step 3:** Subtract the combined weight of the driver and passengers from XXX kilograms or XXX lbs.
- ▶ **Step 4:** The resulting figure equals the available amount of cargo and luggage load capacity. For example, if the "XXX" amount equals 1400 lbs and there will be five 150 lb passengers in your vehicle, the amount of available cargo and luggage load

capacity is 650 lbs (1400 - 750 (5 x 150) = 650 lbs).

- ▶ **Step 5:** Determine the combined weight of luggage and cargo being loaded on the vehicle. For reasons of safety, that weight must not exceed the available cargo and luggage cargo capacity calculated in step 4.
- ▶ **Step 6 (if applicable):** If you intend to tow a trailer behind your vehicle, the load on the trailer is transferred to your vehicle. Consult this Operator's Manual to determine how this reduces the available cargo and luggage load capacity of your vehicle (▷ page 265).

**Example: Steps 1 to 3**

The following table shows examples of how to calculate total load and cargo capacities with varying seating configurations and number and size of occupants. The following examples use a cargo limit of 1500 lbs (680 kg). **This is for illustration purposes only.** Make sure you always use the actual load limit for your vehicle stated on the vehicle's Tire and Loading Information placard (▷ page 262).

		Example 1	Example 2	Example 3
<b>Step 1</b>	<b>Combined maximum weight of occupants and cargo (data from the Tire and Loading Information placard)</b>	1500 lbs (680 kg)	1500 lbs (680 kg)	1500 lbs (680 kg)

		Example 1	Example 2	Example 3
<b>Step 2</b>	<b>Number of people in the vehicle (driver and occupants)</b>	5	3	1
	<b>Distribution of the occupants</b>	Front: 2 Rear: 3	Front: 1 Rear: 2	Front: 1
	<b>Weight of the occupants</b>	Occupant 1: 150 lbs (68 kg) Occupant 2: 180 lbs (82 kg) Occupant 3: 160 lbs (73 kg) Occupant 4: 140 lbs (63 kg) Occupant 5: 120 lbs (54 kg)	Occupant 1: 200 lbs (91 kg) Occupant 2: 190 lbs (86 kg) Occupant 3: 150 lbs (68 kg)	Occupant 1: 150 lbs (68 kg)
	<b>Gross weight of all occupants</b>	750 lbs (340 kg)	540 lbs (245 kg)	150 lbs (68 kg)

		Example 1	Example 2	Example 3
<b>Step 3</b>	<b>Permissible cargo and trailer load/noseweight (maximum gross vehicle weight rating from the Tire and Loading Information placard minus the gross weight of all occupants)</b>	1500 lbs (680 kg) - 750 lbs (340 kg) = 750 lbs (340 kg)	1500 lbs (680 kg) - 540 lbs (245 kg) = 960 lbs (435 kg)	1500 lbs (680 kg) - 150 lbs (68 kg) = 1350 lbs (612 kg)

The greater the combined weight of the occupants, the lower the maximum luggage load. Further information can be found under "Towing a trailer" (▷ page 152).

### Vehicle identification plate

Even if you have calculated the total cargo carefully, you should still make sure that the gross vehicle weight rating and the gross axle weight rating are not exceeded. Details about this can be found on the vehicle identification plate on the driver seat frame of your vehicle (▷ page 277).

**Gross vehicle weight:** the gross weight of the vehicle, all passengers, cargo and trailer load/noseweight (if applicable) must not exceed the permissible gross vehicle weight.

**Gross axle weight rating:** the maximum permissible load that can be carried by one axle (front or rear axle).

To ensure that your vehicle does not exceed the maximum permissible values (gross vehicle weight and maximum gross axle weight rating), have your loaded vehicle (including driver, occupants, cargo, and full trailer load if applicable) weighed on a suitable vehicle weighbridge.

### Trailer load/noseweight

The trailer load/noseweight affects the gross weight of the vehicle. If a trailer is attached, the trailer load/noseweight is included in the load along with occupants and luggage. The

trailer load/noseweight is usually approximately 10% of the gross weight of the trailer and its cargo.

### Maximum tire load

#### Warning!

Do not overload the tires by exceeding the specified load limit as indicated on the Tire and Loading Information placard on the B-pillar on the driver's side or on the vehicle identification plate on the driver seat frame. Overloading the tires can overheat them, possibly causing a blowout. Overloading the tires can also result in handling or steering problems, or brake failure.



**i** The actual values for tires are specific to each vehicle and may deviate from the values in the illustration.

Maximum tire load **①** is the maximum permitted weight for which the tire is approved.

Further information on tire loads (▷ page 266).

## Tire labeling

### Overview of tire labeling

The following markings are on the tire in addition to the tire name (sales designation) and the manufacturer's name:

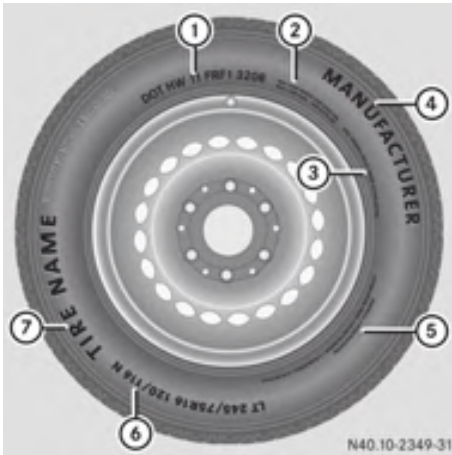

- ①** DOT, Tire Identification Number (▷ page 268)
  - ②** Maximum tire load (▷ page 265)
  - ③** Maximum tire pressure (▷ page 257)
  - ④** Manufacturer
  - ⑤** Tire material (▷ page 268)
  - ⑥** Tire size designation, load-bearing capacity and speed index (▷ page 266)
  - ⑦** Tire name
- i** Tire data is vehicle-specific and may deviate from the data in the example.

### Tire size designation, load-bearing capacity and speed index



- ①** Design standard
- ②** Tire width
- ③** Nominal aspect ratio in %
- ④** Tire code
- ⑤** Rim diameter
- ⑥** Load bearing index
- ⑦** Speed index

**i** Tire data is vehicle-specific and may deviate from the data in the example.

Instructions for tires can be found under "Tires and wheels" in the "Technical data" section (▷ page 280).

**General:** depending on the manufacturer's standards, the size imprinted in the tire wall may not contain any letters or may contain one letter **①** that precedes the size description.

If "LT" precedes the size description (as shown above): these are light truck tires according to U.S. manufacturing standards.

If "C" precedes the size description: these are commercial motor vehicle tires according to European manufacturing standards.

**Tire width:** tire width **②** shows the nominal tire width in millimeters.

**Nominal aspect ratio:** aspect ratio **③** is the size ratio between the tire height and the tire width and is shown in percent. The aspect ratio is calculated by dividing the tire width by the tire height.

**Tire code:** tire code ④ specifies the tire type. "R" represents radial tires. "D" represents diagonal tires, "B" represents diagonal radial tires.

**Rim diameter:** rim diameter ⑤ is the diameter of the bead seat, not the diameter of the rim flange. The rim diameter is specified in inches (in).

**Load bearing index:** load bearing index ⑥ is a numerical code which specifies the maximum load-bearing capacity of a tire.

#### Warning

The tire load rating must always be at least half of the GAWR of your vehicle. Otherwise, sudden tire failure may be the result which could cause an accident and/or serious injury to you or others.

Always replace rims and tires with rims and tires having the same specifications (designation, manufacturer and type) as shown on the original part.

#### Warning

Do not overload the tires by exceeding the specified load limit as indicated on the Tire and Loading Information placard on the driver's door B-pillar. Overloading the tires can overheat them, possibly causing a blowout. Overloading the tires can also result in handling or steering problems, or brake failure.

Example:

The load bearing index 120 is equivalent to a maximum load of 3042 lbs (1380 kg) that the tire can carry. If two load-bearing capacity indices are specified (as shown above), the first number states the load-bearing capacity for single tires, the second number the load-bearing capacity for twin tires. For further information on the maximum tire load in kilograms and pounds, see (▷ page 265).

**Speed index:** speed index ⑦ specifies the approved maximum speed of the tire.

#### Warning

Even when permitted by law, never operate a vehicle at speeds greater than the maximum speed rating of the tires.

Exceeding the maximum speed for which tires are rated can lead to sudden tire failure, causing loss of vehicle control and possibly resulting in an accident and/or serious personal injury and possible death, for you and for others.

Regardless of the speed index always observe the speed limits. Drive carefully and adapt your driving style to the traffic conditions.

Index	Speed rating
F	up to 50 mph (80 km/h)
G	up to 56 mph (90 km/h)
J	up to 62 mph (100 km/h)
K	up to 68 mph (110 km/h)
L	up to 74 mph (120 km/h)
M	up to 80 mph (130 km/h)
N	up to 87 mph (140 km/h)
P	up to 93 mph (150 km/h)
Q	up to 100 mph (160 km/h)
R	above 106 mph (170 km/h)

**i** Not all tires that have the M+S identification offer the driving characteristics of winter tires. Winter tires have, in addition to the M+S identification, the  snowflake symbol on the tire sidewall. Tires with this identification fulfill the requirements of the Rubber Manufacturers Association (RMA) and the Rubber Association of Canada (RAC) regarding the tire traction on snow and have been especially developed for driving on snow.

More information on reading the tire data can be obtained at any qualified specialist

workshop, e.g. at an authorized Sprinter Dealer.

### DOT, Tire Identification Number (TIN)

U.S. tire regulations prescribe that every new tire manufacturer or retreader has to imprint a TIN in or on the sidewall of each tire produced.



The TIN is a unique identification number. The TIN enables the tire manufacturers to inform purchasers of recalls and other safety-relevant matters. It makes it possible for the purchaser to easily identify the affected tires. The TIN is made up of manufacturer identification code (2), tire size (3), tire type code (4) and date of manufacture (5).

- i** Tire data is vehicle-specific and may deviate from the data in the example.

**DOT (Department of Transportation):** tire symbol (1) marks that the tire complies with the requirements of the U.S. Department of Transportation.

**Manufacturer identification code:** manufacturer identification code (2) provides details on the tire manufacturer. New tires have a code with two symbols. Retreaded tires have a code with four symbols.

Further information about retreaded tires (> page 252).

**Tire size:** identifier (3) describes the tire size.

**Tire type code:** tire type code (4) can be used by the manufacturer as a code to describe specific characteristics of the tire.

**Date of manufacture:** date of manufacture (5) provides information about the age of a tire. The first and second positions represent the week of manufacture, starting with "01" for the first calendar week. Positions three and four represent the year of manufacture. For example, a tire that is marked with "3208", was manufactured in week 32 in 2008.

### Tire characteristics



- i** Tire data is vehicle-specific and may deviate from the data in the example.

This information describes the tire cord and the number of layers in sidewall (1) and under tire tread (2).

### Definition for tires and loading

#### Tire structure and characteristics

Describes the number of layers or the number of rubber-coated belts in the tire tread and the tire wall. These consist of steel, nylon, polyester, and other materials.

#### Bar

Metric unit for tire pressure. 14.5038 pounds per square inch (psi) and 100 kilopascal (kPa) correspond to one bar.

**DOT (Department of Transportation)**

Tires with the DOT label fulfill the requirements of the U.S. Department of Transportation.

**Average weight of vehicle occupants**

The number of occupants for which the vehicle is designed multiplied by 68 kilograms (150 lb).

**Uniform Tire Quality Grading Standards**

A uniform standard to grade the quality of tires with regard to tread quality, traction and temperature characteristics. The quality grading assessment is made by the manufacturer following specifications from the U.S. government. The quality grade of a tire is imprinted on the sidewall of the tire.

**Recommended tire pressure F**

The tire pressure recommended for your vehicle for normal driving situations. The recommendation can be found on the Tire & Loading Information placard<sup>13</sup> or on the tire pressure plate on the B-pillar on the driver's side of the vehicle. The recommended tire pressure provides the best balance between handling characteristics, ride comfort and wear.

**Increased vehicle weight due to optional equipment**

The combined weight of all standard and optional equipment available for the vehicle, regardless of whether it is actually installed on the vehicle or not.

**Wheel rim**

The part of the wheel on which the tire is mounted.

**GAWR (Gross Axle Weight Rating)**

The GAWR is the maximum gross axle weight rating. The actual load on an axle must never exceed the gross axle weight rating. The Gross Axle Weight Rating can be found on the vehicle identification plate on the driver seat frame (▷ page 277).

**Speed index**

The speed index is part of the tire identification. It specifies the speed range for which the tire is approved.

**GVW (Gross Vehicle Weight)**

The gross vehicle weight includes the weight of the vehicle including fuel, tools, spare wheel, accessories installed, occupants, luggage and the drawbar noseweight if applicable. The gross vehicle weight may not exceed the GVWR (Gross Vehicle Weight Rating) specified on the vehicle identification plate on the driver seat frame (▷ page 277).

**GVWR (Gross Vehicle Weight Rating)**

The GVWR is the maximum permissible gross weight of a fully loaded vehicle (the weight of the vehicle including all accessories, occupants, fuel, luggage and the drawbar noseweight if applicable). The Gross Vehicle Weight Rating is specified on the vehicle identification plate on the driver seat frame (▷ page 277).

<sup>13</sup> Only for vehicles with a gross weight of less than 10,000 lbs(4536 kg).

**Maximum weight of the laden vehicle**

The maximum weight is the sum of the unladen weight of the vehicle, the weight of the accessories, the maximum load and the weight of the optional equipment installed at the factory.

**Kilopascal (kPa)**

Metric unit for tire pressure. 6.9 kPa is equivalent to 1 psi. Another tire pressure unit is bar. 100 kilopascal (kPa) is equivalent to 1 bar.

**Unladen weight**

The weight of a vehicle with standard equipment including the maximum filling capacity of fuel, oil, and coolant. It also includes the air-conditioning system and optional equipment if these are installed on the vehicle, but does not include passengers or luggage.

**Maximum tire load**

The maximum tire load in kilograms or pounds is the maximum weight for which a tire is approved.

**Maximum permissible tire pressure**

Maximum permissible tire pressure for one tire.

**Maximum load on one tire**

Maximum load on one tire. This is calculated by dividing the maximum axle load of one axle by two.

**PSI (Pounds per square inch)**

Standard unit of measurement for tire pressure.

**Aspect ratio**

Relationship between tire height and width in percent.

**Tire pressure**

Pressure inside the tire applying an outward force to every square inch of the tire's surface. Tire pressure is specified in pounds per square inch (psi), in kilopascal (kPa) or in bar. Tire pressure should only be corrected when the tires are cold. For this, the vehicle must have been stationary for at least three hours or not have traveled more than 1.6 km (1 mile) in this time.

**Tire tread**

The part of the tire that comes into contact with the road.

**Tire bead**

The tire bead ensures that the tire sits securely on the wheel. There are several steel wires in the bead to prevent the tire from coming loose from the wheel rim.

**Sidewall**

The part of the tire between the tread and the tire bead.

**Weight of optional extras**

The combined weight of those optional extras that weigh more than the replaced standard part and more than 2.3 kilograms (5 lbs). These optional extras, such as a roof rack or



a high-capacity battery, are not included in the unladen weight and the weight of the accessories.

### TIN (Tire Identification Number)

A unique identification number which can be used by a tire manufacturer to identify tires, for example for a product recall, and thus identify the purchasers. The TIN is composed of the manufacturer identification code, tire size, tire model code and manufacturing date.

### Load bearing index

The load bearing index (also load index) is a code that contains the maximum load bearing capacity of a tire.

### Traction

Traction is the result of friction between the tires and the road surface.

### Wear indicator

Narrow bars (tread wear bars) that are distributed over the tire tread. If the tire tread is level with the bars, the wear limit of  $\frac{1}{16}$  in (1.6 mm) has been reached.

### Distribution of the vehicle occupants

The distribution of vehicle occupants over designated seat positions in a vehicle.

### Maximum permissible payload weight

Nominal load and cargo/luggage load plus 68 kilograms (150 lb) multiplied by the number of seats in the vehicle.

## Changing wheels

### Flat tire

The "Flat tire" section in the "Practical advice" chapter (▷ page 221) contains information and notes on how to deal with a flat tire. It also provides instructions on changing a wheel or mounting the spare wheel.

### Replacing wheels

#### Warning

Rotate front and rear wheels only if the tires are of the same dimension.

If your vehicle is equipped with mixed-size tires (different tire dimensions front vs. rear), tire rotation is not possible.

#### Warning

After changing a wheel, for safety reasons you must:

- have the tightening torque checked. For wheel bolts, the tightening torque is 177 lb-ft (240 Nm) (steel wheel)/133 lb-ft (180 Nm) (alloy wheel). For wheel nuts, the tightening torque is 133 lb-ft (180 Nm). The wheels could otherwise work loose.
- check the tire pressure and correct it if necessary.
- have the wheel bolts/wheel nuts retightened after driving a distance of 30 miles (50 km). The tightening torque for wheel bolts is 177 lb-ft (240 Nm) (steel wheel)/133 lb-ft (180 Nm) (alloy wheel). The tightening torque for wheel nuts is 133 lb-ft (180 Nm).
- if using new or painted rims, have the wheel bolts and wheel nuts retightened at the specified tightening torque after the vehicle has been driven for approximately 600 to 3000 miles (1000 to 5000 km).
- have the direction of rotation corrected, if reversed, as soon as possible at a qualified specialist workshop, e.g. an authorized Sprinter Dealer. The vehicle handling

characteristics could otherwise be affected.

Otherwise, the operating reliability and road safety of the vehicle could be jeopardized. This could cause you to lose control of your vehicle, resulting in an accident and injuring yourself or others.

The vehicle tires are an essential component in the overall performance and stability of the vehicle. The service life of tires is dependent upon and proportional to tire type, speed rating, environmental conditions, tire load, tire pressure, road quality and individual driving style.

For this reason, we recommend regularly checking wear and correct tire pressure as well as – according to the appropriate tire configuration of the vehicle – regularly rotating the tires.

The wear patterns on the front and rear tires differ, depending on the operating conditions. Rotate the wheels before a clear wear pattern has formed on the tires. Front tires typically wear more on the shoulders and the rear tires in the center.

If your vehicle's tire configuration allows, you can rotate the wheels according to the intervals in the tire manufacturer's warranty book in your vehicle documents. If no warranty book is available, the tires should be rotated every 3000 to 6000 miles (5000 to 10000 km), or earlier if tire wear requires. Do not change the direction of rotation.

Clean the contact surfaces of the wheel and the brake disc thoroughly every time a wheel is rotated. Check the tire pressures.

**!** If your vehicle is equipped with the tire pressure monitor, each wheel has an electronic component.

Tire-mounting tools should not be applied in the area of the valve. Otherwise, the electronic components could be damaged.

Only have the tires changed at a qualified specialist workshop, e.g. an authorized Sprinter Dealer.

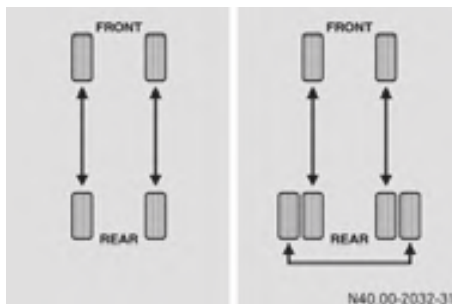

Diagram for rotating single tires and twin tires

### Single tires

If the tires have identical dimensions, you may rotate the tires at the front and rear axles in pairs so that the tires' original direction of rotation remains the same. On unidirectional tires, an arrow on the sidewall shows the prescribed direction of rotation of the tire.

### Twin rear tires

If the tires have identical dimensions, you may rotate the tires at the front axle and the inner wheels at the rear axle in pairs so that the tires' original direction of rotation remains the same. With nondirectional tires, you may rotate the outside wheels at the rear axle sideways.

Information on changing wheels  
(▷ page 229).

### Direction of rotation

Tires with a specified direction of rotation have additional benefits, e.g. if there is a risk of hydroplaning. You will only gain these benefits if the correct direction of rotation is observed.

An arrow on the sidewall of the tire indicates its correct direction of rotation.

You may mount a spare wheel against the direction of rotation. Observe the time restriction on use as well as the speed limitation specified on the spare wheel.

### Storing wheels

Store wheels that are not being used in a cool, dry and preferably dark place. Protect the tires from contact with oil, grease and fuel.

### Cleaning wheels

#### **Warning**

Do not use power washers with circular jet nozzles (concentrated-power jets) to clean your vehicle, especially for cleaning tires. You could otherwise damage the tires and cause an accident.



<b>Vehicle equipment .....</b>	<b>276</b>
<b>Genuine Sprinter parts .....</b>	<b>276</b>
<b>Vehicle electronics .....</b>	<b>276</b>
<b>Vehicle identification plates .....</b>	<b>277</b>
<b>Operating data .....</b>	<b>280</b>
<b>Capacities .....</b>	<b>287</b>

## Vehicle equipment

- i** Diese Betriebsanleitung beschreibt alle Modelle, Serien- und Sonderausstattungen Ihres Fahrzeugs, die zum Zeitpunkt des Redaktionsschlusses dieser Betriebsanleitung erhältlich waren. Länderspezifische Abweichungen sind möglich. Beachten Sie, dass Ihr Fahrzeug nicht mit allen beschriebenen Funktionen ausgestattet sein könnte. Dies betrifft auch sicherheitsrelevante Systeme und Funktionen.

## Genuine Sprinter parts

We test genuine parts, conversion parts and accessories that have been specifically approved for the type of vehicle for:

- reliability
- safety
- suitability

Despite ongoing market research, we are unable to assess other parts. We therefore accept no responsibility for the use of such parts in Sprinters, even if they have been independently or officially approved.

In Germany and some other countries, certain parts are only officially approved for installation or modification if they comply with legal requirements. All genuine Sprinter parts satisfy these requirements.

Make sure that any replacement parts are suitable for your vehicle. In many countries, parts which result in a modification to the vehicle could invalidate the vehicle's general operating permit.

This is the case if:

- they cause a change to the vehicle type from that for which the vehicle's general operating permit was granted.
- other road users could be endangered.
- emission or noise levels are adversely affected.

The use of non-approved parts could affect your vehicle's operating safety. We therefore recommend that you use genuine Sprinter parts, conversion parts and accessories that have been approved for the type of vehicle.

### Environmental note

We supply reconditioned assemblies and parts which are of the same quality as new parts. The same New Vehicle Limited Warranty applies as for new parts.

Genuine Sprinter parts, approved conversion parts and accessories are available from an authorized Sprinter Dealer. Here you will receive advice about permissible technical modifications, and the parts will be professionally installed.

Always provide the vehicle's identification number and the engine number when ordering genuine parts. The numbers can be found on the vehicle identification plate of your vehicle (> page 277).

## Vehicle electronics

### Tampering with the engine electronics

#### Warning!

For safety reasons and to preserve the General Operating Permit, have procedures involving engine electronics and associated parts performed only at a qualified specialist workshop that has the necessary specialist knowledge and tools to carry out the work required. Your driving safety may otherwise be impaired.

For this reason, we recommend an authorized Sprinter Dealer. In particular, all work relevant to safety or on safety-related systems must be carried out at a qualified specialist workshop.

- i** Always have the engine electronics system and its components such as control units, sensors and connector leads serviced at a qualified specialist workshop,

for example an authorized Sprinter Dealer. Otherwise, the vehicle parts may wear out more quickly. This can invalidate the general operating permit and the insurance cover, and lead to the loss of the New Vehicle Limited Warranty.

### Retrofitting electrical or electronic equipment

Electrical and electronic equipment can jeopardize the operational safety of the vehicle. If equipment of this kind is retrofitted, it must be type-approved and bear the **e** mark. The **e** mark may be obtained from the equipment manufacturer or an authorized testing center.

**!** Damage or consequential damage arising from installing equipment that is not approved for Sprinters is not covered by the New Vehicle Limited Warranty.

If you wish to install telephones or two-way radios in the vehicle, you must obtain formal approval.

For operation of mobile phones and two-way radios, We recommend connection to an approved exterior antenna. This is the only way to ensure optimum reception quality inside the vehicle and to minimize mutual interference between the vehicle electronics, mobile phones and two-way radios.

#### Warning

Excessive electromagnetic radiation may constitute a health hazard to yourself and others. Use of an exterior antenna gives consideration to scientific discussion surrounding the possible health risk posed by electromagnetic fields.

The exterior antenna should only be installed at a qualified specialist workshop which has the necessary specialist knowledge and tools to carry out the work required. We recommend that you use an authorized Sprinter Dealer for this purpose. In particular, work relevant to safety or on safety-related

systems must be carried out at a qualified specialist workshop.

The transmission output of the mobile phone or two-way radio must not exceed the maximum transmission outputs listed.

Frequency range	Maximum transmission output (PEAK)
Short wave (f < 50 MHz)	100 W
4 m waveband	30 W
2 m waveband	50 W
Trunked radio/Tetra	35 W
70 cm waveband	35 W
GSM 900/AMPS	10 W
GSM 1800	10 W
UMTS	10 W

**!** If electrical or electronic equipment which does not fulfill these conditions is used in the vehicle, the vehicle's general operating permit may be invalidated.

### Vehicle identification plates

#### Vehicle identification plates

The vehicle identification plate with the vehicle identification number (VIN), the paint code, and the specifications for the permissible weights is located on the base of the driver's seat.



Base of the driver's seat

- ① Vehicle identification plate with vehicle identification number for vehicles or chassis

The VIN is also stamped into the rear wall of the engine compartment (▷ page 279).



Example of a vehicle identification plate (US vehicles)

- ② VIN
- ③ Paint code

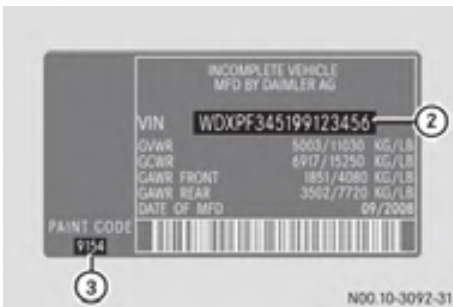

Example of a chassis identification plate (US vehicles)

- ② VIN
- ③ Paint code



Example of a vehicle identification plate (vehicles for Canada)

- ② VIN
- ③ Paint code



Example of a chassis identification plate (vehicles for Canada)

- ② VIN
- ③ Paint code



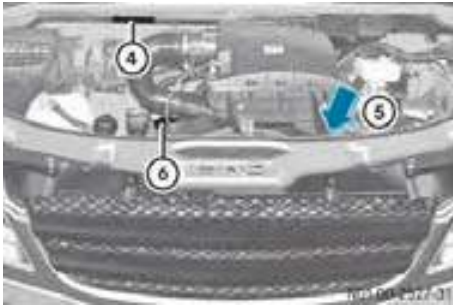

Engine compartment

- ④ VIN (stamped on the rear wall of the engine compartment)
- ⑤ Engine number (stamped on the crankcase)
- ⑥ Emission Control Information and engine oil<sup>14</sup> label

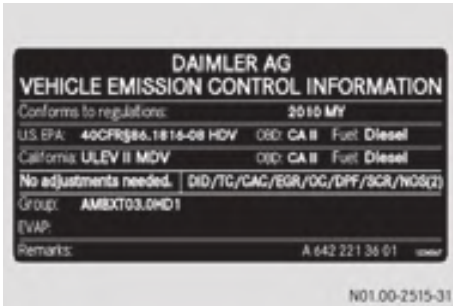

Example: Emission Control Information label

- ① The data shown in the pictures is for the purposes of illustration. Such data is vehicle-specific and can differ from that shown. Always observe the specifications on your vehicle's identification plate.

### Tire plates

The Tire and Loading Information label<sup>15</sup> or the Tire Pressure label is on the B-pillar on the driver's side. You will find the required tire pressure values for the vehicle's original tires on the relevant tire labels.

The Tire and Loading Information label also specifies the number of seats and the permissible load.



- ① Tire and Loading Information label or Tire Pressure label

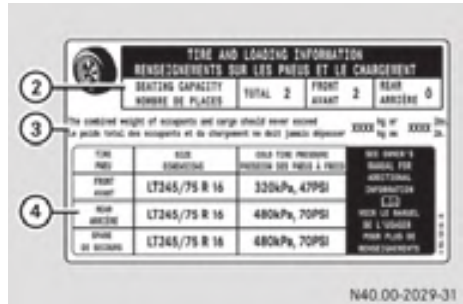

Tire and Loading Information label

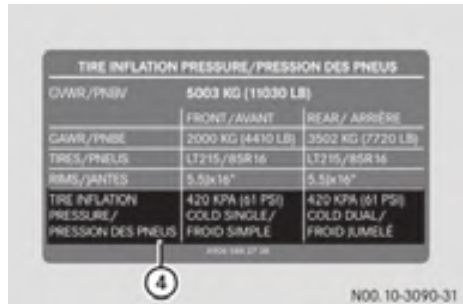

Tire Pressure label

- ② Number of seats
- ③ Permissible load
- ④ Recommended pressure for cold tires

<sup>14</sup> Note also the engine oil information for diesel engines under "Service products" in the "Operation" section.

<sup>15</sup> Vehicles with a permissible gross weight of up to 10,000 lbs(4536 kg) only.

- i** The data shown in the pictures is for the purposes of illustration. Such data is vehicle-specific and can differ from that shown. Always observe the specifications on your vehicle's tire label.

The tire pressure information applies to all load levels up to the permissible gross weight and is only valid for original tires in their cold state.

## Operating data

### General notes

The "Technical data" section contains important technical data for your vehicle.

You can find vehicle-specific and equipment-dependent technical data in your vehicle registration papers, such as:

- engine power output data
- speeds
- vehicle dimensions
- vehicle weights

### Tires and wheels

- !** Only use tire and rim sizes approved for your type of vehicle. These have been specially adapted for use with the control systems, such as ABS or ESP®.

Take note of the operating safety information on tires and wheels in the "Tires and wheels" section (▷ page 252).



- i** In particular, please also observe the permissible tire specifications in your country.

These specifications may stipulate a certain tire type for your vehicle and/or prohibit the use of certain tire types permitted in other countries.

Observe the required tire load-bearing capacity and the speed index for your vehicle.

Information about wheels and tires can be obtained from any authorized Sprinter Dealer. You will find details about the original tires on the tire data label on the B-pillar on the driver's side of your vehicle (▷ page 279).

## Overview

Vehicle type	2500	3500
Rim size (pressed-steel rim)	6.5 J x 16	5.5 J x 16
Rim size (alloy rim)	6.5 J x 16	–
Offset	2.13 in (54 mm)	–
Half distance from center to center	–	4.82 in (122.5 mm)
Wheel attachment	Wheel bolts	Wheel nuts
Tightening torques (pressed-steel rim)	177 lb-ft (240 Nm)	133 lb-ft (180 Nm)
Tightening torques (alloy rim)	133 lb-ft (180 Nm)	–
Summer tires	–	–
All-weather tires <sup>16</sup>	LT 245/75 R16 120/116N	LT 215/85 R16 115/112N
		LT 215/85 R16 115/112Q
Winter tires <sup>16</sup>	LT 245/75 R16 120/116N M+S 	LT 215/85 R16 115/112N M+S 

## Tire pressure

Take note of the information on tire pressure in the "Wheels and tires" section (▷ page 255).

### Warning

Underinflated tires:

- jeopardize driving safety
- damage or destroy the tires
- lead to overheating of tires, even to the point of catching fire

You could thereby lose control of the vehicle and injure yourself and others.

For this reason, check the tire pressure regularly before starting a journey and correct it if necessary.

Correct the tire pressure before loading. If the vehicle is loaded, check the tire pressure, and correct it if necessary.

While driving, dependent on driving speeds and load, the tire temperature and with it, the tire pressure rise.

You should thus only correct tire pressures when the tires are cold. If the tires are warm, you may only correct tire pressures when:

- taking the respective tire temperatures into consideration with the vehicle laden, the values apparent from the tire pressure table are not exceeded.
- taking the respective tire temperatures into consideration with the vehicle unladen, the values apparent from the tire pressure table are not met.

The tires are considered cold if the vehicle has been parked for at least 3 hours or been driven less than 1 mile (1.6 km) with an outside temperature of about 68 °F (20 °C).

-  The tire pressure changes by approximately 10 kPa (0.1 bar/1.5 psi) per

<sup>16</sup> Radial tires.

18 °F (10 °C) in air temperature. This must be observed when checking tire pressure inside a building – especially in winter.

Example:

Room temperature = approximately 68 °F (20 °C)

Outside temperature = approximately 32 °F (0 °C)

Tire pressure to be set: prescribed tire pressure +20 kPa (+0.2 bar/+3 psi).

**!** The difference in pressures in the tires of an axle must not be greater than 10 kPa (0.1 bar/1.5 psi).

A tire pressure less than 300 kPa (3.0 bar/43.6 psi) is not permissible.

The tire pressure values in the following table apply to all load conditions up to the maximum permissible gross vehicle weight and only to the specified original tires in cold condition. The values are determined by the permissible axle loads found on the vehicle identification plate on the driver seat frame (▷ page 277).

**i** Additionally, you will find the stipulated tire pressure values on the tire data label on the B-pillar on the driver's side of your vehicle (▷ page 279).

**Tire pressure table**

Tires	Permissible axle loads (see vehicle identification plate)					
	Front axle			Rear axle		
	3970 lbs (1801 kg)	4080 lbs (1851 kg)	4410 lbs (2000 kg)	5360 lbs (2431 kg)	7060 lbs (3202 kg)	7720 lbs (3502 kg)
LT 215/85 R 115/112 N	–	380 kPa (3.8 bar/ 55 psi)	420 kPa (4.2 bar/ 61 psi)	–	380 kPa (3.8 bar/ 55 psi)	420 kPa (4.2 bar/ 61 psi)
LT 215/85 R 115/112 Q	–	380 kPa (3.8 bar/ 55 psi)	420 kPa (4.2 bar/ 61 psi)	–	380 kPa (3.8 bar/ 55 psi)	420 kPa (4.2 bar/ 61 psi)
LT 245/75 R 120/116 N	320 kPa (3.2 bar/ 47 psi)	–	–	480 kPa (4.8 bar/ 70 psi)	–	–

Technical data

**Lashing points and carrier systems**

**Lashing points**

- ❗ Observe the information on the maximum loading capacity of the lashing points. If you use multiple lashing points to secure a load, you should observe the maximum loading capacity of the weakest lashing point. When you brake hard, for example, forces apply that can be far higher than the weight force of the transported load. Always use multiple lashing points to distribute these forces, and distribute the load equally among them.

You will find further information about lashing points and cargo tie-down rings in the "Operation" section (▷ page 146).

**Cargo tie-down rings**

The maximum tensile load of the cargo tie-down rings is:

Cargo tie-down rings	Permissible nominal tensile load
Passenger Van	786.5 lbf (3500 N)
Cargo Van	1124.0 lbf (5000 N)

### Load rails

The maximum tensile loads of the lashing points in the cargo compartment are:

Lashing point	Permissible nominal tensile load
Load rails on cargo floor	1124.0 lbf (5000 N)
Lower load rail on sidewall	562.0 lbf (2500 N)
Upper load rail on sidewall	337.0 lbf (1500 N)

The values specified apply only to loads placed on the floor of the cargo compartment if:

- the load is secured to 2 lashing points on the rail and
- the distance to the next load securing point on the same rail is approx. 3 ft (1 m).

### Roof carrier

#### Warning

If you have installed a roof carrier, the vehicle's handling, steering and braking characteristics may change due to the higher center of gravity. This is the case particularly if the roof carrier is laden. Adapt your driving style according to the vehicle load.

Observe the manufacturer's installation instructions. An incorrectly secured roof carrier and/or load could come loose, fall off and thereby endanger you or others.

Observe the maximum roof load and maximum roof carrier load. Loads transported on the roof must always be secured with particular care.

Do not allow the load, including passengers, to exceed the permissible gross vehicle weight or the gross axle weight rating for your vehicle.

Maximum roof load and minimum number of pairs of roof carrier supports on vehicles with:

	Maximum roof load	Minimum number of pairs of supports
Standard roof	660 lbs (300 kg)	6
High roof	330 lbs (150 kg)	3

The data is valid for a load distributed evenly over the entire roof area.

 The weight of any load carried on the roof, including the roof carrier, must not exceed the maximum permissible roof load.

The roof carrier supports must be mounted at equal distances.

We recommend that you have a stabilizer bar installed to the front axle.

Reduce the load on shorter roof carriers proportionately. The maximum load per pair of roof carrier supports is 110 lbs(50 kg).

 For safety reasons, we recommend that you only use roof carrier systems which have been tested and approved for Sprinters. This will help to avoid damage.

Loading directions and other information concerning load distribution and load securing can be found in the "Operation" section (> page 144).

### Trailer tow hitch

 We recommend that trailer tow hitches be retrofitted at an authorized Sprinter Dealer

 Only use a trailer tow hitch which has been tested and specially approved by the distributor named on the inside of the front cover for your vehicle.

The permitted weight and load values, which must not be exceeded, can be found in your

vehicle's registration papers and on the type plate of the trailer coupling, the trailer and the vehicle identification plate (▷ page 277). In the event that the data stated differs, the lower value applies.

Make sure that you adhere to the weight restrictions by having the weight checked at a public weighbridge.

**!** The permissible gross combination weight is less than the sum of the permissible gross vehicle weight plus the permissible trailer load. Exceeding the permissible gross combination weight can lead to damage to the drivetrain, to the transmission or to the trailer tow hitch.

For this reason, applicable values for the permissible gross vehicle weight or the permissible trailer load are reduced accordingly if either the vehicle or the trailer is fully loaded. In this case, the trailer or the vehicle may only be partially loaded.

## Maximum permitted weights and loads

Technical data

Type of vehicle	Gross vehicle weight GVWR	Gross front axle load GAWR (FA)	Gross rear axle load GAWR (RA)	Gross combination weight <sup>17</sup> GCWR	Trailer load <sup>18</sup> GTW	Maximum permissible nose weight TWR
<b>2500</b>	8550 lbs (3878 kg)	3970 lbs (1801 kg)	5360 lbs (2431 kg)	13,550 lbs (6146 kg)	5000 lbs (2268 kg)	500 lbs (227 kg)
<b>3500</b>	9900 lbs (4490 kg) Canada only	4080 lbs (1851 kg)	7060 lbs (3202 kg)	14,900 lbs (6759 kg)	5000 lbs (2268 kg)	500 lbs (227 kg)
		4410 lbs (2000 kg)		15,250 lbs (6917 kg)	7500 lbs (3402 kg)	750 lbs (340 kg)
	9990 lbs USA only (4531 kg)	4080 lbs (1851 kg)	7060 lbs (3202 kg)	14,900 lbs (6759 kg)	5000 lbs (2268 kg)	500 lbs (227 kg)
		4410 lbs (2000 kg)		15,250 lbs (6917 kg)	7500 lbs (3402 kg)	750 lbs (340 kg)
	11,030 lbs (5003 kg)	4080 lbs (1851 kg)	7720 lbs (3502 kg)	15,250 lbs (6917 kg)	5000 lbs (2268 kg)	500 lbs (227 kg)
		4410 lbs (2000 kg)			7500 lbs (3402 kg)	750 lbs (340 kg)

<sup>17</sup> Maximum permissible gross weight of the vehicle and trailer including a driver weight of 68 kg.

<sup>18</sup> Maximum permissible gross weight of the trailer.



Capacities

Engine with oil filter	Fuel tank	DEF tank	Cooling system	Windshield/headlamp cleaning system
Engine oil	ULTRA-LOW SULFUR DIESEL	Diesel Exhaust Fluid (DEF) <sup>19</sup>	Coolant <sup>20</sup>	Washer fluid with windshield washer concentrate
13.21 US qt (12.5 l)	25.0 US gal (100 l) <sup>21</sup>	3.2 US gal (12.0 l)/ 4.9 US gal (18.5 l)/ 5.8 US gal (22.0 l) <sup>22</sup>	10.75 US qt (10.0 l)	Approx. 6.3 US qt (6.0 l)

Technical data

<sup>19</sup> DEF according to ISO 22241. Observe MB Specifications for Service Products, Sheet No. 352.0.

<sup>20</sup> When the coolant is being renewed, the coolant must contain 50 % by volume of anticorrosion/antifreeze agent. This is equivalent to antifreeze protection down to -34.6 °F (-37 °C). Do not exceed a ratio of 55 % by volume (antifreeze protection down to approximately -49.0 °F (-45 °C). Heat dissipation is otherwise insufficient. Observe the MB Specifications for Service Products, Sheet No. 310.1.

<sup>21</sup> Including a reserve of 5.3 US gal (20 l).

<sup>22</sup> Chassis Cab only.



## **Impressum**

### **Internet**

Further information about Mercedes-Benz vehicles can be found on the following website:

[www.mercedes-benz.com](http://www.mercedes-benz.com)

### **Editorial office**

You are welcome to forward any queries or suggestions you may have regarding this manual to the technical documentation team at the address mentioned on the inside of the front cover.

© Mercedes-Benz USA LLC

© Mercedes-Benz Canada Inc.

Mercedes-Benz USA LLC and Mercedes-Benz Canada Inc. are Daimler companies.

Not to be reprinted, translated or otherwise reproduced, in whole or in part, without written permission.

Printed in U.S.A

Press date: August 1, 2010



9065844871

Order no. 6462 7471 13 Part no. 906 584 48 71 Edition B MY 2011 MB