



# OPERATOR'S HANDBOOK

## Mack® Pinnacle™ Series (CHU Series)

Mack® CHU Series

21394649

© Mack Trucks, Inc. 2010  
Printed in U.S.A.

OPERATOR'S HANDBOOK

21394649



# OPERATOR'S HANDBOOK

## Mack® Pinnacle™ Series (CHU Series)

21394649  
April 2010





# Foreword

This manual contains information concerning the and function of the Mack Link System. The information in this manual applies to vehicles built April 2010 and later. Please keep this manual in the vehicle at all times.

**Note:** Illustrations in this manual are used for reference only and may differ slightly from the actual vehicle. However, key components addressed in this document are represented as accurately as possible.

The National Highway Traffic Safety Administration (NHTSA) and Mack Trucks Inc. should be informed immediately if you believe that the vehicle has a defect that could cause a crash, injury or death.

Contact NHTSA by calling the Auto Safety Hotline at 1 (888) 327-4236, by writing to NHTSA, U.S. Department of Transportation, Washington, DC 20590, by TTY at 1 (800) 424-9153, or visit their website at [www.nhtsa.dot.gov](http://www.nhtsa.dot.gov).

**Mack Trucks, Inc.**

Greensboro, NC USA

**Order number: PV776-21394649**

©2010 Mack Trucks, Inc., Greensboro, NC USA

All rights reserved. No part of this publication may be reproduced, stored in retrieval system, or transmitted in any forms by any means, electronic, mechanical, photocopying, recording or otherwise, without the prior written permission of Mack Trucks, Inc.

<https://www.truck-manuals.net/mack/>

---

# Contents

|   |           |
|---|-----------|
| <b>INTRODUCTION.....</b>                              | <b>1</b>  |
| TO THE OWNER.....                                     | 1         |
| In Appreciation .....                                 | 1         |
| About This Handbook.....                              | 2         |
| THE VEHICLE.....                                      | 3         |
| Basic Configuration .....                             | 3         |
| Vehicle Management and Control System (V-MAC®).....   | 3         |
| COMPONENT IDENTIFICATION.....                         | 4         |
| VIN Locations.....                                    | 4         |
| Engine Identification.....                            | 5         |
| Engine Information Plate.....                         | 6         |
| Clean Idle Engines.....                               | 7         |
| Transmission Identification.....                      | 8         |
| WARRANTY INFORMATION.....                             | 11        |
| Air Brake System.....                                 | 11        |
| ENGINE GASEOUS EMISSION CONTROL SYSTEMS.....          | 12        |
| Emissions Control System Warranty.....                | 13        |
| ENGINE GASEOUS EMISSIONS CONTROL SYSTEM WARRANTY..... | 15        |
| FEDERAL EMISSION REQUIREMENTS.....                    | 16        |
| EMISSION CONTROL SYSTEMS WARRANTY — CALIFORNIA.....   | 16        |
| Emissions Control System Warranty.....                | 18        |
| SERVICE LITERATURE.....                               | 22        |
| MACK Class 8 –Components Service Manual .....         | 22        |
| Class 8 – Custom Collated Service Manual on CD.....   | 22        |
| CUSTOMER SERVICE.....                                 | 23        |
| Call 1-800-866-1177 for MACK One-Call™.....           | 23        |
| Questions and Complaints.....                         | 23        |
| Addresses.....  | 24        |
| Additional Assistance.....                            | 25        |
| REPORTING SAFETY DEFECTS.....                         | 26        |
| United States.....                                    | 26        |
| Canada.....   | 26        |
| Mexico.....   | 26        |
| EVENT DATA RECORDING DEVICES.....                     | 27        |
| <b>SAFETY INFORMATION.....</b>                        | <b>28</b> |
| SAFETY STATEMENT.....                                 | 28        |
| CERTIFICATION LABELS.....                             | 30        |
| Safety Certification Label.....                       | 30        |
| ADVISORY LABELS.....                                  | 32        |
| Advisory Label Locations (On Vehicle).....            | 32        |
| TRUCK-TRACTOR CONSPICUITY.....                        | 43        |
| CAB ENTRY/EXIT.....                                   | 44        |
| Three-Limb Contact.....                               | 44        |
| Driver Side.....                                      | 46        |
| Passenger Side.....                                   | 48        |
| Deck Plate Access.....                                | 50        |

|  |            |
|--|------------|
| SAFETY TIPS FOR COLD WEATHER .....                     | 52         |
| Driver Visibility .....                                | 52         |
| Auxiliary Cab Heater .....                             | 53         |
| Cab Door Seals and Key Locks .....                     | 54         |
| Outside Mirror Heater .....                            | 54         |
| Air Horn Snow Shield.....                              | 55         |
| Emergency Reflector Kit.....                           | 55         |
| Fire Extinguisher (Optional).....                      | 55         |
| <b>INSTRUMENTS AND CONTROLS .....</b>                  | <b>56</b>  |
| CAB INTERIOR.....                                      | 56         |
| INSTRUMENT PANEL .....                                 | 57         |
| Tell-Tales.....  | 57         |
| Panel Arrangement.....                                 | 58         |
| INSTRUMENT PANEL GAUGE LAYOUT .....                    | 59         |
| Panel A.....   | 61         |
| Panel B.....   | 62         |
| Panel C .....  | 64         |
| Panel D.....   | 65         |
| Function of Optional Switches.....                     | 78         |
| CAB CLIMATE CONTROL .....                              | 85         |
| SLEEPER CLIMATE CONTROL .....                          | 87         |
| LIGHT CONTROL PANEL .....                              | 88         |
| LOWER CONSOLE PANEL .....                              | 89         |
| STEERING COLUMN.....                                   | 90         |
| Combination Starter and Electrical Switch.....         | 90         |
| Steering Wheel Adjustment .....                        | 90         |
| Turn Signal Lever .....                                | 91         |
| Stalk Switch (If Equipped, Co-Pilot® Only).....        | 92         |
| FLOOR PEDALS .....                                     | 93         |
| MISCELLANEOUS CONTROLS .....                           | 94         |
| Dome Light .....                                       | 94         |
| Interior Cab Lights (Sleeper Cab).....                 | 95         |
| Air Horn .....   | 95         |
| Fresh Air Vent.....                                    | 96         |
| Cab Air Filter .....                                   | 97         |
| Microphone.....  | 98         |
| Accessory Power Outlets .....                          | 99         |
| .....  | <b>102</b> |
| <b>PRE-TRIP INSPECTION AND DAILY MAINTENANCE .....</b> | <b>102</b> |
| Pre-Trip Inspection Quick List .....                   | 103        |
| New Vehicle Break-In.....                              | 114        |
| <b>WINDSHIELD WASHER RESERVOIR .....</b>               | <b>117</b> |
| <b>HOOD .....</b>                                      | <b>118</b> |
| Opening the Hood .....                                 | 118        |
| Closing the Hood .....                                 | 120        |

---

|   |     |
|---|-----|
| Locking the Hood .....                                      | 121 |
| HOSE TENDERS .....  | 122 |
| DOORS .....   | 123 |
| Standard Door Panel .....                                   | 123 |
| Power Door Panel (Optional).....                            | 124 |
| Opening the Cab Door .....                                  | 125 |
| Locking the Cab Door.....                                   | 125 |
| Power Window Regulators .....                               | 125 |
| REMOTE KEYLESS ENTRY — (OPTIONAL).....                      | 126 |
| Transmitter Operations .....                                | 127 |
| Battery Replacement.....                                    | 128 |
| SEAT BELTS .....  | 131 |
| Seat Belt Operation .....                                   | 131 |
| Fastening Seat Belt .....                                   | 131 |
| Adjustable D-Ring Shoulder Belts (if equipped).....         | 133 |
| Komfort® Latch System.....                                  | 134 |
| SLEEPER BUNK RESTRAINT .....                                | 136 |
| Upper Bunk (Optional).....                                  | 136 |
| Bunk Restraint .....  | 137 |
| Bunk Restraint Maintenance.....                             | 137 |
| SEAT ADJUSTMENT AND RECLINE (IF EQUIPPED).....              | 138 |
| HEATED SEAT (OPTIONAL).....                                 | 138 |
| SWIVEL SEAT (OPTIONAL).....                                 | 138 |
| MACK ENGINE INFORMATION .....                               | 141 |
| Precautions and Warnings .....                              | 141 |
| Engine Model Designations.....                              | 142 |
| CRUISE CONTROL .....  | 143 |
| Speed Control Switches .....                                | 143 |
| Setting Cruise Control .....                                | 144 |
| Disengaging Cruise Control.....                             | 144 |
| MACK POWERLEASH™ ENGINE BRAKE (IF EQUIPPED).....            | 145 |
| Engine Brake Switch.....                                    | 146 |
| How the Engine Brake is Activated.....                      | 147 |
| Cruise Control with the MACK PowerLeash™ Engine Brake ..... | 148 |
| ON THE ROAD WITH THE MACK POWERLEASH™ ENGINE BRAKE .....    | 149 |
| Over Flat Terrain.....                                      | 149 |
| Descending a Grade .....                                    | 150 |
| On Slippery Road Surfaces.....                              | 152 |
| BRAKE .....   | 154 |
| Air Brake System.....                                       | 154 |
| Automatic Slack Adjusters .....                             | 155 |
| Parking Brake System.....                                   | 156 |
| Parking Brake .....   | 156 |
| Parking .....   | 156 |
| Anti-Lock Brake System (ABS).....                           | 157 |
| Automatic Traction Control (ATC) (If Equipped).....         | 162 |
| GOOD DRIVING HABITS.....                                    | 163 |

|   |     |
|---|-----|
| Weight Ratings .....  | 163 |
| Instruments .....   | 163 |
| Shutting Down the Engine .....  | 163 |
| General Observation .....   | 163 |
| STARTING THE VEHICLE .....  | 164 |
| General Information .....   | 164 |
| Push Button Starters .....  | 164 |
| Air Starters .....  | 165 |
| Engine Warm-Up .....  | 168 |
| Engine Idling .....   | 168 |
| Shutting Down the Engine .....  | 169 |
| COLD WEATHER OPERATION .....  | 171 |
| Cold Weather Starting Tips .....  | 171 |
| Engine Block Heaters .....  | 172 |
| Winterfronts .....  | 173 |
| COUPLING A TRAILER .....  | 176 |
| UNCOUPLING A TRAILER .....  | 178 |
| MOVING THE VEHICLE — GENERAL INFORMATION .....  | 180 |
| Braking .....   | 180 |
| Shifting .....  | 180 |
| Engine Temperature .....  | 181 |
| Clutch (If Equipped) .....  | 182 |
| POWER TAKE-OFF (PTO) .....  | 186 |
| PTO Precautions .....   | 186 |
| PTO Classification .....  | 187 |
| Side-Mounted PTO Locations .....  | 187 |
| PTO Operating Procedures .....  | 187 |
| TRANSMISSION SHIFTING INSTRUCTIONS .....  | 188 |
| Shifting Instructions for Allison Automatic Transmissions .....   | 188 |
| MACK T306G Shifting Instructions .....  | 189 |
| MACK TM308 Shifting Instructions .....  | 190 |
| MACK TM308M Shifting Instructions .....   | 192 |
| MACK TM309 Shifting Instructions .....  | 194 |
| MACK TM309M Shifting Instructions .....   | 195 |
| MACK T309, T309L and T309LR Shifting Instructions .....   | 198 |
| MACK T310 Shifting Instructions .....   | 202 |
| MACK T310M, T310ME and T310MLR Shifting Instructions .....  | 205 |
| MACK T313-T313L-T313LR Shifting Instructions .....  | 209 |
| MACK T31321, T313L21 and T313LR21 Shifting Instructions .....   | 213 |
| MACK T318, T318L and T318LR Shifting Instructions .....   | 217 |
| MACK T31821, T318L21 and T318LR21 Shifting Instructions .....   | 224 |
| Precautions When Descending Grades If Vehicle is Equipped with Eaton<br>AutoShift Generation I and II ..... | 230 |
| AXLES .....   | 231 |
| Rear Axles Other Than MACK .....  | 231 |
| MACK Rear Axles .....   | 231 |
| Engaging the Power Divider Lockout .....  | 233 |

---

|  |            |
|--|------------|
| <b>Mack, EPA2010 Emissions Solution.....</b>                           | <b>234</b> |
| DIESEL PARTICULATE FILTERS (IF EQUIPPED) .....                         | 234        |
| Extended Idling and Aftertreatment System Conditioning .....           | 237        |
| Exhaust Aftertreatment System .....                                    | 238        |
| Safety Information .....   | 239        |
| Exhaust Aftertreatment System Components and .....                     | 240        |
| Selective Catalytic Reduction (SCR) .....                              | 240        |
| Diesel Exhaust Fluid (DEF).....  | 243        |
| Aftertreatment Diesel Particulate Filter (DPF).....                    | 246        |
| Aftertreatment Control Module (ACM).....                               | 247        |
| Exhaust Aftertreatment System .....                                    | 248        |
| Driver Warnings and On Board Diagnostics (OBD) .....                   | 254        |
| On Board Diagnostics (OBD).....  | 254        |
| Instrument Cluster.....  | 255        |
| Malfunction Indicator Lamp (MIL).....                                  | 256        |
| Aftertreatment DEF Tank Level - Driver Warning & Inducement.....       | 257        |
| Aftertreatment DEF Quality - Driver Warning & Inducement .....         | 258        |
| Misfilling Diesel or Aftertreatment DEF Tanks.....                     | 259        |
| SCR Tampering - Driver Warning & Inducement .....                      | 260        |
| Warranty and Maintenance .....   | 261        |
| Exhaust Aftertreatment System Maintenance.....                         | 261        |
| Engine Maintenance Intervals.....                                      | 261        |
| <b>MAINTENANCE AND LUBRICATION.....</b>                                | <b>262</b> |
| MAINTENANCE INTRODUCTION .....   | 262        |
| TURBOCHARGER.....  | 263        |
| CLEANING YOUR VEHICLE.....   | 263        |
| Exterior Washing .....   | 264        |
| Cab and Hood .....   | 266        |
| Chassis .....  | 266        |
| Cab Interior .....   | 267        |
| Waxing .....   | 267        |
| Polishing .....  | 267        |
| Winter Warnings .....  | 267        |
| TOWING .....   | 268        |
| Towing with MACK Air (AL or MAXAIR® 40) Suspension (If Equipped) ..... | 270        |
| ENGINE OIL LEVEL CHECK.....  | 271        |
| Oil Change Intervals .....   | 272        |
| Engine Maintenance Intervals.....                                      | 273        |
| Power Steering Reservoir .....   | 274        |
| FUEL TANK.....   | 275        |
| Fuel Tank Cap.....   | 275        |
| FUELING .....  | 275        |
| B5 Approval For Mack US10 Certified Products .....                     | 277        |
| COOLING SYSTEM.....  | 278        |
| Coolant Level Check.....   | 279        |
| Draining the Cooling System.....                                       | 279        |



---

|  |            |
|--|------------|
| Refilling the Cooling System .....           | 279        |
| Protecting the Cooling System .....          | 280        |
| Cooling System Maintenance .....             | 282        |
| Accessory Drive Belt Routing .....           | 282        |
| <b>HEADLIGHTS</b> .....                      | <b>283</b> |
| Bulb Replacement .....                       | 283        |
| <b>WHEELS</b> .....                          | <b>286</b> |
| Wheel Inspection .....                       | 286        |
| Tires .....                                  | 287        |
| <b>BATTERY</b> .....                         | <b>289</b> |
| Jump-Starting Engine .....                   | 290        |
| <b>ELECTRICAL</b> .....                      | <b>292</b> |
| Circuit Breaker and Relay Panels .....       | 292        |
| Electrical Grease .....                      | 295        |
| Circuit Protection Charts .....              | 295        |
| Electrical Accessory Connection Points ..... | 298        |
| <b>METRIC CONVERSIONS</b> .....              | <b>300</b> |
| METRIC CONVERSIONS .....                     | 300        |

---

# Safety Information

**IMPORTANT:** Before driving this vehicle, be certain that you have read and that you fully understand each and every step of the driving and handling information in this manual. Be certain that you fully understand and follow all safety warnings.

IT IS IMPORTANT THAT THE FOLLOWING INFORMATION BE READ, UNDERSTOOD AND ALWAYS FOLLOWED.

The following types of advisories are used throughout this manual:

**DANGER**

Danger indicates an unsafe practice that could result in serious personal injury or death. A danger advisory banner is in **white** type on a **black** background with a **black** border.

**WARNING**

Warning indicates an unsafe practice that could result in personal injury. A warning advisory banner is in **black** type on a **gray** background with a **black** border.

**CAUTION**

Caution indicates an unsafe practice that could result in damage to the product. A caution advisory is in **black** type on a **white** background with a **black** border.

**Note:** Note indicates a procedure, practice, or condition that must be followed in order for the vehicle or component to function in the manner intended.

## CALIFORNIA PROPOSITION 65 WARNING

Diesel engine exhaust and some of its constituents are known to the State of California to cause cancer, birth defects and other reproductive harm.

## CALIFORNIA PROPOSITION 65 WARNING

Battery posts, terminals and other related accessories contain lead and lead compounds, chemical known to the State of California to cause cancer and other reproductive harm.

Batteries also contain other chemicals known to the State of California to cause cancer.

**Wash hands after handling.**

<https://www.truck-manuals.net/mack/>



---

## **TO THE OWNER**

### **In Appreciation**

Thank you for buying a MACK® vehicle. With proper care and maintenance, your new Mack® Pinnacle™ model will help you gain a competitive edge with its fuel-efficient drivetrain combinations, low maintenance, extended service intervals and, eventually, good resale value.

The Mack® Pinnacle™ model is available for a wide range of applications. Because of this versatility, drivetrains and components vary and operating instructions may differ from one model to another. While every effort has been made to cover all current arrangements, do not hesitate to consult your MACK distributor if a question arises. Honest, personal service is standard with every MACK sale.



#### **CAUTION**

Mack Trucks, Inc. would like to point out the important role that the driver plays in the life of the vehicle. Only trained and informed drivers should operate this vehicle.

We, at Mack Trucks, Inc., hope that you will be happy with your new Mack® Pinnacle™ model, and that you see many years of trouble-free driving.

This vehicle was built to conform to all federal standards and regulations applicable at the time of manufacture.

## 2 INTRODUCTION

---

### About This Handbook

This handbook is referred to as the Mack® Pinnacle™ Series Operator's Handbook. It covers all Mack® Pinnacle™ CHU models. Keep this handbook with the vehicle at all times to ensure that each owner and/or operator will have access to all pertinent information relating to the and handling of this vehicle.

This handbook was prepared to provide the driver with all relevant information concerning the daily use of this vehicle. Please read it thoroughly; pay particular attention to advisory labels that have been included to draw attention to important issues of operator safety and overall performance.

Information and illustrations in this handbook are based on the latest production usage at the time of printing and are subject to change without prior notice.

**Note:** Basic maintenance and lubrication procedures are found in this manual . For further information, refer to the Maintenance and Lubrication Manual. Other important information can be found in the Emission Control Systems for MACK Diesel Engine Manual.

---

## THE VEHICLE

### Basic Configuration

The Mack® Pinnacle™ model features a conventionally styled, aerodynamic cab.

### Vehicle Management and Control System (V-MAC®)

The Vehicle Management and Control System (V-MAC) is an electronic control system that manages engine and vehicle functions. In addition, the DataMax™ portion of V-MAC monitors and stores a variety of information (i.e., maintenance schedules, overspeed logs, fault tables, trip summaries).

For a complete description of the V-MAC IV system, refer to the applicable V-MAC® Operator's Guide, which is supplied with the vehicle.

Additional information concerning service, diagnostics, programming and vendor equipment interface application is available from the Mack Trucks, Inc. Service Publications Department. Contact your local MACK dealer for details.



#### **WARNING**

Never cut into the V-MAC system wire harness to power additional equipment. If such equipment is to be installed, contact your MACK dealer for assistance.

# 4 INTRODUCTION

## COMPONENT IDENTIFICATION

Locate the following serial numbers and write them in the boxes provided next to each illustration.

### VIN Locations

The Vehicle Identification Number (VIN) is displayed in two locations (a frame rail stamping and a label). The 17-digit VIN must be identical in both locations.

The **VIN frame stamping** is located on the bottom right frame rail flange and the top left rail flange. Note that the VIN location may vary if re-stamping of the frame becomes necessary.

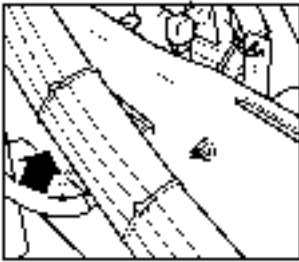

Bottom right frame rail flange

VEHICLE  
IDENTIFICATION  
NUMBER

C0028939



Top left rail flange

VEHICLE  
IDENTIFICATION  
NUMBER

C0028940

The **VIN label** is located on the inside door frame below the driver seat.



Vehicle  
Identification  
Number

C0028941

## Engine Identification

On the **MACK MP** engines, the engine serial number is stamped on the left side of the engine block, below the inlet manifold.

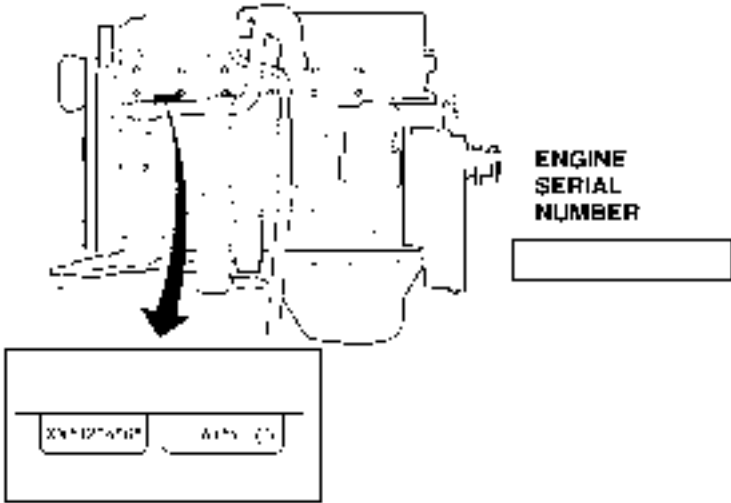

C0028943



# 6 INTRODUCTION

## Engine Information Plate

In compliance with Federal emission requirements, an engine information label is affixed to all Mack diesel engines. This label, which is located on the cylinder head cover at the front of the engine, gives basic engine identification information (engine

model, serial number, etc.), advertised horsepower at rated speed, inlet and exhaust valve lash setting. The Engine family "AVPTH12.8S01" can be used to identify the emission standard under which the engine was certified.

|  |                       |              |                |                 |                   |
|--|-----------------------|--------------|----------------|-----------------|-------------------|
| <b>Mack</b>  | ENGINE IDENTIFICATION |              | MACK MODEL NO. | MACK SERIAL NO. | MACK DISPLACEMENT |
|  | ENGINE FAMILY         | ENGINE MODEL |                |                 |                   |
|  | AVPTH12.8S01          | 12.8S01      | 12.8S01        | 123456          | 12.8L             |
| <p>DISPLACEMENT (LITERS) (CUBIC INCHES) (GALLONS) (CUBIC FEET)</p> <p>12.8L (781.0) (202.0)</p>      |                       |              |                |                 |                   |
| <p>VALVE LASH SETTING (INLET) (EXHAUST) (INLET) (EXHAUST)</p> <p>0.005" (0.127) (0.005" (0.127))</p> |                       |              |                |                 |                   |
| <p>ADVERTISED HORSEPOWER (KW) (HP) (CV) (CV) (CV)</p> <p>12.8 (9.2) (12.5) (17.0) (17.0)</p>         |                       |              |                |                 |                   |
| <p>EMissions INFORMATION (EPA APPROVED) (CALIFORNIA APPROVED)</p> <p>AVPTH12.8S01 (AVPTH12.8S01)</p> |                       |              |                |                 |                   |

W2040455

Engine Identification Label — 49 State EPA Approved Engine without California "Clean Idle"

|  |                       |              |                |                 |                   |
|--|-----------------------|--------------|----------------|-----------------|-------------------|
| <b>Mack</b>  | ENGINE IDENTIFICATION |              | MACK MODEL NO. | MACK SERIAL NO. | MACK DISPLACEMENT |
|  | ENGINE FAMILY         | ENGINE MODEL |                |                 |                   |
|  | AVPTH12.8S01          | 12.8S01      | 12.8S01        | 123456          | 12.8L             |
| <p>DISPLACEMENT (LITERS) (CUBIC INCHES) (GALLONS) (CUBIC FEET)</p> <p>12.8L (781.0) (202.0)</p>      |                       |              |                |                 |                   |
| <p>VALVE LASH SETTING (INLET) (EXHAUST) (INLET) (EXHAUST)</p> <p>0.005" (0.127) (0.005" (0.127))</p> |                       |              |                |                 |                   |
| <p>ADVERTISED HORSEPOWER (KW) (HP) (CV) (CV) (CV)</p> <p>12.8 (9.2) (12.5) (17.0) (17.0)</p>         |                       |              |                |                 |                   |
| <p>EMissions INFORMATION (EPA APPROVED) (CALIFORNIA APPROVED)</p> <p>AVPTH12.8S01 (AVPTH12.8S01)</p> |                       |              |                |                 |                   |

W2040456

Engine Identification Label — 50 State EPA Approved Engine with California "Clean Idle"



## CAUTION

To maintain compliance with emission regulations, engine settings should not be changed from those specified on the engine information label.

**Note:** Both the U.S. EPA and California Air Resources Board requires that each engine be identified with the proper engine

label as shown above. Should this engine label be defaced, destroyed, or removed from the valve cover, it must be replaced immediately. To order a replacement label, please contact Specifications or Parts Interpretations department at 1-800-888-9878, Option 2, who will assist you in obtaining the correct label for your engine.

## Clean Idle Engines

The California Air Resources Board (ARB) requires that 2008 and later model year vehicles be equipped with engines having tamper-resistant software which limits the time at which the engine can idle at speeds above low idle (550–700 rpm). At speeds above low idle, and without a PTO engaged, idle time will be limited to five minutes, after which the engine will revert back to low idle. Vehicles equipped with a Clean Idle engine are identified by a label which is affixed to the left front corner of the hood on conventional models (CHU).



W2056289

Clean Idle Engine Label

<https://www.truck-manuals.net/mack/>

## 8 INTRODUCTION

---

### Transmission Identification

The **MACK T300 Series transmission** serial number is located on the rear left side of the main case.

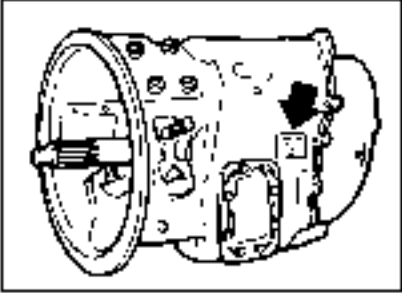

**MACK T300  
Transmission  
Serial Number**

C0028947

The **Allison RDS and HS transmission** identification plate is located on the rear right side of the main case, near the lower end.

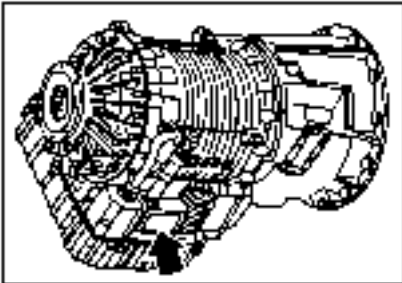

**Allison RDS and HS  
Transmission  
Serial Number**

C0028948

All **Eaton® Fuller® transmission** identification plates are located on the front left side of the main case.



**Eaton Fuller  
Transmission  
Serial Number**

C0028949

The **MACK carrier assembly** serial number is located on the front right side of the housing.

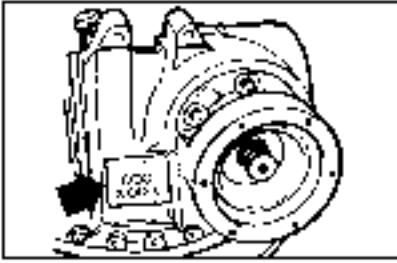

Carrier Assembly  
Serial Number

C0028950

The **Eaton® Spicer® rear axle** serial number is located on the rear of the axle housing toward the carrier.

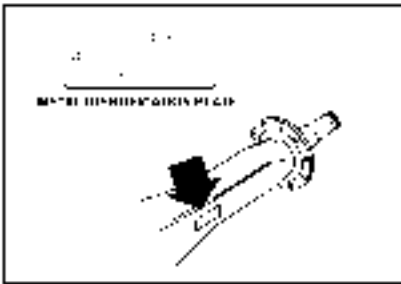

Rear Axle  
Serial Number

C0028951

The **Eaton® Spicer® carrier assembly** serial number is located on the left side of the forward carrier, and the top of the rear carrier.

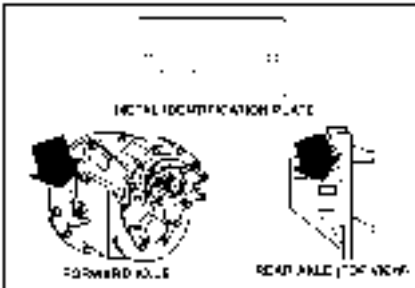

Carrier  
Serial Number

C0028952

The **MERITOR rear axle** identification tag is located on the left or right rear of the rear axle housing, next to the carrier.

# 10 INTRODUCTION

---

|                   |       |
|-------------------|-------|
| Model No.         |       |
| Customer No. .... |       |
| Serial No.        | Plant |
| Date              | Date  |

**IDENTIFICATION TAG**

**Rear Axle  
Serial Number**



C0028953

The **MERITOR carrier assembly** serial number is located on the left side of the forward carrier, and the top of the rear carrier.

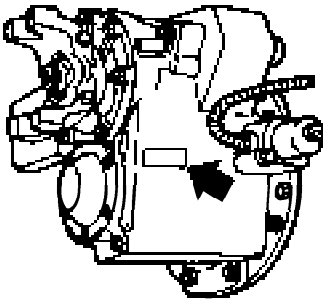

**Carrier  
Serial Number**

C0028954

---

## WARRANTY INFORMATION

This chassis is equipped with a US 2010 emission compliant engine with an engine exhaust aftertreatment system (Diesel Particulate Filter) and selective catalytic reduction (SCR) system. Use of Ultra Low Sulfur Diesel (ULSD) fuel and EO-O Premium Plus (or VDS-4) specification high performance diesel engine oil is required in this vehicle.

**Note:** Use of improper or unapproved fuel or engine oil will void the engine and aftertreatment system warranty.

### Air Brake System

The MACK Standard Vehicle Warranty applies to the air brake system, as set forth in the Warranty, but only if the air brake system has not been subjected to unauthorized additions, deletions or modifications. If any such unauthorized additions, deletions or modifications are performed, Mack Trucks, Inc. disclaims any and all liability for any loss or damage arising out of a malfunction of the air brake system.

The air brake system was designed and built to conform to all applicable federal motor vehicle safety standards in effect at the time of manufacture.

Tractor air systems are designed for as a tractor only, and truck air systems are designed to be operated as a truck only. If a tractor is going to be converted for as a truck, the air brake system must be reconfigured to that of a truck. Conversely, if a truck is going to be converted for as a tractor, the air brake system must be reconfigured to that of a tractor. Consult your local MACK distributor for additional information.

If any unauthorized additions, deletions or modifications are made to any portion of the air brake system which is required by Federal Motor Vehicle Safety Standards, Mack Trucks, Inc. makes no representation as to conformity with the Standards.

For complete warranty information, refer to the *Pedigreed Protection Plan* provided with each vehicle.

# 12 INTRODUCTION

---

## ENGINE GASEOUS EMISSION CONTROL SYSTEMS

### WARRANTY MAINTENANCE

**Note:** For emission control systems information on engines other than MACK, refer to the engine vendor's publication

### ENGINE GASEOUS EMISSION CONTROL SYSTEMS WARRANTY

Mack Trucks, Inc. warrants the Emission Control Systems on each new Mack diesel engine in a new Mack Truck to comply with all United States Federal and Canadian emissions regulations applicable at the time of manufacture of the engine, and to be free from defects in material and workmanship under normal use and service up to 60 months, or 160934 km (100,000 miles), whichever occurs first, provided that all Mack Trucks, Inc. maintenance requirements are followed as described in this manual. All warranty periods are calculated from the date-in-service of the new vehicle.

The repair or replacement of defective parts will be made without charge for the cost of parts and if repairs are made at an authorized Mack Trucks, Inc. dealership, there will be no charge for labor. Mack Trucks, Inc.'s obligation under this warranty is limited to the repair or replacement, at Mack Trucks, Inc.'s option, of any part(s) of the Emission Control Systems of such engine and/or vehicle found to be defective upon examination by Mack Trucks, Inc. and provided that such part(s) were returned to Mack Trucks, Inc. or its nearest authorized Dealer within a reasonable period of time.

### *Qualifications and Limitations:*

**Note: Not covered** by the Emissions Control Systems Warranty:

- Malfunctions caused by misuse, improper adjustments, modification, alteration, tampering, disconnection, improper or inadequate maintenance and use of improper diesel fuel or DEF.
- Damage resulting from accident, acts of nature or other events beyond the control of Mack Trucks, Inc.
- Inconvenience, loss of use of the vehicle, commercial loss of any kind including, but not limited to, consequential or incidental damages
- Any vehicle in which the odometer has been altered or damaged so that mileage cannot be readily determined.

**THIS WARRANTY IS EXPRESSLY IN LIEU OF ALL OTHER WARRANTIES AND REPRESENTATIONS OR CONDITIONS, STATUTORY OR OTHERWISE, EXPRESSED OR IMPLIED INCLUDING, BUT NOT LIMITED TO, IMPLIED WARRANTY OF MERCHANTABILITY OR FITNESS FOR A PARTICULAR PURPOSE.**

<https://www.truck-manuals.net/mack/>

## Emissions Control System Warranty

The following engine components are covered by the supplemental emissions control system warranty policy as required by the Federal code of emission regulations.

- 1 Turbocharger Assembly
  - VGT Actuator
- 2 Charge Air Cooler
  - CAC Pipes (Air inlet to/from CAC)
  - CAC Hoses
- 3 Engine Control Module (ECM)
- 4 Injectors
- 5 Engine and Vehicle Wire harness ( repair to circuits related to Emissions Warrantable Components )
- 6 Exhaust Gas Recirculation (EGR) Mixer
- 7 EGR Cooler
- 8 EGR Valve and EGR Valve Control
- 9 EGR Pipes - Engine Exhaust Manifold to EGR Cooler
- 10 EGR Pipes - EGR Cooler to Inlet Manifold
- 11 Crankcase Breather
- 12 Crankcase Separator
- 13 Crankcase Tubing and Hoses before Separator
- 14 Aftertreatment Wiring Harness
- 15 After treatment Control Module (ACM)
- 16 Aftertreatment Diesel Particulate Filter (DPF) Assembly
  - A. Aftertreatment DPF Assembly with Aftertreatment Diesel Oxidation Catalyst (DOC)
    - Aftertreatment Doser
    - Diffuser Pipe (Aftertreatment Fuel Doser Mounting)
    - Fuel lines to Aftertreatment Fuel Doser
    - Aftertreatment Fuel Shutoff Valve
  - B. Thermal Regeneration Unit (TRU)
    - Aftertreatment DPF Intake Temperature Sensor
    - Discharge Recirculation Valve (DRV) (Heat Mode)
    - Discharge Recirculation Valve (DRV) Solenoid
    - Engine Turbocharger Compressor Bypass Actuator (Heat Mode)
    - Engine Turbocharger Compressor Bypass Actuator Solenoid
    - Engine Exhaust Gas Temperature (EGT) Sensor
    - Aftertreatment DPF Intake Temperature Sensor
    - Aftertreatment DPF Outlet Temperature Sensor
    - Aftertreatment DPF Differential Pressure Sensor
    - Aftertreatment Doser Air Supply Regulator (if applicable), Supply Lines, and Fittings



## 14 INTRODUCTION

---

- Aftertreatment DPF Outlet Temperature Sensor
- Aftertreatment DPF Spark Assist Flame Temperature Sensor
- Aftertreatment DPF Differential Pressure Sensor

### 17 Sensors:

- Crankshaft Position (CKP)
- Camshaft Position (CMP)
- Engine Coolant Temperature (ECT)
- Intake Manifold Air Temperature
- Intake Manifold Pressure (IMP)
- EGR Temperature
- Aftertreatment Outlet NO<sub>x</sub>
- Aftertreatment Intake NO<sub>x</sub>
- EGR Differential Pressure
- Ambient Air Temperature (AAT)

### 18 SCR

- Aftertreatment Selective Catalytic Reduction (SCR) Catalyst
- Aftertreatment Diesel Exhaust Fluid (DEF) Pump
  - Aftertreatment DEF Dosing Absolute Pressure Sensor

- Aftertreatment DEF Return Valve
- Aftertreatment DEF Dosing Valve
- Aftertreatment DEF Tank
- Aftertreatment DEF Tank Heater/Sender
- Aftertreatment DEF Tank Heater
- Aftertreatment DEF Tank Heater Valve
- Aftertreatment DEF Tank Temperature Sensor
- Aftertreatment DEF Level Sensor
- Aftertreatment DEF Heated Lines

19. Instrument Cluster (Repair of microprocessor , OBD MIL, Real Time Clock, Aftertreatment DEF Tank Gauge and, Aftertreatment DEF Tank Low Level Indicator)

20. Exhaust Gas Piping (from Turbocharger to Aftertreatment System )

21. Data Link Connector (DLC)

---

## ENGINE GASEOUS EMISSIONS CONTROL SYSTEM WARRANTY

The emission warranty for the diesel particulate filter (DPF) and SCR System covers defects in workmanship only. Normal maintenance, such as cleaning ash from the filter at regular maintenance intervals and cleaning the aftertreatment fuel injector on Diesel oxidation catalyst (DOC) DPF systems, is not covered by the emission warranty. With the Thermal regenerator DPF system, cleaning the ignition electrodes and fuel injection nozzle at the regular maintenance intervals

is considered normal maintenance and not covered by the emission warranty.

**Note:** In response to customer requests, Mack Trucks, Inc. may build vehicles with engines supplied by other manufacturers. In these cases, each engine manufacturer through its service organization, is responsible for emission control systems warranty on all parts of the engine assembly, as furnished.

# 16 INTRODUCTION

---

## FEDERAL EMISSION REQUIREMENTS

This section covers the requirement of the United States Clean Air Act which states: "The manufacturer shall furnish with each new motor vehicle or motor vehicle engine such written instructions for the maintenance and use of the vehicle or engine by the ultimate purchaser as may

be reasonable and necessary to assure the proper functioning of emission control devices and systems. "This section also covers the requirements of the emissions regulations promulgated under the Motor Vehicle Safety Act in Canada.

### TAMPERING WITH GASEOUS EMISSION CONTROL SYSTEMS PROHIBITED

The Federal Clean Air Act prohibits the removal or rendering inoperative of any device or element of design installed on or in a motor vehicle or motor vehicle engine in compliance with Federal Emission Regulations by:

- 1 Any person prior to its sale and delivery to the ultimate purchaser, or
- 2 Any manufacturer or distributor after its sale and delivery to the ultimate purchaser, or
- 3 Any person engaged in the business of repairing, servicing, selling, leasing, or

trading motor vehicles or motor vehicle engines following its sale and delivery to the ultimate purchaser, or

- 4 Any person who operates a fleet of motor vehicles following its sale and delivery to the ultimate purchaser.

**Note:** For specifics of the prohibited vehicle/engine modifications refer to the Mack Trucks, Inc. Body Builders documentation .

## EMISSION CONTROL SYSTEMS WARRANTY — CALIFORNIA

The California Air Resources Board and Mack Trucks, Inc. are pleased to explain the California emission control system warranty on your new motor vehicle engine. In California, new motor vehicle engines must be designed, built and equipped to meet the State's stringent anti-smog standards. Mack Trucks, Inc. must warrant the emission control system on your engine for the period of time listed below provided there has been no abuse, neglect, or improper maintenance of your engine.

Your emission control system may include parts such as the fuel-injection

system, turbocharger assembly, electronic control module and other emission-related assemblies.

Where a warrantable condition exists, Mack Trucks, Inc. will repair your engine at no cost to you including diagnosis, parts, and labor.

### MANUFACTURER'S WARRANTY COVERAGE:

If an emission-related part of your engine is defective, the part will be repaired or replaced by Mack Trucks, Inc. This is your emission control system DEFECTS WARRANTY.

## OWNER'S WARRANTY RESPONSIBILITIES:

As the motor vehicle engine owner, you are responsible for the performance of the required maintenance listed in this manual. Mack Trucks, Inc. recommends that you retain all receipts covering maintenance of your vehicle, but Mack Trucks, Inc. cannot deny warranty solely for the lack of receipts or for your failure to ensure the performance of all scheduled maintenance listed in other manuals which were supplied with your vehicle.

You are responsible for presenting your motor vehicle engine to a MACK dealer as soon as a problem exists. The warranty repairs should be completed in a reasonable amount of time, not to exceed 30 days. As the motor vehicle engine owner, you should also be aware that Mack Trucks, Inc. may deny you warranty coverage if your vehicle or a part has failed due to abuse, neglect, improper maintenance, or unapproved modifications.

If you have any questions regarding your warranty rights and responsibilities, you should contact the Mack Trucks, Inc. Warranty Activities P.O.Box 26259, Greensboro, NC 27402, or the California Air Resources Board at 9480 Telstar Avenue, El Monte, California 91731. **(Applicable only to vehicles and/or engines certified for sale and registered**

**in the State of California)** Mack Trucks, Inc. warrants the Emission Control Systems on each new MACK diesel engine in a new MACK truck to comply with all State of California emissions regulations applicable at the time of manufacture of the engine, and to be free from defects in material and workmanship under normal use and service up to 60 months, or 100,000 miles, or 3,000 engine operating hours, whichever occurs first, provided that all Mack Trucks, Inc. maintenance requirements are followed as described in this manual. All warranty periods are calculated from the date-in-service of the new vehicle. The repair or replacement of defective parts will be made without charge for the cost of parts and, if repairs are made at an authorized Mack Trucks, Inc. dealership, there will be no charge for labor.

Mack Trucks, Inc.'s obligation under this warranty is limited to the repair or replacement, at Mack Trucks, Inc.'s option, of any part(s) of Emission Control Systems of such engine and/or vehicle found to be defective upon examination by Mack Trucks, Inc. and provided that such part(s) were returned to Mack Trucks, Inc. or its nearest authorized Dealer within a reasonable period of time.

## *Qualifications and Limitations:*

**Not covered** by the Emissions Control Systems Warranty:

- Malfunctions caused by misuse, improper adjustments, modification, alteration, tampering, disconnection, improper or inadequate maintenance and use of improper diesel fuel or DEF.
- Damage resulting from accident, acts of nature or other events beyond the control of Mack Trucks, Inc.
- Inconvenience, loss of use of the vehicle, commercial loss of any kind including, but not limited to, consequential or incidental damages.
- Any vehicle in which the odometer has been altered or damaged so that mileage cannot be readily determined.

# 18 INTRODUCTION

---

**THIS WARRANTY IS EXPRESSLY IN LIEU OF ALL OTHER WARRANTIES AND REPRESENTATIONS OR CONDITIONS, STATUTORY OR OTHERWISE, EXPRESSED OR IMPLIED INCLUDING, BUT NOT LIMITED TO, IMPLIED WARRANTY OF MERCHANTABILITY OR FITNESS FOR A PARTICULAR PURPOSE.**

## Emissions Control System Warranty

The following engine components are covered by the supplemental emissions control system warranty policy as required by the California code of regulations.

- 1 Turbocharger Assembly
  - VGT Actuator
- 2 Charge Air Cooler
  - CAC Pipes (Air inlet to/from CAC)
  - CAC Hoses
- 3 Engine Control Module (ECM)
- 4 Injectors
- 5 Engine and Vehicle Wire harness ( repair to circuits related to Emissions Warrantable Components )
- 6 Exhaust Gas Recirculation (EGR) Mixer
- 7 EGR Cooler
- 8 EGR Valve and EGR Valve Control
- 9 EGR Pipes - Engine Exhaust Manifold to EGR Cooler
- 10 EGR Pipes - EGR Cooler to Inlet Manifold
- 11 Crankcase Breather
- 12 Crankcase Separator
- 13 Crankcase Tubing and Hoses before Separator
- 14 Aftertreatment Wiring Harness
- 15 After treatment Control Module (ACM)
- 16 Aftertreatment Diesel Particulate Filter (DPF) Assembly
  - A. Aftertreatment DPF Assembly with Aftertreatment Diesel Oxidation Catalyst (DOC)
  - Aftertreatment Doser
  - Diffuser Pipe (Aftertreatment Fuel Doser Mounting)
  - Fuel lines to Aftertreatment Fuel Doser
  - Aftertreatment Fuel Shutoff Valve
  - Aftertreatment Fuel Pressure Sensor
  - Engine Turbocharger Compressor Bypass Actuator (Heat Mode)
  - Engine Turbocharger Compressor Bypass Actuator Solenoid
  - Engine Exhaust Gas Temperature (EGT) Sensor
  - Aftertreatment DPF Intake Temperature Sensor
  - Aftertreatment DPF Outlet Temperature Sensor
  - Aftertreatment DPF Differential Pressure Sensor
  - Aftertreatment Doser Air Supply Regulator (if applicable), Supply Lines, and Fittings
- B. Thermal Regeneration Unit (TRU)
  - Aftertreatment DPF Air Shutoff Valve
  - Aftertreatment DPF Combustion Air Valve
  - Aftertreatment DPF Atomization Module
  - Aftertreatment DPF Injection Coil

- Aftertreatment DPF Fuel Control Valve
- Aftertreatment DPF Ignition Electrode
- Nozzle
- Engine Exhaust Gas Temperature (EGT) Sensor
- Aftertreatment DPF Intake Temperature Sensor
- Aftertreatment DPF Outlet Temperature Sensor
- Aftertreatment DPF Spark Assist Flame Temperature Sensor
- Aftertreatment DPF Differential Pressure Sensor
- Aftertreatment Selective Catalytic Reduction (SCR) Catalyst
- Aftertreatment Diesel Exhaust Fluid (DEF) Pump
  - Aftertreatment DEF Dosing Absolute Pressure Sensor
  - Aftertreatment DEF Return Valve

## 17 Sensors:

- Crankshaft Position (CKP)
- Camshaft Position (CMP)
- Engine Coolant Temperature (ECT)
- Intake Manifold Air Temperature
- Intake Manifold Pressure (IMP)
- EGR Temperature
- Aftertreatment Outlet NOx
- Aftertreatment Intake NOx
- EGR Differential Pressure
- Ambient Air Temperature (AAT)

## 18 SCR

- Aftertreatment DEF Dosing Valve
- Aftertreatment DEF Tank
- Aftertreatment DEF Tank Heater/Sender
- Aftertreatment DEF Tank Heater
- Aftertreatment DEF Tank Heater Valve
- Aftertreatment DEF Tank Temperature Sensor
- Aftertreatment DEF Level Sensor
- Aftertreatment DEF Heated Lines

19. Instrument Cluster (Repair of microprocessor , OBD MIL, Real Time Clock, Aftertreatment DEF Tank Gauge and, Aftertreatment DEF Tank Low Level Indicator)

20. Exhaust Gas Piping (from Turbocharger to Aftertreatment System )

21. Data Link Connector (DLC)

## 20 INTRODUCTION

### ENGINE GASEOUS EMISSION CONTROL SYSTEMS WARRANTY — *Continued*

The emission warranty for the diesel particulate filter (DPF) and SCR System covers defects in workmanship only. Normal maintenance, such as cleaning ash from the filter at regular maintenance intervals and cleaning the aftertreatment fuel injector on Diesel oxidation catalyst (DOC) DPF systems, is not covered by the emission warranty. With the Thermal regenerator DPF system, cleaning the ignition electrodes and fuel injection nozzle at the regular maintenance intervals is considered normal maintenance and not covered by the emission warranty.

**Note:** In response to customer requests, Mack Trucks, Inc. may build vehicles with engines supplied by other manufacturers. In these cases, each engine manufacturer through its service organization, is responsible for emission control systems warranty on all parts of the engine assembly, as furnished.



#### CAUTION

Any unauthorized adjustments to the emission control components can cause severe damage to the engine.



#### CAUTION

In the event that damage results from unauthorized adjustments to any emission control system components, as evidenced by settings other than as specified, or broken fastener seals, the cost of repairing such damage WILL NOT BE COVERED under warranty

#### 1. Repairs by MACK Dealers, Sub-Dealers and Service Dealers

Repairs covered by the California Emission Control Systems Warranty will be performed by any authorized MACK repair facility at his place of business with no charge for parts and labor (including diagnosis), using MACK parts for any part of the emission control systems covered by this warranty and found defective.

#### 2. In an Emergency

**In an emergency**, where an authorized MACK facility is not available, repairs may be performed at any available service

establishment, or by the owner, using any replacement part, within the limitations of paragraphs 3 and 4 in this section. An emergency condition exists under this section if, after 30 days, repairs have not been completed or parts are not yet available. MACK will reimburse the owner for such repairs that are covered under this warranty, including diagnosis, not to exceed MACK's suggested retail price for parts replaced and labor charges based on MACK's recommended time allowance and geographically appropriate hourly labor rate. Replaced parts and paid invoices must be presented at a MACK facility as a condition of reimbursement for emergency repairs performed elsewhere.

#### 3. Repairs by Non-MACK Facilities

Owners may elect to have maintenance, replacement, or repair of emission control systems performed by any repair facility, and may elect to use parts other than MACK parts without invalidating the warranty on other components, but the cost of such service or parts will not be covered by MACK under its warranty.

#### 4. Use of Non-MACK Parts

Use of replacement parts which are not the equivalent of MACK parts may impair the effectiveness of emission control systems.

If other than MACK parts are used, the

owner should obtain assurances that such parts are warranted by their manufacturer to be the equivalent of MACK parts in performance and durability. MACK assumes no liability under this warranty with respect to parts other than MACK parts; however, the use of non-MACK parts does not invalidate the warranty on other components unless non-MACK parts cause damage to warranted parts.

## **5. Maintenance and Maintenance Records**

The vehicle owner is responsible for the performance of all required maintenance specified in this manual. MACK will not deny a warranty claim solely because there is no record of maintenance; however, MACK may deny a warranty claim if failure to perform required maintenance results in the failure of a warranted part. Receipts or other records covering the performance of scheduled maintenance should be retained to answer questions that may arise concerning maintenance. Maintenance records should be transferred to subsequent owners if the vehicle is sold.

## **6. Items Not Covered by the Emission Control Systems Warranty**

- Malfunctions caused by misuse, improper adjustments, modification, alteration, tampering, disconnection, improper or inadequate maintenance and use of improper diesel fuel.

- Damage resulting from accident, acts of nature or other events beyond the control of Mack Trucks, Inc.
- Inconvenience, loss of use of the vehicle, commercial loss of any kind including, but not limited to, consequential or incidental damages.
- Any vehicle in which the odometer has been altered or damaged so that mileage cannot be readily determined.

## **7. Customer Assistance**

MACK wishes to assure that the California Emission Control Systems Warranty is properly administered. In the event that owners do not receive the warranty service to which they believe they are entitled under the California Emission Control Systems Warranty, they should contact the nearest MACK Regional Office for assistance. The address and telephone number for each Regional Office are in the MACK Directory of Sales, Parts and Service Centers. Owners in need of additional assistance or information concerning the California Emission Control Systems Warranty may also contact:

Mack Trucks, Inc.

Warranty Activities

P.O. Box 26259

Greensboro, NC 27402



## 22 INTRODUCTION

---

### SERVICE LITERATURE

The MACK Service Publications department offers a variety of service literature (including individual service manuals) that can be ordered through any MACK dealer or on the Mack Trucks, Inc. website at [www.macktrucks.com](http://www.macktrucks.com).

**Note:** Mack Trucks, Inc. would like to emphasize the importance of proper service and maintenance procedures. Service, repair and replacements must be performed by certified, licensed mechanics in accordance with MACK standards.

### MACK Class 8 –Components Service Manual

This multi-binder set contains service information covering all MACK components (i.e., engines, transmissions, front and rear axles, cabs, fuel systems, electrical systems).

**Note:** If your vehicle contains a number of non-MACK (vendor) components, the *Class 8 – Custom Collated Service Manual* might be more appropriate.

### Class 8 – Custom Collated Service Manual on CD

This tailor-made set provides complete service information for all components in the specified vehicle (including both MACK and vendor service manuals). When ordering a *Class 8 – Custom Collated Service Manual* or *Class 8 – Custom Collated Service Manual on CD*, be sure to include the complete Model-Serial number and General Sales Order (GSO) number.

---

## **CUSTOMER SERVICE**

### **Call 1-800-866-1177 for MACK One-Call™**

The One-Call customer support system is a toll-free nationwide hotline that operates 24 hours a day, seven days a week, including holidays. If you break down on the road, simply call 1-800-866-1177. There is a staff of trained, experienced technicians ready to help. They can help troubleshoot a problem to get you back on the road, arrange to send roadside assistance or arrange for towing to the nearest MACK dealership.

One-Call provides personalized service. The person who initially takes your call will be the same person who sees that your situation is resolved quickly and to your satisfaction. If a follow-up call is necessary, the same familiar voice will be on the other end of the line.

One-Call technicians can also help you plan ahead to keep your running efficiently by scheduling routine maintenance and lubrication service, or by locating the nearest MACK dealership.

### **Questions and Complaints**

Your satisfaction is our most important concern.

If questions or complaints arise, first discuss the matter with the service manager at the MACK facility involved. If you are not satisfied with the service manager's response, contact the branch manager, principal or general manager of the distributorship. If assistance is required at a service dealer, contact the owner of the establishment.

If, for any reason, you need further assistance after dealing with the personnel at a MACK subsidiary or distributor, contact the regional service manager at the nearest MACK regional service office. The regional service manager has the responsibility and the authority to recommend action in most cases and (with the aid of relevant district service personnel) will make every effort to conduct a fair review of the situation.

# 24 INTRODUCTION

---

## Addresses

The addresses, telephone and fax numbers of the Mack Trucks, Inc. regional offices are:

### *United States*

**Northeast Region** – 7900 National Service Road, Mail: P.O. Box 26259, Greensboro NC 27402 , TEL: (336) 291-9001

**Southeast Region** – 6768 Southlake Parkway, Morrow, GA 30260, TEL: (770) 960-0511, FAX: (770) 960-0593

**Central Region** –900 S. Frontage Rd., Suite 100, Woodridge, IL 60517, TEL: (630) 910-3330, FAX: (630) 910-3331

**Southwestern and Western Regions** – 5605 N. MacArthur Blvd., #550, Mail: P.O. Box 165408, Irving, TX 75016-5408, TEL: (972) 518-1614, FAX: (972) 550-0389

### *Canada*

**Executive Office** – Mack Canada, Inc., 5600A Cancross Court, Mississauga, ON L5R 3E9, TEL: (905) 366-3400, FAX: (905) 366-0165

### *Australia*

Mack Trucks Australia Pty. Ltd., CNR Archerfield and Boundary Roads, Mail: P.O. Box 364, Richlands, QLD 4077, Australia, TEL: 61-7-3853-3333, FAX: 61-7-3853-3392

### *International*

7900 National Service Road, Mail: P.O. Box 26259, Greensboro NC 27402 , TEL: (336) 291-9001

## Additional Assistance

If additional assistance is required, Mack Trucks, Inc. maintains a Customer Service Department (staffed by experienced personnel) to aid customers who need information or assistance not provided at the local or regional level.

The Customer Service Department phone number is **(610) 709-3961**.

When contacting the regional service offices or Customer Service Department, provide the following information:

- Vehicle Identification Number (VIN) — This 17-digit number is typically located on a label on the driver-side door latch post and behind the front axle on the right, front frame rail.
- Model and year of the vehicle
- Date that the vehicle was purchased and put into service
- Date(s) and mileage of repair(s)
- Dealer that sold and/or serviced the vehicle
- Description of unresolved service complaint or inquiry
- Summary of action taken to date (by the dealer and the regional service office)
- Names of individuals (if known) contacted at the dealer and the Mack Trucks, Inc. regional service office.

## 26 INTRODUCTION

---

### REPORTING SAFETY DEFECTS

#### United States

If you believe that your vehicle has a defect which could cause a crash, injury or death, you should immediately inform the National Highway Traffic Safety Administration (NHTSA), in addition to notifying Mack Trucks, Inc.

If NHTSA receives similar complaints, it may open an investigation and if it finds that a safety defect exists in a group of vehicles, it may order a recall and remedy campaign. However, NHTSA cannot become involved in individual problems between you, your distributor, or Mack Trucks, Inc.

To contact NHTSA, either call the U.S. Government's Vehicle Safety Hotline toll-free at 1-888-327-4236 (TTY: 1-800-424-9153); go to <http://www.NHTSA.gov>; or write to: Administrator, National Highway Traffic Safety Administration, 400 Seventh Street, S.W., Washington, DC 20590. You can also obtain other information about motor vehicle safety from the Vehicle Safety Hotline.

#### Canada

Canadian customers who wish to report a safety-related defect to Transport Canada — Defect Investigations and Recalls, may telephone the toll free hotline at 1-800-333-0510, or contact Transport Canada by mail at Transport Canada, ASFAD, Place de Ville Tower C, 330 Sparks Street, Ottawa ON K1A 0N5. For additional road safety information, please visit the Road Safety website at <http://www.tc.gc.ca/roadsafety/menu.htm>.

#### Mexico

Mack Trucks de Mexico, S.A. de C.V. should be informed immediately if you believe the vehicle has a defect that could cause a vehicle accident, injury or death. Contact Mack Trucks de Mexico by calling 011-52-55-50-81-68-50 or by writing to: Mack Trucks de Mexico, S.A. de C.V., Prol. Paseo de la Reforma 600, 1er. Piso — 121, Col. Santa Fe Pena Blanca, C.P. 01210, Mexico, D.F. Within Mexico, call 01 (800) 90 94 900.

---

## **EVENT DATA RECORDING DEVICES**

Your MACK vehicle is equipped with a device generally referred to as an "event data recorder" or "EDR." Please note that while the term "event data recorder" is typically used throughout the motor vehicle industry, not every EDR is the same; i.e., they do not all record the same data elements. The EDR on your MACK vehicle records vehicle speed, engine rpm, time and date, plus a variety of pedal and switch positions, both before and after an "event." Sudden vehicle deceleration or the occurrence of certain other vehicle characteristics will define (trigger) an "event."

Optional equipment available for your MACK vehicle, such as the Eaton® VORAD® Collision Warning System, may also provide event data recording features.

If you have a question about your EDR, please contact your MACK dealer or regional service office.

## 28 SAFETY INFORMATION

---

### SAFETY STATEMENT

Mack Trucks, Inc. cannot anticipate every possible occurrence which may involve a potential hazard. An accident can be avoided by recognizing potentially hazardous situations before a dangerous situation occurs. Correctly performed service procedures are critical for technician safety and safe, reliable of the vehicle.



#### DANGER

Do not operate the engine in an enclosed area. All internal combustion engines give off various fumes and gases while running. Inhalation of exhaust fumes can cause death.



#### DANGER

Do not sit in a parked vehicle for any extended amount of time with the engine running if there are leaks in the exhaust system. Exhaust fumes could leak into the cab area and death can result. On a regular basis inspect the exhaust system for leaks and repair any leakage.



#### DANGER

Driver attitude is the most important part of any effective vehicle safety system. Mack Trucks, Inc. strongly encourages all drivers and passengers to use their seat belts, drive defensively, remain alert and respect the speed limits. Many accidents can also be avoided through regular vehicle maintenance.



#### DANGER

Engine-driven components such as Power Take-Off (PTO) units, fans and fan belts, driveshafts and other related rotating assemblies, can be very dangerous. Do not service engine-driven components unless the engine is shut down. Always keep body parts and loose clothing out of range of these powerful components to prevent serious personal injury. Be aware of PTO engagement or nonengagement status. Always disengage the PTO when not in use.



## WARNING

Certain everyday procedures such as washing the vehicle and cleaning the windshield can also be hazardous because of the vehicle's height. Mack Trucks, Inc. does NOT recommend climbing up on the vehicle to perform these. Instead, stand on the ground and use brushes and squeegees mounted on extension poles. When better access is necessary (for instance, when washing the cab roof), use sturdy ladders held in place by someone on the ground.



## WARNING

Secure loose objects. Loose objects in the cab or sleeper can be dangerous in a sudden stop or on bad roads. Secure any appliance added to the vehicle, such as a refrigerator or a radio.



## WARNING

Keep clear of fan when engine is running. Fan may start to rotate at high speed without warning.



# 30 SAFETY INFORMATION

## CERTIFICATION LABELS

### Safety Certification Label

National Highway Traffic Safety Administration (NHTSA) regulations require affixing a certification label to all vehicles.

NHTSA regulations also require that the certification label be affixed to either the hinge pillar, door latch post or the door edge that meets the door latch post next to the driver seat. If none of these locations are practical, it may be attached to the left side of the instrument panel or to an inward facing surface of the driver-side door.

In compliance with NHTSA regulations, your Mack® vehicle has a safety certification label affixed in one of the NHTSA locations listed above. This label may be either an Incomplete Vehicle and/or Completed Vehicle label. Both labels are described below.

#### *Incomplete Vehicles*

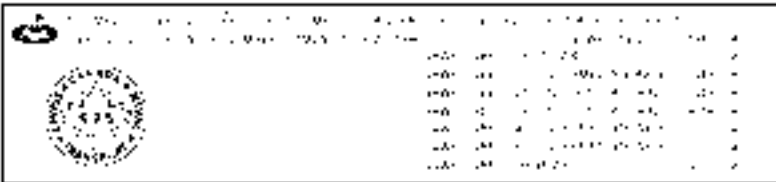
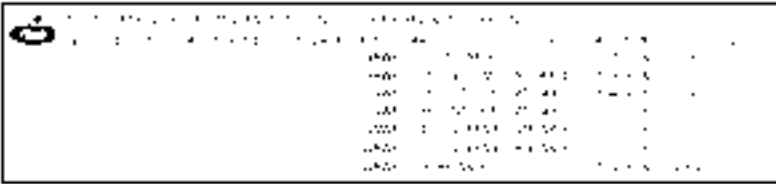

C0028955

A chassis-cab is an incomplete vehicle with a completed occupant compartment that requires the addition of cargo-carrying, work-performing or load-bearing components to perform its intended functions.

The chassis-cab manufacturer must affix a label to the incomplete vehicle in one of the NHTSA locations listed above. This label provides the chassis-cab date of manufacture, VIN and vehicle certification information.

## **Completed Vehicles**

In addition to the label supplied by Mack Trucks, Inc. as the chassis-cab manufacturer, a Completed Vehicle certification label, supplied by the body manufacturer, is affixed in the same general location. This label provides information pertaining to Gross Vehicle Weight Rating (GVWR), Gross Axle Weight Rating (GAWR), tire and rim information, etc.

On **MACK-completed vehicles**, this label contains the date of manufacture, VIN, GVWR, GAWR, and tire and rim data. It is found in one of the NHTSA locations listed above.

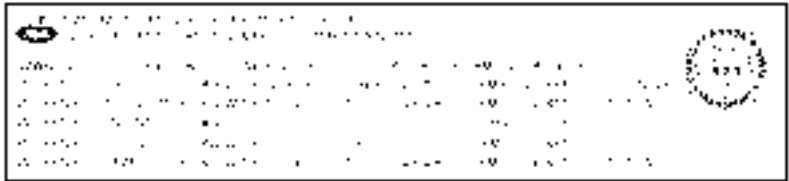
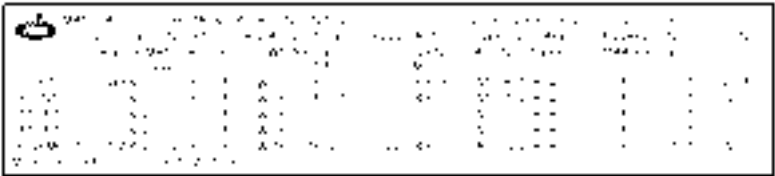

C0028956

# 32 SAFETY INFORMATION

## ADVISORY LABELS

Throughout this book you will find paragraphs labeled *Danger, Warning, Caution, Note and Service Hint*. *Danger, Caution and Warning* labels are also found in various locations on the vehicle to alert drivers, operators and service technicians to situations which can cause personal injury or equipment damage. The labels shown are applicable to the Mack® Pinnacle™ model chassis at the time of publication and are representative of what can be typically found on a Mack® Pinnacle™. (Your vehicle may not contain all of the labels illustrated in this handbook.) These labels are for your benefit. Please look through this section and note the labels, their locations and what they explain. Be sure to replace any label that is damaged.

## Advisory Label Locations (On Vehicle)

### Labels Found on Chassis

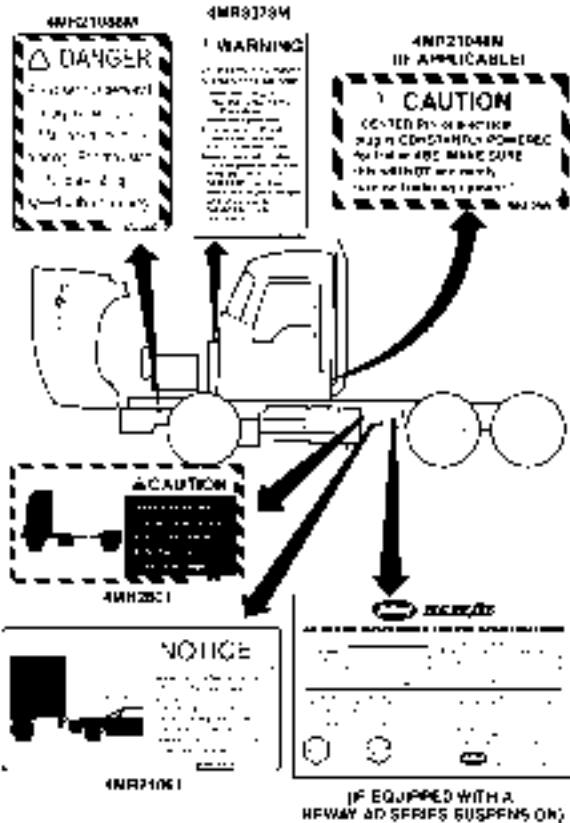

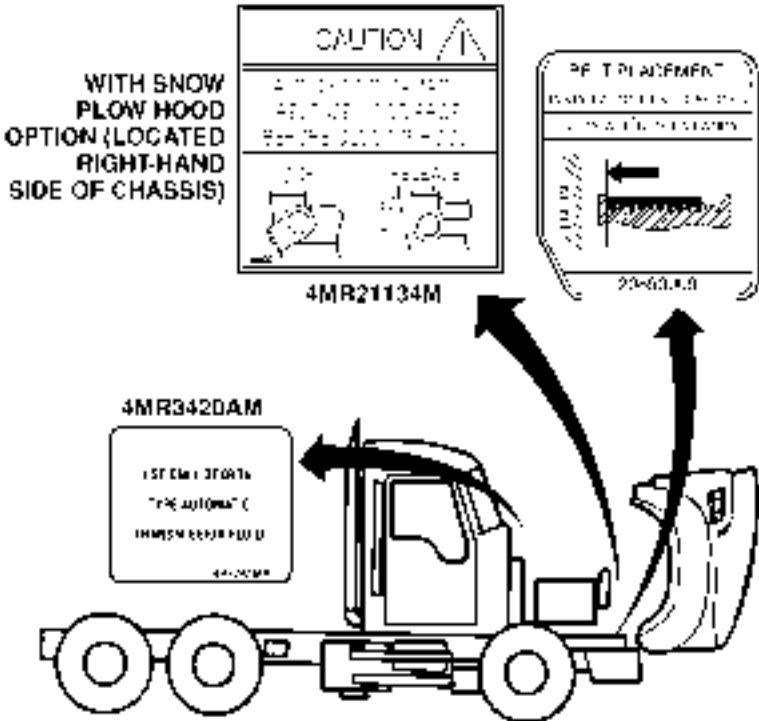

C0028958

# 34 SAFETY INFORMATION

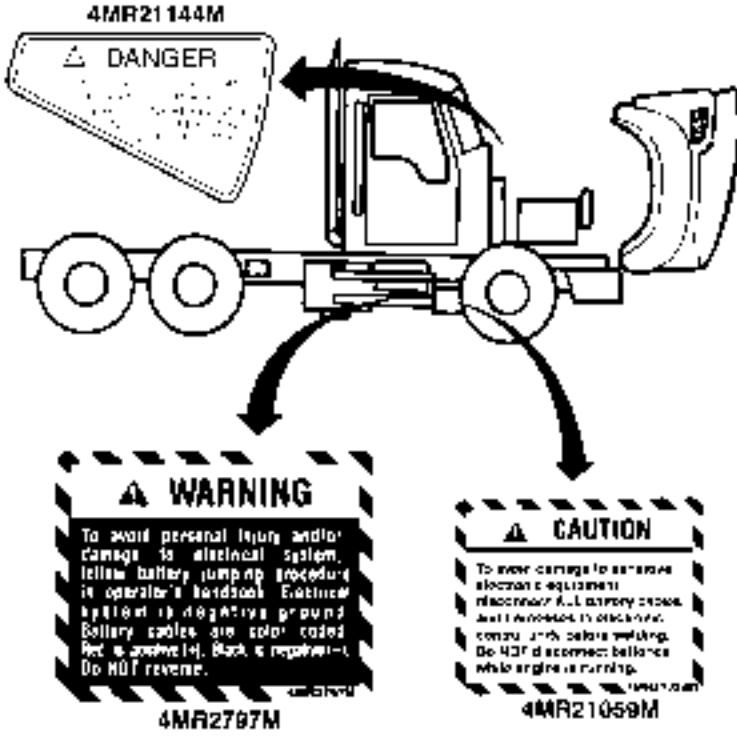

C0028959

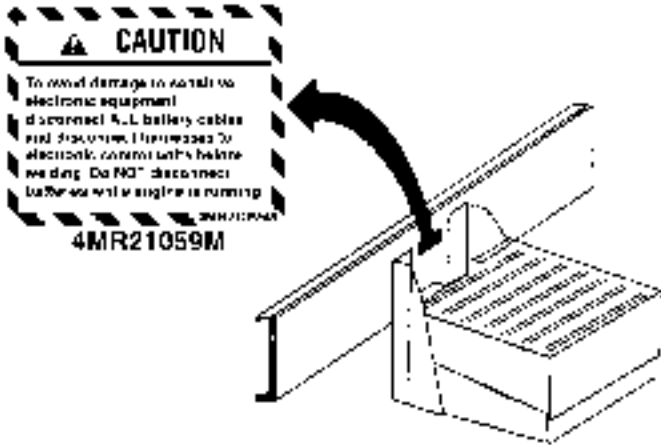

C0029012

# 36 SAFETY INFORMATION

---

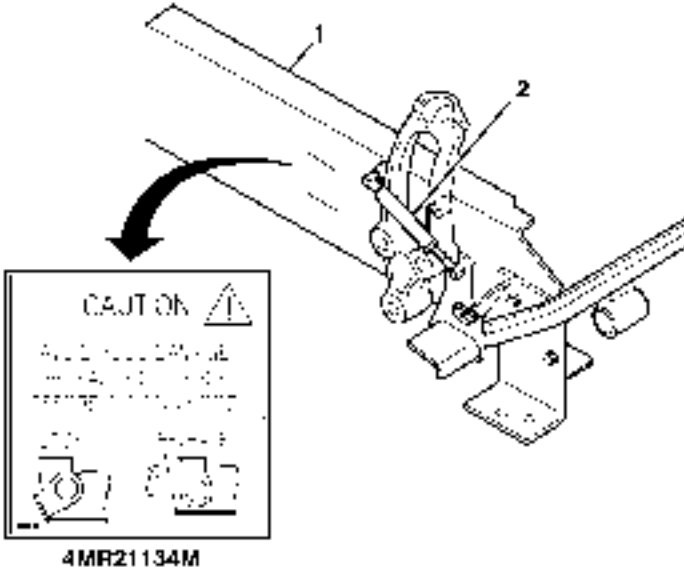

C0029013

|                          |              |
|--------------------------|--------------|
| 1. Right Side Frame Rail | 2. Hood Prop |
|--------------------------|--------------|

4MR3190M

**▲WARNING****GUIDELINES FOR  
ENTERING AND EXITING  
TO AVOID SERIOUS INJURY**

Face cab when entering AND exiting.  
 Place papers, coats, etc., in cab BEFORE entering — take out AFTER exiting — keep hands free to grip handholds.  
 Keep hands and shoes clean — check hands and shoes for grease, mud, etc., BEFORE entering or exiting.  
 Keep 3 limbs (2 hands & 1 foot or 1 hand & 2 feet) in FIRM contact with steps and handholds at ALL times.  
 Be sure where you step and grab — keep the areas clean.  
 Be EXTRA careful in rainy, snowy, etc., weather.  
 Do NOT jump from vehicle.

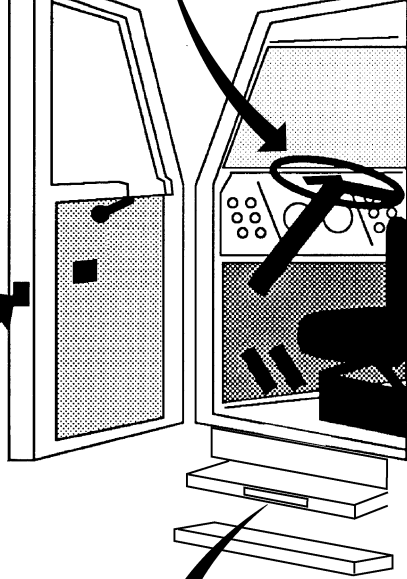

4MR2821M

C0029014



# 38 SAFETY INFORMATION

## Labels Found on Driver-Side Sun Visor

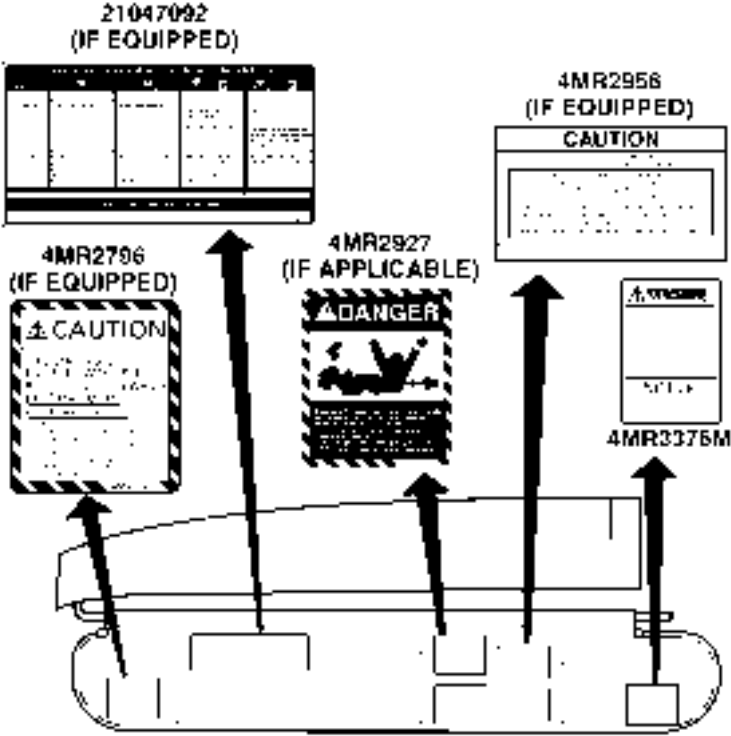

C0029015

**⚠ WARNING**

THIS VEHICLE IS EQUIPPED WITH AN ELECTRONIC STABILITY PROGRAM (ESP) THAT MAY REDUCE VEHICLE SPEED AUTOMATICALLY UNDER CERTAIN OPERATING CONDITIONS. READ THE OPERATOR'S MANUAL CAREFULLY TO UNDERSTAND ESP SYSTEM PERFORMANCE AND LIMITATIONS BEFORE DRIVING THIS VEHICLE. IF THE ESP OPERATOR'S MANUAL IS NO LONGER IN THIS VEHICLE, CONTACT YOUR DEALER FOR A REPLACEMENT COPY. IT CONTAINS IMPORTANT SAFETY AND OPERATIONAL INFORMATION.

20R29157

**⚠ CAUTION**

This vehicle is equipped with the Mack Trucks, Inc., Road Stability Advantage (RSA) system. Removal of the steering shaft or other changes to the steering components requires reinitialization of the RSA Steering Angle Sensor (SAS). Refer to Mack Trucks, Inc. Service Bulletin No. SB-735-002.

#MTC1388

**4MR21109M  
(IF EQUIPPED)**

**4MR21140M  
(IF EQUIPPED)**

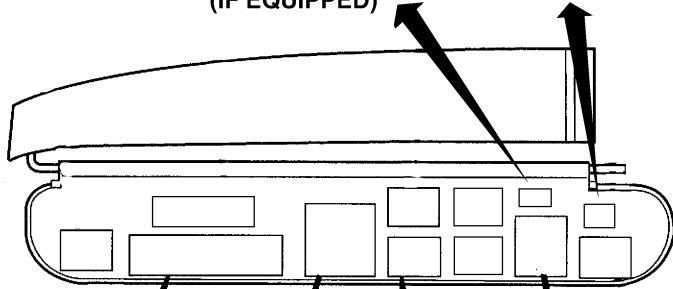

**⚠ WARNING**

REFRIGERANT LEAKAGE CAN BE DANGEROUS TO PERSONS AND TO ANY PERSONS AND PROPERTY DAMAGE. NEVER SERVICE SYSTEMS AND REPAIRS UNLESS TRAINED PERSONNEL USE CORRECT PROCEDURES. ALWAYS USE THE PROPER LEAK DETECTION METHODS AND REPAIR PROCEDURES. LEAKAGE OF REFRIGERANT CAN BE DANGEROUS TO PERSONS AND TO ANY PERSONS AND PROPERTY DAMAGE. NEVER SERVICE SYSTEMS AND REPAIRS UNLESS TRAINED PERSONNEL USE CORRECT PROCEDURES. ALWAYS USE THE PROPER LEAK DETECTION METHODS AND REPAIR PROCEDURES.

#MTC1388

**4MR3211M**

**⚠ CAUTION**

SAFETY AIR LINE OPERATION: Push in clutch pedal. Shift to neutral. Apply parking brake. Turn ignition switch ON. Shift to desired gear (see caption below). Let clutch pedal. Follow separate instructions for pulling on slope.

**FOOD OPERATION:**  
Push in clutch pedal. Shift to neutral. Turn off power switch.

**⚠ CAUTION** — Do not cigarettes and other equipment in the vicinity of the driver's seat.

**4MR2887  
(IF APPLICABLE)**

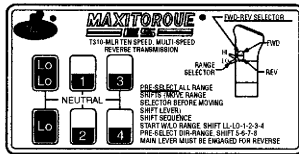

**SHIFTING INSTRUCTIONS  
LABEL (VARIES BY MODEL)**

**⚠ DANGER**

**High Exhaust System  
Temperature**

Exhaust gases and components are at extremely high temperatures. When parking the vehicle, keep away from people, or any flammable materials, vapors, or structures.

21H47095

**21047095**

**NOTE**

⚠ **DANGER**

Exhaust gases and components are at extremely high temperatures. When parking the vehicle, keep away from people, or any flammable materials, vapors, or structures.

**4MR2967M**

C0029016

## 40 SAFETY INFORMATION

### Labels Found on Instrument Panel

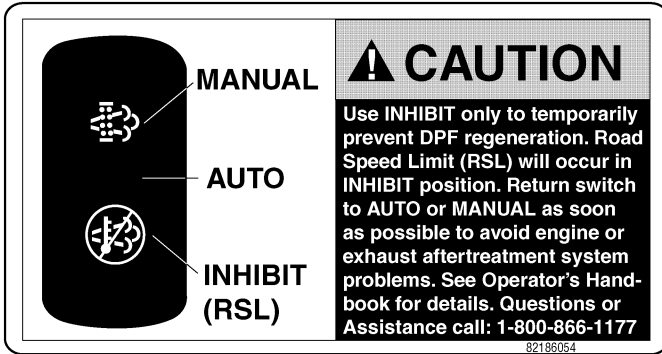

C0029017

### Labels Found on Windshield



C0029018

**Note:** Label to be removed upon delivery to the end user.

**R-134a Refrigerant Label**

The servicing caution label 4MR3283M is located under the hood attached to the receiver dryer bracket.



C0029019

**Eaton Controlled Traction Differential Label**

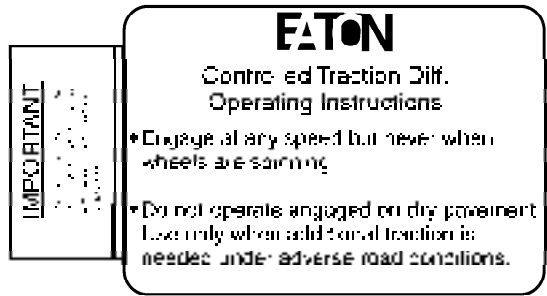

C0029020

## 42 SAFETY INFORMATION

---

### *Labels Found on Fuel Tank*

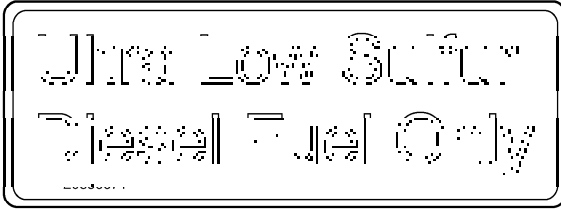

C0029021

### *Back Up Alarm (Optional)*

Your chassis may be equipped with an optional back up alarm. If so, the following label will appear inside the cab.



C0029022

## TRUCK-TRACTOR CONSPICUITY

To make the vehicle more conspicuous when approached from the rear (in times when visibility is reduced), all truck/tractors built on or after July 1, 1997 have reflective devices applied on the rear of the cab and on the mudflaps or mudflap hanger brackets if mudflaps or mudflap hanger brackets are supplied from the factory. If mudflaps or mudflap hanger brackets are not supplied from the factory, reflective devices will be applied on the rear, lower portion of the cab. Refer to the illustration. Locations of these reflective devices may vary from this illustration, depending on the cab model and/or equipment added to the rear of the cab.

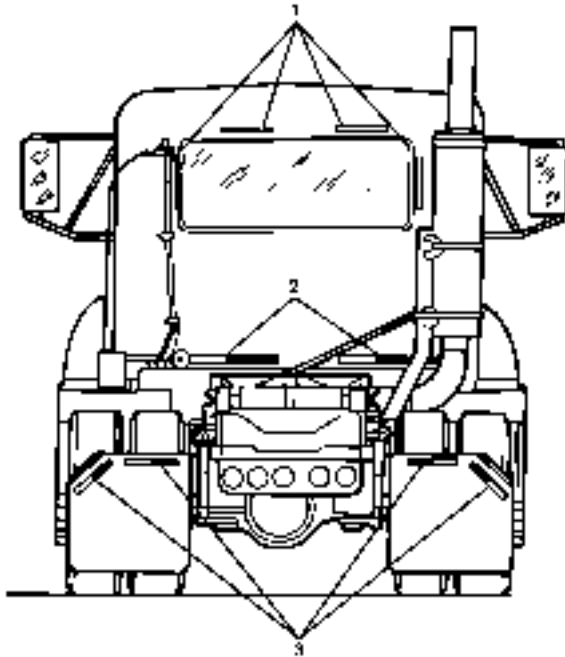

C0029023

|   |   |
|---|---|
| <p>1. White Reflective Devices Back of Cab<br/>2. Red and White Reflective Devices (when not equipped with mudflaps and brackets)</p> | <p>3. Red and White Reflective Devices on Mudflaps or Hanger Brackets</p> |
|---|---|

**Note:** The truck-tractor conspicuity standard is intended to make the tractor as visible as the trailer when the truck tractor is being operated in a bobtail condition.

## 44 SAFETY INFORMATION

---

### CAB ENTRY/EXIT

#### Three-Limb Contact



#### WARNING

When entering or exiting a cab, the driver and/or passenger must have at least three limbs in contact with the vehicle or ground at all times. This means that a minimum of two hands and one foot, or one hand and two feet must be in FIRM contact with the vehicle or ground.



#### WARNING

When entering or exiting the cab, be aware of the condition of the steps and handrails. Clean any fuel, oil or grease off of the steps before entering the cab. During cold weather, ice and snow may accumulate and should be cleaned off to prevent slipping.

During cold, wet conditions when ice, slush, or snow may accumulate on the cab doorstep and other external surfaces, extra caution must be observed when entering or exiting the cab.

**WARNING****GUIDELINES FOR ENTERING AND EXITING TO AVOID SERIOUS INJURY**

- Face the cab when entering AND exiting.
- Place papers, coats, etc., in cab BEFORE entering. Take out AFTER exiting. Keep hands free to grip handholds.
- Keep hands and shoes clean. Check hands and shoes for grease, mud, etc., BEFORE entering or exiting.
- Keep 3 limbs (2 hands and 1 foot or 1 hand and 2 feet) in FIRM contact with steps and handholds at ALL times.
- Be sure of where you step and grab the handholds. Keep the areas clean.
- Be EXTRA careful in rainy, snowy, etc., weather.
- Do NOT jump from vehicle.

**Note:** The illustrations on the following pages are typical for purposes of emphasizing a safe method for hand/foot placement and movement during cab entry/exit. Your vehicle may not look exactly like the one pictured.

**Note:** The arrows in the illustrations are intended to show movement. Notice that three-limb contact is maintained even when one foot, or one hand, is moving.



## 46 SAFETY INFORMATION

---

### Driver Side

The following cab entry and exit procedures, along with the safety guidelines outlined in Three-Limb Contact earlier in this section, should be used with this MACK vehicle.

#### **Entry**

These entry procedures are illustrated on the following page:

- 1 With both feet firmly on the ground, grab the outside handhold with both hands or grab the outside handhold with one hand and grab the steering wheel with the other hand. Then raise one foot to the bottom step. (See figure 1.)
- 2 Maintain a firm grip on the handhold and/or steering wheel and raise your other foot to the top step. (See figure 2.)
- 3 While still gripping the handhold and/or steering wheel, raise one foot to the cab floor. (See figure 3.)
- 4 Move one hand at a time to the steering wheel or cab interior. Bring the other foot inside the cab and sit down. (See figure 4.)

#### **Exit**

To exit, follow the illustrations in reverse order:

- 1 With both hands gripping the steering wheel or cab interior, stand up and face the inside of the cab. Move one foot to the top step. (See figure 4.)
- 2 Move one hand to the outside handhold and grip the steering wheel or cab interior with the other hand. With one foot firmly on the top step, lower the other foot to the bottom step. (See figure 3.)
- 3 Maintain a firm grip on the handhold and/or steering wheel, and keep one foot firmly on the bottom step. Then lower the other foot to the ground. (See figure 2.)
- 4 With both hands firmly gripping the outside handhold, lower the other foot to the ground. (See figure 1.)

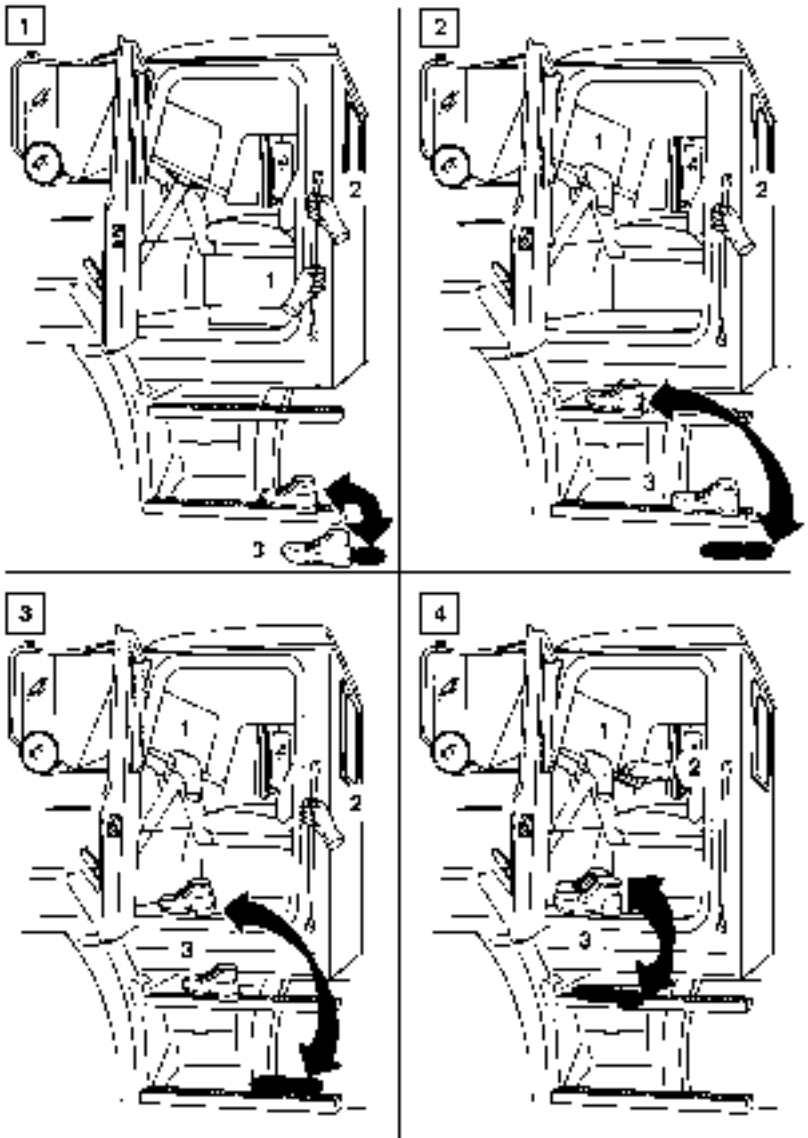

C0029024

# 48 SAFETY INFORMATION

---

## Passenger Side

The following cab entry and exit procedures, along with the safety guidelines outlined in the Three-Limb Contact section, should be used with this MACK vehicle.

### ***Entry***

These entry procedures are illustrated on the following page:

- 1 With both feet firmly on the ground, grab the outside handhold with both hands. Then raise one foot to the bottom step. (See figure 1.)
- 2 Maintain a firm grip on the outside handhold with your left hand and grab the inside handhold with your right hand. Then raise your other foot to the top step. (See figure 2.)
- 3 While still gripping the handholds, raise one foot to the cab floor. (See figure 3.)
- 4 Move your left hand to the cab interior. Bring the other foot inside the cab and sit down. (See figure 4.)

### ***Exit***

To exit, follow the illustrations in reverse order:

- 1 With your right hand gripping the inside handhold and your left hand gripping the cab interior, stand up and face the inside of the cab. Move one foot to the top step. (See figure 4.)
- 2 While maintaining a firm grip on the inside handhold with your right hand, move your left hand to the outside handhold. Then, lower the other foot to the bottom step. (See figure 3.)
- 3 With a firm grip on both handholds and your foot planted securely on the bottom step, lower the other foot to the ground. (See figure 2.)
- 4 Move your right hand to the outside handhold and lower the other foot to the ground. (See figure 1.)

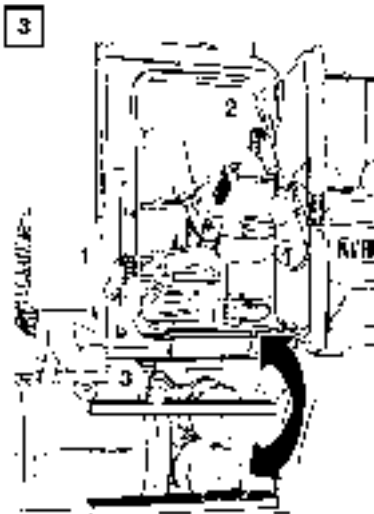

C0029025

## 50 SAFETY INFORMATION

---

### Deck Plate Access

There may be a time when you will need to climb up behind the cab. If your vehicle is equipped with a deck access package, steps and a handhold are provided so you can get to this area safely. Review the rules in the Three-Limb Contact section before climbing behind the cab.

#### *Climbing Up*

These procedures are illustrated on the following page:

- 1 Grab the handhold with both hands. Then move one foot to the bottom step. (See figure 1.)
- 2 While still gripping the handhold, and with one foot planted firmly on the bottom step, move your other foot to the top step. (See figure 2.)
- 3 Then with one foot planted firmly on the top step, move the other foot to the deck plate. (See figure 3.)
- 4 Finally, move your other foot from the top step onto the deck plate. (See figure 4.)

#### *Climbing Down*

To climb down from behind the cab, follow the illustrations in reverse order:

- 1 Grab the handhold with both hands and move one foot to the top step. (See figure 4.)
- 2 While firmly gripping the handhold, and with one foot on the top step, move your other foot to the bottom step. (See figure 3.)
- 3 Then with one foot planted firmly on the bottom step, place the other foot on the ground. (See figure 2.)
- 4 Finally, move foot from bottom step to the ground. (See figure 1.)

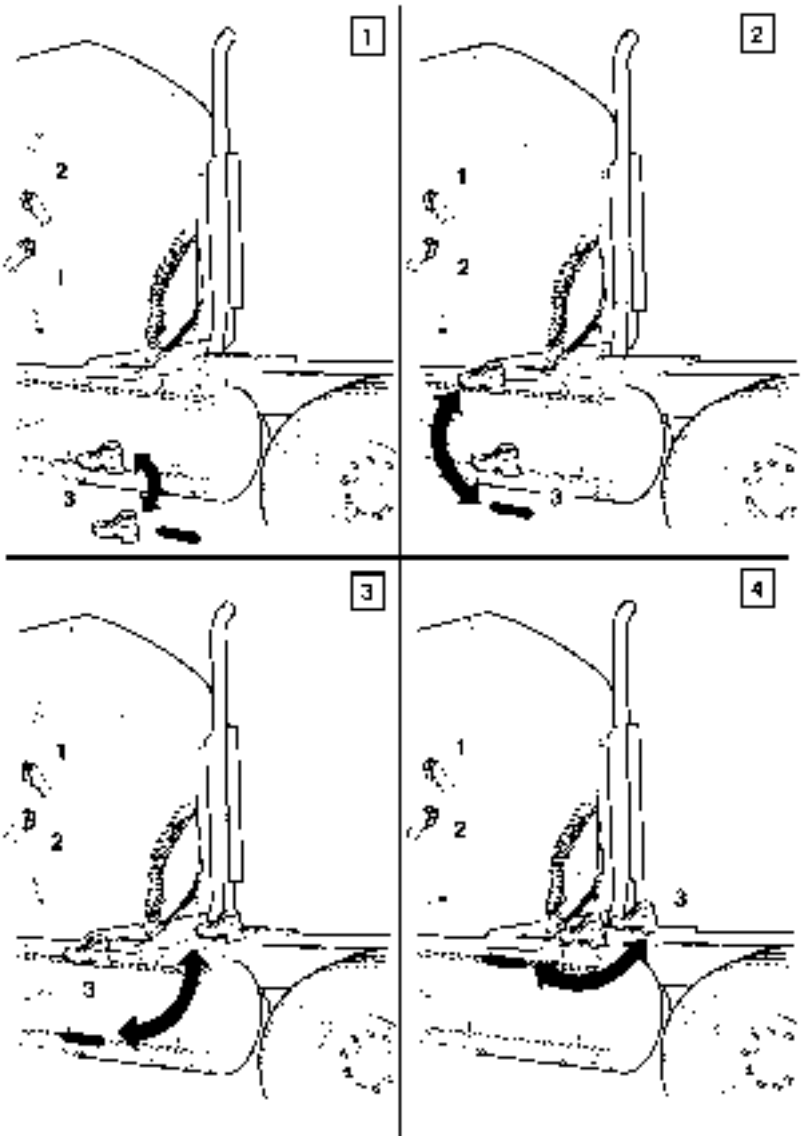

C0029130

## 52 SAFETY INFORMATION

---

### SAFETY TIPS FOR COLD WEATHER

#### Driver Visibility

Poor driver visibility is not only annoying, but extremely unsafe under any circumstance. Without proper maintenance of visibility-related components, adverse weather conditions such as rain, snow and frost can seriously reduce visibility. Take time before winter arrives to check the following:

- Windshield Wipers
  - Check windshield wiper and speeds.
  - Inspect condition and travel of blades. Install new refills for any blades that are cracked, brittle, torn, or coated with road oil along the wiping edge.
- Windshield Washers
  - Check of windshield washer.
  - Inspect system hoses and replace if brittle or worn.
  - Inspect washer reservoir. Drain and flush if dirt particles are evident in washer solution.
  - Fill reservoir with commercially available non-freezing type washer fluid.



#### CAUTION

*Do NOT fill reservoir with water only. Even though non-freezing type washer fluid is recommended, do not attempt to clear the windshield of ice by activating the windshield washer and wipers. Ice accumulations should be removed manually by using a scraper.*

- Heater/Defroster
  - Check and blowers for speed control, noise and temperature.
  - Inspect heater core for signs of corrosion and/or leakage.
  - Check that the defroster blend door is operating correctly and that all ducting is connected properly.
  - Be sure that vents are not obstructed by debris or other objects.

## Auxiliary Cab Heater

To ensure maximum in-cab comfort (even under severe cold weather conditions) contact a MACK subsidiary or distributor for details concerning auxiliary in-cab heaters (see figure below).

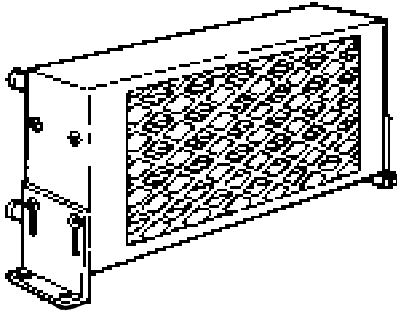

C0029131



## 54 SAFETY INFORMATION

---

### Cab Door Seals and Key Locks

Hollow-core rubber weather seals around some cab doors may lose their resilience in extremely cold temperatures (i.e.,  $-40^{\circ}\text{C}/-40^{\circ}\text{F}$  and below). Under these conditions, it may be necessary to drill holes to penetrate the hollow core. This allows entrapped air to escape, thereby easing the opening/closing of cab door(s).

Be sure to keep the key locks clean and dry to prevent occasional winter freeze-up. Use of antifreeze lubricants is neither required nor recommended.

### Outside Mirror Heater

In areas of frequent snowfall and ice, it may be beneficial to install heated mirrors which will defrost and de-ice cab mirrors. Heated mirrors eliminate the need to pull off the highway and stand on the roadside to scrape ice and snow from the mirrors during winter driving conditions. Heated mirrors are available either cab mounted or fender mounted.

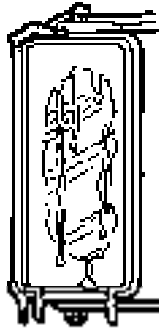

C0029132

---

## Air Horn Snow Shield

Installation of an air horn snow shield is recommended to prevent snow from clogging the air horn bell (maintaining maximum sound output).

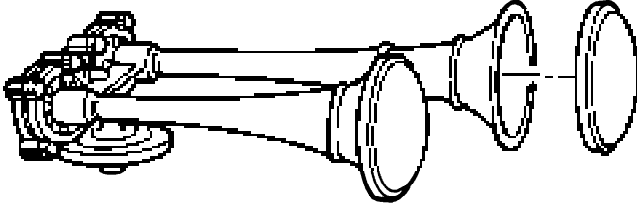

C0029133

## Emergency Reflector Kit

All on-road vehicles are required to have an emergency reflector kit.

If the kit is installed from the factory, it includes red reflector triangles and can be stored in one of the following locations:

- Inboard side of rider seat
- Left-hand luggage compartment of sleeper box
- Between rider seat and rider side door

## Fire Extinguisher (Optional)

Your vehicle may be equipped with a fire extinguisher which is located inside your cab. Check your fire extinguisher regularly to make sure it is fully charged.

# 56 INSTRUMENTS AND CONTROLS

## CAB INTERIOR

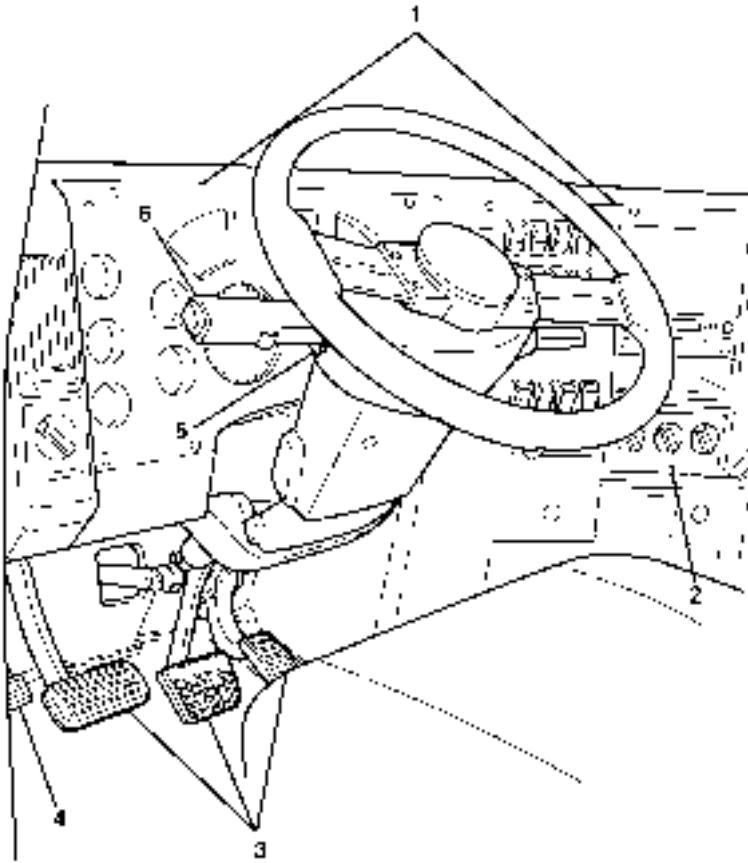

C0029134

- |                              |  |
|------------------------------|--|
| 1. Instrument Panels         | 5. Hazard Switch   |
| 2. Cab Climate Control Panel | 6. Turn Signal, Flash, HI/LO Beam,<br>Courtesy Flash and Flash to Pass |
| 3. Foot Pedals               |  |
| 4. Tilt Control Pedal        |  |

## INSTRUMENT PANEL

### Tell-Tales

A tell-tale is a display that indicates the actuation of a device, a correct or defective condition, or a failure to function.

The operator should become familiar with these symbols in order to recognize and react (if necessary) to the indicated condition. Tell-tale symbols are shown in the instrument panel illustrations on the following pages.

#### **Colors**

To promote visual recognition internationally, specific colors for tell-tales have been established. Unless governmental regulations (in the area where the vehicle is to be used) or engineering directives specify otherwise, the standard colors are:

- **Blue** – high-beam headlights/engine maintenance
- **Flashing Green** – turn signals
- **Flashing Red** – hazard condition involving the safety of personnel
- **Steady Green** – system in
- **Steady Red** – warning, immediate action required
- **Amber** – early warning, such as low fuel or Anti-Lock Brake System (ABS) malfunction

### Panel Arrangement

Your view from the driver seat should look something like the illustrations shown. The layout is designed to provide the operator with a good view of the gauges and controls (which are placed so they are within easy reach). The instrument panel, as shown in the following drawing, is broken down into several main sections. For easy identification we refer to them, from left to right, as Panels A, B, C, D, E and F (where necessary).

**Note:** This section shows the instruments and controls available for this vehicle at the time of publication. However, depending on options, your vehicle may not have all the instruments and controls shown here, and they may not be in the same position.

## INSTRUMENT PANEL GAUGE LAYOUT

The instrument panel features a wrap-around dash with electronically controlled "race type" gauges, meaning their needles point up when the truck is running properly.



C0029135

# 60 INSTRUMENTS AND CONTROLS

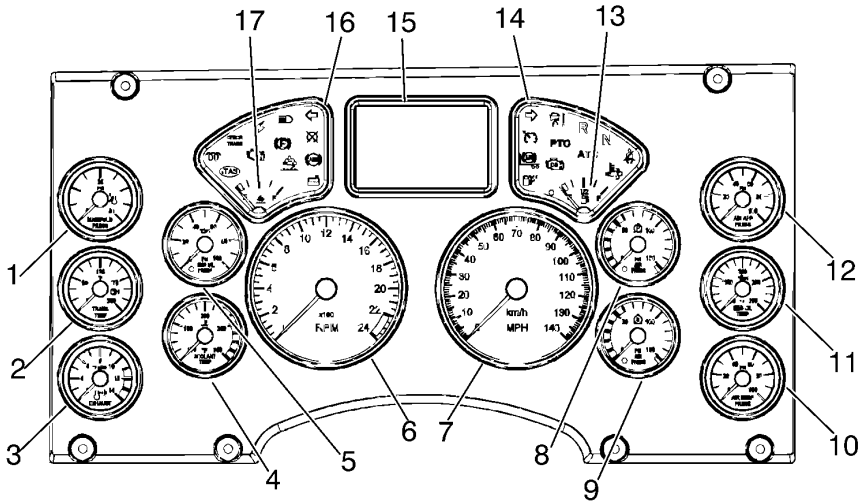

W3056185

|                                 |                              |
|---------------------------------|------------------------------|
| 1. Manifold Boost Pressure      | 10. Air Suspension Pressure  |
| 2. Transmission Oil Temperature | 11. Engine Oil Temperature   |
| 3. Exhaust Pyrometer            | 12. Air Application Pressure |
| 4. Engine Coolant Temperature   | 13. Fuel Level               |
| 5. Engine Oil Pressure          | 14. Right Hand Tell-Tale     |
| 6. Tachometer                   | 15. DOT Matrix Display       |
| 7. Speedometer                  | 16. Left Hand Tell-Tale      |
| 8. Primary Air Pressure         | 17. DEF Level                |
| 9. Secondary Air Pressure       |                              |

## Panel A

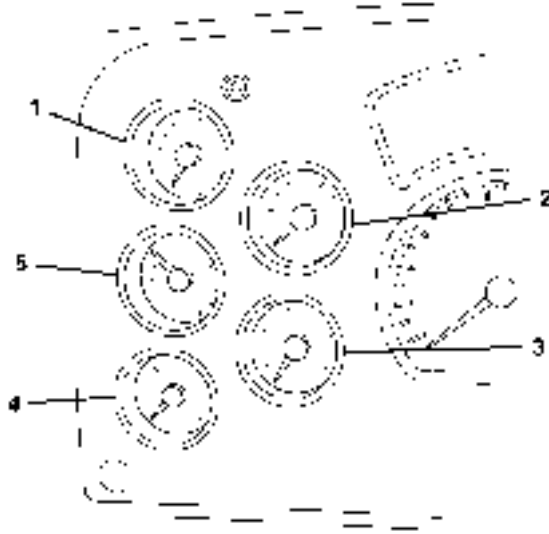

C0029136

1. Manifold Pressure Gauge (If Equipped)

2. Engine Oil Pressure Gauge

3. Engine Coolant Temperature

4. Exhaust Pyrometer (If Equipped)

5. Transmission Oil Temperature Gauge (If Equipped)



# 62 INSTRUMENTS AND CONTROLS

## Panel B

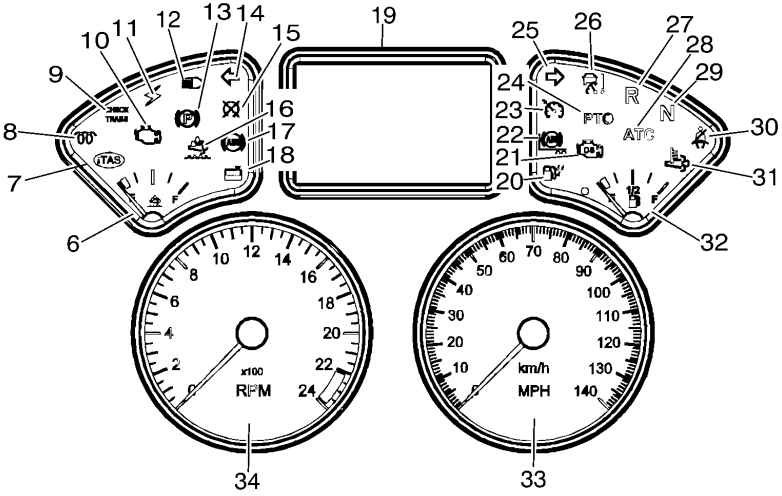

W3056238

|   |   |
|---|---|
| <p>6. Aftertreatment DEF Level Gauge</p> <p>7. Integrated Temp-A-Start Indicator (Amber) (If Equipped).</p> <p>8. Pre-Heat Start Indicator (Amber) (If Equipped)</p> <p>9. Check Transmission Indicator (Amber)</p> <p>10. Electronic Malfunction Indicator (Amber)</p> <p>11. On Board Diagnostics Indicator (Amber)</p> <p>12. High Beams Indicator (Blue)</p> <p>13. Parking Brake Indicator (Red)</p> <p>14. Left Turn Signal Indicator (Green)</p> <p>15. Engine Shutdown Indicator (Red)</p> <p>16. Aftertreatment DEF Low Level Indicator (DEF)</p> <p>17. Anti-Lock Brake System (ABS) Indicator (Amber)</p> <p>18. Low Coolant Level Indicator (Amber)</p> <p>19. Co-Pilot® (If Equipped)</p> <p>20. Water in Fuel Indicator (Amber) (If Equipped)</p> | <p>21. Engine Over Speed Indicator (Red)</p> <p>22. Trailer Anti-Lock Brake System (ABS) Indicator (Amber)</p> <p>23. Cruise Control On Indicator (Green)</p> <p>24. Power Take-Off Operating Indicator (Green)</p> <p>25. Right Turn Signal Indicator (Green)</p> <p>26. Bendix Adaptive Cruise Control (ACC) Indicator (Red)</p> <p>27. Reverse Indicator (Amber)</p> <p>28. Automatic Traction Control (ATC) Indicator (Amber)</p> <p>29. Neutral Indicator (Amber)</p> <p>30. Fasten Seat Belt Warning Indicator (Red)</p> <p>31. HEST Indicator (If Equipped)</p> <p>32. Fuel Gauge</p> <p>33. Speedometer</p> <p>34. Tachometer</p> |
|---|---|

## 64 INSTRUMENTS AND CONTROLS

### Panel C

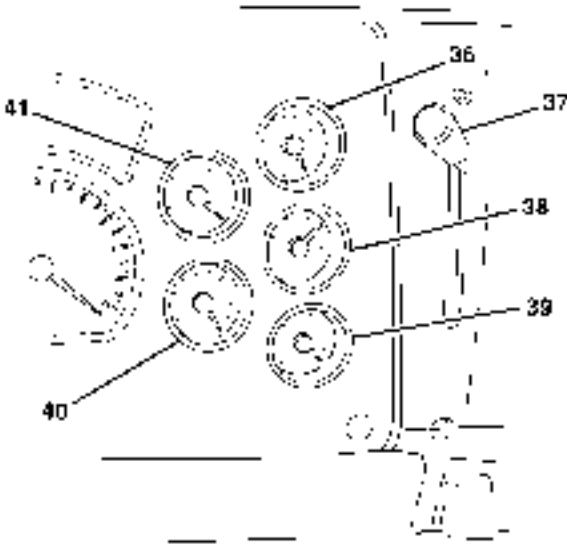

C0029138

36. Air Application or Air Suspension Gauge (If Equipped)

37. Hand-Control Brake Lever

38. Engine Oil Temperature Gauge

39. Air Suspension Pressure

40. Secondary Air Pressure Gauge

41. Primary Air Pressure Gauge

Panel D

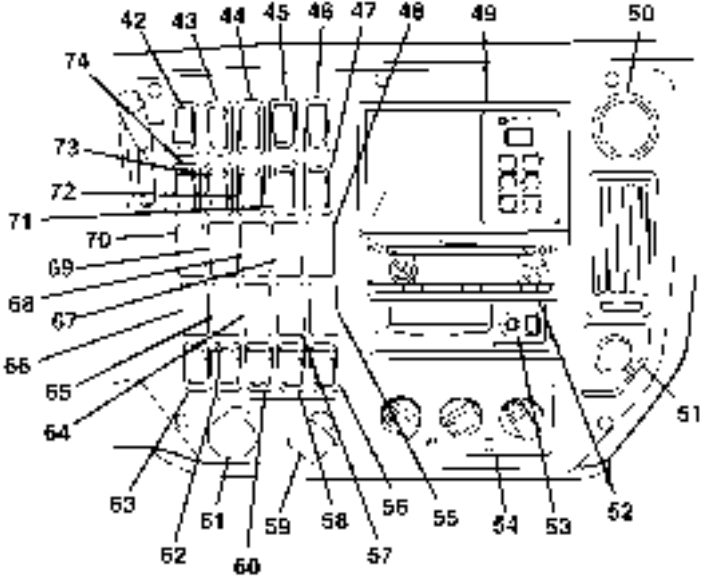

C0029139

|  |                              |
|--|------------------------------|
| 42. Wiper Speed/Delay/Wash Master Switch                         | 58. Optional Switch*         |
| 43. DPF Smart Switch (If Equipped)                               | 59. Parking Brake Valve      |
| 44. Optional Switch*   | 60. Optional Switch*         |
| 45. Optional Switch*   | 61. Trailer Air Supply Valve |
| 46. Optional Switch*   | 62. Optional Switch*         |
| 47. Optional Switch*   | 63. Optional Switch*         |
| 48. Optional Switch*   | 64. Optional Switch*         |
| 49. Storage Box or Automatic Transmission Selector (If Equipped) | 65. Optional Switch*         |

## 66 INSTRUMENTS AND CONTROLS

|  |                          |
|--|--------------------------|
| 50. Air Filter Restriction Indicator (If Equipped) | 66. Optional Switch*     |
| 51. Accessory Power Outlet                         | 67. Optional Switch*     |
| 52. Radio Box                                      | 68. Optional Switch*     |
| 53. AUX/USB Port                                   | 69. Optional Switch*     |
| 54. Cab Climate Control                            | 70. Optional Switch*     |
| 55. Optional Switch*                               | 71. Optional Switch*     |
| 56. Optional Switch*                               | 72. Optional Switch*     |
| 57. Optional Switch*                               | 73. Resume/Set Switch    |
|  | 74. Speed Control Switch |

\* The switches shown in parentheses are listed in their likely position on the panel; however, they may be at other switch locations depending on the customer's requirements. See for a description of the optional switches, listed in alphabetical order.

**1. Manifold Pressure Gauge (If Equipped)** – Measures the charge air boost pressure in the intake manifold.

**2. Engine Oil Pressure Gauge** – Indicates engine oil pressure. The normal operating oil pressure for a MACK MP engine (at governed speed) is between 275.8 and 620.5 kPa (40 and 90 psi). At idling speed, the oil pressure should be between 275.8 and 413.9 kPa (40 and 60 psi).

**3. Engine Coolant Temperature Gauge** – Indicates the temperature of the engine coolant. The normal operating temperature for MACK engines is between 77°C and 107°C (170°F and 225°F). The driver will receive a warning if coolant temperature reaches 106°C (223°F) and engine shutdown will occur at 108°C (227°F) if the engine coolant temperature shut down option is enabled.



### CAUTION

*Coolant temperature must NOT exceed 107°C (225°F).*

<https://www.truck-manuals.net/mack/>

**4. Exhaust Pyrometer (If Equipped)** – Indicates the temperature of exhaust gases (about 12 to 16 inches from the diesel particulate filter inlet connections). This helps the operator select the proper gear for load and grade conditions, thereby avoiding excessive exhaust temperatures.



## CAUTION

*Do NOT exceed the maximum exhaust temperature indicated by the red line on the gauge. To reduce exhaust temperature, downshift or reduce engine power. If operating in cold climates with a winterfront, open the winterfront.*

**5. Transmission Oil Temperature Gauge (If Equipped)** – Indicates transmission oil temperature.



## CAUTION

*The maximum safe oil temperature for MACK transmissions is 121°C (250°F) for mineral-based oil, or 148°C (300°F) for synthetic oil. Continued with oil above this temperature will cause rapid deterioration of the oil's lubricating properties and is NOT recommended. Consult the vendor manual for non-MACK components.*

**6. Aftertreatment DEF Tank Level gauge**

**7. Integrated Temp-A-Start (Amber) (If Equipped)** – "Integrated Temp-A-Start" saves fuel by reducing the amount of time spent idling to keep the vehicle's batteries charged, the engine warm, or the cab and sleeper comfortable. Once the optional 'Integrated Temp-A-Start' feature is activated via a dash switch, the system will automatically start and stop the truck engine. Safety overrides prevent the system from activation if the transmission is in gear, the hood is up, or the parking brake is released. Integrated Temp-A-Start voltage and temperature target settings are fully programmable through either VCADS service support software, or, if enabled via the Co-Pilot instrument cluster display

**8. Wait to Start (Amber) (If Equipped)** – Indicates that the intake pre-heat is enabled. Wait to start engine until light goes out.

**9. Transmission Oil Temperature Indicator (Red)** – A red tell-tale light that illuminates when transmission oil temperature reaches a pre-determined level (depending on transmission make and model) indicating an overheat condition.

**10. Electronic Malfunction Indicator (Amber)** – Illuminates when V-MAC® detects an electronic malfunction. Refer to the *V-MAC® IV Operator's Guide*. The electronic malfunction lamp may turn on when operating the vehicle in a bob-tail mode with the engine brake turned on and cruise control active. Cruise control will become inoperative but can be reset by shutting off, then restarting the engine. This condition can be corrected by resetting the "Service Brake Fault Threshold with Engine Brake" function. Refer to V-MAC® IV Customer Data Programming.

**Note:** Consult the appropriate vendor engine manual if your vehicle is not equipped with a MACK engine.

### 11. Check Lamps

**12. High Beam Indicator (Blue)** – Indicates that high beams are on.

**13. Parking Brake Indicator (Red)** – Indicates that the parking brake is engaged.

**14. Left Turn Signal Indicator (Green)** – Flashes green when the left turn signal is activated.

**15. Engine Shutdown Indicator (Red)** – Indicates the occurrence of a condition which requires that the engine be shut down (i.e., low water level, low oil pressure or high water temperature). If the engine shutdown feature is enabled, the engine will be forced to idle. Once vehicle is stopped, the engine will shut down. If the engine shutdown feature is disabled, the indicator will function as a warning light but the engine will not shut down.

**16. Aftertreatment DEF Low Level Indicator (DEF)**– Icon illuminated when the fluid level is low. It also flashes when the level becomes critically low.

**17. Anti-Lock Brake System (ABS) Indicator (Amber)** – Indicates an ABS malfunction. If the light turns on and stays on, a malfunction is indicated. For additional information on operating an ABS-equipped vehicle, refer to of the *Operation* section.

**Note:** When an ABS malfunction is detected, anti-lock braking in the affected wheel(s) will be disabled and normal braking will return; the other wheels will retain anti-lock braking. Operate the vehicle normally and have the ABS system serviced to correct the fault.

**18. Low Coolant Level Indicator (Amber)** – Illuminates when the coolant level in the coolant surge tank is below the specified level. Stop and add coolant. Use typical warnings, etc., for filling coolant.

## 19. Basic Display or Co-Pilot® (If Equipped)

### BASIC DISPLAY

The Basic Display is an in-dash computer that allows the vehicle operator to monitor a minimum amount of information supplied by the V-MAC IV electronic control system. The operator presses a push button located directly below the driver information display to retrieve information.

**Note:** The Basic Display does not use a stalk switch, which is only available with the Co-Pilot® display.

The following information is available in the Basic Display:

- **Current Conditions**

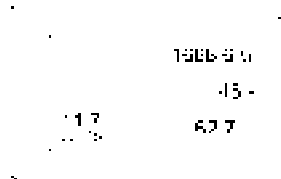

*Current Conditions Screen*

C0029140

- **Trip Information**

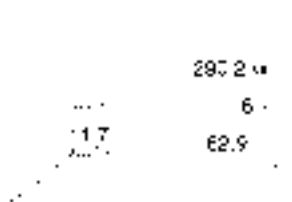

*Trip Information Screens*

C0029141



# 70 INSTRUMENTS AND CONTROLS

## Diagnostics

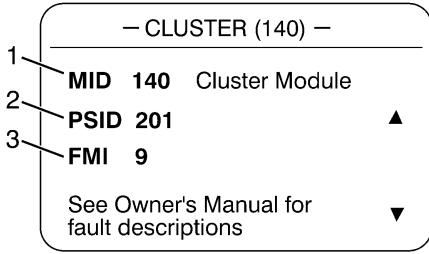

W3036575

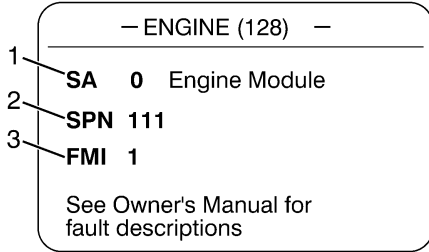

W3036576

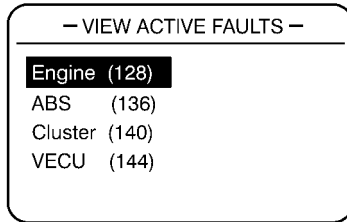
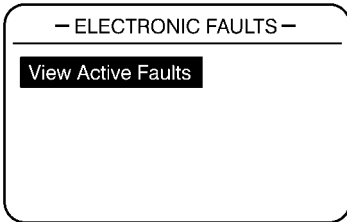

W3036583

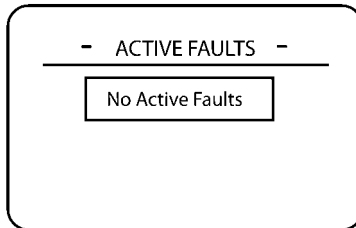
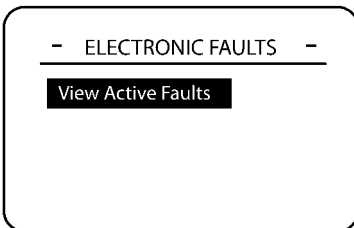

Select View Active  
Faults Screen

No Active Faults Screen

Diagnostics (cont'd.)

W3036584

OR

### CO-PILOT® (If Equipped)

Co-Pilot® is an in-dash computer that allows the vehicle operator to monitor information supplied by the V-MAC® electronic control system. The Co-Pilot® enhances the functions of V-MAC® by entering requested information with the stalk switch. The Co-Pilot® is very "user friendly" and prompts the operator with messages on the display screen. For more information on how to use the Co-Pilot®, please consult the *V-MAC® IV Vehicle Management and Control with Co-Pilot® Display Operator's Guide, TS898*.

### GuardDog™ (Optional; Must be Enabled)

GuardDog™, an active maintenance monitoring system, uses sensor readings to show the status of routine maintenance requirements. If the vehicle is equipped with the GuardDog™ system, Co-Pilot® will display GuardDog™ related maintenance items under the following conditions:

- When the vehicle is started

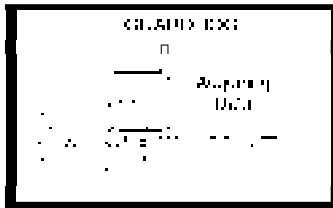

GuardDog™ Acquiring Data Screen

C0029143

- During driving as individual maintenance items become due

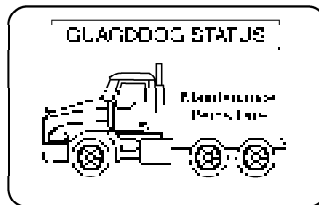

GuardDog™ Maintenance Items Due Screen

C0029144

## 72 INSTRUMENTS AND CONTROLS

- Manually through the GuardDog™ Status screen

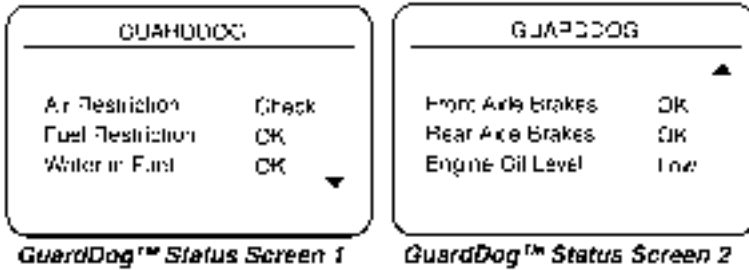

C0029145

For more information on GuardDog™, Co-Pilot® display and Basic Display, please refer to the *V-MAC® IV Operator's Guide, TS898*.

**20. Water in Fuel Indicator (Amber) (If Equipped)** – Illuminates when water accumulates in the primary fuel filter sediment bowl. Stop the engine and drain the fuel from the sediment bowl.

**21. Engine Over Speed Indicator (Red)** – Illuminates when maximum engine RPM is exceeded.

**22. Trailer Anti-Lock Brake System (ABS) Indicator (Amber)** – Indicates an ABS malfunction. If the light turns on and stays on, a malfunction is indicated. For additional information on operating an ABS-equipped vehicle, refer to of the *Operation* section.

**Note:** When an ABS malfunction is detected, anti-lock braking in the affected wheel(s) will be disabled and normal braking will return; the other wheels will retain anti-lock braking. Operate the vehicle normally and have the ABS system serviced to correct the fault.

**23. Cruise Control Indicator (Green)** – Indicates that cruise control is engaged.

**24. Power Take-Off Operating Indicator (Green)** – Indicates PTO .

**25. Right Turn Signal Indicator (Green)** – Flashes green when turn signal is activated.

**26. Inter-Axle Power Divider Lockout Indicator (Amber)** – Indicates the Inter-Axle Power Divider Lockout is engaged.

**27. Reverse Indicator (Amber)** – Indicates that the transmission is in Reverse.

**28. Automatic Traction Control (ATC) Indicator (Amber)** – Indicates that ATC is operating and will flash when in deep mud and snow mode.

**29. Neutral Indicator (Amber)** – Indicates that the transmission is in Neutral.

**30. Fasten Seat Belt Warning Indicator (If Equipped) (Red)**

<https://www.truck-manuals.net/mack/>

- 31. High Exhaust System Temperature (HEST) Icon**— when (HEST) illuminates do not park or operate the vehicle near people, or any flammable materials, vapors, or structures.
- 32. Fuel Gauge** – Registers the fuel level in the supply tank(s).
- 33. Speedometer** — Indicates road speed in miles and/or kilometers per hour.
- 34. Tachometer** – Indicates engine speed in revolutions per minute (RPM). Tachometer readings should be used as a guide for shifting, as well as to prevent engine damage due to overspeed.
- 36. Air Application Gauge (If Equipped)** – Indicates the air pressure being delivered to the service brake chambers in the tractor (and trailer, if equipped);  
OR
- Air Suspension Gauge (If Equipped)** – Indicates the air pressure being delivered to the air suspension system 689 kPa (100 psi range).
- 37. Hand-Control Brake Lever** – Pull down to activate the trailer brakes, or the rear axle brakes in the case of a platform truck.



## WARNING

The hand-control brake system must **NOT** be used for parking. Do **NOT** use to apply service brakes while vehicle is in motion. Do not leave the vehicle while hand-control brake is applied.

- 38. Front Rear Axle and 39. Rear Rear Axle Oil Temperature Gauges (If Equipped)** – Indicate rear axle oil temperature.



## CAUTION

*The maximum safe oil temperature for MACK rear axles is 121°C (250°F). Continued with oil above this temperature will cause rapid deterioration of the oil's lubricating properties and is NOT recommended. Consult the vendor manual for non-MACK components.*

## 74 INSTRUMENTS AND CONTROLS

---

**40. Primary and 41. Secondary Air Pressure Gauge** — Indicates the air pressure in the air brake system(s). The normal operating air pressure is between 759 kPa (110 psi) and 897 kPa (130 psi) in both air brake systems. If pressure drops below 517 kPa (75 psi)  $\pm 34$  ( $\pm 5$  psi) in either system, the warning buzzer and warning light will go on. Determine the cause of failure before proceeding. Primary air pressure is supplied to the rear brakes and is indicated by the green pointer on the gauge. Secondary air pressure is supplied to the steering axle brakes and indicated by the orange pointer.

### **42. Wiper Speed/Delay/Wash Master Switch**

- Depress top of the rocker switch to activate windshield washer
- Toggle switch in top position turns wipers on HIGH
- Toggle switch in second position from top turns wipers on LOW
- Toggle switch in the center position activates intermittent wipers. Pressing the switch down slows the speed of the wipers
- Toggle switch in the lowest position turns wipers OFF

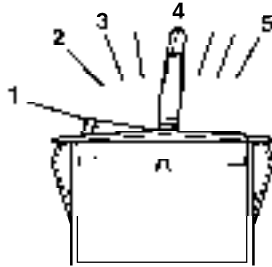

C0029147

### **Wiper Speed/Delay/Wash Master Switch**

|                  |                 |
|------------------|-----------------|
| 1. Press to Wash | 4. Intermittent |
| 2. Hi            | 5. Off          |
| 3. Lo            |                 |

**43. DPF Smart Switch (If Equipped)** – This is a three-position switch where the middle position is neutral.

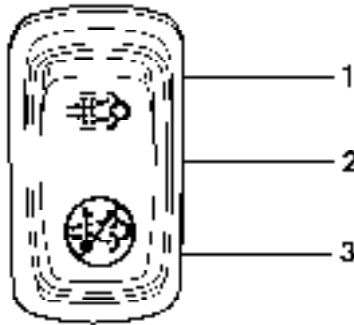

C0029148

**DPF Smart Switch**

|  |  |
|--|--|
| <p>1. Upper Position – Regeneration Position</p> | <p>3. Down Position – Inhibit Position</p> |
| <p>2. Middle Position – Neutral Position</p>     |  |

**44. Optional Switch** – Refer to .

**45. Optional Switch** – Refer to .

**46. Optional Switch** – Refer to .

**47. Optional Switch** – Refer to .

**48. Optional Switch** – Refer to .

**49. Storage Box or Automatic Transmission Selector (If Equipped)** – See your Automatic Transmission Operator’s Manual supplied with this vehicle.

**50. Air Filter Restriction Indicator (If Equipped)** – Indicates that the element needs servicing or replacement. When the red flag locks into position, service as soon as possible to prevent engine damage; then reset the indicator after the filter change. Check the air filter restriction indicator daily.

**51. Accessory Power Outlet** – See instructions under Accessory Power Outlets listed in the Instrument and Controls Section of this manual.

**52. Radio Box** – See separate owner’s manual on radio instruction.

## 76 INSTRUMENTS AND CONTROLS

---

### 53. AUX/USB Port

- **AUX Port** – Use this port to have audio from any unit played over the vehicle audio system.
- **USB Port** – Insert a memory stick, with MP3 music downloaded, and the music will be heard from the vehicle audio system. The music can be controlled with the radio or steering wheel features (if equipped). You can also use this port with the USB style MP3 players.
- **AUX and USB together** – Use both ports together for IPOD control. A special cable is required for this function. Once the IPOD is connected, it will display a MACK logo on the IPOD screen and will let you know that the IPOD can now be controlled by the radio or steering wheel features (if equipped). At this point, the IPOD can be stored out of sight. This port will also charge the IPOD.

For more information on the AUX/USB port, please refer to the radio manual that is supplied with your vehicle.

**54. Cab Climate Control** – See instructions under Cab Climate Control listed in the Instrument and Controls Section of this manual.

**55. Optional Switch** – Refer to .

**56. Optional Switch** – Refer to .

**57. Optional Switch** – Refer to .

**58. Optional Switch** – Refer to .

**59. Parking Brake Valve** – Yellow diamond-shaped knob. Pull to apply. Push to release. Applies tractor parking brakes and trailer brakes, if equipped.

**60. Optional Switch** – Refer to .

**61. Trailer Air Supply Valve** – Red octagonally-shaped knob. Pull to apply trailer emergency brakes. Push to pressurize the trailer air reservoir, releasing the trailer emergency brakes.

**Note:** The trailer air supply valve should NOT be used for parking.

**62. Optional Switch** – Refer to .

**63. Optional Switch** – Refer to .

**64. Optional Switch** – Refer to .

**65. Optional Switch** – Refer to .

**66. Optional Switch** – Refer to .

**67. Optional Switch** – Refer to .

**68. Optional Switch** – Refer to .

**69. Optional Switch** – Refer to .

**70. Optional Switch** – Refer to .

**71. Optional Switch** – Refer to .

**72. Optional Switch** – Refer to .

**73. Resume/Set Switch** – This is a V-MAC® switch; refer to the *V-MAC® IV Operator's Guide (TS898)* for more information.



C0029150

**74. Speed Control Switch** – This is a V-MAC® switch; refer to the *V-MAC® IV Operator's Guide (TS898)* for more information.

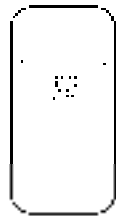

C0029211



# 78 INSTRUMENTS AND CONTROLS

## Function of Optional Switches

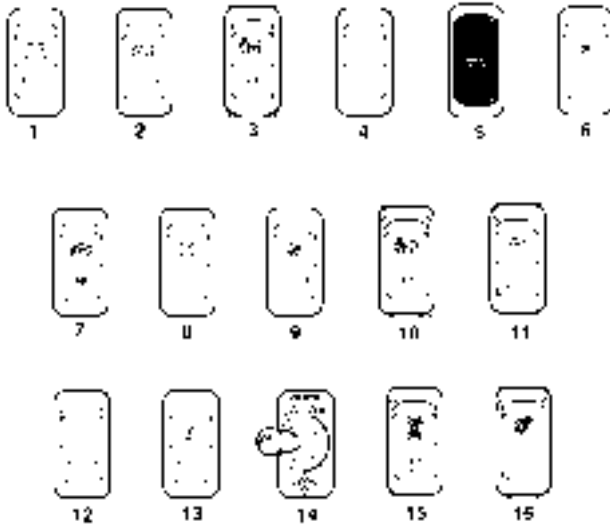

C0029212

### Optional Switches

|   |                                       |
|---|---------------------------------------|
| 1. Accessory Battery Power Switch         | 9. Fan Control Manual Override Switch |
| 2. Accessory Ignition Power Switch        | 10. 5th Wheel Slide Switch            |
| 3. Air Suspension Control Switch          | 11. Inside/Outside Air Switch         |
| 4. Automatic Traction Control Switch      | 12. Load Light Switch                 |
| 5. Body Warning Lamp                      | 13. Mirror Defrost Switch             |
| 6. Daytime Running Lights Override Switch | 14. Motorized-Mirror Joy Stick        |
| 7. Engine Brake Switch                    | 15. Power Divider Lockout Switch      |
| 8. Shutdown Override Switch               | 16. Power Take-Off Control Switch     |

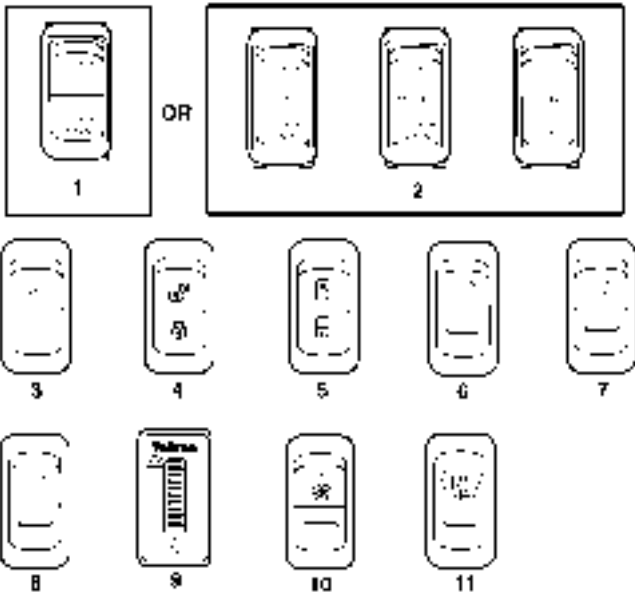

C0029213

### Optional Switches

|  |  |
|--|--|
| <ol style="list-style-type: none"> <li>1. Push Axle Up/Down Switch</li> <li>2. Push Axle Up/Down Switches</li> <li>3. QUAL COMM Panic Button</li> <li>4. Right-Hand Only Door Lock Switch</li> <li>5. Right-Hand Only Window Lift Switch</li> <li>6. Snow Plow Lamps Switch</li> </ol> | <ol style="list-style-type: none"> <li>7. Spin Light Switch</li> <li>8. Strobe Switch</li> <li>9. Telma Retarder Lamp</li> <li>10. Vent Fan Switch</li> <li>11. Windshield Defrost Switch</li> </ol> |
|--|--|

## 80 INSTRUMENTS AND CONTROLS

---

The following optional switches, listed in alphabetical order, may appear on *Panel D*, shown on .

- **Accessory Switch (Battery Power)** – This switch may be used to power optional accessory equipment that requires battery voltage, with the key switch turned OFF.
- **Accessory Switch (Ignition Power)** – This switch may be used to power optional accessory equipment that requires ignition voltage, with the key switch turned ON.
- **Air Suspension Control Switch** – This switch exhausts the air from the air bags of the suspension. It may be used when coupling or uncoupling trailers.



### CAUTION

*When preparing to connect a tractor to a trailer, make sure that the height of the 5th wheel matches the height of the underside of the trailer. Failure to do so will result in the trailer being improperly connected. After the trailer has been coupled and the trailer landing gear has been raised, make sure that the 5th wheel jaws have properly engaged the trailer king pin, and there is no gap between the 5th wheel plate and the bottom of the trailer.*



### CAUTION

*DUMP BODY: Always exhaust the air from the bags before raising the dump body to protect the air bags and improve chassis stability while dumping. If the dump body is raised while the air suspension is pressurized, damage to the air bags may result.*



### CAUTION

*Do not drive the vehicle with the air bags exhausted. Repressurize the air bags before driving the vehicle.*

**Note:** Engine speed and road speed will automatically be limited if the vehicle is moved with the air bags exhausted.

For information concerning trailer coupling and uncoupling, refer to the section of this manual.

<https://www.truck-manuals.net/mack/>

- **Automatic Traction Control Switch/Heavy Mud/Snow** – Activate for increased traction control in heavy mud or snow. (See in the *Operation* section of this manual for more details.) When the operator presses the top of the rocker switch, the heavy mud/snow function ATC indicator lamp blinks continuously. The ATC lamp stops blinking when the ATC mode switch is pressed again or ignition key cycled.



## CAUTION

*Be sure to deactivate the heavy mud/snow function when no longer needed. Continued with the heavy mud/snow function active will result in vehicle damage. If after a reasonable amount of time (no more than five minutes) the vehicle is still not passive, deactivate the ATC and put on chains.*

- **Body Warning Lamp** – The Body Lamp illuminates a RED warning icon on the "D" panel to alert the driver of a body function as defined by the bodybuilder. As an example, the body warning lamp will illuminate to alert the driver that the dump body is not fully down.



C0029214

- **Daytime Running Lights (DRL) Override Switch** – Daytime Running Lights (DRL) come standard on all MACK vehicles and can be optioned with or without an override switch. When the DRL override switch has been specified, different conditions can be selected that cause the DRL to automatically activate, DRL can be automatically turned on when the parking brake is released, the engine is running or both. Only one of these choices may be selected. Using DRL will illuminate the low beam headlamp bulbs at a slightly reduced intensity. The DRL function will monitor high beams as well. If the high beams are activated, the DRL will be temporarily turned off until high beam use ceases.

## 82 INSTRUMENTS AND CONTROLS

---

Daytime running lights offer additional safety when driving in low light conditions when the operator may not normally turn the headlights on. Having headlights on at all times makes the vehicle easier to spot in bad weather, dusk or shade or when there is glare. DRL offers the ability for drivers to give a courtesy flash as a signal when it is safe to merge into another lane on the highway. Turning DRL off temporarily for slowly rolling through weigh stations or when waiting in line to receive bill and weighing tickets is convenient. When the operator presses the DRL override switch, the headlamps will go out if below the DRL speed threshold and flash if above the DRL speed threshold for a designated period of time (customer programmable in VCADS). It is also possible to toggle the headlamps back on if necessary.

- **Engine Brake Switch** – Used to activate the engine brake. Refer to the section in this handbook for more information.
- **Fan Control Manual Override Switch** – Allows the operator to manually control the engine cooling fan.
- **5th Wheel Slide Switch** – Locks and releases a sliding 5th wheel using air pressure; this allows the 5th wheel to be properly positioned. The indicator lamp will illuminate when the 5th wheel is unlocked. Prior to model year 2001, it was necessary to use the trailer Hand Brake Control Lever to activate the 5th wheel slide function. This feature has been changed to make the air slide switch independent of the hand brake control, thereby preventing unexpected 5th wheel slide.
- **Inside/Outside Air Switch** – Allows the operator to choose whether outside air or "under the hood" air is fed into the air cleaner.
- **Load Light Switch** – Press top of the switch in to turn light on. Press bottom of switch to turn light off.
- **Mirror Defrost** – Push the top in to activate mirror defrost.
- **Motorized-Mirror Joy Stick** – This control is designed like a "joy stick." ROTATE the stick to the right to control the right mirror. ROTATE the stick to the left to control the left mirror. PUSH the stick up, down, left or right, as indicated, to correctly position the selected mirror.

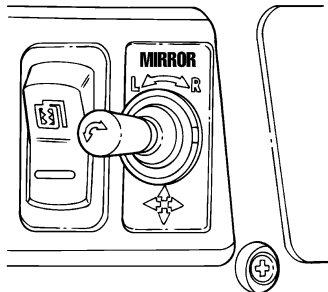

C0029215

- **Power Divider Lockout Switch** – See "Inter-Axle Power Divider Lockout (If Equipped)" in the section of this manual.
- **Power Take-Off Control Switch** — Press the top in to turn the PTO on. Push the bottom in to turn it off.
- **Push Axle Up/Down Switch** — The operator controls the raise and lower functions with the instrument panel-mounted auxiliary axle switch(es), and axle loading is controlled by the air regulators which are located inside the cab between the driver and the rider seats. There is one regulator for each axle.

**Note:** To prevent frame damage, the auxiliary axle(s) will automatically raise when the transmission is shifted into reverse.

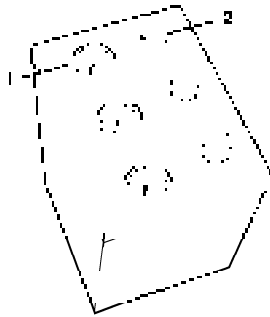

C0029216

|                       |                           |
|-----------------------|---------------------------|
| 1. Air Pressure Gauge | 2. Air Pressure Regulator |
|-----------------------|---------------------------|

- **QUAL COMM Panic Button** — If your vehicle is equipped with this option, refer to the QUAL COMM literature provided with the vehicle.
- **Right-Hand Only Door Lock** — Push the top in to lock the right-hand door.
- **Right-Hand Only Window Lift** — Press the top of the switch to raise the right-hand window. Press bottom of switch to lower right-hand window.
- **Shutdown Override Switch** — Pressing this switch shortly after the vehicle sounds the engine shutdown alarm, allows 30 additional seconds of . The process can be repeated several times to safely park the vehicle.

|   |                                     |
|---|-------------------------------------|
|            | <h2 style="margin: 0;">CAUTION</h2> |
| <p><i>Continuously overriding the shutdown system may result in severe engine damage.</i></p> |                                     |

## 84 INSTRUMENTS AND CONTROLS

---

- **Snow Plow Lamps Switch** — Press the top of the switch to turn on the snow plow lamps if equipped.
- **Spin Light Switch** — Press the top of the switch to activate the rotating beacon light. Push the bottom to turn light off.
- **Strobe Switch** — Press the top of the switch to turn the strobe light on. Push the bottom of the switch to turn light off.
- **Telma Rear Axle Mounted Retarder Indicator Lamp (If Equipped)** — The Telma does not have a disable switch. It is always on and will operate at different levels depending on application of service brake. The indicator will show you the level you are retarding the vehicle: 20%, 40%, 60%, 80% or 100%.

**Note:** The Telma retarder is disabled if there is an ABS event.

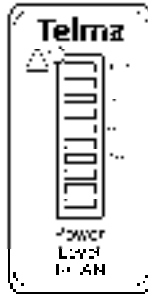

C0029217

- **Vent Fan Switch** — Press switch up to turn vent fan on. Push switch down to turn vent fan off.
- **Windshield Defrost Switch** — Press switch up and release to defrost front windshield.

CAB CLIMATE CONTROL

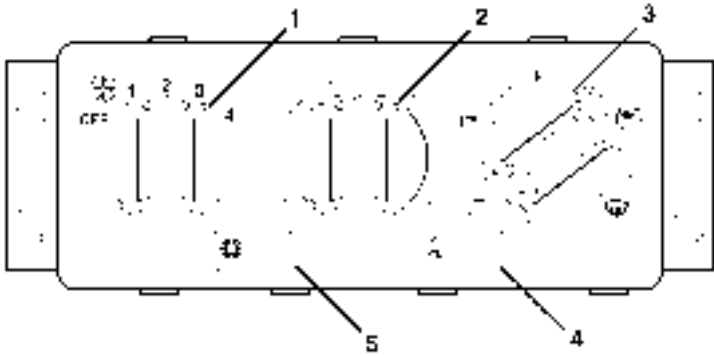

C0029218

|                             |                               |
|-----------------------------|-------------------------------|
| 1. Blower Control Knob      | 4. Fresh/Recirculation Button |
| 2. Temperature Control Knob | 5. A/C ON/OFF Button          |
| 3. Mode Knob                |                               |

**1. Blower Control Knob** — This knob controls fan speed from OFF to 4 (highest speed).

**2. Temperature Control Knob** — Controls the temperature of the air in the cab from COOL (far left) to HOT (far right).

**3. Mode Selection Knob** — Controls the direction of air flow around the cab as follows:



## 86 INSTRUMENTS AND CONTROLS

---

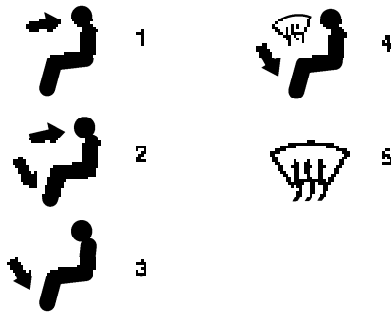

C0029219

1. Directs airflow through the dash panel air vents only.

2. Directs airflow through both the dash panel and floor air vents (bi-level).

3. Directs airflow through the floor vents only.

4. Directs airflow through the floor vents and the windshield for defrosting and/or defogging.

5. Directs airflow only to the windshield for defrosting and/or defogging.

**Note:** The Mode Selection knob can be rotated to any position (see above). This allows the operator to select the desired amount of blend between the positions.

**4. Fresh/Recirculation Switch or Button** — Selects the cab intake air between fresh air (from outside the cab) and recirculated air (inside the cab).

**Note:** For maximum air conditioner performance, select recirculated air.

**5. Air Conditioner ON/OFF Switch or Button** — Activates the air conditioning system.

**Note:** When using the sleeper air conditioner, this switch must be turned ON.

## SLEEPER CLIMATE CONTROL

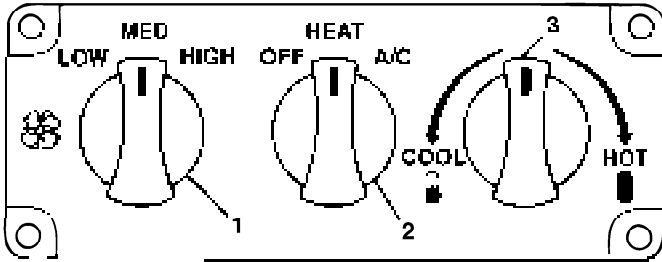

C0029220

- |                        |                             |
|------------------------|-----------------------------|
| 1. Fan Control Knob    | 3. Temperature Control Knob |
| 2. Mode Selection Knob |                             |



**1. Fan Control Knob** — This is a three position knob to control the amount of air delivered through the sleeper box air vents.

**2. Mode Selection Knob** — Allows the operator to choose between OFF, HEAT or A/C.

**3. Temperature Control Knob** — Controls the temperature of the air in the sleeper from COOL (far left) to HOT (far right).

**Note:** When the sleeper mode selection knob is in the OFF position, warm air flows out the sleeper box air vents. As a result, the sleeper may become quite warm and uncomfortable on hot summer days.

To use the sleeper box air conditioner, make sure that the Cab air conditioning unit is activated and the cab fan control switch must be ON (any speed). Then, on the sleeper climate control panel, move the mode selection knob to the A/C position and turn the temperature control knob to COOL.

If the sleeper box becomes too cold and you want to regulate the temperature, the cab air conditioning unit must be activated and the fan switch turned ON to any speed. Then, turn the sleeper mode selection knob to HEAT, then use the temperature control knob to adjust to the desired temperature.

## LIGHT CONTROL PANEL

The light control panel is located on the driver side of the dash. This panel controls the parking lights, interior panel lights, headlights and fog lights (if equipped).

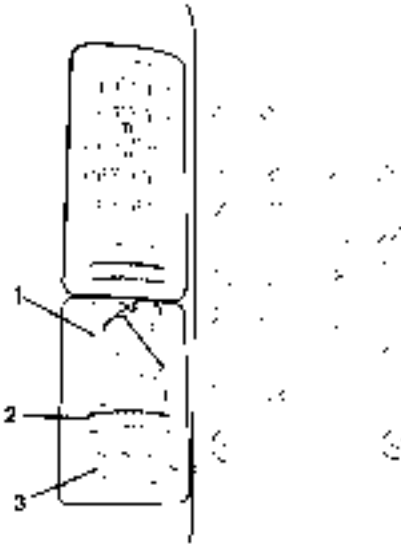

C0029221

### Light Control Panel

- |                                    |  |
|------------------------------------|--|
| 1. Light Control Knob/Pull for Fog | 3. Hook-Up Lamps or Perimeter Lighting (If Equipped) |
| 2. Panel Dimmer Switch             |  |

With the light control knob in the left position, all lights are off. With the knob in the middle position, the parking lights and interior panel lights will illuminate. With the knob in the far right position, the headlights will turn on.

To turn on the fog lights (if equipped), put the knob in the far right position and pull out the fog light button (see Figure above). The fog light symbol will illuminate indicating the lights are on.

To adjust the intensity of the panel light, move the panel dimmer switch back and forth.

To turn on the hook-up lamps or perimeter lighting (if equipped), push the bottom switch to the right.

**LOWER CONSOLE PANEL**

The lower console panel is located under the Cab Climate Control area of the middle dash.

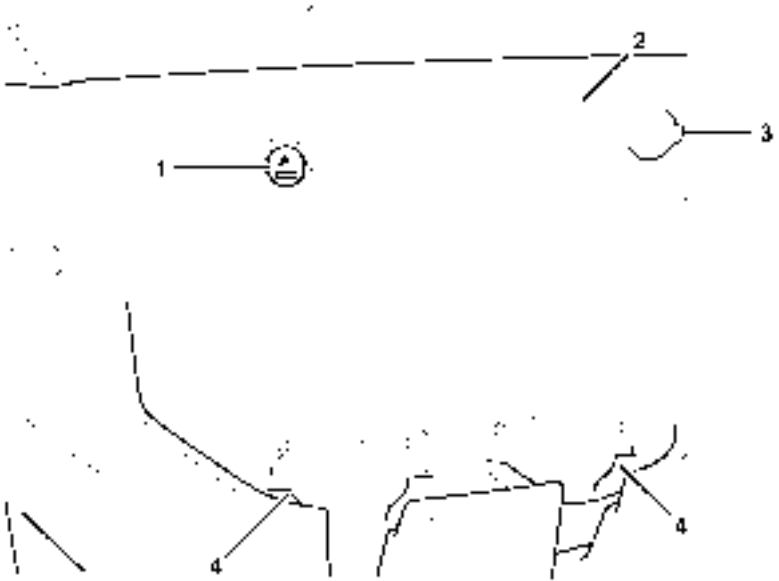

C0029222

|   |   |
|---|---|
| <p>1. Cigar Lighter</p> <p>2. Ashtray</p> | <p>3. Accessory Power Outlet</p> <p>4. Cup Holder</p> |
|---|---|

# 90 INSTRUMENTS AND CONTROLS

## STEERING COLUMN

### Combination Starter and Electrical Switch

The lower console panel is located under the Cab Climate Control area of the middle dash.

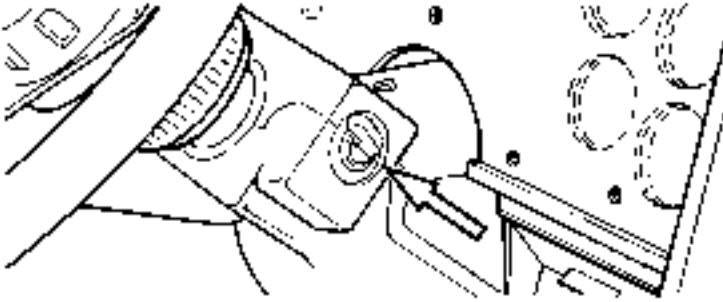

This switch starts the engine (turn the switch clockwise) and activates the accessory relay (turn the switch counterclockwise). When the switch is turned ON (in a clockwise direction), a warning buzzer sounds if air system pressure is below  $448 \pm 34$  kPa ( $65 \pm 5$  psi) or if there is low oil pressure. The buzzer shuts off as soon as sufficient air/oil pressure is restored.

### Steering Wheel Adjustment



#### WARNING

Adjust the steering wheel position **BEFORE** attempting to move the vehicle to avoid losing control of the vehicle.

#### *Adjusting (Tilt and Telescope)*

Push down on the foot pedal located at the left kick panel to adjust the wheel to any position within a pre-defined range. Note that you must continue to hold the pedal down while adjusting. When the adjustment is complete, release the pedal.

## Turn Signal Lever

**Note:** The turn signals are not self-cancelling and must be returned to the middle position manually.

The turn signal lever is located on the steering column. It performs a number of functions, including activating the high and low beams, signal switch and the hazard switch. The signal switch can be used for courtesy flashing of marker lights and for the flashing of high beams.

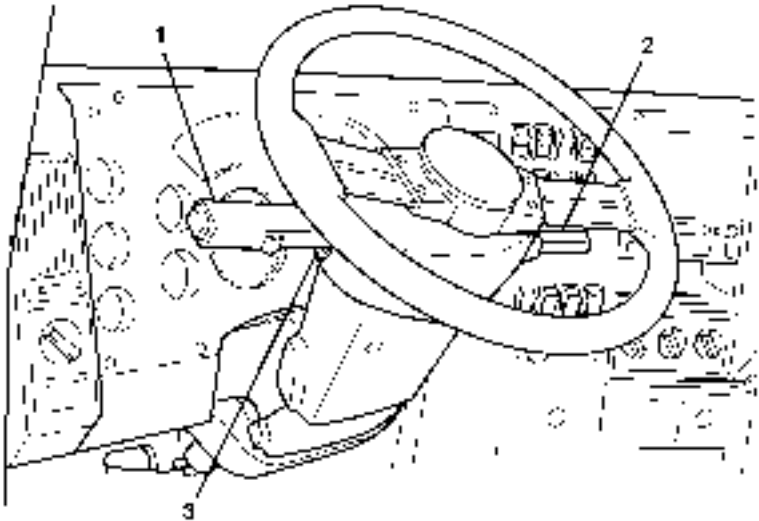

C0029224

|  |                                 |
|--|---------------------------------|
| <p>1. Turn Signal Lever</p> <p>2. Stalk Switch</p> | <p>3. Pull for Hazard (Red)</p> |
|--|---------------------------------|

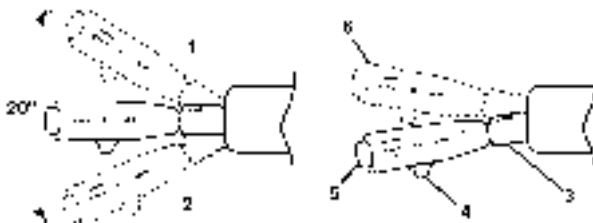

C0029225

## 92 INSTRUMENTS AND CONTROLS

- |  |   |
|--|---|
| 1. Handle in Right Turn Position and Cancel Position of Hazard Warning | 4. Push for Courtesy Flashing of High Beams                       |
| 2. Handle in Left Turn Position and Cancel Position of Hazard Warning  | 5. Push for Courtesy Flashing of Marker Lights (Daylight or Dark) |
| 3. Pull for Warning Hazard Position                                    | 6. Lift Handle for Headlight Dimmer                               |

### Stalk Switch (If Equipped, Co-Pilot® Only)

The stalk switch (Co-Pilot® only) is located on the right side of the steering column and contains three depressible buttons: **ESC**, **Enter** (↵) and **Up & Down**. The stalk switch is used to access, navigate, view and change information available in the driver information display (Co-Pilot® display).

The following illustration shows the stalk switch.

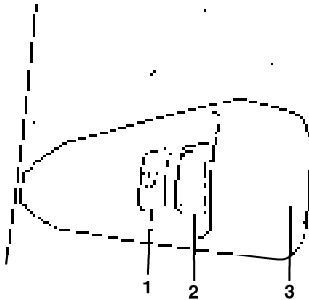

C0029226

- |                 |              |
|-----------------|--------------|
| 1. ESC (Escape) | 3. Up & Down |
| 2. ↵ (Enter)    |              |

#### Navigation of Co-Pilot® Menu

##### ESC BUTTON

The **ESC** (Escape) button on the stalk switch takes the Co-Pilot® back to the previous screen or level in the menu.

**Note:** The **ESC** button does not function at Start Up or when the vehicle is moving. The ESC button is used only when the vehicle is stationary.

##### ENTER (↵) BUTTON

The **Enter** (↵) button on the stalk switch selects the highlighted menu items during menu selection. During Start Up and when moving the vehicle, the **Enter** (↵) button is also used to confirm or acknowledge a pop-up screen.

Sometimes, the **Enter**(↵) button takes the Co-Pilot® back to the previous screen.

## UP & DOWN BUTTONS

The **Up & Down** buttons at the end of the stalk switch allow the user to highlight the various available menu items. Sometimes, these buttons are used to enter information into the displays.

- **Up Button** — Once at the top of the menu items that can be selected, pressing the **Up** button will take the display to the last item in the menu.

For more information on Co-Pilot® display, please refer to the V-MAC® IV Operator's Guide, TS898.

## FLOOR PEDALS

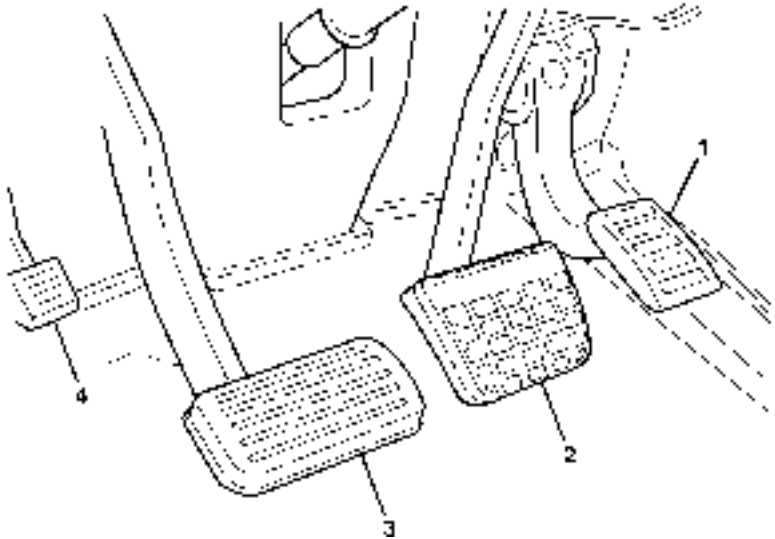

C0029227

- 1. Accelerator Pedal** — Depress to increase engine/vehicle speed; release to decrease engine/vehicle speed.
- 2. Brake Treadle Valve** — Depress to activate the service brakes.
- 3. Clutch Pedal** — Depress to disengage the clutch. The clutch pedal is only found on trucks equipped with manual transmissions.
- 4. Steering Wheel Adjustment Pedal** — Push down on the foot pedal to tilt the wheel to any position between fully tilted up to fully tilted down. You must hold the pedal down while adjusting. When the adjustment is complete, release the pedal.



## MISCELLANEOUS CONTROLS

### Dome Light

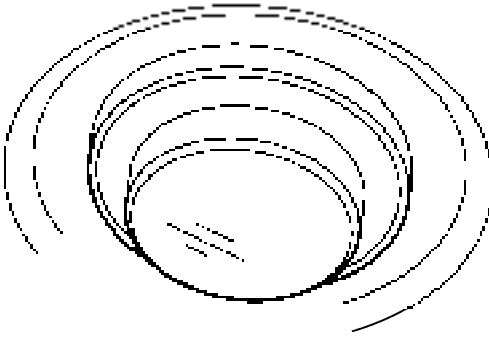

C0029228

### Dome Light



C0029229

### Driver Side Switch



C0029230

### Passenger Side Switch

With the switch in the bottom position on the driver side and on the passenger side, the dome light will come on when the cab door is opened and go off when it is closed. Push the switch up to turn the dome light on when the doors are closed for either the driver side or the passenger side. Depress the CAB switch above the driver up when doors are closed to turn both dome lights on.

## Interior Cab Lights (Sleeper Cab)

Various interior cab lights are activated using the rocker switches located in the headliner.

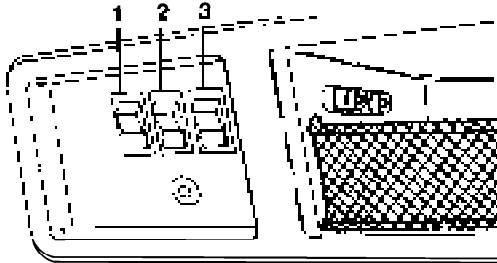

C0029231

### Driver Side

1. Map Light Switch Activates the map lights (which are located in the headliner, to the left of sun visor).

2. Dome Light Switch Activates the dome lights.

3. Sleeper Light Switch Activates the sleeper ceiling lights.

## Air Horn

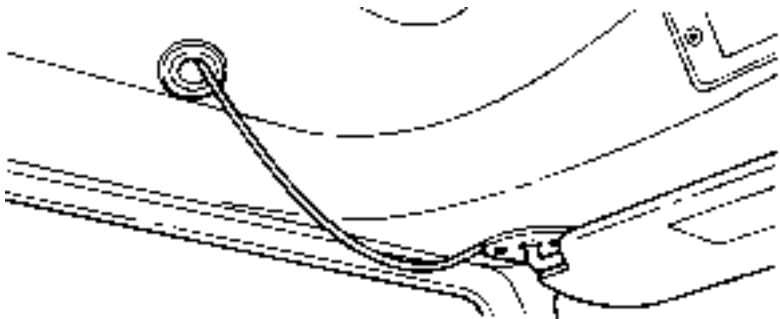

C0029232

The air horn(s), if equipped, is activated by pulling down on the cord that is located above the driver near the overhead console.

### Fresh Air Vent

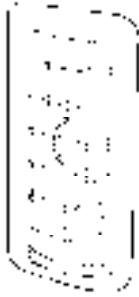

C0029233

An air vent is provided to circulate outside air to the cab interior. Move the vent lever to the left or right to open the vent. Move the lever to the left to close the vent.

On chassis equipped with a sleeper cab, there is an air vent located on either side of the bunk. Pull handle to the left or to the right (depending on what side of the cab you are on) to open the vent.

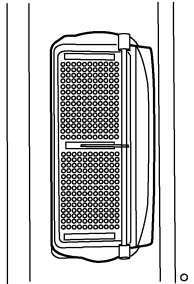

C0029234

## Cab Air Filter

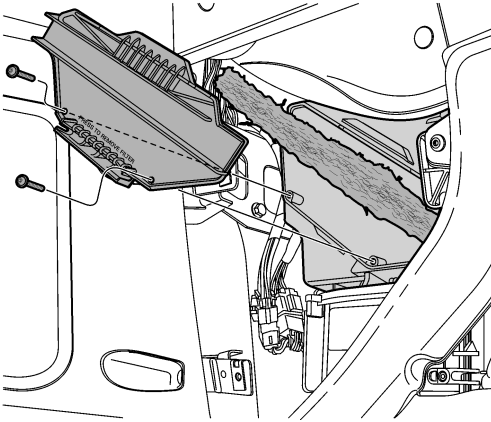

W8056454

---

To provide comfortable and clean fresh air in the cab, the heating and air conditioning system is designed with a replaceable filter.

Under normal operating conditions the filter should be replaced every 6 months to ensure the efficiency of the heating and air conditioning system. Failure to replace the filter may cause damage to heater/AC components.

**Note:** Dusty conditions may require more frequent replacement.

### Microphone



C0029235

#### Microphone

The microphone is located above the driver in the headliner. It is available on the Mid-Level radio with Blue Tooth/Hands free option. This is what is used to talk into when the phone is connected to the truck. For more information on the microphone, please refer to the Radio Manual that is supplied with the vehicle.

## Accessory Power Outlets

Additional 12-volt accessory power outlets are located next to the driver on the "E" panel. These cigar light-type outlets supply 12 volts of fused (20A) power when the ignition switch is turned to the ignition or accessory position.

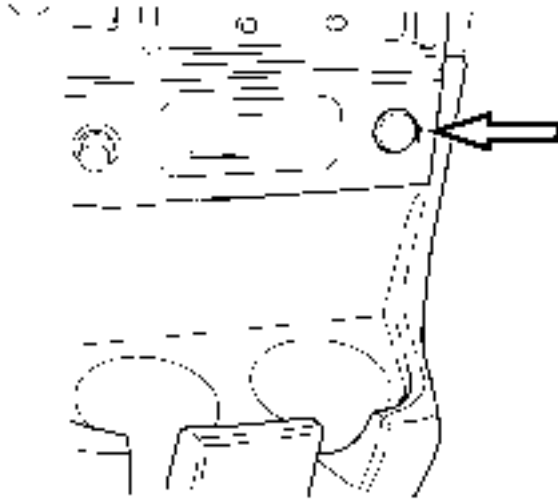

C0029236

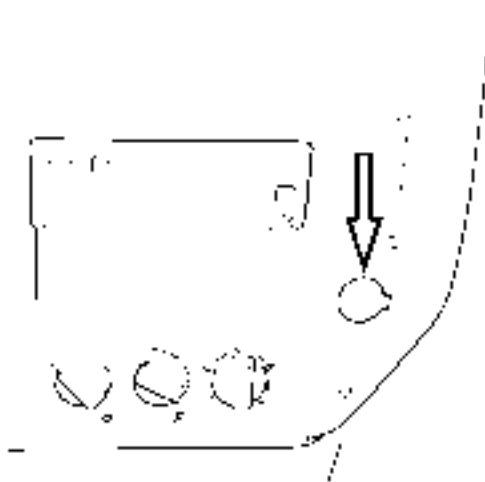

C0029238

On chassis equipped with a sleeper cab, there are also additional power outlets located above the bunk.

# 100 INSTRUMENTS AND CONTROLS

---

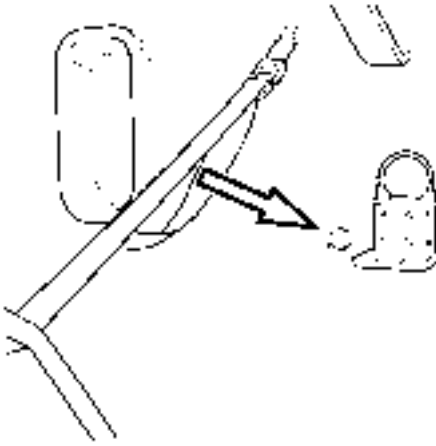

C0029239



## CAUTION

*Maximum amperage for all power receptacles in cab is 20 amps. Do NOT exceed maximum amperage as equipment damage may result.*

### ***CB Radio Power Jack (+) Located in Headliner on Sleeper Cab; on Dashboard in Day Cab (Red)***

This is a 12-volt, switched battery connection. It is used to power the vehicle's CB radio. It is protected by a 15-amp circuit breaker and supplies power when the key is in the ACCESSORY position or ON position.

### ***CB Radio Power Jack (-) Located in Headliner on Sleeper Cab; on Dashboard in Day Cab (Black)***

This is a ground connection. It is used as a power return (-) connection for the vehicle's CB radio.

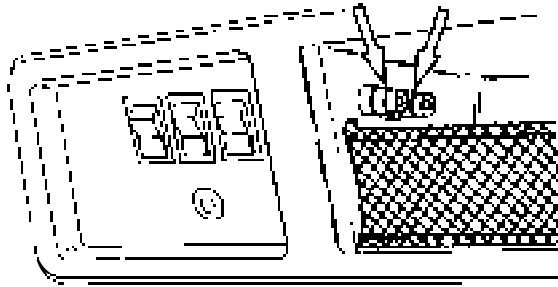

C0029240

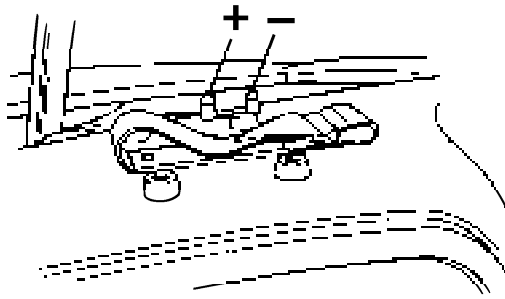

C0029241



## PRE-TRIP INSPECTION AND DAILY MAINTENANCE



### DANGER

*Before working on or inspecting a vehicle, set the parking brakes, place the transmission in neutral and block the wheels. Failure to do so can result in unexpected vehicle movement and can cause serious personal injury or death.*

Safety is the most important and obvious reason for doing a pre-trip inspection. Federal and state laws require inspection performed by the driver. Federal and state inspectors also inspect commercial vehicles. An unsafe vehicle can be placed "out of service" until the driver or owner corrects the deficiency. Owners and operators should familiarize themselves with sections 49 CFR 396.11 and 396.13 concerning Federal requirements for vehicle inspection. Certain other laws may also apply.

Section 49 CFR 396.13 states that all motor carrier drivers must complete a written report at the end of each work day for each vehicle operated, covering most of what is covered in the pre-trip list. The report should list all defects or deficiencies discovered by the driver. A pre-trip inspection prepares for the end-of-work report.

Starting on the next page are suggested guidelines to be used in performing truck, tractor and trailer pre-trip inspections. Depending on the application of the vehicle being used, these guidelines should be modified to include other necessary inspection points. For example, steps and grab handles should be checked daily on refuse trucks because the operator is getting in and out of the cab more frequently.

If any component or system does not pass this inspection, it must be corrected before operating the vehicle. Whenever equipment requires adjustment, replacement, repair or lubrication, refer to the Service Manuals or contact an authorized Mack Truck dealer for the correct procedures, specifications and intervals.

Take your time going through the pre-trip inspection. Remember that a careful pre-trip inspection saves time by eliminating unscheduled stops for correcting a faulty item.

The following information has been provided by the American Trucking Association as developed by the D.O.T. Office of Motor Carriers (BMCS).

---

## Pre-Trip Inspection Quick List

Inspect the vehicle in a circular manner.

### ***Approaching the Vehicle***

- Check under the vehicle for oil, fuel, coolant leaks or other signs of damage.
- Check body surfaces for signs of breaks or damage.

### ***Preparation***

- Open drain cocks on air tanks to let the tanks drain.
- Chock wheels on vehicle and, if hooked up, trailer.
- Close air tank drain cocks.
- Start the engine and let the air pressure build up to normal. Stop engine.
- Switch on parking lights and hazard lights.
- Apply parking brakes.
- Pull the hood release lever or release the hood latches, raise hood.

### ***Step 1: Left Side of the Cab***

#### **Left Front Wheel**

- Check condition of wheel rim. Especially look for cracks, missing lockrings, bent or broken studs, clamps or lugs.
- Check condition of tire: properly inflated, no serious cuts, bulges, tread wear or any signs of misalignment; valve stem not touching wheel, rim or brake drum; valve cap in place.
- Check wheel bearing and hub: no obvious leaking on outside or inside wheel. Verify correct oil level in hub.

#### **Left Front Suspension**

- Check condition of spring, spring hangers, shackles, U-bolts: no cracks, breaks or shifting.
- Check shock absorber condition.

## **Left Front Brake**

- Condition of brake drum. With brakes released, look for a noticeable gap between lining and drum. (This check cannot be made if dust covers are in place.)
- Condition of brake air hose.
- Check brake chamber mounting bolts and bracket.

## **Condition of Front Axle and Steering System, Left Side**

- No loose, worn, bent, damaged or missing parts.

## **Under Hood, Left Side**

- Check coolant hose condition.
- Check condition of fan drive belts.
- Check engine and surrounding areas for coolant, oil and fuel leaks.
- Check wiring harnesses for signs of damage.

## **Step 2: Front of Cab Area**

### **Condition of Windshield**

- Check for damage and clean if dirty.
- Check windshield wiper arms for proper spring tension.
- Check wiper blades for any damage, "dead" rubber and attachment to arm.

### **Lights and Reflectors**

- Lower hood and inspect parking, clearance and identification lights on hood and cab. They should be clean and of the proper color.
- Reflectors clean and proper color.
- Left and right front turn signal lights and headlights clean and proper color. Raise hood.

### **Grille**

- Check that charge air cooler and radiator or bugscreens are clean and undamaged.

---

### **Step 3: Right Side of Cab Area**

#### **Right Front Wheel**

- Check condition of wheel rim. Especially look for cracks, missing lockrings, bent or broken studs, clamps or lugs.
- Check condition of tire: properly inflated, no serious cuts, bulges, tread wear or any signs of misalignment; valve stem not touching wheel, rim or brake drum; valve cap in place.
- Check wheel bearing and hub: no obvious leaking on outside or inside wheel. Verify correct oil level in hub.

#### **Right Front Suspension**

- Check condition of spring, spring hangers, shackles, U-bolts: no cracks, breaks or shifting.
- Shock absorber condition.

#### **Right Front Brake**

- Condition of brake drum. With brakes released, look for a noticeable gap between lining and drum. (This check cannot be made if dust covers are in place.)
- Condition of brake air hose: check for any chafing.
- Check brake chamber mounting bolts and bracket.
- With brakes applied or released, look for conspicuously different positions of the slack adjusters.

#### **Condition of Front Axle and Steering System, Right Side**

- No loose, worn, bent, damaged or missing parts.

#### **Under Hood, Right Side**

- Check condition of coolant and heater hoses.
- Check condition of fan drive belts.
- Check engine and surrounding areas for coolant, oil and fuel leaks.
- Check fuel separator sight glass and drain if necessary. Check for leaks.
- Check wiring harnesses for signs of damage.
- Check air filter with brackets and hoses for loose connections or damage. Check filter gauge, if mounted on the filter.

## ***Step 4: Right Saddle Tank Area***

### **Right Fuel Tank(s)**

- Securely mounted and not damaged or leaking.
- Fuel lines secure and not leaking. Check that shut-off valves are open.
- Tank(s) full of fuel. Cap on and secure.

### **Condition of Visible Components**

- Rear of engine: not leaking.
- Transmission: not leaking. If equipped with oil cooler, check cooler, hoses and fittings for leaks.
- Check drive shaft.
- Exhaust system: secure, not leaking, not touching wires, fuel or air tubing.
- Frame and cross members: no bends, cracks or breaks.
- Air tubing and electrical wiring: secured against snagging and chafing.

## ***Step 5: Right Rear Vehicle Area***

### **Dual Wheels, One or Two Axles**

- Check condition of wheels and rims. Especially look for cracks, missing lockrings, bent or broken spacers, studs, clamps or lugs.
- Check condition of tires: properly inflated, no serious cuts, bulges, tread wear or any signs of misalignment; valve stems not touching wheels, rims or brake drums; valve caps in place and no objects stuck between the wheels.
- Check that both tires are of same type, for example, not mixed radial and bias type and that their circumferences are matched.
- Check wheel bearing and hub: no obvious leaking on outside or inside wheel.

### **Suspension**

- Check condition of springs (leaf or air), spring hangers, shackles and U-bolts.
- Axle alignment.

---

## **Brakes**

- Condition of brake drums. With brakes released, look for a noticeable gap between lining and drum. (This check cannot be made if dust covers are in place.)
- Condition of brake hoses: check for any chafing.
- Check brake chamber mounting bolts and brackets.
- With brakes applied or released, look for conspicuously different positions of the slack adjusters.

### ***Step 6: Rear of Vehicle Area***

#### **Frame Area**

- Frame or cross members not bent, cracked or otherwise damaged or missing.
- Check that air tubing and electrical lines are properly secured to the frame with no damage or chafing.

#### **Lights and Reflectors**

- Tail lights, brake lights and turn signal lights: clean and proper color.

### ***Step 7: Coupling System Area***

#### **Fifth Wheel**

- Securely mounted to the frame.
- No missing or damaged parts.
- Check that trunnion and plate are properly lubricated.

#### **Sliding Fifth Wheel**

- Mechanism not worn, bent, damaged or parts missing.
- Properly lubricated.
- All locking pins present and locked in place.
- If air operated: no air leaks.

#### **Air Tubing and Electric Lines Visible From This Point**

- Should be secure from dangling.
- Both air lines and electric line should be free from damage, oil and grease.

## **Step 8: Left Saddle Tank and Left Rear Vehicle Wheels Area**

### **Dual Wheels, One or Two Axles**

- Check condition of wheels and rims. Especially look for cracks, missing lockrings, bent or broken spacers, studs, clamps or lugs.
- Check condition of tires: properly inflated, no serious cuts, bulges, tread wear or any signs of misalignment; valve stems not touching wheels, rims or brake drums; valve caps in place and no objects stuck between the wheels.
- Check that both tires are of same type, for example, not mixed radial and bias type and that their circumferences are matched.
- Check wheel bearing and hub: no obvious leaking on outside or inside wheel.

### **Suspension**

- Check condition of springs (leaf or air), spring hangers, shackles and U-bolts, no cracks, breaks or shifting.

### **Brakes**

- Condition of brake drums. With brakes released, look for a noticeable gap between lining and drum. (This check cannot be made if dust covers are in place.)
- Condition of brake hoses: check for any chafing.
- Check brake chamber mounting bolts and brackets.
- With brakes applied or released, look for conspicuously different positions of the slack adjusters.

### **Condition of Visible Components**

- Transmission: not leaking.
- Drive shaft: looks OK.
- Exhaust system: secure, not leaking, not touching wires, fuel or air tubing.
- Frame and cross members: no bends, cracks or breaks.
- Air tubing and electrical wiring: secured against snagging and chafing.

---

**Left Fuel Tank(s)**

- Securely mounted and not damaged or leaking.
- Fuel lines secure and not leaking. Check that shut-off valves are open.
- Tank(s) full of fuel. Cap on and secure.

**Battery Area**

- Open the battery box. Battery box securely mounted to vehicle.
- Batteries secured against movement.
- Battery cases not broken or leaking. Battery cables free from damage.
- Tops of batteries and terminals clean and free from foreign material.
- If equipped, replace battery lid and make sure it is securely fastened.

**Step 9: Trailer Front Area****Air and Electrical Connections**

- Glad hands properly mounted, free from damage and not leaking.
- Trailer cord receptacle properly mounted, free of damage; plug properly seated and safety catch engaged to prevent accidental disconnect.
- Air and electrical lines properly secured against tangling, snagging and chafing with sufficient slack for turns.

**Hooking Up To Trailer****Hook-Up Preparation**

- Check kingpin and mounting plate on trailer, free from wear, bends or damage.
- Chock trailer wheels.

**Fifth Wheel or Trailer Hitch**

- No visible space between fifth wheel and trailer.
- Locking jaws around the shank and not the head of kingpin.
- Release lever properly seated and safety latch/lock engaged.
- Check all connections to dolly or trailer hitch and safety chains are secured.
- Check function of trailer air supply valve and trailer brakes.



## **Sliding Fifth Wheel**

- Check that fifth wheel is not so far forward that the tractor frame will strike the landing gear during turns.

**Note:** Refer to the trailer manufacturer's manual for specific information on the trailer checks.

## ***Step 10: Right Side of Trailer Area***

### **Landing Gear or Dolly Area**

- Fully raised; no missing or damaged parts.
- Crank handle present and secured.
- If power operated, no air/hydraulic leaks.

### **Spare Wheel(s)**

- Carrier or rack not damaged.
- Spare wheel securely mounted in rack.
- Tire and wheel condition adequate for a spare: proper size, properly inflated.

### **Lights and Reflectors**

- Trailer side clearance lights: clean, operating and proper color.
- Reflectors clean and proper color.

### **Frame and Body**

- Frame and crossmembers not bent, cracked, damaged or missing.
- Proper placarding.
- Body parts not damaged or missing.

## ***Step 11: Right Rear Trailer Wheel***

### **Dual Wheels, One or Two Axles**

- Check condition of wheels and rims. Especially look for cracks, missing lockrings, bent or broken spacers, studs, clamps or lugs.
- Check condition of tires: properly inflated, no serious cuts, bulges, tread wear or any signs of misalignment; valve stems not touching wheels, rims or brake drums; valve caps in place and no objects stuck between the wheels.

- 
- Check that both tires are of same type, for example, not mixed radial and bias type and that their circumferences are matched.
  - Check wheel bearing and hub: no obvious leaking on outside or inside wheel.

### **Suspension**

- Condition of springs (leaf or air), spring hangers, shackles and U-bolts.
- Axle alignment.
- Condition of torque rod arms.
- If equipped with sliding axles, check position and alignment. Look for damaged, worn or missing parts, all locks present, fully in place and locked.
- Flexible air tubing not cracked, cut, crimped or otherwise damaged. Secured against tangling, dragging and chafing.

### **Brakes**

- Condition of brake drums. With brakes released, look for a noticeable gap between lining and drum. (This check cannot be made if dust covers are in place.)
- Condition of brake hoses: check for any chafing.
- Check brake chamber mounting bolts and brackets.
- With brakes applied or released, look for conspicuously different positions of the slack adjusters.

### **Step 12: Rear of Trailer Area**

#### **Lights and Reflectors**

- Rear clearance, identification and tail lights clean and proper color.
- Reflectors clean and proper color.

#### **Cargo Securement**

- Cargo properly blocked, braced, tied, chained, etc.
- Tailboard up and properly secured. End gates free from damage, properly secured in stake pockets.
- Canvas or tarp (if required) properly latched down to prevent water damage, tearing, billowing or blockage of either mirrors or tail lights.
- Rear doors securely closed, latched or locked; required security seals in place.

- Underside guard in place: not cracked, bent or broken.

## ***Step 13: Left Rear Trailer Wheels Area***

### **Dual Wheels, One or Two Axles**

- Check condition of wheels and rims. Especially look for cracks, lockrings missing, bent or broken spacers, studs, clamps or lugs.
- Check condition of tires: properly inflated, no serious cuts, bulges, tread wear or any signs of misalignment; valve stems not touching wheels, rims or brake drums; valve caps in place and no objects stuck between the wheels.
- Check that both tires are of same type, for example, not mixed radial and bias type and that their circumferences are matched.
- Check wheel bearing and hub: no obvious leaking on outside or inside wheel.

### **Suspension**

- Condition of springs (leaf or air), spring hangers, shackles and U-bolts.
- Axle alignment.
- Condition of torque rod arms.
- If equipped with sliding axles, check position and alignment. Look for damaged, worn or missing parts, all locks present, fully in place and locked.
- Flexible air tubing not cracked, cut, crimped or otherwise damaged. It should be secured against tangling, dragging and chafing.

### **Brakes**

- Condition of brake drums. With brakes released, look for a noticeable gap between lining and drum. (This check can not be made if dust covers are in place.)
- Condition of brake hoses: check for any chafing.
- Check brake chamber mounting bolts and brackets.
- With brakes applied or released, look for conspicuously different positions of the slack adjusters.

## ***Step 14: Left Side of Trailer Area***

### **Landing Gear or Dolly Area**

- Fully raised; no missing or damaged parts.
- Crank handle present and secured.

- 
- If power operated, no air/hydraulic leaks.

### **Spare Wheel(s)**

- Spare wheel securely mounted in rack with no damage to rack.
- Tire and wheel condition adequate for a spare: proper size, properly inflated.

### **Lights and Reflectors**

- Trailer side clearance lights: clean, operating and proper color.
- Reflectors clean and proper color.

### **Frame and Body**

- Frame and crossmembers not bent, cracked, damaged or missing.
- Proper placarding.
- Body parts not damaged or missing.

### ***Step 15: In the Cab***

- Check steps and grab handles for looseness or breakage. Also, clean them if there is any substance that makes them slippery, which makes cab entry/exit hazardous.
- Start the engine. If equipped, check that exhaust rain cap opens when accelerating engine.
- Check gauges and tell-tale light function. See the Instruments and Controls section.
- Check headlights, tail lights, brake lights, emergency flashers and turn signal lights for proper operation, cleanliness and proper color.
- Check function of low air warning.
- Check clutch function. If equipped, check for clutch brake function.
- Check windshield wipers and washers and horns, including back-up alarm, if equipped.
- Clean inside windshield, door windows and instruments. Clean mirrors.
- Check temperature control and defroster. If equipped, check mirror heater.
- Check condition of warning triangles, fire extinguisher and flares.
- Adjust the seat. Check mirror adjustment.
- Check safety belts for function and damage.

- Apply service brakes. After initial drop, pressure should hold steady, or increase slightly, with engine at idle.
- Check slack adjusters and chamber pushrod travel.
- Check steering wheel for excessive free play.
- Check for loose items in the cab. Secure them if necessary.

### **Step 16: Before Leaving the Parking Area**

- Remove chocks from the wheels.
- Test trailer hook-up by slowly pulling while applying the trailer brakes with the trailer brake hand control valve.
- Test the service brakes before leaving the parking area.
- Test parking brakes by stopping on a 20% grade and applying the parking brakes. The parking brakes shall hold the combined vehicle and trailer without moving.

## **New Vehicle Break-In**

To ensure many years of reliable, trouble-free , the following break-in procedures are recommended:

**Note:** Oil change, filter change and chassis lubrication are no longer required at the 4,828 km (3,000-mile ) vehicle break-in interval.

Refer to the preventive maintenance schedules outlined in the *Maintenance and Lubrication Manual (21394653)* for recommended lubrication change intervals for the following items:

- Gear oils (transmission, rear axle carrier[s], front drive axle carrier, transfer case, flywheel PTO)
- Engine oil
- Oil filters
- Fuel filters
- Coolant conditioner

**Note:** It is important that components be filled with lubricants meeting the specifications as given in the *Maintenance and Lubrication Manual (21394653)*

**Note:** When checking oil levels, the vehicle must be parked on level ground, and the units at normal operating temperature. Components must be filled to the correct level. DO NOT OVERFILL.

---

**Note:** Oil and filter change intervals in this manual pertain to components built by Mack Trucks, Inc. For information concerning oil and oil filter change intervals for vendor components, refer to the specific vendor component service literature.

### ***During the First 5000 Kilometers (3000 Miles)***

- After the first 200 km (125 miles), retorque the wheel nuts using an accurately calibrated torque wrench. Recheck this torque again after 800 km (500 miles).
- Check oil and coolant levels frequently.
- Check brake and clutch adjustments per recommended maintenance schedule, and adjust as needed.
- Observe the instruments often, and shut down the engine at the first sign of any abnormal readings.
- Report all leaks, loose fasteners, unusual noises, etc., to the service representative at the nearest Mack dealership so they can be checked and corrected.
- Check the spring clip torque (U-bolts). (On REYCO suspensions, also check equalizer nut torque.)
- On chassis equipped with AIRTEK™ front axle air suspensions, retorque the U-bolts.
- Check the U-bolt torque on the MACK air suspension at the end of the first 1600 km (1000 miles).

### ***After the First 5000 Kilometers (3000 Miles) or Before 6400 Kilometers (4000 Miles) or Before 3 to 4 Months***

- Retorque the spring clip (U-bolts). (On REYCO suspensions, also retorque the equalizer nut.)

**Note:** On chassis equipped with AIRTEK™ front axle air suspensions, check the torque of the front axle U-bolts at 24 000 kilometers (15,000 miles).

### ***At the First A Inspection Interval***

- Check front and rear axle alignment and adjust if the alignment is out of specifications.
- Check steering knuckle to axle beam clearance.

Although this quality-built vehicle has been inspected, lubricated and adjusted at the MACK Trucks Assembly Plant, an occasional air, oil or coolant leak may develop. Quick action to correct these minor items will prevent a major repair later. Take the vehicle to the nearest MACK service center as soon as any abnormal condition becomes evident.

<https://www.truck-manuals.net/mack/>

## ***Initial Valve Adjustment Intervals***

Refer to the *Maintenance and Lubrication Manual (21394653)* for detailed information concerning the Initial Valve Adjustment Interval.

---

## WINDSHIELD WASHER RESERVOIR

As shown in the drawing below, the windshield washer reservoir is located under the hood, against the rider-side cab bulkhead.

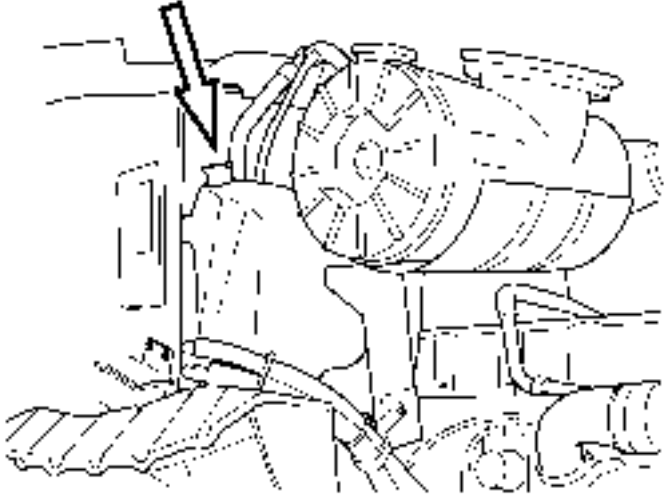

C0029314



## HOOD

### Opening the Hood

To open the hood, release the locking tabs on each side of the hood.

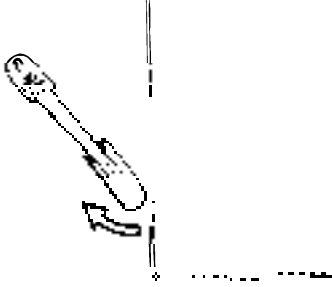

C0029315

1. With the hood in the locked position, pull outward on the plastic handle and disengage the locking tab from the hood latch.
2. Swing the rubber strap up and out of the way.
3. Repeat this procedure on the other side of the hood.

**Note:** When the hood is opened, the safety latch will drop down into the locked position.

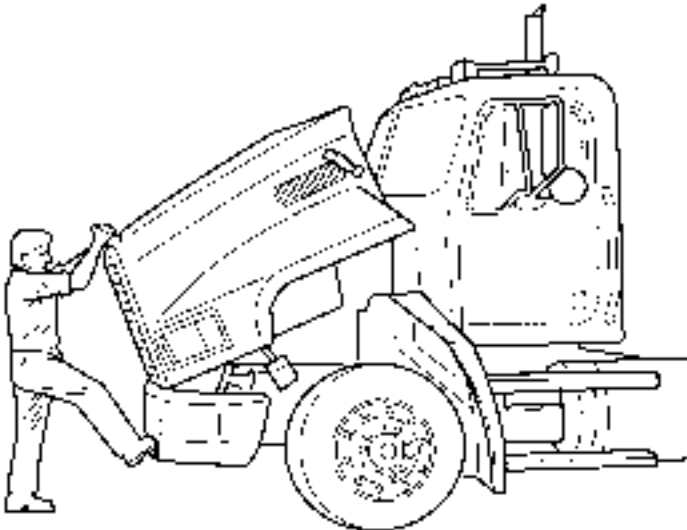

C0029316

4. Using the Bulldog as a handle, pull on the hood to raise it over the engine. You may put one foot on the bumper if necessary.
5. Pull steadily on the hood until it comes over the center and stops fully open.

**WARNING**

**NEVER take both feet off the ground to tilt the hood. Keep at least one foot on the ground to avoid a slip or fall. If it is difficult for you to raise the hood, get the help of someone who can lift from the rear of the hood.**

**WARNING**

**Little effort is required to open or close the hood. NEVER take both feet off the ground to tilt the hood. Keep at least one foot on the ground to avoid a slip or fall.**

## Closing the Hood

**Note:** Remember to remove all tools, rags and test equipment from the engine compartment before closing the hood.



### WARNING

**Before closing the hood, be sure no one is in the way of the hood's descent.**

**Note:** The safety latch must be released (reset) before the hood will close. (See arrow in illustration.)

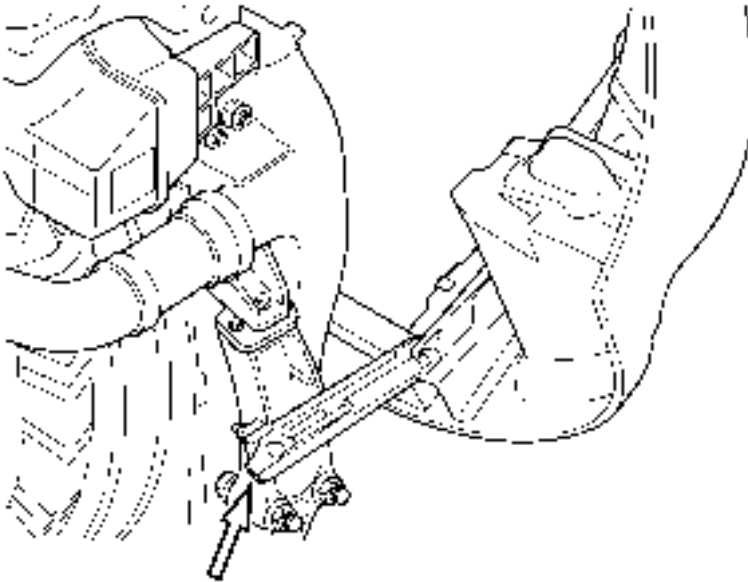

C0029317

## Locking the Hood

To lock the hood, secure the rubber hold-down straps on each side of the hood.

1. With the hood down, set the rubber strap in position and force the locking discs into the hood latch.
2. Push inward on the plastic handle to lock the rubber strap in place.
3. Repeat this procedure on the other side of the hood.

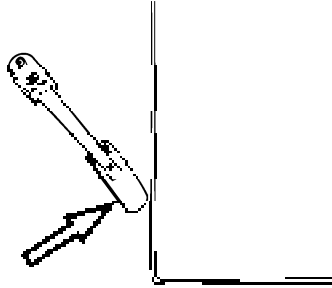

C0029318



### CAUTION

*Be sure the hood is latched securely. If the latch is not completely engaged, the hood could open during and cause vehicle damage.*

## HOSE TENDERS

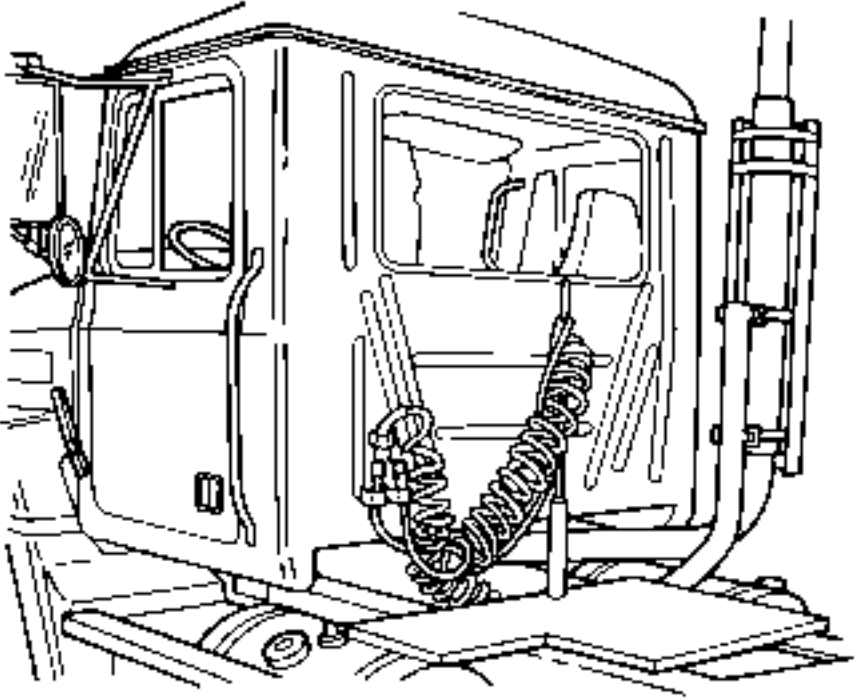

C0029319



### CAUTION

*Avoid loose hoses. Air lines and tractor-to-trailer electrical connections must be secured to the tractor hose tenders (hose hanger, towel bar, pogo stick, etc.) to prevent them from tangling in the driveline.*

## DOORS

### Standard Door Panel

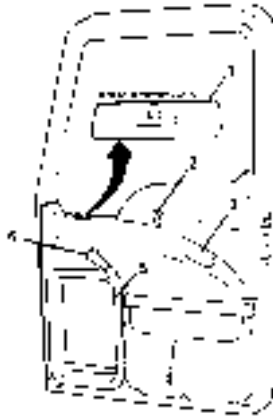

C0029320

#### Manual Locks and Windows — Passenger Side (Right) Shown

|                     |  |
|---------------------|--|
| 1. Manual Door Lock | 4. Storage Pouch                           |
| 2. Door Handle      | 5. Lower View Window (Passenger Side Only) |
| 3. Door Light       | 6. Window Crank                            |

**1. Manual Door Lock** — Push backward to lock. Push forward to unlock. The lock opening appears red when unlocked.

**2. Door Handle** — Lift handle to open.

**3. Door Light** — The door light automatically comes on when the door is opened and goes out when the door is closed.

**4. Storage Pouch** — Large, rigid storage pouch.

**5. Lower View Window** — Provides safe viewing of low lying obstacles on construction sites.

**6. Window Crank** — Turn counterclockwise to open, clockwise to close.

## Power Door Panel (Optional)

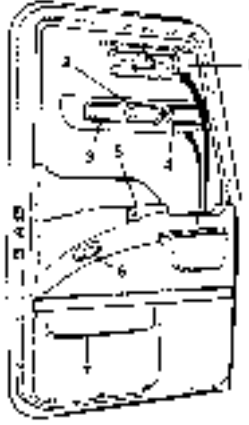

C0029322

### Power Locks and Windows — Driver Side (Left) Shown

|                                    |                  |
|------------------------------------|------------------|
| 1. Manual Door Lock                | 5. Door Handle   |
| 2. Left Side Power Window Control  | 6. Door Light    |
| 3. Right Side Power Window Control | 7. Storage Pouch |
| 4. Power Door Lock                 |                  |

**1. Manual Door Lock** — Push backward to lock. Push forward to unlock. The lock opening appears red when unlocked.

**2. Left Side Power Window Control** — Push back of switch for DOWN, front of switch for UP.

**3. Right Side Power Window Control** — Push back of switch for DOWN, front of switch for UP.

**4. Power Door Lock** — Push back of switch to lock, front of switch to unlock. The power lock controls both doors.

**Note:** The right side (passenger) door has a power control for the right side window only.

**5. Door Handle** — Lift handle to open.

**6. Door Light** — The door light automatically comes on when the door is opened and goes out when the door is closed.

**7. Storage Pouch** — Large, rigid storage pouch.

---

## Opening the Cab Door

To open the door, grasp the front of the door handle and pull upward.

## Locking the Cab Door

The doors can be locked using the manual door lock (item 1 in the illustration) or a power door lock switch (item 4 in the illustration).

Power door lock switches (on both sides of the cab) lock and unlock both cab doors at the same time. To lock the doors, push the rear of the rocker switch. To unlock the doors, push the front of the rocker switch.

To lock with the door open, push the lock lever forward and release. The lock lever will return to the home position and the door will be locked when closed. To unlock, pull the paddle and open the door.



### WARNING

**Always lock the doors while driving. This will lessen the chance of personal injury. Locking the doors helps prevent the occupants from being ejected from the vehicle in the event of an accident.**

## Power Window Regulators

To open the windows, push and hold the rear of the rocker switch (item 3 in the illustration). To close the windows, push and hold the front of the rocker switch. Release the rocker switch to stop the window at the desired position.



## REMOTE KEYLESS ENTRY — (OPTIONAL)

This vehicle is equipped with a Remote Keyless Entry system. This system operates by means of a hand-held remote control that locks and unlocks the cab doors.

The remote control door lock transmitters are supplied in pairs; each one is attached to a key ring.

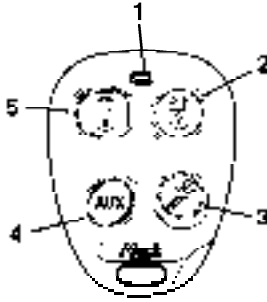

C0029323

1. LED

2. Press once to unlock driver side door. Press twice to unlock both doors.

3. Press and hold for 3 seconds to activate panic mode. Press and hold for 3 seconds again to cancel panic mode.

4. Press and hold for 0.5 second to turn external lights on or off.

5. Press once to lock doors. Press twice for horn confirmation.

Each transmitter is powered by a 3-volt battery and is water resistant. Information concerning battery replacement, troubleshooting and programming the transmitters is provided in this section.

The receiver in the vehicle is capable of recognizing four transmitters. Replacement transmitters are available; however, they must be programmed to match the specific receiver (refer to the "Programming the Transmitter" section).

---

## Transmitter Operations

The door transmitter has four buttons (labeled LOCK, UNLOCK, AUX and HORN) to control of the system. When any of the buttons is pressed, a coded Ultra-high frequency (UHF) radio signal is transmitted to the receiver in the vehicle.

The transmitter must be within approximately 10 meters (33 feet) of the vehicle for the receiver to detect the coded signal. The Remote Keyless Entry system has no affect on the normal of the power door locks.

When the LOCK button is pressed, the doors will lock and the lights will flash once indicating that the doors are locked. The dome light will be on for 5 seconds upon locking the door by remote. For audible confirmation of the door lock, press the LOCK button a second time and the horn will beep once to confirm the doors are locked.

When the UNLOCK button is pressed once, the drivers door will unlock and the lights will flash twice indicating that the door is unlocked. The dome light will be on for 30 seconds upon unlocking the door by remote. Pushing the UNLOCK button a second time within 3 seconds will unlock both doors.

**Note:** If AUTO RE-ARM feature is selected, the keyless entry system will automatically re-arm itself 60 seconds after the doors are unlocked with remote transmitter. Automatic re-arm will cancel if any door is opened before the 60 seconds timer has elapsed.

Press and hold the AUX button on the transmitter for 0.5 second to turn perimeter or trailer access lights "On" or "Off" (if equipped).

Press and hold the HORN button on the transmitter for 3 seconds. The horn will immediately sound and running lights will flash. During panic mode, the normal function of this transmitter button will be suspended. LOCK and UNLOCK buttons cannot be used to lock and unlock the doors. To stop the alarm, press and hold the HORN button on the transmitter again for 3 seconds. If the button is not pressed, the alarm will automatically stop after 60 seconds.

## Battery Replacement

Under normal use, the transmitter battery should last approximately two years. When battery replacement becomes necessary, use a Panasonic 3 volt, type CR2032, or equivalent. Replace the battery as follows:

1. Open the transmitter by inserting a dime between the two halves of the transmitter case (near the key ring hole) and twisting.

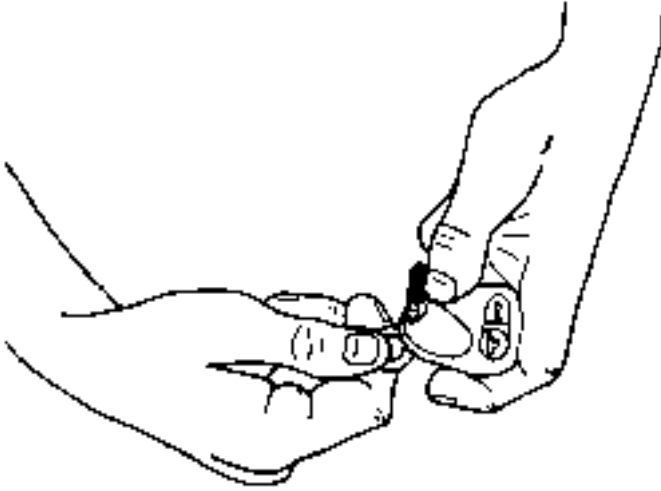

C0029324

2. Remove the battery.
3. Install a new battery with the positive (+) side down.

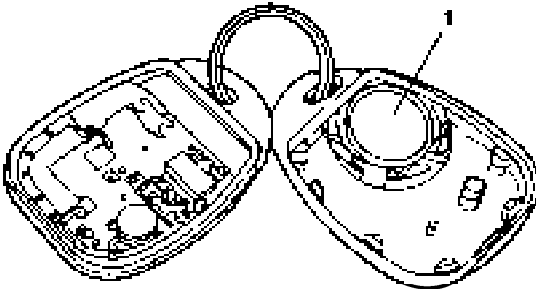

C0029325

1. Battery, positive (+) side down

4. Align the transmitter case halves, then snap the case together.
5. Check the of the transmitter.

### ***Troubleshooting***

The following checks may be used to diagnose any problems which may arise with Remote Keyless Entry system . Remember to check all transmitters.

1. Lower the windows, turn the ignition key to the OFF position and close the doors.
2. Stand near the driver's side door, aim the transmitter at the vehicle and operate both functions of the transmitter. Repeat for all transmitters, if applicable.
  - If a single function on one transmitter is inoperative, replace the transmitter.
  - If all functions on any of the transmitters are inoperative, reprogram all transmitters and repeat the troubleshooting procedures. Refer to the "Programming the Transmitter" section.
  - If one transmitter cannot be programmed, replace the battery in the transmitter. Refer to the "Battery Replacement" section.
3. If all functions on all transmitters operate, stand approximately five feet from the vehicle (at several points around the vehicle), and check the of all transmitters at each point.
  - If one transmitter does not operate at some point where another transmitter does operate, replace the battery in the transmitter that does not operate.
  - If all transmitters operate approximately five feet from the vehicle, the system is operating properly and no repairs should be attempted.

### ***Programming the Transmitter:***

1. Turn the ignition switch to the ON position.
2. Access the keyless entry module, located behind the D-Panel.
3. Push the Program switch on the keyless entry module three times. The program LED on the module will be solid, to indicate you are now in the Transmitter Programming Mode.
4. Press any button on one of the transmitters until the horn responds with a chirp and the LED will flash once, to confirm the first transmitter is now programmed.
5. If necessary, repeat Step 3 to program the 2nd, 3rd and 4th transmitters.

**Note:** If more than four transmitters are programmed, the system will only retain the last four transmitters programmed.



6. To exit Programming Mode, turn the ignition switch to the OFF position, or simply wait 15 seconds. The LED will be off to confirm exit.

**Feature Programming:**

1. Turn the ignition switch to the ON position.
2. Access the keyless entry module, located behind the D-Panel.
3. Push the Program switch on the keyless entry module six times. The horn will chirp six times, and the program LED on the module will be solid, to indicate you are now in the Feature Programming Mode.
4. Press and release the transmitter button corresponding to the feature you want to change.

**Note:** The horn chirps and LED pulses will indicate the new setting.

5. Press the transmitter button again to change the feature again. Keep pressing the transmitter button until the module advances to your desired setting.

| Press Transmitter Button   | One Chirp/LED One Pulse <b>Factory Default Setting</b>                  | Two Chirps/LED Two Pulses                             |
|--|---|---|
|   | The Remote function can operate with ignition "on"                      | The Remote function cannot operate with ignition "on" |
|  | Automatic Re-Arm OFF  | Automatic Re-Arm ON                                   |
| AUX  | External Light turns on for 3 minutes                                   | External Light turns on for 5 minutes                 |
|  | Three Chirps/LED Three pulses = External Light turns on for 10 minutes. |   |
|  | Four Chirps/LED Four pulses = External Light turns on for 15 minutes.   |   |
|  | Five Chirps/LED Five pulses = External Light turns on for 20 minutes.   |   |

6. To exit Programming Mode, turn the Ignition to the "Off" position, or simply wait for 15 seconds. The horn will respond with a short + long beep and the LED turns off to confirm exit.

## SEAT BELTS



### DANGER

*Seat belts should always be secured BEFORE the vehicle is set in motion. Failure to use seat belts can result in SEVERE bodily injury or death. Unbelted riders could be thrown into the windshield or other parts of the cab, or thrown out of the cab entirely.*

## Seat Belt Operation

MACK vehicles manufactured on or after September 1, 1990 must have locking retractable seat belts.

For all seating positions in your MACK vehicle, this type of seat belt is a combination lap and shoulder belt.

This type of belt is designed to lock (prevent belt travel out of the retractor) only during sudden stops or impacts. This feature allows the operator to move freely under normal conditions. Seat belts cannot be locked by jerking on the belt, except during sudden stops or harsh bumps.

## Fastening Seat Belt

1. Pull clip so the belt crosses your shoulder and lap and insert it into the buckle until an audible snap is heard.



### DANGER

*Use the shoulder belt only on the shoulder that is closest to the vehicle door. Never wear the shoulder portion of the belt under your arm or behind your back. Improper use will increase your chances of injury during a collision.*



### DANGER

*To prevent possible injury the belt must be positioned low over the pelvis, below the abdomen. If the belt is buckled too high, it will apply force to the abdomen, not the pelvic region, and could cause serious internal injuries during a sudden stop.*

**DANGER**

*Do NOT wear seat belt loosely. Do NOT use one belt for more than one person.*

2. Make sure the clip is securely fastened into the buckle.

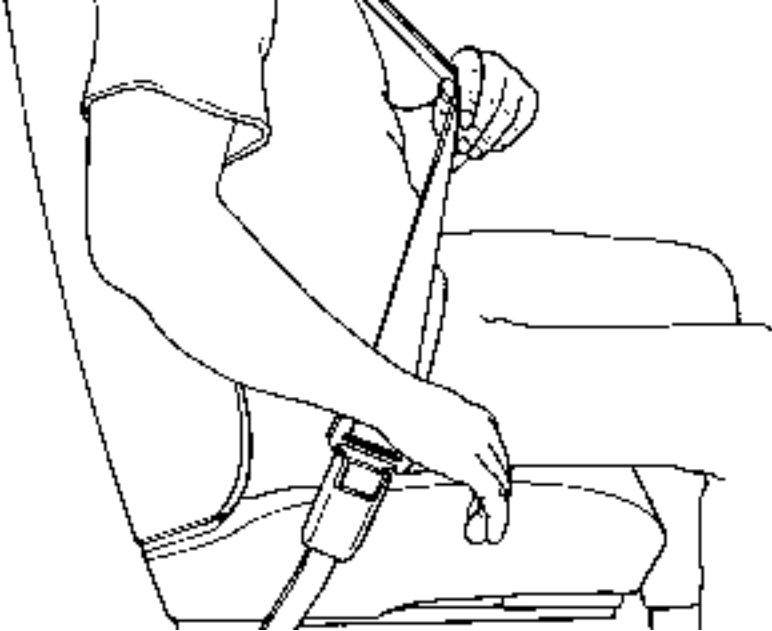

C0029326

3. To tighten the lap portion of the combination belt, pull upward on the shoulder portion until the lap portion fits snugly. The belt should rest as low on your hips as possible.

***Unfastening Seat Belt***

Push down on the button to release the belt.

## Adjustable D-Ring Shoulder Belts (if equipped)

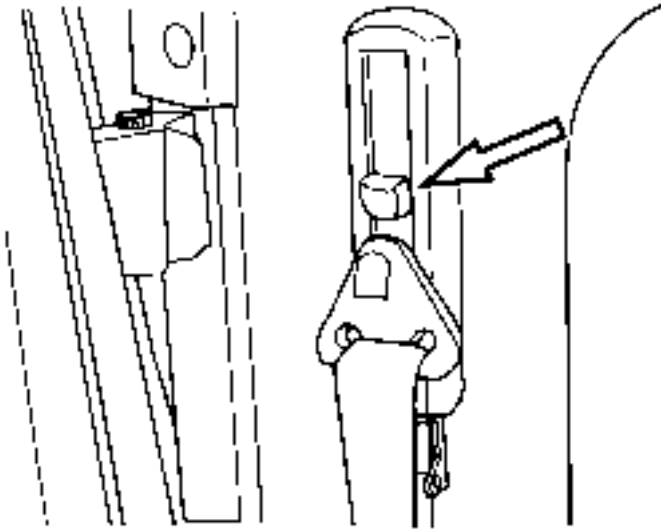

C0029327

The shoulder belt portion of the three-point belt is adjustable so that the belt can be adjusted to lay properly and comfortably across the shoulder. To adjust the belt, squeeze the release lock and move the belt to the desired position. The belt locks into place when the lock is released.

### **Seat Belt Maintenance**

- Keep belt clean and dry.
- Clean with mild soap solution and lukewarm water.



### **DANGER**

*Do NOT bleach or dye belt, as this may cause severe loss of strength. Do NOT install belt in a truck with a weakened floor until the floor has been replaced or reinforced.*

- Periodically inspect the following areas and replace any inadequate parts:

**Buckle and Latchplate** — The buckle and latchplate should mate easily with a solid click and release easily and quickly with moderate pressure on the release button. All metal seat belt components should be free of signs of damage, corrosion or rust.

<https://www.truck-manuals.net/mack/>



**Webbing** — The webbing should show no signs of wear, fraying or holes, and it should be reasonably free of dirt which could find its way into the retracting mechanism.

**Retractors** — The retractors should function smoothly and maintain an appropriate amount of tension. Loose webbing is an indicator that maintenance is needed; it's likely that a too-loose belt will fail to tighten properly when necessary.

**Seat Belt Mounting Components** — The tethering should be free of wear and debris; the webbing should show no signs of wear, fraying or holes; and the metal components should be free of signs of damage, corrosion or rust.



## DANGER

*Seat belt assemblies must be replaced after an accident if they have been subjected to loading by occupants (even if no damage is obvious), or if they have been damaged by an accident (bent retractor, torn webbing, etc.). If there is any question regarding belt or retractor condition, replace the appropriate part.*

**D-Rings (If Equipped)** — The height adjusters installed on pillars should function smoothly without binding or signs of looseness.

## Komfort® Latch System

### **Seat Belt Assembly**

The Track III three-point seat belts installed in this chassis are designed to provide the highest degree of operator safety, comfort and convenience. Additional comfort is provided by the Komfort Latch mechanism, which is incorporated into the seat belt assembly, and may be used to relieve any discomfort caused by the constant pressure of engaged seat belts.

### **Seat Belt**

To buckle the seat belt, grasp the latch portion of the buckle, bring it across your lap (from outboard to inboard) and insert it into the fixed buckle which is mounted to the floor or seat (depending on seat type). With the belt properly latched, the pelvic and upper torso restraints will be in place and automatically adjusted to provide a snug fit.

### **Komfort Latch Feature**

If the constant tension of the buckled seat belt causes any discomfort, engage the Komfort Latch as follows:

<https://www.truck-manuals.net/mack/>

**DANGER**

*Do NOT attempt to engage the Komfort Latch feature while the truck is in motion.*

**Engagement** — Pull the webbing of the shoulder belt away from the upper torso, pulling only as much slack as needed while still allowing the belt to exert slight pressure against your chest and shoulder. (Maximum amount of slack should not exceed one inch when measured from the chest to the belt.) While holding the slack, lift the lever located on top of the Komfort Latch mechanism upward to clamp the webbing in place.

**Normal Release** — To unfasten the seat belt, simply release the buckle and give the shoulder belt a quick tug to release the Komfort Latch mechanism. Allow the belt to retract into the retractor.

**Emergency Release** — In the event of an emergency, release the seat belt buckle. It is not necessary to release the Komfort Latch in an emergency situation.

**Note:** If forward movement is required while the Komfort Latch mechanism is latched, the latch automatically releases when you lean against the shoulder portion of the belt. Repeat the above steps to reset the Komfort Latch, if desired, after forward movement is no longer required.

**DANGER**

*Excessive slack will reduce effectiveness of the seat belt, which could result in personal injury and death. CAREFULLY follow the instructions for adjusting the tension-relieving device.*

## SLEEPER BUNK RESTRAINT

A sleeper bunk restraint is provided as a means of preventing ejection of an occupant from the sleeper bunk during deceleration of the vehicle.



### DANGER

*To avoid personal injury, DO NOT occupy the sleeper bunk unless the restraint is completely attached.*

## Upper Bunk (Optional)

The optional upper bunk is not intended to be used as a sleeping area or storage area while the vehicle is moving and, therefore, is not equipped with a bunk restraint.



### DANGER

*To avoid personal injury, DO NOT occupy the upper bunk or use it for storage while the vehicle is moving.*



### DANGER

*To avoid personal injury, use the bunk restraining strap to hold the upper bunk in place when it is in the upright (stored) position.*

---

## Bunk Restraint

Your vehicle is equipped with either a two-belt restraint system or a net restraint system.

### *Two-Belt Restraint*

- Pull each belt across the body and insert the tongue into the buckle until it latches.
- Make sure that the tongue is securely fastened into the buckle.
- To release the belt, push down on the button.

### *To Attach Net Restraint*

- Facing the mattress, arrange the webbing of the restraint on top of the mattress so that the side with the two buckles (female ends) faces the rear of the sleeper, and the side with the single buckle faces the passenger's side of the vehicle.
- Fasten the two buckles to the two corresponding tongues (male ends) attached to the rear wall of the sleeper.
- Fasten the buckle on the left side of the restraint to the corresponding tongue attached to the passenger side wall of the sleeper.
- Fasten the tongue on the right side of the restraint to the corresponding buckle attached to the driver's side wall of the sleeper.
- Fasten the three tongues along the nearside of the webbing to the corresponding buckles attached to the front of the mattress area.

## Bunk Restraint Maintenance

- Visually inspect the buckle and tongue for any damage which would impair latching or unlatching.
- Check all hardware for breakage, distortion, or excessive corrosion.
- Ensure that fasteners are securely tightened in accordance with specifications.

## SEAT ADJUSTMENT AND RECLINE (IF EQUIPPED)



### WARNING

**Do not adjust the driver's seat while the vehicle is moving. After adjusting the seat and before driving off, ensure that the seat is firmly latched in position.**



### WARNING

**Do not drive or ride with the seat reclined. In case of a sudden stop, a person in a reclined position may slide under the seat belt.**

## HEATED SEAT (OPTIONAL)

If the vehicle is equipped with the optional heated seat which is available only with the MACK Performance Seat, the controls are located on the inboard side of the seat.

## SWIVEL SEAT (OPTIONAL)

Both the driver-side and passenger-side seats can be swiveled 180° inboard. (See drawing and instructions that follow.)

- 1. Recliner Handle** — Before attempting to swivel, adjust the seat back to near-vertical position using the lever or turn knob provided. After the seat is swiveled into the desired position, the seat back may be reclined to a more comfortable angle. (Position driver's seat away from steering wheel to allow maximum recline.)
- 2. Swivel Latch** — Unlatch by moving handle. Swivel inboard up to 120°. Handle may be released after the seat begins to swivel.



### CAUTION

*If your vehicle is equipped with a sleeper and you are trying to gain access to the sleeper from the cab, you must first adjust the seat midway between the fore and aft positions. Then adjust the seat back to the vertical position, and finally, swivel the seat to a position that will allow easy access to the sleeper. If these instructions are not followed, damage to the driver seat and/or door panel can occur.*

3. **Fore/Aft Adjustment Lever** — Fore (forward)/aft (backward) adjustment may be required to provide clearance for the seat to swivel. Move the adjustment knob to slide the seat fore and aft. After seat back and arm rest have cleared B-pillar, seat fore/aft position may require readjustment to provide clearance between knees and gearshift or dashboard and between seat back and steering wheel.

4. **Arm and Back Clearance** — As the seat begins to swivel, check that the seat back and armrest do not get hung up on the curtain or shoulder belt, or contact the B-pillar or door.

**WARNING**

**Do not adjust the driver's seat while the vehicle is moving. After adjusting the seat and before driving off, ensure that the seat is firmly latched in position.**

**WARNING**

**Do not drive or ride with the seat reclined. In case of a sudden stop, a person in a reclined position may slide under the seatbelt.**

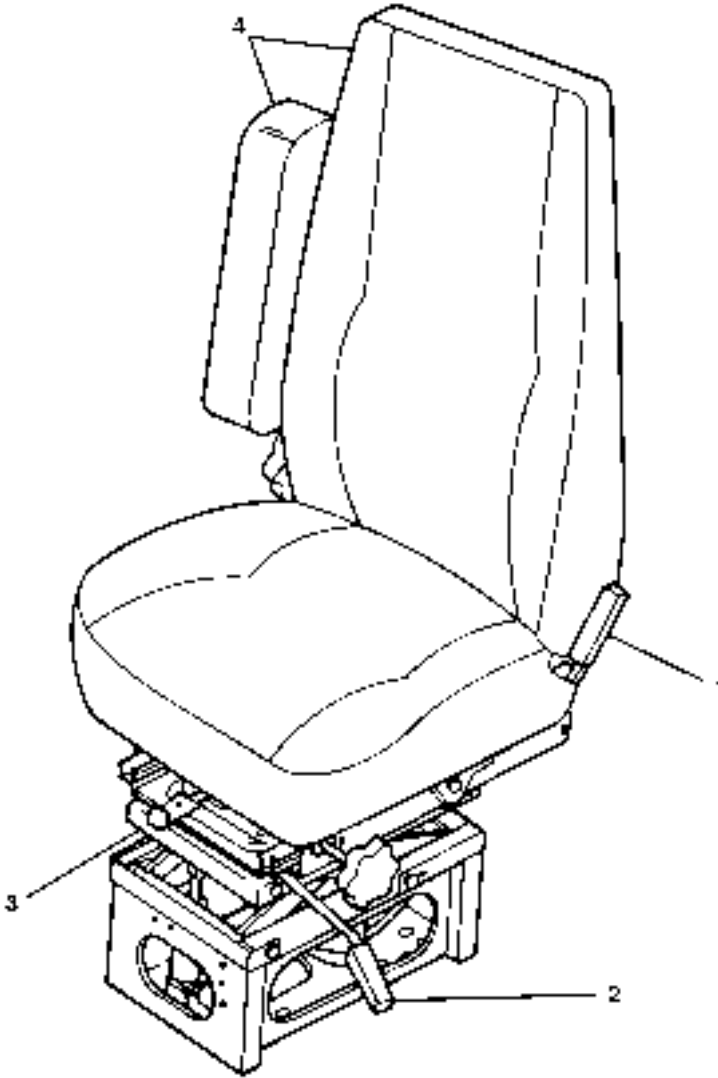

C0029328

**Left Driver Seat Shown**

1. Recliner Handle

2. Swivel Latch

3. Fore/Aft Adjustment Lever

4. Arm and Back Clearance

---

## MACK ENGINE INFORMATION

For engine starting procedures, refer to .

### Precautions and Warnings



#### CAUTION

*If a winterfront is needed, use only a winterfront that was designed for this specific chassis. Winterfronts are not recommended, but may be used during very cold weather with sustained temperatures below -25°C (-13°F).*



#### CAUTION

*Be sure to avoid high intake/exhaust temperatures when using winterfronts under normal operating conditions (above freezing). The restriction of airflow can cause higher exhaust temperatures, power loss, excessive fan usage and reduced fuel economy.*



#### CAUTION

*If a winterfront is used, a MACK-approved exhaust pyrometer must be installed and closely monitored while the engine is in . Do NOT exceed the maximum temperature indicated by the red line on the gauge. To reduce exhaust temperature, downshift or reduce engine power and open the winterfront.*



#### CAUTION

*Do not permit a heavy load to drive the engine above the governed speed. Operate in a gear low enough to allow the engine to accelerate to (or maintain) governed speed when applying the throttle.*



|   |                  |
|---|------------------|
|   | <h3>WARNING</h3> |
| <p><b>Misuse or modification of a turbocharger can result in serious injury and property damage. In addition, extreme care must be taken to avoid foreign material induction, excessive exhaust temperatures and lack of lubrication.</b></p> |                  |

|  |                  |
|--|------------------|
|    | <h3>CAUTION</h3> |
| <p><i>The maximum allowable engine speed is listed on the warning label on the sun visor. DO NOT exceed 2,300 rpm.</i></p> |                  |

## Engine Model Designations

The MACK engine model designation system uses letters and numbers to provide a complete unit description.

### *MP Engine ID Letters and Number*

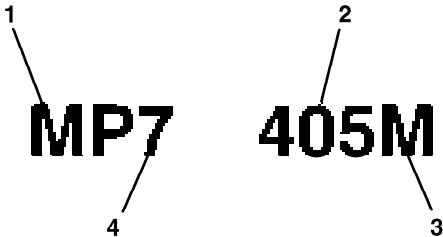

C0029329

### MP7 Used as an Example

|   |   |
|---|---|
| <p>1. Mack Power</p><br><br><br><p>2. Peak Horsepower</p> | <p>3. Curve Family:<br/>Econodyne = E<br/>Maxicruise = C<br/>Maxidyne = M</p> <p>4. Rounded Cubic Inch Displacement</p> |
|---|---|

---

## CRUISE CONTROL

**Note:** Effective August 2008, a change was made to the vehicle software which requires the vehicle operator to press and release the brake pedal after the engine has been started. If the brake pedal is not depressed after starting the engine, cruise control will not function.

### Speed Control Switches

**Resume/Set Switch** — Allows the driver to set and resume cruise control.

**Note:** In most cases, the Speed Control switch must be in the ON position in order to use the Resume/Set switch. However, when the Initial Set Using Resume Switch feature is enabled, cruise control can be activated using the Resume/Set switch.

The Resume/Set switch also functions as the Accel/Decel switch. Usually the Resume position (press the top) corresponds to an increase in engine speed (Accel) and the Set position (press the bottom) corresponds to a decrease in engine speed (Decel).

**Note:** Under specific circumstances this switch can also be used to activate cruise control. For details concerning the Initial Set Using Resume Switch feature, refer to the *V-MAC Support Software User's Guide*.

**Speed Control Switch** — Activates the cruise control system.

## Setting Cruise Control

1. Press and release the brake pedal after engine has been started.
2. Engage the clutch (if equipped).
3. Move the Speed Control switch to the ON position.
4. Increase engine speed using the accelerator pedal.
5. At the desired speed, press and release the Resume/Set switch. This speed is now programmed and will be automatically maintained.

**Note:** To increase the engine speed, press and hold the Accel switch until the desired speed is attained, or press the accelerator pedal until the desired speed is attained and then press and release the Set switch.

## Disengaging Cruise Control

To turn off the cruise control system, move the Speed Control switch to the OFF position.

**Note:** If the Speed Control switch is moved to the OFF position, the process of setting cruise control must be repeated in order to re-activate cruise control (unless the Initial Set Using Resume Switch feature is enabled).

To temporarily disengage cruise control, disengage the clutch or apply the service brakes.

**Note:** If cruise control is temporarily disengaged using the clutch or service brakes, press the Resume switch to resume the previously programmed speed.

---

## MACK POWERLEASH™ ENGINE BRAKE (IF EQUIPPED)

Engines may be equipped to be PowerLeash™ upgradeable. These engines will be equipped with PowerLeash™ camshaft. These engines are identified on the engine information sticker.

If your vehicle is equipped with the MACK PowerLeash™ Engine Brake, it is important that you take the time to become familiar with your engine brake before putting it into .



### WARNING

**of any vehicle on wet or slippery roads requires extreme caution. Because the engine brake converts the engine to a retarding device, it should NOT be used on wet or slippery roads if the vehicle has a single driving axle or if it has tandem driving axles that are lightly loaded. Use of an engine brake under these conditions can cause the vehicle to skid or a combination vehicle to jackknife.**

## Engine Brake Switch

The Engine Brake switch is located on the dashboard. The Engine Brake switch is a three-position switch located on the instrument panel.

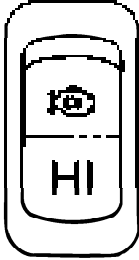

### Engine Brake Switch

- HI Full Engine Braking Power
- LO Half Engine Braking Power
- OFF No Engine Braking Power

C0029330

To operate the vehicle without the engine brake active, leave the dash-mounted switch in the OFF position.



### CAUTION

*The V-MAC® system prevents engine brake activation if the oil temperature is below 55°C (131°F). The driver should be alert to the fact that the engine brake will not function until sufficient warm-up time has elapsed, regardless of the dash switch setting.*

---

## How the Engine Brake is Activated

When the engine brake is "enabled" (switch in either LOW or HIGH position), your engine V-MAC® electronic control system commands engine brake power (engine brake "active") only when the following conditions are true:

- The foot-operated engine accelerator pedal is not depressed.
- The clutch pedal is not depressed (manual shift transmissions only).
- The engine speed is at least 900 rpm.
- Vehicle must be in gear.
- Vehicle speed should be greater than 8 km/h ( 5 mph).

If the engine brake is active, the engine brake will automatically be deactivated by depressing either the accelerator or the clutch, or if the engine speed drops below 900 rpm. As soon as all of the engine brake "active" conditions are again true (taking your foot off the accelerator, for example), the engine brake will again be activated. In order to disable the engine brake, simply return the dash-mounted control switch to the OFF position.



### DANGER

*The engine brake should never be considered a substitute for the vehicle service brakes. The service brakes should always be maintained in good working order, and should always be viewed as the primary vehicle slowing system. Service brakes are always used to bring the vehicle to a complete stop.*

---

## Cruise Control with the MACK PowerLeash™ Engine Brake

When the MACK PowerLeash™ Engine Brake is enabled at the same time your V-MAC® cruise control is in use, the engine brake automatically activates when necessary to slow the vehicle to the cruise set point speed. You can select one of two possible options:

- The engine brake is activated 3 km/h (2 mph) above the cruise set point.
- The engine brake is activated as soon as cruise control commands fueling to zero (vehicle has just reached cruise set point and fuel has been turned off).

The first option is the more popular choice for highway use and is the default mode. Consult your V-MAC® IV Operator's Manual for more information about this option. Your local MACK dealer can change the current selection.

The engine brake's ability to control maximum vehicle speed is limited to the selected retarding power of the engine brake. If the engine brake dash-mounted control switch is set to the LOW position, only half of the available braking power is used. If the dash-mounted control switch is set to the HIGH position, the cruise control invokes full engine brake power.

**Note:** Deactivating the cruise control function does not disable the engine brake.

The MACK PowerLeash™ Engine Brake may be activated or deactivated by other vehicle systems such as ABS and Headway control systems. Refer to the literature concerning these systems for additional information.

# ON THE ROAD WITH THE MACK POWERLEASH™ ENGINE BRAKE

If you are not familiar with the use and of a heavy-duty diesel engine brake, it is essential that you read the following section carefully. It is very important that you take the time to gain experience with your MACK PowerLeash™ Engine Brake in good driving conditions, before using it in difficult or hazardous driving conditions, such as steep descents or slippery roads. Of course, there is no substitute for driver training by a qualified specialist.

The following information is intended as a guideline to safe and appropriate use of the MACK PowerLeash™ Engine Brake. It is difficult to describe every possible driving condition. Certain circumstances may require a more conservative approach than will be described. When encountering any new driving route or situation, err on the side of caution.

## Over Flat Terrain

The LOW power position is likely adequate to control vehicle speed in situations where the roadway is relatively flat or has modestly graded rolling hills, and if total vehicle weight is light.

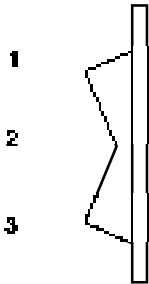

C0029331

|                   |        |
|-------------------|--------|
| 1. High<br>2. Low | 3. Off |
|-------------------|--------|



As grades and vehicle weight increase, it will be necessary to use the HIGH position.

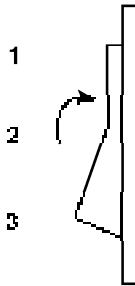

C0029332

|                           |               |
|---------------------------|---------------|
| <p>1. High<br/>2. Low</p> | <p>3. Off</p> |
|---------------------------|---------------|

## Descending a Grade

 **DANGER**

*The MACK PowerLeash™ Engine Brake assists you in establishing faster downhill descent speeds than in a similarly configured and loaded vehicle without an engine brake; nevertheless, even with an engine brake, there are limits to the maximum vehicle speed at which you can travel on downhill grades and still keep your vehicle safely under control. Always approach these situations with caution, and gain the experience necessary for each grade and driving condition to determine the appropriate downhill descent speed.*

For a certain vehicle and load condition, a "control speed" may be established for a given descent. The control speed is the vehicle speed at which the retarding forces of air drag, rolling resistance and engine brake power are equally balanced by the natural force of gravity that causes the vehicle to accelerate down the hill, resulting in a steady, controlled vehicle speed. The additional vehicle slowing power offered by the MACK PowerLeash™ Engine Brake allows the driver to descend the hill in a higher gear than normal (at a faster control speed), without overspeeding the engine.

For example, consider that you are descending a grade with a specific vehicle and an assumed total vehicle weight. You will find that without an engine brake, you must descend this grade in third gear to maintain a steady 16 km/h (10 mph) at 2,000 engine rpm, without the need to apply the service brakes.

<https://www.truck-manuals.net/mack/>

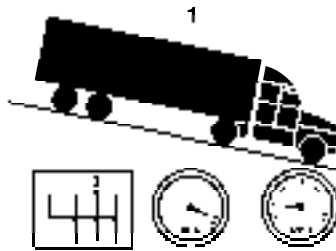

C0029333

### 1. Descent Speed without MACK Engine Brake

Switch the MACK PowerLeash™ Engine Brake to the HIGH position, and now it is possible to descend the same grade in sixth gear to maintain a steady 56 km/h (35 mph) at 2,000 engine rpm.



### CAUTION

*The maximum allowable engine speed is listed on the warning label on the sun visor. Do NOT exceed 2,300 rpm.*

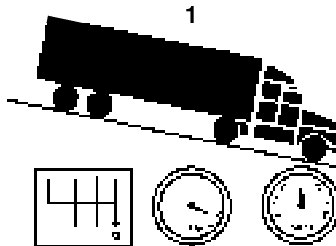

C0029334

### 1. Descent Speed without MACK Engine Brake

In any gear selection higher than sixth gear (in this example), it would be necessary to occasionally apply the service brakes to maintain a safe vehicle speed and to avoid overspeeding the engine.



## DANGER

*As with any vehicle, regular and excessive application of the service brakes during a downhill descent can lead to a brake lining overheat condition, resulting in a very dangerous loss of service brake retarding capability.*

**Note:** The previous figures apply only to this hypothetical example. Specific vehicle control speeds and engine speeds for a given descent are dependent upon the actual vehicle and engine configurations, the gross weight of the vehicle, and the percent grade of the road.

## On Slippery Road Surfaces

As with many aspects of operating a heavy-duty vehicle, special care should be taken when using the MACK PowerLeash™ Engine Brake on slippery road surfaces. The potential for unpredictable loss of vehicle traction is a serious concern; in some situations the engine should not be used at all.

As always, approach untested driving conditions with caution. Avoid use of the MACK PowerLeash™ Engine Brake in these situations until you have gained some experience under normal driving conditions.

As a rule, make sure that the vehicle is demonstrating good tractability with the engine brake off before checking for tractability with the engine brake enabled. Then, provided traffic conditions are safe for "testing" tractability, switch the MACK PowerLeash™ Engine Brake to the LOW position. If the vehicle shows any signs of loss of control (ABS activation or vehicle swerving, for example), immediately switch the engine brake back to the OFF position.

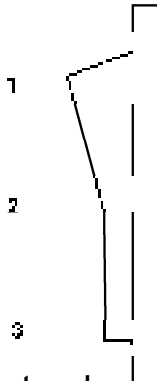

|                   |        |
|-------------------|--------|
| 1. High<br>2. Low | 3. Off |
|-------------------|--------|

Only if the vehicle demonstrates good control in the LOW position (again, only in safe driving conditions) should you test in the HIGH position, if desired. Return to the LOW position and proceed with caution if there is any sign of loss vehicle control.

**Note:** Always monitor vehicle tractability in slippery road conditions, and make adjustments to engine brake switch position and vehicle speed as necessary. Always test the LOW power position setting before moving to the HIGH position.

Your MACK PowerLeash™ Engine Brake and ABS control systems are designed to work together for optimized vehicle control. The engine brake function may be modified or interrupted briefly in the event of pending wheel lock.



### CAUTION

*Do not enable the MACK PowerLeash™ Engine Brake during bobtail s, or when operating on slippery roads with an empty or lightly loaded trailer.*

## BRAKE

### Air Brake System

This chassis features a dual braking system which has two complete air circuits: a primary circuit for rear brakes and a secondary circuit for front brakes. Each circuit receives air from separate reservoirs. Although there are two air circuits, they operate as one brake system through the dual-circuit treadle valve. This provides the driver with easy, graduated control when applying and releasing the brakes.

The air pressure in the two circuits is monitored by gauges on the instrument panel. When air pressure drops below  $517 \pm 34$  kPa ( $75 \pm 5$  psi) in either system at any time other than vehicle startup, pull to the side of the road and determine the problem. If air pressure continues to drop below  $276 \pm 34$  ( $40 \pm 5$  psi) in BOTH systems, spring brakes will automatically apply. The Low Air Pressure Warning indicator and buzzer will be activated if low air pressure occurs in either circuit.

In tractor applications, the Trailer Supply Valve (red octagonal knob) will immediately pop out in the event of a trailer breakaway or sudden trailer air line failure, which will apply the trailer spring brakes. In the event of a slow leak in the trailer air system, the trailer supply valve will pop out when system Pressure reaches 483 kPa (70 psi). This protects the tractor air system from further pressure loss.

If the Trailer Supply Valve is held in, in an attempt to override application of the trailer spring brakes, the Park Brake Valve (yellow diamond knob) will automatically pop out and apply the parking brakes when system pressure drops to approximately 138 – 207 kPa (20–30 psi).

The air brake system consists of three main elements:

- The compressor, governor and reservoirs supply and store the air pressure.
- The brake application valve controls the brake application pressures.
- The brake chambers control the brake mechanism.

#### **Air Brake**



#### **CAUTION**

*Avoid sudden stops. Constant, sudden stops may negatively affect the performance of braking and driving parts.*

When slowing for a stop, leave the clutch engaged for as long as possible to use the braking effect of the engine. When forward speed has dropped to a little above idling speed, push clutch pedal in and brake to a complete stop.

## Automatic Slack Adjusters

Automatic slack adjusters are designed to automatically maintain proper brake chamber pushrod travel and compensate for brake lining wear during normal use. Manual adjustment of an automatic slack adjuster should never be performed except when performing brake or wheel service (such as backing off the brake shoes for wheel removal, brake shoe relining/replacement, brake drum reconditioning, etc.).

When pushrod travel exceeds specifications (as given in the "BRAKE ADJUSTMENT" section of the Maintenance and Lubrication Manual, 21394653) on a vehicle equipped with automatic slack adjusters, a mechanical problem with the slack adjuster, brake components or improper installation of the slack adjuster is indicated. If brakes are found to be out of adjustment, the vehicle must be taken to the nearest repair facility to have the problem investigated and corrected.



### DANGER

*Automatic slack adjusters should not be manually adjusted in an effort to correct excessive pushrod stroke, because this condition indicates that a problem exists with the automatic adjuster, with the installation of the adjuster, or with related foundation brake components, which manual adjustment will not fix. Manual adjustment of automatic slack adjusters is a dangerous practice that could have serious consequences, because it gives the operator a false sense of security about the effectiveness of the brakes, which are likely to go out of adjustment again soon.*

## Parking Brake System

Spring-type parking brakes are standard on all single and tandem rear axles.

The spring brake system consists of an air cylinder with heavy springs, which is integrated with the spring brake air chamber. When there is no pressure in the air chamber, the springs expand (causing a brake application). When air pressure is applied to the air chamber, the springs are compressed (releasing the brakes).

## Parking Brake

The parking brakes can be applied and released from the cab, using the hand-operated push/pull control valve with the yellow diamond knob.

In the event of a significant air pressure loss in both the air brake systems, the spring brake air chambers will be automatically exhausted (applying the brakes). The parking brakes will remain applied until enough pressure is available to recompress the springs.

## Parking



### WARNING

- **NEVER** use the trailer parking brake system alone.
- **NEVER** use the tractor parking brake system alone.
- **ALWAYS** use the tractor and trailer parking brake systems together.
- **ALWAYS** apply the parking brakes when parking and make sure the parking brakes are holding the vehicle from moving before leaving the driver's seat.
- When parking on a grade, use wheel chocks under the rear wheels or turn the front wheels to the curb. Do not leave diesel engine vehicles in gear; if the vehicle should move, the engine may start by heat of compression.
- Check brake adjustment frequently to be sure that the brakes will lock and hold the vehicle when parked.
- Do not use the parking brake to slow or stop the vehicle when in motion, except in an emergency.
- Do not use hand control valve for parking.

---

## Anti-Lock Brake System (ABS)

**Note:** Anti-lock brake systems became mandatory in the U.S.A. on all tractors beginning March 1, 1997; all trucks beginning March 1, 1998, and all trailers beginning March 1, 2001. Federal regulations require that any tractor/truck with a trailer air connection built beginning March 1, 2001 must have a data communications link with the trailer ABS and an indicator lamp located in the cab to alert the driver if there is a trailer ABS malfunction.

### **ABS**

When operating an ABS-equipped vehicle, the following guidelines should be used.

- Apply the brakes as normal. If the anti-lock brake system begins to function, maintain brake pressure. Do NOT release the brakes.
- Avoid rapidly pumping the brakes. The anti-lock brake system automatically applies and releases the brakes up to five times per second.
- When towing a trailer, watch the trailer through the mirrors. Adjust brake application as necessary to keep the combination in a straight line. Make sure the trailer follows the tractor properly.
- An amber trailer ABS lamp on the instrument panel will illuminate for several seconds at start-up during an initial function check. When a trailer ABS fault occurs, the lamp will remain illuminated until the fault is cleared. If there is a loss of communication between the tractor and trailer, the lamp will blink three times. Refer to for more information.

### ***MACK Road Stability Advantage (If Equipped)***

The MACK Road Stability Advantage (RSA) is based on the Bendix® ABS-6 Advanced with ESP® (Electronic Stability Program) System. The RSA system aids the operator in maintaining control of the vehicle in the event of a jackknife or rollover situation by applying select brakes and reducing engine power as required by the specific situation. The RSA system, which is integral with the anti-lock brake system, uses the standard ABS components (such as wheel speed sensors and modulator valves) along with a Steering Angle Sensor (SAS-60™) and a Yaw Rate/Lateral Acceleration Sensor (YAS-60™) package to provide information concerning vehicle movement to the Advanced EC-60™ Electronic Control Unit.

In most cases, vehicle repairs will not affect function of the MACK RSA system. However, the following repairs require recalibration of the SAS-60™ sensor after the repair has been made:

- Removal and reinstallation or replacement of the SAS-60™ sensor

<https://www.truck-manuals.net/mack/>





**CAUTION**

*Installation of an aftermarket steering wheel may damage the SAS-60™ sensor. It is therefore recommended that the OEM steering wheel NOT be replaced with an aftermarket wheel.*

- Any repairs to the steering system or front suspension such as:
  - Replacement of front springs
  - Replacement of king pins or bushings
  - Replacement of the steering gear
  - Replacement of the drag link, cross steering tube or ball sockets
  - Replacement of the front spring hangers
  - Replacement of the steering column
- Front end alignment
- Disconnecting the steering column from the steering gear, or the steering linkage from the steering gear



**WARNING**

**Failure to recalibrate the steering angle sensor after performing any of the repairs mentioned above, may affect proper function of the RSA system, resulting in a loss of vehicle control due to system intervention at inappropriate times.**

**Vehicle Modifications**

Alterations to the vehicle, such as changes to the wheel base (either lengthening or shortening), the addition of an auxiliary lift axle or removal of a factory-installed auxiliary lift axle, or major body changes, such as conversion of a tractor to a truck or an axle, suspension or steering system component modification, are NOT allowed, as these changes will adversely affect performance of the road stability system. Should such changes be unavoidable, the system must be disabled by having a qualified technician replace the Advanced EC-60™ ECU with a Premium EC-60™ ECU.

**WARNING**

**Failure to disable the RSA system on a vehicle that has been modified will result in serious vehicle braking and performance issues, including unnecessary system interventions. These interventions could lead to a loss of vehicle control.**

**In addition to disabling the system, any cab labels, such as warning and caution labels relating to the Bendix® ABS-6 Advanced with ESP® system located on the sun visor must be removed, and notations must be made to the operator's manuals so that the vehicle operator has a clear understanding as to which ABS options are installed on the vehicle.**

Location of the yaw rate/lateral acceleration sensor must not be altered. When servicing is required, the sensors must be replaced with identical components using the original equipment mounting brackets and tightening torque specifications (20 N.m [15 lb-ft]).

The following additional changes **MUST NOT** be made to an "as-built" vehicle:

- Changes to maximum steering angle (to the left or right)
- Changes to steer axle and/or drive axle track width
- Changing the front and/or rear brake drums to drums having a different flange thickness

***Tire Size Calibration***

The ECU requires a precise rolling circumference ratio between the front steer axle and the rear drive axles for optimum performance of the system. For this reason, the system continuously calculates the precise ratio and stores the information in the ECU memory.

**CAUTION**

*Effectiveness of the RSA system relies on the accuracy of the reported vehicle speed. If major changes to tire sizes are made, such that changes to the vehicle speedometer/odometer settings are required, the Advanced EC-60™ ECU must be reprogrammed with the new values by a qualified technician.*

***Enhanced Stability Program***

<https://www.truck-manuals.net/mack/>

Enhanced Stability Program (ESP) is an optional system that uses existing ABS and ATC components with the addition of electronic sensors and brake valves. The system will automatically apply and release individual brakes to improve vehicle control when extreme conditions are detected. In the event a pending rollover situation is sensed, the system applies all brakes to reduce vehicle speed to lessen the possibility of rollover. Please refer to the applicable vendor manual for more information.

### **Precautions When Installing Electrical Equipment**

Connecting electrically powered or electrically controlled equipment to the vehicle may cause interference with other vehicle components (e.g., the ABS system). The amount of interference will depend on the operating frequency of any new signals and the degree to which transient signals are coupled into the vehicle system.

**Note:** Whenever new electrical equipment is installed, it is the obligation of the installer to ensure that the new equipment does not interfere with the proper of all other electrical systems on the vehicle.

If new electrical equipment is installed, a vehicle checkout procedure should be performed.

1. Perform the checkout procedure under the following conditions:

- Engine running
- Brake system air pressure in operating range
- Vehicle stationary
- Brake pedal fully depressed

2. Operate the new equipment under all starting, running and shutdown conditions.

3. Listen for signs of air exhausting from ABS modulator valves (which is an indication of an interference condition).

4. Correct all interference conditions before operating the vehicle.

**Note:** The center pin of the standard seven-pin trailer electrical connector has been standardized as the dedicated connection for uninterrupted power for trailer ABS. This pin is always hot when the tractor ignition is turned on.



### **DANGER**

*Some trailers manufactured prior to the trailer ABS regulations may use the center pin to power certain trailer auxiliary equipment. The possibility exists that this auxiliary equipment may be unexpectedly activated by the truck or tractor electrical system, resulting in personal injury or damage to equipment. Caution must be used when connecting the trailer electrical connector to ensure that power to the center pin will not unintentionally activate any trailer auxiliary equipment.*

## Automatic Traction Control (ATC) (If Equipped)

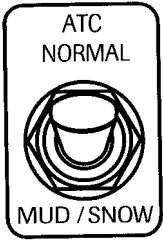

W3001113

Automatic Traction Control (ATC) provides improved traction on slippery surfaces by reducing wheel spin. The system operates automatically as follows:

- If a drive wheel starts to spin, ATC applies air pressure to the brake of the spinning wheel. Doing this transfers engine torque to the wheels that have better traction.
- If all drive wheels are spinning, ATC limits engine torque which, in turn, reduces wheel spin to provide improved traction.

When ATC automatically becomes active, the ATC indicator lamp turns on to alert the operator. The lamp turns off when the wheel(s) stops spinning.

### ***Heavy Mud/Snow Function (If Equipped)***

ATC may also include a heavy mud/snow function which allows the operator to activate ATC when additional traction is needed. This function is activated with the ATC mode switch which is located on the dashboard. The heavy mud/snow function increases available traction by increasing permissible wheel spin.

When the operator selects the heavy mud/snow function, the ATC indicator lamp blinks continuously. The ATC lamp stops blinking when the ATC mode switch is turned off.

---

## GOOD DRIVING HABITS

### Weight Ratings

Do not overload the vehicle. The gross vehicle weight rating (GVWR) and gross axle weight ratings (GAWR's) for a given model may vary due to the tires, wheels/rims, suspensions, axles and/or frame of a specific vehicle. For safety and durability reasons, do not exceed the GVWR and GAWR's listed on your vehicle's Safety Certification Label.

### Instruments

Glance at the instruments frequently. When problems develop, take prompt steps to correct them.

### Shutting Down the Engine

After a hard run, allow the engine to idle three minutes before shutdown to stabilize the temperature of all engine parts. Quick shutdowns can cause engine damage and prevent the turbocharger from being properly lubricated. For additional options, see .

### General Observation

Make it a habit at stops to walk around your truck and look for fuel, oil and coolant leaks. Also check the condition of tires, wheel nuts, springs and lights. Stop trouble before it stops you!

---

## STARTING THE VEHICLE

### General Information

Before putting the key in the ignition switch, set the parking (spring) brake, disengage the clutch (if equipped) and put the transmission in NEUTRAL.



#### CAUTION

*Do not engage the starting motor too soon after an incomplete start of the engine, or the starter may be damaged. Wait at least five seconds before attempting to restart the engine.*



#### CAUTION

*If the engine does not start immediately, limit cranking periods to 30 seconds to avoid overheating and damaging the starter.*



#### CAUTION

*Do not rev the engine at start-up. Turbocharger damage may result because lubricants need time to establish a film between moving parts.*

### Push Button Starters

Put the key in the ignition switch. Turn the key clockwise to the first "click" (about two o'clock position) to activate the instruments. Depress the starter button and release as soon as the engine starts. Keep the clutch (if equipped) disengaged until the engine runs smoothly.

## Air Starters

On chassis equipped with an air starter, make sure that the air pressure gauge reads a maximum of 827 kPa (120 psi) before shutting down and parking for the night. This will ensure sufficient air pressure for restarting the engine.



### WARNING

**Make sure clutch is depressed and transmission is in neutral before engaging the starter! Failure to do so could cause the vehicle to jerk forward unexpectedly causing serious damage or bodily harm.**

### Starting MP Engines

Use the following procedure:

1. Crank the engine until it starts.

**Note:** Do NOT apply the throttle pedal during engine cranking.



### CAUTION

*DO NOT engage the starting motor too soon after an incomplete start of the engine, or the starter may be damaged. Wait at least five seconds before attempting to restart the engine.*

*If the engine does not start immediately, limit cranking periods to 30 seconds to avoid overheating and damaging the starter.*

*DO NOT rev the engine at start-up. Turbocharger damage may result. Lubricants need time to establish a film between moving parts.*

2. After the engine has started, warm the engine until the coolant temperature reaches normal operating range (77°C to 107°C; 170°F to 225°F). Once the engine reaches this temperature, it can be operated in a normal fashion.

**Note:** Warm-up time can be reduced by increasing engine idle speed between 1000 and 1200 rpm by either applying the throttle pedal or by using the Electronic Hand Throttle feature (if equipped).

**Note:** For bobtail or unloaded applications, the engine may be warmed up by moving the vehicle with "light" throttle application after only one minute of idle.



## Priming the MP Fuel System



### DANGER

*Before working on or inspecting a vehicle, set the parking brakes, place the transmission in neutral and block the wheels. Failure to do so can result in unexpected vehicle movement and can cause serious personal injury or death.*



### DANGER

*To avoid potential fire hazard, do not service any part of the fuel system while smoking or in the presence of flames, sparks or hot surfaces, or when working on an operating engine. Failure to follow these precautions can result in fire. To guard against burns from direct contact with hot fuel, wear adequate protective clothing (face shield, heavy gloves and apron, etc.) when working on a hot engine.*



### WARNING

**DO NOT** work near the fan with the engine running. The engine fan can engage at any time without warning. Anyone near the fan when it turns on could be seriously injured. Before turning on the ignition, be sure that no one is near the fan.

1. Unlock the hand primer pump by pushing the pump handle in and turning it counterclockwise.

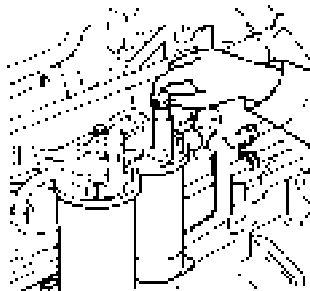

C0029336

2. Pump the hand primer until the force of pumping increases.



C0029337

**Note:** When the fuel system is empty, 200 or more pump strokes may be needed to properly prime the system.

**Note:** There are NO bleed nipples to be opened in order to prime the fuel system.

3. Lock the hand primer pump by retracting it into the housing and turning it clockwise.
4. Start the engine and run it at an increased idle speed for approximately 5 minutes to remove any remaining air in the system.
5. Check the fuel system for leaks.

**Note:** If the engine does not start following this procedure, contact your local MACK dealer.

---

## Engine Warm-Up



### CAUTION

*Idling the engine unnecessarily for long periods of time wastes fuel and fouls injection nozzles. Unburned fuel causes carbon formation and oil dilution. NEVER race an engine during warm-up.*

Engine damage can occur if the engine is not warmed up to a minimum operating temperature of 77°C (170°F) before putting the vehicle into full .

Heavy-duty diesel engines are designed to operate at optimum efficiency when they are running loaded at (or very near) normal operating temperature, where efficient combustion takes place. When the engine is operated unloaded, lightly loaded (i.e., stop-and-go , PTO s, or periods of extended engine idling) or in cold weather conditions, normal operating temperature may not be achieved or maintained. As a result, carbon and/or varnish build-up will occur and lubricating oil will become contaminated with combustion by-products.

Cold weather place added demands on a diesel engine. When operating in cold climates (particularly in stop-and-go , PTO or periods of extended engine idling), minimum operating temperature must be maintained to prevent engine damage resulting from valve varnishing and carbon build-up.

**Note:** Many accessories are available for cold weather. Refer to the Maintenance and Lubrication Manual (21394653) for additional information concerning cold weather accessories.

## Engine Idling

Idling the engine unnecessarily for long periods of time wastes fuel, fouls injector nozzles and can lead to valve carbon and varnish deposits. Unburned fuel causes carbon formation and oil dilution. Shut the engine down when prolonged loading or unloading of cargo is required.

When starting a cold engine, or if the vehicle has been parked and the engine coolant has fallen well below normal operating temperature, a fast idle speed of approximately 1200 rpm should be maintained to help the engine warm up more quickly.

---

## Shutting Down the Engine

### **Standard Shutdown**

After a hard run, allow the engine to idle three minutes before shutdown in order to stabilize the temperature of all engine parts. Quick shutdowns can cause engine damage and prevent the turbocharger from being properly lubricated.



### **CAUTION**

*Operating the engine below normal operating temperature for extended periods of time will allow varnish/carbon deposits to build up on the valve stems and guides. This will cause the valves to stick in the guides after the engine has been shut down and could result in valve damage when the engine is restarted. If the engine has been operated below normal operating temperature for an extended period of time (and the odor of raw diesel fuel is detected or unburned fuel can be seen at the exhaust stack), the engine should be operated under "load" until normal operating temperature is achieved BEFORE shutting down the engine.*

On chassis equipped with an air starter, make sure that the air pressure gauge reads a maximum of 827 kPa (120 psi) before shutting down and parking for the night. This will ensure sufficient air pressure for restarting the engine.

### **V-MAC IV Shutdown Option: Idle Cooldown**

This feature provides a means of cooling down the engine and turbocharger. If the idle cooldown option is enabled using VCADS Pro MACK Support Software and the system senses that the turbocharger may be hot, the engine will not shut down when the vehicle stops, the parking brake is set and the key switch is turned to the OFF position. This feature allows the driver to lock the truck and walk away while still providing adequate cooldown. All switched accessories will then turn off once the engine has stopped. If this option is set, the engine can be shut down immediately by cycling the key switch or by pressing the shutdown override switch.

The idle cooldown timer is set to 3.5 minutes as soon as the engine load exceeds 25%, provided that the engine has been running at least 60 seconds. After the load drops below 25%, the timer begins counting down. If the key switch is turned off before the timer expires, the engine will continue to run until the timer reaches zero.

If a pyrometer is installed, the idle cooldown function will use the pyrometer reading, shutting the engine down when the temperature drops below 232°C (450°F), or after 3.5 minutes, whichever comes first.

The default for this option is set at OFF from the factory.

<https://www.truck-manuals.net/mack/>

**Note:** The parking brake must be on for the idle cooldown function to work.

### ***Engine Shutdown System (If Enabled)***

The engine is protected by a system that prevents engine damage by shutting down the engine whenever a potentially damaging condition (such as loss of oil pressure, loss of coolant or engine overheating) is detected. If the system detects such a condition, a warning indicator light and an alarm will alert the driver before the engine actually shuts down. Pressing the Shutdown Override Switch on the instrument panel shortly after the vehicle sounds the engine shutdown alarm, allows 30 additional seconds of . This process can be repeated several times to safely park the vehicle.



### **CAUTION**

*Continuously overriding the shutdown system may result in severe engine damage.*

**Engine Shutdown Indicator** — During normal operating conditions, this indicator should illuminate as soon as the key switch is turned on. After the engine is started, it will remain illuminated until engine oil pressure reaches normal idling range. During shutdown, if the system detects a condition that could lead to engine failure, the Engine Shutdown indicator will illuminate prior to engine shutdown.

---

## COLD WEATHER OPERATION



### DANGER

**Do NOT, under any circumstances, use starting fluid (ether) on engine whether or not equipped with an inlet manifold air heater element. An explosion can occur.**

### Cold Weather Starting Tips

- Save the batteries. Do not overtax the batteries by cranking the starter for more than 30 seconds without interruption. Allow about two minutes between attempts at starting the vehicle; this allows the starter to cool and the batteries to re-energize.

**Note:** Always make sure that the battery is fully charged in cold weather.

- Use the correct grade of oil for the prevailing winter temperature.
- Drain the fuel tanks and filters regularly to prevent water accumulation in the fuel system. This accumulation can freeze in fuel tanks, fuel lines and filters.



### WARNING

**Do NOT — under any circumstances — add gasoline, alcohol, used oil or additives with metallic particles to the fuel.**

- If the fuel gels and starts clogging filters and small passages, mix a small percentage of No. 1D fuel (kerosene) with Ultra-Low Sulfur (15 ppm max.) No. 2D (diesel) fuel.

**Note:** Adding kerosene is NOT recommended for general use because both performance and fuel economy will be reduced.

- Refer to the *Maintenance and Lubrication Manual (21394653)* for additional cold weather operating information.

## Engine Block Heaters

An engine block heater works by heating the coolant surrounding the combustion chambers. Engine heaters are recommended to help combat the extreme demands of cold weather operating conditions. When the temperature drops, the engine heater can be plugged in overnight. The location of the engine heater power receptacle varies according to vehicle design.

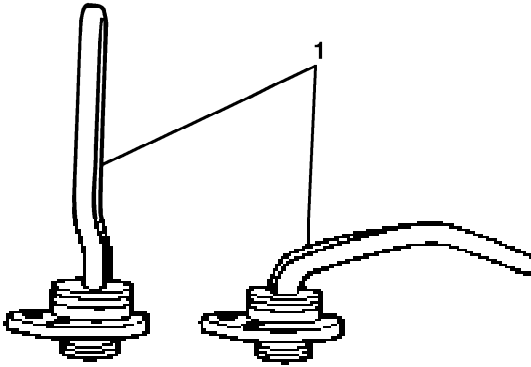

C0029338

### 1. Engine Block Heaters

#### ***Engine Heater Benefits***

- Eliminates cold weather starting problems.
- Increases engine life significantly by keeping the engine warm and avoiding costly, excessive idling.
- Prevents external water leaks caused by excessive cold.
- Allows the cab to heat more quickly.
- Allows the engine heaters to be activated as soon as the engine is stopped.

## Winterfronts

A winterfront, although not recommended, may be used during cold weather, with sustained temperatures below  $-25^{\circ}\text{C}$  ( $-13^{\circ}\text{F}$ ), to aid the engine in reaching and maintaining engine coolant temperatures within the normal operating range.



### CAUTION

*Use a winterfront designed for the specific chassis. Restricted air flow through the charge air cooler can cause higher exhaust temperatures, power loss, excessive fan usage, reduced fuel economy and possible engine or charge air cooler damage. The use of any other type of device, such as a radiator cover, cardboard or similar material, is not approved by Mack Trucks, Inc.*

**Note:** The minimum operating temperature is  $77^{\circ}\text{C}$  ( $170^{\circ}\text{F}$ ).

If a winterfront is used, a MACK-approved exhaust pyrometer must also be installed and closely monitored while the engine is in .



### CAUTION

*DO NOT exceed the maximum exhaust temperature listed on the pyrometer decal. To reduce exhaust temperature, open the winterfront, downshift or reduce engine power.*



Refer to the following chart for suggested temperature ranges concerning the use of various cold-weather accessories.

| Expected Sustained Coldest Ambient Temperature Range                   | Winterfronts   | Belly Tarp  | Inside/Outside Air |
|--|--|-------------|--------------------|
| 4°C (40°F)<br>0°C (32°F)<br>-7°C (20°F)<br>-12°C (10°F)<br>-18°C (0°F) | Prohibited   | Prohibited  | Available          |
|  |  | Available   | Suggested          |
|  | -23°C (-10°F)<br>-25°C (-13°F)<br>-35°C (-30°F)<br>-40°C (-40°F) | Can be Used | Recommended        |

|  |                |
|--|----------------|
|    | <b>CAUTION</b> |
| <p><i>Winter treatments are NOT RECOMMENDED for vehicles which only operate intermittently in cold climates. Sustained temperatures must be below -25°C (-13°F).</i></p> |                |

|   |                |
|---|----------------|
|   | <b>CAUTION</b> |
| <p><i>Never fully close the winterfront if equipped with viscous fan drive.</i></p> |                |

For more information on winterfronts, please refer to the *Maintenance and Lubrication Manual (21394653)*.

**ON-BOARD SCALES (OPTIONAL)**

If your chassis is equipped with an optional Tractor Scale System, the following gauge will be located on the D Panel directly above the radio box.

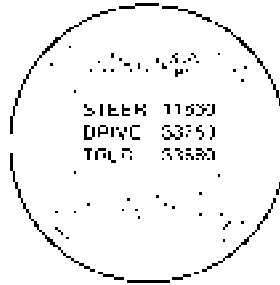

C0029339

### Tractor Scale Display

Your chassis may be equipped with an optional Tractor Scale System. The AW5800 on-board scale converts tractor and trailer suspension loads to an accurate on-ground weight. By comparing empty and loaded axle group weights with empty and loaded suspension pressures, the scale can be calibrated to display accurate weights for any air suspension load.

For more information on this optional feature, please refer to the *Air-Weigh Installation, Calibration and Manual* .

## COUPLING A TRAILER

1. Position the tractor directly in front of the trailer.
2. Back the trailer slowly until the fifth wheel just contacts the trailer plate.
3. Place the transmission in neutral and apply the parking brakes.
4. Connect the trailer glad hands and electrical connector.



### CAUTION

*Make sure the trailer air lines and the trailer electrical cord are properly supported so they will not be pinched or caught while the tractor is being backed under the trailer.*

5. Check that the fifth wheel height matches the height of the underside of the trailer. If the trailer is too high, use the landing gear to lower the trailer until fifth wheel and trailer height match. If the vehicle is equipped with an air suspension and the trailer is too low, use the air suspension control switch to exhaust air from the suspension air bags until fifth wheel and trailer height match.



### CAUTION

*Failure to match fifth wheel height with trailer height will result in the trailer being improperly connected.*

6. Back under the trailer slowly until the trailer king pin engages. Back slowly to avoid hitting the king pin too hard, and stop as soon as the king pin is locked into the fifth wheel.
7. If equipped with an air suspension, use the air suspension control switch to reinflate the suspension air bags.
8. Raise the trailer landing gear slightly off the ground.
9. With the trailer parking brakes applied, pull the tractor ahead slightly to ensure that the trailer is locked onto the tractor.
10. Push the trailer air supply valve (red octagonal knob) in to supply the trailer system with air pressure. With the air system at normal operating pressure, check the trailer air brake system for excessive leakage and proper .

11. Inspect the coupling to ensure the trailer is properly connected. Make sure there is no space between the fifth wheel and the trailer plate and that the fifth wheel jaws have closed around the shank of the king pin. Check that the locking lever is in the "lock" position and make sure the safety latch is in position over the locking lever.
12. After ensuring that the trailer is properly connected, raise the landing gear to its maximum height.
13. If wheel chocks were placed at the trailer wheels, remove the chocks and store.

**CAUTION**

*If equipped with an air suspension, do NOT operate the vehicle with the suspension air bags deflated. Always reinflate the suspension air bags after coupling or uncoupling a trailer.*

## UNCOUPLING A TRAILER

1. Park the tractor/trailer combination on a level surface. Make sure the parking surface will support the weight of the trailer, and make sure that the tractor is lined up straight with the trailer. Pulling out from under a trailer at an angle may damage the landing gear.
2. Pull the trailer air supply valve (red octagonal knob) out to apply the trailer parking brakes.
3. Back the tractor slightly to ease pressure on the fifth wheel jaws. Apply the tractor parking brakes while still backing against the king pin so the combination will be held with pressure off the fifth wheel jaws.
4. Block the trailer wheels to prevent the trailer from moving.
5. Lower the trailer landing gear until the gear makes firm contact with the ground.
6. Disconnect the glad hands and the trailer electrical connector. Connect the glad hands to the dummy couplers at the back of the tractor and install the trailer electrical connector into the receptacle provided at the back of the cab.



### CAUTION

*Make sure the trailer air lines and electrical cord are properly suspended so they will not become tangled or damaged while the tractor is being driven.*



### WARNING

**Keep legs and feet clear of the tractor rear wheels to avoid serious injury should the vehicle move when the fifth wheel is unlocked.**

7. Unlock the fifth wheel.
8. Pull the tractor ahead slightly (approximately twelve inches) so that the king pin disengages the fifth wheel jaws.
9. If equipped with an air suspension, use the air control switch to exhaust the air from the suspension air bags.
10. Pull the tractor ahead until the fifth wheel is out from under the trailer. Stop the tractor with frame under the trailer. This prevents the trailer from falling should the landing gear collapse or sink into the ground.
11. Place the transmission in neutral and apply the parking brakes.

- 
12. Inspect the parked trailer to make sure the ground is supporting the trailer and the landing gear is not damaged.
  13. If equipped with an air suspension, use the air suspension control switch to reinflate the suspension air bags.
  14. Release the parking brakes and drive the tractor forward until the tractor is clear of the trailer.

**CAUTION**

*If equipped with an air suspension, do NOT operate the vehicle with the suspension air bags deflated. Always reinflate the suspension air bags after coupling or uncoupling a trailer.*

## MOVING THE VEHICLE — GENERAL INFORMATION

### Braking

Avoid sudden stops. Constant sudden stops may negatively affect braking performance and driving parts. When slowing, leave the clutch (if equipped) engaged as long as possible to use the braking effect of the engine.



#### CAUTION

*When using the braking effect of the engine, final gear selection is critical. If gear selection is too high, the vehicle will buck which could cause loss of control.*

### Shifting

Operate in a gear low enough to allow the engine to accelerate to (or maintain) governed engine speed when applying full throttle. Allowing the engine to lug causes excessive strain on the engine, which could damage pistons, rings, cylinder walls, or bearings. However, be sure not to overspeed the engine.



#### DANGER

*Always select the proper gear ratio BEFORE descending a grade (to avoid a runaway vehicle and to stay within safe and legal speed limits). Do NOT coast down hills. Gear ratios should be selected to allow the engine to operate between peak torque and rated speed.*



#### DANGER

*If your vehicle is equipped with an Eaton® Fuller® Autoshift™ transmission, selecting "D" on downhill grades will cause automatic upshifts. To prevent unwanted upshifts, preselect "Manual" or "H". Engine must be kept below 2100 rpm to allow commanded upshifts. See the Eaton Driver Instructions manual for more details.*

**CAUTION**

*Do not permit a load to drive the engine above governed speed. When descending steep grades, use lower gears and watch the tachometer. Overspeeding will cause severe drivetrain damage and eventually destroy the engine.*

**CAUTION**

*Running the engine at a speed that is too low for the load (or grade of the road) can cause damage to the drivetrain.*

Shifting at the proper time will result in increased fuel efficiency, as well as a decrease in costly repairs. Remember that once the engine falls below peak torque, both torque and horsepower will drop off very rapidly. Before this happens, downshift to the next lower gear.

For vehicles with transmissions that have extreme reduction gearing coupled with high rear-axle loads, a torque-limiting device should be used. This device limits the amount of fuel that can be delivered to the engine and prevents overloading of drivetrain components while in extreme reduction gears.

Always use the same gear going downhill as uphill. This will reduce brake wear and prevent damage to the engine from overspeeding.

## Engine Temperature

Before entering high-speed traffic conditions, allow the engine to reach normal operating temperature. A normal operating range is between 77°C and 104°C (170°F and 220°F) for stationary vehicles.



## Clutch (If Equipped)

To avoid shock damage, release the clutch pedal smoothly, without shock-loading the driveline (especially on grades while carrying heavy loads). Do not ride the clutch pedal. Premature wear of the clutch facing and release bearing may result.



### CAUTION

*Always use the lowest drive gear combination to start the vehicle moving to avoid premature clutch failure.*

1. To move the vehicle, start the engine and wait until it reaches operating temperature.
2. Disengage the clutch by pushing the pedal to the floor.
3. Shift the transmission into first or LO gear (see "Transmission Shifting Instructions" for specific procedures).
4. Release the parking brake.



### CAUTION

*If the Parking Brake indicator is on, do NOT attempt to move the vehicle because driveline damage may result.*

5. Engage the clutch smoothly by allowing the clutch pedal to come up slowly. For comfortable starts, do not apply the accelerator until the clutch begins to engage.



### CAUTION

*Never allow your foot to ride the clutch pedal when the clutch is engaged. This will cause premature failure and increased clutch wear.*

6. As the vehicle gains speed, continue shifting until the transmission is in the highest gear possible (with engine in operating range).

**Note:** When the vehicle is equipped with a torque-limiting device, the engine must be warmed up to operating temperature before attempting to move in either REVERSE or LO-LO range.

### **Clutch Brake**

The clutch brake is designed to stop the rotation of the transmissions input shaft while the truck is standing still. This makes shifting into first or reverse gears easier.

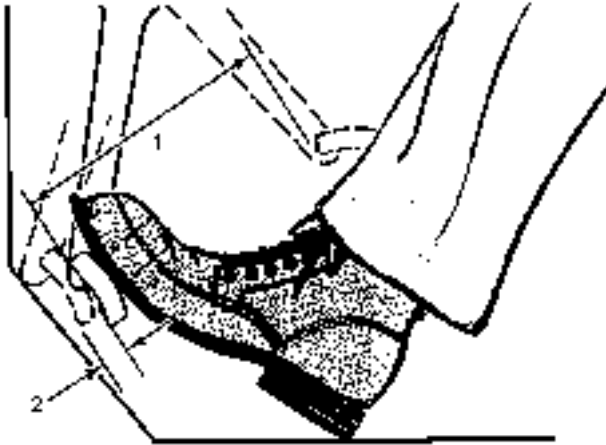

C0029340

1. Normal Clutch Pedal Travel

2. Depress Pedal last 13 mm (1/2 inch) to 25 mm (1 inch) to Engage Clutch Brake (amount of clutch brake travel varies depending on the system and overall tolerances)

1. With the vehicle standing still, apply the clutch brake by pushing the clutch pedal all the way to the floor: the clutch brake is applied when the clutch pedal is fully depressed (approximately the last 13 mm (1/2 inch) to 25 mm (1 inch) of pedal travel past normal, of clutch brake pedal travel, varies between the air assist and non assist release systems. The variance includes general tolerances and amount of pedal free-play. Typically about the last 13 mm (1/2" inch) on the air assist and about the last 25 mm (1 inch) on the non assist control systems).

**Note:** When the clutch is disengaged, a slight but definite resistance to clutch pedal downward travel will be felt in approximately the last 13 mm (1/2 inch) to 25 mm (1 inch).



## CAUTION

Vehicles equipped with the air assist clutch control system use less pedal travel. The clutch brake engages sooner in the pedal stroke than conventional non assist systems. To avoid system damage, be careful not to engage the clutch brake during normal shifting.

2. Shift the transmission into first or reverse gear, engage the clutch and accelerate. The clutch brake is only to be used when the vehicle is stopped and is shifted into first or reverse gears. It is not designed to be used as an upshifting aid.



## CAUTION

*Clutch brake damage may result if used while the vehicle is in motion. The clutch brake must NOT be used when making a downshift or an upshift.*

***Double-Clutching***

Double-clutching is a way to bring the speed of the transmission gears into synchronization so that the shift can be made without a clash. The engine is used to speed up the counter shaft for a downshift and to slow it down for an upshift.

**Note:** For all non-synchronized transmissions, double-clutching is necessary on downshifts and upshifts. It is advisable to use the torque-limiting clutch brake to engage first and REVERSE gears and to double-clutch for gear ratio changes.

1. Depress the clutch pedal and shift to NEUTRAL.
2. Release the clutch pedal and increase (downshift) or decrease (upshift) engine speed until it roughly corresponds to the road speed of the desired gear.
3. Depress the clutch pedal and complete the shift. Then release the clutch pedal.

## POWER TAKE-OFF (PTO)

If the vehicle is equipped with a Power Take-Off (PTO) unit, be sure to read the following section.

### PTO Precautions



#### DANGER

*Power Take-Off (PTO) units and related equipment can be very dangerous. Any PTO installation, repair or replacement should include a warning indicator light which indicates PTO engagement. The light must be located close to the PTO control and clearly visible to the operator.*



#### DANGER

*PTO units are driven by engine or drivetrain components (flywheel, crankshaft, transmission). Do not attempt to service the PTO and related units unless the engine is shut down.*



#### DANGER

*Always keep body parts and loose-fitting clothing out of the range of drivetrain components, or personal injury may result.*



#### DANGER

*Always be aware of the current PTO status (engaged or disengaged) and the position of the vehicle body (dump body controlled by PTO, etc.). Be sure to disengage the PTO when not in use.*

---

## PTO Classification

Rear-mounted PTO units, for MACK transmissions, are categorized according to .

**Intermittent Service** — The PTO unit is operated, under load, for less than seven minutes and then allowed to cool before it is operated again.

**Note:** If a PTO unit is operated for less than seven minutes but is "not" allowed to cool down before operating again, it is considered in Continuous Service.

**Continuous Service** — The PTO unit is operated, under load, for seven minutes or more.

**Note:** Rear-mounted PTO units operating under the Continuous Service guideline must not be run at more than 70% of the PTO output-rated torque/horsepower.

## Side-Mounted PTO Locations

The first choice location for Side-Mounted PTOs is either of the PTO openings on the main box.

The second choice, which is the compound PTO opening, is restricted to those applications specifically requiring multi-speed PTOs with reverse capability, such as some mechanical winches or unique speed or multiple PTO requirements. However, a word of caution is in order when using these locations. Operators should be trained to understand and follow the proper operating procedures as described in the cab instructions, and avoid using the neutralizing feature as a power disconnect for vehicle propulsion.

## PTO Operating Procedures

Specific PTO operating procedures are described at the end of applicable transmissions in the following section.

---

## TRANSMISSION SHIFTING INSTRUCTIONS



### CAUTION

*The maximum safe operating oil temperature for MACK transmissions is 121°C (250°F) for mineral-based oil, and 148°C (300°F) for synthetic-based oil. Continued with oil above this temperature will result in rapid deterioration of the oil's lubricating properties and is NOT recommended.*



### CAUTION

*To avoid transmission damage, the vehicle must be completely stopped before being shifted from REVERSE to any forward speed (and vice versa).*



### CAUTION

*Never coast with the transmission in neutral. Never coast with the clutch depressed.*

## Shifting Instructions for Allison Automatic Transmissions

Please refer to the applicable Allison automatic transmission operator's manual provided with your vehicle for complete shifting and operating instructions.

## MACK T306G Shifting Instructions

The T306G is a six-speed overgear, non-synchronized transmission designed for general highway use. Shifting is accomplished through a single shift lever using the traditional H pattern.

**Upshift** — Start out in first gear and shift up to second, third, fourth, fifth and sixth gears, double-clutching from one gear to the next.

**Downshift** — Downshift in reverse order (sixth through first), double-clutching through each gear.

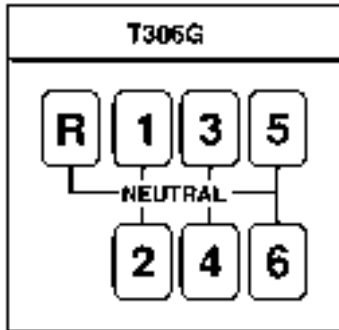

C0029341

### T306G TRANSMISSION RATIOS

| Gear    | Ratio |
|---------|-------|
| 1       | 7.50  |
| 2       | 4.08  |
| 3       | 2.41  |
| 4       | 1.50  |
| 5       | 1.00  |
| 6       | 0.71  |
| Reverse | 8.84  |



## MACK TM308 Shifting Instructions



### CAUTION

*Make sure air pressure is at least 620 kPa (90 psi) and unit is warmed before shifting the transmission. To avoid transmission damage, do NOT change range while moving in REVERSE. Use of the clutch brake is for shifting into first and reverse gears only. Do not use the clutch brake to shift out of gear. Be careful not to overspeed the engine during downshifting. Damage to powertrain components can result.*

The TM308 is a non-synchronized transmission having a total of eight speeds (6+2) with a non-synchronized air shifted compound section. This LO and HI auxiliary compound section is controlled by an air-shift range selector valve located on the shift lever. The LO range has two low gear ratios. In HI range there are six forward gears which can be shifted in the normal manner, but remember to double-clutch whether moving up or down through the gears. For normal highway use, start in HI range, first gear and shift through second, third, fourth, fifth and sixth. The ratio step between fifth and sixth is smaller than all the other ratio steps. The two gears in LO range are designed for off-highway use and in slow-moving s (curb pouring, material spreading, heavy load, steep grade).

**Reverse** — Reverse can be used in LO or HI range. To make a range shift in reverse, bring the truck to a complete stop. Flip the range selector lever to range desired.

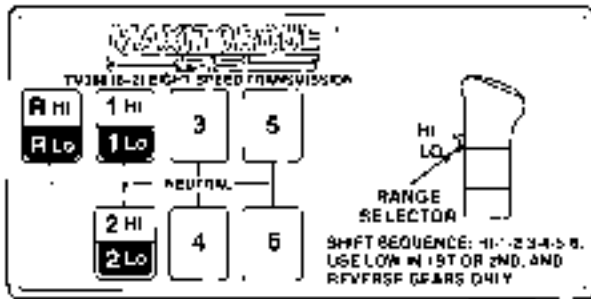

C0029342

### TM308 TRANSMISSION RATIOS

| Gear (Main Box) | Ratios   |          |
|-----------------|----------|----------|
|                 | LO Range | Hi Range |
| First Lo        | 17.77    |          |
| Second Lo       | 10.94    |          |
| First Hi        |          | 6.57     |
| Second Hi       |          | 4.05     |
| Third Hi        |          | 2.54     |
| Fourth Hi       |          | 1.57     |
| Fifth Hi        |          | 1.00     |
| Sixth Hi        |          | 0.71     |
| Reverse Lo      | 18.36    |          |
| Reverse Hi      |          | 6.79     |

## MACK TM308M Shifting Instructions



### CAUTION

*Make sure air pressure is at least 620 kPa (90 psi) and unit is warmed before shifting the transmission. Use of the clutch brake is for shifting into first and reverse gears only. Do not use the clutch brake to shift out of gear. Be careful not to overspeed the engine during downshifting. Damage to powertrain components can result.*

The TM308M is a non-synchronized transmission having a total of eight speeds (6+2) with a non-synchronized air shifted compound section. This LO and HI auxiliary compound section is controlled by an air-shift range selector valve located on the shift lever. The LO range has two low gear ratios. In HI range there are six forward gears which can be shifted in the normal manner, but remember to double-clutch whether moving up or down through the gears.

For normal highway use, start in HI range, first gear and shift through second, third, fourth, fifth and sixth. The ratio step between fifth and sixth is smaller than all the other ratio steps. The two gears in LO range are designed for off-highway use and in slow-moving s (curb pouring, material spreading, heavy load, steep grade).

**Reverse is used in LO range only. To avoid transmission damage when shifting Forward to Reverse or Reverse to Forward:**

- Bring vehicle to a stop.
- Move lever to NEUTRAL.
- Select low range.
- Select F or R as desired.
- Select lowest lever gear position.
- Release and depress clutch pedal.
- Select desired gear.

**CAUTION**

*Vehicle operators must use extreme caution if operating a truck in the higher reverse gears. Higher reverse gears will produce high reverse speeds which may be difficult for drivers to control dependent on terrain or obstacles.*

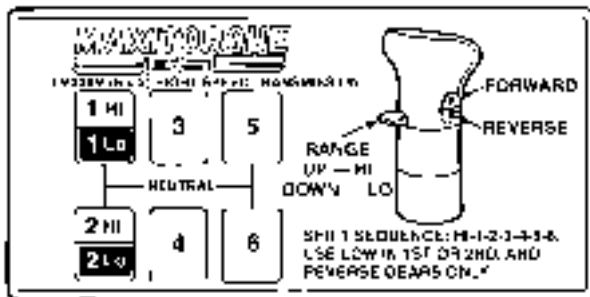

C0029343

**TM308M TRANSMISSION RATIOS**

| Gear (Main Box) | Ratios   |              |         |
|-----------------|----------|--------------|---------|
|                 | LO Range | Direct Range | Reverse |
| First Lo        | 17.77    |              | 15.59   |
| Second Lo       | 10.94    |              | 9.60    |
| Third Lo        |          |              | 6.02    |
| Fourth Lo       |          |              | 3.73    |
| Fifth Lo        |          |              | 2.37    |
| Sixth Lo        |          |              | 1.69    |
| First Hi        |          | 6.57         |         |
| Second Hi       |          | 4.05         |         |
| Third Hi        |          | 2.54         |         |
| Fourth Hi       |          | 1.57         |         |
| Fifth Hi        |          | 1.00         |         |
| Sixth Hi        |          | 0.71         |         |

## MACK TM309 Shifting Instructions



### CAUTION

*Make sure air pressure is at least 620 kPa (90 psi) and unit is warmed before shifting the transmission. To avoid transmission damage, do NOT change range while moving in REVERSE. Use of the clutch brake is for shifting into first and reverse gears only. Do not use the clutch brake to shift out of gear. Be careful not to overspeed the engine during downshifting. Damage to powertrain components can result.*

The TM309 is a non-synchronized transmission having a total of nine speeds (6+3) with an air shifted non-synchronized compound section. This LO and HI auxiliary compound section is controlled by an air-shift range selector valve located on the shift lever. The LO range has three low gear ratios. In HI range there are six forward gears which can be shifted in the normal manner, but remember to double-clutch whether moving up or down through the gears. For normal highway use, start in HI range, first gear and shift through second, third, fourth, fifth and sixth. The ratio step between fifth and sixth is smaller than all the other ratio steps. The three gears in LO range are designed for off-highway use and in slow-moving s (curb pouring, material spreading, heavy load, steep grade). Only start in the lowest gear necessary to move the vehicle. The extreme LO gear (1st low) is intended for vehicular speed control and not for torque multiplication.

**Reverse** — Reverse can be used in LO or HI range. To make a range shift in reverse, bring the truck to a complete stop. Flip the range selector lever to range desired (preselect). Move the shift lever out of reverse through NEUTRAL and then back into reverse again. As the lever moves through NEUTRAL, the range shift will be completed.

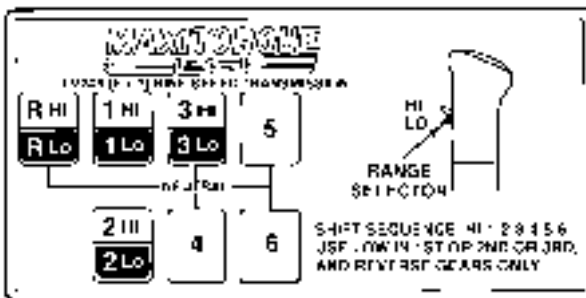

C0029344

### TM309 TRANSMISSION RATIOS

<https://www.truck-manuals.net/mack/>

| Gear (Main Box) | Ratios   |          |
|-----------------|----------|----------|
|                 | LO Range | Hi Range |
| First Lo        | 25.21    |          |
| Second Lo       | 15.52    |          |
| Third Lo        | 9.73     |          |
| First Hi        |          | 6.57     |
| Second Hi       |          | 4.05     |
| Third Hi        |          | 2.54     |
| Fourth Hi       |          | 1.57     |
| Fifth Hi        |          | 1.00     |
| Sixth Hi        |          | 0.71     |
| Reverse Lo      | 25.67    |          |
| Reverse Hi      |          | 6.79     |

## MACK TM309M Shifting Instructions



### CAUTION

*Make sure air pressure is at least 620 kPa (90 psi) and unit is warmed before shifting the transmission. Use of the clutch brake is for shifting into first and reverse gears only. Do not use the clutch brake to shift out of gear. Be careful not to overspeed the engine during downshifting. Damage to powertrain components can result.*

The TM309M is a non-synchronized transmission having a total of nine speeds (6+3) with an air shifted non-synchronized compound section. This LO and HI auxiliary compound section is controlled by an air-shift range selector valve located on the shift lever. The LO range has three low gear ratios. In HI range there are six forward gears which can be shifted in the normal manner, but remember to double-clutch whether moving up or down through the gears.

For normal highway use, start in HI range, first gear and shift through second, third, fourth, fifth and sixth. The ratio step between fifth and sixth is smaller than all the other ratio steps. The three gears in LO range are designed for off-highway use and in slow-moving s (curb pouring, material spreading, heavy load, steep grade). Only start in the lowest gear necessary to move the vehicle. The extreme LO gear (1st low) is intended for vehicular speed control and not for torque multiplication.

**Reverse is used in LO range only. To avoid transmission damage when shifting Forward to Reverse or Reverse to Forward:**

- Bring vehicle to a stop.
- Move lever to NEUTRAL.
- Select low range.
- Select F or R as desired.
- Select lowest lever gear position.
- Release and depress clutch pedal.
- Select desired gear.



**CAUTION**

*Vehicle operators must use extreme caution if operating a truck in the higher reverse gears. Higher reverse gears will produce high reverse speeds which may be difficult for drivers to control dependent on terrain or obstacles.*

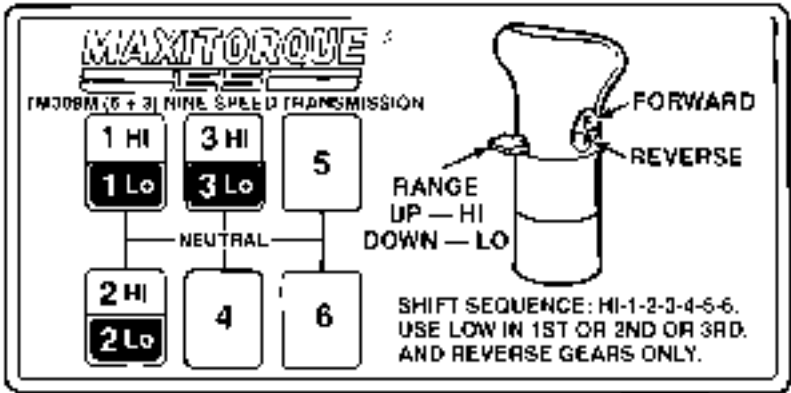

C0029345

### TM309M TRANSMISSION RATIOS

| Gear (Main Box) | Ratios   |              |         |
|-----------------|----------|--------------|---------|
|                 | LO Range | Direct Range | Reverse |
| First Lo        | 25.21    |              | 22.12   |
| Second Lo       | 15.52    |              | 13.62   |
| Third Lo        | 9.73     |              | 8.54    |
| Fourth Lo       |          |              | 5.30    |
| Fifth Lo        |          |              | 3.37    |
| Sixth Lo        |          |              | 2.40    |
| First Hi        |          | 6.57         |         |
| Second Hi       |          | 4.05         |         |
| Third Hi        |          | 2.54         |         |
| Fourth Hi       |          | 1.57         |         |
| Fifth Hi        |          | 1.00         |         |
| Sixth Hi        |          | 0.71         |         |



## MACK T309, T309L and T309LR Shifting Instructions



### CAUTION

*Make sure air pressure is at least 620 kPa (90 psi) and unit is at operating temperature before making range shifts. Always start in LO range. This also applies to dynamometer testing. When the truck is stationary, do NOT shift into HI range and then start moving the truck. Otherwise, damage to the synchronizer may result.*

The T309 unit is a range-shifted transmission which has eight forward highway speeds plus an extra LO speed gear in the LO range. This transmission features a LO and HI auxiliary compound section controlled by an air-shift range selector located on the shift lever. The compound section is equipped with a synchronizer to facilitate LO-HI range shifting.

The LO range provides five low ratios. Never attempt to move the vehicle from a stopped position in any gear higher than second gear. Depending on the load, grade or road conditions, it may be necessary to start in LO speed gear or first-second gears. Note that LO speed gear was designed for off-highway use such as paving, material spreading or heavy load/steep grade conditions.

The HI range has four forward gears that can be shifted in the standard manner. Remember, however, to double-clutch when moving up or down through these gears.

REVERSE can be used in LO range only.

**Upshift** — Under normal highway conditions, with shift lever in NEUTRAL, flip air-shift range selector to LO range, then shift the transmission into first gear (see shift pattern). Shift through second, third and fourth, double-clutching between gears. When maximum RPM is reached in fourth gear, flip air-shift range selector to HI range (preselect) and then move shift lever through NEUTRAL to fifth gear. As the shift lever passes through NEUTRAL, it will put the transmission in HI range. Now continue double-clutching through sixth, seventh and eighth gears.



### CAUTION

*Do NOT move the air-shift range selector while moving in REVERSE. Also, when the truck is stationary, do NOT shift into HI range and then start moving the truck. Damage to the synchronizer may result.*

**Downshift** — To downshift the T309, shift from eighth to seventh, sixth and fifth (HI range), double-clutching between gears. While still in fifth gear, flip the air-shift range selector to LO range (preselect), then shift through NEUTRAL to fourth gear. As you shift through NEUTRAL, the range shift to LO will be completed. Move the shift lever to third, second and first, double-clutching between gears.

**T309 and T309L Reverse** — Reverse can be used in LO range only.

**T309LR Reverse** — Reverse can be used in LO and HI range.

To make a range shift in reverse, bring the truck to a complete stop. Flip the range selector to the range desired (preselect). Move the shift lever out of reverse through NEUTRAL, and then back into reverse again. As the lever moves through NEUTRAL, the range shift will be completed.

|  |                       |
|--|-----------------------|
|         | <p><b>CAUTION</b></p> |
| <p><i>To avoid transmission damage, do NOT change range while moving in REVERSE.</i></p> |                       |

**T309, T309L AND T309LR**

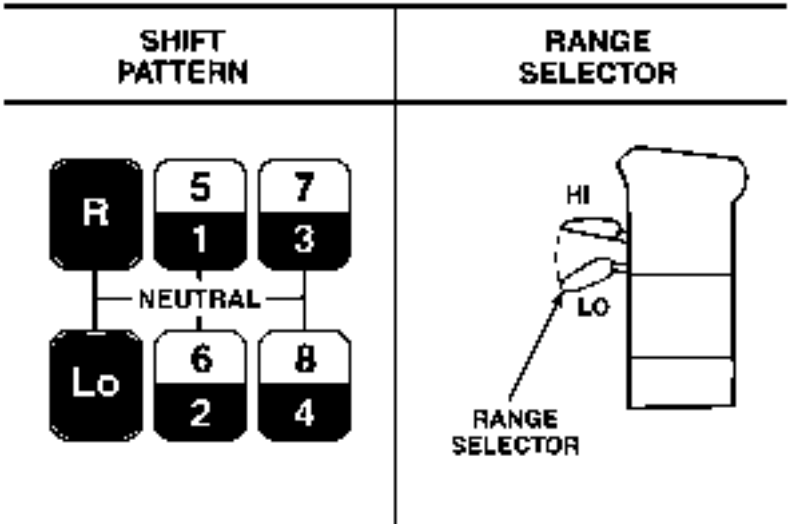

C0029346

**T309 TRANSMISSION RATIOS**

| Gear (Main Box) | LO Range | HI Range |
|-----------------|----------|----------|
| LO              | 11.24    |          |
| 1/5             | 7.35     | 1.94     |
| 2/6             | 5.25     | 1.39     |
| 3/7             | 3.78     | 1.00     |
| 4/8             | 2.69     | 0.71     |
| R               | 13.31    | 3.52     |

### T309L TRANSMISSION RATIOS

| Gear (Main Box) | LO Range | HI Range |
|-----------------|----------|----------|
| LO              | 13.74    |          |
| 1/5             | 7.35     | 1.94     |
| 2/6             | 5.25     | 1.39     |
| 3/7             | 3.78     | 1.00     |
| 4/8             | 2.69     | 0.71     |
| R               | 13.31    | 3.52     |

### T309LR TRANSMISSION RATIOS

| Gear (Main Box) | LO Range | HI Range |
|-----------------|----------|----------|
| LO              | 13.74    |          |
| 1/5             | 7.35     | 1.94     |
| 2/6             | 5.25     | 1.39     |
| 3/7             | 3.78     | 1.00     |
| 4/8             | 2.69     | 0.71     |
| R               | 24.24    | 6.41     |

### ***Preferred Methods for Engaging T309 "Eighth" Gear (or any Hi-Range Gear) for Output Shaft Driven Power Take-Off (PTO)***

**Note:** OPTIONAL RANGE ENGAGEMENT INDICATOR LAMP — If the vehicle is so equipped, an indicator lamp, located in the cab, will illuminate to indicate that the range shift has occurred.

**Method #1 — PTO with Wheels OFF the Ground**

<https://www.truck-manuals.net/mack/>

- 
1. Position the vehicle for power take-off .
  2. Stop the vehicle and apply the spring brakes.
  3. Raise the vehicle wheels off the ground.
  4. Shift the transmission to NEUTRAL.
  5. Turn on PTO.
  6. Place the range selector to HIGH.
  7. Fully depress the clutch pedal and shift the transmission to REVERSE.
  8. Slowly release the clutch pedal until the transmission range clutch engagement is heard; or, if so equipped, until the range engagement indicator lamp is lit.
  9. Fully depress the clutch pedal.
  10. Shift the transmission to EIGHTH gear.
  11. Release the clutch pedal to begin PTO .

***Method #2 — PTO with Wheels ON the Ground***

1. Position the vehicle for power take-off .
2. Stop the vehicle and apply the spring brakes.
3. Keep the vehicle wheels on the ground.
4. Shift the transmission to NEUTRAL.
5. Place the range selector to HIGH.
6. Fully depress the clutch pedal and shift the transmission to REVERSE.
7. Slowly release the clutch pedal until the transmission range clutch engagement is heard; or, if so equipped, until the range engagement indicator lamp is lit.
8. Fully depress the clutch pedal.
9. Turn on PTO.
10. Shift the transmission to EIGHTH gear.
11. Release the clutch pedal to begin PTO .

## MACK T310 Shifting Instructions



### CAUTION

*Make sure air pressure is at least 620 kPa (90 psi) and unit is warmed before making range shifts. Always start in LO range. This also applies to dynamometer testing. When the truck is stationary, do NOT shift into HI range and then start moving the truck. Otherwise, damage to the synchronizer may result.*

The T310 unit is a range-shifted transmission which has 10 forward "highway" speeds. This transmission features a LO and HI auxiliary compound section controlled by an air shift range selector located on the shift lever. The compound section is equipped with a synchronizer to facilitate LO-/HI- range shifting.

The LO range provides five low ratios. Never attempt to move the vehicle from a stopped position in any gear higher than fourth speed gear. Depending on load, grade, or road conditions, it may be necessary to start in first, second, third or fourth speed gears. In HI range there are five forward gears that can be shifted in the standard manner. Always remember, however, to double clutch whether moving up or down through these gears. Reverse gear can be used in LO range only.

**Upshift** - With the shift lever in NEUTRAL, flip the air shift range selector down to LO range. Then shift the transmission into first gear. Shift up to second, third, fourth and fifth speed gears, double clutching between the gears. When maximum engine RPM has been reached in fifth gear, flip the air shift range selector up to HI range (preselect). Then move the shift lever through NEUTRAL to sixth gear. As the shift lever passes through NEUTRAL, the transmission is placed into Hi range. Continue following the normal sequence (7-8-9-10), being sure to double clutch from one gear to the next.

**Downshift** — Shift from 10th speed gear down through the HI range (9-8-7-6), double clutching through each gear. While still in sixth speed gear, flip the air shift range selector down to LO range (preselect). Then move the shift lever through NEUTRAL to fifth speed gear. As the shift lever passes through NEUTRAL, the transmission is placed into LO range. Then, shift down to fourth, third, second and first speed gears, double clutching between all gears.

**CAUTION**

- *Always start in LO range according to shift marker plate instructions. Never start in a gear higher than fourth speed gear, even when dynamometer testing.*
- *When the truck is stationary, do not shift into HI range and then start moving the truck. Damage to the synchronizer can result.*
- *Be careful not to overspeed the engine during downshifting. Damage to powertrain components may result.*

**Reverse** — Reverse can be used in LO only. To make a range shift in reverse, bring the truck to a complete stop. Flip the range selector lever to range desired (preselect). Move the shift lever out of reverse through NEUTRAL and then back into reverse again. As the lever moves through NEUTRAL, the range shift will be completed.

**CAUTION**

*To avoid transmission damage, do NOT change range while moving in REVERSE.*

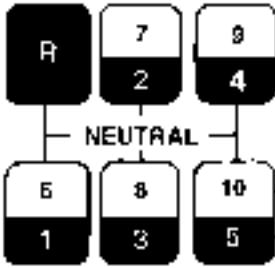
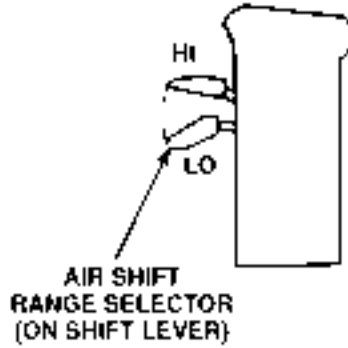
**MAIN BOX****REAR COMPOUND**

C0029347

| Gear (Main Box) | Ratios |      |
|-----------------|--------|------|
|                 | LO     | HI   |
| 1/6             | 13.81  | 2.67 |
| 2/7             | 10.05  | 1.94 |
| 3/8             | 7.18   | 1.39 |
| 4/9             | 5.17   | 1.00 |
| 5/10            | 3.75   | 0.73 |
| R/R             | 14.73  | 2.85 |

## MACK T310M, T310ME and T310MLR Shifting Instructions



### CAUTION

*Make sure air pressure is at least 620 kPa (90 psi) and unit is at operating temperature before making range shifts. Always start in LO range. This also applies to dynamometer testing. When the truck is stationary, do NOT shift into HI range and then start moving the truck. Otherwise, damage to the synchronizer may result.*

The T310M is a range-shifted transmission which has 10 forward speeds. There is a LO and HI auxiliary compound section controlled by an air-shift selector on the shifter. This compound section is equipped with a synchronizer to facilitate LO-HI range shifting. The T310M transmission also provides a multi-speed reverse feature by means of reverse gearing in the compound case which works in conjunction with LO-LO, first and second speed gears in the main box. The air-shift selector must be moved to the R (REVERSE) position in order to utilize the multi-speed reverse feature.

LO range provides six low ratios for six forward gears in the T310M. HI range provides four additional forward gears which can be shifted in the standard manner. Remember, however, to double-clutch when moving up or down through the gears. For normal highway use, start in LO range, first gear and shift through second, third and fourth. The LO-LO and LO positions in LO range for this transmission are designed for use in off-highway and slow-moving s such as curb pouring, material spreading, heavy load/steep grade. REVERSE is used in LO range for four reverse speeds.

**Upshift** — Begin in first gear (shown as 1/5 on shift pattern diagram) with air-shift selector in LO range. Upshift to second gear (2/6 on shift pattern diagram) LO range in the normal manner (double-clutching). When ready to upshift again, depress the clutch pedal and release the accelerator pedal in the normal manner. Repeat this shifting pattern through the remaining gears up to fourth speed (4/8 on shift pattern diagram). When maximum engine RPM has been reached in fourth gear, flip the air-shift selector to HI range (preselect), then double-clutch and shift to fifth gear. As the shift lever passes through NEUTRAL, it will put the transmission in HI range. Continue to upshift through normal sixth, seventh and eighth gears, while double-clutching.



**Downshift** — Downshift as normal from eighth to seventh, sixth and fifth in HI range (double-clutching between all gears). The next lower shift will be to fourth gear LO range. While still in fifth gear, flip the air-shift selector to LO range (preselect), then double-clutch and move the shift lever through NEUTRAL to fourth gear. The move through NEUTRAL activates the air-shift mechanism, this time to LO range. The next lower gear is third gear LO range. Double-clutch down through the remaining gears to first gear LO range as needed.

**CAUTION**

*When the truck is stationary, do NOT shift into HI range and then start moving the truck. Damage to the synchronizer may result.*

**Reverse is used in LO range only. To avoid transmission damage when shifting Forward to Reverse or Reverse to Forward:**

- Bring vehicle to a stop.
- Move lever to NEUTRAL.
- Select low range.
- Select F or R as desired.
- Select lowest lever gear position.
- Release and depress clutch pedal.
- Select desired gear.

## T310M, T310ME AND T310MLR

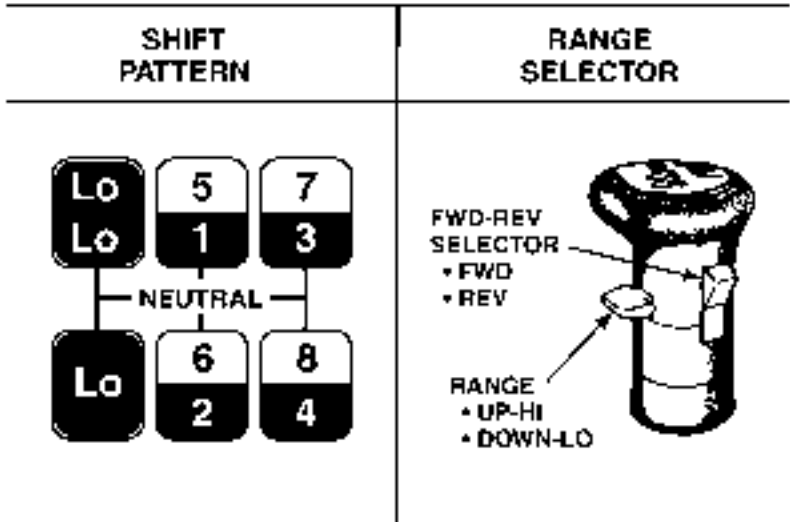

C0029348

### T310M AND T310ME TRANSMISSION RATIOS

| Gear (Main Box) | LO Range | HI Range | Reverse |
|-----------------|----------|----------|---------|
| LOLO            | 17.35    |          | 15.22   |
| LO              | 11.40    |          | 10.00   |
| 1/5             | 7.45     | 1.94     | 6.54    |
| 2/6             | 5.33     | 1.39     | 4.67    |
| 3/7             | 3.83     | 1.00     | 3.37    |
| 4/8             | 2.78     | 0.73     | 2.44    |

---

**T310MLR TRANSMISSION RATIOS**

| <b>Gear (Main Box)</b> | <b>LO Range</b> | <b>HI Range</b> | <b>Reverse</b> |
|------------------------|-----------------|-----------------|----------------|
| LOLO                   | 27.30           |                 | 23.96          |
| LO                     | 13.90           |                 | 12.22          |
| 1/5                    | 7.45            | 1.94            | 6.54           |
| 2/6                    | 5.33            | 1.39            | 4.67           |
| 3/7                    | 3.83            | 1.00            | 3.37           |
| 4/8                    | 2.73            | 0.71            | 2.40           |

**Preferred Method for Engaging T310M or T310MLR High Range Gear for Output Shaft Driven Power Take-Off**

After positioning the vehicle for power take-off :

1. Shift the transmission to NEUTRAL.
2. Engage power take-off drive.
3. Move range selector to HI range.
4. Disengage engine clutch.
5. Select "tenth" gear (8 on the shift marker plate) for T310M or T310MLR.
6. Engage clutch when power take-off is desired.

**CAUTION**

*When the truck is stationary, do NOT shift into HI range and then start moving the truck. Damage to the synchronizer may result.*

## MACK T313-T313L-T313LR Shifting Instructions



### CAUTION

*Make sure air pressure is at least 620 kPa (90 psi) and unit is at operating temperature before making range shifts. Always start in LO range. This also applies to dynamometer testing. When the truck is stationary, do NOT shift into HI range and then start moving the truck. Otherwise, damage to the synchronizer may result.*

The T313(L)(LR) is a range-shifted transmission with 12 forward highway speeds and an extra LO gear in the LO range. LO and HI ranges are controlled by an air-shift range selector.

**Note:** When making a SPLIT SHIFT from gear to gear, the splitter switch must not be actuated, either up or down, until the main box is in NEUTRAL. When making a SPLIT SHIFT in the same gear to a preselected gear, especially under a heavy load, the splitter will not shift until the driveline torque is relieved. This can be done by depressing the clutch pedal and releasing it, or by backing off the throttle and reapplying it. The splitter switch must not be actuated, either up or down, until IMMEDIATELY before the driveline torque is relieved. When making a RANGE SHIFT, it is important to preselect the range shift. This means that the range selector must be moved to its next position (up or down) BEFORE the gearshift lever is moved. Then move the gearshift lever through NEUTRAL to the next desired gear position. As the lever passes through NEUTRAL, the range shift will be completed.



### CAUTION

*Do not "play" with the splitter and range selector tabs at a stop light, flipping from high to low range or HI-LO split. These controls are not intended for entertainment. Such activity can adversely impact the life of the transmission.*

**Upshift** — For purposes of explaining the shifting procedures through ALL gears, assume that the vehicle has a full load and will climb a slight grade.

Before moving the vehicle, the range selector must be in LO range and the splitter switch in LO-split. With the shift lever in NEUTRAL, move the splitter to LO-split (if needed), then the range to LO range (if needed).

Refer to the shift pattern and move the shift lever to LO speed gear (LO range, LO-split). Apply accelerator, engage the clutch, and accelerate to governed speed. Shift up through first, second, third and fourth speed gears, double-clutching between the gears.

To continue while in fourth gear (LO-split), flip the range selector up to HI range (preselect), then move the shift lever through NEUTRAL to fifth gear. As the lever moves through NEUTRAL, the range shift to HI will be completed. You are now in fifth gear LO-split (HI range). Use a combination of the splitter and shift lever to continue shifting to fifth HI-split, sixth LO-split, sixth HI-split and so on, until you reach eighth HI-split. Remember to double-clutch between gears.

To upshift from LO-split to HI-split (in the same gear), accelerate the engine to governed speed, move the splitter switch to HI (preselect), depress the clutch and back off the accelerator pedal. Reapply the accelerator and engage the clutch when the audible shift is heard, or when the engine speed falls by approximately 200 rpm. Depressing the clutch may not be necessary to break the driveline torque, but this will vary with road and load conditions.

To upshift from a HI-split gear to the next higher gears LO-split (in HI range), accelerate the engine to governed speed, then move the splitter switch to LO as you move the shift lever through NEUTRAL to the next higher gear. Note that the splitter switch must not be actuated down to the LO position until the main box is in NEUTRAL.

**Downshift** — Shift from eighth HI-split to eighth LO-split, then seventh HI-split, seventh LO-split and so on (double-clutching between the gears), until you reach fifth LO-split.

While in fifth gear LO-split, flip the range selector down to LO range (preselect), then move the shift lever through NEUTRAL to fourth gear (double-clutch and use the throttle in the normal manner between gears). As the shift lever moves through NEUTRAL, the range shift to LO will be completed. You are now in fourth gear LO-split (LO range). Continue downshifting, using the shift lever in the normal manner until you reach LO speed gear (LO range, LO-split).

To downshift from HI-split to LO-split (in the same gear) as engine speed falls, move the splitter to LO (preselect), then release and reapply the accelerator pedal. An audible shift completion should be heard.

To downshift from a LO-split gear to the next lower gears HI-split (in HI range) as engine speed falls, move the splitter switch to HI as you move the shift lever through NEUTRAL to the next lower gear. Note that the splitter switch must not be actuated up to the HI position until the main box is in NEUTRAL. Remember to double-clutch between gears.

**T313 and T313L Reverse** — Reverse can be used in LO range only.

**T313LR Reverse** — Reverse can be used in LO and HI range.

To make a range shift in reverse, bring the truck to a complete stop. Flip the range selector to the range desired (preselect). Move the shift lever out of reverse through NEUTRAL, and then back into reverse again. As the lever moves through NEUTRAL, the range shift will be completed.

<https://www.truck-manuals.net/mack/>



**CAUTION**

*To avoid transmission damage, do NOT change range while moving in REVERSE.*

**T313, T313L AND T313LR**

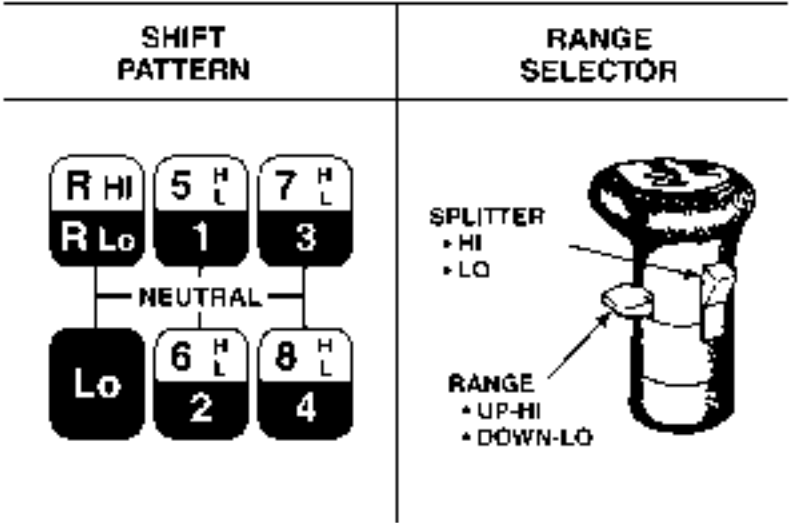

C0029349

**T313, T313L AND T313LR TRANSMISSION RATIOS**

| Gear<br>(Main<br>Box)   | Splitter | Range | Ratios |       |       |
|-------------------------|----------|-------|--------|-------|-------|
|                         |          |       | T313LR | T313  | T313L |
| LO                      | LO       | LO    | 16.42  | 13.44 | 16.42 |
| 1                       | LO       | LO    | 8.78   | 8.78  | 8.78  |
| 2                       | LO       | LO    | 6.28   | 6.28  | 6.28  |
| 3                       | LO       | LO    | 4.52   | 4.52  | 4.52  |
| 4                       | LO       | LO    | 3.22   | 3.22  | 3.22  |
| <b>Range Shift Here</b> |          |       |        |       |       |
| 5                       | LO       | HI    | 2.29   | 2.29  | 2.29  |
| 5                       | HI       | HI    | 1.94   | 1.94  | 1.94  |
| 6                       | LO       | HI    | 1.64   | 1.64  | 1.64  |
| 6                       | HI       | HI    | 1.39   | 1.39  | 1.39  |
| 7                       | LO       | HI    | 1.18   | 1.18  | 1.18  |
| 7                       | HI       | HI    | 1.00   | 1.00  | 1.00  |
| 8                       | LO       | HI    | 0.84   | 0.84  | 0.84  |
| 8                       | HI       | HI    | 0.71   | 0.71  | 0.71  |
| R                       | LO       | LO    | 28.98  | 15.91 | 15.91 |
| R                       | HI       | HI    | 6.41   | 3.52  | 3.52  |

### ***Rear Case, Side-Mounted PTO Operating Procedures (T313, T313L and T313LR)***

#### **When engaging the PTO —**

1. Select LO-split using the splitter switch and select LO range using the range selector.

**Note:** The transmission MUST be in LO range and LO-split at all times during PTO .

2. Depress the clutch pedal to disengage the clutch.
3. Set the parking brakes.
4. Move the main box shift lever to the NEUTRAL position.
5. Move the dash-mounted compound NEUTRAL control valve to the ON position, which moves the synchro clutch to a NEUTRAL position.
6. Engage the PTO.

7. Move the main box shift lever to the desired ratio.
8. Release the clutch pedal to engage the clutch.
9. Operate the PTO-driven load.

#### **When disengaging the PTO —**

1. Depress the clutch pedal to disengage the clutch.
2. Move the main box shift lever to NEUTRAL.
3. Disengage the PTO.
4. Move the dash-mounted compound NEUTRAL control valve to the OFF position, which moves the synchro clutch back to LO range.
5. Move the shift lever to the desired main gear box ratio.
6. Release the parking brakes.
7. Release the clutch pedal to engage the clutch.

## **MACK T31321, T313L21 and T313LR21 Shifting Instructions**



### **CAUTION**

*Make sure air pressure is at least 620 kPa (90 psi) and unit is at operating temperature before making range shifts. Always start in LO range. This also applies to dynamometer testing. When the truck is stationary, do NOT shift into HI range and then start moving the truck. Otherwise, damage to the synchronizer may result.*

The T313(L)(LR)21 is a range-shifted transmission with 12 forward highway speeds and an extra LO gear in the LO range. LO and HI ranges are controlled by an air-shift range selector.



**Note:** When making a SPLIT SHIFT from gear to gear, the splitter switch must not be actuated, either up or down, until the main box is in NEUTRAL. When making a SPLIT SHIFT in the same gear to a preselected gear, especially under a heavy load, the splitter will not shift until the driveline torque is relieved. This can be done by depressing the clutch pedal and releasing it, or by backing off the throttle and reapplying it. The splitter switch must not be actuated, either up or down, until IMMEDIATELY before the driveline torque is relieved. When making a RANGE SHIFT, it is important to preselect the range shift. This means that the range selector must be moved to its next position (up or down) BEFORE the gearshift lever is moved. Then move the gearshift lever through NEUTRAL to the next desired gear position. As the lever passes through NEUTRAL, the range shift will be completed.

**Upshift —** For purposes of explaining the shifting procedures through ALL gears, assume that the vehicle has a full load and will climb a slight grade.

Before moving the vehicle, the range selector must be in LO range and the splitter switch in LO-split. With the shift lever in NEUTRAL, move the splitter to LO-split (if needed), then the range to LO range (if needed).

Refer to the shift pattern and move the shift lever to LO speed gear (LO range, LO-split). Apply accelerator, engage the clutch, and accelerate to governed speed. Shift up through first, second, third-fourth speed gears, double-clutching between the gears.

To continue while in fourth gear (LO-split), flip the range selector up to HI range (preselect), then move the shift lever through NEUTRAL to fifth gear. As the lever moves through NEUTRAL, the range shift to HI will be completed. You are now in fifth gear LO-split (HI range). Use a combination of the splitter and shift lever to continue shifting to fifth HI-split, sixth LO-split, sixth HI-split and so on, until you reach eighth HI-split. Remember to double-clutch between gears.

To upshift from LO-split to HI-split (in the same gear), accelerate the engine to governed speed, move the splitter switch to HI (preselect), depress the clutch and back off the accelerator pedal. Reapply the accelerator and engage the clutch when the audible shift is heard, or when the engine speed falls by approximately 200 rpm. Depressing the clutch may not be necessary to break the driveline torque, but this will vary with road and load conditions.

To upshift from a HI-split gear to the next higher gear's LO-split (in HI range), accelerate the engine to governed speed, then move the splitter switch to LO as you move the shift lever through NEUTRAL to the next higher gear. Note that the splitter switch must not be actuated down to the LO position until the main box is in NEUTRAL.

**Downshift —** Shift from eighth HI-split to eighth LO-split, then seventh HI-split, seventh LO-split and so on (double-clutching between the gears), until you reach fifth LO-split.

While in fifth gear LO-split, flip the range selector down to LO range (preselect), then move the shift lever through NEUTRAL to fourth gear (double-clutch and use the throttle in the normal manner between gears). As the shift lever moves through NEUTRAL, the range shift to LO will be completed. You are now in fourth gear LO-split (LO range). Continue downshifting, using the shift lever in the normal manner until you reach LO speed gear (LO range, LO-split).

To downshift from HI-split to LO-split (in the same gear) as engine speed falls, move the splitter to LO (preselect), then release and reapply the accelerator pedal. An audible shift completion should be heard.

To downshift from a LO-split gear to the next lower gears HI-split (in HI range) as engine speed falls, move the splitter switch to HI as you move the shift lever through NEUTRAL to the next lower gear. Note that the splitter switch must not be actuated up to the HI position until the main box is in NEUTRAL. Remember to double-clutch between gears.

**T31321 and T313L21 Reverse** — Reverse can be used in LO range only.

**T313LR21 Reverse** — Reverse can be used in LO and HI range.

To make a range shift in reverse, bring the truck to a complete stop. Flip the range selector to the range desired (preselect). Move the shift lever out of reverse through NEUTRAL, and then back into reverse again. As the lever moves through NEUTRAL, the range shift will be completed.



## CAUTION

*To avoid transmission damage, do NOT change range while moving in REVERSE.*

## T31321, T313L21 AND T313LR21

| SHIFT<br>PATTERN  | RANGE<br>SELECTOR   |
|---|---|
| <p>Diagram illustrating the shift pattern for the T31321, T313L21, and T313LR21 models. The pattern shows gears arranged in two rows. The top row contains gears labeled R HI, 5 H L, and 7 H L. The middle row contains gears labeled R Lo, 1, and 3. A horizontal line labeled "NEUTRAL" connects the three middle gears. The bottom row contains gears labeled Lo, 6 H L, and 8 H L. Below the bottom row are gears labeled 2 and 4.</p> | <p>Diagram illustrating the range selector for the T31321, T313L21, and T313LR21 models. The selector is a vertical shaft with a knob at the top. The knob has a "SPLITTER" label with "HI" and "LO" positions. The shaft has a "RANGE" label with "UP-HI" and "DOWN-LO" positions.</p> |

C0029350

## T31321, T313L21 AND T313LR21 TRANSMISSION RATIOS

| Gear<br>(Main<br>Box)   | Splitter | Range | Ratios |          |         |
|-------------------------|----------|-------|--------|----------|---------|
|                         |          |       | T31321 | T313LR21 | T313L21 |
| LO                      | LO       | LO    | 13.44  | 16.42    | 16.42   |
| 1                       | LO       | LO    | 8.78   | 8.78     | 8.78    |
| 2                       | LO       | LO    | 6.28   | 6.28     | 6.28    |
| 3                       | LO       | LO    | 4.52   | 4.52     | 4.52    |
| 4                       | LO       | LO    | 3.22   | 3.22     | 3.22    |
| <b>Range Shift Here</b> |          |       |        |          |         |
| 5                       | LO       | HI    | 2.29   | 2.29     | 2.29    |
| 5                       | HI       | HI    | 1.94   | 1.94     | 1.94    |
| 6                       | LO       | HI    | 1.64   | 1.64     | 1.64    |
| 6                       | HI       | HI    | 1.39   | 1.39     | 1.39    |
| 7                       | LO       | HI    | 1.18   | 1.18     | 1.18    |
| 7                       | HI       | HI    | 1.00   | 1.00     | 1.00    |
| 8                       | LO       | HI    | 0.84   | 0.84     | 0.84    |
| 8                       | HI       | HI    | 0.71   | 0.71     | 0.71    |
| R                       | LO       | LO    | 15.91  | 28.98    | 15.91   |
| R                       | HI       | HI    | 3.52   | 6.41     | 3.52    |

## MACK T318, T318L and T318LR Shifting Instructions



### CAUTION

*Make sure air pressure is at least 620 kPa (90 psi) and unit is at operating temperature before making range shifts. Always start in LO range. This also applies to dynamometer testing. When the truck is stationary, do NOT shift into HI range and then start moving the truck. Otherwise, damage to the synchronizer may result.*

**Note:** When making a SPLIT SHIFT from gear to gear, the splitter switch must not be actuated, either up or down, until the main box is in NEUTRAL. When making a SPLIT SHIFT in the same gear to a preselected gear, especially under a heavy

load, the splitter will not shift until the driveline torque is relieved. This can be done by depressing the clutch pedal and releasing it, or by backing off the throttle and reapplying it. The splitter switch must not be actuated, either up or down, until IMMEDIATELY before the driveline torque is relieved. When making a RANGE SHIFT, it is important to preselect the range shift. This means that the range selector must be moved to its next position (up or down) BEFORE the gearshift lever is moved. Then move the gearshift lever through NEUTRAL to the next desired gear position. As the lever passes through NEUTRAL, the range shift will be completed.

**Upshift** — For purposes of explaining the shifting procedures through ALL gears, assume that the vehicle has a full load and will climb a slight grade.

To prepare for moving the vehicle, position the shift lever in NEUTRAL, select LO-split using the splitter switch, and select LO range using the range selector.

Refer to the shift pattern and move the shift lever to LO speed gear (LO range, LO-split). Apply accelerator and engage the clutch, then accelerate to governed speed. Select HI on the splitter switch (preselect) and release the accelerator pedal long enough for the split shift to complete. Reapply the accelerator. Shift through first LO-split, first HI-split, second LO-split, second HI-split and so on, until you reach fourth HI-split. Remember to double-clutch between gears.

To continue while in fourth gear HI-split, flip the range selector up to HI range (preselect), and as you move the shift lever through NEUTRAL to fifth gear, move the splitter switch from HI to LO. As the lever moves through NEUTRAL, the range shift to HI will be completed. You are now in fifth gear LO-split (HI range). Continue shifting to fifth HI-split, sixth LO-split, sixth HI-split and so on, until you reach eighth HI-split. Remember to double-clutch between gears.

To upshift from LO-split to HI-split (in the same gear), accelerate the engine to governed speed, move the splitter switch to HI (preselect), depress the clutch and back off the accelerator pedal. Reapply the accelerator and engage the clutch when the audible shift is heard, or when the engine speed falls by approximately 200 rpm. Depressing the clutch may not be necessary to break the driveline torque, but this will vary with road and load conditions.

To upshift from a HI-split gear to the next higher gears LO-split (in the same range), accelerate the engine to governed speed, then move the splitter switch to LO as you move the shift lever through NEUTRAL to the next higher gear. Note that the splitter switch must not be actuated down to the LO position until the main box is in NEUTRAL.

**Downshift** — Shift from eighth HI-split to eighth LO-split, then seventh HI-split, seventh LO-split and so on (double-clutching between the gears), until you reach fifth LO-split.

To continue while in fifth gear LO-split, flip the range selector down to LO range (preselect), and as you move the gearshift lever through NEUTRAL to fourth gear, move the splitter switch from LO to HI. As the shift lever moves through NEUTRAL, the range shift to LO will be completed. You are now in fourth gear HI-split (LO range). Continue downshifting, using the shift lever and splitter in the normal manner, until you reach LO speed gear (LO range, LO-split).

To downshift from HI-split to LO-split (in the same gear) as engine speed falls, move the splitter to LO (preselect), then release and reapply the accelerator pedal. An audible shift completion should be heard.

To downshift from a LO-split gear to the next lower gear's HI-split (in the same range) as engine speed falls, move the splitter switch to HI as you move the shift lever through NEUTRAL to the next lower gear. Note that the splitter switch must not be actuated up to the HI position until the main box is in NEUTRAL. Remember to double-clutch between gears using the accelerator pedal to synchronize the transmission components.

**T318 and T318L Reverse** — Reverse can be used in LO range only.

**T318LR Reverse** — Reverse can be used in LO and HI range.

To make a range shift in reverse, bring the truck to a complete stop. Flip the range selector to the range desired (preselect). Move the shift lever out of reverse through NEUTRAL, and then back into reverse again. As the lever moves through NEUTRAL, the range shift will be completed.



## CAUTION

*To avoid transmission damage, do NOT change range while moving in REVERSE.*

## T318, T318L AND T318LR

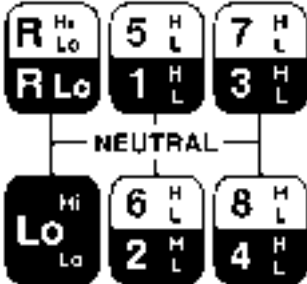
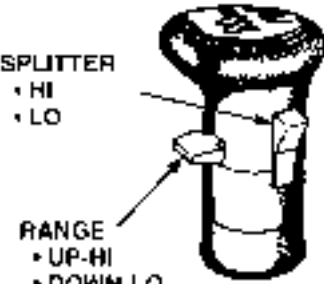
| SHIFT<br>PATTERN  | RANGE<br>SELECTOR  |
|---|--|
|  <p>SHIFT PATTERN</p> <p>NEUTRAL</p> |  <p>SPLITTER</p> <ul style="list-style-type: none"> <li>• HI</li> <li>• LO</li> </ul> <p>RANGE</p> <ul style="list-style-type: none"> <li>• UP-HI</li> <li>• DOWN-LO</li> </ul> |

C0029351

---

**T318, T318L AND T318LR TRANSMISSION RATIOS**

| Gear<br>(Main<br>Box)   | Splitter | Range | Ratios |        |       |
|-------------------------|----------|-------|--------|--------|-------|
|                         |          |       | T318   | T318LR | T318L |
| LO                      | LO       | LO    | 13.44  | 16.42  | 16.42 |
| LO                      | HI       | LO    | 11.40  | 13.93  | 13.93 |
| 1                       | LO       | LO    | 8.78   | 8.78   | 8.78  |
| 1                       | HI       | LO    | 7.45   | 7.45   | 7.45  |
| 2                       | LO       | LO    | 6.28   | 6.28   | 6.28  |
| 2                       | HI       | LO    | 5.33   | 5.33   | 5.33  |
| 3                       | LO       | LO    | 4.52   | 4.52   | 4.52  |
| 3                       | HI       | LO    | 3.83   | 3.83   | 3.83  |
| 4                       | LO       | LO    | 3.22   | 3.22   | 3.22  |
| 4                       | HI       | LO    | 2.73   | 2.73   | 2.73  |
| <b>Range Shift Here</b> |          |       |        |        |       |
| 5                       | LO       | HI    | 2.29   | 2.29   | 2.29  |
| 5                       | HI       | HI    | 1.94   | 1.94   | 1.94  |
| 6                       | LO       | HI    | 1.64   | 1.64   | 1.64  |
| 6                       | HI       | HI    | 1.39   | 1.39   | 1.39  |
| 7                       | LO       | HI    | 1.18   | 1.18   | 1.18  |
| 7                       | HI       | HI    | 1.00   | 1.00   | 1.00  |
| 8                       | LO       | HI    | 0.84   | 0.84   | 0.84  |
| 8                       | HI       | HI    | 0.71   | 0.71   | 0.71  |
| R                       | LO       | LO    | 15.91  | 28.98  | 15.91 |
| R                       | LO       | HI    | 13.49  | 24.58  | 13.49 |
| R                       | HI       | HI    | 3.52   | 6.41   | 3.52  |



## ***Rear Case, Side-Mounted PTO Operating Procedures (T318, T318L and T318LR)***

### **When engaging the PTO —**

1. Select LO-split using the splitter switch and select LO range using the range selector.

**Note:** The transmission MUST be in LO range and LO-split at all times during PTO .

2. Depress the clutch pedal to disengage the clutch.
3. Set the parking brakes.
4. Move the main box shift lever to the NEUTRAL position.
5. Move the dash-mounted compound NEUTRAL control valve to the ON position, which moves the synchro clutch to a NEUTRAL position.
6. Engage the PTO.
7. Move the main box shift lever to the desired ratio.
8. Release the clutch pedal to engage the clutch.
9. Operate the PTO-driven load.

### **When disengaging the PTO —**

1. Depress the clutch pedal to disengage the clutch.
2. Move the main box shift lever to NEUTRAL.
3. Disengage the PTO.
4. Move the dash-mounted compound NEUTRAL control valve to the OFF position, which moves the synchro clutch back to LO range.
5. Move the shift lever to the desired main gear box ratio.
6. Release the parking brakes.
7. Release the clutch pedal to engage the clutch.

---

***Preferred Methods for Engaging T318(L)(LR) "Eighteenth" Gear (or any HI-range gear) for Output Shaft Driven Power Take-Off***

**Method #1**

After positioning the vehicle for power take-off , and with vehicle wheels off the ground:

1. Shift the transmission to NEUTRAL.
2. Engage power take-off drive.
3. Move the range selector to HI range.
4. Disengage the engine clutch and select REVERSE.
5. Feather the clutch until the transmission range clutch engagement is heard.
6. Disengage the engine clutch.
7. Select 18th speed gear for T318LR.
8. Engage the clutch when power take-off is desired.

**Method #2**

After positioning the vehicle for power take-off , and with vehicle wheels on the ground:

1. Shift the transmission to NEUTRAL.
2. Move the range selector to HI range.
3. Disengage the engine clutch and select REVERSE.
4. Feather the clutch until the transmission range clutch engagement is heard.
5. Disengage the engine clutch.
6. Engage power take-off drive.
7. Select 18th speed gear for T318LR.
8. Engage the clutch when power take-off is desired.

## MACK T31821, T318L21 and T318LR21 Shifting Instructions



### CAUTION

*Make sure air pressure is at least 620 kPa (90 psi) and unit is at operating temperature before making range shifts. Always start in LO range. This also applies to dynamometer testing. When the truck is stationary, do NOT shift into HI range and then start moving the truck. Otherwise, damage to the synchronizer may result.*

**Note:** When making a SPLIT SHIFT from gear to gear, the splitter switch must not be actuated, either up or down, until the main box is in NEUTRAL. When making a SPLIT SHIFT in the same gear to a preselected gear, especially under a heavy load, the splitter will not shift until the driveline torque is relieved. This can be done by depressing the clutch pedal and releasing it, or by backing off the throttle and reapplying it. The splitter switch must not be actuated, either up or down, until IMMEDIATELY before the driveline torque is relieved. When making a RANGE SHIFT, it is important to preselect the range shift. This means that the range selector must be moved to its next position (up or down) BEFORE the gearshift lever is moved. Then move the gearshift lever through NEUTRAL to the next desired gear position. As the lever passes through NEUTRAL, the range shift will be completed.

**Upshift** — For purposes of explaining the shifting procedures through ALL gears, assume that the vehicle has a full load and will climb a slight grade.

To prepare for moving the vehicle, position the shift lever in NEUTRAL, select LO-split using the splitter switch, and select LO range using the range selector.

Refer to the shift pattern and move the shift lever to LO speed gear (LO range, LO-split). Apply accelerator and engage the clutch, then accelerate to governed speed. Select HI on the splitter switch (preselect) and release the accelerator pedal long enough for the split shift to complete. Reapply the accelerator. Shift through first LO-split, first HI-split, second LO-split, second HI-split and so on, until you reach fourth HI-split. Remember to double-clutch between gears.

To continue while in fourth gear HI-split, flip the range selector up to HI range (preselect), and as you move the shift lever through NEUTRAL to fifth gear, move the splitter switch from HI to LO. As the lever moves through NEUTRAL, the range shift to HI will be completed. You are now in fifth gear LO-split (HI range). Continue shifting to fifth HI-split, sixth LO-split, sixth HI-split and so on, until you reach eighth HI-split. Remember to double-clutch between gears.

To upshift from LO-split to HI-split (in the same gear), accelerate the engine to governed speed, move the splitter switch to HI (preselect), depress the clutch and back off the accelerator pedal. Reapply the accelerator and engage the clutch when the audible shift is heard, or when the engine speed falls by approximately 200 rpm. Depressing the clutch may not be necessary to break the driveline torque, but this will vary with road and load conditions.

To upshift from a HI-split gear to the next higher gear's LO-split (in the same range), accelerate the engine to governed speed, then move the splitter switch to LO as you move the shift lever through NEUTRAL to the next higher gear. Note that the splitter switch must not be actuated down to the LO position until the main box is in NEUTRAL.

**Downshift** — Shift from eighth HI-split to eighth LO-split, then seventh HI-split, seventh LO-split and so on (double-clutching between the gears), until you reach fifth LO-split.

To continue while in fifth gear LO-split, flip the range selector down to LO range (preselect), and as you move the gearshift lever through NEUTRAL to fourth gear, move the splitter switch from LO to HI. As the shift lever moves through NEUTRAL, the range shift to LO will be completed. You are now in fourth gear HI-split (LO range). Continue downshifting, using the shift lever and splitter in the normal manner, until you reach LO speed gear (LO range, LO-split).

To downshift from HI-split to LO-split (in the same gear) as engine speed falls, move the splitter to LO (preselect), then release and reapply the accelerator pedal. An audible shift completion should be heard.

To downshift from a LO-split gear to the next lower gear's HI-split (in the same range) as engine speed falls, move the splitter switch to HI as you move the shift lever through NEUTRAL to the next lower gear. Note that the splitter switch must not be actuated up to the HI position until the main box is in NEUTRAL. Remember to double-clutch between gears using the accelerator pedal to synchronize the transmission components.

**T31821 and T318L21 Reverse** — Reverse can be used in LO range only.

**T318LR21 Reverse** — Reverse can be used in LO and HI range.

To make a range shift in reverse, bring the truck to a complete stop. Flip the range selector to the range desired (preselect). Move the shift lever out of reverse through NEUTRAL, and then back into reverse again. As the lever moves through NEUTRAL, the range shift will be completed.



## CAUTION

*To avoid transmission damage, do NOT change range while moving in REVERSE.*

## T31821, T318L21 AND T318LR21

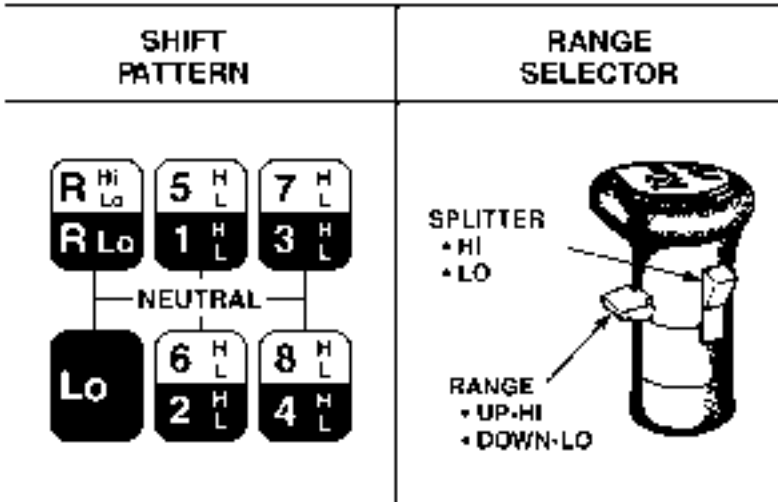

C0029352

---

**T31821, T318L21 AND T318LR21 TRANSMISSION RATIOS**

| Gear<br>(Main<br>Box)   | Splitter | Range | Ratios |          |         |
|-------------------------|----------|-------|--------|----------|---------|
|                         |          |       | T31821 | T318LR21 | T318L21 |
| LO                      | LO       | LO    | 13.44  | 16.42    | 16.42   |
| LO                      | HI       | LO    | 11.40  | 13.93    | 13.93   |
| 1                       | LO       | LO    | 8.78   | 8.78     | 8.78    |
| 1                       | HI       | LO    | 7.45   | 7.45     | 7.45    |
| 2                       | LO       | LO    | 6.28   | 6.28     | 6.28    |
| 2                       | HI       | LO    | 5.33   | 5.33     | 5.33    |
| 3                       | LO       | LO    | 4.52   | 4.52     | 4.52    |
| 3                       | HI       | LO    | 3.83   | 3.83     | 3.83    |
| 4                       | LO       | LO    | 3.22   | 3.22     | 3.22    |
| 4                       | HI       | LO    | 2.73   | 2.73     | 2.73    |
| <b>Range Shift Here</b> |          |       |        |          |         |
| 5                       | LO       | HI    | 2.29   | 2.29     | 2.29    |
| 5                       | HI       | HI    | 1.94   | 1.94     | 1.94    |
| 6                       | LO       | HI    | 1.64   | 1.64     | 1.64    |
| 6                       | HI       | HI    | 1.39   | 1.39     | 1.39    |
| 7                       | LO       | HI    | 1.18   | 1.18     | 1.18    |
| 7                       | HI       | HI    | 1.00   | 1.00     | 1.00    |
| 8                       | LO       | HI    | 0.84   | 0.84     | 0.84    |
| 8                       | HI       | HI    | 0.71   | 0.71     | 0.71    |
| R                       | LO       | LO    | 15.91  | 28.98    | 15.91   |
| R                       | LO       | HI    | 13.49  | 24.58    | 13.49   |
| R                       | HI       | HI    | 3.52   | 6.41     | 3.52    |

## ***Rear Case, Side-Mounted PTO Operating Procedures (T31821, T318L21 and T318LR21)***

### **When engaging the PTO —**

1. Select LO-split using the splitter switch and select LO range using the range selector.

**Note:** The transmission MUST be in LO range and LO-split at all times during PTO .

2. Depress the clutch pedal to disengage the clutch.
3. Set the parking brakes.
4. Move the main box shift lever to the NEUTRAL position.
5. Move the dash-mounted compound NEUTRAL control valve to the ON position, which moves the synchro clutch to a NEUTRAL position.
6. Engage the PTO.
7. Move the main box shift lever to the desired ratio.
8. Release the clutch pedal to engage the clutch.
9. Operate the PTO-driven load.

### **When disengaging the PTO —**

1. Depress the clutch pedal to disengage the clutch.
2. Move the main box shift lever to NEUTRAL.
3. Disengage the PTO.
4. Move the dash-mounted compound NEUTRAL control valve to the OFF position, which moves the synchro clutch back to LO range.
5. Move the shift lever to the desired main gear box ratio.
6. Release the parking brakes.
7. Release the clutch pedal to engage the clutch.

---

***Preferred Methods for Engaging T318(L)(LR)21 "Eighteenth" Gear (or any HI-range gear) for Output Shaft Driven Power Take-Off (PTO)***

**Method #1**

After positioning the vehicle for power take-off , and with vehicle wheels off the ground:

1. Shift the transmission to NEUTRAL.
2. Engage power take-off drive.
3. Move the range selector to HI range.
4. Disengage the engine clutch and select REVERSE.
5. Feather the clutch until the transmission range clutch engagement is heard.
6. Disengage the engine clutch.
7. Select 18th speed gear for T318L(R)21.
8. Engage the clutch when power take-off is desired.

**Method #2**

After positioning the vehicle for power take-off , and with vehicle wheels on the ground:

1. Shift the transmission to NEUTRAL.
2. Move the range selector to HI range.
3. Disengage the engine clutch and select REVERSE.
4. Feather the clutch until the transmission range clutch engagement is heard.
5. Disengage the engine clutch.
6. Engage power take-off drive.
7. Select 18th speed gear for T318L(R)21.
8. Engage the clutch when power take-off is desired.



## Precautions When Descending Grades If Vehicle is Equipped with Eaton AutoShift Generation I and II



### DANGER

*When "D" is selected, AutoShift will automatically upshift as engine and road speed increases on downhill grades. Preselect "Manual" or "H" to prevent unwanted upshifts; use the up and down buttons to command shift. Shifter will beep and not respond to shift requests that will overspeed or excessively lug the engine.*

**Note:** Keep engine speed below 2100 rpm to allow commanded upshifts.

Preselect "Low" to maximize engine braking power down steep grades and allow downshifts only. **See your Eaton Driver Instructions Manual for more details.**

---

## AXLES

### Rear Axles Other Than MACK

Please refer to the operator's manual provided with your vehicle for axles other than MACK.

### MACK Rear Axles

Mack Trucks, Inc. provides axle housings in three capacity classifications:

- Medium Duty
- Heavy Duty
- Extra-Heavy Duty

To deliver the appropriate amount of torque to the driving wheels, MACK offers dual-reduction carriers in a variety of ratios.

Mack Trucks, Inc. offers a large variety of four-wheel-drive tandem axles with top-mounted, dual-reduction carriers (for straight line through drive). Carriers are also available in a large number of ratios.

All four-wheel-drive tandem carriers are available with the MACK inter-axle power divider third differential (with or without a power divider lockout).

MACK rear axles are designed so the entire load is carried by the axle housing (through the wheel bearings mounted on the housing spindle). The rear axle shafts are either free-splined (both ends) or integral flange type. Both types of axle shafts can be removed without removing or disturbing the rear wheels.

To avoid excessive tire wear, proper maintenance must be practiced and rear axle tires must be matched.



#### CAUTION

*The maximum safe operating oil temperature for a MACK rear axle is 121°C (250°F) for mineral-based oil, and 148°C (300°F) for synthetic-based oil. Continued with oil above this temperature will result in rapid deterioration of the oil's lubricating properties and is NOT recommended.*

**Inter-Axle Power Divider Lockout (If Equipped)**

The MACK power divider can be rendered inoperative, during short periods of poor traction, using a power divider lockout. When the power divider lockout is engaged, both axles are locked together (in positive through-drive) for maximum traction with no differential action between axles. It is not necessary to stop the vehicle to engage the power divider lockout. The lockout may be engaged while the vehicle is moving at less than 30 mph, as long as the wheels are not spinning.

**CAUTION**

*Do not engage the power divider lockout if the wheels are spinning.*

**Note:** Even when no traction is available at the spinning wheel, the driver can "feather" the brakes (apply the brakes slightly), creating enough resistance at that wheel to allow power to the axle with traction. Feathering brakes should not be done with power divider lockout engaged.

**Note:** For vendor axles, see the vendor manual furnished with the vehicle.

---

## Engaging the Power Divider Lockout

Normally, the Power Divider switch is in the OUT (disengaged) position. In poor traction conditions, it may be necessary to provide positive through-drive to both axles by flipping the switch to the locked (engaged) position.

1. Push switch to engage.
2. Momentarily release the accelerator pedal to allow the shift to take place, then drive through the slippery area.

**Note:** A lockout indicator lamp will remain lit as long as the lockout is engaged. This is to remind the driver to release the lockout as soon as normal traction is regained.

3. When driving conditions permit, unlock the power divider by moving the Power Divider switch back to the OUT (disengaged) position. Then release the accelerator pedal momentarily (to shift out of the locked position) and drive as usual.



### CAUTION

*Do NOT (under any circumstances) engage or disengage the lockout while the drive wheels are actually slipping or spinning; clashing between the lockout sliding clutch and the outer cam may result.*

### DIESEL PARTICULATE FILTERS (IF EQUIPPED)

Your new MACK chassis is equipped with a 2010 emission compliant engine, with an engine exhaust aftertreatment system (Diesel Particulate Filter) and selective catalytic reduction (SCR) system. Vehicles equipped with a Diesel Particulate Filter require the use of EO-O Premium Plus (or VDS-4) specification high performance diesel engine oil and Ultra Low Sulfur Diesel (ULSD) fuel.



#### CAUTION

*Use of diesel fuel other than ULSD and engine oils other than EO-O Premium Plus (or VDS-4), will adversely affect performance, efficiency and durability of the DPF system and the engine, to the point where the engine may not run at all. Manufacturer's warranties will also be rendered void due to usage of improper fuel. Unapproved fuel additives (including engine oil) are NOT permitted.*

Mack Trucks, Inc. offers two different types of DPF systems:

- Conventional DPF (passive regeneration and parked regeneration)
- Thermal Regeneration Unit (TRU) DPF (moving regeneration and parked regeneration)

as well as two different mounting styles:

1. MACK Vertical Back-of-Cab DPF (both conventional DPF and TRU DPF)
2. MACK-Cap DPF, which is a space saving unit that is mounted inside the frame (conventional only)

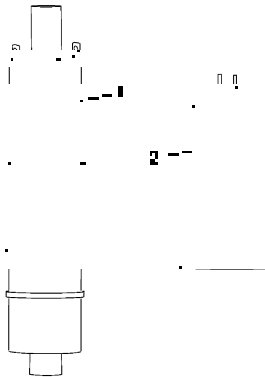

C0029353

A Diesel Particulate Filter (DPF) takes the place of the standard muffler. The DPF is used to meet EPA requirements to help reduce soot and particulate emissions into the atmosphere. The particulates are removed by collecting in the DPF unit, where they are eventually oxidized with passive regeneration or active regeneration of the filter. The electrical system and exhaust aftertreatment system of the vehicle will determine when regeneration is required. Mack Trucks, Inc., uses two exhaust aftertreatment systems: conventional and TRU.

Conventional exhaust aftertreatment systems use passive-active regeneration. The passive regeneration process oxidizes the particulates captured in the DPF while the vehicle is in operation. An oxidation catalyst raises the exhaust temperature to approximately 260°C (500°F), the temperature at which a chemical reaction takes place to oxidize the soot (passive regeneration)

TRU exhaust aftertreatment systems use active regeneration. Regeneration takes place after a certain number of engine operating hours and begins when an air/fuel mixture is injected into the thermal regenerator and raises the temperature inside the unit to the point where the soot oxidation takes place.

Conventional exhaust aftertreatment systems are used in highway and certain vocational applications. TRU exhaust aftertreatment systems are used mainly in refuse collection applications.

Depending on how the vehicle is set up, regeneration can occur while the vehicle is being driven (referred to as a "moving" regeneration) or when the vehicle is parked and idling (referred to as a "parked" regeneration).



## CAUTION

*When active regeneration occurs (with either system), the temperature of the exhaust will be elevated. DO NOT park the vehicle with the exhaust outlet under low hanging overhead flammable objects such as trees, awnings, etc., that could be damaged by elevated exhaust temperatures. DO NOT remove the diffuser.*



## CAUTION

*If the vehicle is in a location that may be hazardous when an active regeneration begins (i.e., in close proximity to flammable materials or gases), the regeneration should be stopped by pushing the DPF switch to the "Stop Regeneration" position. If an active regeneration is stopped by the vehicle operator, it should be initiated at a later time when the vehicle is in a safe location. However, if an active regeneration is stopped repeatedly, the vehicle may need to be taken to a MACK service facility. The service facility will use a service tool to manually initiate the regeneration.*



### **WARNING**

**For chassis equipped with a heated dump body, be aware that temperature around the area where the exhaust enters the body, as well as the product contained in the body, may be elevated, particularly during DPF regeneration.**

## Extended Idling and Aftertreatment System Conditioning

Extended idling performed on this vehicle equipped with an exhaust aftertreatment system should be carried out at a low engine idle speed. There is no benefit to using a raised engine idle speed for extended idling. The only exception is for active PTO . Utilizing an engine speed above 1300 rpm is recommended for vehicles which perform extended idling with an active PTO.

During periods of extended idling, normally greater than 8 hrs, the conventional DPF system needs to perform a routine conditioning cycle. The conditioning cycle is controlled by the Engine ECU and will start and stop automatically as needed. The ATS conditioning is required to maintain normal exhaust aftertreatment system function and should not be stopped. ATS conditioning will not occur on TRU DPF systems.

During these events the engine speed will increase to approximately 1050–1400 rpm, for non-PTO , in order to complete the exhaust aftertreatment conditioning cycle. Exhaust temperatures will also elevate slightly but remain much lower than those reached during regeneration and present no danger.

If a compatible driver display is available a message will be displayed when the conditioning cycle is in progress. The message indicated in the driver's display will be "ATS Conditioning in Progress, No Action Required." If no driver



## 238 Mack, EPA2010 Emissions Solution

display is available there will be no indication of an ATS conditioning event except for the automatic increase in engine speed.

### Exhaust Aftertreatment System

#### *CHU Standard System View*

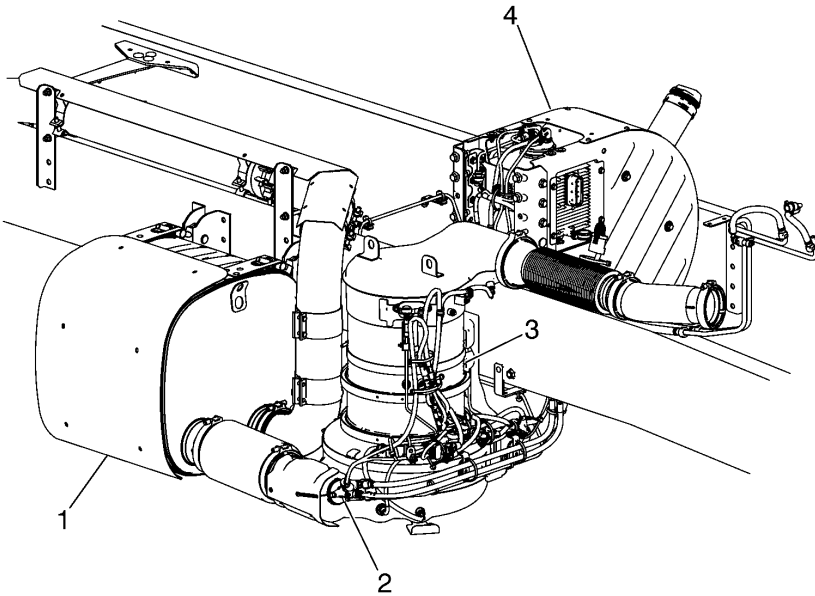

W2029933

1. Selective Catalytic Reduction (SCR) Catalyst
2. Aftertreatment DEF Dosing Unit
3. Aftertreatment Diesel Particulate Filter (DPF)
4. Aftertreatment DEF Tank

Diesel Exhaust Fluid (DEF) is a reactant that's key to the SCR process. It's a nontoxic, ultra-pure solution of urea and

ultra-pure water. Urea is a compound of nitrogen that turns to ammonia when heated. It is used in a variety of industries, perhaps most commonly as a fertilizer in agriculture. The fluid is non flammable, and is not dangerous when handled as recommended. However, it is highly corrosive to certain metals, especially copper and brass. Read the separate section concerning the handling of DEF solution.

## Safety Information

Mack utilizes the use of a Diesel Particulate Filter (DPF) and Selective Catalytic Reduction (SCR) to meet EPA2010 emissions. The system is designed to require very little driver interface to maintain correct operation. The technology utilizes a passive regeneration; requiring no fuel to be injected to clean the DPF. In EPA2007 an active regeneration (fuel was injected) was required to clean out the DPF producing very high exhaust outlet temperatures. Certain vocational duty cycles will require the use of fuel and/or a parked regeneration to clean out built-up soot in the particulate filter. Exhaust temperatures will increase during a parked regeneration. When parking the vehicle to perform a parked regeneration keep away from any flammable materials, vapors or structures.



### **DANGER**

Exhaust gases and components can be at extremely high temperatures during regeneration. When parking the vehicle, keep away from any flammable materials, vapors, or structures.



### **DANGER**

The temperature of the exhaust system components during the regeneration process can exceed 350 degrees C (660 F). The exhaust gas leaving the system can reach 505 degrees C (930 F). Various factors (including ambient temperature and duration of the regeneration process) determine when these components will return to normal operating temperature after regeneration has completed. Be extremely careful around these hot components. Contact with these components can result in serious personal injury.

## Exhaust Aftertreatment System Components and

### Selective Catalytic Reduction (SCR)

Selective Catalytic Reduction (SCR) is an emissions-reduction technology with the ability to deliver near-zero emissions of nitrogen oxides (NOx), a smog-causing pollutant and greenhouse gas. SCR's performance has been proved in millions of miles of real-world trucks in other countries, as well as in long-term field tests in the U.S.

SCR reduces NOx emissions to very low levels, while at the same time delivering excellent fuel economy and reliability. The system doesn't change the design or of the basic engine. Rather, SCR is an aftertreatment system which converts NOx in the exhaust stream into harmless gases. Modern diesels already use exhaust

aftertreatment systems, called diesel particulate filters, to control emissions of another pollutant, soot (also known as particulate matter or PM).

SCR works by injecting Diesel Exhaust Fluid (DEF) into the exhaust. DEF is a solution of ultra-pure water and urea. DEF works with the heat of the exhaust and a catalyst to convert NOx into nitrogen and water vapor - two harmless and natural components of the air we breathe. The end result is cleaner air, excellent fuel efficiency and a reliable emissions control system for today's modern diesel engine.

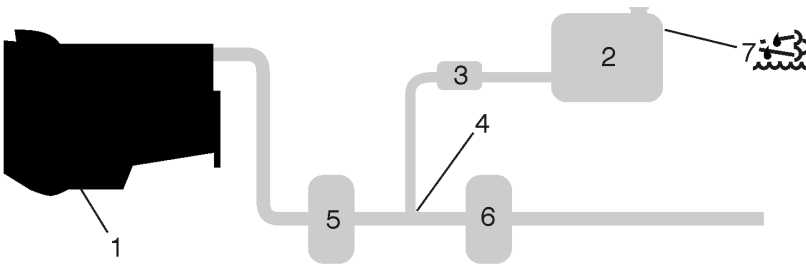

W2031651

#### System Operation

1 Diesel engine optimized for high performance, low particle emissions and low fuel consumption.

2 Aftertreatment DEF tank

3 The Aftertreatment Control Module (ACM) continuously monitors and adjusts the DEF injection rate.

4 DEF is injected into the exhaust gases in between the Aftertreatment DPF (5) and the SCR catalyst (6).

5 Aftertreatment Diesel Particulate Filter (DPF).

6 In the SCR catalyst, nitrogen oxides are transformed into harmless nitrogen gas and water.

7 The system notifies the driver when it is time to refill tank with DEF.

The Mack SCR system is simple and effective, with few components. It consists of a Aftertreatment DEF tank positioned near the standard diesel tank, plus a Aftertreatment DEF pump, Aftertreatment DEF Dosing unit and SCR catalyst.

The advantage of using DEF is that it enables the engine to use less EGR -- and higher oxygen levels -- for better combustion, while meeting the EPA near-zero NOx emissions requirement of 0.2 g/hp-hr NOx. By using DEF, we avoid the disadvantages of increasing EGR to massive levels. This results in better fuel economy from your Mack engine.



W2055490

Vertical SCR, side inlet



W2055491

Vertical SCR, vertical inlet

## 242 Mack, EPA2010 Emissions Solution

---



W2055492

Horizontal SCR, full size



W2055493

Horizontal SCR, compact size



### CAUTION

Do not put diesel fuel in the Aftertreatment DEF tank. Diesel fuel, if sprayed into the hot exhaust along with the DEF, could ignite explosively causing a fire resulting in personal injury or damage to the exhaust system.



W3036787

## Diesel Exhaust Fluid (DEF)

Diesel Exhaust Fluid (DEF) is a reactant that's key to the SCR process. It's a nontoxic, ultra-pure solution of urea and ultra-pure water. Urea is a compound of nitrogen that turns to ammonia when heated. The fluid is non flammable, and is not dangerous when handled as recommended. However, it is highly corrosive to certain metals, especially copper and brass. Read the separate section concerning the handling of DEF solution.

Use only **Diesel Exhaust Fluid** that is **clearly labeled as meeting ISO-22241 standards, and certified by the American Petroleum Institute**. The container **must display the API certification seal**. **Never use agricultural or industrial grade**

**urea**. Use of fluids other than API certified Diesel Exhaust Fluid will compromise aftertreatment system performance, increase emissions, and may impact your product warranties. **Never dilute DEF with water or any other fluid.**

It is recommended that DEF not be stored in extreme hot or cold conditions, or for prolonged periods. Follow the instructions for proper storage and handling as indicated on the container or provided with the purchase.

**Note:** Agriculture mixtures are not pure enough for use in the SCR system and impurities in the solution will comprise the SCR system.

### *Diesel Exhaust Fluid (DEF) Handling*

When handling DEF solution, it is important to prevent contact with electrical connections. There is a risk that the DEF will cause oxidation that cannot be removed. Water or compressed air do not help, since DEF quickly oxidizes certain metal. If a disconnected connector comes into contact with the DEF solution it must be replaced immediately to prevent the DEF solution from creeping further into the copper wiring.



#### **CAUTION**

When detaching hoses and components, do not spill DEF on disconnected or unsealed connectors. If DEF is spilled on a disconnected or unsealed connector, the connector must be replaced immediately.

#### Things to know about spilled Diesel Exhaust Fluid (DEF)

If DEF solution comes into contact with the skin: rinse with plenty of water and remove contaminated clothing.

If DEF solution comes into contact with the eyes: rinse for several minutes and call for medical help if necessary.

If inhaled: breathe fresh air and call for medical help if necessary.

Do not allow the DEF solution to come into contact with other chemicals.

The DEF solution is not flammable. If the DEF solution is exposed to high temperatures, it breaks down into ammonia and carbon dioxide.

The DEF solution is highly corrosive to certain metals, including copper and brass.

If the DEF solution is spilled onto the vehicle, wipe off the excess and rinse with water. Spilled DEF solution can form concentrated white crystals on the vehicle. Rinse off these crystals with water.

**Note:** Do not flush DEF spillage into the normal drain system.

## *Diesel Exhaust Fluid( DEF) Consumption*

DEF consumption is related to fuel consumption. A highway truck may travel 225–300 miles or more on one gallon of DEF. A gauge much like a fuel gauge will indicate the level of DEF in the tank. A DEF low-level warning will activate when DEF is low. If a driver runs out of DEF

completely, vehicle power will be reduced. When the DEF tank is refilled, the engine will resume normal power.

**Note:** DEF tanks are sized for a two to one fuel to DEF ratio in order to meet US 2010 requirements.

## *Diesel Exhaust Fluid (DEF) Availability*

DEF will be available in 2.5-gallon containers, 55-gallon drums, 275 gallon IBC and in bulk storage for fleet locations, truck stops and dealerships. All major truck stops, dealers and distributors will carry DEF.

DEF will freeze below –11 degrees

C (12 F). DEF needs to be protected from extended periods of severe cold. For more information on DEF and availability please visit the website [www.Mackscr.com](http://www.Mackscr.com) or please contact Mack One-Call at 1–800–866–1177.



### Aftertreatment Diesel Particulate Filter (DPF)



#### CAUTION

Use of diesel fuel other than ULSD and engine oils other than EO-O Premium Plus (or VDS-4), will adversely affect performance, efficiency and durability of the Aftertreatment DPF system and the engine, to the point where the engine may not run at all. Manufacturers warranties can also be rendered void due to usage of improper fuel. Unapproved fuel additives (including engine oil) are NOT permitted. Blends of No. 1D and No. 2D grades of ULSD are recommended and allowable for cold weather operations.

The exhaust aftertreatment system virtually eliminates exhaust smoke. White exhaust vapor (water condensation) may be visible during a cold start. If black

exhaust smoke is visible during engine operation, this indicates a problem with the exhaust aftertreatment system. Take the vehicle to an authorized Mack Truck dealer immediately.

Vehicles equipped with a 2010 emission compliant engine have an exhaust aftertreatment system which includes a Selective Catalytic Reduction (SCR) system and a Conventional or TRU Aftertreatment Diesel Particulate Filter (DPF). The Aftertreatment DPF takes the place of the standard muffler, and it reduces particulate emissions into the atmosphere. Soot and other particulate matter are collected by a filter where it is eventually oxidized using a regeneration process. Vehicles equipped with a Aftertreatment DPF require the use of EO-O Premium Plus (or VDS-4) specification high performance diesel engine oil and Ultra Low Sulfur Diesel (ULSD) fuel.

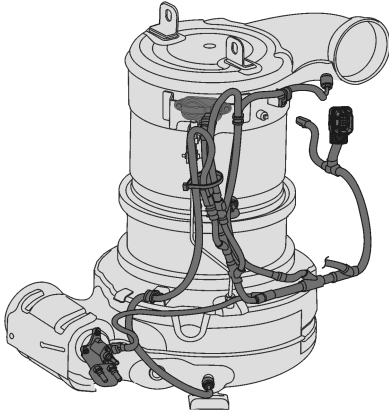

W2030326

## Aftertreatment Control Module (ACM)

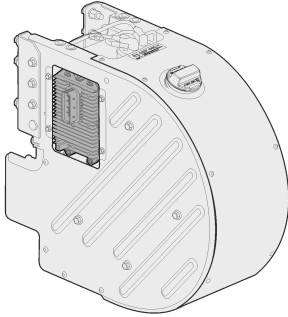

W2029917

The ACM controls the following components in the exhaust aftertreatment system:

- Aftertreatment DEF Dosing Unit
- Aftertreatment DEF Tank Heater Valve
- Aftertreatment DEF Line Heaters
- Aftertreatment DEF Pump
- Aftertreatment DEF Return Valve

The ACM also monitors the following values in the exhaust aftertreatment system:

- Aftertreatment DEF Dosing Pressure
- Aftertreatment DEF Tank Temperature
- Aftertreatment DEF Tank Level
- Aftertreatment DPF Inlet/Outlet Temperature
- Aftertreatment DEF Tank Level Sensor
- Aftertreatment DPF Differential Pressure
- NOX Sensors

The ACM is a stand alone module. Depending on your configuration it may be mounted as part of the DEF tank (as shown above) or on a bracket near the DEF tank.

**Exhaust Aftertreatment System**

## Aftertreatment DPF Regeneration

**DPF Smart Switch**– This is a three-position switch where the middle position is neutral.

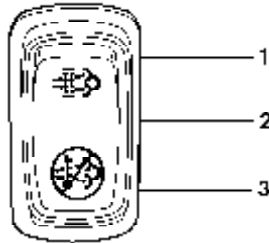

C0029148

**DPF Smart Switch**

1. Upper Position – Regeneration Position

2. Middle Position – Neutral Position

3. Down Position – Inhibit Position (if equipped)



### CAUTION

During the Aftertreatment DPF Regeneration, the exhaust gas temperature will be elevated. **DO NOT** park the vehicle with the exhaust outlet near flammable objects such as trees, awnings, etc. that could be damaged by elevated exhaust gas temperatures.



### CAUTION

If the vehicle is in a location that may be hazardous when DPF Regeneration begins (i.e., in close proximity to flammable materials or gases, inside tunnels, parked under flammable objects, etc.), the DPF Regeneration should be stopped (if equipped). If DPF Regeneration is stopped by the vehicle operator, it must be initiated at a later time when the vehicle is in a safer location. DPF Regenerations that are stopped and never restarted at a later time, however, will require that the vehicle be taken to an authorized Mack Truck dealer to have the Aftertreatment Regeneration manually started with special service tools.

**Note:** During vehicle operation, idle speed may increase when the vehicle is stopped at a traffic light to maintain heat in the DPF for passive regeneration and urea dosing.

There are two types of Aftertreatment DPF Regeneration: Passive regeneration and Parked regeneration.

Passive regeneration occurs when the exhaust gas within the aftertreatment system is hot enough to remove soot without injecting additional fuel into the dpf system. On chassis equipped with a US07 aftertreatment system, DPFs needed an active regeneration, that included this injection of fuel. With the addition of the SCR system active regenerations are no longer needed for EPA2010.

### Parked Regeneration

The Aftertreatment DPF Regeneration system is self-monitoring. Under certain duty cycles driver action is needed to perform a parked regeneration. When driver action is needed to perform a parked regeneration, an icon at the top of the DPF Smart switch will illuminate to notify the vehicle operator. The DPF Smart switch allows the vehicle operator to either stop or start regeneration. (Certain conditions must be met, however, before regeneration can be manually started.)

Parked regeneration allows the operator to start and/or stop the regeneration manually when the vehicle is parked and the engine is idling. The operator is notified that a regeneration is needed when the icons on the DPF Smart switch illuminate. The operator should perform the regeneration as soon as possible.

Please refer to the instructions below on how to use the DPF Smart switch for parked regenerations.

1. Move the vehicle to a safe location, apply the park brake and allow the engine to idle.



## WARNING

When a regeneration is in process, the temperature of the exhaust will be elevated. **DO NOT** park the vehicle with the exhaust outlet under low hanging overhead flammable objects such as trees, awnings, etc., that could be damaged by elevated exhaust temperatures. **DO NOT** attempt to regenerate inside a garage or enclosed area if the tail pipe is attached to an exhaust ventilation system as the hose material may not be rated for the high temperature.

2. Press and hold the top part of the DPF Smart switch momentarily to initiate the regeneration.
3. During regeneration, the icons on the switch will shut off. The HEST indicator on the instrument cluster will light up to notify of high exhaust temperatures.
4. For aftertreatment DPF filter systems, the engine speed may ramp as high as 1,250 rpm.
5. Parked regeneration will take between 30 and 45 minutes to complete.
6. After regeneration has completed and the exhaust temperature has returned to normal, the HEST indicator will shut off.
7. To stop regeneration, press the switch down to the inhibit position (if equipped). When the bottom of the switch is illuminated, regeneration is stopped. The switch will remain locked in this position and the light will stay illuminated. The driver has the option of stopping a regeneration if the vehicle is in an area where elevated exhaust temperatures will pose a hazard (i.e., tunnel, under trees, in an area where there is flammable material, etc.).

**Note:** The HEST lamp will remain On if it comes On during the regeneration, and remain On until the exhaust temperature returns to normal.



## CAUTION

*Failure to perform a regeneration in a timely manner after notification may result in engine derate, a clogged DPF, damage to the DPF and engine shutdown.*



### DANGER

*During the regeneration process, the temperature of the exhaust gases will be elevated. DO NOT park or stop for an extended period under low hanging overhead flammable objects such as trees, awnings, structures, etc., that could be damaged by elevated exhaust temperatures. Further, if the vehicle is being operated in an area where flammable vapors exist, the regeneration process must be interrupted. Failure to heed these cautions may result in fire or explosion causing serious personal injury or death.*

**Note:** Do not initiate a parked regeneration if the vehicle is in a location that may be hazardous (i.e., in close proximity to flammable materials or gases),

If a parked regeneration is stopped by the vehicle operator, it should be initiated at a later time when the vehicle is in a safe location. However, if a parked regeneration is stopped too many times, the vehicle must be taken to a MACK service facility. The service facility will use a service tool to manually initiate the regeneration.



### WARNING

**The temperature of the exhaust system components during the regeneration process 350 degrees C (660 F). The exhaust gas leaving the system can reach 505 degrees C (930 F). Various factors (including ambient temperature and duration of the regeneration process) determine when these components will return to normal operating temperature after regeneration has completed. Be extremely careful around these hot components. Contact with these components can result in serious personal injury.**



### CAUTION

*When the inhibit position is pressed, the switch will remain in a locked position. It is important, therefore, to immediately set the switch back to the neutral position when safe to do so. Failure to set the switch back to the neutral position may result in an engine derate, clogged diesel particulate filter or damage to the filter.*









## DPF INHIBIT ROAD SPEED LIMITING (RSL)

The DPF Smart Switch can be locked into the DOWN (or Inhibit Regen) position by the driver (if equipped). If the DPF Smart Switch remains in the locked position, the following vehicle speed limiting will occur:

- 1 **Vehicle Moving.** If vehicle is moving with the DPF Smart Switch in the locked (DOWN) position, the vehicle speed will decrease down to 16 kph (10 mph) below the current speed until the driver releases the switch back to the neutral (MIDDLE) position.
- 2 **Vehicle Stationary and then Moving.** If the vehicle is stationary with the DPF Smart Switch in the locked (DOWN) position and the driver then begins to move the truck, the vehicle speed will be limited to 16 kph (10 mph) until the driver releases the switch back to the neutral (MIDDLE) position.

Refer to the Exhaust Aftertreatment System Information sun visor label for additional Aftertreatment DPF information.

### ENGINE EXHAUST AFTERTREATMENT SYSTEMS (EATS)

| DEF Indicators:                            |  (solid)      |  (flashing)   |  (flashing)+ Message  |
|--|--|--|--|
| Diesel Exhaust Fluid (DEF) Condition:      | The DEF tank is low.   | The DEF tank is empty. Engine is in derate mode.   | The DEF tank is empty. The vehicle is limited to 5 mph.  |
| DEF Action:                                | Refill the DEF tank.   | Refill the DEF tank now (before adding diesel).  | Refill the DEF tank now (before operating vehicle).  |
| DEF Indicators:                            |  (flashing) |  (flashing)  |  (flashing)  |
| Diesel Particulate Filter (DPF) Condition: | The DPF filter is full.  | The DPF filter is overfull. Engine is in derate mode.  | The DPF filter may be clogged with soot. Engine is in shutdown mode.   |
| DPF Action:                                | Initiate a parked manual regeneration at next available stop.                                  | IMMEDIATELY stop and initiate a parked regeneration.   | Service EATS system immediately.   |
| See Operator's Manual for Further Detail   |  |  |  |

W8056653



# Driver Warnings and On Board Diagnostics (OBD)

## On Board Diagnostics (OBD)

Beginning with your US 2010 compliant Vehicle, On Board Diagnostics (OBD) is introduced. This is very similar to the On Board Diagnostics (OBD) system that has been required on passenger cars for many years.

On Board Diagnostics (OBD) is a system that monitors the functions of emissions related components and alerts

the vehicle operator to any detected need for an emission related repair. When the systems detects a needed repair to an emissions related component it activates the Malfunction Indicator Lamp (MIL).

The list of emissions related components can be found in the Warranty and Maintenance section of this manual.

## Instrument Cluster

The aftertreatment icons are located in the instrument cluster per the following images.

### CHU Instrument Cluster

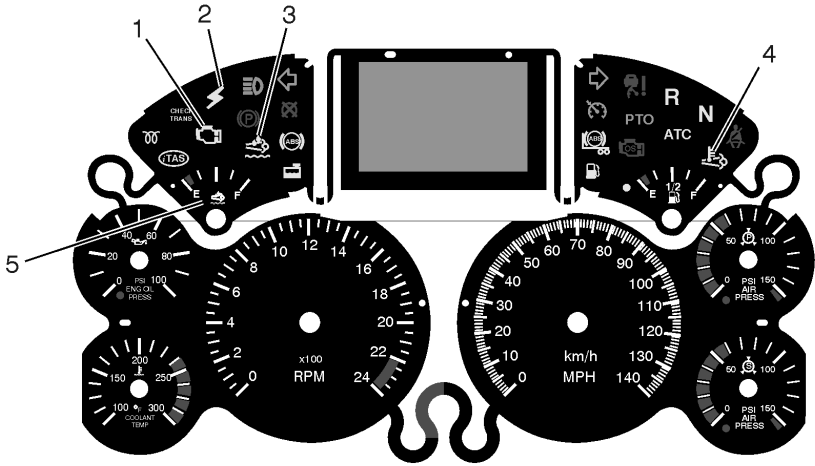

W3031621

|   |                                  |                                |
|---|----------------------------------|--------------------------------|
| 1. Malfunction Indicator Lamp (MIL)     | 2. CHECK Lamp                    | 3. Aftertreatment DEF Low Lamp |
| 4. High Exhaust Temperature (HEST) Lamp | 5. Aftertreatment DEF Tank Gauge |                                |

# 256 Mack, EPA2010 Emissions Solution

## Instrument Cluster Icons

Aftertreatment icons are displayed on the instrument cluster. There are 3 aftertreatment icons:

- Aftertreatment DPF Regeneration Required
- High Exhaust System Temperature (HEST)
- Aftertreatment DEF Tank Low Level Indicator

The Aftertreatment DPF Regeneration Required icon flashes when the Diesel Particulate Filter is full/overfull and regeneration is needed.



W3007445

Aftertreatment DPF Regeneration Required Icon

The High Exhaust System Temperature icon illuminates when a parked Aftertreatment DPF Regeneration Required is initiated. It also indicates high

exhaust gas temperature during a passive regeneration. When the HEST icon is illuminated, do not park or operate the vehicle near people, or any flammable materials, vapors, or structures.



W3007444

High Exhaust System Temperature (HEST) Icon



W2029416

Aftertreatment DEF Tank Low Level Indicator (DEF)

The Aftertreatment DEF Tank Low Level Indicator icon illuminates when the fluid level is low. It also Flashes when the level becomes critically low.

## Malfunction Indicator Lamp (MIL)

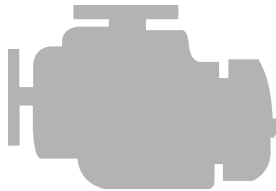

W3031200



MIL Lamp

- MIL indicates government Regulation On Board Diagnostics (OBD) faults
- **Lamp may remain active after repair until system confirms repair**

## Aftertreatment DEF Tank Level - Driver Warning & Inducement





Aftertreatment DEF tanks are sized to have no less than 2 times the diesel fuel tank mileage or hour range

The vehicle instrument cluster has a Aftertreatment DEF Tank Level Gage

| Triggers   | Aftertreatment DEF Tank Low Level Indicator   | Amber Warning Lamp | Inducement                            |
|--|---|--------------------|---------------------------------------|
| >12% Aftertreatment DEF Tank Level Gauge   | None  | None               | None                                  |
| <=12% Aftertreatment DEF Tank Level Gauge  | <br><small>W2029416</small>  | None               | None                                  |
| 0% Aftertreatment DEF Tank Level Gauge (~4% DEF Remaining)                                       | <br><small>W2029415</small>  | None               | 25% torque reduction                  |
| 0% Aftertreatment DEF Tank Gauge<br>Insufficient DEF Pump Pressure<br>Diesel Fuel Refueling >15% | <br><small>W2029415</small> | None               | 8 km/h (5 mph) Road Speed Limit (RSL) |

**Note:** Vehicle has to be stationary before 5 mph RSL becomes active.

## Aftertreatment DEF Quality - Driver Warning & Inducement

| Triggers  | Aftertreatment DEF Tank Low Level Indicator | Amber Warning Lamp   | Inducement                            |
|---|---|--|---------------------------------------|
| Good DEF Quality  | None  | None   | None                                  |
| Poor DEF Quality DTC Initial Detected                                       | None  | <br>W3031623  | None                                  |
| Poor DEF Quality DTC Initial Detected + 10 hours                            | None  | <br>W3031623  | 25% torque reduction                  |
| Poor DEF Quality DTC Initial Detected + 20 hours Diesel Fuel Refueling >15% | None  | <br>W3031623  | 8 km/h (5 mph) Road Speed Limit (RSL) |
| Temporary Exit from 5 mph Inducement  | None  | <br>W3031623 | 25% torque reduction                  |

**Note:** Vehicle has to be stationary before 8 km/h (5 mph RSL) becomes active.

## Exit conditions for DEF Quality "5 mph road speed limit" Inducement:

**First Restart:** Return to 25% torque reduction until proper DEF quality evaluation. If poor DEF quality is detected during the next monitoring cycle then the 5 mph limit is resumed after vehicle is stationary for 20 minutes. After the second restart a Service Tool is required to exit the 8 km/h (5 mph) RSL.

## Misfilling Diesel or Aftertreatment DEF Tanks

Although diesel fuel and Aftertreatment DEF caps are clearly labeled and filler necks and nozzles are different accidents can happen.

Contamination of fluids by- misfilling of diesel or DEF in the wrong tank may result in vehicle malfunction.

### Results of misfilling DEF in Diesel Tank

- Engine may run poorly or not at all
- Injectors may be damaged
- Exhaust system corrosion may occur between turbocharger and Aftertreatment DPF
- On Board Diagnostic (OBD) Diagnostic Trouble Codes (DTC)
- Costly repairs

### Results of misfilling Diesel in Aftertreatment DEF Tank





- Aftertreatment SCR system may be damaged by Diesel
- SCR Catalyst may be damaged by diesel (chemical damage)
- Emissions may be non-compliant
- On Board Diagnostic (OBD) Diagnostic Trouble Codes (DTC)
- Costly repairs

**Note:** DEF tank has a magnetic interlock and fuel station DEF fluid dispensing nozzle with a magnetic valve, have to meet to prevent from dispensing into anything other than the DEF tanks.

## 260 Mack, EPA2010 Emissions Solution

### SCR Tampering - Driver Warning & Inducement

|  |   |
|--|---|
| 1. Disconnected Aftertreatment DEF tank level sensor | 4. Disconnected Aftertreatment DEF pump |
| 2. Blocked Aftertreatment DEF line or dosing unit    | 5. Disconnected SCR wiring harness      |
| 3. Disconnected Aftertreatment DEF dosing unit       | 6. Disconnected NOx Sensor              |

| Triggers   | Aftertreatment DEF Tank Low Level Indicator | Warning Lamp   | Inducement                      |
|--|---|--|---------------------------------|
| No Tampering   | None  | None   | None                            |
| Tampering DTC Pending  | None  | <br><small>W3031623</small>   | None                            |
| Tampering DTC Confirmed  | None  | <br><small>W3031623</small>   | None                            |
| Tampering DTC Initial Detected + 10 hour                             | None  | <br><small>W3031623</small>  | 25% torque reduction            |
| Tampering DTC Initial Detected + 40 hours Diesel Fuel Refueling >15% | None  | <br><small>W3031623</small> | 8 km/h (5 mph) road speed limit |

**Note:** Operator can not override the 5mph road speed limit and that 5mph road speed limit.

**Note:** Vehicle has to be stationary before 8 km/h (5 mph RSL) becomes active.

## Warranty and Maintenance

### Exhaust Aftertreatment System Maintenance

The vehicle must be taken to an authorized Mack Truck dealer to remove the ash from the Aftertreatment Diesel Particulate Filter and clean the Aftertreatment Doser.

### Engine Maintenance Intervals

| Component  |                | Interval  |
|--|----------------|---|
| Fuel Filter  | Change         | Every oil change. Under certain conditions (for example, irregular fuel quality), the fuel/water separator filters may require more frequent replacement. |
| Air Cleaner  | Change         | Control lamp indication or 24 months, whichever comes first   |
| Valve and Injector Lash adjustment , MP7 and MP8             | Initial Adjust | 200 000 km (125,000 miles) or 12 months, whichever comes first  |
| Injector Lash Adjustment , MP7 and MP8                       | Adjust         | Every 400 000 km (250,000 miles) or 24 months, whichever comes first  |
| Valve and Injector Lash adjustment MP10                      | Initial Adjust | 100 000 km (60,000 miles) or 6 months, whichever comes first  |
| Injector Lash Adjustment, MP10                               | Adjust         | Every 200 000 km (125,000 miles) or 12 months, whichever comes first  |
| Aftertreatment DPF Ash Cleaning                              | Clean          | 400 000 km (250,000 miles) or 4,500 hours, whichever occurs first   |
| Aftertreatment Doser   | Clean          | 240 000 km (150,000 miles) or 4,500 hours, whichever occurs first   |
| Aftertreatment Diesel Exhaust Fluid (DEF) Filter             | Change         | First change at 161 000 km (100,000 miles) 3200 hours or 3 years whichever occurs first, 241,000 km (150,000 miles) 4800 hours or 3 years there after     |
| Aftertreatment Diesel Exhaust Fluid (DEF) Filler Neck Filter | Clean          | 280 000km (175,000 miles) or 12 months, whichever comes first   |



### MAINTENANCE INTRODUCTION

Preventive maintenance is vital to the life of your new vehicle. This section of the Operator's Handbook covers items of importance concerning the proper care of MACK vehicles. A well-run maintenance and lubrication program is the best way to ensure a long life of productive .

The operator plays an important role in the proper care of this equipment. By performing daily checks and observing the equipment while in , minor defects can be caught and corrected before they become major problems. Make sure any problems are corrected before putting the equipment into .

If you have any questions concerning the proper care, maintenance and lubrication of your vehicle, or if you need help in developing a preventive maintenance program, contact the service manager at the local MACK Sales, Parts and Service Center.

**Note:** This handbook contains basic maintenance information. For complete maintenance and lubrication procedures, refer to the *Maintenance and Lubrication Manual (21394653)*.

## TURBOCHARGER

The engine turbocharger operates at very high speed, temperatures and pressure. Turbo bearing lubrication is critical, particularly for a newly installed turbo or one which has not been operated for a period of time and all oil has drained from the bearing and shaft surfaces. To avoid turbocharger bearing failure, the following instructions are recommended:

- Start the engine at least every 30 days to ensure turbo bearing lubrication. Operate engine at low idle for at least three minutes before increasing RPM or driving the vehicle.
- If the engine has not been run for more than 30 days, turbo pre-lube procedure is necessary:
  1. Pour clean engine oil into the oil inlet port at the top of the turbocharger until overflowing.
  2. Spin the compressor wheel by hand several revolutions while wiggling the shaft back and forth. This ensures that oil is distributed over all bearing surfaces.
  3. Install the inlet air duct to the turbocharger, and install the turbocharger drain tube (use a new gasket). Make sure that all clamps are tightened and positioned properly to ensure no leaks in the intake piping.
  4. Disconnect the connector from the VTG control valve.
  5. Again, pour clean engine oil into the turbocharger oil inlet port until overflowing, and then reconnect the oil supply line.
  6. Start the engine and allow it to run at an idle for at least five minutes.

**Note:** Disconnecting the connector from the VTG control valve prevents the turbocharger from reaching excessive speeds when the engine is first started.

7. After the engine has run for at least five minutes, shut the engine off and reconnect the VTG control valve connector.
8. Use the V-MAC® service tool to clear the fault code.

## CLEANING YOUR VEHICLE

The best protection against environmental influences that can hurt your vehicle's finish is frequent washing and waxing. How often this is required depends on how much the vehicle is used, where it is parked and weather conditions. Frequent washing is required to remove oils, dirt and grime that can stain and oxidize the painted and polished surfaces of your new truck.

### Exterior Washing

Recommendations for the first 30 days...

- Only wash the vehicle by hand with cool water, a mild car wash solution and a soft cloth or sponge. Do not use a commercial truck wash.
- Wash the vehicle in the shade, never in direct sunlight.
- Do not dry wipe the finish; always use clean water. Dry wiping could scratch the finish.
- Do not park near factories with heavy smoke fallout for extended periods of time.
- Bird droppings have high acid content and can damage freshly painted surfaces. They should be cleaned off as soon as possible.
- Do not spill gasoline, diesel fuel, oil, antifreeze, transmission fluid or any solvents of the like on the new finish. If you do... IMMEDIATELY rinse off with water. DO NOT WIPE.
- Do not scrape ice or snow from surface. Brush off the loose material with a soft snow brush.

Recommendations for the first 90 days.

- Do not wax or polish the vehicle; this will allow the finish to dry and harden completely. (Do not use waxes or polishes that contain silicone.)

**Note:** Do not wash the vehicle in direct sunlight.



#### DANGER

*Test the service brakes after washing the vehicle. Moisture and/or ice on the brakes can affect braking efficiency.*

**Note:** When washing the vehicle in cold/freezing weather, avoid direct water spray into the door lock cylinders, as the water may freeze in the lock mechanisms.



#### CAUTION

*Proper care of the paint finish is an important part of the durability. Chemicals used to wash the paint should be of neutral pH with a range of between 6 and 8. Detergents containing butyl cellosolve or potassium hydroxide should not be used.*

**Note:** Vehicles should be washed only in special wash bays to protect the environment from cleaning agent contamination.



**DANGER**

*Vehicle cleaning products must be handled carefully, as these products may be poisonous. Keep all cleaning products out of the reach of children.*



**WARNING**

**Do not clean the underside of the fenders, cab, chassis, etc., without protecting the hands and arms, as injuries may result when scraping against sharp edges.**



**CAUTION**

*For chassis used in concrete s, do not use muriatic acid or similar types of products to clean concrete from the cab or frame surfaces. Use of these types of products will damage the paint finish and void the vehicle warranty. Mack Trucks, Inc. has approved EL-ReadyMix Truck Wash & Wax for removing concrete from the vehicle surfaces. This product is available on a direct ship basis from EMS®. For additional information, contact EMS® at 800-510-8812, or on their web site at [www.enviromfg.com](http://www.enviromfg.com).*

**Note:** Unprotected aluminium surfaces will form an oxide layer if not maintained. This is especially important during cold season when roads are salted or in coastal areas where the salt level in the air is high. Clean with steam or high pressure water. Use a mild detergent if the dirt is heavy. Rinse well. Clean aluminium surfaces with warm water. If the surface has heavy dirt or tar spots, use a tar remover. To prevent spotting, wipe aluminum surfaces dry after washing. The use of an aluminium protective Carnuba-based wax is recommended after washing for longer term protection from road salts and spotting.

### Cab and Hood

- Soften the dirt on your cab with plenty of water and rinse.
- Clean truck with a soft sponge/brush starting at the roof and working downward using slight pressure.
- Use mild detergent. Never use strong soaps or chemical detergents. Any commercially available cleaner designed specifically for automotive finishes may be used for cleaning the cab and hood surfaces. The 3M company and Mequiar's® have a complete line of automotive cleaning products available that are approved for use on MACK vehicles.
- Rinse the sponge or brush often to keep it clean.
- If possible, clean wheels and dirtier areas with a separate sponge/brush. This will help avoid scratching body paint with grit from other areas.
- Rinse truck thoroughly with water and wipe dry with a soft clean chamois or all cotton towels to avoid surface scratches and water spotting.



#### CAUTION

*Do not clean the underside of the fenders, cab, chassis, etc. without protecting your hands and arms. You may injure yourself on sharp-edged parts.*

### Chassis

- Wash away excess dirt and grime with water from a hose.
- Use a mild detergent/soap and a soft brush to remove road grime and salts that can collect on the frame.
- Rinse thoroughly with a hose.

**Note:** Cleaning of your chassis on a regular basis will help deter accelerated corrosion and rust on the frame and components. Chemicals used for ice and snow removal and dust control can collect on the frame. If these are not removed in a timely manner, accelerated corrosion can occur on fuel lines, frame, and other components even though they have corrosion protection.

## Cab Interior

- For cleaning vinyl upholstery and lining: wipe with a soft cloth, using a good commercial upholstery cleaner. Do not use acetone, lacquer thinner, etc.
- For cleaning fabric upholstery: use an upholstery shampoo specially designed for this purpose. Follow the directions on the manufacturer's label.

## Waxing

- Always use waxes and polishes that are non-abrasive. Do not use waxes or polishes that contain silicone.
- When water does not form small drops and roll off clean paint, apply a coat of good hard wax.
- Even if a liquid wax solution is used on a regular basis, it is advisable to protect the finish with a hard wax at least twice a year.
- Your truck may have a basecoat plus clearcoat. Use a basecoat/clearcoat wax on your paint finish.

## Polishing

Polish your truck only if the paint has lost its shine and the gloss cannot be brought back with wax. It is recommended to have a professional polish your truck to avoid swirl marks or damage to the painted surface. Mequiar's® has a complete line of waxes, polishes and other cleaning and care products that are approved for use on MACK cabs, hoods and sleeper surfaces.

## Winter Warnings

- If you rinse your vehicle with a hose, avoid direct water into lock cylinders. You may experience freezing of the lock mechanism.
- Test brakes after each vehicle wash. Moisture and ice on brakes can affect braking efficiency.

A well kept vehicle can look like new after many years of service. Proper care and maintenance can help you keep your vehicle's beauty and value. You can get an assortment of Mack Trucks approved cleaning products from your local Mack dealer.

### TOWING

Tow pins, hooks, eyes, etc., are located in or behind the front bumper. These devices meet the recommendations for towing set forth by the Technology and Maintenance Council (TMC) of the American Trucking Association and can be used for towing a disabled vehicle from the immediate location.



#### CAUTION

*Do NOT lift and tow any vehicle by tow pins, hooks, eyes, etc. If the vehicle is mired in heavy mud, snow, etc., use a suitable sling-type towing arrangement.*

**Note:** Tow pins, hooks, eyes, etc., are NOT intended for use as long-term towing devices.



#### CAUTION

*Failure to disconnect the driveshaft, remove the drive axle shaft(s) or lift the drive wheels off the ground before towing or pushing the vehicle, can cause serious transmission damage.*



#### DANGER

*If the drive shaft has been removed for towing, DO NOT reuse bearing retainer bolts or stamped strap bolts, or stamped straps. Reuse of bearing retainer bolts or stamped strap bolts, or stamped straps can cause driveline failure, which can result in separation of the driveline from the vehicle. A separated driveline can result in property damage, serious personal injury or death.*

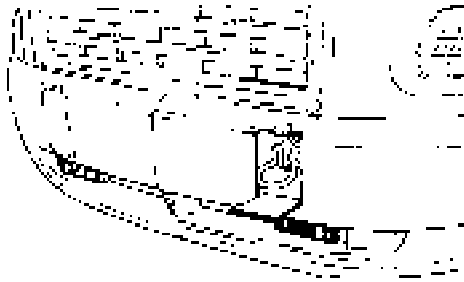

C0029420

**Note:** On Rawhide vehicles, the bumper must be removed prior to towing to access the clevis.



C0029421

1. Rawhide Bumper



## 270 MAINTENANCE AND LUBRICATION

---

### Towing with MACK Air (AL or MAXAIR® 40) Suspension (If Equipped)

During vehicle towing, when the rear axles of a chassis with the MACK AL suspension are raised from the ground, the axle is held in position by the fore-aft torque rods, transverse torque rod and the shock absorbers.

To prevent damage to any of these components during rear towing, the following precautions should be taken:

- Exhaust the air from the air bags.
- Use chains of suitable length and secure the axles to the frame.



#### CAUTION

*Be sure that the chains do not rub against spring members because this could adversely affect spring member life.*



#### CAUTION

*Tow truck operators must be trained in proper hook-up techniques, safety precautions, and the correct of their equipment to avoid vehicle damage and personal injury.*

## ENGINE OIL LEVEL CHECK

As the operator of this vehicle, it is important for you to perform the daily inspections necessary to keep your truck in good shape. Maintaining the proper oil level in your engine crankcase cannot be overemphasized.

Before checking the oil, remember these important points:

- Measurement of the oil level must be taken on level ground.
- The best time to check oil level is while the engine is COLD (prior to starting at the beginning of the work day, or after the vehicle has sat approximately 2 hours). At normal operating temperature (engine oil temperature above 79.4°C [175°F]), oil level can be checked 15 minutes after shut down.



### CAUTION

*Failure to wait a sufficient amount of time (2 hours if engine oil temperature is below 79.4°C [175°F]) or 15 minutes if oil temperature is above 79.4°C [175°F]) will result in an inaccurate dipstick reading.*

- The level must be close to the FULL line (at least between the ADD and FULL lines) on the dipstick, but must NOT exceed the FULL line (refer to illustration below).

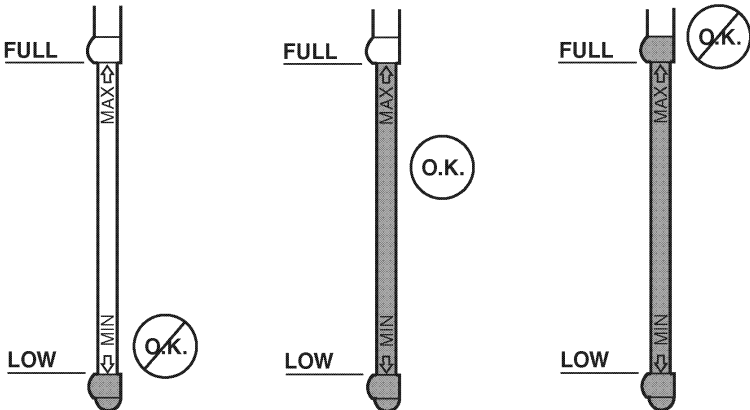

C0029422

## Oil Change Intervals

The length of time an engine can operate before an oil change depends on the quality oil used, the type of fuel used, fuel consumption, engine oil consumption, vehicle application, level of dust in the air, and fuel consumption. The change intervals given in this manual are maximum intervals. If the vehicle is

operating in heavy-duty or severe duty, dusty or off-road conditions, etc., reduce the intervals for more frequent oil changes.

**Note:** Use the information in the table below to determine the operating condition and usage applicable to your vehicle.

| Engine Operating Condition  | Medium             | Heavy              | Severe             |
|---|--------------------|--------------------|--------------------|
| Total Fuel Consumption (mpg)  | more than 6        | more than 4.7      | more than 3.7      |
| Total Fuel Consumption (L/100 km)   | less than 39       | less than 50       | less than 64       |
| MP7 and MP8 Engine Oil and Filter Change Interval, km (miles) — 36L (38 quart) oil capacity | 56 000<br>(35,000) | 40 000<br>(25,000) | 24 000<br>(15,000) |
| MP10 Engine Oil and Filter Change Interval, km (miles) — 42L (44 quart) oil capacity        |                    |                    |                    |
| MP10 Engine Oil and Filter Change Interval, km (miles) — 52L (55 quart) oil capacity        | 80 000<br>(50,000) | 56 000<br>(35,000) | 40 000<br>(25,000) |
| <b>Note:</b> If idle time is greater than 25%, use the next lower drain interval.           |                    |                    |                    |

For additional information about oil change intervals, see your Mack Truck dealer. Also, refer to Bulletin 175-60, Oil and Filters, Mack Components.

For a complete list of approved oils, see your Mack Truck dealer. Also, refer to Bulletin 175-61, Approved Oils, Mack Components.

## **Engine Maintenance Intervals**

| <b>Components</b>  |               | <b>Intervals</b>  |
|--|---------------|---|
| Water Separator  | Filter Change | Every oil change. Under certain conditions (for example, irregular fuel quality), the fuel/water separator filters may require more frequent replacement. |
| Coolant (Standard)   | Change        | 500,000 km (300,000 miles) or 24 months, whichever comes first  |
| Coolant (ELC)  | Change        | 500,000 km (300,000 miles) or 24 months, whichever comes first  |
| Coolant Filter (Standard)  | Change        | 80,000 km (50,000 miles) or 6 months, whichever comes first   |
| Coolant Filter (ELC)   | Change        | 240,000 km (150,000 miles) or 12 months, whichever comes first  |
| Main drive and accessory drive belts, Highway usage MP7 and MP8    | Change        | 500,000 km (300,000 miles) or 36 months, whichever comes first  |
| Main drive and accessory drive belts, Vocational usage MP7 and MP8 | Change        | 240,000 km (150,000 miles) or 12 months, whichever comes first  |
| Main drive and accessory drive belts, Vocational usage MP10        | Change        | 500,000 km (300,000 miles) or 36 months, whichever comes first  |

### Power Steering Reservoir

The Power Steering system uses only DEXRON® type automatic transmission fluid.

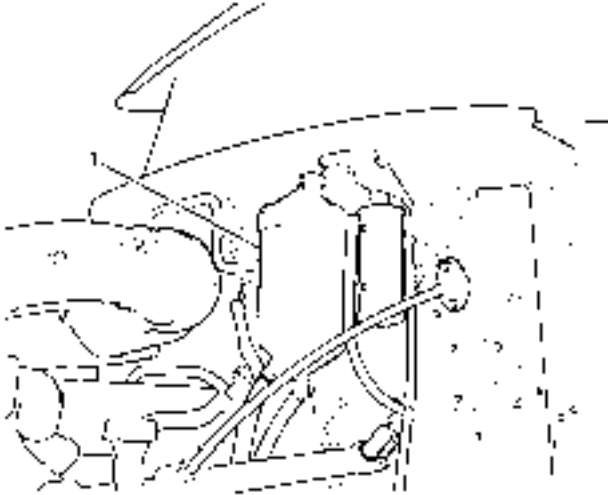

C0029423

#### Power Steering Reservoir

|                             |
|-----------------------------|
| 1. Power Steering Reservoir |
|-----------------------------|

For additional information about power steering, refer to the *Maintenance and Lubrication Manual (21394653)*.

## FUEL TANK

Your vehicle may be equipped with an isolated fuel tank. If so equipped, the following label will be affixed to the fuel tank decal.

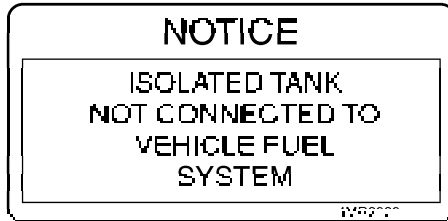

C0029424

## Fuel Tank Cap

Use MACK approved non-vented cap only or tank damage and/or poor engine performance may result. DO NOT fill to more than 95% of liquid capacity.

## FUELING



### DANGER

*DO NOT carry extra fuel containers in the cab. Fuel containers, full or empty, may leak, explode or give added fuel to a fire. Failure to follow this precaution may lead to serious personal injury or death.*



### DANGER

*DO NOT smoke while fueling the vehicle. The glow from the cigar/cigarette can ignite the diesel fuel, causing an explosion resulting in serious personal injury or death.*



### DANGER

*Do not remove the fuel tank cap near an open flame. Diesel fuel vapors are combustible and can cause an explosion or fire, resulting in severe personal injury or death.*



### CAUTION

*Diesel-powered engines for heavy-duty trucks built on or after January 1, 2010 are designed to operate only with Ultra Low Sulfur Diesel (ULSD) fuel. Improper fuel use will reduce the efficiency and durability of engines, permanently damage advanced emissions control systems, reduce fuel economy and possibly prevent the vehicles from running at all. Manufacturer warranties will be voided by improper fuel use. Additionally, burning Low Sulfur Diesel fuel (instead of ULSD fuel) in 2007 and later model year diesel-powered cars, trucks and buses is illegal and punishable with civil penalties.*



### CAUTION

*Ultra Low Sulfur Diesel (ULSD) fuel with a maximum sulfur content of 15 ppm must be used in order to meet Euro4 engine emission requirements. Using otherwise approved diesel fuels with a maximum sulfur content greater than 500 ppm may shorten engine life and void the engine warranty.*

Air is always present inside the fuel tanks, entering mainly through the tank ventilation. With the air being heated and cooled, condensation is formed and water is mixed in the fuel. To avoid condensation when the vehicle is parked for longer periods, fill the tanks up to 95% of capacity. Do not fill more than that, as the fuel needs to have room for expansion during the heat of the day.

## **B5 Approval For Mack US10 Certified Products**

Mack engines are certified to comply with U.S. EPA and California emissions standards based upon the use of test fuels with specifications established by these regulatory agencies. Alternative fuels, including biodiesel, that are not substantially similar to the required test fuels may adversely affect engine emissions compliance and may impact the performance of certain emissions aftertreatment components. As a result, Mack does not warrant the engine will conform to applicable Federal or California emissions limits when operated on, or having operated on, biodiesel or other alternative fuels that are not substantially similar to specified test fuels used for certification.

The use of biodiesel up to a maximum of 20% (B20) in and of itself, will not affect the manufacturers mechanical warranty as to engine and emissions system related components except as limited below with respect to aftertreatment components, provided the bio fuel used in the blend conforms to ASTM D6751 and B1 to B5 blends conform to ASTM D975, and B6 to B20 blends conform to ASTM D7467. Failure of certain emissions aftertreatment components, specifically SCR, DPF and NOx sensors will not be warranted if the failure can be attributed to operation on biodiesel blends from 6 to 20% (B6 to B20) even if the biodiesel used in the blend B6 to B20 conforms to ASTM D7467 or any related standard.



### COOLING SYSTEM

The cooling system is a pressurized system. The coolant is circulated by a centrifugal pump. It is a typical system in most respects, but there are a few things to keep in mind when checking or working on the cooling system.



#### **WARNING**

**Keep clear of fan when engine is running. Fan may start to rotate at high speed without warning.**



#### **WARNING**

**Avoid injury when checking coolant in a hot engine. Wait for the engine to cool prior to checking the level whenever possible.**

## Coolant Level Check



### **WARNING**

**Turn the cooling system pressure cap counterclockwise slowly. After the pressure has completely dissipated, continue turning to remove the cap.**

Your MACK model chassis has a pressurized plastic coolant expansion tank where quick checks of coolant level can be made and additional coolant can be added to the system. The expansion tank is mounted on the radiator.

Periodically, the coolant level should be checked by observing the coolant in the expansion tank.

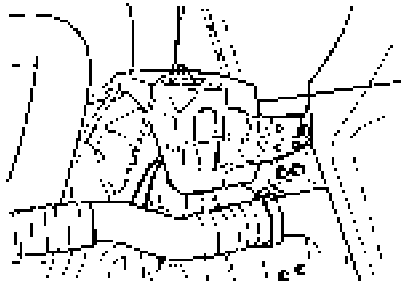

C0029425

### 1. Expansion Tank

## Draining the Cooling System

Whenever repairs are to be made which would require disconnection of coolant hoses, etc., the cooling system should be drained. Carefully remove the filler cap and remove all pipe plugs.

## Refilling the Cooling System

Close all drain cocks and fill with the proper coolant mixture. Run engine with the pressure cap removed until operating temperature is reached and the thermostat opens. Recheck level and add coolant if required. Run the engine long enough to be sure the system is free of air and has the correct amount of coolant.

### Protecting the Cooling System



#### CAUTION

*The concentration of ethylene glycol or propylene glycol in the cooling system must be checked with a refractometer prior to traveling or operating in areas where subfreezing temperatures may be encountered. When adding antifreeze to the system, run the engine for 20 minutes before checking with a refractometer.*

**Note:** Your chassis is currently supplied from the factory with engine coolant protection to  $-23^{\circ}\text{C}$  ( $-10^{\circ}\text{F}$ ). Optional coolant protection to  $-40^{\circ}\text{C}$  ( $-40^{\circ}\text{F}$ ) is also available.

Ethylene glycol or propylene glycol-based antifreezes are both approved for all MACK engines. All ethylene glycol and propylene glycol coolants must be low-silicate antifreezes which meet ASTM4985 test (GM6038M SPEC) criteria. These antifreezes are sometimes referred to as heavy-duty diesel coolants. Passenger car coolants do NOT meet this specification.

Be sure to maintain the required level of antifreeze protection for anticipated winter temperatures in your area of . A 40% to 60% concentration of antifreeze is required for MP engines, regardless of application, geographic location or ambient air temperature.



#### CAUTION

*Do NOT exceed a 60% concentration of antifreeze to water. A higher percentage of antifreeze will not increase protection. Concentrations over 60% adversely affect freeze protection and heat transfer rates.*

**Note:** Propylene glycol should be checked with a refractometer.

**Note:** ALWAYS mix the water/antifreeze solution before pouring it into the cooling system.

**Note:** The piping arrangement may cause capacity variation depending on the type of cooling system and optional external cooling devices which may be attached. Therefore, it is difficult to tell exactly how much coolant it will take to fill any one particular system.



## CAUTION

*Do NOT use coolant solutions which contain anti-leak additives in trucks equipped with coolant filters or conditioners.*



## CAUTION

*Do NOT use soluble oil-type coolants in any MACK cooling system.*

## Cooling System Maintenance

The cooling system must be maintained by performing regularly scheduled maintenance as outlined in the Maintenance and Lubrication Manual (21394653). Cold weather s, however, place added demands on the cooling system. Prevent potential cold weather problems by performing a quick check of the cooling system as outlined below:

- Make a general check for cooling system leaks.
- Inspect hoses and clamps for leaks and condition. Tighten hose clamps to specifications (as required).
- Check coolant level. Add fresh coolant (in specified concentration) as necessary.
- Check and record degree of antifreeze concentration. Add antifreeze as necessary to obtain required protection level.

For additional information concerning the cooling system, refer to the *Maintenance and Lubrication Manual (21394653)*.

## Accessory Drive Belt Routing

The following diagram shows the accessory drive belt and main belt routing with and without air conditioning. This diagram is located in a clear area on the outside of the left frame between the radiator and center line of the front axle.

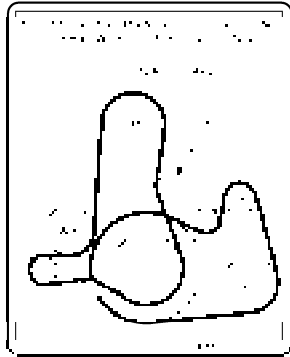

1

C0029426

### Accessory and Main Drive Belt Routing

1. Accessory and Main Drive Belt Routing MP8 Engine

## HEADLIGHTS

### Bulb Replacement

**Note:** The long-life halogen bulbs can be replaced without tools.



#### CAUTION

*Never touch the glass of a halogen bulb with your bare hands or a dirty rag. Oils and other contaminants can greatly reduce bulb life or cause the bulb to explode.*

- Open the hood. Remove the bulb access cover.

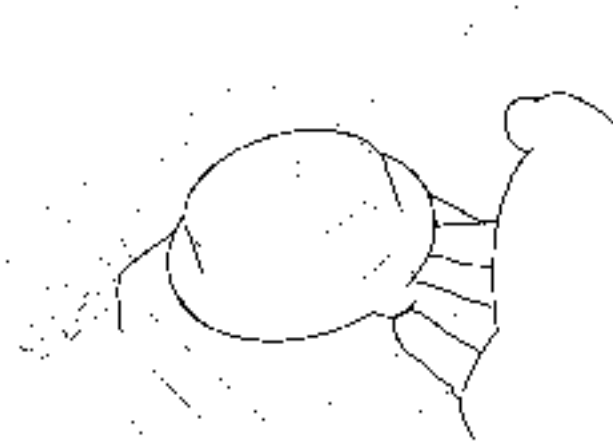

C0029427

## 284 MAINTENANCE AND LUBRICATION

---

- Lift the wire connector clip and remove the connector.

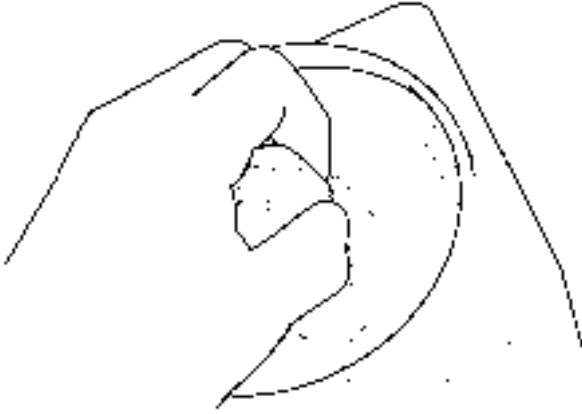

C0029428

- Turn the bulb retaining ring counterclockwise and remove. Retain the ring for installation of the new bulb.



C0029429

- Pull the bulb out and discard it.

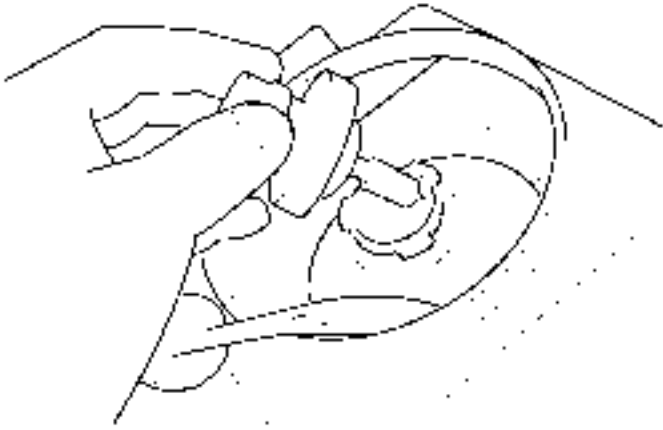

C0029430

Reverse the procedure to install the new bulb.



### WHEELS

#### Wheel Inspection

Look at the wheels and cap nuts. Inspect them for evidence of cap nut looseness. Rust streaks from the cap nut ball seat are an indication of looseness. Refer to the Maintenance and Lubrication Manual (21394653) for complete procedures concerning wheel inspection and wheel nut tightening.

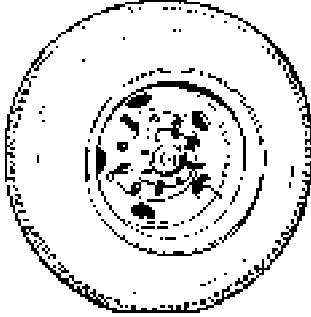

C0029431

Look for cracks around the hand hole, stud hole and wheel. Look for broken studs, wheel damage or improperly seated lock rings.

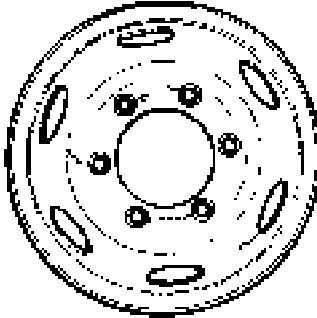

C0029432

Tires



**DANGER**

*Tires used on multipiece rims must be assembled and inflated only by experienced, qualified personnel. Tires must be inflated in a safety cage whenever possible. If, however, a safety cage is not available, use a portable lock-ring guard. The tire must be deflated prior to removal of the tire-and-rim assembly from the vehicle. Remove the valve core to ensure complete deflation.*



**DANGER**

*NEVER position your body in front of the rim during inflation.*



**CAUTION**

*NEVER use water-based sealants, puncture proofing, or liquid balance materials containing water in All-Steel Radial Ply truck tires.*

**Inflation Pressure**

To ensure maximum mileage and overall performance from your tires, it is essential that they operate at the correct inflation pressure for the load carried. Inflation pressure should be checked daily while the tires are cold. Always use an accurate tire pressure gauge. NEVER bleed air from a hot tire, as it will then be under inflated. Refer to the specific tire manufacturer's data books, or to the vehicle certification label for a complete listing of tire inflation pressures. For additional information concerning tire care, refer to the *Maintenance and Lubrication Manual (21394653)*.



**WARNING**

**UNDER NO CIRCUMSTANCES** should you drive on underinflated or overloaded tires. A tire in this condition builds up excessive heat which can result in sudden tire destruction, property damage and personal injury.



### CAUTION

*Never bleed air from your tires in an attempt to gain traction for a vehicle stuck in snow, ice or mud. This practice provides no additional traction and typically results in under inflated tires. Never bleed air from a hot tire since that tire will then be under inflated.*

To adjust for pressure fluctuations induced by temperature changes associated with winter weather, it is recommended that tire inflation pressure be checked daily when the tires are cold (i.e., before the vehicle is driven). Always use an accurate tire pressure gauge.

### ***Inspection***

Inspect your tires daily. Look for bulges, cracks, cuts, penetrations and/or oil contamination. If any such damage is found, the tire must be thoroughly inspected by a qualified tire inspector and repaired or discarded immediately, at his discretion. Also, check for uneven wear. If found, a thorough inspection of front end parts and alignment should be made by a qualified mechanic. Refer to the Maintenance and Lubrication Manual (21394653) for more information.

### ***Tire Manufacturer's Data Book***

Specific and more detailed information can be obtained by referring to the technical data books provided by each tire manufacturer.

Subjects of interest are:

- High-speed or low-speed
- Repair, retreading and regrooving
- Use of tire chains
- Mixing radial and bias tires on the same vehicle
- Use of dynamometers
- Tire mounting/dismounting



## CAUTION

*For important tire information (i.e., high speed limits, inflation pressures, etc.), consult the product information available through the specific tire manufacturer.*

### **Oil Contamination of Tires**

Lubricating oils, fuel oil, gasoline and other petroleum derivatives, if allowed to contact tires, will soften the rubber and destroy the tire. Preventive maintenance is necessary to ensure that oil leakage does not occur. The following areas should be inspected on a regular basis:

- Axle end seals
- Engine seals
- Transmission seals
- Drive axle seals
- Oil filters
- Oil and hydraulic lines (if equipped)
- Refer to the *Maintenance and Lubrication Manual*, specific tire manufacturer's books, or to the vehicle certification label, for additional information concerning tires and their care.

## BATTERY



## CAUTION

*To avoid damage to sensitive electronic equipment, disconnect ALL battery cables and harnesses to electronic control units before welding. Do NOT disconnect batteries while engine is running.*

### Jump-Starting Engine

If you encounter a situation in which it is necessary to jump-start an engine, use the following procedures.



#### WARNING

**Batteries which are to be linked together must be of the same voltage (12 to 12, 24 to 24). Take care to observe proper polarity when connecting batteries. Batteries produce explosive gases. Keep sparks, flames, cigarettes, etc., away from batteries at all times. Protect your eyes by wearing safety goggles. Be sure vehicles are NOT touching each other.**



#### CAUTION

*To avoid damaging any electronic controllers when jump-starting a V-MAC vehicle, always turn the ignition switch OFF before connecting the batteries.*

**Note:** Your vehicle may be equipped with a jump-start connector which is located on the left rear side of the cab.

1. Connect the positive (+) cable to positive (+) post of discharged battery or to the positive post of the remote jump-start connector (if equipped).
2. Connect the other end of the same cable to the positive (+) post of the booster battery.
3. Connect the second cable, negative (-) side, to the other post of the booster battery.
4. Make the final connection to the negative (-) battery terminal or the remote jump-start connector (if equipped) of the stalled vehicle, and stand back.

5. Start the vehicle with the booster batteries and then start the stalled vehicle. Shut down the vehicle with the booster batteries and remove the cables in the reverse order of connection.



### WARNING

**Do NOT connect the final negative (-) connection to the frame of the stalled vehicle. This would cause all current to flow through the master ground circuit breaker resulting in overload.**

## ELECTRICAL

### Circuit Breaker and Relay Panels

The electrical equipment cover for this vehicle is located in the middle of the dash under the top cover.

The cover panels are fastened with screws. Most relays and fuses are accessible from under the top cover. Since the function of some fuses or relays may change for the vehicle, refer to the list of functions that is attached beneath each panel.

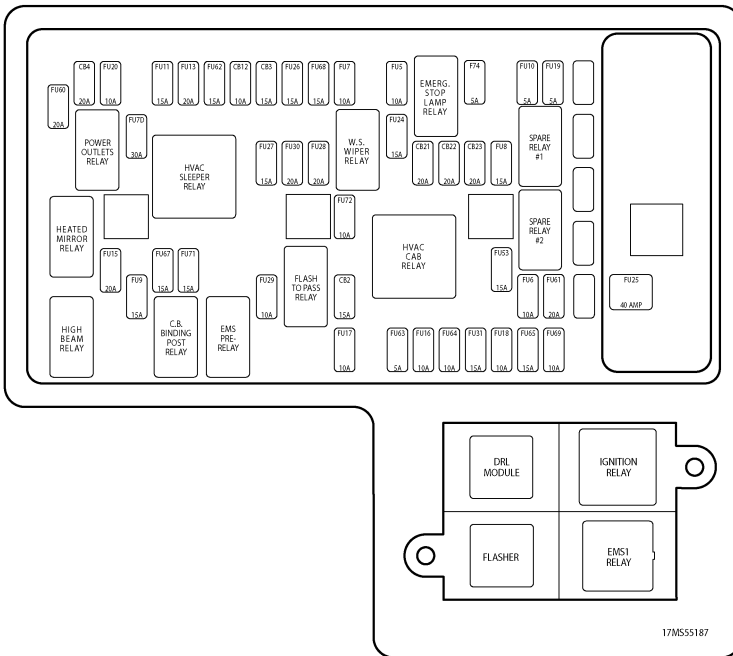

C0029433

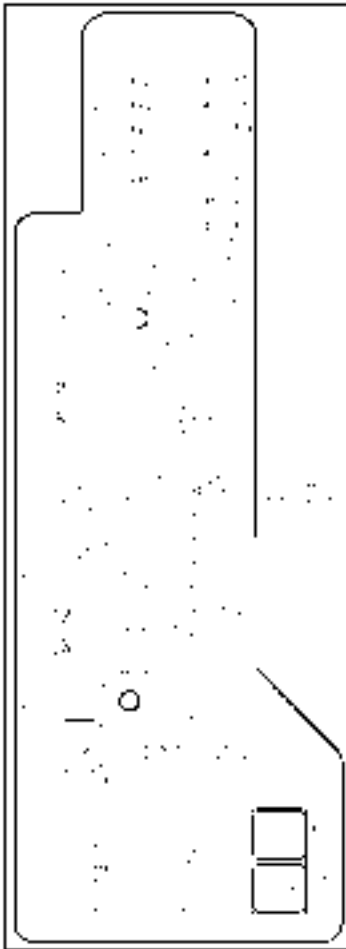

1

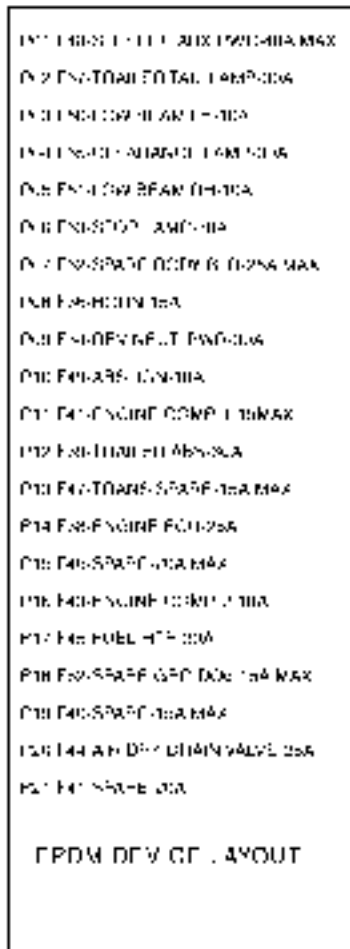

2

C0029434

|          |         |
|----------|---------|
| 1. Front | 2. Back |
|----------|---------|



**Note:** For circuit breaker designations, refer to the Circuit Protection charts.

Fuses are standard equipment for all circuits except the headlamps and windshield wipers. Circuit breakers are available as optional equipment.



### CAUTION

*For proper installation of electrical accessories, all wiring should meet SAE requirements and be routed through the circuit protection panel with proper amperage fuses or Type II circuit breakers. (Headlights and wipers will be on Type I, cycling-type circuit breakers.)*

Some vehicles may be equipped with daytime running lights. For the daytime running lights to be on, a DRL module must be installed in the relay socket marked either DRL MOD or Running Lamps on the electrical equipment panel. Do NOT install a standard relay into the daytime running light relay socket (marked either DRL MOD or Running Lamps) or a short circuit in the headlight high beam circuit will result.

The headlight circuits are protected by SAE Type I (automatic reset-cycling) circuit breakers that automatically interrupt then restore the flow of current through the circuit in the event of an overload. This cycling will continue until the cause of the overload is repaired.

SAE Type II (automatic reset, non-cycling) circuit breakers (if equipped) provide a complete circuit disconnect until the overload is corrected. The power to the affected circuit breaker must be shut off before the circuit breaker will reset itself.

The circuit protection panel also provides access to battery, ignition and ground terminals for non-factory installed electronic equipment. (On V-MAC chassis, there are two serial link terminals for easy local connection of a trip recording device.)

## Electrical Grease

To prevent corrosion of the lamp socket terminals, particularly with the clearance and marker lamp, apply a coating of electrical sealing grease, such as Lubriplate DS-ES or TEK-519, to the socket and terminal assemblies.

|   |                |
|---|----------------|
|  | <b>CAUTION</b> |
| <i>Do not use electrical grease on any V-MAC connectors.</i>                      |                |

## Circuit Protection Charts

| <b>Cab Circuit Protection</b>  |                                      |                                |                            |
|--|--------------------------------------|--------------------------------|----------------------------|
| #1   | #2 – 15A                             | #3 – 15A                       | #4 – 20A                   |
| Open   | Headlamps, DRL Module, Fog Lamps     | Park & Tail Lps., Marker Lamps | Direct Lps., Flasher       |
| #5 — 10A   | #6 — 10A                             | #7 — 10A                       | #8 — 15A                   |
| Tractor Stop Lps.  | Dome Lps., Courtesy Lps.             | Ign. Switch                    | Air Solenoid               |
| #9 — 15A   | #10 — 5A                             | #11 — 15A                      | #12 – 10A                  |
| CB Posts   | Communication Connector (DDL), Radio | Battery Stud                   | Electric Door Locks        |
| #13 – 20A  | #14                                  | #15 – 20A                      | #16 – 10A                  |
| ABS  | Open                                 | Heated Mirrors                 | Vehicle Control Unit (VCU) |
| #17 – 10A  |                                      | #18 — 10A                      | #19 — 5A                   |
| Clutch Switch, Engine Brake, Cruise On/Off & Set/Resume, Override Switch, Park Brake, PTO w/o T2000, Spare (VCU) Relay Coils |                                      | DPF Switch Power/Spare         | ABC Cluster                |
| #20 – 10A  | #21 — 20A                            | #22 — 20A                      | #23 — 20A                  |
| Moto Mirrors   | Windshield Wiper & Washer            | LH Window Lift Motor           | RH Window Lift Motor       |
| #24 — 15A  | #25 – 40A                            | #26 — 15A                      | #27 — 15A                  |
| Spare Batt./Ign. Power   | Heater/Air Conditioner               | Hook-Up Lps.                   | Ignition Stud              |

## 296 MAINTENANCE AND LUBRICATION

| <b>Cab Circuit Protection</b> |  |                               |                               |
|-------------------------------|--|-------------------------------|-------------------------------|
| #28 — 20A                     | #29 — 10A                                    | #30 — 20A                     | #31 — 15A                     |
| Htd. seats                    | EMS #1 Relay<br>Coil/Short Range<br>Wireless | Opt. Ign. Power<br>Sw., Spare | Auto shift trans.<br>or spare |
| #53 — 15A                     | #60 — 20A                                    | #61 — 20A                     | #62 — 15A                     |
| A/C Comp.<br>Clutch           | 2-Power Outlet<br>Sockets                    | Aux. sw's/Spare               | Spare/Battery                 |
| #63 — 5A                      | #64 — 10A                                    | #65 — 15A                     | #67 — 15A                     |
| ABC Gauge<br>Cluster          | Cold Start                                   | VORAD Module                  | Spare/Battery                 |
| #68 — 15A                     | #69 — 10A                                    | #70 — 30A                     | #71 — 15A                     |
| Cigar Lighter                 | Keyless Entry<br>Module                      | HVAC Sleeper                  | Transmission                  |
| #72 — 10A                     | #74 — 5A                                     |                               |                               |
| HVAC/Control<br>Unit          | Illumination                                 |                               |                               |

## MAINTENANCE AND LUBRICATION 297

| <b>Engine Circuit Protection (V-MAC IV)</b> |                             |                            |                              |
|---|-----------------------------|----------------------------|------------------------------|
| #32 — 30A                                   | #33 — 30A                   | #34 — 30A                  | #35 — 30A                    |
| Spare Body Bld.                             | Trailer Stop Lps.           | Reverse/Neutral Power      | Cab & Trailer Clearance Lps. |
| #36 — 15A                                   | #37 — 30A                   | #38 — 25A                  | #39 — 30A                    |
| Horn  | Trailer Tail Lps.           | Engine Control Unit (ign.) | Trailer ABS Power            |
| #40 — 15A                                   | #41 — 15A                   |                            | #42 — 20A                    |
| Spare                                       | Engine Compartment          |                            | Back-Up Lps.                 |
| #43 — 10A                                   | #44 — 25A                   | #45 — 30A                  | #46 — 20A                    |
| Engine Compartment                          | Air Dryer, Htd. Drain Valve | Fuel Heater                | NOx Sensor/Spare             |
| #47 — 10A                                   | #48 — 50A                   | #49 — 10A                  | #50 — 10A                    |
| Meritor Trans. EOA or Spare                 | Sleeper Box                 | ABS                        | Low Beam L.H.                |
| #51 — 10A                                   | #52 — 15A                   |                            |                              |
| Low Beam R.H.                               | Spare/Guard Dog             |                            |                              |

### Electrical Accessory Connection Points



#### CAUTION

*The electrical systems on all MACK chassis include a circuit breaker located in the ground circuit. Any additional electrical components that may be added MUST not be connected directly to the battery or negative connection of the starter. Doing so may defeat the protection provided by this circuit breaker. Components may be ground connected to other locations, such as frame or engine grounding points.*

This MACK chassis is ready for convenient installation of electrical accessories. Use only the designated CB jacks on the dashboard, or battery post (12 volts), ignition, ground post, buffered tachometer (RPM) output, and buffered speedometer (MPH) output connections available on the electrical equipment panel. Each connection point is described below.

#### **Battery Post (BATT)**

This is a 12-volt, unswitched battery power connection. It can be used to power external devices that require power at all times, even when the key is turned off. This source is protected by a 20-amp circuit breaker.

#### **Ignition Post (IGN)**

This is a 12-volt, switched battery power connection. It can be used to power external devices that require power only when the key is turned on. This source is protected by a 15-amp circuit breaker.

#### **Ground Post (GND)**

This is a ground connection. It can be used as a power return connection for external devices.



#### WARNING

**The tachometer output, speedometer output, and serial links A and B are for specific hookups. These terminals should be used only for their specified purposes and connection to these terminals should be done only by a qualified service technician.**

**Note:** The tachometer output and speedometer output are 50% duty cycle, Transistor-Transistor Logic (TTL) compatible, square wave signals that are calibrated to provide a standard pulse rate of 12 pulses per engine revolution for the tachometer output and 30,000 pulses per mile for the speedometer output. TTL compatibility of these outputs may be affected by other devices connected to these outputs.

### ***Tachometer (RPM) Output***

This terminal is to be used for devices requiring information for engine speed signals. (See the Warning and Note above.)

### ***Speedometer (MPH) Output***

This terminal is to be used for devices requiring information for vehicle speed signals. (See the Warning and Note above.)

### ***SAE/ATA J1708 Posts (Serial Links A and B)***

This is a serial communication interface. It conforms to the SAE/ATA J1708 Recommended Practice for Serial Data Communications Between Microcomputer Systems in Heavy-Duty Vehicle Applications. (See the Warning above.)

### ***CB Radio Power Jack***

The CB radio power jacks are located on the dashboard of the day cab, and on the headliner of the sleeper.

**Power Jack (+)** This is a 12-volt, switched battery connection. It is to be used to power the vehicle's CB radio. It is protected by a 15-amp circuit breaker and will supply power when the key is in the ACCESSORY position or ON position.

**Power Jack (-)** This is a ground connection. It is to be used as a power return connection for the vehicle's CB radio.

## 300 METRIC CONVERSIONS

---

### METRIC CONVERSIONS

**Note:** Use all tools on the fasteners they were made to be used on. Use metric tools on SI metric units only. Never try to use metric tools on U.S. standard fasteners or U.S. standard tools on SI metric units.



#### CAUTION

*Potential external/internal thread mismatch condition(s) may occur with certain metric thread-inch thread fastener combinations, and with fastener combinations involving incompatible metric fastener systems. A given thread mismatch condition can result in thread stripping and/or assembly weakness leading to potential service failure, thereby rendering a vehicle non-al and/or unsafe for . The specific external/internal thread combinations from which such problems can result are identified and set forth in Maintenance and Lubrication Manual (21394653).*

| <b>SI to U.S. Conversions</b>   |   |                        |
|---------------------------------|---|------------------------|
| 25.4 millimeters                | = | 1 inch                 |
| 1.61 kilometers                 | = | 1 mile                 |
| .473 liter                      | = | 1 pint (U.S. liquid)   |
| .946 liter                      | = | 1 quart (U.S. liquid)  |
| .01639 liter                    | = | 1 cubic inch           |
| 1.3558 Newton meters            | = | 1 pound-foot           |
| .746 kilowatt                   | = | 1 horsepower           |
| 6.895 kilopascals               | = | 1 pound/square inch    |
| (1.8 x degrees Celsius) + 32    | = | degrees Fahrenheit     |
| .83267 Imperial gallon          | = | 1 gallon (U.S. liquid) |
| <b>U.S. to SI Conversions</b>   |   |                        |
| .03937 inch                     | = | 1 millimeter           |
| .6214 mile                      | = | 1 kilometer            |
| 2.1134 pints (U.S. liquid)      | = | 1 liter                |
| 1.0567 quarts (U.S. liquid)     | = | 1 liter                |
| 61.024 cubic inches             | = | 1 liter                |
| .7376 pound-foot                | = | 1 Newton meter         |
| 1.34 horsepower                 | = | 1 kilowatt             |
| .145 pound/square inch          | = | 1 kilopascal           |
| .556 x (degrees Fahrenheit -32) | = | degrees Celsius        |
| 1.2009 gallons (U.S. liquid)    | = | 1 Imperial gallon      |



