



# Renault KANGOO

Driver's handbook

RenaultUSA.com

<https://www.truck-manuals.net/renault/>



# A passion for performance

 ELF, partner of  
**world  
series**  
by RENAULT



## RENAULT recommends ELF

Partners in cutting-edge automotive technology, Elf and Renault combine their expertise on both the racetrack and the city streets. This enduring partnership gives drivers a range of lubricants perfectly suited to Renault cars. Lasting protection and optimum performance for your engine – guaranteed. Whether changing the oil or simply topping up, to find the approved ELF lubricant best suited to your vehicle, ask your Renault dealer for a recommendation or consult your vehicle maintenance handbook.



[www.lubricants.elf.com](http://www.lubricants.elf.com)



<https://www.truck-manuals.net/renault/>

A brand from **TOTAL**

# Welcome to your new vehicle

---

**This Driver's Handbook** contains the information necessary:

- for you to familiarise yourself with your vehicle, to use it to its best advantage and to benefit fully from all the functions and the technical developments it incorporates.
- to ensure that it always gives the best performance by following the simple, but comprehensive advice concerning regular maintenance.
- to enable you to deal quickly with minor faults not requiring specialist attention.

It is well worth taking a few minutes to read this handbook to familiarise yourself with the information and guidelines it contains about the vehicle and its functions and new features. If certain points are still unclear, our Network technicians will be only too pleased to provide you with any additional information.

The following symbol will help you when reading this handbook:



**To indicate a hazard, danger or safety recommendation.**

The descriptions of the models given in this handbook are based on the technical specifications at the time of writing. **This handbook covers all items of equipment** (both standard and optional) **available for these models but whether or not these are fitted to the vehicle depends on the version, options selected and the country where the vehicle is sold.**

**This handbook may also contain information about items of equipment to be introduced later in the model year.**

Throughout the manual, the “approved Dealer” is your RENAULT Dealer.

Enjoy driving your new vehicle.

Translated from French. Copying or translation, in part or in full, is forbidden unless prior written permission has been obtained from the vehicle manufacturer.



# C O N T E N T S

## Sections

**Getting to know your vehicle** .....

**1**

**Driving** .....

**2**

**Your comfort** .....

**3**

**Maintenance** .....

**4**

**Practical advice** .....

**5**

**Technical specifications** .....

**6**

**Alphabetical index** .....

**7**



# Section 1: Getting to know your vehicle

Key, radio frequency remote control: general information, use, deadlocking . . . . .	1.2
Doors . . . . .	1.7
Locking/unlocking the doors . . . . .	1.12
Automatic locking when driving . . . . .	1.14
Headrests/Front seats . . . . .	1.15
Front seats . . . . .	1.19
Roof flap . . . . .	1.22
Swivelling partition . . . . .	1.24
Seat belts . . . . .	1.25
Methods of restraint in addition to the front seat belts . . . . .	1.29
Side protection devices . . . . .	1.32
Additional methods of restraint . . . . .	1.33
Child safety: General information . . . . .	1.34
Choosing a child seat mounting . . . . .	1.37
Fitting a child seat . . . . .	1.39
Deactivating/activating the front passenger airbag . . . . .	1.46
Steering wheel . . . . .	1.49
Driving position . . . . .	1.50
Warning lights . . . . .	1.54
Displays and indicators . . . . .	1.58
Trip computer and warning system . . . . .	1.61
Clock and outdoor temperature . . . . .	1.70
Rear view mirrors . . . . .	1.72
Audible and visual signals . . . . .	1.74
External lighting and signals . . . . .	1.75
Headlight beam adjustment . . . . .	1.78
Windscreen wipers/washers . . . . .	1.80
Fuel tank . . . . .	1.83

## KEY, RADIO FREQUENCY REMOTE CONTROL: general information (1/2)

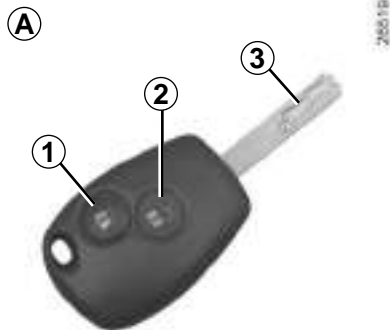

### Radio frequency remote control A

- 1 Locking all the opening elements.
- 2 Unlocking all the opening elements.
- 3 Coded key for ignition switch, driver's door and fuel filler cap.

The key must not be used for any function other than those described in the handbook (removing the cap from a bottle, etc.).

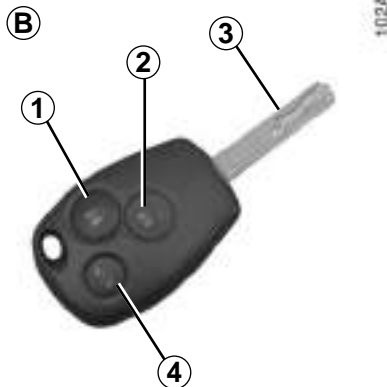

### Radio frequency remote control B

- 1 Locking all the opening elements.
- 2 Unlocking all the opening elements.
- 3 Coded key for ignition switch, driver's door and fuel filler cap.
- 4 Locking/unlocking the luggage compartment and, depending on the vehicle, the sliding side doors.

#### Advice

Avoid leaving the remote control in hot, cold or humid areas.

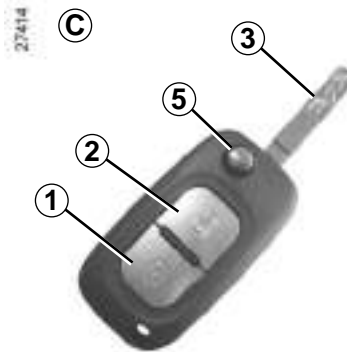

### Radio frequency remote control C

- 1 Locking all the opening elements.
- 2 Unlocking all the opening elements.
- 3 Coded key for ignition switch, driver's door and fuel filler cap.
- 5 Locking/unlocking the key insert for remote control B.

To release the insert from its housing, press button **5**, it comes out automatically.

Press button **5** and guide the insert back into its housing.



## KEY, RADIO FREQUENCY REMOTE CONTROL: general information (2/2)

### Radio frequency remote control operating range

This varies according to the surroundings: take care not to lock or unlock the doors by inadvertently pressing the buttons on the remote control.

### Interference

Interference by factors in the immediate vicinity (external installations or the use of equipment operating on the same frequency as the remote control) may affect the operation of the remote control.

**Note:** if a door is not opened within approximately 2 seconds of the door being unlocked by remote control, the doors will lock again automatically.

### For replacement, or if you require an additional remote control.

You must only contact an approved Dealer.

- To replace a remote control, the vehicle must be taken to an approved Dealer as both the vehicle and the remote control are needed to initialise the system.
- Depending on the vehicle, you have the option of using up to four remote controls.

### Remote control unit failure

Make sure that the correct battery type is being used, and that the battery is in good condition and inserted correctly. These batteries have a service life of approximately two years.

To learn how to change the battery, please refer to the information on the "Key, radio frequency remote control: Batteries" in Section 5.



### Driver's responsibility when parking or stopping the vehicle

Never leave an animal, child or adult who is not self-sufficient alone in your vehicle, even for a short time.

They may pose a risk to themselves or to others by starting the engine, activating equipment such as the electric windows or locking the doors, for example.

Also, in hot and/or sunny weather, please remember that the temperature inside the passenger compartment increases very quickly.

**RISK OF DEATH OR SERIOUS INJURY.**

## RADIO FREQUENCY REMOTE CONTROL, KEY: use (1/2)

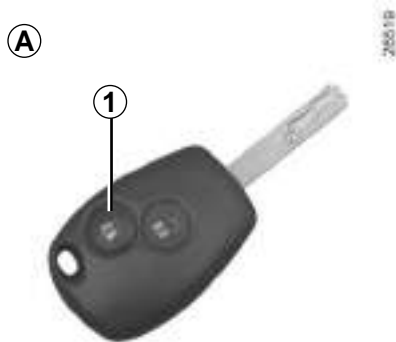

The doors are locked and unlocked using the remote control unit.

It is powered by a battery which must be replaced (refer to the information on the "Key, radio frequency remote control: batteries" in Section 5).

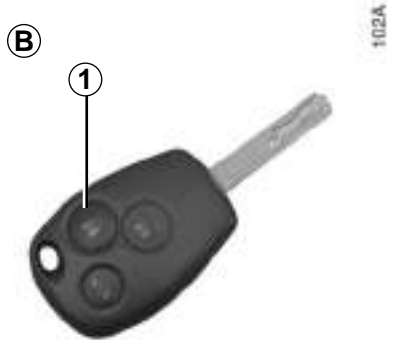

### Locking the doors

#### Remote control *A, B* or *C*

Press locking button **1**.

The hazard warning lights and side indicator lights **flash twice** to indicate that the doors have locked.

If a door or the tailgate is open or not properly shut, the doors and tailgate lock then quickly unlock and the hazard warning lights and side indicator lights do not flash.

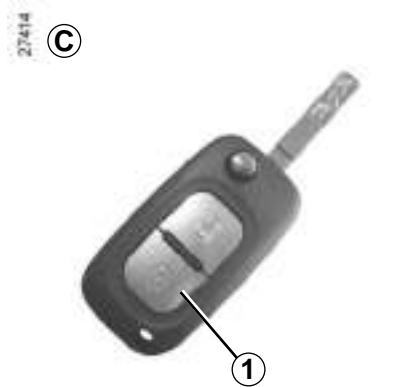

The key must not be used for any function other than those described in the handbook (removing the cap from a bottle, etc.).

## RADIO FREQUENCY REMOTE CONTROL, KEY: use (2/2)

A



B

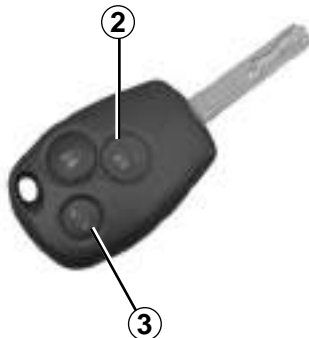

2741A

C



### Unlocking the doors

Remote control *A*, *B* or *C*

Press unlocking button **2**.

Pressing the button briefly unlocks all the doors.

A short press on button **3** locks/unlocks the tailgate and, depending on the vehicle, the sliding side doors.

The hazard warning lights and side indicator lights **flash once** to indicate that the doors have unlocked.



#### Driver's responsibility when parking or stopping the vehicle

Never leave an animal, child or adult who is not self-sufficient alone in your vehicle, even for a short time.

They may pose a risk to themselves or to others by starting the engine, activating equipment such as the electric windows or locking the doors, for example.

Also, in hot and/or sunny weather, please remember that the temperature inside the passenger compartment increases very quickly.

**RISK OF DEATH OR SERIOUS INJURY.**

# DEADLOCKING

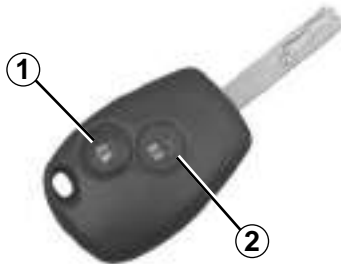

If fitted to the vehicle, this allows the doors to be locked and prevents them from being opened with the interior handles (for example, by breaking the window and then trying to open the doors from the inside).

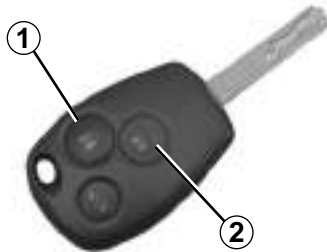

## To activate deadlocking

Press button **1** twice in quick succession.

The side indicator lights and hazard warning lights **flash five times** to indicate that the doors have locked.

## To deactivate deadlocking

Unlock the vehicle using button **2**.

The hazard warning lights and side indicator lights **flash once** to indicate that the doors have unlocked.



Never use deadlocking if someone is still inside the vehicle.

## DOORS (1/5)



### Opening from the outside

Unlock the door and pull handle **1**. For information on unlocking the doors, refer to the information on the “Key, radio frequency remote control: use” in Section 1.

### Opening from the inside

Pull handle **2**.



### Lights-on reminder buzzer

If the lights have been left on when the engine is switched off, an audible warning will sound when the door is opened (to prevent the battery discharging).

 This warning indicates that a door is open or not properly closed.



As a safety precaution, the doors should only be opened or closed when the vehicle is stationary.

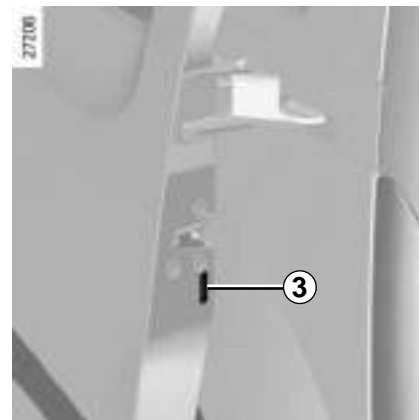

### Child safety

At the rear, to prevent the side door from being opened from the inside, move lever **3** using the end of the vehicle key.

From the inside, check that the door is correctly locked.

## DOORS (2/5)



### Sliding side door

#### Opening from the outside

Unlock the door and pull handle **4** then slide the door towards the rear of the vehicle until it locks in position. For information on unlocking the doors, refer to the information on the “Key, radio frequency remote control: use” in Section 1.

#### Opening from the inside

Pull handle **6** and use handle **5** to slide the door towards the rear of the vehicle until it locks in position.

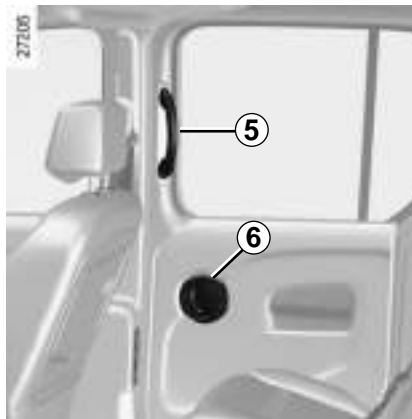

### Closing from the inside

Pull handle **5** towards the front of the vehicle until the door is completely closed.

As a safety measure, the sliding side door located on the fuel filler flap side locks when the flap is opened. For more information, refer to the information on the “Central door locking/unlocking” in Section 1.



### Recommendations concerning the sliding side door

The following precautions must be taken when opening and closing the doors or any other opening element:

- Check that the door will not come into contact with any person, animal or object.
- Only use the handles on the inside and outside of the door to operate it.
- Take care when opening and closing the door.
- Take particular care when the vehicle is parked on a slope: open the door with care until it is fully open and latches into its locking position.
- Before moving off, always ensure that the sliding door is properly closed.
- Do not use the lower support as a step.

## DOORS (3/5)



### Rear hinged doors

#### Opening from the outside

Unlock the door and pull handle **7**. For information on unlocking the doors, refer to the information on the "Key, radio frequency remote control: use" in Section 1.



Do not leave the hinged rear doors open in case of strong winds. Risk of injury.

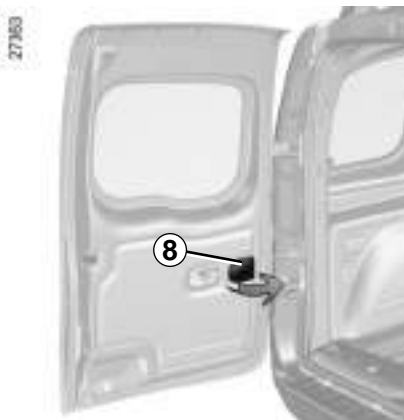

#### Opening the doors to the maximum position

For each door, pull handle **8** to release the door check strap. Open the door as far as possible.

#### Closing manually from the outside

First close the small door and then close the large door.

Position each door so that it is almost closed and then slam shut.



If the vehicle is parked on the hard shoulder with tail-gate open, the rear lights may be obscured. You should make other road-users aware of your vehicle by using a warning triangle or other equipment specified by the road traffic regulations of the country concerned.

## DOORS (4/5)

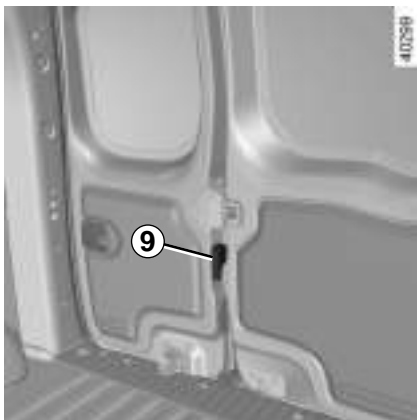

### Rear hinged doors (continued)

#### Opening from the inside

Move the lever **9** to open the small door.

#### Closing from the inside

First close the small door and then close the large door.

Position each door so that it is almost closed and then slam shut.



#### Driver's responsibility when parking or stopping the vehicle

Never leave an animal, child or adult who is not self-sufficient alone on your vehicle, even for a short time.

They may pose a risk to themselves or to others by starting the engine, activating equipment such as the electric windows or by locking the doors.

Also, in hot and/or sunny weather, please remember that the temperature inside the passenger compartment increases very quickly.

**RISK OF DEATH OR SERIOUS INJURY.**



## DOORS (5/5)



### Tailgate

#### Opening

Unlock the door, press button **11** and lift the tailgate. For information on unlocking the doors, refer to the information on the “Key, radio frequency remote control: use” in Section 1.



For your safety, check that all the vehicle's doors are properly closed before starting the engine.

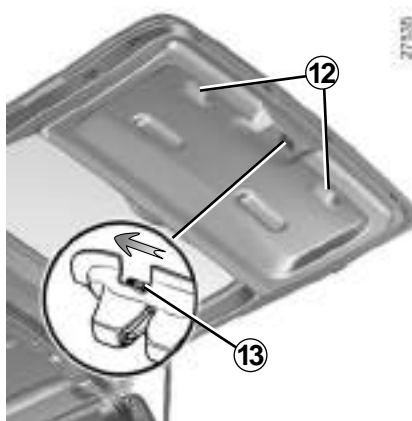

#### Closing

Lower the tailgate using interior handles **12**.

When the tailgate reaches shoulder height, gently push it shut.

#### Opening manually from the inside

If it is not possible to unlock the tailgate, it can be unlocked manually from the inside.

Insert a pencil or similar object into cavity **13**, slide the assembly as shown in the diagram and push the tailgate to open it.

## CENTRAL DOOR LOCKING/UNLOCKING (1/2)

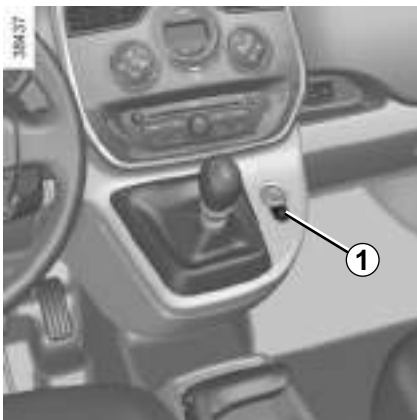

### Control for locking and unlocking from the inside

This enables all the doors to be locked simultaneously.

Lock or unlock the doors by pressing switch **1**.

If a door or the tailgate is open or not closed properly, the doors and tailgate lock/unlock quickly.



Never leave your vehicle with the key inside the vehicle.

### Locking the opening elements without the remote control

With the engine and ignition off, the sliding side doors closed and a front door open, press switch **1** for more than five seconds.

Make sure you have your key with you before you leave your vehicle.

When the door is closed, all the doors and tailgate will be locked.

Unlocking from outside the vehicle will only be possible with the key for the driver's door.

### Doors and tailgate status indicator light

**When the ignition is on**, the indicator light integrated in switch **1** informs you of the status of the doors and tailgate:

- indicator light on, the doors and tailgate are locked;
- indicator light off, at least one door is unlocked.

When you lock the doors, the indicator light remains lit and then goes out.



### Driver's responsibility

If you decide to keep the doors locked when you are driving, remember that it may be more difficult for those assisting you to gain access to the passenger compartment in the event of an emergency.

## CENTRAL DOOR LOCKING/UNLOCKING (2/2)



### Manual control

#### Using the key

Lock or unlock the driver's door by inserting the key fully into lock **2**, and turning the key.

For more information on the remote controls, refer to the information on the "Key, radio frequency remote control: use" in Section 1.

#### Locking the doors manually

Turn screw **3** with the door open (using the end of the key) and close the door. This means that the doors are then locked from the outside.



The doors may then only be opened from inside the vehicle or with the key for the front doors.

### Sliding side door (fuel filler cap side)

To prevent the door striking the fuel filler nozzle, a mechanical system locks it when the fuel filler flap is open.

When the fuel tank has been filled, replace the cap in its housing and close the flap. The door can now be used.

# AUTOMATIC LOCKING WHEN DRIVING (RAID)

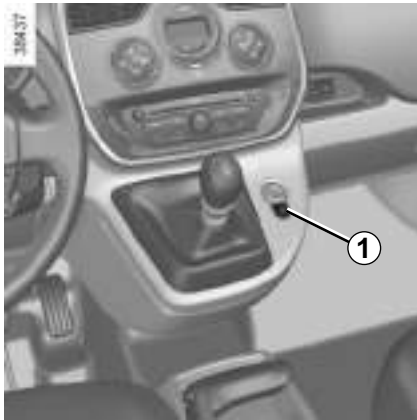

**You must first decide if you want to activate this function.**

## To activate

**With the engine running**, press and hold button **1** for about 5 seconds, until you hear two beeps. The indicator light built into the control comes on when the doors are locked.

## To deactivate

**With the engine running**, press and hold button **1** from approximately 5 seconds, until you hear a beep.

## Operating principle

When the engine is started, the system automatically locks the doors when the vehicle reaches a speed of approximately 4 mph (7 km/h).

## Operating faults

If you notice an operating fault (automatic locking impossible), first check that all doors are correctly locked. If they are correctly locked and the fault is still present, contact an approved Dealer.

Also make sure that locking has not been inadvertently deactivated.

If necessary, refer to the activation procedure.



### Driver's responsibility

If you decide to keep the doors locked when you are driving, remember that it may be more difficult for those assisting you to gain access to the passenger compartment in the event of an emergency.

## FRONT HEADRESTS (1/3)

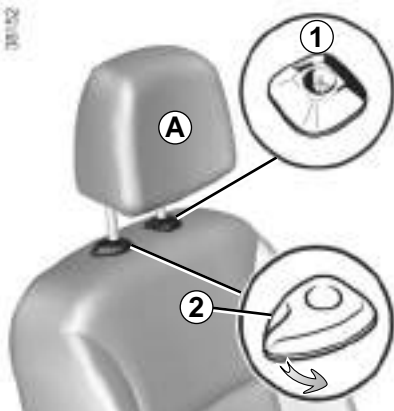

### Headrest A

#### To raise the headrest

Pull it upwards to the required height.

#### To lower the headrest

Pull the tab **2** forwards, gently lift the headrest to unlock it and guide it down to the required height.

#### To remove the headrest

Raise it to its highest position. Press button **1** and lift the headrest to release it.

#### To refit the headrest

First, check that the headrest rods are clean and correctly aligned.

Pull the tab **2** forwards.

Insert the headrest rods in the holes, with the notches facing forwards (tilt the seat backwards if necessary).

Guide the headrest down to the desired height.



The headrest is an important safety component: ensure that it is in place and in the correct position.

The distance between your head and the headrest should be as small as possible. The top of your head should be in line with the top of the headrest.

## FRONT HEADRESTS (2/3)

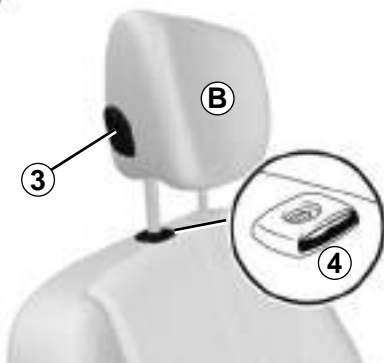

### Headrest **B**

#### To raise the headrest

Pull it upwards to the required height.

#### To lower the headrest

Press button **3** and guide the headrest down to the desired height.

#### To remove the headrest

Raise it to its highest position. Press button **4** and lift the headrest to release it.

**Note:** when the headrest is removed, take care not to change the positions of the rods.

#### To refit the headrest

If the setting of the rods has been altered, pull them fully upwards. Take care to ensure they are clean and correctly aligned and, if there are any problems, check that the notches are facing forwards.

Insert the headrest rods into the holes (tilt the seatback backwards if necessary).

Lower the headrest until it locks, press button **3** and lower the headrest as far as possible.



The headrest is an important safety component: ensure that it is in place and in the correct position.

The distance between your head and the headrest should be as small as possible. The top of your head should be in line with the top of the headrest.

## FRONT HEADRESTS (3/3)



### Headrest C

#### To raise the headrest

Pull it upwards to the required height.

#### To lower the headrest

Press tab **5** and guide the headrest down to the desired height.

#### To remove the headrest

Raise it to its highest position. Press tabs **5** and **6** then lift the headrest to release it.

**Note:** when the headrest is removed, take care not to change the positions of the rods.

#### To refit the headrest

Press tab **5**.

Insert the headrest rods in the holes with the notches facing forward, and guide the headrest down to the required height.



The headrest is an important safety component: ensure that it is in place and in the correct position.

The distance between your head and the headrest should be as small as possible. The top of your head should be in line with the top of the headrest.

## REAR HEADRESTS

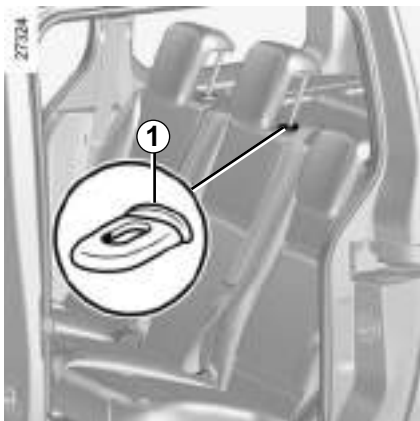

### To raise it

Slide it to the required height.

### To lower it

Pull it towards you and slide it to the required height.

### To remove it

Raise the headrest then press tabs **1** to release it.

### To refit it

Press tab **1** and insert the rods into the holes, with the notches facing forwards.

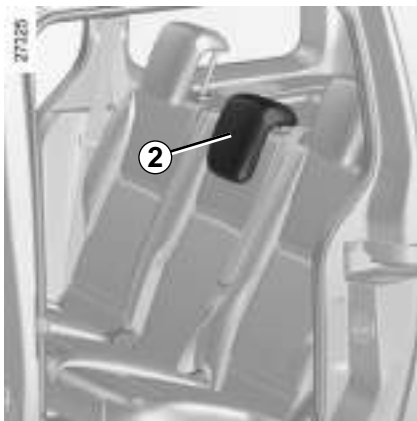

### Storage position 2

Pull it towards you and lower it completely.

**When the headrest is fully lowered, it is in the storage position:** do not use this position when someone is sitting in the rear seats.



The headrest is a safety component; check that it is fitted and in the correct position.



### Child's convertible headrest

If fitted to the vehicle, the child headrest and booster cushion can only be installed on the rear side seats.

For fitting and use, refer to the equipment instructions.



## FRONT SEATS (1/3)



### To move forwards or backwards

Depending on the seat, lift bar **1** or handle **4** to release it. Release the handle at the desired position and make sure that it is locked.

### Adjusting the height of the driver's seat

Move lever **3** as many times as necessary:

- upwards to raise the seat,
- downwards to lower the seat.



### To tilt the seatback

Depending on the seat, lower or lift lever **2** and tilt the seatback until it reaches the required position.

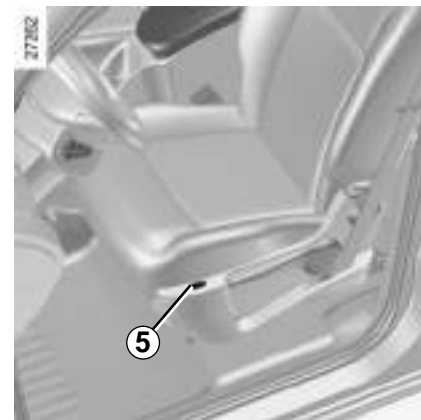

### Heated seats

With the engine running, activate switch **5**; a warning light comes on.



For safety reasons, carry out any adjustments when the vehicle is not being driven.

We would advise you not to recline the seatbacks too far to ensure that the effectiveness of the seat belts is not reduced.

Make sure that the seatbacks are correctly locked in place.

Nothing should be placed on the floor (area in front of driver) as such objects may slide under the pedal during braking manoeuvres, thus obstructing its use.

## FRONT SEATS (2/3)



### Flat position

Depending on the vehicle, the seatback on the passenger side may be folded down onto the seat base to create a flat position.

- Hold handle **4** and move the seat as far back as possible;
- lower the headrest fully;
- hold the top of the seatback to lower it;
- pull lever **2** and pull the seatback down and forwards (the seat base will be positioned on the floor);



For safety reasons, carry out any adjustments when the vehicle is not being driven.

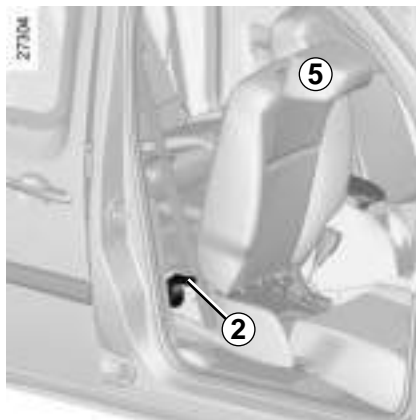

- make sure that there is nothing which will prevent the seat from moving;
  - tilt headrest **5** so as to position it under the dashboard.
- The seat locks automatically; make sure it is correctly locked.

Maximum weight on the seat in the flat position: 80 kg, with the weight evenly distributed.



Be sure to hold the seatback when placing it in the flat position. Risk of injury.



### Repositioning the seat

Make sure that nothing prevents the seat from moving.

- Pull lever **2** and lift the seatback, ensuring it is correctly locked;
- reposition the seat base, placing your hand on the front of the seat base.

When the rear bench seat is folded down, move the front seats carefully.



Put your hand on the front of the seat base when repositioning it. Risk of trapping.

## FRONT SEATS (3/3)

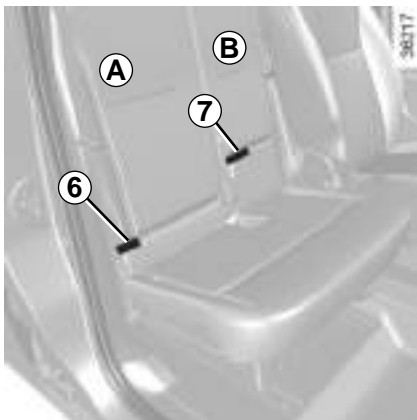

### Version with front bench seat for two

The seatbacks can be folded down (in one or two sections).

#### To fold down the seatbacks

Pull on handles **6** and **7** to release the seatbacks and lower seatbacks **A** and **B**.

### To refit the seatbacks

Refit the seatbacks and click them back into place.



For safety reasons, carry out any adjustments when the vehicle is not being driven.



To avoid all risk of injury, ensure that nobody is in the proximity of the moving parts. When moving the seat, make sure that nothing interferes with the moving parts and their locking.



### Front seats

#### Operating faults (depending on vehicle)

If the sliding side door does not work, lower handle **8**, hold it while the seatback tilts and slide the seat forwards.

To place the seat into the comfort position, slide it rearwards. Adjust the seat and make sure that it is correctly locked.

## ROOF FLAP (1/2)

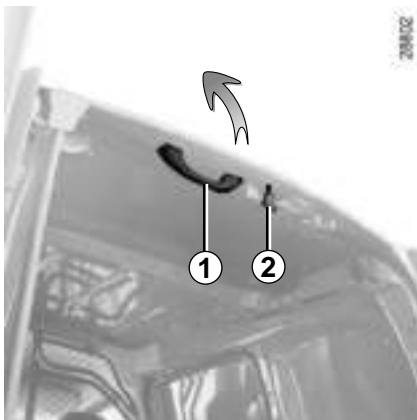

### To open:

- Unlock the control **2**, the roof flap lifts automatically (make sure that nothing prevents the flap from opening. In this case, use the handle **1** to help raise it);
- when the roof flap is open, it must be locked by pushing it towards the front of the vehicle until the control **2** locks.

**Important:** It is prohibited to drive with the roof flap open and unlocked.



### Transverse bar

When loading bulky objects, the transverse bar may be moved:

- Press the handle **3**;
- lift the bar all the way to the door pillar;
- lock the bar after loading.

**Note:** When driving with the roof flap open, you may hear wind noise. To reduce these, open one of the side windows slightly.



Driving with the roof flap open may be unpleasant for passengers because exhaust gas may enter the passenger compartment. This use is solely **for short distances**, or for **transporting bulky objects** without having to open the rear doors. In this case, close the other windows and operate the **ventilation system at the half or fully open setting**, as this will help to prevent exhaust fumes from entering the passenger compartment.

## ROOF FLAP (2/2)

28805

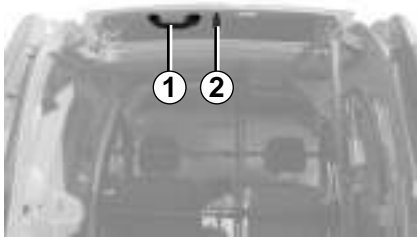

### To close:

- Unlock the control **2**, the roof flap automatically opens halfway;
- pull the handle **1** and lock the roof flap in the closed position.

Before starting, always reposition the transverse bar and ensure it is correctly locked.

The rear hinged doors can only be closed with the bar locked.

Remember that the overall vehicle dimensions may change when you are transporting bulky objects.

## SWIVELLING PARTITION

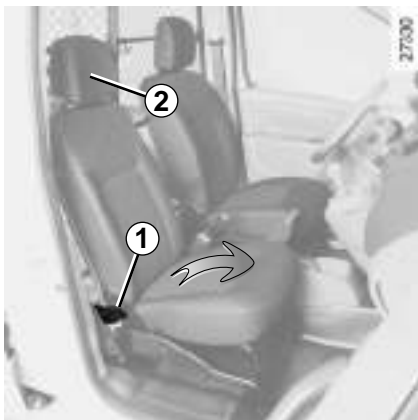

### To rotate the partition

- Unlock the seat base by moving handle **1** downwards;
- lift the front passenger seat base vertically (arrow);
- lower headrest **2** to its lowest setting;
- unlock the seatback by moving handle **1** downwards again and position the seatback horizontally. To make the manoeuvre easier, rotate the headrest **2**;

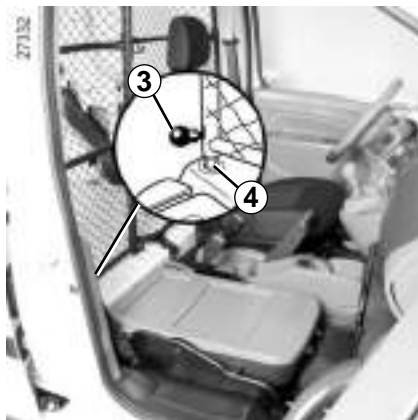

- unlock the swivelling section by lifting catch **3**;
- reposition the seat base, proceeding in reverse order.

When moving the swivelling partition, ensure the seat belt is not damaged. Hold it aside when you rotate the partition.



- Pivot the moving section 90 degrees, lock it at point **5** and lower catch **3**.

**Note:** before refitting the swivelling section in its original position, check that locking point **4** is clean.

Maximum weight on the seat in table position is 80 kg. The weight must be evenly distributed.



The swivelling section must always be locked when the vehicle is driven. Risk of injury.

## SEAT BELTS (1/4)

Always wear your seat belt when travelling in your vehicle. You must also comply with the legislation of the particular country you are in.

Make sure that the rear bench seat is locked in position correctly so that the rear seat belts will operate efficiently. Refer to the information on the "Rear bench seat: functions" in Section 3.



Seat belts which are incorrectly adjusted or twisted may cause injuries in the event of an accident.

Use one seat belt per person, whether child or adult.

Even pregnant women should wear a seat belt. In this case, ensure that the lap belt is not exerting too much pressure on the abdomen, but do not allow any slack.

**Before starting, first adjust your driving position, then ask all occupants to adjust their seat belts to ensure optimum protection.**

### Adjusting your driving position

- **Sit well back in your seat** (having removed your coat or jacket etc.). This is essential to ensure your back is positioned correctly;
- **adjust the distance between the seat and the pedals.** Your seat should be as far back as possible while still allowing you to fully depress the clutch pedal. The seatback should be adjusted so that your arms are slightly bent when you hold the steering wheel;
- **adjust the position of your headrest.** For maximum safety, your head must be as close as possible to the headrest;
- **adjust the height of the seat.** This adjustment allows you to select the seat position which offers you the best possible view.
- **adjust the position of the steering wheel.**



### Adjusting the seat belts

Sit with your back firmly against the seatback.

Shoulder strap **1** should be as close as possible to the base of the neck but not on it.

Lap belt **2** should be worn flat over the thighs and against the pelvis.

The seat belt must be worn as close to the body as possible. E.g.: avoid wearing heavy clothing or keeping bulky objects under the belts, etc.

## SEAT BELTS (2/4)



### Locking

Unwind the belt **slowly and smoothly** and ensure that buckle **3** locks into catch **5** (check that it is locked by pulling on buckle **3**).

If the belt jams, allow it to return slightly before attempting to unwind it again.

If your seat belt is completely jammed, pull slowly, but firmly so that just over 3 cm unwinds. Allow it to return slightly before attempting to unwind it again.

If there is still a problem, contact an approved dealer.



### Front seat belt reminder warning light

It remains on when the engine is started if your seat belt is not fastened. An audible warning sounds at a low volume for 30 seconds, then at a high volume for 90 seconds.

### Unfastening

Press button **4** and the seat belt will be rewound by the inertia reel. Guide the belt.

**Note:** an object placed on the passenger seat base may activate the warning light in some cases.

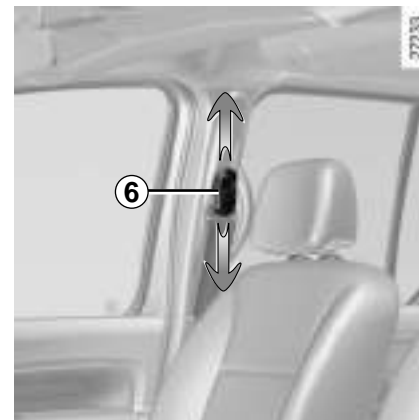

### Adjusting the front seat belt height

Press button **6** to adjust the seat belt height so that shoulder strap **1** is worn as shown previously:

- to lower the seat belt, press button **6** and lower the seat belt at the same time;
- to raise the seat belt, press button **6** fully and lift the seat belt to the required position.

Make sure that the seat belt is locked in position correctly after you have adjusted it.



## SEAT BELTS (3/4)



### Version with front bench seat for two

In normal use conditions, fasten the centre seat belt when no one is seated there.

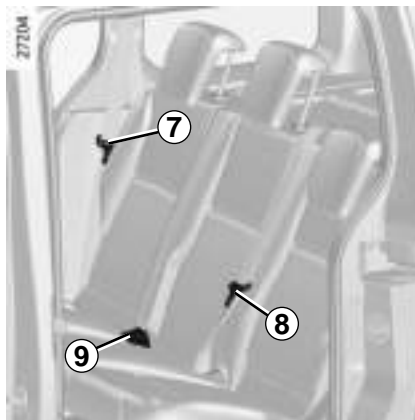

### Rear centre belt

Unwind the belt slowly and ensure that the buckle **8** locks into catch **9**.

### Rear side seat belts 7

The belts are locked, unlocked and adjusted in the same way as the front belts.

Make sure that the rear bench seat is locked in position correctly so that the rear seat belts will operate efficiently. Refer to the information on the "Rear bench seat: functions" in Section 3.

## SEAT BELTS (4/4)



- No modification may be made to the component parts of the originally fitted restraint system: seat belts, seats and their mountings. For special operations (e.g. fitting child seats), contact an authorised dealer.
- Do not use devices which allow any slack in the belts (e.g. clothes pegs, clips, etc.): a seat belt which is worn too loosely may cause injury in the event of an accident.
- Never wear the shoulder strap under your arm or behind your back.
- Never use the same belt for more than one person and never hold a baby or child on your lap with your seat belt around them.
- The belt should never be twisted.
- Following an accident, have the seat belts checked and replaced if necessary. Always replace your seat belts as soon as they show any signs of wear.
- Make sure that the buckle is inserted into the appropriate catch.
- When the rear seats are being put back, make sure that the seat belts and buckles are correctly positioned so that they can be used properly.
- Ensure that no objects are placed in the area around the seat belt catch as they could prevent it from being properly secured.
- Make sure the seat belt catch is properly positioned (it should not be hidden away, crushed or flattened by people or objects).

## METHODS OF RESTRAINT IN ADDITION TO THE FRONT SEAT BELTS (1/3)

Depending on the vehicle, they are composed of:

- **seat belt pretensioners;**
- **air bags 1 for driver and front passenger.**

These systems are designed to act independently or together when the vehicle is subjected to a frontal impact.

Depending on the severity of the impact, the system can trigger:

- seat belt **2** locking;
- the seat belt pretensioner (which engages to correct seat belt slack);
- the front air bag.



### Pretensioners

The pretensioners hold the seat belt against the body, holding the occupant more securely against the seat, thus increasing the seat belt's efficiency.

With the ignition on, following a significant frontal impact and depending on the severity of the impact, the system may trigger the seat belt pretensioner which instantly retracts the seat belt.



– Have the entire restraint system checked following an accident.

– No operation whatsoever is permitted on any part of the system (pretensioners, air bags, computers, wiring) and the system components must not be reused on any other vehicle, even if identical.

– To avoid incorrect triggering of the system which may cause injury, only qualified personnel from an approved dealer may work on the pretensioner and air bag system.

– The electric trigger system may only be tested by a specially trained technician using special equipment.

– When the vehicle is scrapped, contact an approved dealer for disposal of the pretensioner and air bag gas generators.

## METHODS OF RESTRAINT IN ADDITION TO THE FRONT SEAT BELTS (2/3)

### Air bags for driver and front passenger

It is fitted to the front seats on the driver's side and, depending on the vehicle, on the passenger's side as well.

Depending on the vehicle, the presence of this equipment is indicated by the word "air bag" on the steering wheel and dashboard (air bag zone **A**) and a symbol on the lower section of the windscreen.

Each air bag system consists of:

- an air bag and gas generator fitted on the steering wheel for the driver and in the dashboard for the front passenger;
- an electronic unit for system monitoring which controls the gas generator electrical trigger system;
- a single indicator light  on the instrument panel;
- remote sensors.

### Operation

This system is only operational when the ignition is switched on.

In a severe **frontal** impact, the air bags inflate rapidly, cushioning the impact of the driver's head and chest against the steering wheel and of the front passenger against the dashboard. The air bags then deflate immediately so that the passengers are not in any way hindered from leaving the vehicle.

### Load limiter

Above a certain severity of impact, this mechanism is used to limit the force of the belt against the body so that it is at an acceptable level.



#### Vehicle fitted with three front seats

The passenger airbag only protects the front side passenger; the front centre passenger is only protected by the seat belt. Please follow the usual safety instructions (wearing the seat belt).

Risk of injury in the event of an accident.



The air bag system uses pyrotechnic principles. This explains why, when the air bag inflates, it will generate heat, produce smoke (this does not mean that a fire is about to start) and make a noise upon detonation. In a situation where an air bag is required, it will inflate immediately and this may cause some minor, superficial grazing to the skin or other problems.

## METHODS OF RESTRAINT IN ADDITION TO THE FRONT SEAT BELTS (3/3)

All of the warnings below are given so that the air bag is not obstructed in any way when it is inflated and also to prevent the risk of serious injuries caused by items which may be dislodged when the air bag inflates.



### Warnings concerning the driver's air bag

- Do not modify the steering wheel or the steering wheel boss.
- Do not cover the steering wheel boss under any circumstances.
- Do not attach any objects (badge, logo, clock, telephone cradle, etc.) to the steering wheel boss.
- The steering wheel must not be removed (except by qualified personnel from our Network).
- Do not sit too close to the steering wheel when driving: sit with your arms slightly bent (see Section 1 “Adjusting your driving position”). This will allow sufficient space for the air bag to deploy correctly and be fully effective.

### Warnings concerning the passenger air bag

- Do not attach or glue any objects (badge, logo, clock, telephone cradle, etc.) to the dashboard in the air bag zone.
- Do not place anything between the dashboard and the passenger (animal, umbrella, walking stick, parcels, etc.).
- The passenger must not put his or her feet on the dashboard or seat as there is a risk that serious injuries may occur. As a general rule, keep all body parts (knees, hands, head, etc.) away from the dashboard.
- The devices in addition to the front passenger seat belt should be reactivated as soon as a child seat is removed, to ensure the protection of the passenger in the event of an impact.

**A REAR-FACING CHILD SEAT MUST NOT BE FITTED TO THE FRONT PASSENGER SEAT UNLESS THE ADDITIONAL RESTRAINT SYSTEMS, I.E. THE PASSENGER AIR BAG, ARE DEACTIVATED.**

(Refer to the information on “Child safety: deactivating/activating the front passenger air bag” in Section 1).

## SIDE PROTECTION DEVICES

### Side air bags

(depending on vehicle)

This air bag may be fitted to each of the front seats and is activated at the sides of the seats (door side) to protect the occupants in the event of a severe side impact.

### Curtain air bags

(depending on vehicle)

These air bags may be fitted along the top of each side of the vehicle and are triggered along the front and rear side windows to protect the passengers in the event of a severe side impact.

Depending on the vehicle, a marking on the windscreen informs you of the presence of additional means of restraint (airbags, pretensioners, etc.) in the passenger compartment.



#### Warnings concerning the side air bag

- **Fitting seat covers:** seats equipped with an airbag require covers specifically designed for your vehicle. Contact an authorised dealer to find out if these covers are available. The use of any covers other than those designed for your vehicle (including those designed for another vehicle) may affect the operation of the airbags and reduce your protection.
- Do not place any accessories, objects or even pets between the seatback, the door and the internal fittings. Do not cover the seatback with any items such as clothes or accessories. This may prevent the air bag from operating correctly or cause injury when the air bag is deployed.
- No work or modification whatsoever may be carried out on the seat or internal fittings, except by qualified personnel from an approved Dealer.
- These airbags operate through slits in the front seatbacks (door side): Never place any objects here.

## ADDITIONAL METHODS OF RESTRAINT

All of the warnings below are given so that the air bag is not obstructed in any way when it is inflated and also to prevent the risk of serious injuries caused by items which may be dislodged when the air bag inflates.



The air bag is designed to complement the action of the seat belt. Both the air bags and seat belts are integral parts of the same protection system. It is therefore essential to wear seat belts at all times. If seat belts are not worn, the occupants are exposed to the risk of serious injury in the event of an accident. It may also increase the risk of minor superficial injuries occurring when the air bag is deployed, although such minor injuries are always possible with air bags.

If the vehicle should overturn or suffer a rear impact, however severe, the pretensioners and air bags are not always triggered. Impacts to the underside of the vehicle, eg. from pavements, potholes or stones, can all trigger these systems.

- No work or modification **whatsoever** may be carried out on any part of the air bag system (air bags, pretensioners, computer, wiring harness, etc.), except by qualified personnel from an approved Dealer.
- To ensure that the system is in good working order and to avoid accidental triggering of the system which may cause injury, only qualified Network personnel may work on the air bag system.
- As a safety precaution, have the air bag system checked if your vehicle has been involved in an accident, or is stolen or broken into.
- When selling or lending the vehicle, inform the user of these points and hand over this handbook with the vehicle.
- When scrapping your vehicle, contact your approved Dealer for disposal of the gas generator(s).



### Operating faults

Warning light **1** will light up on the instrument panel when the ignition is turned on and then go out after a few seconds.

If it does not come on when the ignition is switched on, or if it comes on when the engine is running, there is a fault with the system (air bags, pretensioners, etc.) in the front and/or rear seats.

Contact your approved dealer as soon as possible. Your protection will be reduced until this fault is rectified.

## CHILD SAFETY: General information (1/2)

### Carrying children

Children, and adults, must be correctly seated and strapped in for all journeys. The children being carried in your vehicle are your responsibility.

A child is not a miniature adult. Children are at risk of specific injuries as their muscles and bones have not yet finished growing. The seat belt alone would not provide suitable protection. Use an approved child seat and ensure you use it correctly.



To prevent the doors being opened, use the "Child safety" device (refer to the information on "Opening and closing the doors" in Section 1).



A collision at 30 mph (50 km/h) is the same as falling a distance of 10 metres.

Transporting a child without a restraint is the equivalent of allowing him or her to play on a fourth-floor balcony without railings.

Never travel with a child held in your arms. In the event of an accident, you will not be able to keep hold of the child, even if you yourself are wearing a seat belt.

If your vehicle has been involved in a road accident, replace the child seat and have the seat belts and ISOFIX anchorage points checked.



### **Driver's responsibility when parking or stopping the vehicle**

Never leave an animal, child or adult who is not self-sufficient alone on your vehicle, even for a short time.

They may pose a risk to themselves or to others by starting the engine, activating equipment such as the electric windows or by locking the doors.

Also, in hot and/or sunny weather, please remember that the temperature inside the passenger compartment increases very quickly.

**RISK OF DEATH OR SERIOUS INJURY.**



## CHILD SAFETY: General information (2/2)

### Using a child seat

The level of protection offered by the child seat depends on its ability to restrain your child and on its installation. Incorrect installation compromises the protection it offers the child in the event of harsh braking or an impact.

Before purchasing a child seat, check that it complies with the regulations for the country you are in and that it can be fitted in your vehicle. Consult an approved dealer to find out which seats are recommended for your vehicle.

Before fitting a child seat, read the manual and respect its instructions. If you experience any difficulties during installation, contact the manufacturer of the equipment. Keep the instructions with the seat.

Set a good example by always fastening your seat belt and teaching your child:

- to strap themselves in correctly.
- to always get in and out of the car at the kerb, away from busy traffic.

Do not use a second-hand child seat or one without an instruction manual.

Check that there are no objects in the vicinity of the child seat which could impede its operation.



Never leave a child unattended in the vehicle.

Check that your child is always strapped in and that the belt or safety harness used is correctly set and adjusted. Avoid wearing bulky clothing which could cause the belts to slacken.

Never let your child put their head or arms out of the window.

Check that the child is in the correct position for the entire journey, especially if asleep.

## CHILD SAFETY: choosing a child seat



### Rear-facing child seats

A baby's head is, proportionally, heavier than that of an adult and its neck is very fragile. Transport the child in this position for as long as possible (until the age of 2 at the very least). It supports both the head and the neck.

Choose a bucket type seat for best side protection and change it as soon as the child's head is higher than the shell.



### Forward-facing child seats

The child's head and abdomen need to be protected as a priority. A forward-facing child seat which is firmly attached to the vehicle will reduce the risk of impact to the head. Ensure your child travels in a forward-facing seat with a harness for as long as their size permits.

Choose a bucket type seat for optimum side protection.



### Booster cushions

From 15 kg or 4 years, the child can travel using a booster seat, which will enable the seat belt to be adapted to suit his/her size and shape. The booster seat cushion must be fitted with guides to position the seat belt on the child's thighs rather than the stomach. It is recommended that you use a seat-back fitted with a belt strap guide which can be adjusted in terms of height to position the seat belt in the centre of the shoulder. It must never rest on the neck or on the arm.

Choose a bucket type seat for optimum side protection.

## CHILD SAFETY: choosing a child/baby seat mounting (1/2)

There are two ways of attaching child seats: via the seat belt or using the ISOFIX system.

### Attachment via the seat belt

The seat belt must be adjusted to ensure that it is effective in the event of harsh braking or an impact.

Ensure that the strap paths indicated by the child seat manufacturer are respected.

Always check that the seat belt is correctly fastened by pulling it up, then pulling it out fully whilst pressing on the child seat.

Check that the seat is correctly held by moving it from side to side and back to front: the seat should remain firmly fixed.

Check that the child seat has not been installed at an angle and that it is not resting against a window.



Do not use the child seat if it may unfasten the seat belt restraining it: the base of the seat must not rest on the buckle and/or catch of the seat belt.



The seat belt must never be twisted or the tension relieved. Never pass the shoulder strap under the arm or behind the back. Check that the seat belt has not been damaged by sharp edges. If the seat belt does not operate normally, it will not protect the child. Consult an approved Dealer. Do not use this seat until the seat belt has been repaired.



No modifications may be made to the component parts of the restraint system (belts, ISOFIX and seats and their mountings) originally fitted.

### Attachment with the ISOFIX system

Authorised ISOFIX child seats are approved in accordance with regulation ECE-R44 in one of the three following scenarios:

- ISOFIX universal 3 point forward-facing seat;
- ISOFIX semi-universal 2 point seat;
- specific.

For the latter two, check that your child seat can be installed by consulting the list of compatible vehicles.

Attach the child seat with the ISOFIX locks, if these are provided. The ISOFIX system allows quick, easy, safe fitting.

The ISOFIX system consists of 2 rings and, in some cases, a third ring.



Before using an ISOFIX child seat that you purchased for another vehicle, check that its installation is authorised. Consult the list of vehicles which can be fitted with the seat with the equipment manufacturer.

## CHILD SAFETY: choosing a child/baby seat mounting (2/2)

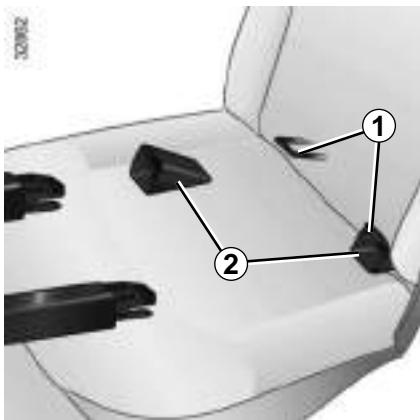

The two rings **1** are located between the seatback and the seat base, behind the zip fasteners, and are identified by a marking.

To ensure your child seat can be easily fitted and locked on rings **1**, use access guides **2** on the child seat.

The third ring is used to attach the upper strap on some child seats.

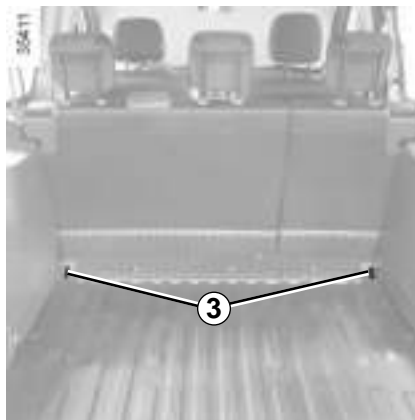

Depending on the vehicle, pass the strap between wheel arch liner **4** and the underside of upper partition **5**.

From the luggage compartment, attach the strap hook to ring **3** on the corresponding side. Check that the bench seatback is correctly locked.

Pull the belt so that the back of the child seat comes into contact with the back of the vehicle seat.

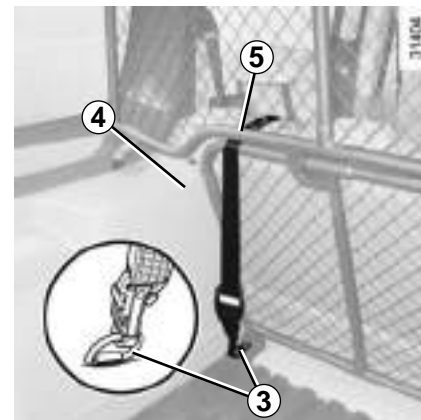

The ISOFIX anchorage points have been exclusively designed for child seats with the ISOFIX system. Never fit a different type of child seat, seat belt or other objects to these anchorage points.

Check that nothing is obstructing the anchorage points.

If your vehicle has been involved in a road accident, have the ISOFIX anchorage points checked and replace your child seat.



The anchoring points (rings) in luggage compartment **3** cannot be used if they are already being used to mount two of the following three components: luggage net, load in the luggage compartment or child seat.

## CHILD SAFETY: fitting a child seat (1/7)

Some seats are not suitable for fitting child seats. The diagrams on the following pages show you how to attach a child seat.

The types of child seats indicated may not be available. Before using a different child seat, check with the manufacturer that it can be fitted.



Fit the child seat in a rear seat wherever possible.

Check that when installing the child seat in the vehicle it is not at risk of coming loose from its base.

If you have to remove the headrest, check that it is correctly stored so that it does not come loose under harsh braking or impact.

Always attach the child seat to the vehicle even if it is not in use so that it does not come loose under harsh braking or impact.

### In the front seat

The laws concerning children travelling in the front passenger seat differ in every country. Consult the legislation in force and follow the indications on the diagrams on the following pages.

Before fitting a child seat in this seat (if authorised):

- lower the seat belt as far as possible;
- move the seat as far back as possible;
- gently tilt the seatback away from vertical (approximately 25°);
- on equipped vehicles, raise the seat base as far as possible.

Do not change these settings after the child seat is installed.



### **RISK OF DEATH OR SERIOUS INJURY:**

before installing a child seat on this seat, check that the airbag has been deactivated (refer to “Child safety: front passenger airbag deactivation, activation” in Section 1).

## CHILD SAFETY: fitting a child seat (2/7)

### In the rear seat

A carrycot can be installed across the vehicle and will take up at least two seats. Position the child with his or her feet nearest the door.

Push the vehicle seat fully forwards to install a rear-facing child seat, then push it back as far as possible without allowing it to make contact with the child seat.

For the safety of the child in the forward-facing seat, do not move the seat in front back past the middle of the runner, do not tilt the seatback too far (maximum of 25°) and raise the seat as much as possible.

Check that the forward-facing child seat is resting against the back of the vehicle seat and that the headrest of the vehicle is not obstructing its use.

### Child's convertible headrest

If fitted to the vehicle, the child headrest and booster cushion can only be installed on the rear side seats.

For fitting and use, refer to the equipment instructions.



A child seat with a floor support must never be installed on the rear centre seat.

**RISK OF DEATH OR  
SERIOUS INJURY.**

## CHILD SAFETY: fitting a child seat (3/7)

Van version with two front seats



38510

Van version Type of seat group (weight of the child)	Seats suitable for fitting a child seat Front passenger seat (1)	
	WITH PASSENGER AIR BAG (2)	WITHOUT PASSENGER AIR BAG
<b>Group 0, 0+</b> (weight below 13 kg)	U	U
<b>Group I</b> (weight from 9 kg to 18 kg)	U	U
<b>Groups II and III</b> (weight from 15 kg to 36 kg)	U	U

### Child seat attached using the belt

**U** Seat which allows a child seat with “Universal” approval to be attached by a seat belt.

**⊘** Seat not suitable for fitting child seats.

**⊘** Check the status of the air bag before fitting a child seat or allowing a passenger to use the seat.

(1) Before fitting a child seat: position the vehicle seat as far back as possible.



**(2) RISK OF DEATH OR SERIOUS INJURY:** Before installing a child seat on the front passenger seat, check that the airbag has been deactivated (refer to “Child safety: front passenger airbag deactivation and activation” in Section 1).

# CHILD SAFETY: fitting a child seat (4/7)

Van version with three front seats



## Child seat attached using the belt

**U** Seat which allows a child seat with “Universal” approval to be attached by a seat belt.

**⊘** Seat not suitable for fitting child seats.

Van version Type of seat group (weight of the child)	Seats suitable for fitting a child seat Front passenger seat (1)	
	SIDE PASSENGER	CENTRE PASSENGER
<b>Group 0, 0+</b> (weight below 13 kg)	U	X
<b>Group I</b> (weight from 9 kg to 18 kg)	U	X
<b>Groups II and III</b> (weight from 15 kg to 36 kg)	U	X



# CHILD SAFETY: fitting a child seat (5/7)

## Sport tourer versions



### Child seat attached using the belt

**U** Seat which allows a seat with "Universal" approval to be fitted using a seat belt;

**UD** Seat which **only** allows a **rear-facing seat** with "Universal" approval to be attached with a seat belt.



**RISK OF DEATH OR SERIOUS INJURY:** before installing a rear-facing child seat in the front passenger seat, make sure the air bag has been deactivated (refer to the information on "Child safety: front passenger air bag deactivation/activation" in Section 1).



Using a child safety system which is not approved for this vehicle will not correctly protect the baby or child. They risk serious or even fatal injury.

### Child seats attached using the ISOFIX mounting



Seat which allows an ISOFIX child seat to be fitted.



Check the status of the air bag before fitting a child seat or allowing a passenger to use the seat.



Seat not suitable for fitting child seats.



The rear seats are fitted with an anchorage point which allows a forward-facing ISOFIX child seat with universal approval to be fitted. The anchorage points are located in the luggage compartment and are visible.

The size of the ISOFIX child seat is indicated by a letter:

- A, B and B1: for forward-facing seats in group 1 (9 to 18 kg);
- C: rear-facing seats in group 1 (9 to 18 kg);
- D and E: shell seat or rear-facing seats in group 0 or 0+ (less than 13 kg);
- F and G: cots in group 0 (less than 10 kg).

## CHILD SAFETY: fitting a child seat (6/7)

The table below summarises the information already shown on the diagram on the previous page, to ensure the regulations in force are respected.

Sport tourer versions Type of child seat	Weight of the child	Seat size ISOFIX	Front passenger seat (1) (2)	Rear side seats	Rear centre seat
<b>Carrycot fitted across the vehicle</b> Group 0	< 10 kg	F, G	X	U - IL (3)	U (3)
<b>Shell seat/rear-facing seat</b> Group 0, 0+ and 1	< 13 kg and 9 to 18 kg	C, D, E	U	U - IL (4)	U (4)
<b>Forward-facing seat</b> Group 1	9 to 18 kg	A, B, B1	X	U - IUF - IL (5)	U (5)
<b>Booster seat</b> Group 2 and 3	15 to 25 kg and 22 to 36 kg		X	U (5)	U (5)



**(1) RISK OF DEATH OR SERIOUS INJURY:** before installing a rear-facing child seat in the front passenger seat, make sure the air bag has been deactivated (refer to the information on “Child safety: front passenger air bag deactivation/activation” in Section 1).

## **CHILD SAFETY: fitting a child seat (7/7)**

**X** = Seat not suitable for fitting child seats.

**U** = Seat which allows a child seat with "Universal" approval to be installed using a seat belt; check that it can be fitted.

**IUF/IL** = On equipped vehicles, seat which allows an approved "Universal/semi-universal" or "vehicle specific" child seat to be attached using the ISOFIX system; check that it can be fitted.

- (2) Only a rear-facing child seat can be fitted in this seat: raise the seat to the maximum and position it as far back as possible, tilting the seatback slightly (approximately 25°).
- (3) A carrycot is fitted crosswise and occupies at least two seats (the child's feet are placed nearest the door).
- (4) Move the front seat as far forward as possible to install a rear-facing child seat, then move back the seat in front as far as it will go, although without allowing it to come into contact with the child seat.
- (5) Forward-facing child seat; position the seatback of the child seat in contact with the seatback of the vehicle seat. Adjust the headrest, or remove it if necessary. In addition, do not push the seat in front of the child further than halfway along its runners, or incline the seatback more than 25°.

## CHILD SAFETY: deactivating/activating the front passenger air bag (1/3)

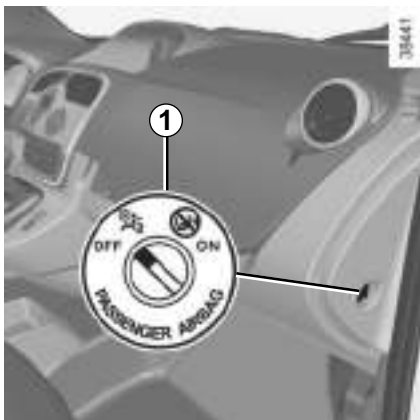

### Deactivating the front passenger air bag (on equipped vehicles)

You **must** deactivate the passenger air bag before fitting a child seat on the front passenger seat.



To deactivate the airbag: with the vehicle stopped and the ignition off, press and turn the lock 1 to the OFF position.

With the ignition on, you **must** check that warning light 2 is lit on the central display and, depending on the vehicle, that the message "passenger air bag off" is displayed.

**Note:** on equipped vehicles, the side air bag is also deactivated.

**This light remains permanently lit to let you know that you can fit a child seat.**



The passenger air bag must only be deactivated or activated **with the ignition off**.

If it is interfered with when the vehicle is being driven, indicator

lights



and



will come on.

Switch the ignition off then on again to reset the air bag in accordance with the lock.

## CHILD SAFETY: deactivating/activating the front passenger air bag (2/3)

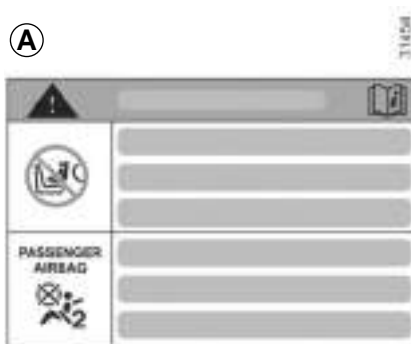
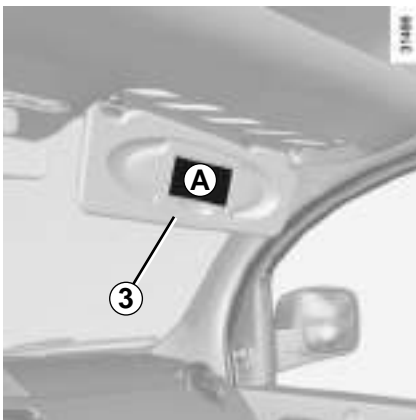

### DANGER

Since operation of the front passenger airbag is not compatible with the position of a rear-facing child seat, **NEVER** fit a restraint system for a rear-facing child in a seat protected by an **ACTIVATED front AIRBAG**. This can cause the **CHILD'S DEATH** or **SERIOUS INJURY**.

The markings on the dashboard and labels **A** on each side of the passenger sun visor **3** (for example, the labels shown above) will remind you of these instructions.

## CHILD SAFETY: deactivating/activating the front passenger air bag (3/3)



### Activation of the front passenger air bag

You should reactivate the air bag as soon as you remove the child seat from the front passenger seat to ensure the protection of the front passenger in the event of an impact.

**To reactivate the airbag: with the vehicle stopped and the ignition off**, press and turn the lock **1** to the **ON** position.

With the ignition on, you **must** ensure that warning light **2** is off.

The front passenger seat belt additional restraint systems are activated.



### Operating faults

If the front passenger airbag activation/deactivation system is faulty, child seats must not be fitted to the front seat.

Allowing any other passenger to sit in that seat is not recommended.

Contact your approved Dealer as soon as possible.



### DANGER

Since operation of the front passenger airbag is not compatible with the position of a rear-facing child seat, **NEVER** fit a restraint system for a rear-facing child in a seat protected by an **ACTIVATED front AIRBAG**. This can cause the **CHILD'S DEATH** or **SERIOUS INJURY**.



The passenger air bag must only be deactivated or activated **with the ignition off**.

If it is interfered with when the vehicle is being driven, indicator

lights



and



will come on.

Switch the ignition off then on again to reset the air bag in accordance with the lock.

## STEERING WHEEL

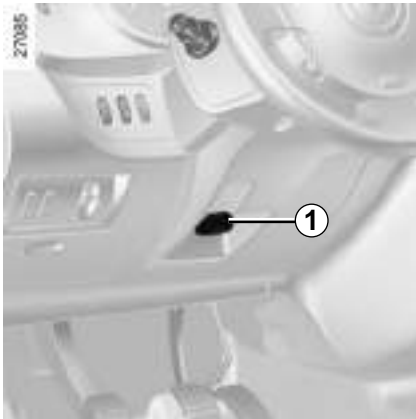

### Steering wheel height adjustment

Pull lever **1** and adjust the steering wheel to the required position; push the lever to lock the steering wheel.

Make sure that the steering wheel is correctly locked.



For safety reasons, only adjust the steering wheel when the vehicle is stationary.

Never leave the steering wheel on full lock when the vehicle is stationary.



Never switch off the ignition when travelling downhill, and avoid doing so in normal driving (assistance is not provided).

# DRIVING POSITION: LEFT-HAND DRIVE (1/2)

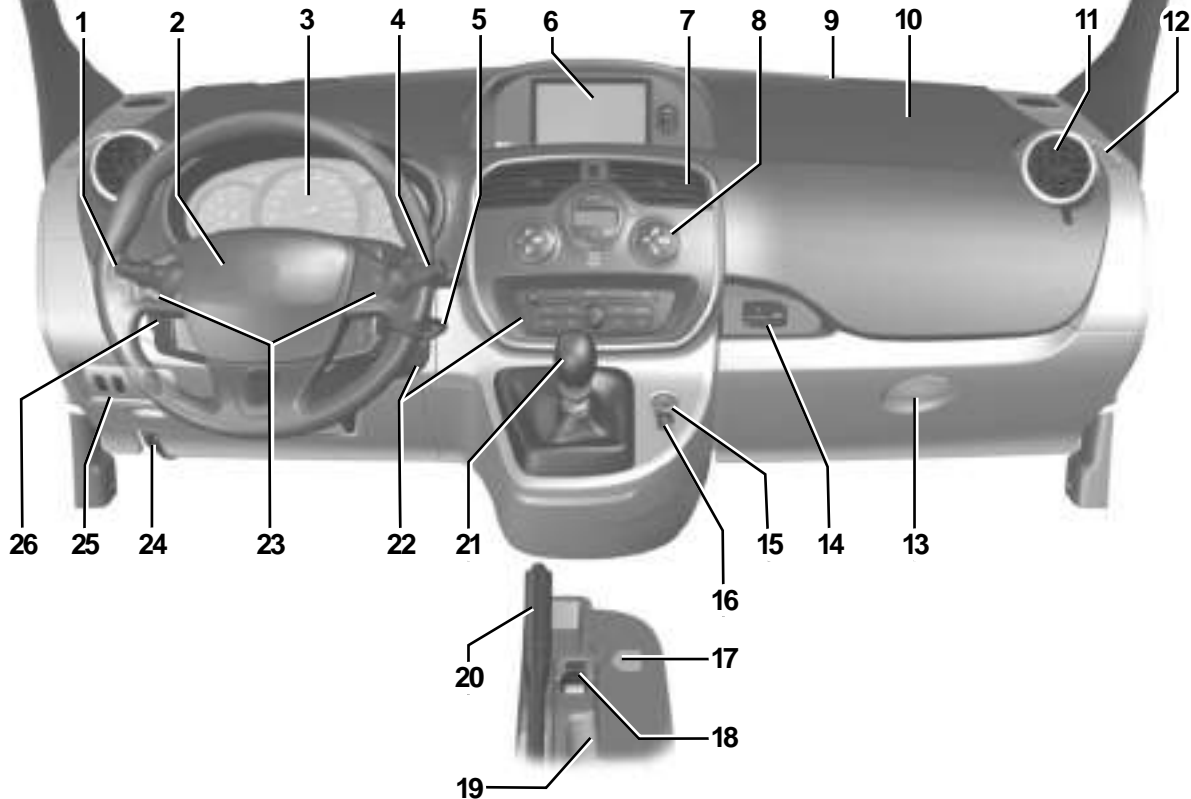



## DRIVING POSITION: LEFT-HAND DRIVE (2/2)

The equipment fitted, described below, **DEPENDS ON THE VERSION AND COUNTRY.**

- 1** Stalk for:
  - direction indicator lights,
  - exterior lights,
  - front fog lights,
  - rear fog lights.
- 2** – Horn,
  - location for driver's air bag.
- 3** Instrument panel.
- 4** Stalk for:
  - wipers,
  - windscreen washer,
  - trip computer and warning system.
- 5** Ignition switch.
- 6** Multimedia display or touchscreen:
  - seat belt reminder warning light,
  - air bag deactivation warning light,
  - navigation,
  - clock,
  - exterior temperature.
- 7** Centre air vent.
- 8** Controls for ventilation, heating and de-icing.
- 9** Windscreen demister outlet.
- 10** Location for passenger air bag.
- 11** Side air vent.
- 12** Side window demister outlet.
- 13** Glovebox.
- 14** Storage space or accessories socket.
- 15** Hazard warning lights switch.
- 16** Door electric locking/unlocking switch.
- 17** ECO mode switch.
- 18** Cigarette lighter/12 V socket.
- 19** Central storage compartment.
- 20** Handbrake.
- 21** Gear lever.
- 22** Remote control/location for radio, navigation system.
- 23** Cruise control/speed limiter controls.
- 24** Bonnet release control.
- 25** Controls for:
  - parking distance;
  - headlight vertical beam adjustment.
- 26** Controls for:
  - cruise control/speed limiter.
  - deactivating/activating the Stop and Start function.
  - activation/deactivation of the traction control or grip system.

# DRIVING POSITION: RIGHT-HAND DRIVE (1/2)

30016

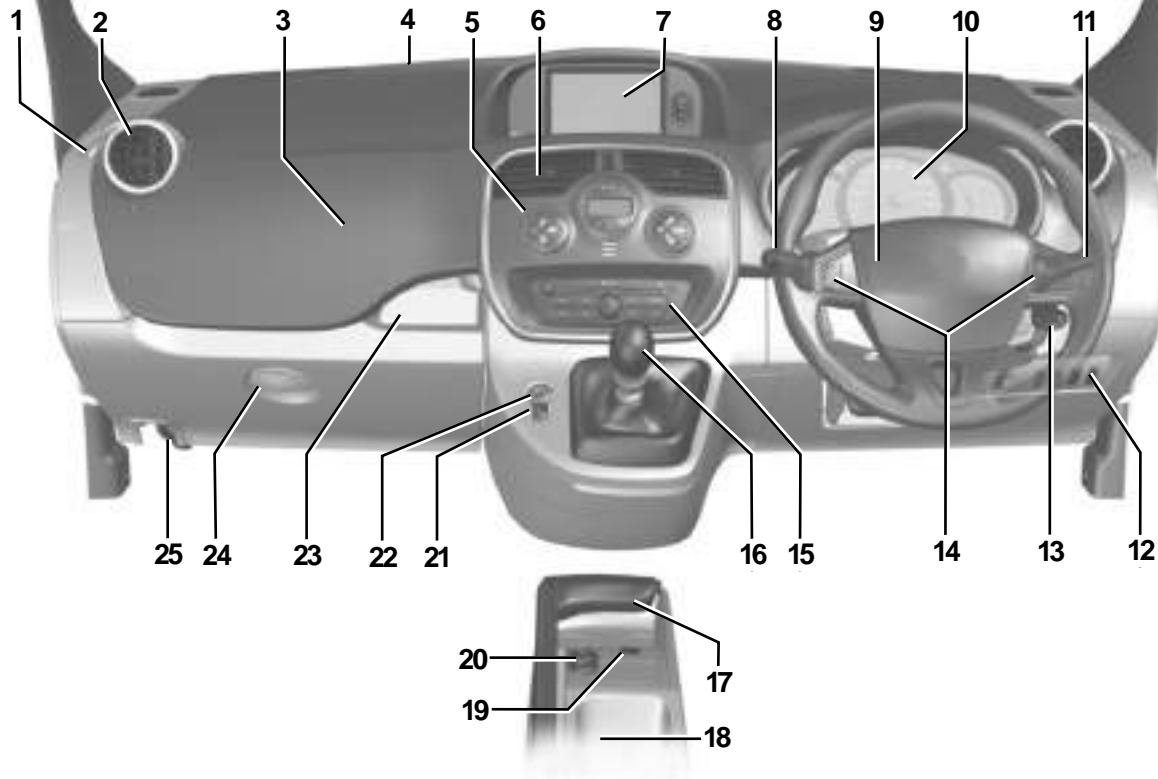

## DRIVING POSITION: RIGHT-HAND DRIVE (2/2)

The equipment fitted, described below, **DEPENDS ON THE VERSION AND COUNTRY.**

- |  |  |  |
|--|--|--|
| <p><b>1</b> Side window demister outlet.</p> <p><b>2</b> Side air vent.</p> <p><b>3</b> Location for passenger airbag.</p> <p><b>4</b> Windscreen demister outlet.</p> <p><b>5</b> Controls for ventilation, heating and de-icing.</p> <p><b>6</b> Centre air vent.</p> <p><b>7</b> Multimedia display or touchscreen:</p> <ul style="list-style-type: none"><li>– seat belt reminder warning light,</li><li>– air bag deactivation warning light,</li><li>– navigation,</li><li>– clock,</li><li>– exterior temperature.</li></ul> <p><b>8</b> Stalk for:</p> <ul style="list-style-type: none"><li>– direction indicator lights,</li><li>– exterior lights,</li><li>– front fog lights,</li><li>– rear fog lights.</li></ul> | <p><b>9</b> – Horn.</p> <ul style="list-style-type: none"><li>– Location for driver's air bag.</li></ul> <p><b>10</b> Instrument panel.</p> <p><b>11</b> Stalk for:</p> <ul style="list-style-type: none"><li>– wipers,</li><li>– windscreen washer,</li><li>– trip computer and warning system.</li></ul> <p><b>12</b> Controls for:</p> <ul style="list-style-type: none"><li>– cruise control/speed limiter;</li><li>– activating/deactivating the traction control or grip system;</li><li>– deactivating/activating the Stop and Start function;</li><li>– parking distance control;</li><li>– headlight beam adjustment.</li></ul> <p><b>13</b> Ignition switch.</p> <p><b>14</b> Cruise control/speed limiter controls.</p> | <p><b>15</b> Location for radio, navigation system.</p> <p><b>16</b> Gear lever.</p> <p><b>17</b> Handbrake.</p> <p><b>18</b> Central storage compartment.</p> <p><b>19</b> ECO mode switch.</p> <p><b>20</b> Cigarette lighter/12 V socket.</p> <p><b>21</b> Door electric locking/unlocking switch.</p> <p><b>22</b> Hazard warning lights switch.</p> <p><b>23</b> Storage space or accessories socket.</p> <p><b>24</b> Glovebox.</p> <p><b>25</b> Bonnet release control.</p> |
|--|--|--|

## WARNING LIGHTS (1/4)

The presence and operation of the warning lights **DEPEND ON THE EQUIPMENT AND COUNTRY.**



Instrument panel A



Warning light **STOP** requires you to stop immediately, for your own safety, as soon as traffic conditions allow. Switch off the engine and do not restart it. Contact an approved Dealer.



Main beam headlight tell-tale light



Dipped beam headlight tell-tale



Front fog light tell-tale light



Rear fog light tell-tale



Direction indicator tell-tale light

The  warning light means you should **drive very carefully** to an approved Dealer as soon as possible. If you fail to follow this recommendation, you risk damaging your vehicle.



If no lights or sounds are apparent, this indicates a fault in the instrument panel. This indicates that it is essential to stop immediately (as soon as traffic conditions allow). Ensure that the vehicle is correctly immobilised and contact an approved Dealer.



Variable power assisted steering warning light

This lights up when the ignition is switched on and goes out after a few seconds.

If it comes on when driving accompanied by a beep, this indicates a fault in the system.

Contact an approved Dealer as soon as possible.



**Gear change indicator.**

This lights up to advise you to change to a higher gear (up arrow) or lower gear (down arrow).

## WARNING LIGHTS (2/4)

The presence and operation of the warning lights **DEPEND ON THE EQUIPMENT AND COUNTRY.**



### **STOP STOP light**

It comes on when the ignition is switched on, sometimes at the same time as other warning lights and then goes out after several seconds.

It indicates that it is essential to stop as soon as traffic conditions allow. Contact an approved Dealer as soon as possible.

Depending on the vehicle, this warning light is accompanied by a message on the instrument panel.



### **Coolant temperature warning light**

If this remains lit while driving accompanied by the **STOP** indicator light, it indicates engine overheating. Stop and allow the engine to run at idle speed for a minute or two. The temperature should drop. If not, stop the engine. Let the engine cool down, then check the coolant level. Contact an approved Dealer if necessary.



### **Handbrake "on" warning light and brake circuit incident warning light**

This comes on when the ignition is switched on. If it comes on during braking or when the vehicle is being driven, accompanied by the **STOP** indicator light, it means that one of the circuit levels is too low; it may be dangerous to continue driving. Consult an approved Dealer.



### **Warning light**

It comes on when the ignition is switched on, sometimes at the same time as other warning lights and then goes out after several seconds.

If the light comes on, you should visit an approved Dealer immediately.

Depending on the vehicle, this warning light is accompanied by a message on the instrument panel.



### **Warning light for monitoring exhaust gas**

On equipped vehicles, the light comes on when the ignition is switched on then goes out.

- If it lights up continuously accompanied by the  indicator light, consult an approved Dealer as soon as possible;
- If it flashes, reduce the engine speed until the light stops flashing. Contact your approved Dealer as soon as possible.

Refer to "Emission control, fuel economy and driving advice" in section 2.

## WARNING LIGHTS (3/4)

The presence and operation of the warning lights **DEPEND ON THE EQUIPMENT AND COUNTRY.**



### Oil pressure warning light

If it comes on while you are driving, stop at once and switch off the ignition.

Check the oil level (refer to section 4 “Engine oil level”). If the level is normal, the light has come on for another reason: contact an approved Dealer as soon as possible.



### Preheating warning light (on diesel version)

This should come on when the ignition is switched on. It indicates that the heater plugs are in operation. It goes out after preheating is sufficient and the engine can be started.



### Electronic fault warning light

If it comes on when driving, it indicates an electronic or electrical fault or, for diesel versions, the presence of water in the diesel fuel.

Contact your approved Dealer as soon as possible.



### Air bag warning light

This comes on when the ignition is switched on and goes out after a few seconds. If it does not come on when the ignition is switched on or if it flashes, there is a fault in the system.

Contact an approved Dealer as soon as possible.



### Anti-lock braking warning light

This lights up when the ignition is switched on and goes out after a few seconds.

If it does not go out after the ignition is switched on, or lights up when driving, there is a fault with the ABS. Braking will then be as normal, without the ABS system.

Contact an approved Dealer as soon as possible.



### Low fuel level warning light

This comes on when the ignition is switched on and goes out after a few seconds. If it comes on when driving and is accompanied by a beep, fill up with fuel as soon as possible. There is only approximately 30 miles (50 km) worth of fuel left after the warning light first comes on.

## WARNING LIGHTS (4/4)

The presence and operation of the warning lights **DEPEND ON THE EQUIPMENT AND COUNTRY.**



### **Seat belt reminder light**

Depending on the vehicle, it is displayed on the instrument panel or on the central display of the dashboard. It remains on when the engine is started if your seat belt is not fastened. A beep sounds at a low volume for 30 seconds, then at a high volume for 90 seconds.



### **Battery charge warning light**

If it comes on when you are driving, it indicates that the circuit is overcharged or has discharged. Stop and consult an approved Dealer as soon as possible.



### **Door status warning light**

If it lights up when the ignition is switched on, it indicates that a door is not properly closed.



### **Engine standby warning light**

Please see information in the paragraph on “Stop and Start Function” in Section 2.



### **Unavailability of engine standby warning light**

Please see information in the paragraph on “Stop and Start Function” in Section 2.



### **Cruise control and speed limiter indicator lights**

Refer to the information on the “Speed limiter” and “Cruise control” in Section 2.



### **Warning light for electronic stability program ( ESC ) and traction control system**

Please refer to the information on “Driver correction devices and aids” in Section 2.



### **Tyre pressure loss warning**

Please refer to the information on the “Tyre pressure loss warning” in Section 2.

## DISPLAYS AND INDICATORS (1/3)

The presence and operation of the display and indicators **DEPENDS ON THE LEVEL OF EQUIPMENT AND THE COUNTRY.**



### Speedometer 1

#### Overspeed buzzer

Depending on the vehicle, a beep sounds for 10 seconds approximately every 40 seconds as long as the vehicle is travelling at over 72 miles per hour (120 km/h).

**Note:** depending on the vehicle, the desired speed may be programmed; consult an approved Dealer.



### Rev counter 2

(graduations x 1000)



## DISPLAYS AND INDICATORS (2/3)

The presence and operation of the display and indicators **DEPENDS ON THE LEVEL OF EQUIPMENT AND THE COUNTRY.**



### Fuel gauge A

The number of squares lit shows the fuel level. When it is at the minimum level, the last square comes on, accompanied by a beep. A warning light also lights up on the instrument panel.

Fill up as soon as possible. There is only approximately 30 miles (50 km) worth of fuel left after the warning light first comes on.



### Fuel gauge 3

The needle shows the fuel level. When it is at the minimum level, the fuel warning light comes on, accompanied by a beep.

Fill up as soon as possible. There is only approximately 30 miles (50 km) worth of fuel left after the warning light first comes on.

### Coolant temperature indicator 4 or A

In normal use, the needle should be positioned before zone **B**. Under “intensive” operating conditions, the needle may approach this zone. The only warning is if the indicator light comes on or the message “engine overheating” appears.

## DISPLAYS AND INDICATORS (3/3)

The presence and operation of the display and indicators **DEPENDS ON THE LEVEL OF EQUIPMENT AND THE COUNTRY.**



### Low engine oil level warning

Depending on the vehicle, when the engine is started and for 30 seconds, display **A** alerts the driver when the minimum engine oil level is reached. Refer to the information on the “Engine oil level” in Section 4.

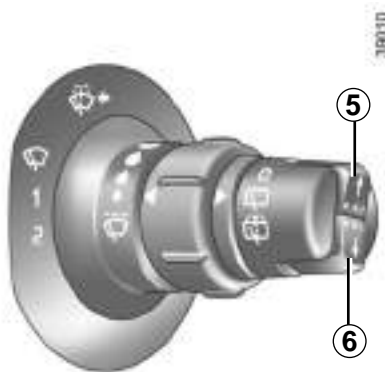

### Display selection keys 5 or 6

Depending on the vehicle, pressing the button repeatedly enables the information on the display to be selected and the trip mileage recorder to be reset (for this, the trip mileage must be selected on the display).

#### – Display selection

Press briefly to move from the total mileage to the trip mileage and vice versa.

#### –Resetting the trip mileage recorder

Once trip mileage has been selected on the display, press and hold the button.

#### Multifunction display

Total mileage recorder.

Trip mileage recorder.

Setting the time.

OR

#### Trip computer and warning system



Refer to the information on the “Trip computer and warning system” in Section 1.

## TRIP COMPUTER: general information (1/2)



### Trip computer and warning system A

Depending on the vehicle, this includes the following functions:

- distance travelled;
- journey parameters;
- information messages;
- operating fault messages (associated with the  warning light);
- warning messages (connected to the warning light .

All these functions are described on the following pages.

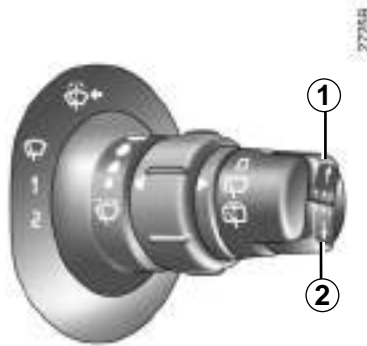

### Display selection keys 1 and 2

Scroll through the following information upwards (button 1) or downwards (button 2) by pressing briefly and successively (the display depends on the vehicle equipment and country).

- Total mileage and trip mileage recorder,
- journey parameters:
  - fuel consumed;
  - average fuel consumption;
  - current fuel consumption;
  - estimated range;
  - distance travelled;
  - average speed;

- Mileage before oil change
- Cruise control and speed limiter programmed speed
- Reset the tyre pressure
- Trip log, operating faults and information message readout.

## TRIP COMPUTER: general information (2/2)

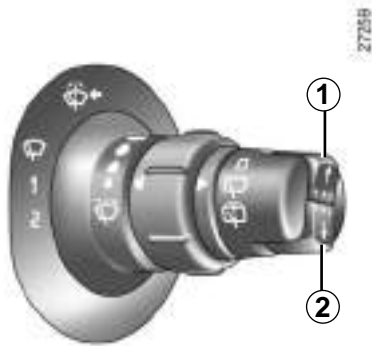

### Trip mileage resetting

With "trip mileage recorder" selected on the display, press button **1** or **2** until the mileage recorder resets to zero.

### Resetting the journey parameters (reset button)

With one of the journey parameters selected on the display, press button **1** or **2** until the display resets.

### Interpreting some of the values displayed after resetting

The values showing average fuel consumption, range and average speed will become more stable and reliable the further you travel after pressing the reset button.

For the first few miles after pressing the reset button you may notice:





- that the range increases as you travel. This range takes into account the average fuel consumption since the last time the reset button was pressed. Therefore, the average fuel consumption may decrease when:
  - the vehicle has just stopped accelerating;
  - the engine reaches its operating temperature (if the engine was cold when the reset key was pressed);
  - when driving from an urban area onto the open road.

### Automatic resetting of the journey parameters

Resetting occurs automatically when the maximum value of any of the parameters is exceeded.

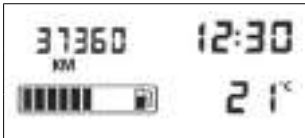

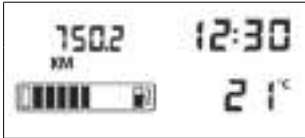

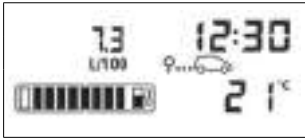

# TRIP COMPUTER AND WARNING SYSTEM: journey parameters (1/4)

The display of information shown below **DEPENDS ON THE VEHICLE EQUIPMENT AND COUNTRY.**

Examples of selections		Interpreting the display selected
<p>37360 KM 7080 KM</p>		<p>a) Total mileage and trip mileage recorder</p> <p>b) Journey parameters</p> <p><b>Fuel consumed</b> since the last reset.</p> <p><b>Average fuel consumption</b> since the last reset.</p> <p>This value is displayed after driving 400 metres and takes into account the distance travelled and the fuel used since the last time the reset button was pressed.</p>
<p>FUEL USED 26.0 L</p> 		
<p>AVERAGE 7.3 L/100</p> 		

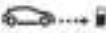
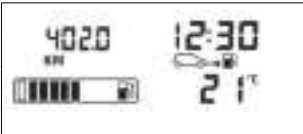



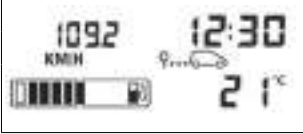



## TRIP COMPUTER AND WARNING SYSTEM: journey parameters (2/4)

The display of information shown below **DEPENDS ON THE VEHICLE EQUIPMENT AND COUNTRY.**

Examples of selections		Interpreting the display selected
<p>CURRENT <b>8.6 L/100</b></p> 		<p><b>Current fuel consumption</b></p> <p>This value is displayed after a speed of approximately 20 mph (30 km/h) is reached.</p>
<p>RANGE <b>402.0 KM</b></p> 		<p><b>Estimated range with remaining fuel</b></p> <p>This range takes into account the average fuel consumption since the last time the reset button was pressed.</p> <p>The value is displayed after driving 400 metres.</p> <p>Several minutes after the reserve light has come on (refer to the information on the "Instrument panel"), the estimated range will no longer be displayed.</p>
<p>DISTANCE <b>430.0 KM</b></p> 		<p><b>Distance travelled</b> since the last reset.</p>
<p>AVERAGE <b>109.2 KM/H</b></p> 		<p><b>Average speed</b> since the last reset.</p> <p>The value is displayed after driving 400 metres.</p>

## TRIP COMPUTER AND WARNING SYSTEM: journey parameters (3/4)

The display of information shown below **DEPENDS ON THE VEHICLE EQUIPMENT AND COUNTRY.**

Examples of selections	Interpreting the display selected		
<table border="1"><tr><td data-bbox="84 266 364 418"><p>SERVICE IN 137.7 KM</p></td><td data-bbox="374 266 674 418"></td></tr></table>	<p>SERVICE IN 137.7 KM</p> 		<p><b>c) Mileage before service</b> Distance remaining until the next service (displayed in kilometres), then when the service nears, several scenarios are possible:</p> <ul style="list-style-type: none"><li>– distance/time less than <b>1,800 miles</b> (3,000 km) or <b>two months</b>: the message “SERVICE DUE ” is displayed;</li><li>– mileage before service equal to <b>0 miles</b> (0 km) or service date reached: the message “SERVICE PROMPTLY” is displayed when the selected display is “mileage before service”, along with the symbol  and the warning light .</li></ul> <p>The vehicle requires a service as soon as possible.</p>
<p>SERVICE IN 137.7 KM</p> 			
<p><b>Note:</b> depending on the vehicle, the mileage before service changes according to the driving style (frequent driving at low speeds, door-to-door, prolonged periods at idle speed, towing a trailer, etc.). The distance remaining until the next service can therefore, in some cases, be less than the actual distance remaining.</p> <p><b>Resetting the display after the service in accordance with the maintenance schedule.</b> The mileage before service must only be reset after a service which complies with the recommendations in the Maintenance Document.</p> <p>If you decide to change the oil more frequently, do not reset this data each time the oil is changed to avoid exceeding the replacement intervals for other parts in the maintenance schedule.</p> <p><b>Special features:</b> to reset the mileage before service value, go to the service page (see image above) and press and hold one of the display’s reset buttons for at least 10 seconds until the mileage before service value is displayed continuously. Refer to the information on the “Trip computer and warning system: general information” in Section 2.</p>			

## TRIP COMPUTER AND WARNING SYSTEM: journey parameters (4/4)

The display of information shown below **DEPENDS ON THE VEHICLE EQUIPMENT AND COUNTRY.**

Examples of selections		Interpreting the display selected
<p>SPEED LIMITER 70 KM/H</p>		<p><b>d) Cruise control/speed limiter programmed speed</b> (depending on vehicle). Please refer to the information on "Cruise control/speed limiter" in Section 2.</p> <p><b>e) Reset the tyre pressures</b> Please refer to the information on the "Tyre pressure loss warning" in Section 2.</p>
<p>CRUISE CONTROL 70 KM/H</p>		
<p>TIRES:SET TPW</p>	<p>SEt tP</p>	
<p>TYRE PRESSURE ACQUISITION</p>	<p>SEt PP</p>	



# TRIP COMPUTER AND WARNING SYSTEM: information messages

## Information messages

These can help in the vehicle starting phase, or give information about a selection or a driving status.

Examples of information messages are given in the following pages.

Examples of messages	Interpretation of messages
<p>« NO MESSAGE AVAILABLE »</p> <p>« BOOT OPEN »</p> <p>« BATTERY MODE : ECONOMY »</p> <p>« OIL LEVEL CORRECT »</p> <p>« AUTO LIGHTS DEACTIVATED »</p>	<p>f) Trip log</p> <p>Successive display:</p> <ul style="list-style-type: none"><li>- information messages (automatic lighting, etc.),</li><li>- operating fault messages (check injection system, etc).</li></ul> <p>Indicates that the tailgate has been left open.</p> <p>Indicates that vehicle accessories have been switched off to preserve the battery.</p> <p>Indicates that the oil level is correct when the ignition is switched on.</p> <p>Indicates that the automatic lights function is deactivated.</p>

## TRIP COMPUTER AND WARNING SYSTEM: operating fault messages

These appear with the  warning light and mean that you should drive very carefully to an approved Dealer as soon as possible. If you fail to follow this recommendation, you risk damaging your vehicle.

They disappear when the display selection key is pressed or after several seconds and are stored in the computer log. The  warning light stays on. Examples of operating fault messages are given on the following pages.

Examples of messages	Interpretation of messages
« CHECK ESC »	Indicates a fault in the Electronic Stability Program and the traction control system (see "Driver correction devices and aids" in Section 2).
« CHECK FUEL FILTER »	Indicates that there is water present in the diesel fuel. Contact an approved Dealer as soon as possible.
« CHECK GEARBOX »	Indicates that a fault has occurred in the gearbox; contact an approved Dealer as soon as possible.
« CHECK AUTO LIGHTS »	Indicates an automatic lighting operating fault; contact an approved Dealer.
« CHECK STEERING »	Indicates a power-assisted steering system operating fault.

## TRIP COMPUTER AND WARNING SYSTEM: warning message

These appear with the **STOP** warning light and require you to stop immediately, for your own safety, as soon as traffic conditions allow. Stop your engine and do not restart it. Contact an approved Dealer.

Examples of warning messages are given in the following pages. **Note:** the messages appear on the display either individually or alternately (when there are several messages to be displayed), and may be accompanied by a warning light and/or a beep.

Examples of messages	Interpretation of messages
« INJECTION FAULT »	Indicates that the vehicle has a serious engine fault.
« ENGINE OVERHEATING »	Indicates that the engine is overheating.
« STEERING FAULT »	Indicates a fault in the vehicle's power assisted steering.
« GEARBOX OVERHEATING »	Indicates that the gearbox is overheating.
« TYRE PUNCTURE »	Indicates that at least one wheel is punctured or severely underinflated.

## CLOCK AND EXTERIOR TEMPERATURE (1/2)

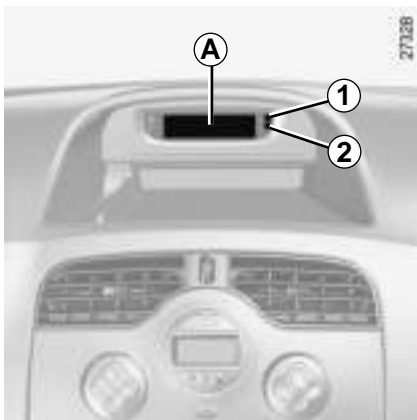

With the ignition on, the time and, depending on the vehicle, exterior temperature are displayed.

### Setting the time

#### Setting clock A

On equipped vehicles, adjustment buttons **1** and **2** are used to set the clock.

Press button **1** to adjust the hours and button **2** to adjust the minutes.

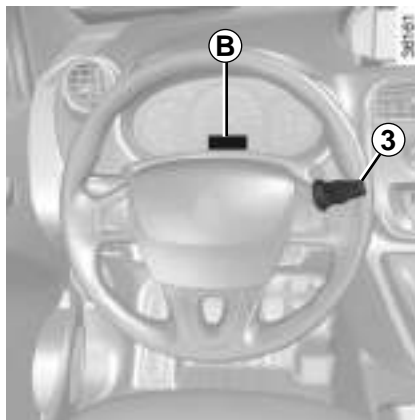

#### Setting clock B

Display the “clock” page on the instrument panel by pressing one of the buttons on stalk **3**.

After two seconds, the hours and minutes start flashing.

Press and hold the bottom button to enter the hour setting mode.

When only the hours flash, press the top button to scroll through them.

Press and hold the bottom button to enter the minute setting mode.

When only the minutes flash, press the top button to scroll through them.

Confirm by pressing and holding the bottom button on stalk **3**.

If the power supply is cut (battery disconnected, supply wire cut, etc.), the clock must be reset.

We recommend that you do not adjust these settings while driving.

## CLOCK AND EXTERIOR TEMPERATURE (2/2)



### Resetting the clock C

Vehicles fitted with touch-screen multimedia, navigation aid systems, telephones, etc.

Refer to the separate instructions for the function to understand the special features of this equipment.

### Exterior temperature

If the vehicle is suitably equipped, when the exterior temperature is between  $-3^{\circ}\text{C}$  and  $+3^{\circ}\text{C}$ , the  $^{\circ}\text{C}$  characters flash (risk of black ice on the road).



#### Exterior temperature indicator

As ice formation is related to climatic exposure, local air humidity and temperature, the external temperature alone is not sufficient to detect ice.

## DOOR MIRRORS (1/2)

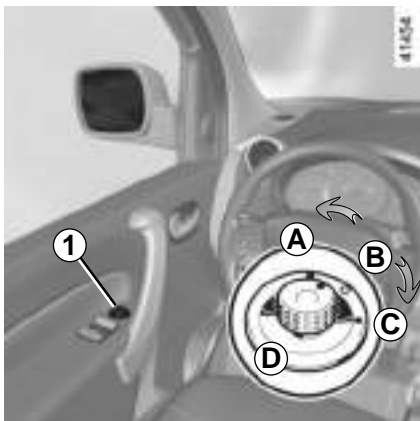

### Door mirrors with electrical adjustment

With the ignition on, turn button **1**:

- position **A** to adjust the left-hand door mirror;
- position **C** to adjust the right-hand door mirror.

**B** is the inactive position.

### Heated door mirrors

With the engine running, mirror de-icing is activated with the rear screen de-icing/demisting.

### Folding door mirrors

Move button **1** to position **D** to fold the door mirrors in. To reset them for driving, return to position **B**.

If you fold the door mirrors in manually before resetting them to driving position **B**, you must first turn button **1** to position **D**.



Objects observed in the door mirror glass are actually closer than they appear.

For your safety, take this into account in order to correctly assess the distance before any manoeuvre.

## DOOR MIRRORS (2/2)



### Door mirrors with manual adjustment

To adjust the door mirror, move switch **2**.

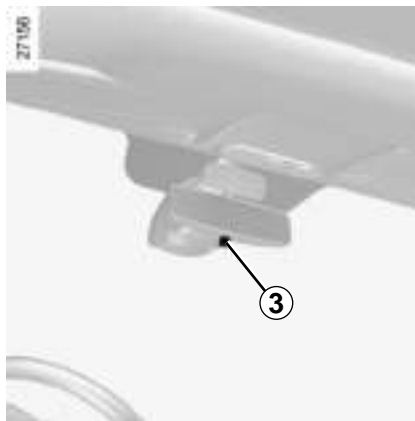

### Interior rear view mirror

The interior rear-view mirror is adjustable.

### Rear view mirror with lever **3**

When driving at night, to avoid being dazzled by the headlights of the vehicle behind, depress the little lever located behind rear view mirror **3**.

### Rear view mirror without lever **3**

The rear-view mirror automatically darkens when you are being followed by a vehicle using main beam headlights or in very bright lighting.

## AUDIBLE AND VISUAL SIGNALS



### Horn

Press at one of the locations **2**.

### Headlight flasher

Pull stalk **1** towards you to flash the headlights.



### Hazard warning lights

Press switch **3**. This device simultaneously activates the four direction indicators and the side indicator lights. It must only be used in an emergency to warn other drivers that you have had to stop in an area where stopping is prohibited or unexpected, or that you are obliged to drive under special conditions.

Depending on the vehicle, the hazard warning lights may come on automatically under heavy deceleration. You can switch them off by pressing switch **3**.

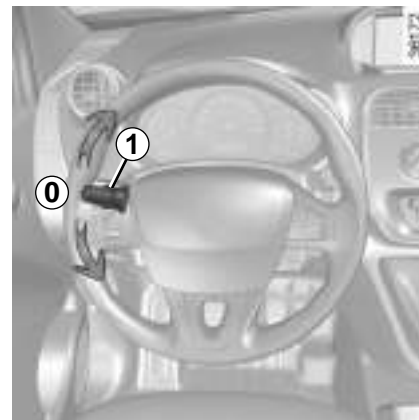

### Direction indicators

Move stalk **1** parallel to the steering wheel and in the direction you are going to turn it.

When driving on the motorway, the steering wheel is not often turned enough to return the stalk automatically to **0**. There is an intermediate position in which the stalk may be held when changing lanes.

When the stalk is released, it automatically returns to **0**.



## EXTERNAL LIGHTING AND SIGNALS (1/3)

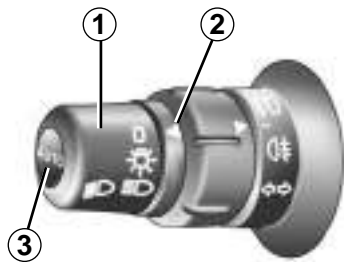

### Side lights

Turn the end of stalk **1** until the symbol is opposite mark **2**.

The instrument panel will light up.



### Dipped beam headlights

#### Manual operation

Turn the end of stalk **1** until the symbol is opposite mark **2**. This indicator light on the instrument panel comes on.

#### Automatic operation (depending on vehicle)

With the engine running, the dipped beam headlights are switched on or off automatically depending on the level of ambient light, without the need to operate stalk **1**.

This function can be deactivated or reactivated.

- **To activate:** with the ignition on and the vehicle stationary, press and hold button **3** for at least four seconds. Depending on the vehicle, the message "lights ON" appears on the instrument panel.
- **To deactivate:** with the ignition on and the vehicle stationary, press and hold button **3** for at least four seconds. Depending on the vehicle, the message "lights OFF" appears on the instrument panel.



### Main beam headlights

With stalk **1** in dipped beam headlights position, move the stalk towards you. The indicator light on the instrument panel then lights up.

To return to the dipped beam headlight position, pull the stalk towards you again.



Before driving at night, check that the electrical equipment is operating correctly and adjust the headlight beams (if your vehicle is not carrying its normal load). As a general precaution, check that the lights are not obscured (by dirt, mud, snow or objects being transported).

## EXTERNAL LIGHTING AND SIGNALS (2/3)

### “See-me-home lighting” function

(depending on vehicle)

This function (useful, for example, when opening a gate, garage, etc.) enables you to switch the dipped headlights on momentarily.

With the ignition off and the headlights off, pull stalk **1** towards you: the dipped beam headlights come on for approximately sixty seconds.

This action may be carried out no more than four times for a maximum lighting period of four minutes.

To switch off the lights before they switch off automatically, turn the end of stalk **1** then bring it back to position 0, or switch on the ignition.

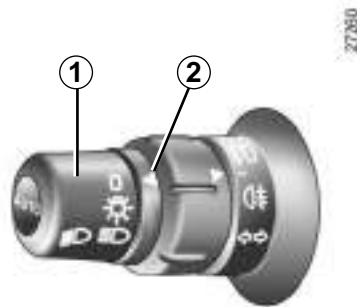

### Switching off the lights

There are two possibilities:

- manually, move stalk **1** to its original position;
- automatically, the lights are switched off when the engine is stopped, the driver's door is opened or, depending on the vehicle, when the vehicle is locked. In this case, the next time the engine is started the lights will be switched back on according to the position of the ring **2**.

## EXTERNAL LIGHTING AND SIGNALS (3/3)



### **Front fog lights** (depending on vehicle)

The side lights or dipped beam headlights must be on.

Turn ring **5** on stalk **1** until the symbol is opposite mark **4**, then release it. This indicator light on the instrument panel comes on.

### **Rear fog light**

The front fog lights and the side lights or dipped beam headlights must be on.

Turn ring **5** on stalk **1** until the symbol is opposite mark **4**, then release it. This indicator light on the instrument panel comes on.

To avoid inconveniencing other road users, remember to switch off the rear fog light when it is no longer needed.

### **Switching off the lights**

Turn ring **5** again to position mark **4** opposite the symbol for the light you wish to switch off.

Switching off the exterior lights or the ignition switches off the front and rear fog lights.

## HEADLIGHT BEAM ADJUSTMENT (1/2)



Control knob **1** is used to adjust the height of the headlight beams according to the load.

Turn control knob **1** downwards to lower the headlights and upwards to raise them.

Unladen, control knob **1** should be at 0.

When the vehicle is partially or completely laden, the headlight beam should be set to light the road at between 50 and 100 metres. Then use positions 1 to 4 on the control knob.

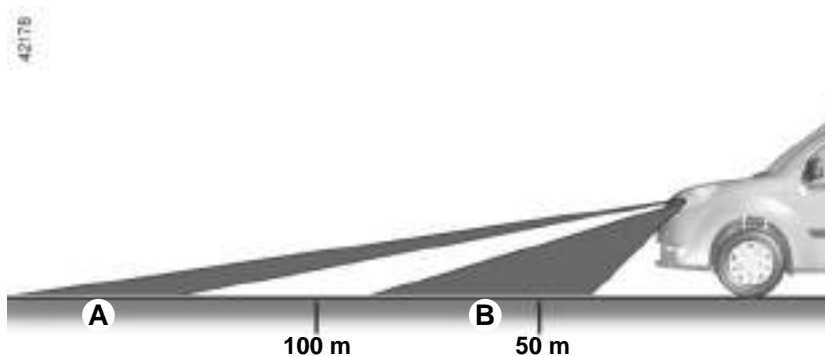

**A** Incorrect setting: the lights are set too high and could dazzle other drivers. Turn the control knob downwards to lower the beam.

**B** Correct setting: the beam's maximum range is between 50 and 100 metres.

## HEADLIGHT BEAM ADJUSTMENT (2/2)

When driving on the left in a left-hand drive vehicle (or vice versa), you must adjust your lights temporarily during your stay.

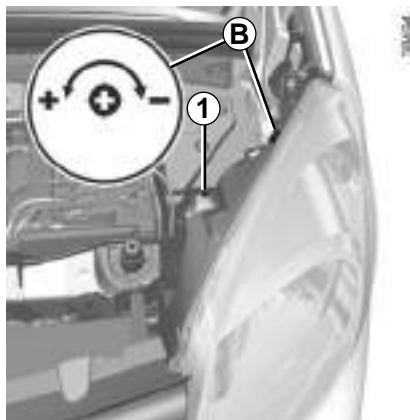

### Temporary adjustment

Open the bonnet and identify the marking **B** next to one of the front headlight projectors.

For each headlight, using a screwdriver, turn the screw **1** by a quarter turn towards the - symbol to lower the beams.

Return to the starting point once your trip is over: turn the screw **1** by a quarter turn towards the + symbol to raise the beams.

## FRONT WINDSCREEN WASHER/WIPER (1/2)

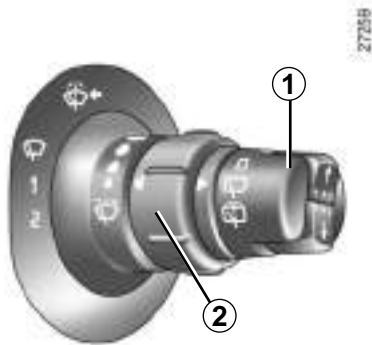

### Windscreen wiper

With the ignition on, move stalk **1** around the steering wheel:

#### A Park

#### B Intermittent wiping

The wipers will pause for several seconds between sweeps. It is possible to change the time between sweeps by turning ring **2**.

#### C Normal wiping speed

#### D Fast wiping speed

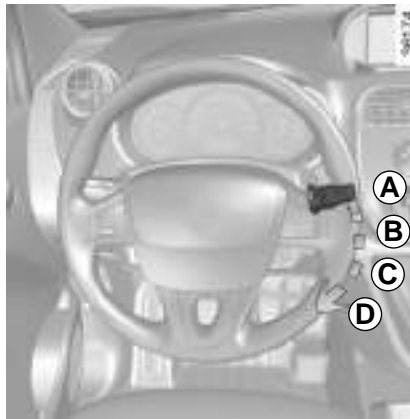

### Special note

**When the vehicle is being driven,** the wiping speed slows down whenever the vehicle stops. For example, fast wiping speed will slow to normal wiping speed. As soon as the vehicle moves off, wiping will return to the speed originally selected.

If stalk **1** is operated, it overrides and cancels the automatic function.

If for any reason the wipers are jammed (eg. frozen to windscreen by ice, etc.), the system will automatically cut the power supply to the wipers.

### Automatic wiper function (depending on vehicle)

With the engine running, move stalk **1**.

#### A Park

#### B Automatic wiper function

When this position is selected, the system detects the presence of water on the windscreen and triggers wiping at a suitable wiping speed. The triggering threshold and the time between sweeps can be adjusted by turning ring **2**.

**Note:** in foggy weather or during snowfalls, wiping is not automatically triggered and remains under the driver's control.

#### C Normal wiping speed

#### D Fast wiping speed

## FRONT WINDSCREEN WASHER/WIPER (2/2)

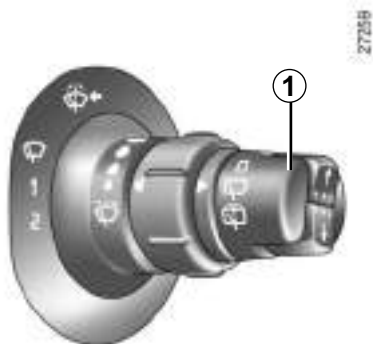

### Windscreen wiper

**With the ignition on**, pull stalk **1** towards you.

A brief pull will trigger a single sweep of the wipers, in addition to the windscreen washer.

A longer pull will trigger three sweeps of the wipers followed, a few seconds later, by a fourth, in addition to the windscreen washer.

In freezing or snowy weather, ensure they are not stuck to the windscreen (including the central area located behind the interior rear-view mirror) and the rear screen before starting the wipers (risk of motor overheating).



Before any action on the windscreen (washing the vehicle, de-icing, cleaning the windscreen, etc.) return stalk **1** to position **A** (park).

Risk of injury and/or damage.

## REAR WINDSCREEN WASHER/WIPER

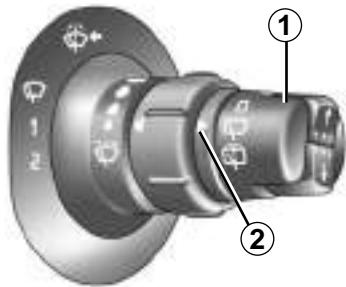

### Speed-dependent rear screen wiper with timer (depending on vehicle)

Turn the end of stalk **1** to position the symbol opposite mark **2**.

Wiping frequency varies with speed.

#### Special note

If the windscreen wipers are operational when you select reverse gear, the rear screen is wiped intermittently.

### Rear screen wash/wipe (depending on vehicle)

Turn the end of stalk **1** to position the symbol opposite mark **2**.

When the stalk is released, it returns to the rear screen wiper position.

Check the condition of the wiper blades. You are responsible for their service life:

- they must remain clean: clean the blades, windscreen and rear screen regularly with soapy water;
- do not use them when the windscreen or rear screen are dry;
- free them from the windscreen or rear screen when they have not been used for a long time.

In all cases, replace them as soon as they begin to lose efficiency: approximately once a year.

Before using the rear wiper, check that no object obstructs the travel of the blade.

Do not use the wiper arm to open or close the tailgate.



## FUEL TANK (1/3)

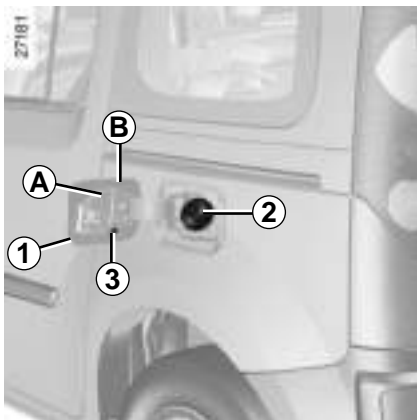

### Filling the tank

With the vehicle unlocked, to open the fuel filler flap, place your finger in opening **1** and pull the flap.

Use the ignition key to open the cap **2**.

Use cap holder **3** on the fuel filler flap **B** during filling to hold the cap **2** in place.

**Useful capacity of fuel tank: about 60 litres for diesel versions and about 56 litres for petrol versions.**



**Fuel filler cap: this is of a special type.**

If you have to replace it, make sure it is identical to the original cap. Contact an approved Dealer.

Never place the cap near a source of heat or flame.

Do not wash the filler area with a high-pressure washer.

### Fuel grade

Use a **high-grade fuel** that complies with the legislation in force in each country. It **must** conform to the specifications given on label **A** inside the fuel filler flap. Please refer to the information on “Engine specifications” in Section 6.

### Diesel versions

It is **essential** to use diesel fuel that conforms to the specifications given on the label inside fuel filler flap **A**.

Make sure that no water accidentally enters the fuel tank during filling. The shut-off system and its surrounding area must be dust-free.



Do not mix even small amounts of petrol (unleaded or E85) with diesel.

Do not use ethanol-based fuel if your vehicle is not compatible with this fuel.

Do not add additive to the fuel – otherwise you risk damaging the engine.

## FUEL TANK (2/3)

### Petrol versions

It is **essential** to use unleaded petrol. The octane rating (RON) should match the information given on the label **A** located inside the fuel filler flap. Please refer to the information on "Engine specifications" in Section 6.

### Vehicles running on ethanol-based fuel

It is **essential** to use unleaded petrol or fuel containing a maximum of 85% ethanol (E85).

In very cold conditions, it may be very difficult or even impossible to start the engine. To avoid this problem, use unleaded petrol or, on equipped vehicles, use the heater integrated in the engine: connect the correct end of the extension piece supplied into the socket integrated into the radiator grille and the other end into a **220 V** socket for at least 6 hours before starting.

**NB:** you may notice an increase in fuel consumption with this type of fuel.

### Filling with fuel

With the ignition off, insert the nozzle so that the valve opens and then **fully** insert it before beginning to fill the tank (risk of splashback).

Keep the nozzle in this position throughout the entire filling operation.

When the pump cuts out automatically at the end of the filling procedure, a maximum of two further filling attempts may be made so as to leave sufficient room for expansion.

### Petrol versions

Using leaded petrol will damage the antipollution system and may lead to a loss of warranty.

To ensure that the fuel tank is not filled with leaded petrol, the fuel tank filler neck consists of a restrictor fitted with a foolproof system which **only allows a nozzle for unleaded petrol to be used** (at the pump).



### Persistent smell of fuel

If you notice a persistent smell of fuel you should:

- stop the vehicle when traffic conditions allow it and switch off the ignition;
- switch on the hazard warning lights and ask your passengers to leave the vehicle and to keep away from the traffic;
- contact an approved Dealer.



No modifications whatsoever are permitted on any part of the fuel supply system (electronic unit, wiring, fuel circuit, injector, protective covers, etc.) as this may be dangerous (unless undertaken by qualified Network personnel).

## FUEL TANK (3/3)

### Repriming the fuel circuit

After a breakdown caused by completely running out of fuel, the system must be reprimed before the engine is restarted:

The peripheral components (alternator, starter, engine mountings, etc.) should be protected against splashes of fuel.



The engine may be hot when carrying out operations in close proximity. In addition, the engine cooling fan can come on at any moment.

Risk of injury.



### Vehicles with a manual priming bulb

- If fitted to the vehicle, turn the bleed screw located on the diesel filter;
- activate the priming bulb **1** until it hardens and fuel runs in the pipes.

### Vehicles without a manual priming bulb

- Put the ignition key in “On” position **M** (please see the information on the “Ignition switch” in Section 2) and wait for a few minutes before starting, to enable the fuel circuit to be primed;
- turn the key to position **D**. If the engine does not start, repeat the procedure.



# **Section 2: Driving**

## ***(Advice on use relating to fuel economy and the environment)***

Running in . . . . .	2.2
Ignition switch . . . . .	2.2
Starting, stopping the engine. . . . .	2.3
Stop and Start function . . . . .	2.4
Gear lever . . . . .	2.7
Handbrake/Power-assisted steering . . . . .	2.8
Special features of petrol versions . . . . .	2.9
Special features of diesel versions . . . . .	2.10
Driving advice, Eco-driving . . . . .	2.11
Maintenance and antipollution advice . . . . .	2.15
Environment . . . . .	2.16
Tyre pressure loss warning . . . . .	2.17
Tyre pressure loss warning . . . . .	2.22
Driver correction devices/aids . . . . .	2.26
Speed limiter . . . . .	2.31
Cruise control . . . . .	2.34
Parking distance control . . . . .	2.38
Reversing camera . . . . .	2.40
Automatic gearbox. . . . .	2.42

# RUNNING IN/IGNITION SWITCH

## Running in

### Petrol version

For the first **600 miles** (1,000 km) do not exceed 54 mph (90 km/h) in the highest gear.

**After 600 miles (1,000 km)**, you can use your vehicle normally. However, it is only after running 1,800 miles (3,000 km) that you can expect full performance.

**Service intervals:** refer to the Maintenance Document for the vehicle.

### Diesel version

For the first **900 miles** (1,500 km), do not exceed 54 mph (90 km/h). After completing this mileage you may drive faster, however, it is only after 3600 miles (6,000 km) have been covered that you may reasonably expect full performance.

During the running in period, do not accelerate hard while the engine is still cold and do not let the engine over-rev.

**Service intervals:** refer to the Maintenance Document for the vehicle.



## Ignition switch

### Stop and steering lock position St

To lock: remove the key and turn the steering wheel until the steering column locks.

To unlock: turn the key and the steering wheel slightly.

### Accessories position A

When the ignition is switched off, any accessories (radio, etc.) will continue to function.

## Ignition on position M

The ignition is switched on:

- **petrol version:** you can start the vehicle;
- **diesel version:** the engine is preheating.

## Start position D

If the engine fails to start at the first attempt, the key must be turned back before the starter can be activated again. Release the key as soon as the engine starts.

**Note:** on diesel versions, several seconds may pass between turning the key and the engine starting to allow for engine preheating.

In the "Accessories" or "On" position, a system may automatically switch off your vehicle's accessories depending on the battery charge, to prevent it from discharging completely.

# STARTING/STOPPING THE ENGINE



## Starting the engine

### Petrol versions

- Activate the starter **without accelerating**;
- release the key as soon as the engine starts.



### Diesel versions

- Turn the ignition key to the “Ignition on” position **M**, and hold this position until the engine pre-heating light goes off;
- turn the key to starter position **D** **without depressing the accelerator pedal**;
- release the key as soon as the engine starts.

**Special note:** if starting the engine when the outdoor temperature is very low (below - 10 ° C): hold down the clutch pedal until the engine starts.



Never switch off the ignition before the vehicle has stopped completely. Once the engine has stopped, the brake servo, power-assisted steering, etc., and the passive safety devices such as the airbags and pretensioners will no longer operate.

## Stopping the engine

With the engine idling, turn the key to the “Stop” position **St**.



### Driver's responsibility when parking or stopping the vehicle

Never leave an animal, child or adult who is not self-sufficient alone in your vehicle, even for a short time.

They may pose a risk to themselves or to others by starting the engine, activating equipment such as the electric windows or locking the doors, for example.

Also, in hot and/or sunny weather, please remember that the temperature inside the passenger compartment increases very quickly.

**RISK OF DEATH OR SERIOUS INJURY.**

## STOP AND START function (1/3)

This system enables a reduced fuel consumption and lower greenhouse gas emissions.

The system is activated automatically when the vehicle is started.

While driving, the system stops the engine (standby) when the vehicle is at a standstill (traffic jam, traffic lights, etc).

### System operating conditions

Engine standby is activated if:

- the vehicle has been driven since its last stop;
  - the gearbox is in neutral;
  - the clutch pedal is released;
- and
- the vehicle is travelling at less than 3 km/h.



Do not drive off when the engine is on standby (warning light  is displayed on the instrument panel).

Warning light  is displayed on the instrument panel. This notifies you that the engine is on standby.

The vehicle equipment remain operational while the engine is stopped.

The engine will restart as soon as you press the clutch pedal and move into gear.

If you get out of the vehicle, a beep notifies you that the engine is on standby and has not been switched off.



Before getting out of the vehicle, you must switch off the ignition (please see section on “Starting, stopping the engine”).

### Special feature of the automatic engine re-start

Under certain conditions, the engine can restart on its own in order to guarantee your safety and comfort.

This can occur especially when:

- the outdoor temperature is too low or too high (less than around 0 °C or higher than around 30 °C);
- the “Clear View” function is activated if fitted on the vehicle (please see “Automatic Climate Control” in Section 3);
- the battery is not sufficiently charged;
- the vehicle speed is above 7 km/h (downhill slope, etc.);
- repeated pressing on the brake pedal or braking system requirement;
- ...



Engine on standby - braking assistance is no longer operational.



## STOP AND START function (2/3)

### Conditions preventing the standby of the engine

Certain conditions prevent the system from using the engine standby function, including when:

- after having come out of reverse gear;
- the bonnet is not locked;
- the outdoor temperature is too low or too high (less than around 0 °C or higher than around 30 °C);
- the battery is not sufficiently charged;
- the difference between the vehicle interior temperature and the automatic climate control instruction is too high;
- the “Clear View” function is activated if fitted on the vehicle (please see “Automatic Climate Control” in Section 3);

- the engine coolant temperature is too low;
  - automatic particle filter cleaning is underway;
- or
- ...

The warning light  on the instrument panel indicates that the engine is on standby.

With the vehicle stopped, gear lever engaged and clutch pedal depressed, the

warning light  flashes to tell you the engine can be put on standby.

To fill up with fuel, the engine must be stopped (and not on standby): always stop the engine (please see “Starting, stopping the engine”).

### Special cases

In the event of the engine stalling, if the system is operational, press down the clutch pedal as far as it will go to restart.



Deactivate the Stop and Start function for any operation performed in the engine compartment.

## STOP AND START function (3/3)

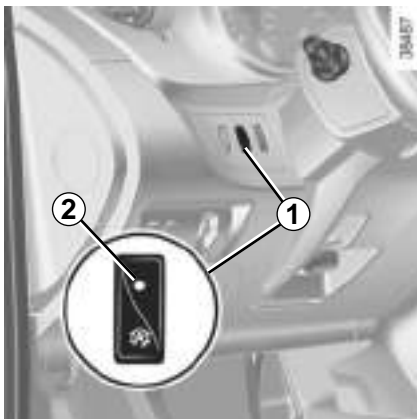

### Deactivating, activating the function

Press **1** to deactivate the function. Warning light **2** in the switch lights up.

Pressing this again will reactivate the system. Warning light **2** in switch **1** goes out.

The system is automatically reactivated each time the vehicle is started (please see section on “Starting, stopping the engine”).



Before getting out of the vehicle, you must switch off the ignition (please see section on “Starting, stopping the engine”).

## GEAR LEVER



### Selecting reverse gear

(vehicle stationary)

**Vehicles with manual gearbox:** follow the grid drawn on knob **1**, and depending on the vehicle, lift ring against the gear lever knob to select reverse.

**Vehicle with automatic gearbox:** refer to the information on the “Automatic gearbox” in Section 2.

The reversing lights will come on as soon as reverse gear is selected (with the ignition on).



An impact to the underside of the vehicle (e.g.: striking a post, raised kerb or other street furniture) may result in damage to the vehicle (e.g.: deformation of an axle).

To avoid any risk of accident, have your vehicle checked by an approved Dealer.

# HANDBRAKE/POWER-ASSISTED STEERING



## Handbrake

### To release:

Pull lever **2** up slightly, press button **1** and then lower the lever to the floor.



Make sure that the handbrake is properly released when driving (red indicator light off), otherwise overheating, or even damage, may occur.

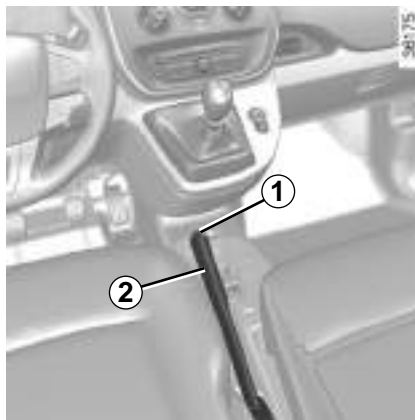

### To apply:

Pull upwards, check that the vehicle is properly immobilised.



When stationary and depending on the slope and/or vehicle load, it may be necessary to pull up the handbrake at least two extra notches and engage a gear (1<sup>st</sup> or reverse gear) for vehicles with a manual gearbox or position **P** for vehicles with an automatic transmission.

## Variable power-assisted steering

The variable power-assisted steering system is equipped with an electronic control system which alters the level of assistance to suit the vehicle speed.

Steering is made easier during parking manoeuvres (for added comfort) while the force needed to steer increases progressively as the speed rises (for enhanced safety at high speeds).



Never switch off the ignition when travelling downhill, and avoid doing so in normal driving (assistance is not provided).

## SPECIAL FEATURES OF PETROL VERSIONS

The following operating conditions should be avoided:

- driving for long periods when the low fuel level warning light is lit;
- using leaded petrol;
- using fuel or lubrication additives which are not approved.

Or operating faults such as:

- faulty ignition, running out of fuel or disconnected spark plugs resulting in the engine misfiring or cutting out when driving;
- loss of power,

may cause the catalytic converter to overheat, reducing its efficiency **which may irreparably damage it and cause heat damage to the vehicle.**

If you notice any of the above operating faults, have the necessary repairs carried out as soon as possible by an approved dealer.

These faults may be avoided by regularly taking your vehicle to an approved Dealer at the intervals specified in the Maintenance Document.

### Starting problems

To avoid damaging the catalytic converter, **do not keep** trying to start the engine (using the start button, or by pushing or towing the vehicle) **without having identified and corrected the cause of the fault.**

If the fault cannot be identified, do not continue to try and start the engine, but contact an approved dealer.





Do not park the vehicle or run the engine in locations where combustible substances or materials such as grass or leaves can come into contact with the hot exhaust system.

## SPECIAL FEATURES OF DIESEL VERSIONS

### Diesel engine speed

Diesel engines are fitted with an injection pump with an electronic regulator **which prevents overrevving of the engine** irrespective of the gear engaged.

If the  and  warning lights come on, consult an approved dealer as soon as possible.

### Running out of fuel

You may start the engine normally after refilling the fuel tank **even if you have completely run out of fuel**, provided that the battery is fully charged.

However, if the engine does not start after a few seconds and several attempts, refer to the information on the "Fuel tank" in Section 1.

### Precautions to be taken in winter

To avoid any faults in icy weather:

- make sure that the battery is always fully charged;
- always keep the diesel tank relatively full to prevent water vapour condensing in it and accumulating at the bottom of the tank.



Do not park the vehicle or run the engine in locations where combustible substances or materials such as grass or leaves can come into contact with the hot exhaust system.

## DRIVING ADVICE, ECO-DRIVING (1/4)

Fuel consumption is accredited in accordance with a standard regulatory method. Identical for all manufacturers, this enables vehicles to be compared with one another. Consumption in real time depends on vehicle usage conditions, the equipment fitted and the user's driving style. To optimise fuel consumption, please refer to the following advice.

Depending on the vehicle, you will have various functions which enable you to lower your fuel consumption:

- the ECO zone of the rev counter;
- gear change indicator;
- the journey record and eco-driving advice via the multimedia display;
- ECO mode – activated by the ECO button.

If fitted on the vehicle, the navigation system provides additional information.

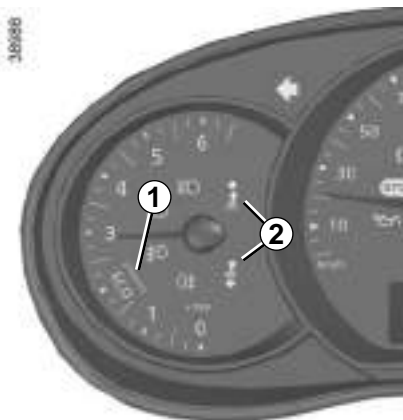



### The ECO zone of the rev counter 1

Driving in the ECO zone helps you optimise fuel consumption.

### Gear change indicator 2

Depending on the vehicle, to obtain optimum consumption levels, a warning light on the instrument panel lets you know the best time to move up or down a gear:

-  move up a gear;
-  move down a gear.

## DRIVING ADVICE, ECO-DRIVING (2/4)



### Journey record

Once the engine is switched off, you will see “Journey record” displayed on the screen **3**, enabling you to view information relating to your last journey.

This indicates:

- average fuel consumption;
- number of miles/kilometres travelled;
- number of miles/kilometres saved.

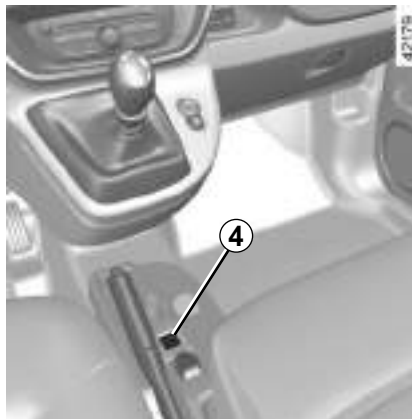

### ECO mode

ECO mode is a function which optimises fuel consumption. It acts upon certain power consuming systems in the vehicle (heating, air conditioning, power-assisted steering, etc.) and on certain driving actions (acceleration, gear changing, cruise control, deceleration, etc.).

### Activating the function

Press switch **4**.

The warning light in the **4** switch lights up.

While driving, it is possible to leave the ECO mode temporarily in order to improve engine performance.

To do this, press the accelerator pedal firmly and fully.

ECO mode is reactivated when you take pressure off the accelerator pedal.

### Disabling the function

Press switch **4**.

The indicator light in the switch **4** goes out.

Depending on the vehicle, the function is active every time the engine is started. A label is attached to the dashboard to notify you.



## DRIVING ADVICE, ECO-DRIVING (3/4)



### Driving advice, Eco-driving

#### Behaviour

- Drive carefully for the first few miles until the engine reaches its normal operating temperature, rather than let it warm up while the vehicle is stationary.
- Speed is expensive.
- Sporty driving uses a lot of fuel: drive with a light right foot.
- Do not overrev the engine in the intermediate gears. You should always use the highest gear possible.

- Avoid sudden acceleration.
- Brake as little as possible. If you anticipate an obstacle or bend in advance, you may then simply release the accelerator pedal.
- Do not try to maintain the same speed up a hill, accelerate no more than you would on the level. Keep your foot in the same position on the accelerator pedal.
- Double declutching and accelerating before switching off are unnecessary in modern vehicles.
- Bad weather, flooded roads:



Do not drive through floods if the water is above the lower edge of the wheel rims.



#### **Obstructions to the driver**

On the driver's side, only use mats adapted to the vehicle that attach to the pre-installed parts, and regularly check their mounting. Do not place several mats on top of each other.

**There is a risk of wedging the pedals**

## DRIVING ADVICE, ECO-DRIVING (4/4)

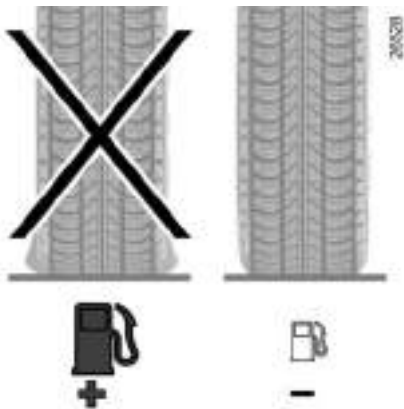

### Tyres

- An underinflated tyre increases fuel consumption.
- The use of non-recommended tyres can increase fuel consumption.



### Advice on use

- Favour ECO mode.
- Electricity is fuel; switch off all the electrical components which are not really needed. **However** (safety first), keep your lights on when the visibility is bad ("see and be seen").
- Use the air vents. Driving with the windows open at 60 mph (100 km/h) will increase fuel consumption by 4%.
- Never fill the fuel tank right to the brim to avoid overflow.

- In vehicles fitted with air conditioning, it is normal to observe an increase in fuel consumption (especially in urban conditions) when it is used. For vehicles fitted with manual air conditioning, switch off the system when it is not required.

### Advice for reducing consumption and therefore helping to preserve the environment:

If the vehicle has been parked in the sun, open the doors for a few moments to let the hot air escape before starting the engine.

- Do not leave an empty roof rack fitted to the vehicle.
- When towing a caravan, fit a wind deflector and adjust it carefully.

# MAINTENANCE AND ANTIPOLLUTION ADVICE

Your vehicle complies with criteria for recycling and recovering vehicles at the end of their service life which will come into force in 2015.

Some parts of your vehicle have therefore been designed to facilitate future recycling.

These parts are easy to remove so that they can be recovered and reprocessed by recycling companies.

By virtue of its design, moderate fuel consumption and initial settings, your vehicle also conforms to current antipollution regulations. The manufacturer is actively striving to reduce pollutant exhaust gas emissions and to save energy. But the fuel consumption of your vehicle and the level of pollutant exhaust gas emissions are also your responsibility. Ensure that it is maintained and used correctly.

## Maintenance

It is important to remember that failure to respect antipollution regulations could lead to legal action being taken against the vehicle owner. In addition, replacing engine, fuel supply system and exhaust components with parts other than those originally recommended by the manufacturer may alter your vehicle so that it no longer complies with antipollution regulations.

Have your vehicle adjusted and checked by an approved Dealer, in accordance with the instructions given in your maintenance schedule: they will have all the equipment necessary for ensuring that your vehicle is maintained to its original standard.

## Engine adjustments

- **Air filter, diesel filter:** a choked element will reduce efficiency. It must be replaced.
- **Idle speed:** this does not require adjustment.

## Exhaust gas monitoring system

The exhaust gas monitoring system will detect any operating faults in the vehicle's antipollution system.

If this system malfunctions, toxic substances may be released into the atmosphere or damage may occur.



This warning light on the instrument panel will indicate if there are any faults in the system:

This light comes on when the ignition is switched on and goes out when the engine is started.

- If it lights up continuously, consult an approved Dealer as soon as possible;
- if it flashes, reduce the engine speed until the light stops flashing. Contact your approved dealer as soon as possible.



Refer to the information on «Additive tank» in Section 1.

## ENVIRONMENT

Your vehicle has been designed with respect for the **environment** in mind for its entire service life: during production, use and at the end of its life. This commitment is illustrated by the Renault eco<sup>2</sup> signature.

### Manufacture

Your vehicle has been manufactured at a factory which complies with a policy to reduce the environmental impact on the surrounding areas (reduction of water and energy consumption, visual and noise pollution, atmospheric emissions and waste water; sorting and re-using waste).

### Emissions

Your vehicle has been designed to emit fewer greenhouse gases (CO<sub>2</sub>) while in use, and therefore to consume less fuel (eg. 140 g/km, equivalent to 5.3 l/100 km for a diesel vehicle).

Our vehicles are also equipped with a particle filter system including a catalytic converter, an oxygen sensor and an active carbon filter (the latter prevents vapour from the fuel tank being released into the open air).

For certain diesel vehicles, this system also has a particle filter to reduce the volume of soot particles emitted.

### Please make your own contribution towards protecting the environment too

- Worn parts replaced in the course of routine vehicle maintenance (vehicle battery, oil filter, air filter, batteries, etc.) and oil containers (empty or filled with used oil) must be disposed of through specialist organisations.

- At the end of the vehicle's service life, it should be sent to approved centres to ensure that it is recycled.
- In all cases, comply with local legislation.

### Recycling

Your vehicle is 85% recyclable and 95% recoverable.

To achieve these objectives, many of the vehicle components have been designed to enable them to be recycled. The materials and structures have been carefully designed to allow these components to be easily removed and reprocessed by specialist companies.

In order to preserve raw material resources, this vehicle incorporates numerous parts made from recycled plastics or renewable materials (vegetable or animal-derived materials such as cotton or wool).

## TYRE PRESSURE LOSS WARNING (1/9)



If fitted on the vehicle, this system warns the driver of pressure loss in one or several tyres.

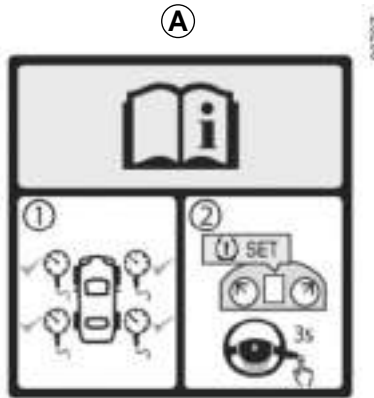

### System identification

There are two tyre pressure loss warning systems:

- **System A:** can be seen on the label **A** in the vehicle. To verify its presence, open the driver's door.
- **System B:** can be seen on the label **A** in the vehicle.

## TYRE PRESSURE LOSS WARNING (2/9)



### SYSTEM A

#### Operating principle

This system detects a loss of pressure in one of the tyres by measuring the wheel speed while driving.

Warning light  1 comes on to alert the driver in the event of insufficient pressure (deflated wheel, punctured tyre, etc.).

#### Operating conditions

The system should be reset with an inflation pressure equal to that given on the tyre inflation pressure label. Otherwise it risks not giving a reliable warning in the event of a significant loss of pressure. Please refer to the information on "Tyre pressures" in Section 4.

In the following situations, the system risk coming into action late or not functioning correctly:

- system not reset after reinflation or any operation on the wheels;
- system badly reset: different inflation pressures from the recommended pressures;
- significant change in load or distribution of load on one side of the vehicle;
- sporty driving with strong acceleration;
- driving on snowy or slippery surface;

- driving with snow chains;
- fitting a single new tyre;
- use of tyres not approved by the network.
- ...



This function is an additional driving aid.

However, the function does not take the place of the driver. It cannot, therefore, under any circumstances replace the vigilance or the responsibility of the driver.

Check the tyre pressures, including the emergency spare wheel, once a month.

# TYRE PRESSURE LOSS WARNING (3/9)

## SYSTEM A (cntd.)

### Resetting the standard level for the tyre pressures

This should be done:

- after each reinflation or readjustment of the pressure of one of the tyres;
- when the standard tyre pressure needs to be changed to adapt to usage conditions (empty, carrying a load, motorway driving, etc.);
- after changing a wheel;
- after using the tyre inflation kit;
- after swapping a wheel (however, this practice is not recommended).

It should always be done after checking the tyre pressure of all four tyres when cold.

Tyre pressures must correspond to the current usage of the vehicle (empty, carrying a load, motorway driving, etc.).

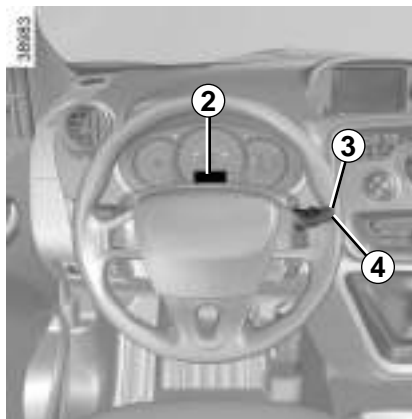

### Resetting procedure

With the ignition on, depending on the vehicle:

- repeatedly press one of the buttons **3** or **4** to select the “TIRES:SET TPW” function on the display **2**;
- press and hold (around 3 seconds) button **3** or **4** to start initialisation. The display of the message “SET TPW LAUNCHED” for around five seconds indicates that the reset request for the tyre pressure reference value has been taken into account.

Or

- repeatedly press the button **3** to select the “SEt tP” function on the display **2**;
- press and hold (around 3 seconds) the button **3** to start initialisation. The flashing, lasting around five seconds, followed by a constant display of the message “SEt tP” indicates that the reset request for the tyre pressure reference value has been taken into account.

Reinitialisation is carried out after a few minutes' driving.

# TYRE PRESSURE LOSS WARNING (4/9)

## SYSTEM A (cntd.)

### Display

The display **2** on the instrument panel informs you of any tyre pressure faults (flat tyre, punctured tyre, etc.).

### INFLATE TIRES AND SET TPW

The warning light  stays on and, depending on the vehicle, along with the message "INFLATE TIRES AND SET TPW".

They indicate that at least one tyre is flat or punctured.

In the event of a flat tyre, inflate the relevant tyre.

In the event of a puncture, change the tyre or consult an authorised dealer.

Check and readjust the pressure of the four tyres when cold, and launch the reinitialisation of the tyre pressure reference value.

Warning light  goes out after launching the reinitialisation of the tyre pressure reference value.

### RECALIBRATE SET TPW

The warning light  flashes for several seconds, then stays on and, depending on the vehicle, together with the message "RECALIBRATE SET TPW".

They indicate that the request to reset the reference value of the tyre pressures must be restarted.

### TPW UNAVAILABLE

The warning light  flashes for several seconds, then stays on and, depending on the vehicle, together with the message "TPW UNAVAILABLE".

They indicate that the vehicle is equipped with an emergency spare wheel which is smaller than the other four and that it is fitted to the vehicle.

The sudden loss of pressure in a tyre (burst tyre, etc.) cannot be detected by the system.

### CHECK TPW

The warning light  flashes for several seconds, then stays on and, depending on the vehicle, together with the message "CHECK TPW".

This message is accompanied by the warning light .

They indicate a system fault. Please consult an authorised dealer.



# TYRE PRESSURE LOSS WARNING (5/9)

## SYSTEM A (cntd.)

### Readjustment of tyre pressures

**The tyre pressures must be adjusted when cold** (please refer to the label located on the edge of the driver's door).

If tyre pressures cannot be checked when the tyres are **cold**, the recommended pressures should be increased by **0.2 to 0.3 bar (3 PSI)**.

### Never deflate a hot tyre.

After each reinflation or readjustment of the tyre pressure, launch the reinitialisation of the tyre pressure reference value.

### Replacing wheels/tyres

Only use equipment approved by the brand network, or the system risks being activated late or not operating correctly. Please see the information on "Tyres" in Section 5.

After each change of wheel/tyre, readjust the tyre pressure and launch the reinitialisation of the tyre pressure reference value.

### Emergency spare wheel

If fitted on the vehicle, readjust the tyre pressure and launch the reinitialisation of the tyre pressure reference value.

### Tyre repair product and inflation kit

Only use equipment approved by the brand network, or the system risks being activated late or not operating correctly. Please refer to "Tyre inflation kit" in Section 5.

After using the tyre inflation kit, readjust the tyre pressure and launch the reinitialisation of the tyre pressure reference value.

## TYRE PRESSURE LOSS WARNING (6/9)



### SYSTEM B

#### Operating principle

Each wheel (except for the emergency spare wheel) has a sensor in the inflation valve which periodically measures the tyre pressure while driving.

Warning light  1 comes on to alert the driver in the event of insufficient pressure (deflated wheel, punctured tyre, etc.).

#### Resetting the standard level for the tyre pressures

This should be done:

- when the standard tyre pressure needs to be changed to adapt to usage conditions (empty, carrying a load, motorway driving, etc.);
- after swapping a wheel (however this practice is not recommended);
- after changing a wheel.

It should always be done after checking the tyre pressure of all four tyres when cold.

Tyre pressures must correspond to the current usage of the vehicle (empty, carrying a load, motorway driving, etc.).



This function is an additional driving aid.

However, the function does not take the place of the driver. It cannot, therefore, under any circumstances replace the vigilance or the responsibility of the driver.

Check the tyre pressures, including the emergency spare wheel, once a month.

## TYRE PRESSURE LOSS WARNING (7/9)

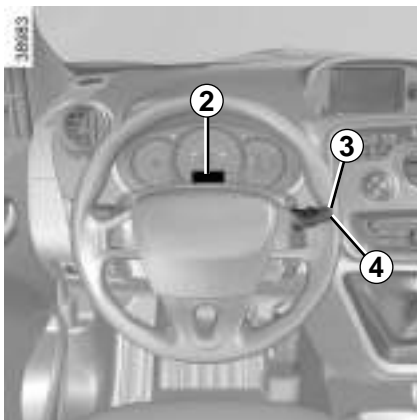

### SYSTEM B (cntd.)

#### Resetting procedure

With the ignition on, depending on the vehicle:

- repeatedly press one of the buttons **3** or **4** to select the “TYRE PRESSURE ACQUISITION” function on the display **2**;
- press and hold (around 3 seconds) button **3** or **4** to start initialisation.

The display of the message “TP ACQUISITION LAUNCHED” for around five seconds indicates that the reset request for the tyre pressure reference value has been taken into account.

Or

- repeatedly press the button **3** to select the “SEt PP” function on the display **2**;
- press and hold (around 3 seconds) the button **3** to start initialisation. The flashing, lasting around five seconds, followed by a constant display of the message “SEt PP” indicates that the reset request for the tyre pressure reference value has been taken into account.

Reinitialisation is carried out after a few minutes' driving.

#### Note:

The standard tyre pressure cannot be less than that recommended and indicated on the door frame.

# TYRE PRESSURE LOSS WARNING (8/9)

## SYSTEM B (cntd.)

### Display

The display **2** on the instrument panel informs you of any tyre pressure faults (flat tyre, punctured tyre, etc.).

### CHECK TYRE PRESSURES

The warning light  stays on and, depending on the vehicle, along with the message “CHECK TYRE PRESSURES”.

These indicate that at least one tyre is flat.

Check and, if necessary, readjust the pressures of the four wheels when cold.

The warning light  goes off after a few minutes' driving.

The sudden loss of pressure in a tyre (burst tyre, etc.) cannot be detected by the system.

## TYRE PUNCTURE

The warning light  stays on together with a beep and, depending on the vehicle, the message “TYRE PUNCTURE”.

This message is accompanied by the warning light .

They indicate that at least one wheel is punctured or severely underinflated. Replace it or contact an authorised dealer if it is punctured. Top up the tyre pressure if the wheel is deflated.



Warning light  requires you to stop immediately, for your own safety, as soon as traffic conditions allow.

## CHECK TYRE SENSORS

The warning light  flashes for several seconds, then stays on and, depending on the vehicle, together with the message “CHECK TYRE SENSORS”.

This message is accompanied by the warning light .

They indicate that at least one tyre is not fitted with sensors (e.g. emergency spare wheel). In other cases, contact an authorised dealer.

# TYRE PRESSURE LOSS WARNING (9/9)

## SYSTEM B (cntd.)

### Readjustment of tyre pressures

**The tyre pressures must be adjusted when cold** (please refer to the label located on the edge of the driver's door). If tyre pressures cannot be checked when the tyres are **cold**, the recommended pressures must be increased by **0.2 to 0.3 bar (3 PSI)**.

**Never deflate a hot tyre.**



### Replacing wheels/tyres

This system requires specific equipment (wheels, tyres, hubcaps, etc.). Please see the information on "Tyres" in Section 5.

Contact an approved Dealer to fit new tyres and to find out about available accessories compatible with the system and available from your dealer network: the use of any other accessory could affect the correct operation of the system or damage a sensor.

### Emergency spare wheel

If the vehicle is equipped with an emergency spare wheel, it will not have a sensor. When it is fitted on the vehicle,

the warning light  flashes for several seconds, then stays on, together with the warning light . Depending on the vehicle, the message "CHECK TYRE SENSORS" appears on the instrument panel.

### Tyre repair product and inflation kit

Because the valves are specially designed, only use equipment approved by the approved network. Please refer to "Tyre inflation kit" in Section 5.

## DRIVING CORRECTION DEVICES AND AIDS (1/5)

Depending on the vehicle, this is composed of:

- the **ABS (anti-lock braking system)**;
- **electronic stability program (ESC) with understeer control and traction control**;
- **emergency brake assist**;
- **grip control**;
- **hill start assistance**.



These functions are an additional aid in the event of critical driving conditions, enabling the vehicle behaviour to be adapted to suit the driving conditions.

The functions do not take the place of the driver. **They do not increase the vehicle's limits and should not encourage you to drive more quickly.** Therefore, they can under no circumstances replace the vigilance or responsibility of the driver when manoeuvring the vehicle (the driver must always be ready for sudden incidents which may occur when driving).

### ABS (anti-lock braking system)



Under heavy braking, the ABS prevents the wheels from locking, allowing the stopping distance to be managed and keeping control of the vehicle.

Under these circumstances, the vehicle can be steered to avoid an obstacle whilst braking. In addition, this system can increase stopping distances, particularly on roads with low surface grip (wet ground etc.).

You will feel a pulsation through the brake pedal each time the system is activated. The ABS does not in any way improve the vehicle's physical performance relating to the road surface and roadholding. It is still **essential** to follow the rules of good driving practice (such as driving at a safe distance from the vehicle in front, etc.).

In an emergency, apply **firm and continuous pressure** to the brake pedal. There is no need to pump it repeatedly. The ABS will modulate the force applied in the braking system.

### Operating faults:

- If the  warning light on the instrument panel comes on while driving, **braking is still operational**;
- If the  and  warning lights on the instrument panel come on when driving, **this indicates a fault with the braking system**.

In such cases, ABS, ESC and emergency brake assist are also deactivated and, depending on the vehicle, the messages "CHECK ABS", "BRAKES TO BE CHECKED" and "CHECK ESC" appear on the instrument panel.

Consult an approved dealer.



Your braking systems are partially operational. However, it is **dangerous to brake suddenly** and it is essential to stop immediately, as soon as traffic conditions allow. Contact an approved dealer.

## DRIVING CORRECTION DEVICES AND AIDS (2/5)

### Electronic stability program ESC with understeer control and traction control

#### Electronic stability control ESC

This system helps you to keep control of the vehicle in critical driving conditions (avoiding an obstacle, loss of grip on a bend, etc.).

#### Operating principle

A sensor in the steering wheel detects the direction selected by the driver.

Other sensors throughout the vehicle measure the actual direction.

The system compares driver input to the actual trajectory of the vehicle and corrects the trajectory if necessary by controlling the braking of certain wheels and/or engine power. In the event that the system is engaged, indicator light



flashes on the instrument panel.

#### Understeer control

This system optimises the action of the ESC in the case of pronounced understeer (loss of front axle road holding).

#### Traction control

This system helps to limit wheelspin of the drive wheels and to control the vehicle when pulling away accelerating or decelerating.

#### Operating principle

Using the wheel sensors, the system measures and compares the speed of the drive wheels at all times and slows down their over-rotation. If a wheel is starting to slip, the system brakes automatically until the drive supplied becomes compatible with the level of grip under the wheel again.

The system also adjusts the engine speed to the grip available under the wheels, independently of the pressure exerted on the accelerator pedal.

#### Operating faults

When the system detects an operating fault the message "CHECK ESC" and warning light  appear on the instrument panel. In this case, the ESC and traction control system are deactivated.

Consult an approved dealer.

## DRIVING CORRECTION DEVICES AND AIDS (3/5)

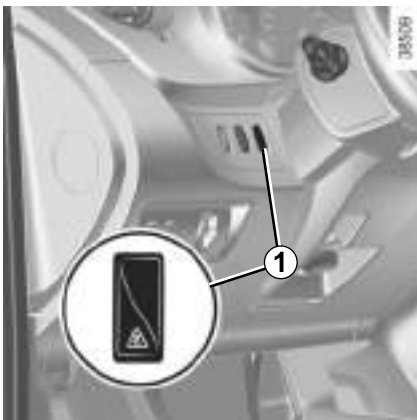

### Disabling the traction control system

(depending on vehicle)

In some situations (driving on very wet ground: snow, mud, etc. or driving with snow chains fitted), the system may reduce the engine output to limit wheel-spin. If this is not required, it is possible to deactivate the function by pressing switch **1**.

The message “TRACTION CONTROL OFF” is displayed on the instrument panel to inform you.

The traction control system offers additional safety. It is recommended that you do not drive with the function disabled. Correct this as soon as possible by pressing the switch **1** again.

**Note:** The function is reactivated automatically when the ignition is switched on or when a speed of approximately 24 mph (40 km/h) is exceeded.

### Emergency brake assist

This is an additional system to ABS which helps reduce vehicle stopping distances.

#### Operating principle

The system detects an emergency braking situation. In this case, the braking assistance immediately develops maximum power and may trigger ABS regulation.

ABS braking is maintained as long as the brake pedal is not released.

### Hazard warning lights switching on

Depending on the vehicle, these may light up in the event of sudden deceleration.

#### Operating faults

When the system detects an operating fault the message “BRAKING FAULT” appears on the instrument panel along with the  warning light.

Consult an approved dealer.

#### Braking anticipation

Depending on the vehicle, when you rapidly release the accelerator, the system anticipates the braking manoeuvre in order to reduce stopping distances.

#### Special cases

When using the cruise control:

- if you use the accelerator, when you release it, the system may be triggered;
- if you do not use the accelerator, the system will not be triggered.



## DRIVING CORRECTION DEVICES AND AIDS (4/5)

### Grip control

If fitted on the vehicle, grip control makes it easier to control the vehicle on low grip surfaces (soft ground, etc.).



#### Tyres

When they need to be replaced, only tyres of the same make, size, type and profile should be used.

**Tyres fitted to the vehicle should either be identical to those fitted originally or conform to those recommended by your approved dealer.**

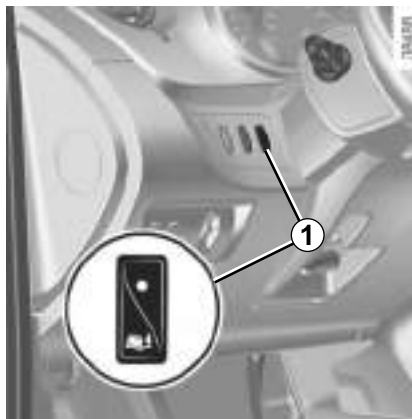

#### “Road” mode

Upon starting up the vehicle, the “STANDARD HIGHWAY MODE” message is displayed on the instrument panel. The warning light on the switch **1** goes out.

This position enables optimal usage under normal driving conditions (dryness, humidity, light snow, etc.). “Road” mode uses traction control functions.

#### “Soft ground” mode

Press the switch **1**: the integrated warning light **1** comes on, along with the instrument panel message “VARIABLE HIGHWAY MODE”.

This position enables optimal usage on soft ground (mud, sand, dead leaves, etc.). In this position, engine speed is left under the driver’s control. The system automatically switches to “Road” mode at speeds above 30 mph (50 km/h), and the warning light on button **1** goes out.

## DRIVING CORRECTION DEVICES AND AIDS (5/5)

### Hill start assistance

This function assists the driver when starting on hills. It prevents the vehicle from rolling backwards, depending on the slope, by automatically applying the brakes when the driver lifts his/her foot off the brake pedal to depress the accelerator pedal.

### System operation

It only operates when the gear lever is in a position other than neutral and the vehicle is completely stationary (brake pedal depressed).

The system holds the vehicle for approximately **2 seconds**. The brakes are then gradually released (the vehicle will move according to the slope).



The hill start assistance system cannot completely prevent the vehicle from rolling backwards in all situations (extremely steep gradients, etc.).

In all cases, the driver may depress the brake pedal to prevent the vehicle from rolling forwards or backwards.

The hill start assistance function should not be used for prolonged stops: use the brake pedal.

This function is not designed to immobilise the vehicle permanently.

If necessary, use the brake pedal to stop the vehicle.

The driver must remain particularly vigilant when driving on slippery or low-grip surfaces and/or on hills.

Risk of serious injury.

## SPEED LIMITER (1/3)



The speed limiter function helps you stay within the driving speed limit that you choose, known as the **limit speed**.

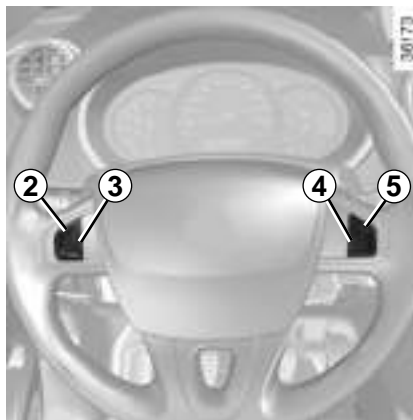



### Controls

- 1 Main “On/Off” switch.
- 2 Limit speed activation, storage and increase switch (+).
- 3 Decreasing the limit speed (-).
- 4 Speed limiter function standby (with limited speed memory) (O).
- 5 Activation and recall of memorised limited speed (R).



### Switching on

Press the side switch **1** . Warning light  comes on, lit orange, and the “SPEED LIMITER” message appears on the instrument panel, accompanied by dashes to indicate that the speed limiter function is activated and waiting to store a limit speed.

To store the current speed, press switch **2** (+): The limit speed will replace the dashes.

The minimum stored speed is 20 mph (30 km/h).

## SPEED LIMITER (2/3)

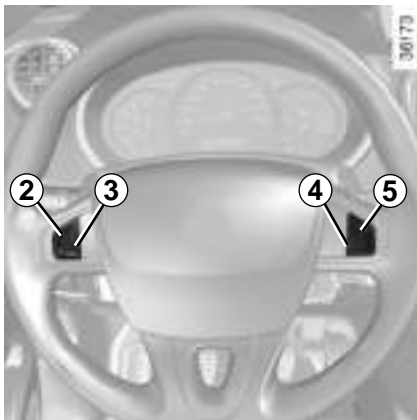

### Driving

When a limited speed has been stored and this speed is not reached, driving is similar to driving a vehicle without the speed limiter function.

Once you have reached the stored speed, no effort on the accelerator pedal will allow you to exceed the programmed speed except in an emergency (refer to information on “Exceeding the limit speed”).

### Varying the limit speed

The limit speed may be changed by repeatedly pressing:

- switch **2** (+) to increase the speed;
- switch **3** (-) to decrease the speed.

### Exceeding the limit speed

It is possible to exceed the limit speed at any moment. To do this: press the accelerator pedal **firmly and fully** (beyond the kickdown point).

Whilst the speed is being exceeded, the cruising speed displayed on the instrument panel flashes.

Then, release the accelerator pedal: the speed limiter function will return as soon as you reach a speed lower than the stored speed.

### Limited speed cannot be maintained

When driving down a steep gradient, the system is unable to maintain the limit speed: the stored speed will flash on the instrument panel information display to inform you of this situation.



The speed limiter function is in no way linked to the braking system.

## SPEED LIMITER (3/3)



### Putting the function on standby

The speed limiter function is suspended when you press switch **4** (O). In this case, the limited speed remains stored and the “SPEED MEMORY” message accompanied by this speed appears on the instrument panel.

### Recalling the limit speed

If a speed has been stored, it can be recalled by pressing switch **5** (R).



### Switching off the function

The speed limiter function is interrupted when you press switch **1**. In this case, the speed is no longer stored. The instrument panel orange indicator light  goes out to confirm that the function is deactivated.

When the speed limiter is put on standby, pressing switch **2** (+) reactivates the function without taking into account the stored speed: it is the speed at which the vehicle is moving that is taken into account.

## CRUISE CONTROL (1/4)

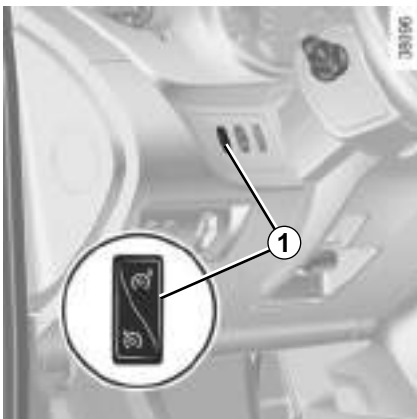

The cruise control function helps you to maintain your driving speed at a speed that you choose, called the **cruising speed**.

This cruising speed may be set at any speed above 20 mph (30 km/h).



The cruise control function is in no way linked to the braking system.



This function is an additional driving aid. The function does not take the place of the driver.

Therefore, it can under no circumstances replace the driver's responsibility to respect speed limits and to be vigilant (the driver must always be ready to brake).

Cruise control must not be used in heavy traffic, on undulating or slippery roads (black ice, aquaplaning, gravel) and during bad weather (fog, rain, side winds etc.).

There is a risk of accidents.

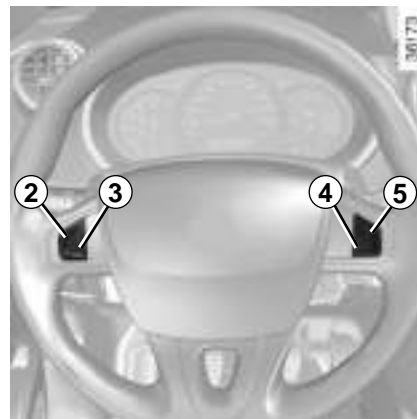

### Controls

- 1 Main "On/Off" switch.
- 2 Cruising speed activation, storage and increase switch (+).
- 3 Decreasing cruising speed (-).
- 4 Switch the function to standby (with cruising speed saved) (O).
- 5 Activation with recall of saved cruising speed (R).

## CRUISE CONTROL (2/4)



### Switching on

Press switch **1** on the side showing . Indicator light **6** comes on, lit green, and the message "CRUISE CONTROL" appears on the instrument panel, accompanied by dashes to indicate that the cruise control function is activated and waiting to store a cruising speed.



### Activating cruise control

At a steady speed (above 18 mph (30 km/h approximately)) press switch **2** or (+): the function is activated and the current speed is saved. The cruising speed replaces the dashes and the cruise control is confirmed by the appearance of a message on the instrument panel and indicator light **7** lit green, as well as indicator light **6**.

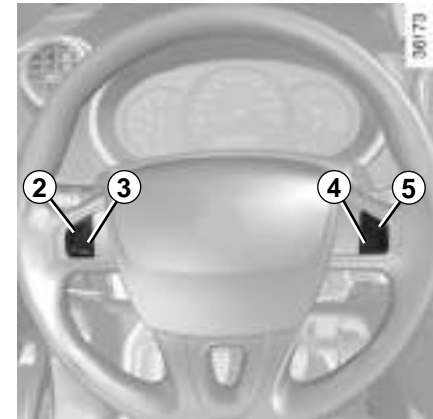

### Driving

Once a cruising speed is memorised and the cruise control function is active, you may lift your foot off the accelerator pedal.



Please note that you must keep your feet close to the pedals in order to react in an emergency.

## CRUISE CONTROL (3/4)

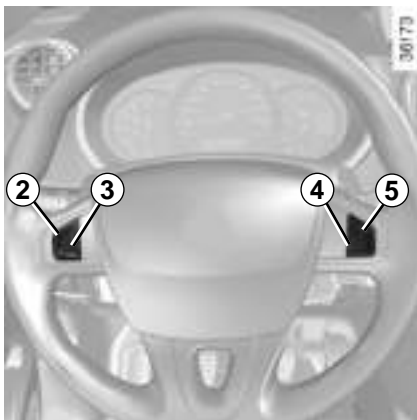

### Adjusting the cruising speed

The cruising speed may be changed by pressing the following repeatedly:

- switch **2 (+)** to increase the speed,
- switch **3 (-)** to decrease the speed.



The cruise control function is in no way linked to the braking system.

### Exceeding the cruising speed

The cruising speed may be exceeded at any time by depressing the accelerator pedal. While it is being exceeded, the cruising speed flashes on the instrument panel.

Then, release the accelerator: after a few seconds, the vehicle will automatically return to its set cruising speed.

### Cruising speed cannot be maintained

When driving down a steep gradient, the system is unable to maintain the cruising speed: the stored speed will flash on the instrument panel information display to inform you of this situation.



## CRUISE CONTROL (4/4)

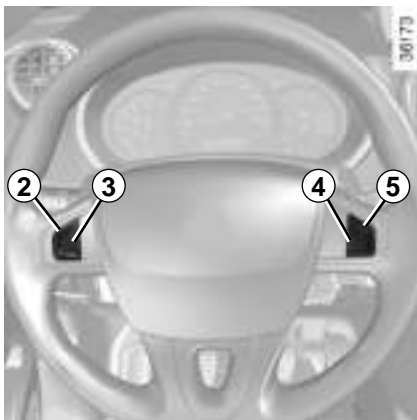

### Putting the function on standby

The function is set to standby if you:

- the brake pedal;
- depress the clutch pedal or shift into neutral if the vehicle has an automatic gearbox;
- press switch **4** (O).

In all three cases, the cruising speed is stored.

Standby is confirmed when the green  warning light goes out and the "SPEED MEMORY" message appears on the instrument panel.

### Recalling the cruising speed



If a speed has been stored, it is possible to recall it by pressing button **5** (R), on condition that you are driving faster than 20 mph (30 km/h) and that you are sure that the road conditions are suitable (traffic, road surface condition, weather conditions, etc.).

**Note:** if the speed previously stored is much higher than the current speed, the vehicle will accelerate more rapidly to reach this threshold.



### Switching off the function

The cruise control function is deactivated if you press switch **1**: in this case a speed is no longer stored.

The green  and  indicator lights on the instrument panel go out, confirming that the function is deactivated.

When the cruise control is on standby, pressing the (+) buttons **2** reactivates the cruise control function without taking into account the stored speed: it is the speed at which the vehicle is moving that is taken into account.



Putting the cruise control on standby or switching it off does not cause a rapid reduction in speed: you must brake by depressing the brake pedal.

## PARKING DISTANCE CONTROL (1/2)

### Operating principle

Ultrasonic sensors in the rear bumper measure the distance between the vehicle and an obstacle.

This measurement is indicated by beeps which become more frequent the closer you come to the obstacle, until they become a continuous beep when the vehicle is approximately 30 centimetres from the obstacle.

**Note:** make sure that the ultrasonic sensors are not obscured (by dirt, mud, snow, condensation etc.).



**Note:** depending on the vehicle, the screen 1 shows the vehicle surroundings alongside the beeps.



### Operation

When reverse gear is selected, most objects which are less than approximately 1.20 metres from the rear of the vehicle are detected, a beep sounds and, depending on the vehicle, the display 1 comes on.



This function is an additional aid that indicates the distance between the vehicle and an obstacle whilst reversing, using sound signals.

Under no circumstances should it replace the driver's care or responsibility whilst reversing.

The driver should always be ready for sudden incidents while driving: always ensure that there are no small, narrow moving obstacles (such as a child, animal, pushchair, bicycle, stone, post, etc.) in the blind spot when manoeuvring.

## PARKING DISTANCE CONTROL (2/2)



### Temporary deactivation of the system

(depending on vehicle)

Press switch **2** to deactivate the system:

The indicator light built into the switch lights up to remind you that the system is deactivated.

Pressing the switch again will reactivate the system and switch off the indicator light.

The system is automatically reactivated after the ignition is switched off and the engine restarted.

### Prolonged deactivation of the system

You can deactivate the system permanently by pressing and holding switch **2**.

The warning light built into the switch remains lit constantly.

Pressing the switch again will reactivate the system and switch off the indicator light.



In the event of an impact to the underside of the vehicle (e.g. striking a post, raised kerb or other street furniture) this may result in damage to the vehicle (e.g. twisted axle), the electrical circuit or the traction battery.

To avoid any risk of accident, have your vehicle checked by an approved dealer.

### Operating faults

When the system detects an operating fault, a beep sounds for about 3 seconds as a warning. Consult an approved dealer

## REVERSING CAMERA (1/2)

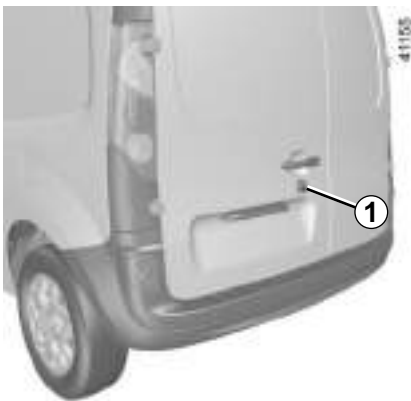

### Operation

Moving into reverse gear, the camera **1** located on the rear hinged door provides a view of the area behind the vehicle on the rear-view mirror **2** or, depending on the vehicle, on the multimedia display **3**, accompanied by one or two (moving and fixed) guide lines **4** and **5**.



**Note:** make sure that the reversing camera is not obscured (by dirt, mud, snow, condensation, etc.).



**NB:** Depending on the vehicle, you can adjust certain settings from the multimedia display **3**. Refer to the handbook for the equipment.



This function is an additional aid. It cannot, therefore, under any circumstances replace the vigilance or the responsibility of the driver.

The driver should always be ready for sudden incidents while driving: always ensure that there are no small, narrow moving obstacles (such as a child, animal, pushchair, bicycle, stone, post, etc.) in the blind spot when manoeuvring.

## REVERSING CAMERA (2/2)

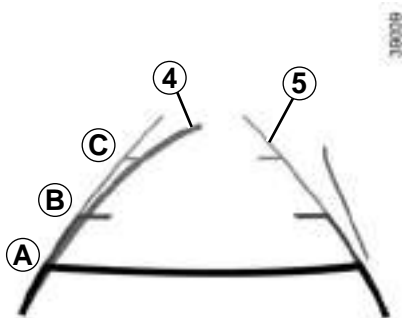

### Dynamic gauge 4 (depending on the vehicle)

This is shown in blue on the multimedia display 3. It indicates the vehicle trajectory according to the position of the steering wheel.

### Static guide line 5:

The fixed clearance gauge comprises coloured markers **A**, **B** and **C**, indicating the distance behind the vehicle:

- **A** (red) approximately 30 centimetres from the vehicle;
- **B** (yellow) approximately 70 centimetres from the vehicle;
- **C** (green) approximately 150 centimetres from the vehicle.

This gauge remains fixed and indicates the vehicle trajectory if the wheels are in line with the vehicle.

This system is initially used with the aid of several gauges (mobile for trajectory and fixed for distance). When the red zone is reached, use the bumper image to stop accurately.

The screen shows a reverse image.

The frames are a representation projected onto flat ground; this information must not be taken into account when superimposed on a vertical object or an object on the ground.

Objects which appear on the edge of the screen may be deformed.

In very bright light (snow, vehicle in sunshine etc.), the camera vision may be adversely affected.

If the rear doors are open or poorly closed, the camera display disappears and, depending on the vehicle, the message "BOOT OPEN" appears.

## AUTOMATIC GEARBOX (1/3)

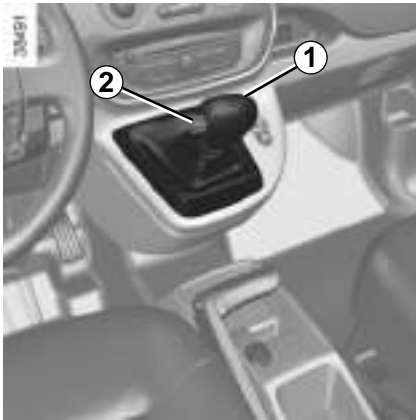

### Selector lever 1

Display **A** on the instrument panel shows the mode and gear selected.

**P**: park

**R**: reverse

**N**: neutral

**D**: automatic mode (in forwards gear only)

**3** : displays the gear engaged in manual mode.



### Operation

With the selection lever **1** in position **P**, switch on the ignition.

To move out of position **P**, you must depress the brake pedal before pressing the unlocking button **2**.

With your foot on the brake pedal (warning light  **4** on the display goes out), move the lever out of position **P**.

**Only engage D or R when the vehicle is stopped, with your foot on the brake and the accelerator pedal released.**

**Note:** depending on the vehicle, when the selector lever **1** is in a position other than **P**, display **3** of the gear selected flashes. Starting is impossible. Move the lever **1** to position **P**, switch on the ignition.



An impact to the underside of the vehicle (e.g.: striking a post, raised kerb or other street furniture) may result in damage to the vehicle (e.g.: deformation of an axle).

To avoid any risk of accident, have your vehicle checked by an approved dealer.

## AUTOMATIC GEARBOX (2/3)

### Driving in automatic mode

Move lever **1** to position **D**.

In most traffic conditions, you will not have to touch the gear selector lever again: the gears will change automatically at the right time and at the most suitable engine speed because the automatic system takes into account the vehicle load and road contour and adjusts itself to the particular driving style you have chosen.

### Accelerating and overtaking

Depress the accelerator pedal firmly and fully (so that it goes beyond the kickdown point).

**This will enable you to change down to the optimum gear within the engine range.**

### Driving in manual mode

With the selector lever **1** in position **D**, move the lever to the left. Shifting the lever repeatedly allows you to change gears manually:

- To move down through the gears, push the lever backwards;
- To move up through the gears, push the lever forwards.

The gear selected is displayed on the instrument panel.

### Special cases

Under certain driving conditions (e.g. engine protection, electronic stability program (ESP) operational etc.: ESC) the automatic system may change gear automatically.

Likewise, to prevent incorrect manoeuvres, a gear change may be refused by the automatic system: in this case the gear display flashes for a few seconds as a warning.



### Economical driving

When driving, leave the lever in position **D**, keeping the accelerator pedal lightly depressed to ensure automatic gear changes at comparatively low engine speeds.

## AUTOMATIC GEARBOX (3/3)

### Operating faults

- **When driving**, if the “CHECK GEARBOX” message and the  warning light appear on the instrument panel, this indicates a fault.

Contact your approved Dealer as soon as possible.

- **When driving**, if the message “GEARBOX OVERHEATING” appears on the instrument panel, drive at a moderate speed and avoid leaving the gearstick in the **D** (or **R**) position, where traffic conditions allow: always return to **N** while the vehicle is stationary.

Contact your approved Dealer as soon as possible.

- **If a vehicle with an automatic gearbox breaks down**, refer to the information on “Towing” in Section 5.

### Special circumstances

- **If the bends and road surface** do not allow you to stay in automatic mode (eg. in the mountains), we recommend that you change to manual mode.

This will prevent the automatic gearbox from changing gear repeatedly when climbing, and permit engine braking on long descents.

- **In cold weather**, start the engine and wait a few seconds before moving the selector lever from position **P** or **N** and engaging it in **D** or **R** to prevent the engine stalling..

### Parking the vehicle

When the vehicle is stopped, move the lever to position **P** while keeping your foot on the brake pedal: the gearbox is in neutral and the drive wheels are mechanically locked by the driveshaft.

#### **Apply the handbrake.**



## Section 3: Your comfort

Air vents: air outlets . . . . .	3.2
Heating/air conditioning . . . . .	3.4
Automatic climate control . . . . .	3.7
Air conditioning: information and advice on use . . . . .	3.15
Interior lighting . . . . .	3.17
Sun visor/Mirrors . . . . .	3.19
Electric windows . . . . .	3.20
Half-opening window . . . . .	3.21
Manual sunroof . . . . .	3.22
Ashtray/cigar lighter/accessories sockets . . . . .	3.23
Passenger compartment storage/ fittings . . . . .	3.24
Rear bench seat . . . . .	3.29
Transporting objects . . . . .	3.31
in the boot . . . . .	3.31
Towbar . . . . .	3.32
Luggage cover . . . . .	3.33
Luggage net . . . . .	3.34
Roof bars . . . . .	3.35
Multimedia equipment . . . . .	3.37

## AIR VENTS: air outlets (1/2)

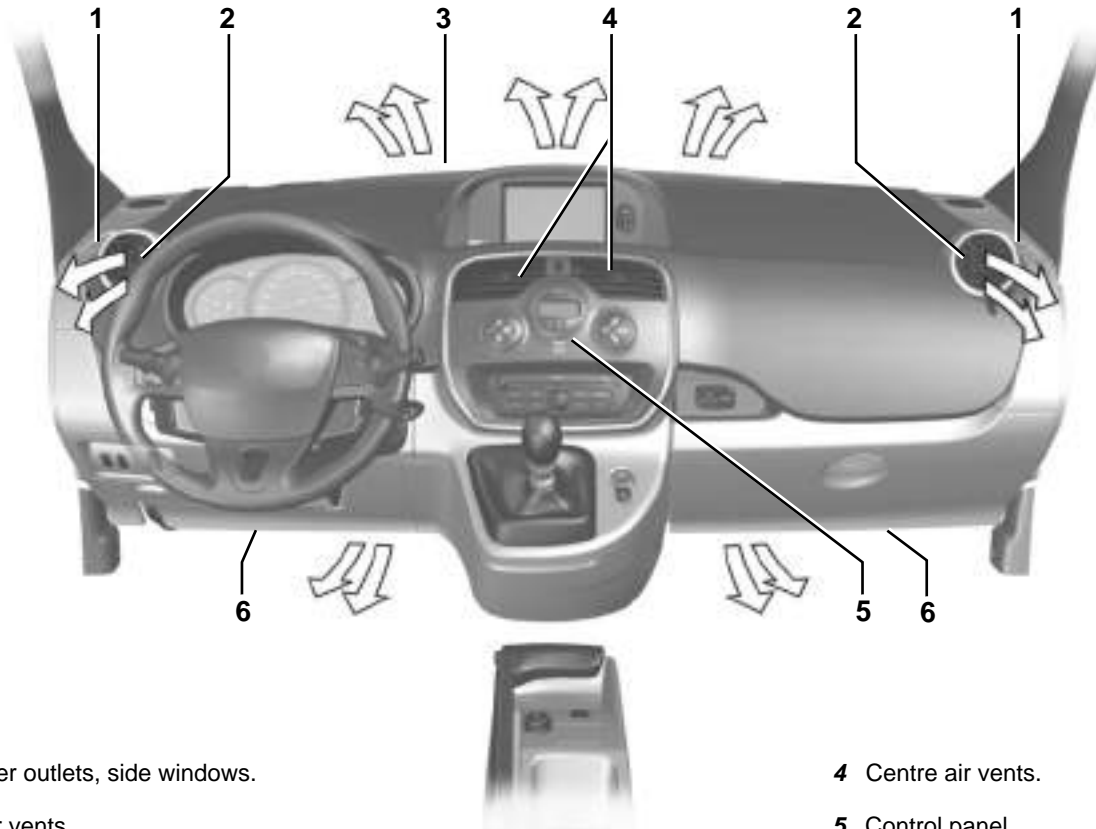

1 Demister outlets, side windows.

2 Side air vents.

3 Demisting outlets for the windscreen.

4 Centre air vents.

5 Control panel.

6 Footwell air vents.

## AIR VENTS: air outlets (2/2)

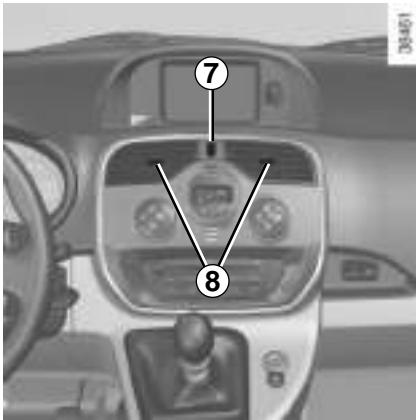

### Centre air vents

#### Settings

##### Air flow:

Move control knob **7** (beyond the point of resistance).

##### Air distribution:

Right/left: move tabs **8**.

Up/down: guide the air vent up or down.

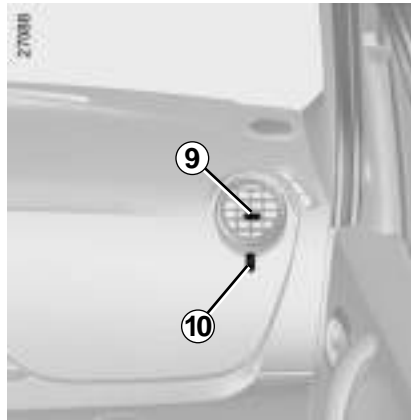

### Side air vents

#### Settings

##### Air flow:

Move control knob **10** (beyond the point of resistance).

##### Air distribution:

Right/left: move tab **9**.

Up/down: guide the air vent up or down.

To remove bad odours from your vehicles, only use the systems designed for this purpose. Consult an approved Dealer.



Do not add anything to the vehicle's ventilation circuit (for example, to remove bad odours).

**There is a risk of damage or of fire.**

## HEATING/AIR CONDITIONING (1/3)

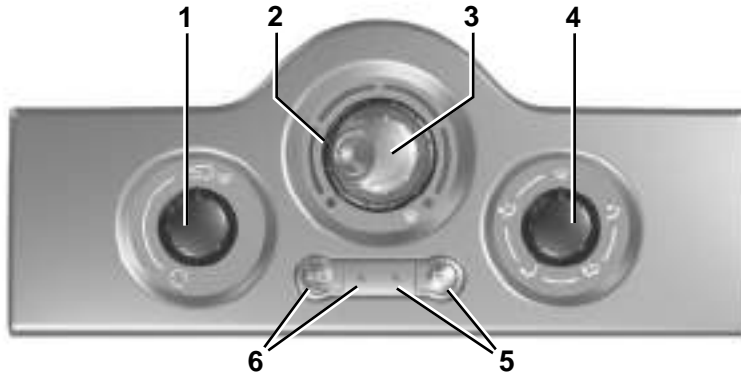

### The controls

- 1 - Air recirculation control.
- 2 - Adjusting the air temperature.
- 3 - Adjusting the ventilation speed.
- 4 - Adjusting the distribution of air in the passenger compartment.

- 5 - Heated rear screen and heated door mirror de-icing/demisting control and indicator light.
- 6 - Air conditioning control and operating indicator light (depending on vehicle).

### Information and advice for use:

Refer to information on “Air conditioning: information and advice on use”.

### Switching air conditioning on or off

The air conditioning is switched on (indicator light illuminated) or off (indicator light extinguished) using button **6**.

### The air conditioning system is used for:

- lowering the temperature inside the passenger compartment;
- eliminating condensation more quickly.

The air conditioning does not operate when the exterior temperature is low.

### Adjusting the air temperature

Turn control **2** to obtain the desired temperature. The further towards the red the slide is, the higher the temperature will be.

When the air conditioning system is used for long periods, it may begin to feel cold. To increase the temperature, turn control **2** to the right.

## HEATING/AIR CONDITIONING (2/3)



### Distribution of air in the passenger compartment

Turn control **4** so that the pointer is positioned opposite the marked positions.



The air flow is directed to the windscreen demisting vents and the side windows. This position prevents the formation of condensation.



The air flow is directed to the windscreen demisting vents, the side windows and the passenger footwells.

This is the recommended position for the best temperature in cold weather.



The air flow is directed mainly towards the footwells.



The air flow is directed to all air vents and the footwells.

This is the recommended position for the best temperature in hot weather.



The air flow is directed mainly to the dashboard vents. This position allows the passenger compartment to be heated or cooled more quickly.

### Rapid demisting

Turn the controls to the positions marked as :

- air from the outside;
- maximum temperature;
- demisting.

Using the climate control increases the speed of demisting.

## HEATING/AIR CONDITIONING (3/3)

### Adjusting the ventilation speed

#### Normal use

Turn control **3** to one of the four positions to start the ventilation system and adjust the power.

Select position 1 for minimum ventilation and position 4 for maximum ventilation.

#### Position 0

In this position:

- the air conditioning stops automatically even if button **6** is activated (the indicator light remains lit);
- the ventilation speed of air in the passenger compartment is zero;
- there is, however, a slight flow of air when the vehicle is moving.

This position should not normally be used.

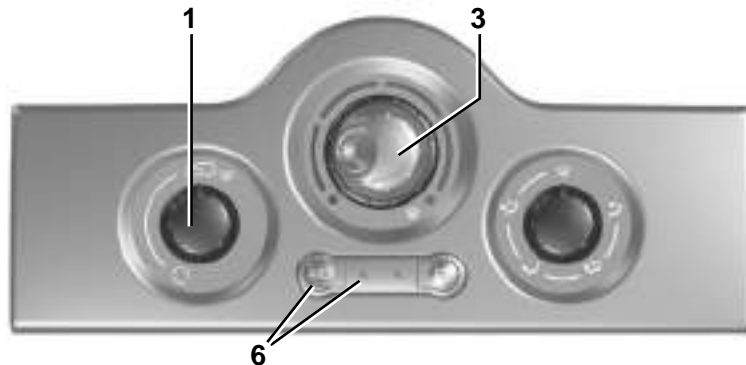

### Air recirculation (isolation of the passenger compartment)

Turn control **1** towards air recirculation symbol .

In these conditions air is taken from the passenger compartment and is recirculated, with no air being taken from outside the vehicle.

#### Air recirculation is for:

- isolating the passenger compartment from the outside air (driving in polluted areas, unpleasant odours, etc.);
- bringing the passenger compartment to the desired temperature as quickly as possible.

Prolonged use of this position can lead to condensation forming on the side windows and windscreen and problems due to the use of non-renewed air in the passenger compartment.

We therefore advise you to return to normal mode (outside air) as soon as the air recirculation function is no longer required, by turning control **1** again.

## AUTOMATIC CLIMATE CONTROL (1/8)

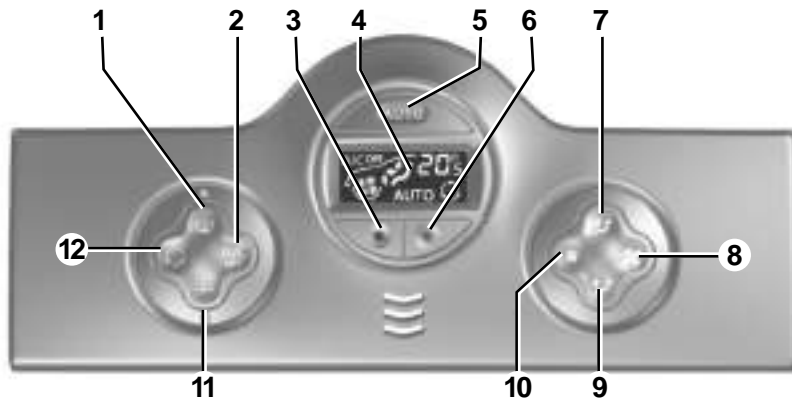

### Controls (depending on vehicle)

- 1 - Clear View button to demist and de ice the windows.
- 2 - Switching off air conditioning.
- 3 and 6 - Adjusting the air temperature.
- 4 - Display.
- 5 - Switching on automatic mode.
- 7 and 9 - Passenger compartment air distribution adjustment.

8 and 10 - Adjusting the ventilation speed.

11 - Heated rear screen and heated door mirror de-icing.

12 - Air recirculation control.

### Information and advice for use

Refer to information on “Air conditioning: information and advice on use”.

## AUTOMATIC CLIMATE CONTROL (2/8)

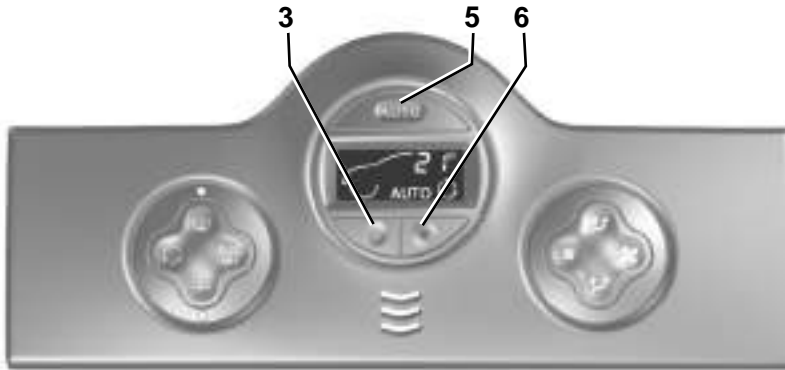

### Automatic mode

Press button **5**. The AUTO operating tell-tale will come on.

The automatic climate control system guarantees comfort in the passenger compartment and good visibility (except in the event of extreme conditions), while optimising fuel consumption.

**This is the recommended mode of use.**

To reach and keep the chosen comfort level and to maintain good visibility, the system controls:

- ventilation speed;
- air distribution;
- air recirculation management;
- air conditioning start/stop;
- the air temperature.

**Only the temperature and the AUTO symbol are displayed**

Functions managed in automatic mode are not displayed.

- press button **6** to increase the temperature;
- press button **3** to decrease the temperature.

**Note:** The maximum and minimum settings of 15°C and 27°C allow the system to produce a minimum or maximum temperature, whatever the ambient conditions.

In automatic mode (AUTO indicator light on the display is lit), all air conditioning functions are controlled by the system.

When you modify certain functions the AUTO indicator light goes out. Only the modified function stops being controlled by the system.



The displayed temperature values show a comfort level.

When starting the engine, increasing or decreasing the value displayed will not allow the comfort level to be reached any more quickly. The system will always optimise the temperature increase or decrease (the ventilation system does not start instantly at maximum speed: it gradually increases). This may take several minutes.

Generally speaking, unless there is a particular reason not to, the dashboard air vents should remain open.

### Adjusting automatic mode

The system normally operates in automatic mode but you can alter the standard settings used by the system (air distribution, etc.). These options are explained on the following pages.

#### **Automatic mode is the recommended mode of use**

The automatic climate control system guarantees comfort in the passenger compartment and good visibility (except in the event of extreme conditions), while optimising consumption.

The types of adjustments that can be made are described in the following pages.

Return to automatic mode as soon as possible.

## AUTOMATIC CLIMATE CONTROL (4/8)

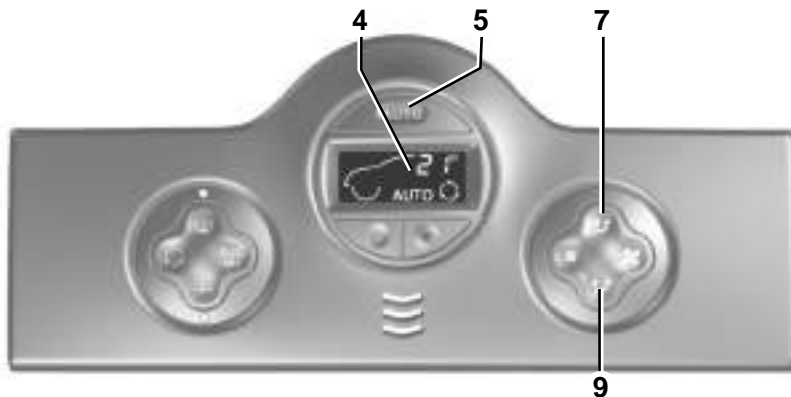

### Distribution of air in the passenger compartment

There are five possible combinations for air distribution, which may be selected by pressing buttons **7** and **9** repeatedly. The arrows on display **4** indicate the setting selected:



The air flow is directed to the windscreen demisting vents and the side windows.



The air flow is directed to the windscreen demisting vents, the side windows and the passenger footwells.



The air flow is directed mainly to the dashboard air vents. This position allows the passenger compartment to be heated or cooled more quickly.



The air flow is directed to all the windscreen demisting vents and the passenger footwells.



The air flow is directed mainly towards the passenger footwells.

The manual air distribution option causes the operating tell-tale light on display **4** to go out (automatic mode), but only air distribution is no longer controlled automatically by the system.

Press button **5** to return to automatic mode.

## AUTOMATIC CLIMATE CONTROL (5/8)

### Varying the ventilation speed

In automatic mode, the system uses the most suitable amount of air to reach and maintain the desired comfort level.

Automatic mode is switched off by pressing buttons **8** and **10**.

These buttons allow you to increase or decrease ventilation speed.

### Switching air conditioning on or off

In automatic mode, the system switches the air conditioning system on or off, depending on the climate conditions.

Exit automatic mode by pressing button **2**: the AUTO warning light on display **4** goes out.

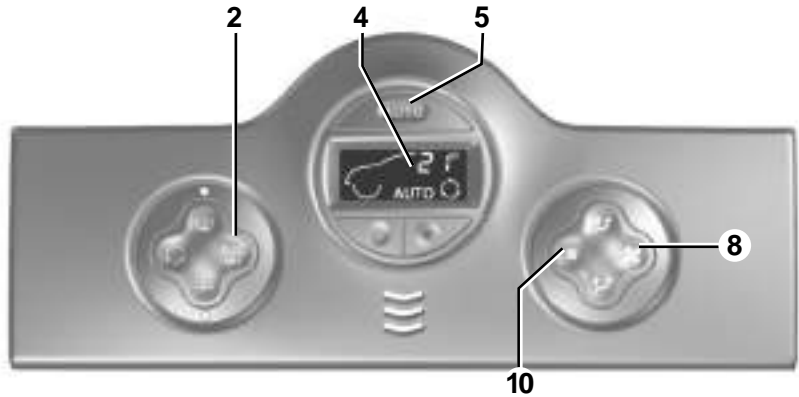

**Note:** the “Clear View” function automatically activates the air conditioning. Press button **5** to return to automatic mode.

In automatic mode, depending on the outside air conditions, the ventilation may not start immediately at maximum power but will increase progressively until the engine temperature is warm enough to heat the passenger compartment air. This may take from a few seconds to several minutes.

## AUTOMATIC CLIMATE CONTROL (6/8)

30840



### Rear screen de-icing/ demisting

Press button **11**.

This function allows rapid electric demisting of the rear screen and, depending on the vehicle, electric de-icing of the door mirrors.

**To exit this function**, press button **11** again. Demisting automatically stops by default.

## AUTOMATIC CLIMATE CONTROL (7/8)

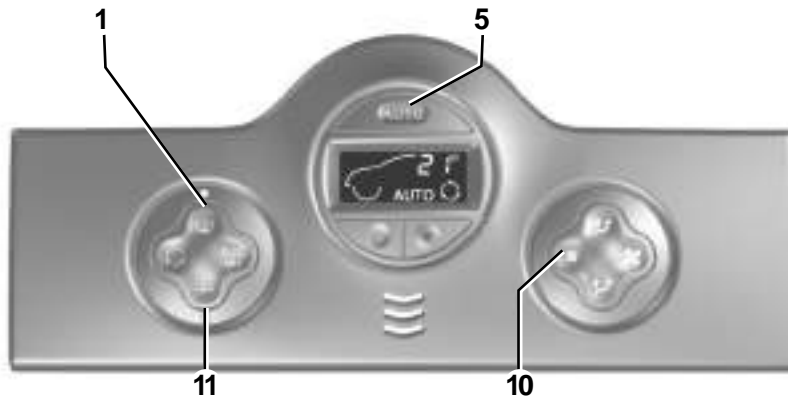

### Clear View function

Press button **1**.

The AUTO button indicator light (on the display) goes out.

This function rapidly demists/de-ices the windscreen, the front side windows and the door mirrors.

It imposes automatic operation of the air conditioning and rear screen de-icing, and inhibits air recirculation.

Press button **11** if you do not want the heated rear screen to be activated.

**Note:** if you wish to reduce the air flow (which may produce a certain amount of noise in the passenger compartment), press button **10**.

**To exit this function**, press:

- button **1** again;
- or button **5** (the AUTO indicator light on the display will light up).



### Air recirculation

Pressing button **12** activates air recirculation (the symbol lights up on the display).

During recirculation, air is taken from the passenger compartment and is recycled, with no air being taken from outside the vehicle.

Air recirculation allows the external atmosphere to be cut off (when driving in polluted areas, etc.).

Prolonged use of the air recirculation mode may cause the windows to mist up or lead to odours, as the air is not renewed.

We therefore advise you to return to normal mode (external air or automatic recirculation) as soon as air recirculation is no longer needed, by pressing button **12**.

# AIR CONDITIONING: information and operating instructions (1/2)

## Advice on use

In some situations (air conditioning off, air recirculation activated, ventilation speed at zero or low etc.), you may notice that condensation starts to form on the windows and windscreen.

If there is condensation, use the “**Clear View**” function to remove it, then use the air conditioning in automatic mode to stop it forming again.

## Maintenance

Refer to the Maintenance Document for your vehicle for the inspection frequency.



Do not add anything to the vehicle's ventilation circuit (for example, to remove bad odours).

**There is a risk of damage or of fire.**

## Fuel consumption

You will normally notice an increase in fuel consumption (especially in town) when the air conditioning is operating.

For vehicles fitted with air conditioning with no automatic mode, switch off the system when it is not required.

### Advice for reducing consumption and helping to preserve the environment

Drive with the air vents open and the windows closed.

If the vehicle has been parked in the sun, open the doors for a few moments to let the hot air escape before starting the engine.

## Operating faults

As a general rule, contact your approved dealer in the event of an operating fault.

### – Reduction in de-icing, demisting or air conditioning performance.

This may be caused by the passenger compartment filter cartridge becoming clogged.

### – No cold air is being produced.

Check that the controls are set correctly and that the fuses are sound. Otherwise, switch off the system.

## Presence of water under the vehicle

After prolonged use of the air conditioning system, it is normal for water to be present under the vehicle. This is caused by condensation.



**Do not open the refrigerant fluid circuit.** The fluid may damage eyes or skin.

## AIR CONDITIONING: information and operating instructions (2/2)

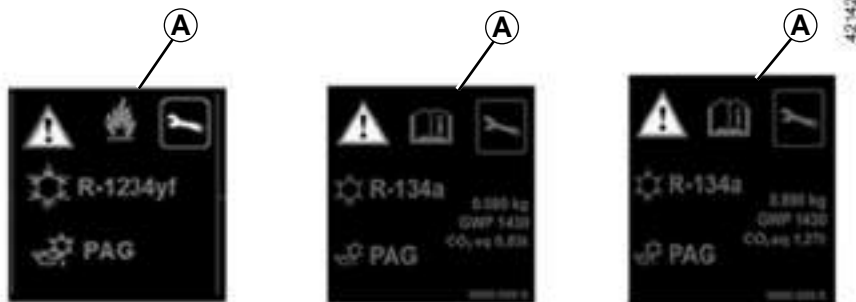

The refrigerant fluid circuit contains fluorinated greenhouse gases.

Depending on the vehicle, you will find the following information on label **A** affixed inside the engine compartment.

The presence and location of the information on label **A** depends on the vehicle.



Do not open the refrigerant fluid circuit. The fluid may damage eyes or skin.



Before carrying out any work in the engine compartment, the engine must be stopped (and not on standby): stop the engine (please see “Starting, stopping the engine” in Section 2).



Type of refrigerant fluid



Type of oil in the air conditioning circuit



Inflammable product



Consult the driver's handbook



Maintenance

x.xxx kg

Quantity of refrigerant fluid present in the vehicle.

GWP xxxxx

Global Warming Potential (CO<sub>2</sub> equivalent).

CO<sub>2</sub> eq  
x.xx t

Quantity in weight and in CO<sub>2</sub> equivalent.



## INTERIOR LIGHTING (1/2)

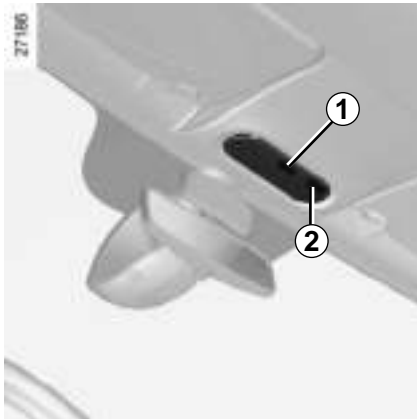

### Courtesy lights

Switches **1** or **3** provide:

- permanent lighting;
- intermittent lighting, which comes on when a door is opened. It goes out when the doors concerned are properly closed;
- immediate switching off.

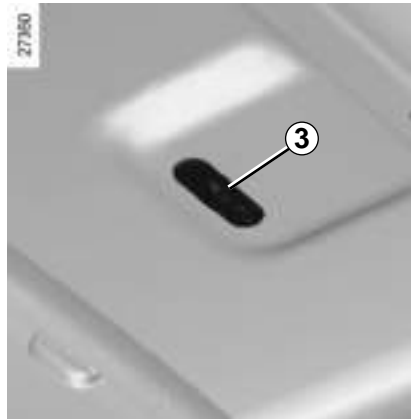

### Map reading lights

(depending on vehicle)

Tilt the switch **3** for permanent lighting.

In the front passenger seat, press switch **2**.

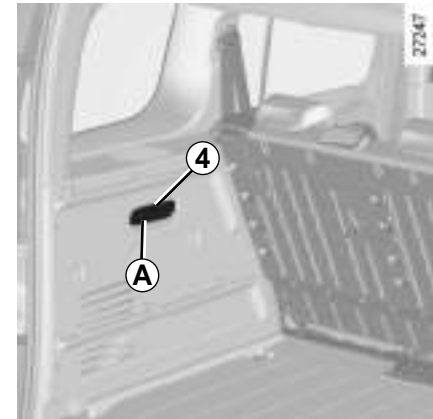

### Luggage compartment light **A**

(depending on vehicle)

Tilt the switch **4** for permanent lighting.

Unlocking and opening the doors or luggage compartment switches on the timed courtesy lights.

## INTERIOR LIGHTING (2/2)

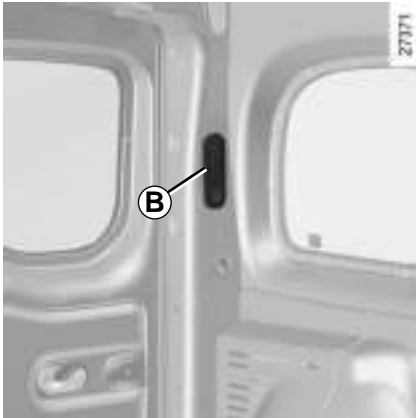

**Luggage compartment light B**  
(depending on vehicle)



**Sliding side door light C**  
(depending on vehicle)

Pressing switch **5** gives:

- permanent lighting;
- light when the sliding side door is opened. It goes out when the door in question is correctly closed;
- immediate switching off.

### Special features

Depending on the vehicle, remote unlocking of the doors triggers timed lighting of the passenger compartment. If one of the front or rear doors is opened, the period for which the light is switched on will start again.

Then the courtesy light and the luggage compartment light dim and go out.

The lighting timer will cut out for various reasons:

- if a door has been open for 15 minutes;
- if all the doors have been closed for 15 seconds or 5 minutes, depending on the vehicle;
- when the ignition is switched on.

## SUN VISOR/MIRRORS

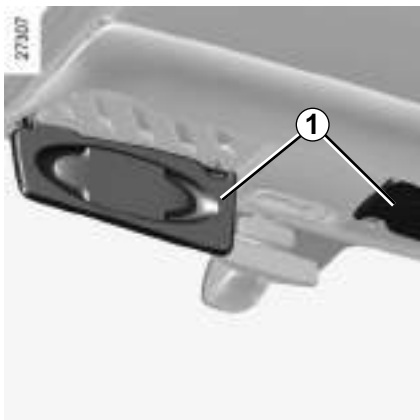

### Front sun visor

Lower sun visor 1.

The clip can be used to hold motorway passes, etc..



### Courtesy mirror 2 (passenger side)

If the sun visor is fitted with a courtesy mirror, it has a cover.

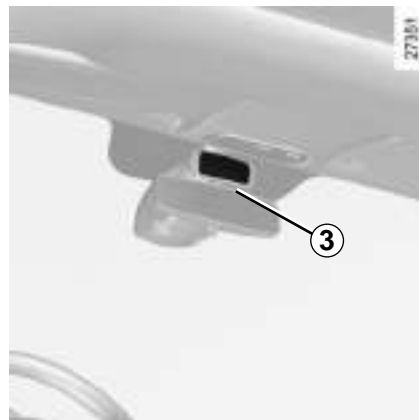

### Child minder mirror 3

The child minder mirror allows you to keep an eye on your child in the back seat.



When driving, ensure the courtesy mirror cover is closed. Risk of injury.

## ELECTRIC WINDOWS (1/2)

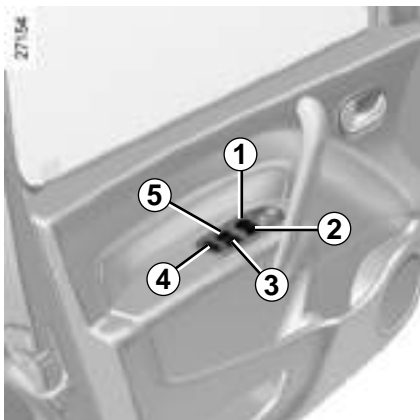

### Electric windows

#### With the ignition on:

- press the switch for the window concerned to lower it to the desired height;
- lift the switch for the window concerned to raise it to the desired height.

#### From the driver's seat

Operate the switches as follows:

- **1** for the driver's side;
- **2** for the front passenger's side;
- **3** and **5** for the rear passenger windows.



#### From the front passenger seat

Press switch **6**.

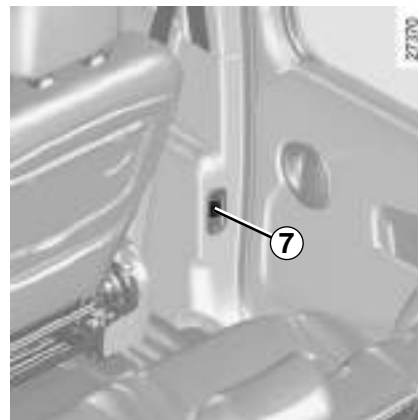

#### From the rear seats

With the doors closed, press switch **7**.



#### Safety of rear occupants

Depending on the vehicle, the driver can disable operation of the rear electric windows by pressing switch **4**.

#### Driver's responsibility

Never leave your vehicle with the remote control unit inside and never leave a child (or a pet) unsupervised, even for a short while.

They may pose a risk to themselves or to others by starting the engine or activating equipment (such as the gear lever or electric windows). If any part of the body becomes trapped, reverse the direction of the window immediately by pressing the relevant switch.

Risk of serious injury.

## ELECTRIC WINDOWS (2/2)/HALF-OPENING WINDOW



### One-touch electric window

The one-touch mode works in addition to the operation of the electric windows described previously.

**It is fitted to the driver's window.**

**Briefly press or pull the** switch **1**: the window is fully lowered or raised. Pressing the switch again stops the window moving.



Closing windows can cause serious injury.

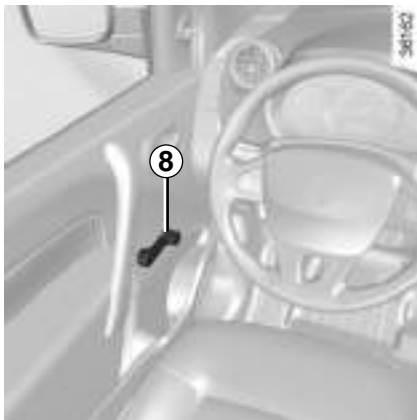

### Manual window winders

Turn handle **8**.

Avoid resting any objects against a half-open window: there is a risk that the electric window winder could be damaged.

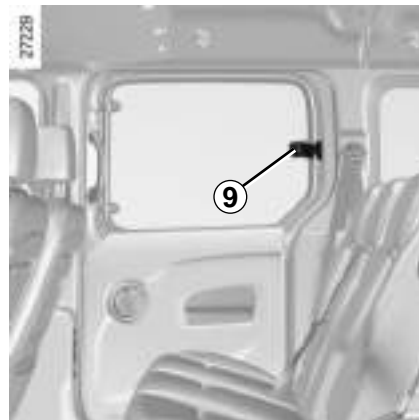

### Half-opening window

To half-open the window, turn handle **9** in the direction of the arrow then lock it by pushing the handle. When closing it, check that it is properly locked.

# MANUAL SUNROOF



## Opening

### To the first position

Push handle **1** towards the front of the vehicle until it stops.

### To the second position

Press tab **2** and push handle **1** at the same time until it stops again.



## Closing

Hold tab **2** pressed in and return the handle **1** to the initial position.

## Precautions during use

- **check** that the sunroof is properly closed before leaving your vehicle;
- **clean** the seal every three months using products recommended by our Technical Department;
- **do not open** the sunroof immediately after the vehicle has been in the rain or after your car has been washed.
- **Vehicle with roof bars**

As a general rule, if there is a load on the roof, use of the sunroof is not recommended.

Before using the sunroof, check the objects and/or accessories (bike racks, roof boxes, etc.) attached to the roof bars: they should be properly arranged and secured and should not interfere with the operation of the sunroof.

Contact your approved Dealer for details of possible conversions.

## ASHTRAYS/CIGAR LIGHTER/ACCESSORIES SOCKETS

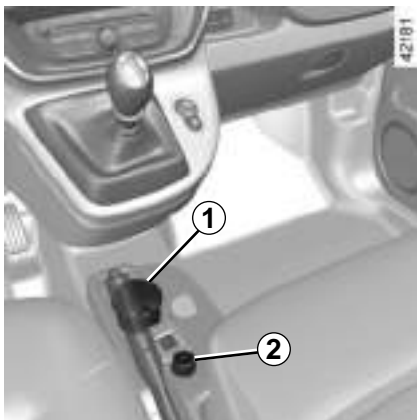

### Removable ashtray 1

This is a removable ashtray which can be placed in the cup holders 3.

Lift the cover to open.

To empty it, pull the assembly. The ashtray will come out of its housing.

If your vehicle is not fitted with a cigar lighter and an ashtray, these can be obtained from an approved Dealer.

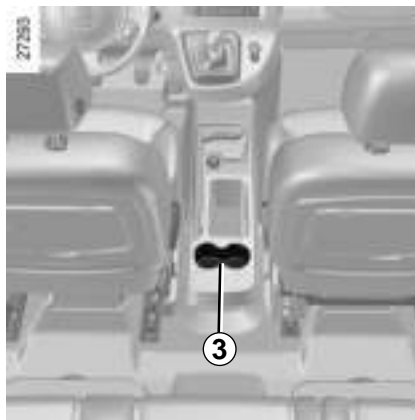

### Cigar lighter 2

With the ignition on, press it in. It will spring back with a click when it is ready. Pull it out to use.

After use, replace it without pushing it all the way in.



Connect accessories with a maximum power of 120 Watts only.

**Fire hazard.**

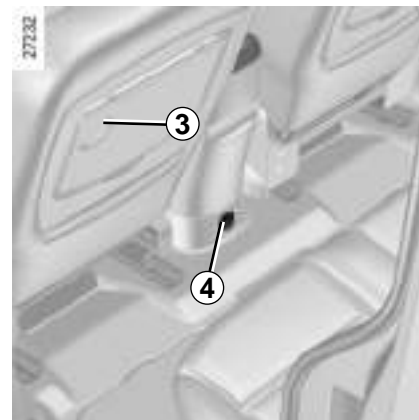

### Accessories sockets

You may use the cigar lighter recess 2 or one of sockets 4 (depending on the vehicle). They are designed for connecting accessories with a maximum power rating of 120 Watts (voltage: 12V) which have been approved by our Technical Department.

Depending on the battery charge, the accessories socket may stop working.

## PASSENGER COMPARTMENT STORAGE SPACE AND FITTINGS (1/5)

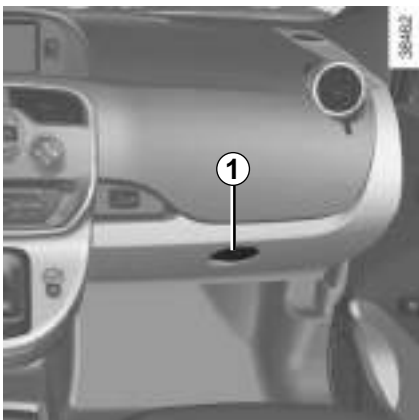

### Glovebox

To open the glove box, lift catch **1**.

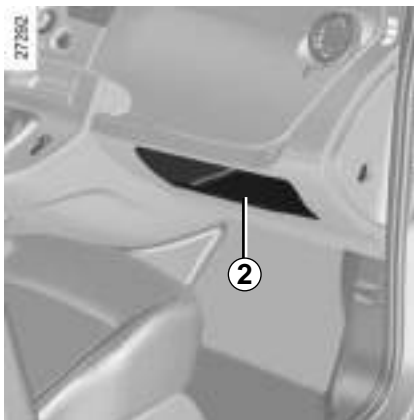

### Dashboard storage compartment **2**

### Centre console storage compartment **3**

To open, lift cover **4**. It will store a 1.5 litre bottle.

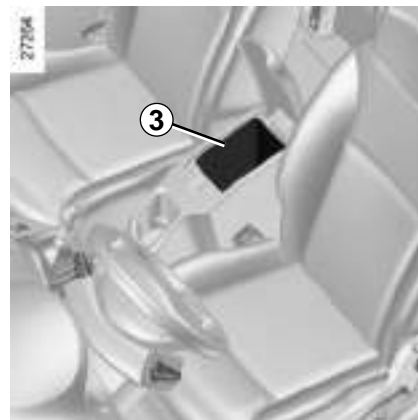

When turning corners, accelerating or braking, ensure that the receptacle being held by the cup holder is not dislodged.

There is a risk of burning if hot liquid escapes.



## PASSENGER COMPARTMENT STORAGE SPACE AND FITTINGS (2/5)

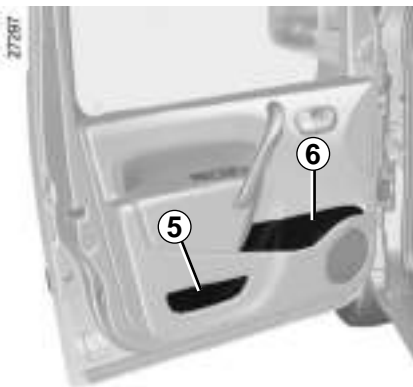

### Front door storage compartments 5

### Bottle holders 6



Ensure that no hard, heavy or pointed objects are placed in the "open" storage compartments in such a way that they may fall onto passengers during sudden turning or braking.

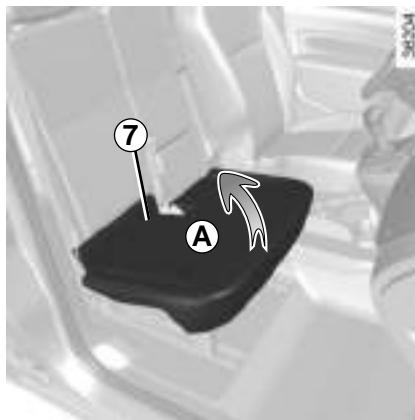

### Storage compartment 8 under front passenger seat

(for vehicles fitted with front bench seat for two)

To get to it:

- lift up the front of the bench seat cushion **A** as far as the stop;
- then lift the rear part of the cushion **7** and tip the seat up against the dashboard.

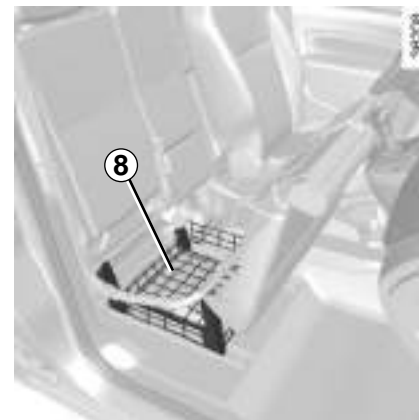

To replace the seat, proceed in reverse:

- lift up the bench seat cushion **A** so as to put the rear part of the cushion **7** under the seatback;
- push down on the front of the cushion **A** so as to lock the seat base.



Nothing should be placed on the floor area in front of the driver as such objects may slide under the pedal during braking manoeuvres, thus obstructing its use.

## PASSENGER COMPARTMENT STORAGE SPACE AND FITTINGS (3/5)



### Clip 9

This can be used for storing motorway tickets, cards, etc.

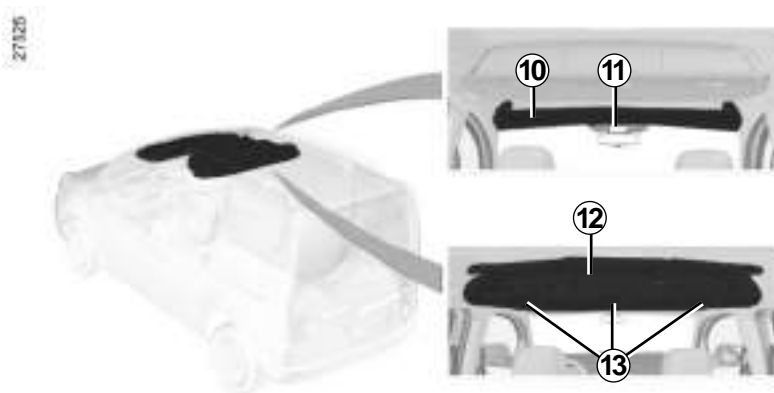

### Front upper cab storage compartment 10

Do not use it for getting into or out of the vehicle and do not hang from it.

### Sunglasses holder 11

There is a dedicated storage compartment in the centre.

### Central upper storage compartments 12

To open the storage compartments, pull handles 13.

This is not suitable for storing heavy items.



Do not hang any heavy and/or sharp objects which may fall whilst driving. Risk of injury. Before opening the upper storage compartments, take the necessary precautions to avoid falling objects. Risk of injury.

When driving, the upper storage compartments 12 must be closed.

## PASSENGER COMPARTMENT STORAGE SPACE AND FITTINGS (4/5)

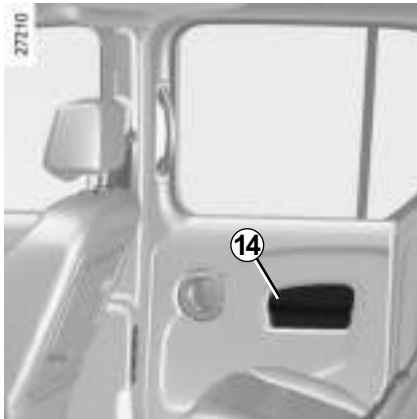

**Sliding side door storage compartments 14**

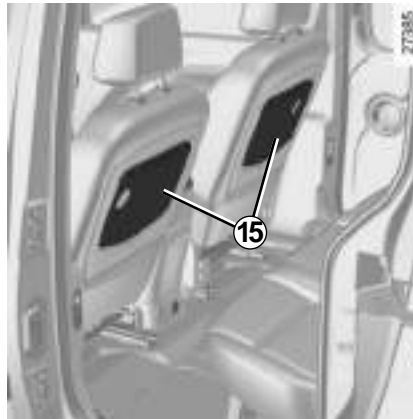

**Trays on the front seat 15**

Permitted weight: 5 kg, evenly distributed.

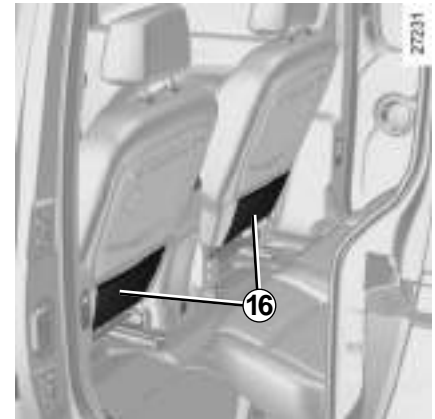

**Front seat storage pockets 16**

## PASSENGER COMPARTMENT STORAGE SPACE AND FITTINGS (5/5)

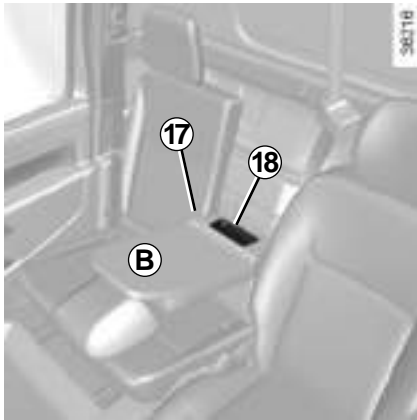

### Storage compartment 18 in the front armrest

(for vehicles fitted with front bench seat for two)

Pull on the handle 17 to lower the seat-back **B**.



### Clothes hook 19

Depending on the vehicle, a hook may be located on the partition behind the front passenger seat.

For safety reasons, this hook may only be used to hang clothes.

**Note:** the maximum permitted load is 4 kg.

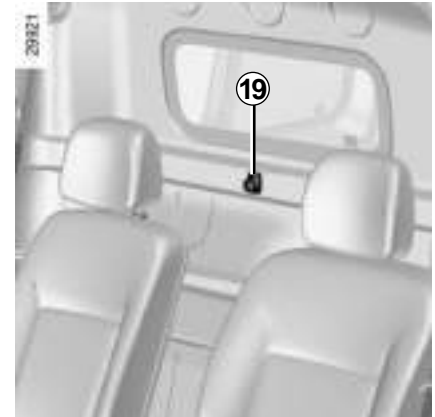
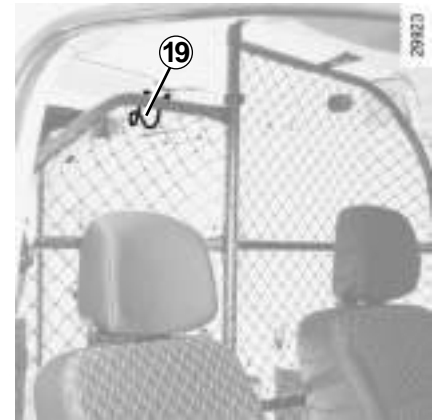

## REAR BENCH SEAT: functions (1/2)

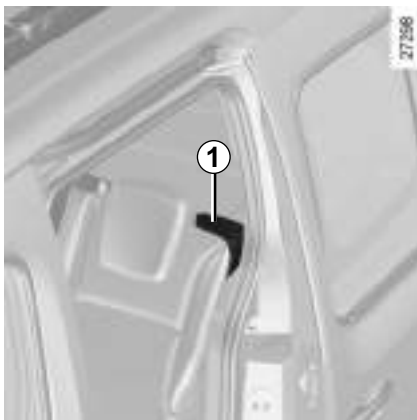

### To fold down the seatback

Before moving the bench seat, make sure the front seats are pushed forward enough, that the rear seat belts are unfastened and that nothing will obstruct the manoeuvre.

Lower the rear headrests to storage position.

Pull lever **1** of the seatback you wish to fold down (on the right- or left-hand side of the bench seat), and bring the seatback down.



### To raise the seatback

Before raising the seatback, make sure there are no objects (water bottle, tool box etc.) which will prevent it from locking properly.

Raise the seatback and click it into position. Check that it is correctly locked.

Maximum weight: 300 kg, evenly distributed.



For safety reasons, carry out any adjustments when the vehicle is not being driven.



When moving the rear bench seat, make sure the bench seat anchorage points are clean (they should be free from grit, cloths etc.).



When refitting the seatback, make sure it is correctly locked.

If using seat covers, make sure they do not prevent the seatback and seat base latches from locking in. Ensure that the seat belts and seat belt fasteners are correctly positioned.

Reposition the headrests.

## REAR BENCH SEAT: functions (2/2)



11500

### Use restriction

It is forbidden to drive with a seatback or a front seat folded down when there is a passenger occupying a rear seat.



For safety reasons, carry out any adjustments when the vehicle is not being driven.

## TRANSPORTING OBJECTS IN THE BOOT (1/2)

Always position the objects transported so that the largest surface is against:

- the rear bench seatbacks, for normal loads;



- the front seats for maximum loads.



Always position the heaviest items directly on the floor.



Always position the heaviest items directly on the floor.

Use the lashing points on the floor of the luggage compartment, if these are fitted to the vehicle.

The luggage should be loaded in such a way that no items will be thrown forward and strike the occupants if the driver has to brake suddenly.

Fasten the rear seat belts, even if the seats are not occupied.

## TRANSPORTING OBJECTS IN THE BOOT (2/2)/TOWING

27313

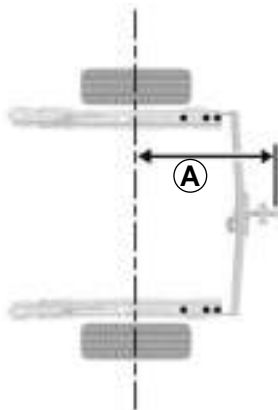

**Permissible nose weight, maximum permissible towing weight, braked and unbraked:** refer to the information on “Weights” in Section 6.

### **Choice and fitting of towing equipment**

Maximum weight of towing equipment: 23 kg

For fitting and conditions of use, refer to the equipment’s fitting instructions.

Please keep these instructions with the rest of the vehicle documentation.

27314



$A = 781$  mm.

If the towbar ball obscures the registration plate or the rear fog lights, it should be removed when not in use.

In all cases, comply with local legislation.



## LUGGAGE COVER



The luggage compartment cover is made up of two rigid sections.

There are three possible positions:

- top position **A**;
- bottom position **B** (depending on the vehicle).

In both cases, you can fold section **1** onto section **2** by lifting it as shown by the arrow.



- The storage position **C** (depending on the vehicle).

To store the luggage compartment cover, position it in the runner against the rear bench seatback.



Do not place any objects, especially heavy or solid objects on the luggage cover. These may pose a risk to the vehicle occupants if the driver has to brake suddenly or if the vehicle is involved in an accident.

# LUGGAGE NET

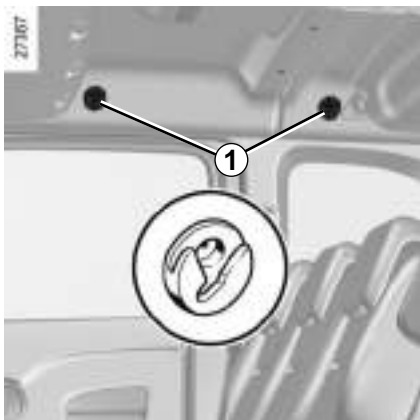

## The luggage net (depending on vehicle)

This is located in the luggage compartment.

It may be attached behind the front seats or behind the rear bench seat.

Hooks **1** may also be used to hang clothes.



The luggage net must not be used to restrain or hold objects.

Risk of injury

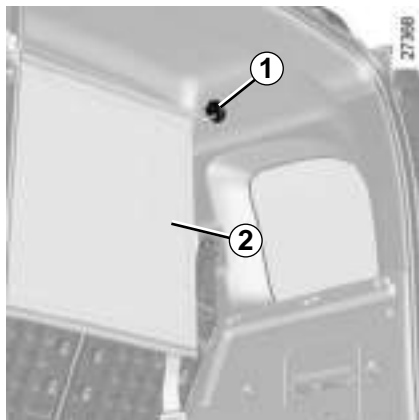

## Positioning the net 2

- Upper section: insert the tabs at the ends of the net in hooks **1**;
- lower section: engage belts **3** in lashing rings **4** on the floor. Ensure that both forks of the lower hook are engaged;
- tighten the net using the tensioning units.

For more information, refer to the label sewn onto the net.

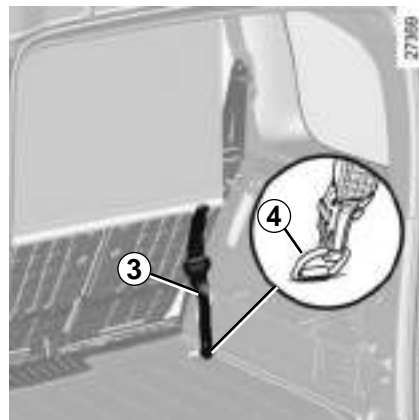

Luggage compartment anchorages (rings) **4** cannot be used if they are already being used to secure two other components (eg. luggage net + load in the luggage compartment or child seat + load in the luggage compartment).

## ROOF BARS (1/2)



### To place the bars in the transverse position

- Unclip levers 1.
- Lift the bars to allow them to be pivoted (figure A).
- Lock the bars in the transverse position (figure B).
- Check that they are correctly locked.

Maximum weight on each roof bar:  
40 kg evenly distributed (80 kg over  
2 roof bars)



It is strictly forbidden to place the roof bars in the transverse position (carrying position) when entering a roller-type car wash.

## ROOF BARS (2/2)

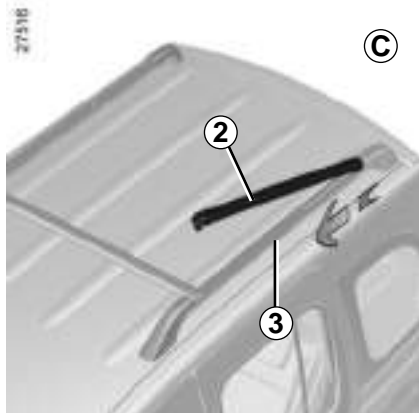

### To slide the bar

Roof bar **2** can be slid to move it closer to or further from the other bar (figure **C**).

There are two positions: centre or rear.

With the bar unlocked, pull it towards the front or the rear of the vehicle to slide it in rail **3**. Once you have chosen the position, pivot the bar and lock it in the transverse position (figure **D**).

Check that both bars are correctly locked in position.

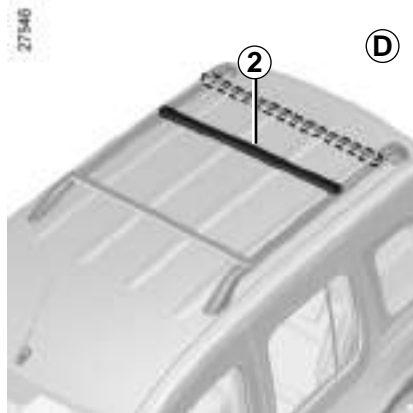

## MULTIMEDIA EQUIPMENT

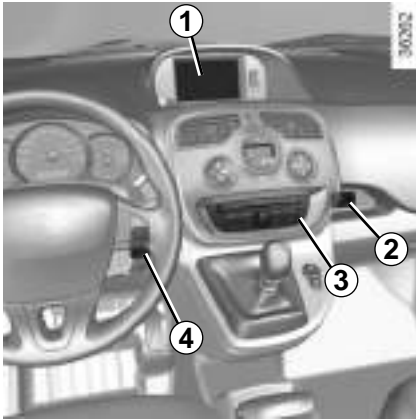

The presence and location of this equipment depends on the vehicle's multimedia equipment.

- 1 Multimedia touchscreen;
- 2 multimedia sockets;
- 3 radio;
- 4 steering column control.

Refer to the equipment instructions for information on how to operate this equipment.



# Section 4: Maintenance

Bonnet . . . . .	4.2
Engine oil level: . . . . .	4.4
general information, use. . . . .	4.4
topping up, filling . . . . .	4.6
Levels . . . . .	4.8
Filters. . . . .	4.10
Battery . . . . .	4.11
Tyre pressure. . . . .	4.13
Bodywork maintenance . . . . .	4.15
Interior trim maintenance. . . . .	4.17

## BONNET (1/2)



To open the bonnet, pull the handle **1**.



### Unlocking the bonnet catch

To open, push tab **2** to the left as you open the bonnet.

### Opening the bonnet

Lift the bonnet, helping it up, and it will rest in position with the help of struts.



Before performing any action in the engine compartment, the ignition must be switched off (please see the information on “Starting, stopping the engine” in Section 2).



Do not press down on the bonnet: there is a risk that the bonnet may accidentally close.



The engine may be hot when carrying out operations in close proximity. In addition, the engine cooling fan can come on at any moment. Risk of injury.



When working in the engine compartment, ensure that the windscreen wiper stalk is in the park position. Risk of injury.



## BONNET (2/2)

### Closing the bonnet

Check that nothing has been left in the engine compartment.

To close the bonnet again, hold the bonnet in the middle and lower it to 30 cm above the closed position, then release it. It will latch automatically under its own weight.



Ensure that the bonnet is properly locked.

Check that nothing is preventing the catch from locking (gravel, cloth, etc.).



After carrying out any work in the engine compartment, check that nothing has been left behind (cloth, tools, etc.).

These may damage the engine or cause a fire.



In the event of even a slight impact involving the radiator grille or bonnet, have the bonnet lock checked by an approved dealer as soon as possible.

## ENGINE OIL LEVEL: general information (1/2)

It is normal for an engine to use oil for lubrication and cooling of moving parts and it is normal to top up the level between oil changes.

However, contact an approved Dealer if more than 0.5 litres is being consumed every 600 miles (1,000 km) after the running in period.

**Oil change frequency: check the oil level from time to time and certainly before any long journey to avoid the risk of damaging your engine.**

### Reading the oil level

The oil level should be read with the vehicle on level ground, after the engine has been switched off for some time.

**The dipstick must be used to read the exact oil level and make sure that the maximum level has not been exceeded (risk of engine damage).** Refer to the following pages.

The instrument panel display only alerts the driver when the oil level is at its minimum.



### Minimum oil level display A

#### If the level is above the minimum level

The "OIL LEVEL" message appears on the display, accompanied by squares indicating the level. These squares disappear as the level drops and they are replaced by dashes.

To advance to trip computer reading, press button **1** or **2** again.

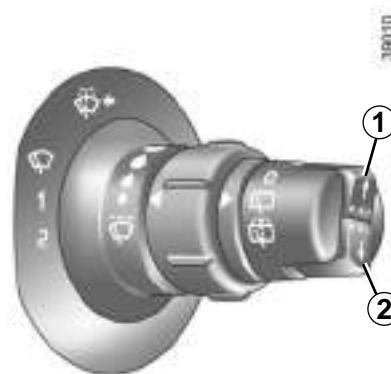

#### If the level is at the minimum

The "TOP-UP OIL LEVEL" message and warning light  are displayed on the instrument panel.

**It is vital to top up the oil as soon as possible.**



The display only warns the driver if the oil level is at the minimum level. It does not inform the driver that the oil level has exceeded the maximum level as this can only be measured using a dipstick.

## ENGINE OIL LEVEL: general information (2/2)

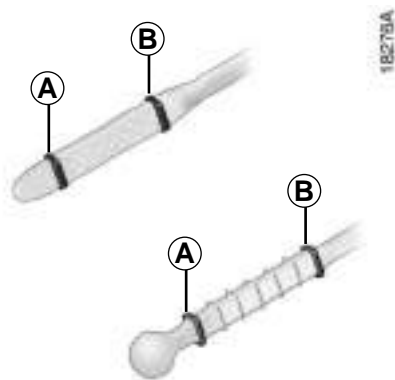

### Reading the level using the dipstick

Engine switched off:

- remove the dipstick and wipe with a clean, lint-free cloth;
- push the dipstick in as far as it will go;
- take out the dipstick again;
- read the level: it should never fall below minimum mark **A** or exceed maximum mark **B**.

Once the level has been read, push the dipstick in as far as it will go.



Before performing any action in the engine compartment, the ignition must be switched off (please see the information on “Starting, stopping the engine” in Section 2).



#### Exceeding the maximum engine oil level

Under no circumstances must the maximum fill level **B** be exceeded: risk of damage to the engine and catalytic converter.

If the oil level exceeds the maximum level, **do not start your vehicle** and contact an approved Dealer.

In order to prevent splashback, it is recommended that a funnel be used when topping up/filling with oil.

Consult your approved Dealer at once if you notice an abnormal or repeated drop in any of the fluid levels.



The engine may be hot when carrying out operations in close proximity. In addition, the engine cooling fan can come on at any moment.

Risk of injury.

## ENGINE OIL LEVEL: topping up/filling (1/2)

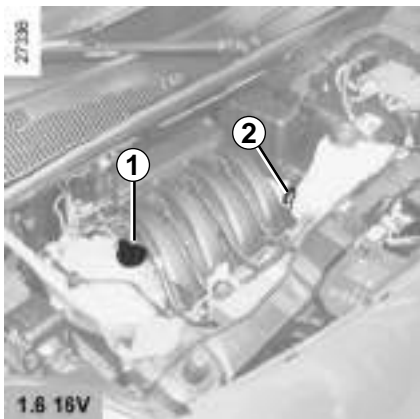

### Topping up/filling

The vehicle must be parked on level ground and the engine should be cold (for instance, before the engine is started up for the first time in the day).

Do not exceed the **“max”** level and do not forget to refit the cap **1** and the dipstick **2**.

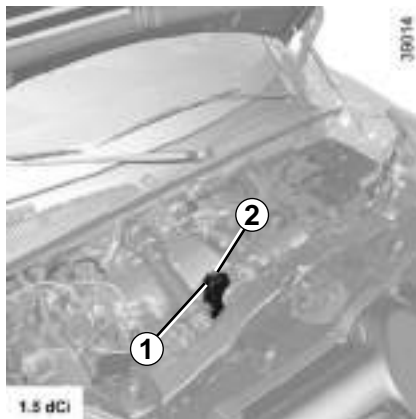

- Unscrew the cap **1**;
- top up the level (as a guide, the capacity between the “min” and “max” on the dipstick **2** is 1.5 litres, depending on the engine);
- wait for approximately 10 minutes to allow the oil to flow into the engine;
- check the level using the dipstick **2** (as described above).

Once the operation is complete, ensure that the dipstick is fully inserted, or the cap-type dipstick screwed in completely.

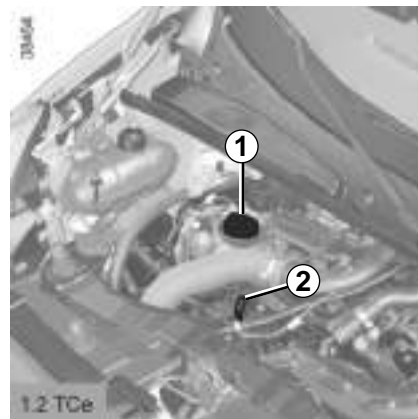

# ENGINE OIL LEVEL: topping up/filling (2/2)ENGINE OIL CHANGE

## Oil change

**Service interval:** refer to the Maintenance Service Booklet for your vehicle.

## Oil change capacity

Please refer to the maintenance document for your vehicle, or contact an authorised dealer.

Always check the engine oil level using the dipstick, as explained previously (it should never fall below the minimum level, or be over the maximum level on the dipstick).



### Exceeding the maximum engine oil level

Under no circumstances must the maximum fill level be exceeded: risk of damage to the engine and catalytic converter. If the oil level exceeds the maximum level, **do not start your vehicle** and contact an approved Dealer.

## Engine oil grade

Refer to the Maintenance Service Booklet for your vehicle.



The engine may be hot when carrying out operations in close proximity. In addition, the engine cooling fan can come on at any moment.

Risk of injury.



Consult your approved Dealer at once if you notice an abnormal or repeated drop in any of the fluid levels.



Never run the engine in an enclosed space as exhaust gases are poisonous.



**Engine oil change:** if you are changing the oil when the engine is hot, be careful not to scald yourself if the oil overflows.



**Filling:** take care when topping up the oil that no oil drips onto engine components - risk of fire. Remember to refit the cap securely as there is a risk of fire if oil splashes onto hot engine components.

## LEVELS (1/3)



### Brake fluid level

This should be checked frequently, and immediately if you notice even the slightest loss in braking efficiency.

The level should be read with the engine switched off and on level ground.

### Level 1

It is normal for the level to drop as the brake shoes become worn, but it must never drop lower than the "MINI" warning line.

If you wish to check the disc and drum wear yourself, you should obtain the document explaining the checking procedure from our network or from the manufacturer's website.

Consult your approved dealer at once if you notice an abnormal or repeated drop in any of the fluid levels.



Before performing any action in the engine compartment, the ignition must be switched off (please see the information on "Starting, stopping the engine" in Section 2).

### Topping up

After any operation on the hydraulic circuit, a specialist must replace the fluid.

Only use fluids approved by our Technical Department (and taken from a sealed container).

### Replacement intervals

Refer to the Maintenance Document for your vehicle.



The engine may be hot when carrying out operations in close proximity. In addition, the engine cooling fan can come on at any moment.

Risk of injury.

## LEVELS (2/3)



### Coolant

The level **when cold** should be between the MINI and MAXI marks on the coolant reservoir **2**.

Top this level up **when cold** before it reaches the MINI mark.

The level should be read with the engine switched off and on level ground.



No operations should be carried out on the cooling circuit when the engine is hot.

**Risk of burns.**

### Checking intervals

**Check the coolant level regularly** (very severe damage is likely to be caused to the engine if it runs out of coolant).

If the level needs to be topped up, only use products approved by our Technical Department which ensure:

- antifreeze protection;
- anticorrosion protection of the cooling system.

### Replacement intervals

Refer to the Maintenance Document for your vehicle.

Consult your approved dealer at once if you notice an abnormal or repeated drop in any of the fluid levels.

## LEVELS (3/3)/FILTERS

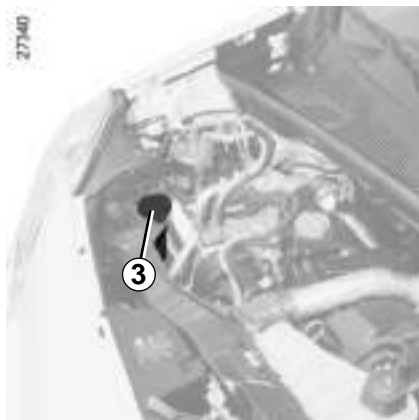

### Windscreen washer reservoir

#### Topping up

- Unscrew cap **3**;
- fill until you can see the fluid;
- close the cap.

#### Liquid

Screen wash product (product with antifreeze in winter).

#### Jets

To adjust the height of the windscreen washer jets, use a tool such as a flat-blade screwdriver.

#### Filters

The replacement of filter elements (air filter, cabin filter, diesel fuel filter, etc.) is scheduled in the maintenance operations for your vehicle.

**Replacement intervals for filter elements:** refer to the Maintenance Document for your vehicle.



The engine may be hot when carrying out operations in close proximity. In addition, the engine cooling fan can come on at any moment.

Risk of injury.



Before performing any action in the engine compartment, the ignition must be switched off (please see the information on “Starting, stopping the engine” in Section 2).



## BATTERY (1/2)



Battery **1** does not require any maintenance. **You should not open it or add any fluid.**



Handle the battery with care as it contains sulphuric acid, which must not come into contact with eyes or skin. If it does, wash the affected area with plenty of cold water. If necessary, consult a doctor.

Ensure that naked flames, red hot objects and sparks do not come into contact with the battery as there is a risk of explosion.

Depending on the vehicle, a system continuously checks the battery charge status.

When the ignition is off, some consumers may also be switched off (dipped beam headlights, radio, ventilation, etc.). On the instrument panel, the "BATTERY MODE : ECONOMY" message appears when they are switched off. When the level is extremely low, the messages "BATTERY LOW" and "START ENGINE" are displayed.

The charge status of the battery can decrease, especially if you use your vehicle:

- for short journeys;
- for driving in town;
- when the temperature drops, etc.;
- with the vehicle stopped and the engine off.

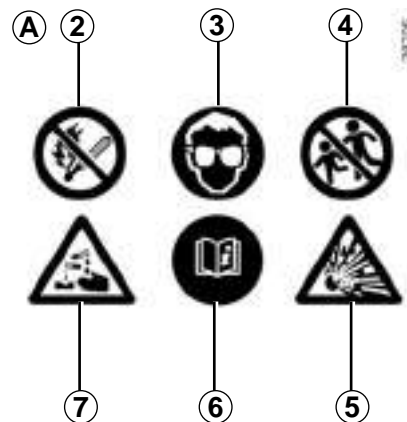

### Label A

Observe the indications on the battery:

- **2** naked flames and smoking forbidden;
- **3** eye protection required;
- **4** keep away from children;
- **5** explosive materials;
- **6** please consult the driver's handbook;
- **7** corrosive materials.



The engine may be hot during operations in close proximity. In addition, the engine cooling fan may start at any moment.

Risk of injury.

## BATTERY (2/2)



### Replacing the battery

As this operation is complex, we advise you to contact an approved Dealer.

### Vehicle fitted with the Stop and Start function

The function will have to be restarted each time the battery is replaced. To restart the function, press and hold the Stop and Start activation/deactivation switch **8** until you hear a beep.



Before performing any action in the engine compartment, the ignition must be switched off (please see the information on “Starting, stopping the engine” in Section 2).



The battery is a **specific type**, please ensure it is replaced with the same type. Consult an approved dealer.

## TYRE PRESSURE WHEN cold (1/2)



### Label A

Open the driver's door to read it. Tyre pressures should be checked when the tyres are cold. If the tyre pressures cannot be checked when the tyres are **cold**, increase the pressures from **0.2 to 0.3 bar** (or **3 PSI**). **Never deflate a hot tyre.**

### Vehicle fitted with a tyre pressure loss warning system

If under-inflated (puncture, low pressure, etc.), the warning light  lights up on the instrument panel. See "Tyre pressure loss warning" in Section 2.

### Vehicles used fully laden (Maximum Permissible All-up Weight) and towing a trailer

The maximum speed must be limited to **60 mph (100 km/h)** and the tyre pressure increased by **0.2 bar**.

Please refer to the information on "Weights" in Section 6.

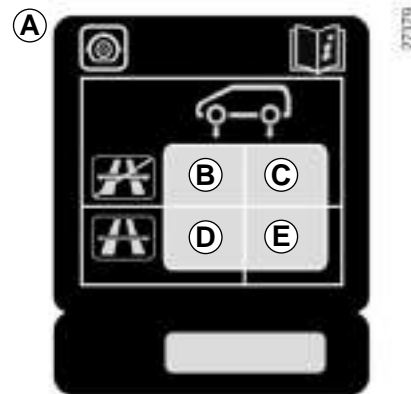

**B:** front tyre pressure when driving (non-motorway), or if less than 4 people occupy the vehicle.

**C:** rear tyre pressure when driving (non-motorway), or if less than 4 people occupy the vehicle.

**D:** tyre pressures for the front wheels (motorway) or when driving with a significant load.

**E:** tyre pressures for the rear wheels (motorway) or when driving with a significant load.

## TYRE PRESSURE WHEN cold (2/2)

### Tyre dimensions

The following dimensions are specific to the vehicle:

- 185/70 R 14 88 T;
- 195/65 R 15 91 T;
- 195/65 R 15 95 T;
- 205/55 R 16 91 H.

### Tyre safety and use of snow chains

Refer to the information on “Tyres” in Section 5 for the servicing conditions and, depending on the version, the use of chains.



For your safety, please respect the speed limit.

When they need to be replaced, only tyres of the same make, size, type and profile should be used on a single axle.

**They must: either have a load capacity and speed rating at least equal to those of the original tyres, or conform to those recommended by an authorised dealer.**

Failure to heed these instructions could endanger your safety and affect your vehicle's roadworthiness.

**Risk of loss of control of the vehicle.**

## BODYWORK MAINTENANCE (1/2)

A well-maintained vehicle will last longer. It is therefore recommended to maintain the exterior of the vehicle regularly.

Your vehicle has been treated with very effective anti-corrosion products. It is nevertheless subject to various outside influences.

### Corrosive agents in the atmosphere

- atmospheric pollution (built-up and industrial areas),
- saline atmospheres (near the sea, particularly in hot weather),
- seasonal and damp weather conditions (e.g. road salt in winter, water from road cleaners, etc.).

### Minor impacts

#### Abrasive action

Dust and sand in the air, mud, road grit thrown up by other vehicles, etc.

You should take a number of minor precautions in order to safeguard your vehicle against such risks.

### What you should not do

Do not degrease or clean mechanical components (e.g. the engine compartment), underneath the body, parts with hinges (e.g. inside the doors) and painted plastic external fittings (e.g. bumpers) using high-pressure cleaning equipment or by spraying on products not approved by our Technical Department. Doing this could give rise to corrosion or operational faults.

Wash the vehicle in bright sunlight or freezing temperatures.

Do not scrape off mud or dirt without pre-wetting.

Allow dirt to accumulate on the exterior.

Allow rust to form following minor impacts.

Do not use solvents not approved by our Technical Department to remove stains as this could damage the paintwork.

Do not drive in snow or muddy conditions without washing the vehicle, particularly under the wheel arches and body.

### You should

Wash your car frequently, **with the engine off**, with cleaning products recommended by the manufacturer (never use abrasive products). Rinse thoroughly beforehand with a jet:

- spots of tree resin and industrial grime;
  - mud in the wheel arches and underneath the body which forms damp patches;
  - **bird droppings**, which cause a chemical reaction with the paint that **rapidly discolours paintwork and may even cause the paint to peel off**;
- wash the vehicle **immediately** to remove these marks since it is impossible to remove them by polishing;
- salt, particularly in the wheel arches and underneath the body after driving in areas where the roads have been gritted.

Remove any plant matter (resin, leaves, etc.) from the vehicle regularly.

## BODYWORK MAINTENANCE (2/2)

Respect local regulations about washing vehicles (e.g. do not wash your vehicle on a public highway).

Observe the vehicle stopping distances when driving on gravelled surfaces to prevent paint damage.

Repair, or have repaired quickly, areas where the paint has been damaged, to prevent corrosion spreading.

Remember to visit the body shop periodically in order to maintain your anti-corrosion warranty. Refer to the Maintenance Document.

If it is necessary to clean mechanical components, hinges, etc., spray them with products approved by our Technical Department to protect them after they have been cleaned.

We have selected special products to care for your vehicle and you can obtain these from the manufacturer's accessory outlets.

### Vehicles with a matte paint finish

This type of paint requires certain precautions.

#### Do not do the following

- use wax-based products (polishing);
- rub hard;
- wash the vehicle in a roller-type car wash;
- wash the vehicle using a high-pressure device;
- attach stickers to the paintwork (risk of leaving marks).

#### You should do the following

Wash the vehicle by hand using plenty of water, using a soft cloth or a gentle sponge.

### Using a roller type car wash

Return the windscreen wiper stalk to the Park position (refer to the information on the “Windscreen washer, wiper” in Section 1). Check the mounting of external accessories, additional lights and mirrors, and ensure that the wiper blades are secured with adhesive tape. Remove the radio aerial mast if your vehicle is fitted with this equipment. Remember to remove the tape and refit the antenna after washing.

### Cleaning the headlights

As the headlights are made of plastic “glass”, use a soft cloth or cotton wool to clean them. If this does not clean them properly, moisten the cloth with soapy water, then wipe clean with a soft damp cloth or cotton wool. Finally, carefully dry off with a soft dry cloth.

**Cleaning products containing alcohol must not be used.**

## INTERIOR TRIM MAINTENANCE (1/2)

A well-maintained vehicle will last longer. It is therefore recommended to maintain the interior of the vehicle regularly.

A stain should always be dealt with swiftly.

Whatever type of stain is on the trim, use **cold** (or warm) **soapy water with natural soap**.

**Detergents (washing-up liquid, powdered products, alcohol-based products) should not be used.**

Use a soft cloth.

Rinse and soak up the excess.

### Glass instrument panel

(e.g.: instrument panel, clock, exterior temperature display, radio display, multimedia or multifunction display etc.)

Use a soft cloth (or cotton wool).

If this does not clean them properly, use a soft cloth (or cotton wool) slightly moistened with soapy water and then wipe clean with another soft damp cloth or cotton wool.

Finally, **carefully** dry off with a soft dry cloth.

**Do not use products containing alcohol and/or spray fluids on the area.**

### Seat belts

These must be kept clean.

Use products selected by our Technical Department (Approved outlets) or warm, soapy water and a sponge and wipe with a dry cloth.

**Detergents or dyes must not be used under any circumstances.**

### Textiles (seats, door trim, etc)

Vacuum-clean the textiles **regularly**.

#### Liquid stain

Use soapy water.

Dab lightly (never rub) with a soft cloth, rinse and remove the excess.

#### Solid or pasty stain

Carefully remove the excess solid or pasty material **immediately** with a spatula (working from the edges to the centre to avoid spreading the stain). Clean as for a liquid stain.

#### Special instructions for sweets or chewing gum

Put an ice cube on the stain to solidify it, then proceed as for a solid stain.

For further recommendations for maintaining the interior, and/or for any unsatisfactory results, please see an authorised dealer.

## INTERIOR TRIM MAINTENANCE (2/2)

### Removal/replacing removable equipment originally fitted in the vehicle

If you need to remove equipment in order to clean the passenger compartment (for example, mats), always ensure that they are correctly refitted and are the right way around (the driver's mat should be fitted on the driver's side, etc.) and fit them with the components supplied with the equipment (for example, the driver mat should always be fixed using the pre-fitted mounting components).

With the vehicle stationary, ensure that nothing will impede driving (anything obstructing the pedals, heel wedged by the mat, etc.).

### You should not:

You are strongly advised not to position objects such as deodorants, scents, etc. near air vents, as this could damage your dashboard trim.



You are strongly recommended not to use high-pressure or spray cleaning equipment inside the passenger compartment: use of such equipment could impair the correct functioning of the electrical or electronic components in the vehicle, or have other detrimental effects.



# Section 5: Practical advice

Puncture . . . . .	5.2
Emergency spare wheel . . . . .	5.2
Tyre inflation kit . . . . .	5.4
Tools . . . . .	5.8
Wheels, trim. . . . .	5.10
Changing a wheel . . . . .	5.11
Tyres . . . . .	5.13
Headlights: changing bulbs . . . . .	5.16
Fog lights: changing bulbs. . . . .	5.18
Rear lights: changing bulbs . . . . .	5.19
Indicator lights: changing bulbs . . . . .	5.22
Interior lighting: changing bulbs. . . . .	5.23
Battery: troubleshooting. . . . .	5.25
Fuses. . . . .	5.27
Wiper blades . . . . .	5.29
Towing: breakdown . . . . .	5.31
Fitting a radio. . . . .	5.33
Accessories . . . . .	5.35
Key, radio frequency remote control: battery. . . . .	5.36
Operating faults . . . . .	5.37

## PUNCTURE, EMERGENCY SPARE WHEEL (1/2)

In the event of a puncture, there is either an emergency spare wheel or tyre inflation kit available, depending on the vehicle (refer to the information in the following pages).

### Emergency spare wheel 2

This is stored in cage 4 under the floor at the rear of the vehicle.

#### To access the emergency spare wheel

- Open the tailgate.
- Undo the nut with the wheelbrace 1.
- Detach the cage using handle 3.
- Release the emergency spare wheel.



If the vehicle is parked on the hard shoulder, you must warn other road users of your vehicle's presence with a warning triangle or with other devices as per the legislation applying to the country you are in.

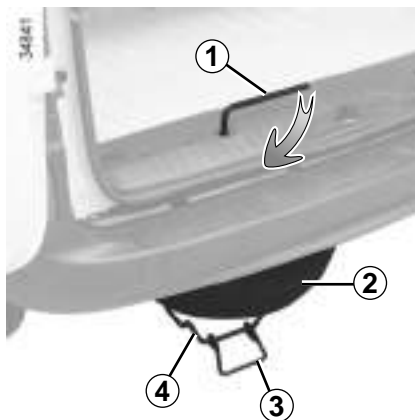

#### To store the wheel in the cage

- Make sure the wheel is correctly positioned in the cage, valve facing down.
- Reposition the cage using handle 3 and retighten the nut using spanner 1 to refit the assembly.
- Make sure it is correctly locked.

### Vehicle fitted with a tyre pressure loss warning system

If under-inflated (puncture, low pressure, etc.), the warning light  lights up on the instrument panel. See “Tyre pressure loss warning” in Section 2.

## PUNCTURE, EMERGENCY SPARE WHEEL (2/2)



If the emergency spare wheel has been stored for several years, have it checked by your Dealer to ensure that it is safe to use.

### **Vehicle fitted with an emergency spare wheel that differs from the other wheels:**

- Never fit more than one emergency spare wheel to the same vehicle.
- As the punctured wheel is wider than the emergency spare wheel, the vehicle's ground clearance is reduced.
- Replace the emergency spare wheel as soon as possible with a wheel identical to the original one.
- If wheel bolts are supplied with the emergency spare wheel, it is imperative that they are used and that they are used for the emergency spare wheel only: refer to the label affixed to the emergency spare wheel.
- When this is fitted to the vehicle, which must only be a temporary measure, the driving speed must not exceed the speed indicated on the label on the wheel.
- Fitting an emergency spare wheel may alter the way the vehicle usually runs. Avoid sudden acceleration or deceleration and reduce your speed when cornering.
- If you need to use snow chains, fit the emergency spare wheel to the rear axle and check the tyre pressure.
- The warning light  on the instrument panel flashes for several seconds, then stays on.

## TYRE INFLATION KIT (1/4)

30208



The kit repairs tyres when tread **A** has been damaged by objects smaller than 4 mm. It cannot repair all types of puncture, such as cuts larger than 4 mm, or cuts in tyre sidewall **B**.

Ensure also that the wheel rim is in good condition.

Do not pull out the foreign body causing the puncture if it is still in the tyre.



Do not attempt to use the inflation kit if the tyre has been damaged as a result of driving with a puncture.

You should therefore carefully check the condition of the tyre sidewalls before any operation.

Driving with underinflated, flat or punctured tyres can be dangerous and may make the tyre impossible to repair.

### **This repair is temporary.**

A tyre which has been punctured should always be inspected (and repaired, where possible) as soon as possible by a specialist.

When taking a tyre which has been repaired using this kit to be replaced, you must inform the specialist.

When driving, vibration may be felt due to the presence of the repair product injected into the tyre.



The kit is only approved for inflating the tyres of the vehicle originally equipped with the kit.

It must never be used to inflate the tyres of another vehicle, or any other inflatable object (rubber ring, rubber boat, etc.).

Avoid spillage on skin when handling the repair liquid bottle. If droplets do leak out, rinse them off with plenty of water.

Keep the repair kit away from children.

Do not dispose of the empty bottle in the countryside. Return it to your approved dealer or to a recycling organisation.

The bottle has a limited service life which is indicated on its label. Check the expiry date.

Contact an approved dealer to replace the inflation tube and repair product bottle.

## TYRE INFLATION KIT (2/4)

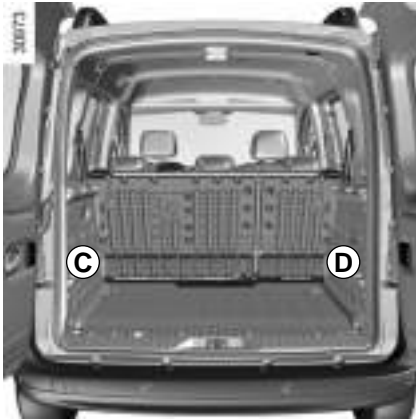

Depending on the vehicle, in the event of a puncture, use the kit located in the glove box or in the luggage compartment, in rear wheel arch **C** or **D**.

### Vehicle fitted with a tyre pressure loss warning system

If under-inflated (puncture, low pressure, etc.), the warning light  lights up on the instrument panel. See “Tyre pressure loss warning” in Section 2.



Before using this kit, park the vehicle at a sufficient distance from traffic, switch on the hazard warning lights, apply the handbrake, ask all passengers to leave the vehicle and keep them away from traffic.

If the vehicle is parked on the hard shoulder, you must warn other road users of your vehicle's presence with a warning triangle or with other devices as per the legislation applying to the country you are in.

## TYRE INFLATION KIT (3/4)

42172

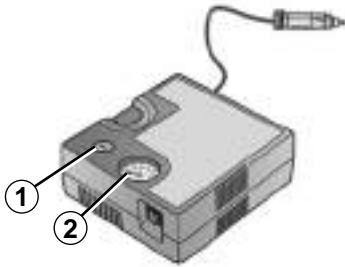

### Engine running, parking brake applied:

- Refer to the information on the inflation kit compressor and follow the instructions;
- inflate the tyre to the recommended pressure (please refer to the information in the section on “Tyre pressures”);

- after a maximum of **15 minutes**, stop inflating and read the pressure (on the pressure gauge **2**).

**Note:** while the bottle is emptying (approximately 30 seconds), the pressure gauge **2** will indicate briefly a pressure of **6 bar**, then the pressure drops;

- Adjust the pressure: to increase it, continue inflation with the kit. To reduce it, press the button **1**.

**If a minimum pressure of 1.8 bar is not reached after 15 minutes, repair is not possible; do not drive the vehicle but contact an approved dealer.**

## TYRE INFLATION KIT (4/4)

Once the tyre is correctly inflated, remove the kit: slowly unscrew the inflation end piece to prevent any product spatter and store the container in plastic packaging to prevent product leaks.

- Affix the driving recommendation label to the dashboard where it can easily be seen by the driver;
- put the kit away;
- at the end of this initial inflation operation, air will still escape from the tyre; you must drive a short distance in order to seal the hole;
- start immediately and drive at between 12.4 and 37.2 mph (20 and 60 km/h) in order to distribute the product evenly in the tyre and, after driving for 1.86 miles (3 km), stop and check the pressure;
- if the pressure is greater than 1.3 bar but less than the recommended pressure, re-adjust it (refer to the label affixed to the edge of the driver's door), otherwise contact an approved dealer: repair is not possible.

### Precautions when using the kit

The kit should not be operated for more than 15 consecutive minutes.



Nothing should be placed around the driver's feet as such objects may slide under the pedals during sudden braking manoeuvres and obstruct their use.



Please be aware that a poorly tightened or missing valve cap can make the tyres less airtight and lead to pressure loss.

Always use valve caps identical to those fitted originally and tighten them fully.



Following repair with the kit, do not travel further than 120 miles (200 km). In addition, reduce your speed and under no circumstances exceed 48 mph (80 km/h). The sticker, which you must affix in a prominent position on the dashboard, reminds you of this. Depending on the country or local legislation, a tyre repaired with the inflation kit may need to be replaced.

## TOOL KIT (1/2)

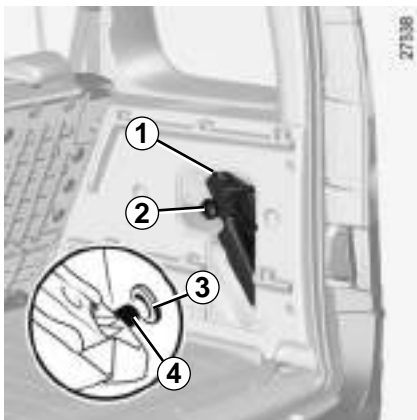

Depending on the vehicle, remove the tool kit or any tools.

### To remove the tool kit 1 from the luggage compartment

If stored behind a flap, open it. Undo the wheel 2 and pull the tool kit towards you.

### Repositioning the tool kit

Put the tool kit pin 4 into the hole 3. Fit the kit correctly and tighten the wheel 2.

### Repositioning the tools

Put them into their slots. Check everything is correctly positioned.



Do not leave the tools unsecured inside the vehicle as they may come loose under braking. After use, check that all the tools are correctly clipped into the tool kit, then position it correctly in its housing: risk of injury.

If wheel bolts are supplied with the emergency spare wheel, it is imperative that they are used and that they are used for the emergency spare wheel only: refer to the label affixed to the emergency spare wheel.

The jack is designed for wheel changing purposes only. Under no circumstances should it be used for carrying out repairs underneath the vehicle or to gain access to the underside of the vehicle.



## TOOL KIT (2/2)

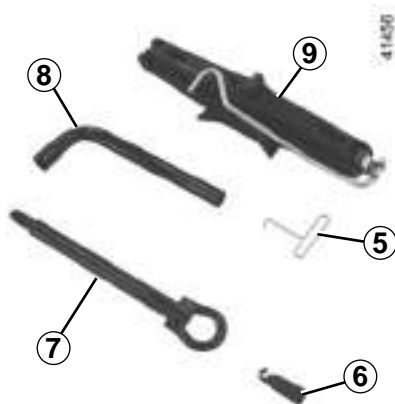

The tools included in the tool kit depend on the vehicle.

### **Hubcap tool 5**

To remove the wheel trims.

### **Screw guide 6**

To finish loosening or starting to tighten the wheel bolts.

### **Tow eye 7**

Refer to the information on the “Towing: breakdown” in Section 5.

### **Wheel brace 8**

To undo the wheel bolt and the emergency spare wheel cage nut.

### **Jack 9**

Refer to Section 5 “Changing a wheel”.

### **Retaining belt**

After use, reposition the strap making sure that it retains all components in the tool kit.

## WHEELS, TRIM

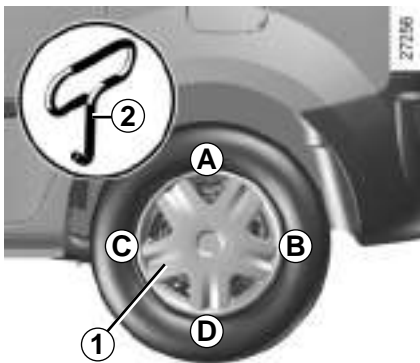

### Wheel trim 1 (concealed wheel bolts)

Remove it using hubcap tool **2** (located under the tool kit), by pushing the hook into the opening located near the valve (to reach the metal retaining wire located behind the wheel trim).

To refit it, align it with the valve. Push the retaining hooks, starting with side **A** on the valve side, then **B** and **C** and finish with the side opposite the valve **D**.

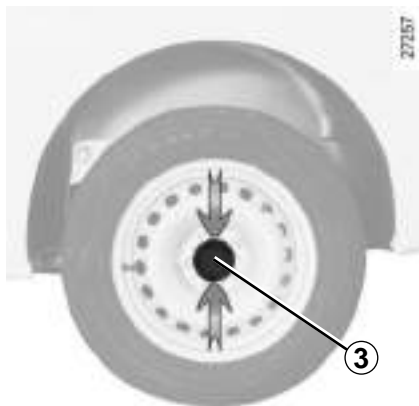

### Wheel trim 3 (exposed wheel bolts)

To remove it without removing the wheel, press it at the points indicated by the arrows.

Turn it so that the retaining brackets holding it in place behind the wheel bolts are released.

To refit the hubcap, proceed in reverse order.

## CHANGING A WHEEL (1/2)



Switch on the hazard warning lights.

Keep the vehicle away from traffic and on a level surface where it will not slip.

Apply the parking brake and engage a gear (first or reverse, or **P** for automatic transmissions).

Ask all the passengers to leave the vehicle and keep them away from traffic.

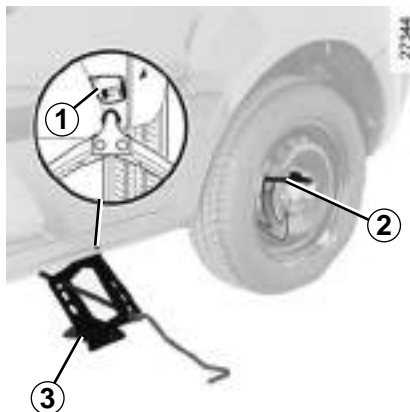

### Vehicles equipped with a jack and wheelbrace

If necessary, remove the wheel trim.

Use the wheelbrace to slacken off the wheel bolts **2**. Position it so as to be able to push from above.

If the vehicle is not equipped with a jack or wheelbrace, you can obtain these from your approved dealer.

Crank up jack **3** by hand to position the jack head against the jacking point closest to the relevant wheel and marked by an arrow **1**.

Continue to crank the jack so that the baseplate is correctly positioned (it should be underneath the vehicle and aligned with the jack head).

Turn it a few times to lift the wheel off the ground.



If the vehicle is parked on the hard shoulder, you must warn other road users of your vehicle's presence with a warning triangle or with other devices as per the legislation applying to the country you are in.



To prevent any risk of injury or damage to the vehicle, raise the jack until the wheel you are replacing is a maximum of 3 centimetres off the ground.

## CHANGING A WHEEL (2/2)

Undo the bolts and take off the wheel. For vehicles fitted with alloy wheels, use the guide bolt located in the tool kit to finish loosening and start tightening the bolts.

Fit the emergency spare wheel on the central hub and turn it to align the mounting holes in the wheel and the hub.

Tighten the bolts, checking that the wheel is correctly positioned on its hub.

Lower the jack.

If bolts are supplied with the emergency spare wheel, only use these bolts for the emergency spare wheel.

With the wheel on the ground, tighten the bolts fully and have the tightness of the bolts checked and the emergency spare wheel pressure checked as soon as possible.

### Anti-theft bolts

If you use anti-theft bolts, fit these nearest the valve (wheel trim may not be able to fit).

### Vehicle fitted with a tyre pressure loss warning system

If under-inflated (puncture, low pressure, etc.), the warning light  lights up on the instrument panel. See “Tyre pressure loss warning” in Section 2.



If you have a puncture, replace the wheel as soon as possible.

A tyre which has been punctured should always be inspected (and repaired, where possible) by a specialist.

## TYRES (1/3)

### Tyre and wheel safety

The tyres are the only contact between the vehicle and the road, so it is essential to keep them in good condition. You must make sure that your tyres conform to local road traffic regulations.



For your safety, please respect the speed limit.

When they need to be replaced, only tyres of the same make, size, type and profile should be used on a single axle.

**They must: either have a load capacity and a speed capacity at least equal to the original tyres, or correspond to those recommended by your authorised dealer.**

Failure to heed these instructions could endanger your safety and affect your vehicle's roadworthiness.

**Risk of loss of control of the vehicle.**

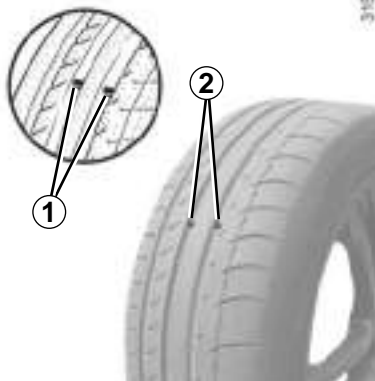

### Maintaining the tyres

The tyres must be in good condition and the tread form must have sufficient depth; tyres approved by our Technical Department have tread wear indicators **1** which are **indicators moulded into the tread at several points.**

When the tyre tread has been eroded to the level of the warning strips, **they become visible 2: it is then necessary to replace your tyres because the tread profile is no more than 1.6 mm deep and this causes poor road holding on wet roads.**

An overloaded vehicle, long journeys by motorway, particularly in very hot weather, or continual driving on poorly surfaced minor roads will lead to more rapid tyre wear and affect safety.



Incidents which occur when driving, such as striking the kerb, may damage the tyres and wheel rims, and could also lead to misalignment of the front or rear axle geometry. In this case, have the condition of these checked by an approved dealer.

## TYRES (2/3)

### Tyre pressures

Respect the tyre pressures (including the emergency spare wheel). The tyre pressures should be checked at least once a month and additionally before any long journey (refer to the label affixed to the edge of the driver's door, described in the information on "Tyre pressures" in Section 4).



#### Incorrect tyre pressures

lead to abnormal tyre wear and unusually hot running. These are factors which may seriously affect safety and lead to:

- poor road holding;
- risk of bursting or tread separation.

The pressure depends on the load and the speed of use. Adjust the pressures according to the conditions of use (refer to the information on "Tyre pressures").

Pressures should be checked when the tyres are cold; ignore higher pressures which may be reached in hot weather or following a fast journey.

If tyre pressures cannot be checked when the tyres are **cold**, the normal pressures must be increased by **0.2** to **0.3 bar (or 3 PSI)**.

**Never deflate a hot tyre.**



Please be aware that a poorly tightened or missing valve cap can make the tyres less airtight and lead to pressure loss.

Always use valve caps identical to those fitted originally and tighten them fully.

### Vehicle fitted with a tyre pressure loss warning system

If under-inflated (puncture, low pressure, etc.), the warning light  lights up on the instrument panel. See "Tyre pressure loss warning" in Section 2.

### Fitting new tyres



For safety reasons, this operation must be carried out by a specialist.

Fitting different tyres may change your vehicle as follows:

- may mean that your vehicle no longer conforms to current regulations;
- it may change the way it handles when cornering;
- it may cause the steering to be heavy;
- It may affect the use of snow chains.

## TYRES (3/3)

### Changing wheels around

This practice is not recommended.

### Emergency spare wheel

Refer to the information on the “Emergency spare wheel” and instructions on “Changing a wheel” in Section 5.

### Use in winter

#### – Chains

**For safety reasons, fitting snow chains to the rear axle is strictly forbidden.**

**Chains must not be fitted** to tyres which are larger than those originally fitted to the vehicle.



Chains may only be fitted to tyres of the same size as those originally fitted to **your vehicle**.

Only certain chains can be fitted to tyres. Consult an approved Dealer.

#### – Snow or winter tyres

We would recommend that these be fitted to **all four wheels** to ensure that your vehicle retains maximum grip.

**Note:** be aware that these tyres may sometimes have:

- a direction of travel;
- a maximum speed index which may be lower than the maximum speed of your vehicle.

#### – Studded tyres

This type of equipment may only be used for a limited period and as laid down by local legislation.

It is necessary to observe the speed specified by current legislation.

These tyres must, at a minimum, be fitted to the two front wheels.

In all cases, we would recommend that you contact an approved dealer who will be able to advise you on the choice of equipment which is most suitable for your vehicle.

## LIGHTS: changing bulbs (1/2)

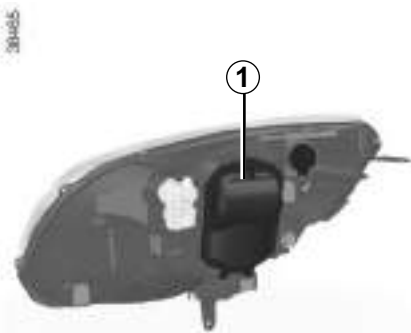

### Dipped beam/main beam headlights

Open the cover **1**.

Disconnect the bulb holder wiring **2**.

Unclip spring **3** to remove the bulb holder **2**.



Before performing any action in the engine compartment, the ignition must be switched off (please see the information on "Starting, stopping the engine" in Section 2).

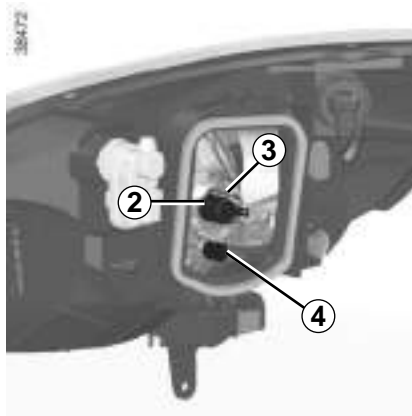

### Bulb type: H4

It is essential to use 55W anti UV bulbs to prevent damage to the lights' plastic glass.

### Do not touch the bulb glass. Hold it by its base.

To refit it, carry out the above operations in reverse order.

Make sure you reposition the wiring in its housing before closing the cover **1**.

### Front side light

Open the cover **1**.

Disconnect the bulb holder wiring **4**.

Remove bulb holder **4** from its housing. Replace the bulb.

### Bulb type: W5W

To refit it, carry out the above operations in reverse order.



The engine may be hot during operations in close proximity. In addition, the engine cooling fan may start at any moment.

Risk of injury.



The bulbs are under pressure and can break when replaced.

Risk of injury.



## LIGHTS: changing bulbs (2/2)

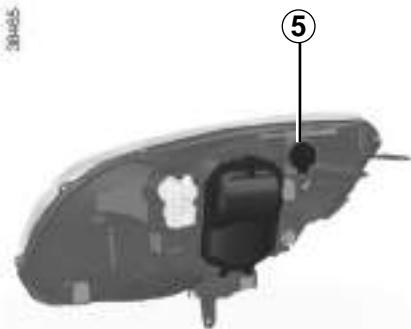

### Direction indicator lights

Turn bulb holder **5** to unlock it and remove it from its location, without disconnecting the wiring. Replace bulb .

#### **Bulb type: PY21W**

To refit it, carry out the above operations in reverse order.

To comply with local legislation, or as a precaution, you can obtain an emergency kit containing a set of spare bulbs and fuses from an approved Dealer.



The bulbs are under pressure and can break when replaced.  
Risk of injury.

## FOG LIGHTS: changing bulbs



### Front fog lights 1

As it is necessary to remove parts or components (front bumper), **you are advised to have your bulbs replaced by an approved dealer.**

**Bulb type: H16**



The engine may be hot during operations in close proximity. In addition, the engine cooling fan may start at any moment.

Risk of injury.

### Additional lights

If you wish to fit your car with fog lights or long range headlights, consult an approved Dealer.



The bulbs are under pressure and can break when replaced.

Risk of injury.



Any operation on (or modification to) the electrical system must be performed by an approved dealer since an incorrect connection might damage the electrical equipment (harness, components and in particular the alternator). In addition, your Dealer has all the parts required for fitting these units.



### Rear fog lights 2

As it is necessary to remove parts or components (rear bumper), **you are advised to have your bulbs replaced by an approved dealer.**

**Bulb type: P21 W**

## REAR LIGHTS: changing bulbs (1/3)

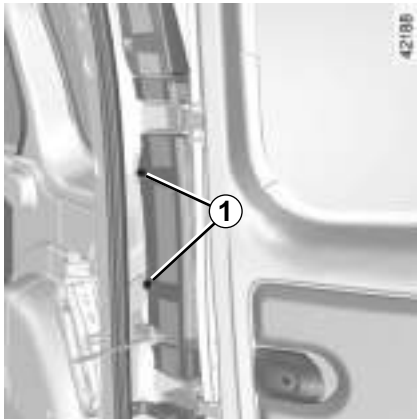

### Rear lights

Depending on the vehicle, open the hinged doors or the tailgate.

Undo bolts **1** using a Torx tool.

Unclip the lower section, then the upper section of the light by pulling it towards you.

Pull tabs **2** to unclip bulb holders **3**.

Replace the bulb, then proceed in the reverse order to refit the bulb.

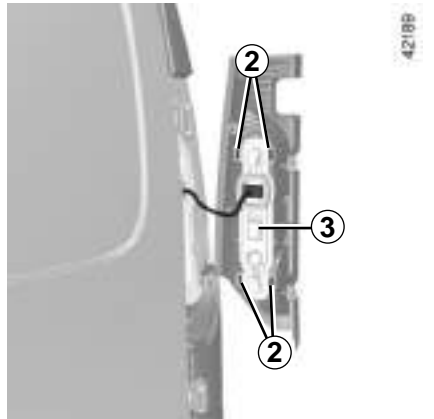

### Bulb type

#### 4 Indicator

Pear-shaped, bayonet type bulb **P Y21W**.

#### 5 Side and brake light

Pear-shaped, bayonet type bulb with two filaments **P 21/5W**.

#### 6 Reversing light

Pear-shaped, bayonet type bulb **P 21W**.

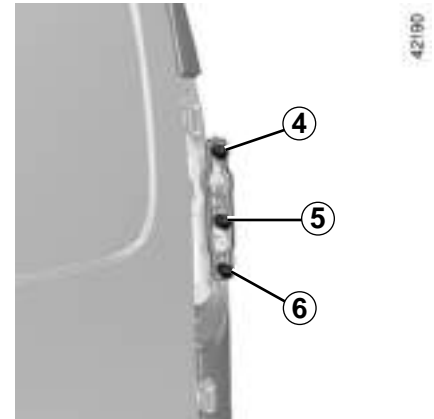

The bulbs are under pressure and can break when replaced.

**Risk of injury.**

## REAR LIGHTS: changing bulbs (2/3)



### High-level brake light

- **Version with tailgate:** it is located above the rear screen, in the centre.
- **Version with hinged doors:** it is located above the rear screen, on the left-hand door.



Remove the two plastic blanking covers **7** from the inside. Unclip the light using a screwdriver, by pressing in the metal clip housings.

Remove light **8** from the outside. Replace the bulb without disconnecting the wiring.

### Bulb type: W16W

For refitting, proceed in the reverse order to removal.

Check the tabs are correctly locked in position.

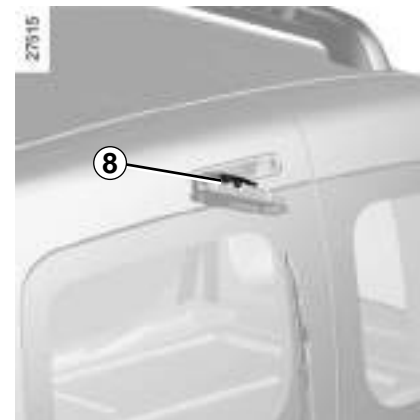

## REAR LIGHTS: changing bulbs (3/3)



### Number plate light

Undo two bolts **9** using a Torx tool.



Release the light to access bulbs **10**.

**Bulb type: W5W.**

Replace the bulbs, then fit the light in position.

## INDICATOR LIGHTS: changing bulbs

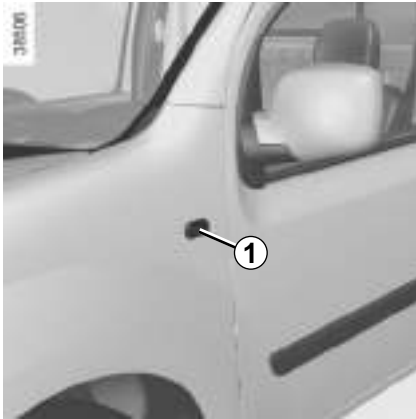

Unclip indicator light **1** on the door side, using a flat-blade screwdriver type tool.

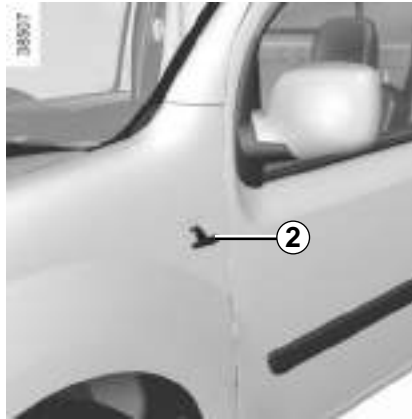

Turn bulb holder **2** a quarter of a turn and take out the bulb.

**Bulb type: WY5W.**

Replace the bulb and refit the indicator light.

## INTERIOR LIGHTING: changing bulbs (1/2)

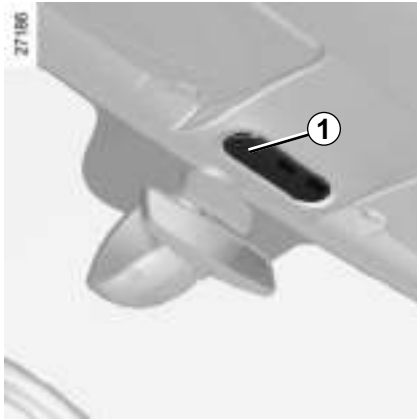

### Passenger compartment lights

Remove lens **1** using a tool such as a flat-blade screwdriver.

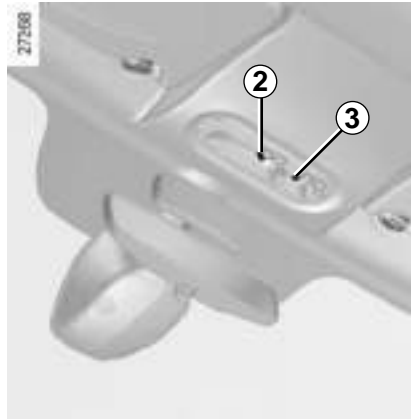

Pull bulbs **2** and **3** downwards to remove them from their housings.

**Bulb type 2: W6W**

**Bulb type 3: W5W**

**Type of rear courtesy light bulb: W6W or, depending on the vehicle, W5W**

Replace the bulbs and replace the lens.

## INTERIOR LIGHTING: changing bulbs (2/2)

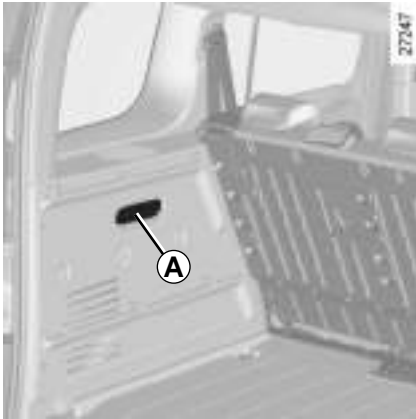

### Light A

Remove the lens using a tool such as a flat-blade screwdriver.

Pull the bulb to remove it from its housing.

#### **Bulb type A: W5W**

Replace the bulb and refit the lens.

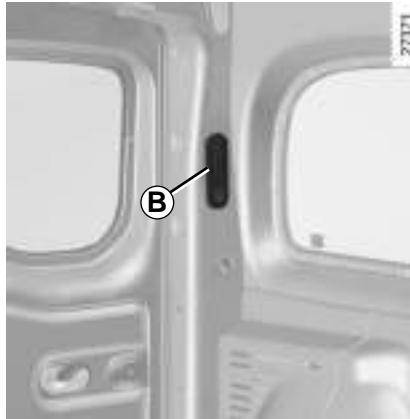

### Light B

Remove the lens using a tool such as a flat-blade screwdriver.

Pull the bulb to remove it from its housing.

#### **Bulb type B: W6W**

Replace the bulb and refit the lens.



## BATTERY: troubleshooting (1/2)

### To avoid all risk of sparks:

- Ensure that any consumers (courtesy lights, etc.) are switched off before disconnecting or reconnecting the battery.
- When charging, stop the charger before connecting or disconnecting the battery.
- Do not place metal objects on the battery to avoid creating a short circuit between the terminals.
- Always wait at least twenty seconds after the engine has been switched off before disconnecting a battery.
- Make sure that you reconnect the battery terminals after refitting.



Before performing any action in the engine compartment, the ignition must be switched off (please see the information on “Starting, stopping the engine” in Section 2).



Handle the battery with care as it contains sulphuric acid, which must not come into contact with eyes or skin. If it does, wash the affected area with plenty of cold water.

Ensure that naked flames, red hot objects and sparks do not come into contact with the battery as there is a risk of explosion.

The engine may be hot when carrying out operations in close proximity. In addition, the engine cooling fan can come on at any moment.

**Risk of injury.**

### Connecting a battery charger

**The battery charger must be compatible with a battery with nominal voltage of 12 volts.**

Switch the engine off and then disconnect both battery leads **starting with the negative terminal.**

Do not disconnect the battery when the engine is running. **Follow the instructions given by the manufacturer of the battery charger you are using.**

## BATTERY: troubleshooting (2/2)

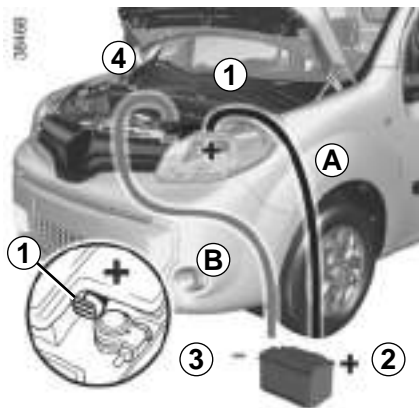

### Starting the vehicle using the battery from another vehicle

If you have to use the battery from another vehicle to start, obtain suitable jump leads (with a large cross section) from an approved dealer or, if you already have jump leads, ensure that they are in perfect condition.

**The two batteries must have an identical nominal voltage of 12 volts.** The battery supplying the current should have a capacity (amp-hours, Ah) which is at least the same as that of the discharged battery.

Ensure that there is no risk of contact between the two vehicles (risk of short circuiting when the positive terminals are connected) and that the discharged battery is properly connected. Switch off your vehicle ignition.

Start the engine of the vehicle supplying the current and run it at an intermediate engine speed.

Connect the positive (+) lead **A** to (+) terminal **1** of the discharged battery, then to (+) terminal **2** of the battery supplying the current.

Connect the negative (-) lead **B** to (-) terminal **3** of the battery supplying the current and then to (-) terminal **4** of the discharged battery.

Check that there is no contact between leads **A** and **B** and that the positive (+) lead **A** is not touching any metal parts on the vehicle supplying the current.

Start the engine as normal. As soon as it is running, disconnect leads **A** and **B** in the reverse order (**4-3-2-1**)



Special procedures may be required to charge some batteries. Contact your approved dealer.

Avoid all risk of sparks which may cause an immediate explosion, and charge the battery in a well ventilated area.

**Risk of serious injury.**

## FUSES (1/2)



### Fuse box

If any electrical component does not work, check the condition of the fuses.

Unclip cover **A**.

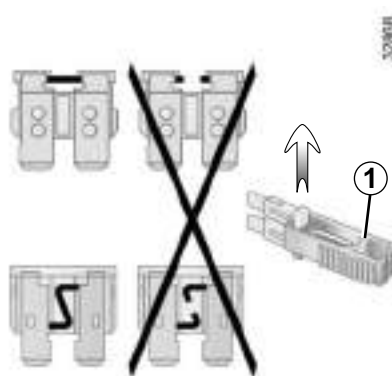

### Tweezers 1

Remove the fuse using tweezers **1**, located at the back of cover **A**.

To remove the fuse from the tweezers, slide the fuse to the side.

To locate the fuses, please see the following page.

It is not advisable to use the free fuse locations.

Some functions are protected by fuses located in the engine compartment. However, because of their reduced accessibility, **it is recommended to have these fuses replaced by an authorised dealer.**



Check the fuse in question and **replace it, if necessary, with a fuse of the same rating.**

If a fuse is fitted where the rating is too high, it may cause the electrical circuit to overheat (risk of fire) in the event of an item of equipment using an excessive amount of current.

To comply with local legislation, or as a precaution, you can obtain an emergency kit containing a set of spare bulbs and fuses from an approved Dealer.

## FUSES (2/2)

40550

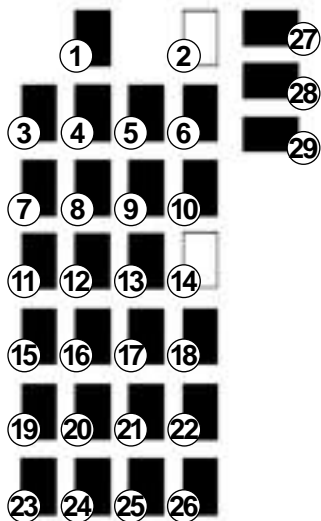

### Allocation of fuses

The presence of certain fuses depends on the vehicle equipment level.

Number	Allocation
1	Fuel pump
2	Not used
3	Passenger compartment engine cooling fan
4	Passenger compartment engine cooling fan
5	Rear windscreen wiper
6	Horn, diagnostic socket
7	Heated seats
8	Electric rear windows
9	Passenger compartment ECU
10	Windscreen washer
11	Brake lights
12	Passenger compartment unit, ABS, ESP
13	Electric windows, child safety, heating and air conditioning system, ECO mode
14	Not used
15	Starter

Number	Allocation
16	Brake lights, additional equipment, navigation, ABS, ESP, boot light, tyre pressure warning light, interior lights, rain and light sensor
17	Radio, navigation system, display, alarm
18	Additional equipment
19	Heated door mirrors
20	Hazard lights, rear fog lights
21	Central locking of opening elements
22	Instrument panel
23	Rear accessories socket
24	ESC, radio, heating and air conditioning system, heated seats, stop lights
25	Front accessories socket
26	Towbar
27	Electric front windows
28	Rear-view mirror control
29	De-icing the rear screen and rear view mirror

## WINDSCREEN WIPER BLADES (1/2)

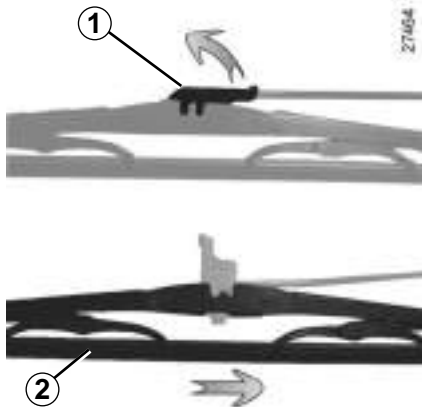

### Replacing windscreen wiper blades 2

- With the ignition switched off, lift wiper arm 2 slightly;
- pull tab 1 upwards;
- move the blade in the direction of the arrow.

For refitting, proceed in the reverse order and ensure that the blade is correctly clipped on.

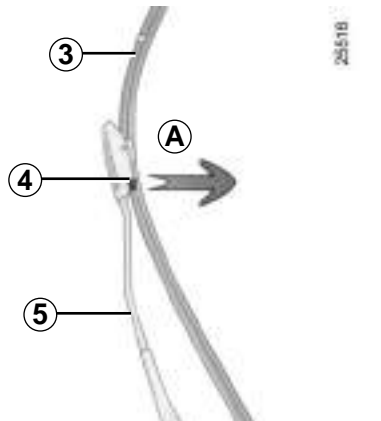

### Replacing windscreen wiper blades 3

- With the ignition switched off, lift wiper arm 5 slightly;
- pull the tab 4 (movement A) and push the blade upwards.

#### To refit

Slide the blade along the arm until it clips on. Make sure that the blade is correctly locked in position. Return the windscreen wiper stalk to the park position.

Check the condition of the wiper blades. You are responsible for their service life:

- clean the blades, windscreen and rear screen regularly with soapy water;
- do not use them when the windscreen or rear screen are dry;
- free them from the windscreen or rear screen when they have not been used for a long time.



Before changing the wiper blade, make sure the stalk is in the stop position (deactivated).

**Risk of injury.**

## WINDSCREEN WIPER BLADES (2/2)

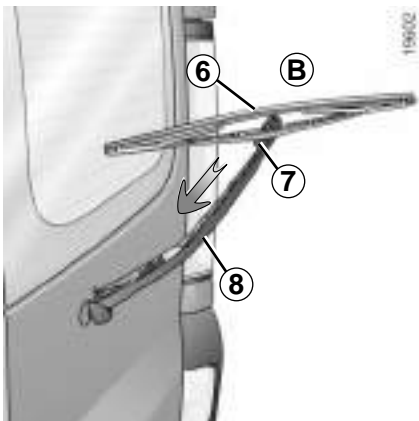

### Replacing the rear screen wiper blade

#### Hinged door versions B

- With the ignition switched off, lift wiper arm **8**;
- pivot the blade **6**;
- press tab **7**;
- pull the blade to release it (arrow).

For refitting, proceed in the reverse order and ensure that the blade is correctly clipped on.

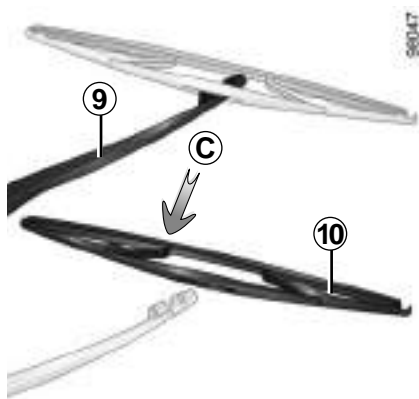

#### Tailgate versions C

- With the ignition switched off, lift wiper arm **9**;
- pivot the blade **10** until some resistance is met;
- pull the blade to release it (arrow).

For refitting, proceed in the reverse order and ensure that the blade is correctly clipped on.



- In frosty weather, make sure that the wiper blades are not stuck by ice (to avoid the risk of the motor overheating).
  - Check the condition of the wiper blades.  
Replace the wiper blades as soon as they begin to lose efficiency (approximately once a year).
- Whilst changing the blade, take care not to drop the arm onto the window after it has been removed as this may break the window.

## TOWING: breakdown (1/2)

Before towing, unlock the steering column: with the clutch dipped, engage **first gear** (lever in **N** or **R** positions for vehicles with an automatic gearbox), insert the key in the ignition-starter switch.

Reposition the lever to neutral (position **N** for vehicles fitted with an automatic gearbox).

The column is unlocked, the accessory functions are supplied: the vehicle lights can be used (indicators, brake lights etc.). At night the vehicle must have its lights on.



Do not remove the key from the ignition when the vehicle is being towed.



When the engine is stopped, steering and braking assistance are not operational.

The speed specified by current legislation for towing must always be observed. If your vehicle is the towing vehicle, do not exceed the maximum towing weight for your vehicle (refer to the information on “Weights” in Section 6).

### Towing a vehicle with an automatic gearbox

**With the engine switched off:** the gearbox is no longer lubricated. It is preferable to tow this type of vehicle on a trailer or tow it with the front wheels off the ground.

**Under exceptional circumstances,** you may tow the vehicle with all four wheels on the ground, **only going forward, with the gear lever in the Neutral position, and for a distance not exceeding 30 miles (50 km).**

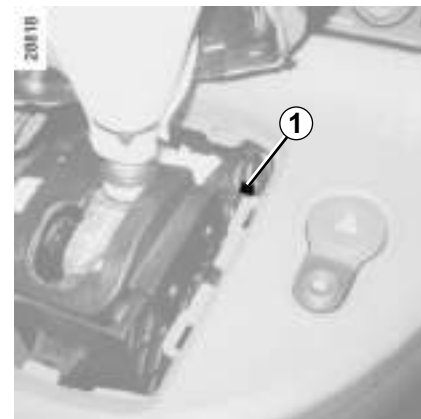

If the lever is stuck in **P**, even though you are depressing the brake pedal, the lever can be released manually.

To do this, unclip the cover at the base of the lever.

Press simultaneously on mark **1** and on the unlocking button on the lever.

## TOWING: breakdown (2/2)



**Only use the front and rear towing points** (never use the driveshafts). These towing points may only be used for towing: never use them for lifting the vehicle directly or indirectly.



Do not leave the tools unsecured inside the vehicle as they may come loose under braking.

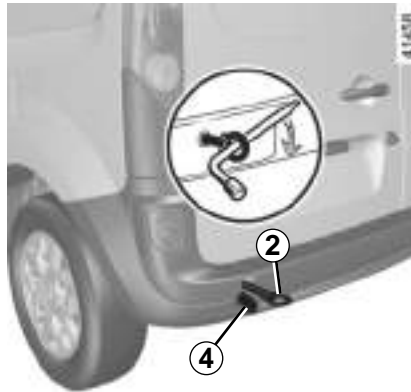

### Access to towing points

Unclip cover **3** or **4**.

**Tighten the towing hitch 2 fully:** first by hand until it stops then finish by locking it with the wheel brace.

Use only the towing eye **2** and the wheelbrace located under the boot carpet with the tools (please refer to the information on "Tools" in Section 5).



– Use a rigid towing bar. If a rope or cable is used (where the law allows this), the vehicle being towed must be able to brake.

- A vehicle must not be towed if it is not fit to be driven.
- Avoid accelerating or braking suddenly when towing, as this may result in damage being caused to the vehicle.
- When towing a vehicle, it is advisable not to exceed **15 mph (25 km/h)**.



## FITTING A RADIO (1/2)

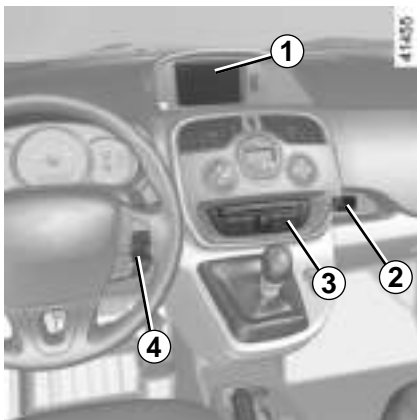

The presence, connections and location of this equipment depend on the vehicle version.

### Radio location

Unclip the blanking cover. The connections for the aerial, + and – supply, and speaker wires are found behind the cover.

- 1 offset display (time, exterior temperature, radio and navigation);
- 2 audio connection socket;
- 3 radio unit;
- 4 radio steering column controls.



### Bass speakers 5

To use this equipment, consult the instructions for the equipment which should be kept with the other vehicle documentation.

## FITTING A RADIO (2/2)

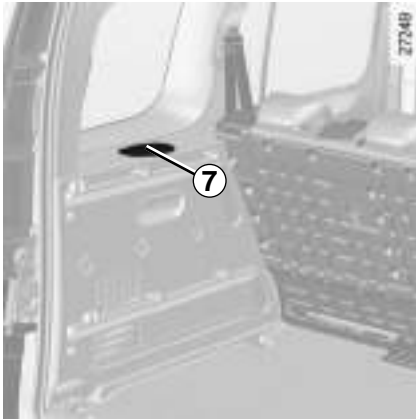

**Rear speakers 7**

- In all cases, it is very important to follow the manufacturer's instructions carefully.
- The specifications of the brackets and wires vary depending on the equipment level of your vehicle and the type of radio.  
Consult an approved Dealer to find out the correct part number.
- No work may be carried out on the vehicle's electrical or radio circuits, except by approved Dealers: an incorrectly connected system may result in damage being caused to the electrical equipment and/or the components connected to it.

## ACCESSORIES



### **Electrical and electronic accessories**

Before installing this type of accessory (particularly for transmitters/receivers: frequency bandwidth, power level, position of the aerial, etc.), make sure it is compatible with your vehicle. You can get advice from an authorised dealer.

Connect accessories with a maximum power of 120 Watts only. **Fire hazard.** When several accessory sockets are used at the same time, the total power of the connected accessories must not exceed 180 watts.

No work may be carried out on the vehicle's electrical or radio circuits, except by authorised dealers: an incorrectly connected system may result in damage being caused to the electrical equipment and/or the components connected to it.

If the vehicle is fitted with any aftermarket electrical equipment, make sure that the installation is correctly protected by a fuse.

Establish the rating and position of this fuse.

### **Using the diagnostic socket**

The use of electronic accessories on the diagnostic socket may cause serious disturbance to the vehicle's electronic systems.

For your safety we recommend that you use only electronic accessories approved by the manufacturer, consult an Approved Dealer. **Serious accident risk.**

### **Use of transmitting/receiving devices (telephones, CB equipment etc.)**

Telephones and CB equipment with integrated aerials may cause interference to the electronic systems originally fitted to the vehicle: it is advisable only to use equipment with an external aerial. **Furthermore, we remind you of the need to conform to the legislation in force concerning the use of such equipment.**

### **Fitting aftermarket accessories**

If you wish to install accessories on the vehicle: please contact an authorised dealer. Also, to ensure the correct operation of your vehicle, and to avoid any risk to your safety, we recommend that you use only accessories specifically designed for your vehicle, which are the only accessories for which the manufacturer will provide a warranty.

If you are using an anti-theft device, only attach it to the brake pedal.

### **Obstructions to the driver**

On the driver's side, only use mats suitable for the vehicle, attached with the pre-fitted components, and check the fitting regularly. Do not lay one mat on top of another. **There is a risk of wedging the pedals.**

# KEY, RADIO FREQUENCY REMOTE CONTROL: battery

27416

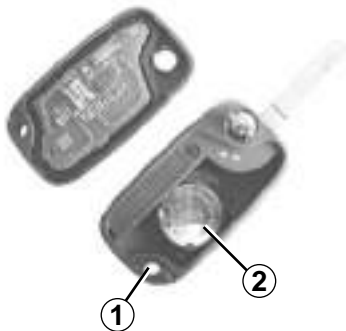

## Special feature of key A

Remove screw 3.

## Replacing the battery

Open the case at slot 1 using a coin, and replace battery 2, observing the polarity shown on the back of the cover.

**Note:** It is not advisable to touch the electrical circuit in the key cover when replacing the battery.

When refitting, ensure that the cover is correctly clipped on and the screw tightened.

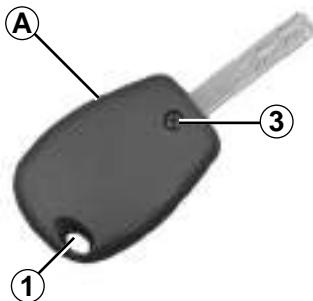

522A



522B

The batteries are available from approved Dealers, and their service life approximately two years.

Check that there is no dye on the battery: risk of an incorrect electrical contact.

Do not dispose of your used batteries in the countryside. Give them to an organisation that collects and recycles used batteries.

20810



## OPERATING FAULTS (1/4)

The following advice will enable you to carry out quick, temporary repairs. For safety reasons, you should always contact an approved Dealer as soon as possible.

<b>The starter is activated</b>	<b>POSSIBLE CAUSES</b>	<b>WHAT TO DO</b>
Warning lights dim or fail to come on; the starter does not run.	Battery terminals disconnected, oxidised or incorrectly secured.	Retighten, reconnect or clean them if they are oxidised.
	Battery discharged or worn.	Connect another battery to the faulty battery. Refer to the paragraph "Battery: troubleshooting" in Section 5 or replace the battery if necessary. Do not push the vehicle if the steering column is locked.
The engine will not start.	Starting conditions are not fulfilled.	Refer to the information on "Starting/stopping the engine" in Section 2.
The steering column remains locked.	Steering wheel locked.	To unlock, move the key and the steering wheel (refer to the information on the "Ignition switch" in Section 2).

## OPERATING FAULTS (2/4)

On the road	POSSIBLE CAUSES	WHAT TO DO
Vibrations.	Tyres not inflated to the correct pressure, incorrectly balanced or damaged.	Check the tyre pressures: if this is not the problem, have them checked by an approved Dealer.
Coolant boiling in the coolant reservoir.	Mechanical fault: damaged cylinder head gasket.	Stop the engine. Contact an approved Dealer.
Smoke under the bonnet.	Short circuit or cooling system leak.	Stop, switch off the ignition, stand away from the vehicle and contact an approved dealer.
The oil pressure warning light comes on:		
while cornering or braking	The level is too low.	Top up the engine oil level (refer to the information on "Engine oil level: topping up/ filling" in Section 4).
is slow to go out or remains lit under acceleration	Loss of oil pressure.	Stop the vehicle and contact an approved Dealer.
White smoke from the exhaust.	This is not necessarily a fault. Smoke may be caused by regeneration of the particle filter.	Refer to the information on "Special features of diesel versions" in Section 2.

## OPERATING FAULTS (3/4)

### On the road

### POSSIBLE CAUSES

### WHAT TO DO

Steering becomes heavy.

Assistance overheating.

Consult an approved Dealer.

The engine overheats. The coolant temperature indicator and the STOP warning light come on.

Engine cooling fan not working.

Stop the vehicle, switch off the engine and contact an approved Dealer.

Coolant leaks.

Check the coolant reservoir: it should contain fluid. If there is no coolant, consult an approved Dealer as soon as possible.



**Radiator:** If there is a lack of coolant, remember that it must never be topped up using cold coolant while the engine is very warm. After any procedure on the vehicle which has involved even partial draining of the cooling system, it must be refilled with a new mixture prepared in the correct proportions. Reminder: only products approved by our Technical Department may be used for this purpose.

## OPERATING FAULTS (4/4)

<b>Electrical equipment</b>	<b>POSSIBLE CAUSES</b>	<b>WHAT TO DO</b>
The wipers do not work.	Wiper blades stuck.	Free the blades before using the wipers.
	Faulty electrical circuit.	Consult an approved Dealer.
	Fuse damaged.	Replace the fuse, refer to the information on "Fuses".
The wiper does not stop.	Faulty electrical controls.	Consult an approved Dealer.
Direction indicators flashing more quickly.	Blown bulb.	Replace the bulb.
The direction indicators do not work.	Faulty electrical circuit.	Consult an approved Dealer.
	Fuse damaged.	Replace the fuse, refer to the information on "Fuses".
The headlights do not switch on or off.	Faulty electrical circuit or control.	Consult an approved Dealer.
	Fuse damaged.	Replace the fuse, refer to the information on "Fuses".
Traces of condensation in the lights.	This is not a fault. Traces of condensation are a natural phenomenon caused by variations in temperature. The traces will disappear slowly once the lights are switched on.	



# Section 6: Technical specifications

Vehicle identification plates . . . . .	6.2
Engine identification plates . . . . .	6.3
Engine specifications. . . . .	6.4
Weights (in kg). . . . .	6.5
Dimensions . . . . .	6.6
Replacement parts and repairs . . . . .	6.8
Service sheets . . . . .	6.9
Anticorrosion check . . . . .	6.15

<https://www.truck-manuals.net/renault/>

# VEHICLE IDENTIFICATION PLATES

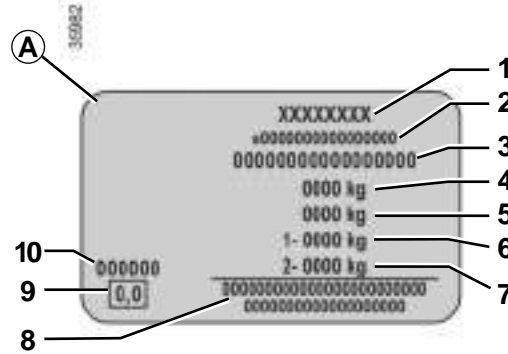
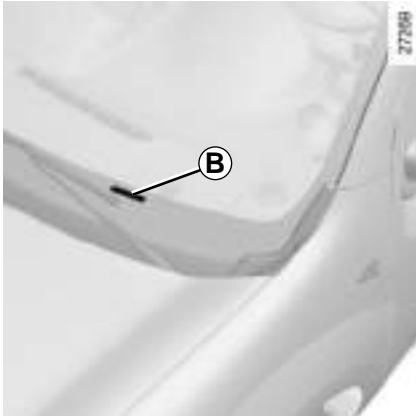

The information shown on the vehicle identification plate should be quoted on all correspondence or orders.

The presence and location of the information depends on the vehicle.

### Vehicle identification plate A

- 1 Manufacturer name.
- 2 EC design number or approval number.
- 3 Identification number.

Depending on the vehicle, this information is also given on marking B.

- 4 MAM (Maximum Authorised Mass).
- 5 GTW (Gross train weight: vehicle fully loaded, with trailer).
- 6 MPAW (Maximum Permissible Weight) for front axle.
- 7 MPAW on rear axle.
- 8 Reserved for related or additional entries.
- 9 Diesel exhaust emissions.
- 10 Paint reference (colour code).

# ENGINE IDENTIFICATION PLATES

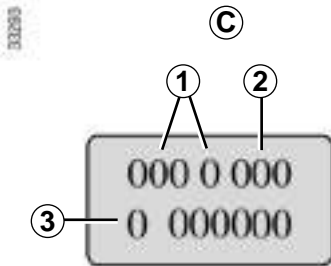

Quote the details given on engine plate **C** on all communication or orders.

(Location varies depending on engine)

- 1 Engine type.
- 2 Engine suffix.
- 3 Engine number.

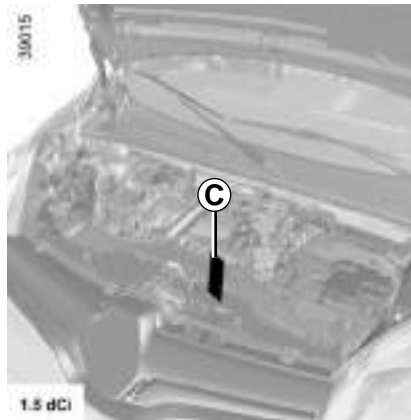

## ENGINE SPECIFICATIONS

Versions	1.2 TCe	1.6 16V	1.5 dCi
<b>Engine type</b> (see engine plate)	H5F Turbo	K4M	K9K
<b>Cubic capacity (cc)</b>	1 197	1 598	1461
<b>Type of fuel</b> <b>Octane rating</b>	<p>It is <b>essential</b> that you use unleaded petrol of the octane rating stated on the label inside the fuel filler flap.</p> <p>If not available, for a limited time only, use unleaded fuel:</p> <ul style="list-style-type: none"> <li>– with an octane rating of 91 for a label showing 95 or 98;</li> <li>– with an octane rating of 87 for a label showing 91, 95 or 98.</li> </ul>		Diesel: the label located in the fuel filler flap indicates authorised fuels.
<b>Spark plugs</b>	<p>Only use the spark plugs specified for your vehicle's engine.</p> <p>The type should be marked on a label affixed inside the engine compartment. If it is not then contact an approved Dealer.</p> <p>Fitting spark plugs other than those specified may damage the engine.</p>		–

## WEIGHTS (in kg)

The weights indicated are for a basic vehicle without options: they vary depending on the your vehicle's equipment. Contact an approved Dealer.

Maximum permissible all-up weight (MMAC) Total train weight (MTR)	Van version	Estate version
	Weights are indicated on the vehicle identification plate (refer to the information on "Vehicle identification plates" in Section 6)	
Braked Trailer Weight *	found by calculating: <b>MTR - MMAC</b>	
Unbraked trailer weight *	610	695
Permissible nose weight *	75	
Maximum permissible load on roof	100 (including the carrying device)	

### \* Towing weight (Towing a caravan, boat, etc.)

Towing is prohibited when the GTW - MAM calculation is equal to zero, or when the GTW is equal to zero (or is not listed) on the identification plate.

- It is important to respect local towing regulations in force, specifically those set out in the Highway Code. Please contact your authorised dealer about adapting any towing equipment.
- When towing, under no circumstances may **the total train weight (vehicle + trailer) be exceeded**. However the following is permitted:
  - the Maximum permissible weight at the rear may be exceeded by no more than 15%,
  - the maximum permissible all-up weight may be exceeded by no more than 10% or 100 kg (whichever occurs first).In either case, the maximum speed of the vehicle and trailer must not exceed 48 mph (80 km/h) (van versions) or 60 mph (100 km/h) (estate versions) and the tyre pressure must be increased by 0.2 bar (3 PSI).
- The engine output and climbing capability are reduced with altitude. We recommend that the maximum load be reduced by 10% at an altitude of 1,000 metres and by an additional 10% for each 1,000 metres thereafter.

### Load transfer on Estate versions, average wheelbase

Depending on the local legislation, if the Maximum Authorised Mass of the vehicle has not been reached, up to 300 kg can be transferred to the braked trailer, within the limits of the Gross Train Weight.

## DIMENSIONS (in metres) (1/2)

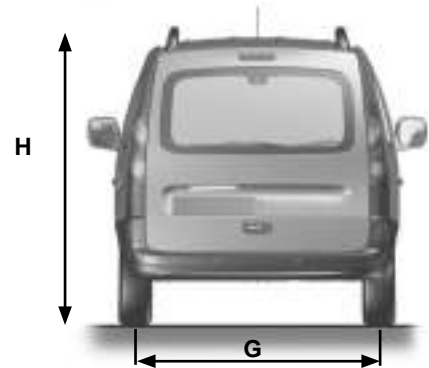
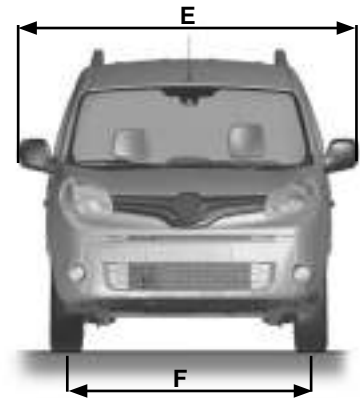
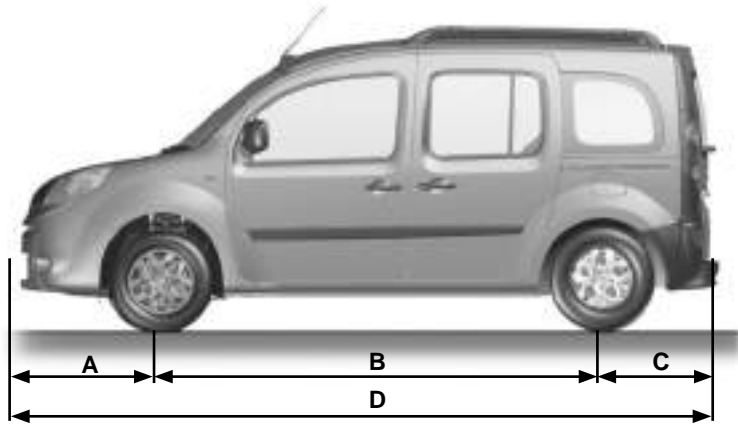

27346

## DIMENSIONS (in metres) (2/2)

	Short	Medium	Long
A	0,9		
B	2.3	2.7	3,1
C	0.7		
D	3,9	4,3	4,7
E	2.1		
F	1.5		
G	1.5		
H (unladen)	1.8		

Turning circles between kerbs	9.6	10.7	11.9
Turning circles between walls	10.1	11.2	12.4

**Important:** if the vehicle is fitted with roof bars, the height must be increased by 0.070 m (the bars cannot be moved).

## REPLACEMENT PARTS AND REPAIRS

Original parts are based on strict specifications and are subject to highly-specialised tests. Therefore, they are of at least the same level of quality as the parts fitted originally.

If you always fit genuine replacement parts to your vehicle, you will ensure that it performs well. Furthermore, repairs carried out within the manufacturer's Network using original parts are guaranteed according to the conditions set out on the reverse of the repair order.



# SERVICE SHEETS (1/6)

VIN: .....

Date: _____ Miles (Km): _____		Invoice number: _____		Comments/miscellaneous	
<b>Type of operation:</b>		<b>Stamp</b>			
Service <input type="checkbox"/>					
..... <input type="checkbox"/>					
<b>Anti-corrosion check:</b>					
OK <input type="checkbox"/> Not OK* <input type="checkbox"/>					
*See specific page					

Date: _____ Miles (Km): _____		Invoice number: _____		Comments/miscellaneous	
<b>Type of operation:</b>		<b>Stamp</b>			
Service <input type="checkbox"/>					
..... <input type="checkbox"/>					
<b>Anti-corrosion check:</b>					
OK <input type="checkbox"/> Not OK* <input type="checkbox"/>					
*See specific page					

Date: _____ Miles (Km): _____		Invoice number: _____		Comments/miscellaneous	
<b>Type of operation:</b>		<b>Stamp</b>			
Service <input type="checkbox"/>					
..... <input type="checkbox"/>					
<b>Anti-corrosion check:</b>					
OK <input type="checkbox"/> Not OK* <input type="checkbox"/>					
*See specific page					

# SERVICE SHEETS (2/6)

VIN: .....

Date:	Miles (Km):	Invoice number:	Comments/miscellaneous
<b>Type of operation:</b>		<b>Stamp</b>	
Service	<input type="checkbox"/>		
.....	<input type="checkbox"/>		
<b>Anti-corrosion check:</b>			
OK	<input type="checkbox"/>	Not OK*	<input type="checkbox"/>
*See specific page			

Date:	Miles (Km):	Invoice number:	Comments/miscellaneous
<b>Type of operation:</b>		<b>Stamp</b>	
Service	<input type="checkbox"/>		
.....	<input type="checkbox"/>		
<b>Anti-corrosion check:</b>			
OK	<input type="checkbox"/>	Not OK*	<input type="checkbox"/>
*See specific page			

Date:	Miles (Km):	Invoice number:	Comments/miscellaneous
<b>Type of operation:</b>		<b>Stamp</b>	
Service	<input type="checkbox"/>		
.....	<input type="checkbox"/>		
<b>Anti-corrosion check:</b>			
OK	<input type="checkbox"/>	Not OK*	<input type="checkbox"/>
*See specific page			

# SERVICE SHEETS (3/6)

VIN: .....

Date: _____ Miles (Km): _____		Invoice number: _____		Comments/miscellaneous	
<b>Type of operation:</b>		<b>Stamp</b>			
Service <input type="checkbox"/>					
..... <input type="checkbox"/>					
<b>Anti-corrosion check:</b>					
OK <input type="checkbox"/> Not OK* <input type="checkbox"/>					
*See specific page					

Date: _____ Miles (Km): _____		Invoice number: _____		Comments/miscellaneous	
<b>Type of operation:</b>		<b>Stamp</b>			
Service <input type="checkbox"/>					
..... <input type="checkbox"/>					
<b>Anti-corrosion check:</b>					
OK <input type="checkbox"/> Not OK* <input type="checkbox"/>					
*See specific page					

Date: _____ Miles (Km): _____		Invoice number: _____		Comments/miscellaneous	
<b>Type of operation:</b>		<b>Stamp</b>			
Service <input type="checkbox"/>					
..... <input type="checkbox"/>					
<b>Anti-corrosion check:</b>					
OK <input type="checkbox"/> Not OK* <input type="checkbox"/>					
*See specific page					

# SERVICE SHEETS (4/6)

VIN: .....

Date:	Miles (Km):	Invoice number:	Comments/miscellaneous
<b>Type of operation:</b>		<b>Stamp</b>	
Service	<input type="checkbox"/>		
.....	<input type="checkbox"/>		
<b>Anti-corrosion check:</b>			
OK	<input type="checkbox"/>	Not OK*	<input type="checkbox"/>
*See specific page			

Date:	Miles (Km):	Invoice number:	Comments/miscellaneous
<b>Type of operation:</b>		<b>Stamp</b>	
Service	<input type="checkbox"/>		
.....	<input type="checkbox"/>		
<b>Anti-corrosion check:</b>			
OK	<input type="checkbox"/>	Not OK*	<input type="checkbox"/>
*See specific page			

Date:	Miles (Km):	Invoice number:	Comments/miscellaneous
<b>Type of operation:</b>		<b>Stamp</b>	
Service	<input type="checkbox"/>		
.....	<input type="checkbox"/>		
<b>Anti-corrosion check:</b>			
OK	<input type="checkbox"/>	Not OK*	<input type="checkbox"/>
*See specific page			

# SERVICE SHEETS (5/6)

VIN: .....

Date: _____ Miles (Km): _____		Invoice number: _____		Comments/miscellaneous	
<b>Type of operation:</b>		<b>Stamp</b>			
Service <input type="checkbox"/>					
..... <input type="checkbox"/>					
<b>Anti-corrosion check:</b>					
OK <input type="checkbox"/> Not OK* <input type="checkbox"/>					
*See specific page					

Date: _____ Miles (Km): _____		Invoice number: _____		Comments/miscellaneous	
<b>Type of operation:</b>		<b>Stamp</b>			
Service <input type="checkbox"/>					
..... <input type="checkbox"/>					
<b>Anti-corrosion check:</b>					
OK <input type="checkbox"/> Not OK* <input type="checkbox"/>					
*See specific page					

Date: _____ Miles (Km): _____		Invoice number: _____		Comments/miscellaneous	
<b>Type of operation:</b>		<b>Stamp</b>			
Service <input type="checkbox"/>					
..... <input type="checkbox"/>					
<b>Anti-corrosion check:</b>					
OK <input type="checkbox"/> Not OK* <input type="checkbox"/>					
*See specific page					

# SERVICE SHEETS (6/6)

VIN: .....

Date:	Miles (Km):	Invoice number:	Comments/miscellaneous
<b>Type of operation:</b>		<b>Stamp</b>	
Service	<input type="checkbox"/>		
.....	<input type="checkbox"/>		
<b>Anti-corrosion check:</b>			
OK	<input type="checkbox"/>	Not OK*	<input type="checkbox"/>
*See specific page			

Date:	Miles (Km):	Invoice number:	Comments/miscellaneous
<b>Type of operation:</b>		<b>Stamp</b>	
Service	<input type="checkbox"/>		
.....	<input type="checkbox"/>		
<b>Anti-corrosion check:</b>			
OK	<input type="checkbox"/>	Not OK*	<input type="checkbox"/>
*See specific page			

Date:	Miles (Km):	Invoice number:	Comments/miscellaneous
<b>Type of operation:</b>		<b>Stamp</b>	
Service	<input type="checkbox"/>		
.....	<input type="checkbox"/>		
<b>Anti-corrosion check:</b>			
OK	<input type="checkbox"/>	Not OK*	<input type="checkbox"/>
*See specific page			

# ANTICORROSION CHECK (1/6)

If the continuation of the warranty is subject to repair, it is indicated below.

**VIN:** .....

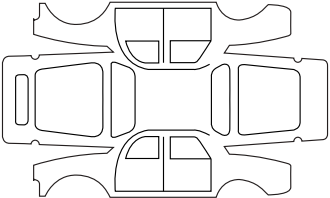
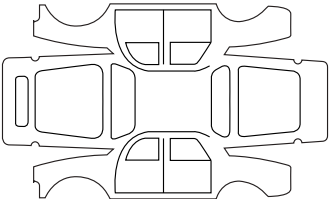
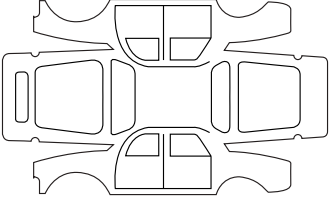
Corrosion repair operation to be carried out:		<b>Stamp</b>
Date of repair:		
Repair to be carried out:		<b>Stamp</b>
Date of repair:		
Repair to be carried out:		<b>Stamp</b>
Date of repair:		

## ANTICORROSION CHECK (2/6)

If the continuation of the warranty is subject to repair, it is indicated below.

**VIN:** .....

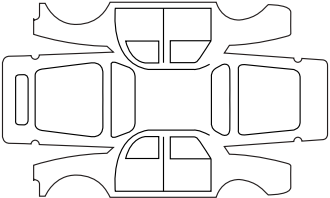
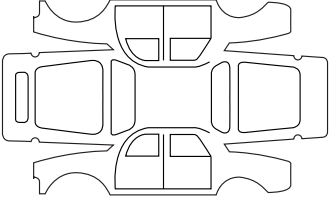
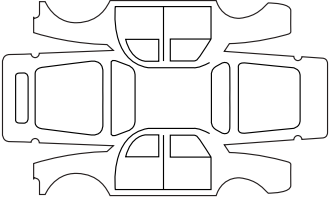
Corrosion repair operation to be carried out:		<b>Stamp</b>
Date of repair:		
Repair to be carried out:		<b>Stamp</b>
Date of repair:		
Repair to be carried out:		<b>Stamp</b>
Date of repair:		



# ANTICORROSION CHECK (3/6)

If the continuation of the warranty is subject to repair, it is indicated below.

VIN: .....

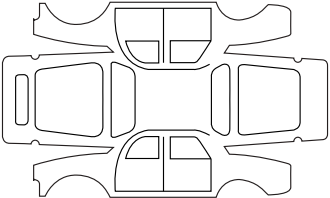
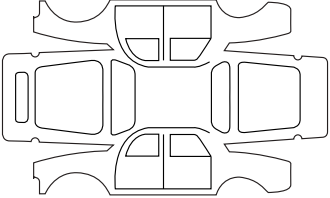
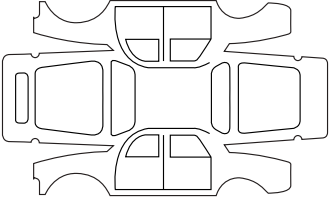
Corrosion repair operation to be carried out:		
Corrosion repair operation to be carried out:		Stamp
Date of repair:		
Repair to be carried out:		
Repair to be carried out:		Stamp
Date of repair:		
Repair to be carried out:		
Repair to be carried out:		Stamp
Date of repair:		

# ANTICORROSION CHECK (4/6)

If the continuation of the warranty is subject to repair, it is indicated below.

**VIN:** .....

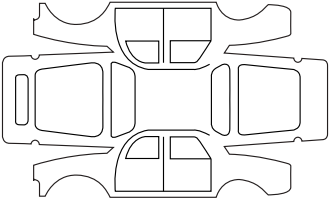
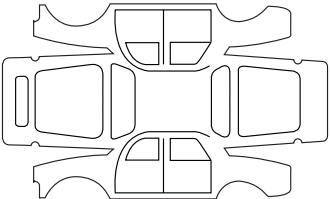
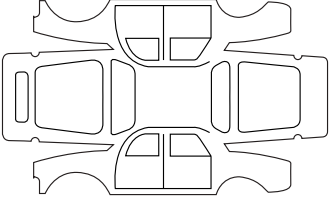
Corrosion repair operation to be carried out:		<b>Stamp</b>
Date of repair:		
Repair to be carried out:		<b>Stamp</b>
Date of repair:		
Repair to be carried out:		<b>Stamp</b>
Date of repair:		

# ANTICORROSION CHECK (5/6)

If the continuation of the warranty is subject to repair, it is indicated below.

VIN: .....

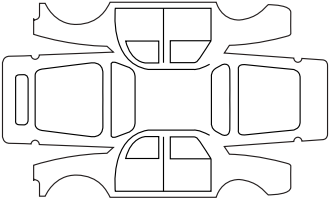
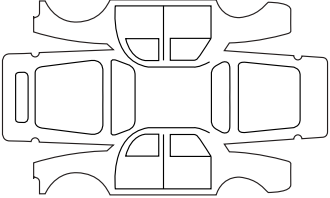
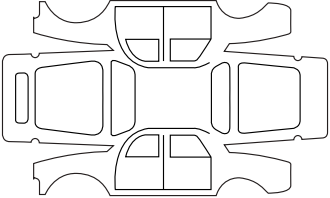
Corrosion repair operation to be carried out:		<b>Stamp</b>
Date of repair:		
Repair to be carried out:		<b>Stamp</b>
Date of repair:		
Repair to be carried out:		<b>Stamp</b>
Date of repair:		

# ANTICORROSION CHECK (6/6)

If the continuation of the warranty is subject to repair, it is indicated below.

**VIN:** .....

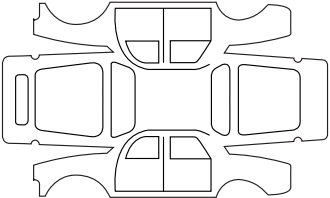
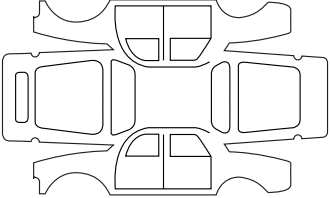
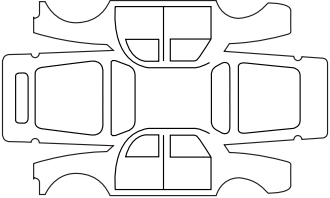
Corrosion repair operation to be carried out:		<b>Stamp</b>
Date of repair:		
Repair to be carried out:		<b>Stamp</b>
Date of repair:		
Repair to be carried out:		<b>Stamp</b>
Date of repair:		

# ALPHABETICAL INDEX (1/5)

## A

ABS .....	1.56, 2.26 → 2.30
accessories.....	5.35
accessories socket .....	3.23
additional methods of restraint .....	1.33
advice on antipollution.....	2.15
air bag.....	1.29 → 1.33, 1.56
activating the front passenger air bags.....	1.46 → 1.48
deactivating the front passenger air bags.....	1.46 → 1.48
air conditioning .....	3.4 → 3.16
air vents .....	3.2 – 3.3
anti-corrosion check .....	6.15 → 6.20
anti-corrosion protection.....	4.15
anti-lock braking system: ABS.....	2.26 → 2.30
antipollution	
advice .....	2.15
ashtrays.....	3.23
audible and visual signals.....	1.74
automatic gearbox (use).....	2.42 → 2.44
automatic gearbox selector lever.....	2.42 → 2.44

## B

batteries.....	5.36
battery.....	1.57, 4.11 – 4.12
troubleshooting .....	5.25 – 5.26
bonnet.....	4.2 – 4.3
brake fluid.....	4.8
brake lights	
changing bulbs.....	5.19 – 5.20
bulbs	
changing .....	5.16 → 5.24

## C

catalytic converter.....	2.9
central door locking .....	1.6
changing a bulb .....	5.16 → 5.18, 5.22 → 5.24

changing a wheel.....	5.11
changing gear.....	2.7, 2.42 → 2.44
child minder mirror.....	3.19
child restraint/seat .....	1.34 – 1.35, 1.37 → 1.48
child safety.....	1.2, 1.4, 1.7, 1.34 – 1.35, 1.37 → 1.48, 2.3, 3.20
child seats.....	1.34 – 1.35, 1.37 → 1.45
children.....	1.34 – 1.35
cigar lighter.....	3.23
cleaning:	
inside the vehicle .....	4.17 – 4.18
clock .....	1.70 – 1.71
closing the doors .....	1.7 → 1.11
control instruments .....	1.54 → 1.60
coolant.....	1.55
courtesy light .....	3.17 – 3.18
courtesy mirrors.....	3.19
cruise control .....	1.57, 2.34 → 2.37

## D

dashboard.....	1.50 – 1.51
deadlocking the doors .....	1.4
demisting	
rear screen.....	3.4, 3.12 – 3.13
windscreen.....	3.5, 3.13
dimensions .....	6.6 – 6.7
dipstick.....	4.4 – 4.5
display .....	1.58 → 1.60
doors.....	1.7 → 1.14
driver's position .....	1.50 – 1.51
driving.....	2.9, 2.13, 2.17 → 2.25, 2.22 → 2.39, 2.42 → 2.44
driving position	
settings .....	1.25 → 1.28
driving recommendations .....	2.11 → 2.14

## E

ECO driving.....	2.11 → 2.14
------------------	-------------

## ALPHABETICAL INDEX (2/5)

ECO mode.....	2.12
electric windows.....	3.20 – 3.21
electronic stability control: ESC.....	2.26 → 2.30
emergency brake assist.....	2.26 → 2.30
emergency braking.....	2.26 → 2.30
emergency spare wheel.....	5.2
engine	
technical specifications.....	6.4
engine coolant.....	4.9
engine oil.....	1.56, 4.4 → 4.7
engine oil capacity.....	4.6 – 4.7
engine oil level.....	4.4 → 4.7
engine specifications.....	6.4
environment.....	2.16
ESC: electronic stability control.....	1.57, 2.26 → 2.30
external temperature.....	1.70 – 1.71

### F

faults	
operating faults.....	5.37 → 5.40
filter.....	4.10
fitting a radio.....	5.33 – 5.34
fittings.....	3.24 → 3.28
fog lights.....	1.77, 5.18
front lights	
changing bulbs.....	5.16 – 5.17
front passenger air bag deactivation.....	1.46 → 1.48
front seat adjustment.....	1.19 → 1.21
front seats	
adjustment.....	1.19 → 1.21
fuel	
advice on fuel economy.....	2.11 → 2.14
capacity.....	1.83
consumption.....	2.11 → 2.14
filling.....	1.56, 1.83 → 1.85
grade.....	1.83

fuel consumption.....	2.11 → 2.14
fuel filler cap.....	1.83 → 1.85
fuel tank	
capacity.....	1.83 → 1.85
fuel tank capacity.....	1.83 → 1.85
fuses.....	5.27 – 5.28

### G

gear lever.....	2.7
glove box.....	3.24
grip control.....	2.29

### H

handbrake.....	1.55, 2.8
hazard warning lights signal.....	1.74
headlight beam adjustment.....	1.78 – 1.79
headrest.....	1.15 → 1.18
heated seats.....	1.19 → 1.21
heating and air conditioning system.....	3.4 → 3.15
heating system.....	3.4 → 3.16
horn.....	1.74
horn:	
flash.....	1.74
sounding the horn.....	1.74
hubcap tool.....	5.8

### I

ignition switch.....	2.2
indicators.....	1.54, 1.74, 5.17, 5.22
indicators:	
direction indicators.....	5.17, 5.22
instrument panel.....	1.58 → 1.60
instrument panel.....	1.54 → 1.69
instrument panel messages.....	1.61 → 1.69
interior lighting:	
changing bulbs.....	5.23 – 5.24

## ALPHABETICAL INDEX (3/5)

interior trim  
    maintenance ..... 4.17 – 4.18  
Isofix ..... 1.37 → 1.45

**J**  
jack ..... 5.8, 5.11

**L**  
levels ..... 4.8 → 4.10  
levels:  
    brake fluid ..... 4.8  
    coolant ..... 1.59, 4.9  
    fuel ..... 1.59  
    windscreen washer reservoir ..... 4.10

lifting the vehicle  
    changing a wheel ..... 5.11 – 5.12

lighting:  
    interior ..... 3.17 – 3.18

lights  
    adjustment ..... 1.78 – 1.79  
    changing bulbs ..... 5.16 – 5.17  
    fog lights ..... 5.18  
    front ..... 5.16 – 5.17

lights:  
    brake lights ..... 5.19  
    dipped beam headlights ..... 1.54, 1.75, 5.16  
    direction indicators ..... 1.54, 1.74, 5.19  
    fog lights ..... 1.54, 1.77, 5.18  
    hazard warning ..... 1.74  
    main beam headlights ..... 1.54, 1.75 – 1.76  
    number plate lights ..... 5.21  
    reversing lights ..... 5.19  
    side lights ..... 1.75

lights-on warning buzzer ..... 1.7, 1.76  
locking the doors ..... 1.6, 1.12 – 1.13  
luggage compartment cover ..... 3.33

luggage retaining net ..... 3.34

**M**  
maintenance ..... 2.15  
maintenance:  
    bodywork ..... 4.15 – 4.16  
    interior trim ..... 4.17 – 4.18  
    mechanical ..... 4.2 → 4.5, 6.9 → 6.14  
map reading lights ..... 3.17 – 3.18  
methods of restraint in addition to the front seat belts ..... 1.29 → 1.31  
methods of restraint in addition to the seat belts ... 1.29 → 1.33  
multimedia equipment ..... 3.37, 5.33 – 5.34

**N**  
navigation ..... 3.37  
navigation system ..... 3.37

**O**  
oil change ..... 4.6 – 4.7  
opening the doors ..... 1.7 → 1.11  
operating faults ..... 1.54 → 1.57, 5.37 → 5.40

**P**  
paintwork  
    maintenance ..... 4.15 – 4.16  
    reference ..... 6.2  
parking distance control ..... 2.38 – 2.39  
partition ..... 1.24  
power-assisted steering ..... 2.8  
practical advice ..... 5.34  
pretensioners ..... 1.29  
puncture ..... 5.8, 5.11

**R**  
radio ..... 3.37, 5.33 – 5.34

## ALPHABETICAL INDEX (4/5)

radio frequency remote control/key	
use .....	1.2, 1.4
rear bench seat .....	3.29 – 3.30
rear lights	
changing bulbs .....	5.19 → 5.21
rear parcel shelf .....	3.33
rear screen	
demisting .....	3.2, 3.4
rear seats	
functions .....	3.29 – 3.30
rear view camera .....	2.40 – 2.41
rear view mirrors .....	1.72 – 1.73
remote control electric door locking .....	1.2, 1.4
RENAULT ANTI-INTRUDER DEVICE (RAID) .....	1.14
replacement parts .....	6.8
reverse gear	
selecting .....	2.7, 2.42 → 2.44
reversing sensor .....	2.38 – 2.39
roof bars .....	3.35
running in .....	2.2

### S

seat belts .....	1.25 → 1.33, 1.57
see-me-home lighting .....	1.76
service sheets .....	6.9 → 6.14
side indicator lights	
changing bulbs .....	5.22
side protection devices .....	1.32
side windows .....	3.21
signals and lights .....	1.75 → 1.77
speakers .....	5.34
special features of diesel versions .....	2.10
special features of petrol vehicles .....	2.9
speed limiter .....	1.57, 2.31 → 2.33
starting the engine .....	2.3 → 2.6

steering wheel	
adjustment .....	1.49
Stop & Start .....	1.57
stopping the engine .....	2.3 → 2.6
storage compartment .....	3.24 → 3.28
storage compartments .....	3.24 → 3.28
sun visor .....	3.19, 3.25
sunroof .....	3.22

### T

tailgate .....	1.9 → 1.11, 3.31 – 3.32
technical specifications .....	6.2, 6.4, 6.6 → 6.8
temperature regulation .....	3.4 → 3.16
tool kit .....	5.8
towing .....	6.5
breakdown .....	5.31
towing a caravan .....	6.5
towing equipment	
fitting .....	3.32
towing hitch .....	5.8, 5.31
towing rings .....	1.37 – 1.38
towing weights .....	6.5
traction control .....	1.57, 2.26 → 2.30
transporting children .....	1.34 – 1.35, 1.37 → 1.48
transporting objects	
in the luggage compartment .....	3.31 – 3.32
trims .....	5.10
trip computer and warning system .....	1.61 → 1.69
turning circle .....	6.6 – 6.7
tyre inflation kit .....	5.4 → 5.7
tyre pressure .....	2.17 → 2.25, 2.22 → 2.25, 4.13
tyre pressure loss warning .....	2.17 → 2.25, 2.22 → 2.25
tyre pressures .....	4.13 – 4.14, 5.13 → 5.15
tyres .....	2.17 → 2.25, 2.22 → 2.25, 4.13, 5.13 → 5.15



## ALPHABETICAL INDEX (5/5)

### U

unlocking the doors ..... 1.12 – 1.13

### V

variable power-assisted steering ..... 1.54

vehicle identification ..... 6.2

vehicle identification plates ..... 6.2 – 6.3

ventilation ..... 3.2 → 3.16

### W

warning lights ..... 1.54 → 1.57, 1.61 → 1.69

washing ..... 4.15 – 4.16

weights ..... 6.5

wheelbrace ..... 5.8

wheels (safety) ..... 5.13

windscreen washer ..... 1.80 → 1.82

windscreen washer fluid ..... 4.10

windscreen washer/wiper  
replacing blades ..... 5.29 – 5.30

wiper blades ..... 5.29 – 5.30

wipers ..... 1.80 → 1.82



<https://www.truck-manuals.net/renault/>

Visit: RenaultUSA.com

