



Table of Contents

Global Technology Behind Every Part

Using the Catalog

Table of Contents.....	i
How To Use This Catalog.....	ii
Abbreviations.....	xii-xiii
Conversion Tables.....	55
General CA0045 Catalog Information.....	ii
Catalog Index.....	1

Coverage / Products..... v

FP Diesel Philosophy..... iii

Manufacturing / Customer Service..... iv

Warranty.....xiv-xvi

Product Information

Engine Bearings.....	vii-ix
Engine Kits.....	vi
Engine Plastigage.....	viii
Pistons - Heavy Duty.....	x
Sleeves and Assemblies.....	xi
Technology Page.....	56

Detroit Diesel Four-Cycle Engines

Identifying the Series 40 Engines.....	1
Series 40 Engine.....	2
Identifying the 8.2L Engines.....	5
8.2L Specialty Gasket Sets.....	6
8.2L Engine.....	7
Identifying the Series 50 Engines.....	20
Series 50 Engine.....	21
Identifying the Series 60 Engines.....	30
Series 60 Engine.....	31
Engine Kit Bill of Material.....	50
Numerical List.....	52



How To Use This Catalog

Global Technology Behind Every Part

The header for each block listed is designed to help you identify the correct engine application. Special information regarding a specific part is located to the far right of the part number listing. If available, ENGINE KIT listings are located at the beginning of the engine listing.

Engine components are grouped in the following order:

- 1st. Cylinder Head and Parts
- 2nd. Intake and Exhaust Manifolds
- 3rd. Camshaft Group
- 4th. Fuel System and Parts
- 5th. Cooling System
- 6th. Engine Block and Parts
- 7th. Crankshaft/Oil Pump and Related Parts
- 8th. Cylinder Components (incl. Rod Bearings, Cylinder Sleeves, Pistons, Piston Rings)

This catalog is sorted as follows:

- 1st. By ENGINE DISPLACEMENT
- 2nd. By BORE DIAMETER. Engines with the same displacement are sorted by bore diameter.
- 3rd. By USAGE. Engines used in Medium Duty Truck applications will be listed before engines used in Heavy Duty Truck applications.
- 4th. By INDUCTION SYSTEM. Naturally aspirated-engines will be listed before Turbocharged engines.

General Information

This catalog is designed to identify the major components, assemblies and kits used in the Detroit Diesel four cycle family of engines including Series 40, 50, 60 and 8.2L naturally aspirated and turbo charged versions.

The catalog includes all of the parts and kits available from FP Diesel for Detroit Diesel four-cycle engines.

The catalog is organized by engine model. Each section is subdivided into groups that coincide with the various engine assemblies and components.

FP Diesel uses a part numbering system similar to Detroit Diesel's OEM number. In most instances, the FP Diesel part number is the same except that the suffix, or prefix of the Detroit Diesel number is omitted (when it serves no applicable purpose). For example:

Detroit Diesel Part Number 8929690

FP Diesel Part Number FP-8929690

All manufacturers numbers, names, symbols and descriptions are used for reference purposes only. It is not implied that any part listed is the product of any specific manufacturer.

All information contained in this catalog is based on the latest data available at the time of printing. Although care has been taken to ensure the accuracy of the data compiled in this catalog, Federal-Mogul does not assume liability for errors or omissions.

IMPORTANT NOTICE

This catalog does not replace the Detroit Diesel parts catalogs or service materials. If in doubt, reference your Detroit Diesel OEM publications.





FP Diesel Philosophy

Global Technology Behind Every Part

FP Diesel – part of the Federal-Mogul Engine Systems group – is the industry's leading brand of premium heavy-duty replacement engine parts and gaskets, providing total engine system solutions for such well-known brands as Case,[®] Caterpillar,[®] Cummins,[®] Detroit Diesel,[®] International,[®] John Deere,[®] Komatsu,[®] Mack,[®] Waukesha[®] and White Superior[®].

Federal-Mogul maintains a steadfast commitment to unsurpassed product quality and customer service. We serve construction, marine, agricultural, mining, gas compression, trucking and industrial markets around the globe. As the global leader in heavy-duty powertrain systems, Federal-Mogul is instrumental in the development of every new generation of gasoline and diesel engine technology. When you choose FP Diesel, you get unparalleled global engineering and manufacturing resources built into every product.

Today's heavy duty market demands performance. Performance means precision-engineered parts that meet your demanding specifications; and are backed by a team of knowledgeable customer service representatives who can provide technical information and assistance; computerized order and inventory tracking for fast and accurate order fill; unprecedented warranty programs and a company-wide commitment to customer satisfaction.



Construction



Agriculture



On-Highway



Marine

©2010 Federal-Mogul Corporation. FP Diesel and their respective designs are registered trademarks of Federal-Mogul Corporation. Case[®] is the registered trademark of Case Corporation, Inc.; Cat[®] and Caterpillar[®] are the registered trademarks of the Caterpillar, Inc.; Cummins[®] is the registered trademark of Cummins Engine Company; Detroit Diesel[®] is the registered trademark of Detroit Diesel Corporation; International[®] is the registered trademark of International Truck and Engine Corporation; John Deere[®] is the registered trademark of Deere & Company; Komatsu[®] is the registered trademark of Komatsu Limited, Inc.; Mack[®] is the registered trademark of Mack Trucks, Inc.; Waukesha[®] is the registered trademark of the Waukesha Engine Division of Dresser Industries, Inc.; White Superior[®] is the registered trademark of White Superior Corporation, Inc. Jacobs[®] is a registered trademark of Jacobs Vehicle Systems. All rights reserved.



Manufacturing

Global Technology Behind Every Part



Precise manufacturing and fabricating techniques, rigorous quality control procedures, utilization of the latest CAD technology and innovative solutions to industry challenges – coupled with Federal-Mogul's global manufacturing capabilities – have established FP Diesel as the industry leader in the heavy duty market.

FP Diesel applies stringent quality control procedures with expertly skilled technicians supervising the manufacturing process in all phases to ensure that our parts will perform and last.

FP Diesel is a military approved supplier for the 53 Series Detroit Diesel engine. But the parts we supply for the 53 aren't the only ones that go through government testing. Every FP Diesel part must pass through high-level quality control. Plus, every part is tracked throughout the entire distribution process.

Customer service

FP Diesel customer service representatives are among the most experienced and knowledgeable in the industry, with hands-on heavy-duty experience and in-depth knowledge of engine parts and applications. With one call to your representative you'll have answers to any product, technical,



order processing, billing, warranty, pricing, order tracking or availability questions you may have. Customer service that goes the extra mile also means you not only get the parts you need, but expert assistance from a person who knows the heavy duty market.

Plus, our computerized inventory system allows us to ship your order promptly anywhere in the world, while our easy-to-use cataloging system makes ordering FP Diesel parts fast and simple. For the parts and information you need, count on FP Diesel to go the extra mile.



<https://www.truck-manuals.net/>



Coverage

Global Technology Behind Every Part

The FP Diesel product offering is a comprehensive line of diesel and natural gas engine replacement parts that provides all the coverage necessary to meet your heavy-duty engine rebuilding needs. FP Diesel also offers a full line of gaskets and elastomeric products. For more specific information, please refer to our full-line catalogs, which are engine and machine specific and follow OEM format. To ensure exact part number replacement, these catalogs reference OEM part numbers and features technical information relating to the specific engine being serviced.



Products

Caterpillar

Replacement Caterpillar products cover 3200, 3300, 3400, 3500, D Series and G Series engines. This coverage extends from cylinder heads, fuel injection, cam and crankshafts, cylinder kits, valvetrain and electrical to engine bearings, transmission, hydraulic gasket sets and more. Refer to FP Diesel catalog No. CA0010 (parts) and CA0020 (gaskets).

Cummins

FP Diesel provides replacement parts coverage for V378, V504, V555, Small Vee Engines, V/VT 903, 855 Series, N14, L10, B Series, C Series, V/VT1710, N743 and K/KTA 18-, 38- and 50-liter engines, as well as components for Jacobs® brakes. Refer to FP Diesel catalog No. CA0030.

Detroit Diesel

FP Diesel offers the most complete coverage in the replacement parts industry for Detroit Diesel, with an extensive line of components and kits for the 8.2-liter, 53 Series, 60 Series, 71 Series, 92 Series and 149 Series engines. Refer to FP Diesel catalog No. CA0040 for 2-cycle engines or FP Diesel catalog No. CA0045 for 4-cycle engines.

John Deere

FP Diesel offers a broad range of in-frame and complete overhaul kits and related components for 300 Series, 400 Series, 500 Series and Powertech engines is available from FP Diesel. Refer to FP Diesel catalog No. CA0085.

Komatsu

Extensive coverage for Komatsu S6D 155 and SA6D155 engines, as well as a full line of replacement parts for Komatsu machines using Cummins N743, KT/KTA 19-, 38- and 50-liter engines, and the Cummins 855. Refer to FP Diesel catalog No. CA0085.

Mack

FP Diesel has a broad line for Mack, early ENDT 675 and 676 engines, as well as parts for later EM6 with both two- and four-valve head configurations. Refer to FP Diesel catalog No. CA0060

International

International coverage extends from the 6.9 and 7.3 liter, DT-360 and DT-466 through the 9.0 liter engine. Refer to FP Diesel catalog No. CA0050. For agricultural applications, FP Diesel also services the DT-414 and DT-436 Case/I.H. engines. For industrial and agricultural applications, refer to FP Diesel catalog No. SP188.

Case

FP Diesel has a complete range of kits and components for the 188, 207, 301, 366, 451 and 504-Case engines along with the 4-390 & 4T-390, 6-590 & 6T-590, 6T-830 & 6TA-830, LTA 10 and NTA 855 B/C III Cummins engines. Refer to FP Diesel catalog No. CA0095.

Commercial, Ag, Industrial Engines

The FP Diesel SP188 catalog contains all the engine manufacturers that are not covered in the other FP Diesel name-plate specific catalogs listed. These engine manufacturers include Allis-Chalmers, Bedford, Bendix-Westinghouse, Briggs & Stratton, Buda, Case Tractor, Chevrolet MD Truck, Climax, Continental, Dodge MD Truck, Ford Tractor, GMC MD Truck, Hercules, IHC Tractor, Isuzu Forklift, KHD, Kohler, LeRoi, Massey Ferguson, Mercedes, Mazda Forklift, Minneapolis-Moline, Mitsubishi, Novo, Oliver, Perkins, Superior, Thermo-King, Volvo, Waukesha, White and Wisconsin. All of the replacement engine components offered for each of these manufacturers is included in this catalog.



Engine Kits

Global Technology Behind Every Part

The FP Diesel Engine Kit program allows you to select a kit tailored to the job at hand. Whether performing a complete overhaul, or in-frame repair, our engine kits contain all the necessary components to complete the rebuild job. This comprehensive program provides you with the following:

- Concise application information
- One price look-up
- A full complement of oversizes and undersizes
- Master kits that include full gasket sets

Engine kits are listed at the back of this catalog and under the In-Frame and Overhaul specific sections.

How To Specify FP Diesel Engine Kits

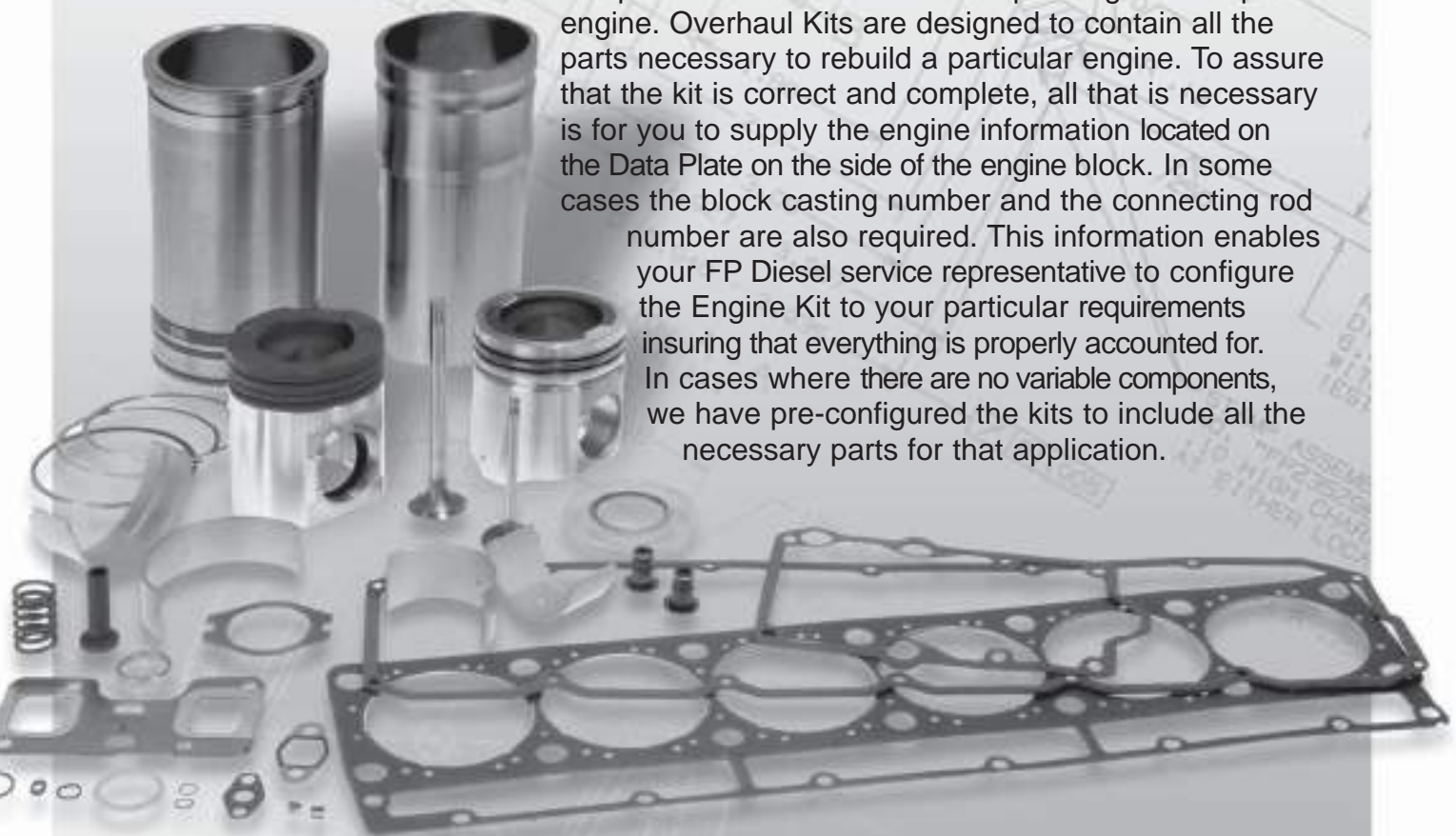

Many FP Diesel engine kits have several variations in components that are available depending on the specific engine. Overhaul Kits are designed to contain all the parts necessary to rebuild a particular engine. To assure that the kit is correct and complete, all that is necessary is for you to supply the engine information located on the Data Plate on the side of the engine block. In some cases the block casting number and the connecting rod number are also required. This information enables your FP Diesel service representative to configure the Engine Kit to your particular requirements insuring that everything is properly accounted for. In cases where there are no variable components, we have pre-configured the kits to include all the necessary parts for that application.





Engine Bearings

Global Technology Behind Every Part

Engine Bearing Material Selection

When selecting engine bearings, most rebuilders concentrate on getting the proper clearances and maintaining adequate oil pressure. Durability is expected from any bearing chosen, and the advantages of different bearing materials may not be considered. If engine operating conditions are considered and bearing materials chosen accordingly, the likelihood of engine longevity is greater. No single material can be correct for every application. FP Diesel engine bearings are equal to or better than the

original equipment specifications for material and design. We also provide alternatives to address unique problems and special needs.

In heavy duty applications there are a number of materials that will do an excellent job. Each alloy has advantages in terms of resistance to corrosion, rate of wear and fatigue strength. The latter characteristic is critical in engines that operate under high loads, generate considerable heat and may be subjected to occasional detonation.

Bi-Metal Aluminum Alloys – Plated and Unplated

Diesel fuels, moisture, and engine “blow-by” introduce many contaminants into the crankcase. Aluminum engine bearing materials provide outstanding resistance to the corrosive effects of these substances, and are the product of choice for most current original equipment vehicle manufacturers. The modern bi-metal aluminum engine bearing contains silicon. As a result of using silicon, the alloy resists seizure and dramatically

reduces or eliminates bearing wear. This contributes to today’s extended engine life. Aluminum is often the best material for a daily driven vehicle. Adding an overplate to an aluminum engine bearing will further enhance embedability and conformability. Continued efforts to remove lead from our environment guarantee that aluminum will become the preferred engine bearing material for most applications.





Engine Bearings

Global Technology Behind Every Part

Tri-Metal Alloys



Tri-Metal engine bearings, such as our H-14 and H-24 alloys, have excellent fatigue resistance, but are less resistant to corrosion damage than aluminum bearings. These bearing materials are accepted by engine builders worldwide, and are proven to be reliable in a wide range of uses. While OE manufacturers are moving to aluminum for their needs, many rebuilders still specify the tri-metal bearings for older engines.

Typical Commercial Engine

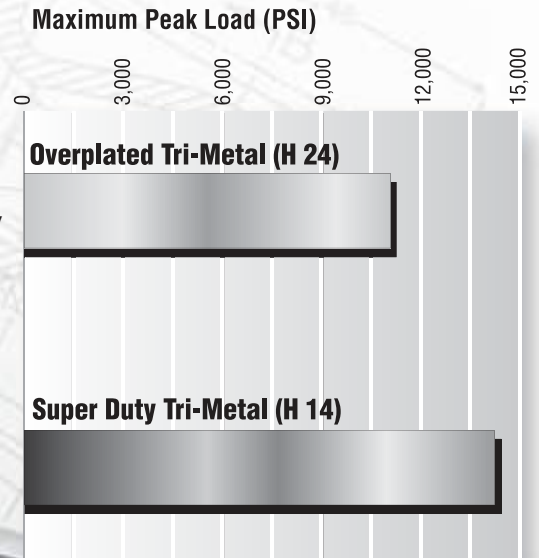

PLASTIGAGE

Sealed Power PLASTIGAGE® for High Performance Precision

A Quick and Accurate Method for Measuring Main and Connecting Rod Bearing Clearances.



Federal-Mogul offers Sealed Power Plastigage. It ends the guessing game when measuring clearances of main and connecting rod bearings. Specially formulated and oil soluble, Plastigage strips flatten precisely for accurate reading. Plastigage strips are available in four size ranges, packaged 12 to a carton, (enough to do 12 engines). Part number SPG-1 cartons contain strips in the .001-.003 inch range. Part number SPR-1 cartons hold strips in the .002-.006 inch range. SPB-1 cartons include strips in the .004-.009 inch range. SPY-1 cartons contain strips in the .009-.020 inch range. This complete range of sizes will fit every heavy duty engine.

SPG-1 .001-.003 in.

SPR-1 .002-.006 in.

SPB-1 .004-.009 in.

SPY-1 .009-.020 in.





Engine Bearings

Global Technology Behind Every Part

Rod and Main Bearing

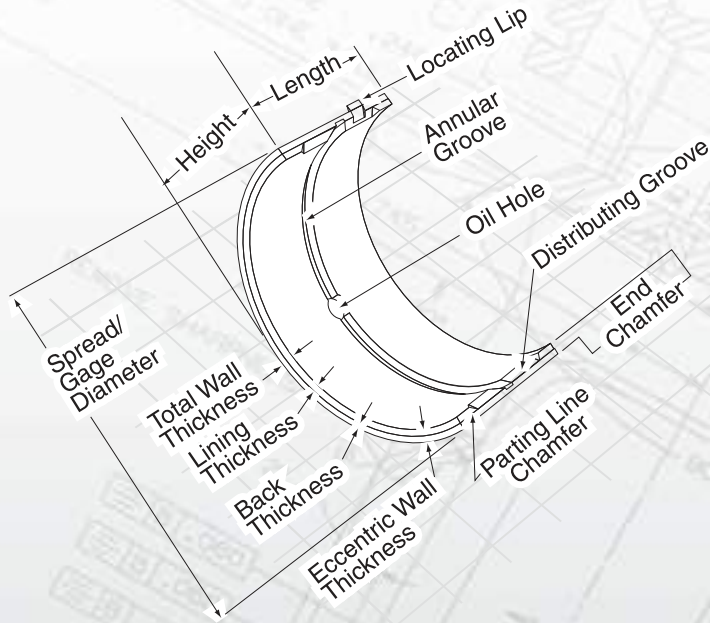

Thrust Bearing

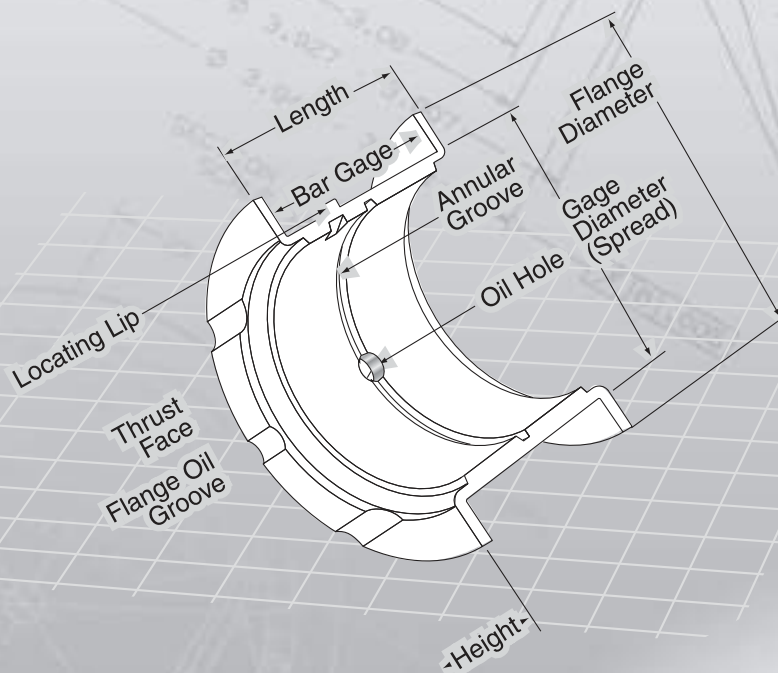



Heavy Duty Pistons

Global Technology Behind Every Part

FP Diesel heavy duty pistons are designed and produced for severe operating conditions. Federal-Mogul is one of the world's leading manufacturers of heavy duty pistons offering one and two-piece designs including aluminum articulated, cast iron and steel materials. For severe and high load applications, FP Diesel pistons include a metallurgically bonded NI-resist insert in the top and in some cases, the second ring groove. The NI-resist insert minimizes groove wear and reduces pound-out from the compression ring. Anodized heads and graphite-coated skirts offer additional durability in severe applications. Federal-Mogul also utilizes an in-house, patented magnesium-phosphate coating to reduce the piston

corrosion caused by high-sulfate diesel fuels and break-in wear on problematic applications.

We design our heavy duty pistons using the latest in computer aided design (CAD) software. Each application is thoroughly researched to ensure the proper dimensional and metallurgical requirements. And since we also design and manufacture cylinder liners and piston rings, our engineers can make sure each piston we develop provides optimum performance as part of the "power-cylinder" system.





Sleeves and Assemblies

Global Technology Behind Every Part

Cylinder sleeves are produced by Federal-Mogul in a QS9000 registered facility complete with casting, induction hardening, machining, measurement and design capabilities. We start with raw castings produced on a state-of-the-art molding line specifically designed for the manufacture of static cast cylinder liners. The static castings produced by our foundry have a very consistent microstructure and superior scuffing resistance.

Certain applications are induction hardened or thru-hardened to enhance the wear characteristics and strength of the liner. Hardened liners are typically used in engines highly susceptible to dirt contamination, such as construction or agricultural applications.

Machining is performed on modern CNC equipment to ensure dimensional stability and exacting tolerances. Cylinder liners are typically finish honed to generate a plateau finish. The plateau finish promotes rapid ring seating

during break-in while providing a long-wearing sealing surface.

FP Diesel offers sleeves for wet, dry and repair applications. Sleeve assemblies or kits include the sleeve, piston, piston pin and lock rings, piston rings and sealing rings.



Abbreviations Used

Global Technology Behind Every Part

ABBREVIATION	DESCRIPTION
&	And
2WD	Two Wheel Drive
4WD	Four Wheel Drive
A.I.R.	Air Injector Reactor
A/C	Air Conditioning
A/R	As Required
A/T	Automatic Transmission
ABS	Anti-lock Brake System
AC	Alternating Current
Acc.	Accessory
Adj.	Adjustable
Adv.	Advance
Aft	After
Alt.	Altitude
Alum.	Aluminum
Amp.	Ampere
AOD	Automatic Overdrive
Appl.	Application
Approx.	Approximately
Asst.	Assist
Assy.	Assembly
ATV	All Terrain Vehicle
Auto.	Automatic
Auto. Trans.	Automatic Transmission
Aux.	Auxiliary
Avail.	Available
Avg.	Average
AWD	All Wheel Drive
Bal.	Balance
Batt.	Battery
Bbl.	Barrel
Bbl. Carb.	Barrel Carburetor
Bef.	Before
Brg.	Bearing
Brkt.	Bracket
C	Celsius
C.I.	Cast Iron
C.R.	Compression Ratio
C/L	Centerline
Calib.	Calibration
Calif.	California
Cam	Camshaft
Can.	Canada
Carb.	Carburetor
Cat.	Catalytic
cc	Cubic Centimeter
CCW	Counter Clockwise
CD	Compression Distance
CFFI	Cross Fire Injection
CFI	Central Fuel Injection
CFM	Cubic Feet per Minute
CID	Cubic Inch (Displacement)
Cld.	Cooled
Clg.	Cooling
Clr.	Cooler
cm	Centimeter

ABBREVIATION	DESCRIPTION
Cntr. Bore	Counter Bore
Compl.	Complete
Con. Rod	Connecting Rod
Cruise	Cruise Control
Ctr.	Center
CW	Clockwise
Cyl.	Cylinder
Cyl. Hd.	Cylinder Head
DC	Direct Current
Deg.	Degree
DFI	Digital Fuel Injection
DI	Direct Injection
Dia.	Diameter
Dim.	Dimension
Dir. Inj.	Direct Injection
Disc.	Discontinued
Dist.	Distributor
DOHC	Dual Overhead Camshaft
Dr.	Door or Drive
E.E.C.	Electronic Engine Control
E.I.S.	Electronic Ignition System
Ea.	Each
Ecc.	Eccentric
ECM	Electronic Computer Module
ECM	Electronic Control Module
ECM	Engine Control Module
Econ.	Economy
ECS	Electronic Controlled Spark
EFI	Electronic Fuel Injection
Elec.	Electric
Emis.	Emission
Eng.	Engine
Equip.	Equipment
Etc.	Et Cetera
Exc.	Except
Exh.	Exhaust
Exp.	Export
Ext.	Exterior
Ext.	External
F	Fahrenheit
Fed.	Federal
FI	Fuel Injection
Flex.	Flexible
Flg.	Flange
Flwr.	Follower
Frg.	Forged or Forging
Frnt.	Front
FWD	Front Wheel Drive
Gal.	Gallon
Gas	Gasoline
GPH	Gallons Per Hour
GPM	Gallons Per Minute
Grv(s)	Groove(s)
Gskt.	Gasket
GVW	Gross Vehicle Weight
H/D	Heavy Duty
Hd.	Head
HEI	High Energy Ignition
Hi	High





Abbreviations Used

Global Technology Behind Every Part

ABBREVIATION	DESCRIPTION
Hi Alt.	High Altitude
Hi-Perf.	High Performance
Hi-Temp.	High Temperature
HO	High Output
Horiz.	Horizontal
HP	Horsepower
HSC	High Swirl Combustion
Hyd.	Hydraulic
I/C	Intercooler
I.D.	Identification
ID	Inside Diameter
IDI	Indirect Injection
In. Frm.	In Frame
in.	Inch
Incl.	Includes
Ind.	Industrial
Inj.	Injection
Int.	Intake
Inter.	Intermediate
L	Liter
L.H.	Left Hand
L/D	Light Duty
Lgth.	Length
LPG	Liquid Propane Gas
M/D	Medium Duty
M/T	Manual Transmission
Man.	Manual
Man. Trans.	Manual Transmission
Max.	Maximum
Mech.	Mechanical
MFI	Multi-Port Fuel Injection
Min.	Minimum
mm.	Millimeters
MPH	Miles Per Hour
Mtl.	Material
N/A	Not Available
N/R	Not Required
Nat.	Natural
Nat. Asp.	Naturally Aspirated
Neg.	Negative
Neut.	Neutral
No.	Number
Nom.	Nominal
Norm.	Normal
O.A.L.	Overall Length
O.E.	Original Equipment
O/D	Overdrive
O/S	Oversize
Obs.	Obsolete
OD	Outside Diameter
OEM	Original Equipment Manufacturer
OHC	Overhead Cam
OHV	Overhead Valve
Opt.	Optional
Orig.	Original
oz.	Ounce
P. T.O.	Power Take Off
P/S	Power Steering
Pass.	Passenger

ABBREVIATION	DESCRIPTION
Pc(s)	Piece(s)
PCV	Positive Crankcase Ventilation
Perf.	Performance
Pkg.	Package
Pos.	Positive
Prem.	Premium
Pri.	Primary
PSI	Pound Per Square Inch
Pwr.	Power
Qtr.	Quarter
Qty.	Quantity
R.B.P.	Ring Below Pin
R.H.	Right Hand
Ref.	Reference
Reg.	Regular
Reman.	Remanufactured
Req'd	Required
Rev.	Revision
Rev. Rot.	Reverse Rotation
Rlr.	Roller
RMB	Rear Main Bearing
Rot.	Rotatiovn
RPM	Revolutions Per Minute
Rr.	Rear
RWD	Rear Wheel Drive
S/C	Supercharged
Seal. Rings	Sealing Rings
Ser.	Serial or Series
Ser. No.	Serial Number
SFI	Sequential Fuel Injection
Slv.	Sleeve
SOHC	Single Overhead Cam
Spd.	Speed
Spec.	Special
Sta.	Station
Std.	Standard
Sys.	System
T/C	Turbocharged
Tach	Tachometer
TBI	Throttle Body Injection
Temp.	Temperature
TPI	Tuned Port Injection
Trans.	Transmission
Trk.	Truck
TTY	Torque-to-Yield
TURBO	Turbocharged
U/S	Under Size
Veh.	Vehicle
VIN	Vehicle Identification Number
VIV	Valve
VSS	Valve Stem Seal
w/	With
w/o	Without
Wagon	Station Wagon
Wt.	Weight



Global Technology Behind Every Part

The products listed in this catalog are warranted to be free from defects in material and workmanship, under normal use and service, for two years from date of installation in an engine, without mileage or hour qualification in accordance with the following limited warranty. This warranty is the sole and exclusive warranty for failure of the above parts. This exclusive remedy shall not be deemed to have failed of its essential purpose so long as Federal-Mogul is willing and able to provide the remedy provided below.

WARRANTY LIMITATIONS

Federal-Mogul agrees to only pay for parts and labor needed to repair engine damages that result from the defined warranty failure. The costs are limited to parts and labor necessary for restoring the engine to its condition immediately prior to the failure. Labor costs are determined by current published rates and standards in the geographic area in which repairs are performed. Overtime or holiday rate charges are not allowed. We will also pay for maintenance products such as oil, antifreeze, belts, hoses and filter elements that are damaged because of a defined warranty failure.

Federal-Mogul is not responsible for engine failure resulting from owner, operator or third party neglect or abuse, improper installation or repair procedures, alteration or misapplication of parts, failure to properly service or maintain the engine and vehicle in accordance with applicable OEM operation and maintenance manuals or use in engine modified for competition purposes or used in competition.

OTHER THAN AS EXPRESSLY PROVIDED HEREBY, FEDERAL-MOGUL SHALL NOT, UNDER ANY CIRCUMSTANCES, BE LIABLE FOR ANY SPECIAL, INDIRECT, INCIDENTAL, OR CONSEQUENTIAL DAMAGES, INCLUDING, BUT NOT LIMITED TO, DAMAGE OR LOSS OF OTHER PROPERTY OR EQUIPMENT, LOSS OF PROFITS OR REVENUE, TRANSPORTATION AND TOWING COSTS, COST OF PURCHASED OR REPLACED GOOD, OR CLAIMS OF CUSTOMERS OF THE PURCHASER, WHICH MAY ARISE OR RESULT FROM THE SALE, INSTALLATION, OR USE OF THESE PARTS. Some jurisdictions do not allow limitations on how long an implied warranty will last or the exclusion or limitation of incidental or consequential damages, so the limitations or exclusions contained herein may or may not apply to you. This warranty gives you specific legal rights. You may also have other rights depending on the state or province in which you reside.

THIS WARRANTY IS IN LIEU OF ALL OTHER WARRANTIES, EXPRESS AND/OR IMPLIED, INCLUDING, WITHOUT LIMITATION, WARRANTIES OF MERCHANTABILITY AND OF FITNESS FOR A PARTICULAR PURPOSE AND THEY ARE EXCLUDED TO THE EXTENT THEY EXCEED THE WARRANTY COVERAGE DESCRIBED BY THIS WARRANTY.

This warranty and remedy apply to new FP Diesel engine parts from Federal-Mogul sold directly to our authorized aftermarket customers as evidenced by completed claim documentation.

No agent or sales representative of Federal-Mogul Corporation has the authority to modify this warranty. Other Federal-Mogul parts may carry different warranties.

CLAIM PROCEDURES

Federal-Mogul must be notified by the customer: (i) before filing a warranty claim, (ii) within one year of the date that the claim accrues, and (iii) before any work has been performed. All claims must be submitted in writing and Federal-Mogul reserves the right to examine all parts, systems and related information associated with the claim. (Note all shipping charges are the responsibility of the end-user or distributor, Federal-Mogul will not accept collect shipments). See your sales representative for detailed claim submission procedures and forms.

WARNING

Use parts only for applications and interchanges in this catalog.

Failure to heed this warning could result in reduced life or failure of the part. All parts listed in this catalog are not for use in space program, atomic energy/nuclear reactor equipment, medical or aircraft applications. Federal-Mogul reserves the right to make product improvements/changes, with respect to similar products previously manufactured, without notice and without incurring liability.





Global Technology Behind Every Part

Les produits indiqués dans ce catalogue sont garantis contre toute défectuosité de matériel et de fabrication, dans des conditions d'utilisation et d'entretien normales, sur une période de deux ans à partir de la date d'installation dans un moteur, sans qualification de kilométrage ou horaire, conformément à la garantie limitée suivante.

Cette garantie est la garantie unique et exclusive pour la défaillance des pièces précitées. Ce recours exclusif ne doit pas être présumé comme ayant échoué à son objectif essentiel, tant que Federal-Mogul approuve et est capable de fournir le recours fourni ci-dessous.

LIMITATIONS DE GARANTIE

Federal-Mogul accepte uniquement de payer les pièces et la main-d'œuvre nécessaires pour réparer les dommages de moteur qui résultent de la défaillance de la garantie définie. Les coûts sont limités aux pièces et à la main-d'œuvre nécessaires pour la restauration du moteur à l'état auquel il se trouvait juste avant la défaillance.

Les frais de main-d'œuvre sont déterminés par les prix et normes publiés à l'heure actuelle dans la zone géographique dans laquelle les réparations sont effectuées. Les heures supplémentaires ou les frais de jours fériés ne sont pas permis. Nous payons également les produits d'entretien, tels que l'huile, l'antigel, les courroies, les tuyaux et les éléments de filtre qui sont endommagés en raison d'une défaillance de garantie définie.

Federal-Mogul décline toute responsabilité pour une défaillance de moteur découlant d'une négligence ou d'un abus infligés par le propriétaire, l'opérateur ou une tierce partie, de procédures d'installation ou de réparations incorrectes, de l'altération ou d'une application incorrecte de pièces, d'un manque de réparation ou d'entretien adéquat du moteur et du véhicule conformément aux manuels d'utilisation et d'entretien OEM applicables, ou de l'utilisation dans un moteur modifié à des fins de compétition ou utilisé en compétition.

SAUF SUR SPÉCIFICATION EXPRESSE DANS LA PRÉSENTE, FEDERAL-MOGUL NE SERA RESPONSABLE, EN AUCUNE CIRCONSTANCE, POUR DES DOMMAGES SPÉCIAUX, INDIRECTS, ACCESSOIRES OU CONSÉCUTIFS, Y COMPRIS, SANS S'Y LIMITER, DES DOMMAGES OU LA PERTE D'UNE AUTRE PROPRIÉTÉ OU D'UN AUTRE ÉQUIPEMENT, LA PERTE DE PROFITS OU DE REVENUS, LES FRAIS DE TRANSPORT ET DE REMORQUAGE, LES FRAIS DE BIENS ACHETÉS OU REMPLACÉS, OU LES DEMANDES DE CLIENTS DE L'ACHETEUR, QUI PEUVENT SE PRÉSENTER OU RÉSULTER DE LA VENTE, DE L'INSTALLATION OU DE L'UTILISATION DE CES PIÈCES.

Certaines juridictions ne permettent pas les limites sur la durée d'une garantie implicite, ni l'exclusion ou la limitation de dommages accessoires ou consécutifs, et, par conséquent, les limitations ou exclusions ci-incluses peuvent s'appliquer ou non pour votre cas. Cette garantie vous octroie des droits légaux spécifiques.

Vous disposez également d'autres droits en fonction de l'état ou de la province de votre résidence.

LA PRÉSENTE GARANTIE REMPLACE TOUTES AUTRES GARANTIES, EXPRESSES ET/OU IMPLICITES, Y COMPRIS, SANS S'Y LIMITER, LES GARANTIES DE QUALITÉ MARCHANDE OU D'ADAPTATION À UN USAGE PARTICULIER, ET ELLES SONT EXCLUES SI ELLES DEVAIENT DÉPASSER LA COUVERTURE DE GARANTIE DÉCRITE PAR LA PRÉSENTE GARANTIE.

Cette garantie et le recours s'appliquent aux nouvelles pièces du moteur diesel FP de Federal-Mogul vendu directement à nos clients de pièces de rechange autorisés, tel qu'attesté par les documents de demande dûment remplis. Aucun agent ou représentant de ventes de Federal-Mogul Corporation ne dispose du droit de modifier la présente garantie. D'autres pièces de Federal-Mogul peuvent être couvertes par des garanties différentes.

PROCÉDURES DE DEMANDE

Le client doit notifier Federal-Mogul : (i) avant de remplir une demande au titre de la garantie, (ii) en l'espace d'un an à partir de la date à laquelle la demande est exercée, et (iii) avant l'exécution d'un travail quelconque.

Toutes les demandes doivent être soumises par écrit et Federal-Mogul se réserve le droit d'examiner toutes les pièces, tous les systèmes et toutes les informations associées à la demande.

(Veuillez noter que l'utilisateur final ou le distributeur est responsable pour tous les frais d'expédition; Federal-Mogul n'accepte aucun envoi en port-dû). Veuillez consulter votre représentant des ventes pour les formulaires et les procédures de soumission de demande détaillés.

AVERTISSEMENT

Utilisez uniquement les pièces pour les applications et les échanges de ce catalogue.

Un manque de respect de cet avertissement pourrait résulter en une durée de vie réduite ou une défaillance de la pièce. Aucune des pièces indiquées dans ce catalogue n'est destinée à être utilisée dans un programme d'espace, pour du matériel de réacteur nucléaire/d'énergie atomique, ou des applications médicales ou d'aéronefs.

Federal-Mogul se réserve le droit d'effectuer des améliorations/changements de produits, en ce qui concerne des produits similaires fabriqués auparavant, sans avis et sans assumer de responsabilité.



Global Technology Behind Every Part

Se garantiza que todos los productos presentados en este catálogo no presentaran defecto alguno, ya sea en su material ni en su fabricación, bajo condiciones de uso y servicio normales. La garantía es de dos años de la fecha de la instalación en el motor, sin límites en el kilometraje o en las horas de funcionamiento. Esta es la única y exclusiva garantía si alguna de las partes listadas fuese a fallar. Este recurso exclusivo no se tomará como una falta, siempre y cuando Federal Mogul pueda remediarlo con las provisiones enumeradas mas abajo.

LIMITACIONES DE LA GARANTIA

Federal-Mogul pagará solo por las partes y la mano de obra necesarias para reparar daños al motor que resulten de una falla definida sobre la parte vendida. Los costos quedarán limitados a las partes y la mano de obra necesarias para restaurar el motor a la condición en la cual se encontraba inmediatamente antes de la falla.

Los costos de la mano de obra se determinarán por medio de precios publicados y estándares del área geográfica en la cual las reparaciones se lleven a cabo. No se permitirá agregar costos de tiempo extra ni por trabajo durante días festivos. Pagaremos por productos de mantenimiento tales como aceite, anti-congelantes, correas, mangueras y filtros dañados debido a alguna falla definida del producto vendido.

Federal-Mogul no se hará responsable por una falla de motor causada por el dueño, operador o un tercero, ya sea por su propia negligencia, abuso o instalación inadecuada o procedimientos de reparación inadecuados, por alteración o aplicación incorrecta de las partes, falta de servicio necesario o mantenimiento del motor o de el vehículo de acuerdo a los manuales de operación y mantenimiento de acuerdo fabricante original, o por la modificación de un motor para su uso en competencias o por haber sido usado en competencias.

FEDERAL-MOGUL NO SERÁ RESPONSABLE, BAJO NINGUNA CIRCUNSTANCIA, OTRO QUE NO SEA LO QUE SE HA MENCIONADO EXPLÍCITAMENTE EN ÉSTA GARANTÍA, POR CUALQUIER DAÑO INDIRECTO, ESPECIAL, ACCIDENTAL O CÓMO CONSECUENCIA DE OTROS DAÑOS, INCLUYENDO, PERO SIN QUE QUÉDE LIMITADO A DAÑOS O PÉRDIDAS DE BIENES O DE EQUIPO, PÉRDIDA DE GANANCIAS O INGRESOS, COSTOS DE GRÚA O TRANSPORTACIÓN, DE PARTES REEMPLAZADAS, O RECLAMOS DE CLIENTES DEL COMPRADOR, QUE PUEDAN RESULTAR DE LA VENTA, INSTALACIÓN, O USO DE ÉSTAS PARTES.

Algunas jurisdicciones no permiten limitaciones con respecto a la duración de garantías implícitas, o a la exclusión o limitación de daños accidentales, por lo tanto puede que las limitaciones o exclusiones contenidas en el presente no le apliquen a Ud. Esta garantía le ofrece derechos específicos. Ud. puede gozar de derechos adicionales dependiendo del estado o provincia en la cual viva.

ÉSTA GARANTIA REEMPLAZARA CUALQUIER Y TODA OTRA GARANTÍA, YA SEA EXPLÍCITA U IMPLÍCITA, INCLUYENDO, PERO NO LIMITANDOSE A GARANTÍAS PARA LA MERCANCÍA Y USO DE LA MISMA CON UN PROPÓSITO EN PARTICULAR, Y ESAS MISMAS QUEDARAN EXCLUIDAS SI EXCEDEN LA COBERTURA DESCRITA EN ÉSTA GARANTÍA.

Ésta garantía y recurso aplican a partes nuevas de motores de FP Diésel, vendidas directamente a nuestros clientes autorizados del mercado de reposición, lo cual será corroborado por medio de documentación usada en el reclamo.

Ningún agente o representante de la empresa Federal-Mogul tiene autoridad para modificar ésta garantía.

Otras partes de Federal-Mogul pueden tener garantías diferentes.

PROCEDIMIENTO PARA PRESENTAR UN RECLAMO

Federal-Mogul debe ser notificado por el cliente: (i) antes de presentar un reclamo cubierto en la garantía, (ii) dentro del plazo de un año de ocurrida la falla, y (iii) antes de que se haya hecho algún trabajo.

Todo reclamo debe ser entregado por escrito y Federal-Mogul reserva el derecho a examinar todas las partes, sistemas e información relacionados y asociados al reclamo. (Todo cargo de envío será responsabilidad del usuario final o distribuidor, Federal-Mogul no aceptará envíos a cobrar). Contacte a su representante de ventas para conseguir el formulario de reclamos con el procedimiento detallado.

ADVERTENCIA

Las partes deben ser usadas sólo para las aplicaciones mencionadas en éste catálogo. El no seguir ésta advertencia puede que resulte en que le falle la parte o a que su vida quede reducida. Todas las partes listadas en éste catálogo no están hechas para el uso en programas espaciales, para equipos de energía atómica, o reactores nucleares, o para aplicaciones médicas ni en naves aéreas. Federal-Mogul se reserva el derecho de hacerle mejoras y cambios a los productos, con respecto a productos similares que se hayan fabricado previamente, sin notificación o responsabilidad legal alguna.



Engine Finding Index					
Engine	Line No.	Engine	Line No.	Engine	Line No.
6.7L 408 OHV Turbo-Diesel L6 4.3005" Bore (12 Valve) (International Eng.)	1	8.7L 530 OHV Turbo-Diesel L6 4.587" Bore (12 Valve) (International Eng.)	6	11.1L 677 SOHC Turbo-Diesel L6 130mm Bore (24 Valve).....	7
7.6L 466 OHV Turbo-Diesel L6 4.3005" Bore (12 Valve) (International Eng.)	2	12.7L 774 SOHC Turbo-Diesel L6 130mm Bore (24 Valve).....	8	14.0L 858 SOHC Turbo-Diesel L6 133mm Bore (24 Valve).....	9
8.2L 500 OHV Diesel V8 108mm Bore (Fuel Pincher)	3				
8.2L 500 OHV Turbo-Diesel V8 108mm Bore (Fuel Pincher).....	4				
8.5L 519 SOHC Turbo-Diesel L4 130mm Bore (16 Valve).....	5				
Engine Code Index					
Engine Code	Engine Description	Line No.	Engine Code	Engine Description	Line No.
Series 40 (6.7L) ... Multi-Purpose Engines.....	6.7L 408 OHV Turbo-Diesel L6 4.3005" Bore (12 Valve) (International Eng.).....	1	Series 60 (12.7L) ... Multi-Purpose Engines.....	12.7L 774 SOHC Turbo-Diesel L6 130mm Bore (24 Valve).....	8
Series 40 (7.6L) ... Multi-Purpose Engines.....	7.6L 466 OHV Turbo-Diesel L6 4.3005" Bore (12 Valve) (International Eng.).....	2	Series 60 (14.0L) ... Multi-Purpose Engines.....	14.0L 858 SOHC Turbo-Diesel L6 133mm Bore (24 Valve).....	9
Series 40 (8.7L) ... Multi-Purpose Engines.....	8.7L 530 OHV Turbo-Diesel L6 4.587" Bore (12 Valve) (International Eng.).....	6	8.2 (Fuel Pincher) ... Multi-Purpose Engines.....	8.2L 500 OHV Diesel V8 108mm Bore (Fuel Pincher)	3
Series 50 (8.5L) ... Multi-Purpose Engines.....	8.5L 519 SOHC Turbo-Diesel L4 130mm Bore (16 Valve).....	5	8.2N (Fuel Pincher) ... Multi-Purpose Engines.....	8.2L 500 OHV Diesel V8 108mm Bore (Fuel Pincher)	3
Series 60 (11.1L) ... Multi-Purpose Engines.....	11.1L 677 SOHC Turbo-Diesel L6 130mm Bore (24 Valve).....	7	8.2T (Fuel Pincher) ... Multi-Purpose Engines.....	8.2L 500 OHV Turbo-Diesel V8 108mm Bore (Fuel Pincher)	4

Series 40 Engine

Identifying the Series 40

The engine serial number for all Series 40 engines is stamped on a pad located on the upper left hand side of the engine crankcase, left of the fuel filter header. Reference to the "front" indicates the fan end of the engine. Whenever the terms "Right" or "Left" are used, the reference point is from a rear position looking forward to the fan end of the engine.

Listed below are model codes used to identify the engine and horsepower ratings for the Series 40 engines.

6.7L Engines

12NEA = 175HP @ 2600 rpm
 12NEB = 190HP @ 2600 rpm
 12NEC = 210HP @ 2600 rpm
 12NED = 230HP @ 2600 rpm

7.6L Engines

12NEE = 195HP @ 2400 rpm
 12NEG = 210HP @ 2400 rpm
 12NEH = 230HP @ 2400 rpm
 12NEJ = 250HP @ 2400 rpm
 12NEK = 275HP @ 2600 rpm

8.7L Engines

12NEL = 205HP @ 2200 rpm
 12NEM = 275HP @ 2000 rpm
 12NEN = 275HP @ 2200 rpm
 12NEP = 300HP @ 2000 rpm
 12NER = 300HP @ 2200 rpm

1 Multi-Purpose Engines Series 40 Eng. (6.7L) 6.7L 408 OHV Turbo-Diesel L6 (12 Valve), 4.3005" Bore (International Eng.)				
CYL. HEAD & PARTS				
QTY	GASKETS	PART NO.	SIZE	DESCRIPTION
1	Valve Cover Gasket	FP-1817510		
1	Head Gasket	FP-1817562		
QTY	VALVE	PART NO.	SIZE	DESCRIPTION
6	Intake	FP-1818580		
6	Exhaust	FP-1824838		5/16" valve stem
24	Keeper	FP-1810944		
QTY	VALVE SEAT	PART NO.	SIZE	DESCRIPTION
6	Exh.	FP-675450	STD	I.D. Top taper 1.524"; 1.6285" OD, 1.3480" ID, .3650" Depth
6	Int.	FP-675043	STD	I.D. Top taper 1.767"; 1.9990" OD, 1.7120" ID, .3860" Depth
QTY	VALVE GUIDE	PART NO.	SIZE	DESCRIPTION
12	Guide	FP-1820264		.315" ID, .565" OD, 2.391" O.A.L.
QTY	VALVE SPRING	PART NO.	SIZE	DESCRIPTION
6	Spring	FP-677349		Int.
CAMSHAFT GROUP				
QTY	CAMSHAFT TIMING	PART NO.	SIZE	DESCRIPTION
1	Woodruff Key	FP-218211		Cam gear; 1/4" x 3/4"
FUEL SYSTEM & PARTS				
QTY	FUEL INJECTION	PART NO.	SIZE	DESCRIPTION
1	Injector Nozzle Seat Gasket	FP-675477		.060" thick
6	Grommet	FP-682810		Dust cover
6	Fuel Injector Sleeve	FP-675442		
QTY	TURBOCHARGER	PART NO.	SIZE	DESCRIPTION
1	Turbocharger Oil Inlet Gasket	FP-253660		
1	Turbocharger Mounting Gasket	FP-1822120		
COOLING SYSTEM				
QTY	WATER PUMP	PART NO.	SIZE	DESCRIPTION
1	Water Pump - Heavy Duty	FP-1817687		
ENGINE BLOCK & PARTS				
QTY	GASKETS	PART NO.	SIZE	DESCRIPTION
1	Chemicals	FP-1816593		Oil pan; RTV Sealant
1	Oil Seal Kit	FP-690437		Oil pump; Incl. seal & wear sleeve
QTY	CAM BEARINGS	PART NO.	SIZE	DESCRIPTION
1	Cam Set	FP-680117	STD	Also available as Sealed Power No. 1470M
CRANKSHAFT/OIL PUMP				
QTY	SEALS - FRONT CRANK	PART NO.	SIZE	DESCRIPTION
1	Oil Seal Kit	FP-690437		Incl. seal & wear sleeve
QTY	SEALS - REAR CRANK	PART NO.	SIZE	DESCRIPTION
1	Oil Seal Kit	FP-1817867		
1	Wear Sleeve	FP-1816569		
QTY	MAIN BEARINGS	PART NO.	SIZE	DESCRIPTION
6	Plain Main Brg.	FP-1822321	STD	Position 1-2-3-4-5-6
6	Plain Main Brg.	FP-1822490	10	Position 1-2-3-4-5-6
6	Plain Main Brg.	FP-1822491	20	Position 1-2-3-4-5-6
6	Plain Main Brg.	FP-1822492	30	Position 1-2-3-4-5-6
1	Flanged Main Brg.	FP-1822379	STD	Position 7
1	Flanged Main Brg.	FP-1822494	10	Position 7
1	Flanged Main Brg.	FP-1822495	20	Position 7
1	Flanged Main Brg.	FP-1822496	30	Position 7
CYLINDER COMPONENTS				
QTY	LINERS	PART NO.	SIZE	DESCRIPTION
6	Liner w/o Sealing Rings	FP-1815674		
6	Cyl. Liner Sealing Ring Kit	FP-1822322		
6	Sealing Ring, Liner	FP-1817633		
6	Sealing Ring, Liner	FP-1842115		PTFE
6	Sealing Ring, Liner	FP-1817000 +		When depleted use FP-1842115
QTY	PISTONS	PART NO.	SIZE	DESCRIPTION
6	Pin	FP-1818552		
12	Piston Pin Retainer	FP-1818702		
6	Pin Bushing	FP-1818598		

(continued on next page)

Multi-Purpose Engines Series 40 Eng. (6.7L) 1
6.7L 408 OHV Turbo-Diesel L6 (12 Valve), 4.3005" Bore (International Eng.) (cont.)

CYLINDER COMPONENTS (cont.)

QTY	CONNECTING RODS & BRGS.	PART NO.	SIZE	DESCRIPTION
6	Rod Pair	FP-1822389	STD	
6	Rod Pair	FP-1822486	10	
6	Rod Pair	FP-1822487	20	
QTY	PISTON RINGS	PART NO.	SIZE	DESCRIPTION
6	Ring Set Single Cylinder	FP-1817247		

Multi-Purpose Engines Series 40 Eng. (7.6L) 2
7.6L 466 OHV Turbo-Diesel L6 (12 Valve), 4.3005" Bore (International Eng.)

CYL. HEAD & PARTS

QTY	GASKETS	PART NO.	SIZE	DESCRIPTION
1	Head Gasket	FP-1817562		DT466P Engs.
QTY	VALVE	PART NO.	SIZE	DESCRIPTION
6	Intake	FP-675046		
6	Intake	FP-1824642		DT466P Engs.; From Ser. No. 956464
6	Intake	FP-1818580		DT466P Engs.; To Ser. No. 956463
6	Exhaust	FP-676865		
6	Exhaust	FP-1824842		DT466P Engs.; From Ser. No. 956464; 3/8" valve stem
6	Exhaust	FP-1824838		DT466P Engs.; To Ser. No. 956463; 5/16" valve stem
24	Keeper	FP-1824644		DT466P Engs.; From Ser. No. 956464
24	Keeper	FP-1810944		DT466P Engs.; To Ser. No. 956463
24	Keeper	VK-138		1 groove; Square cut key groove
QTY	VALVE SEAT	PART NO.	SIZE	DESCRIPTION
6	Exh.	FP-671563	2	Also available as Sealed Power No. 245-1628-1N
6	Exh.	FP-675450	STD	DT466P Engs.; I.D. Top taper 1.524"; 1.6285" OD, 1.3480" ID, .3650" Depth
6	Int.	FP-671559	2	Also available as Sealed Power No. 245-2001-1
6	Int.	FP-675043	STD	DT466P Engs.; I.D. Top taper 1.767"; 1.9990" OD, 1.7120" ID, .3860" Depth
QTY	VALVE GUIDE	PART NO.	SIZE	DESCRIPTION
12	Guide	FP-1824646		DT466P Engs.; From Ser. No. 956464; .375" ID, .6262" OD, 2.39" O.A.L.; .3750" ID, 2.3900" O.A.L.
12	Guide	FP-1820264		DT466P Engs.; To Ser. No. 956463; .315" ID, .565" OD, 2.391" O.A.L.
12	Guide	FP-1815264		From 6/89; new style, cut for valve stem seal
12	Guide	FP-675439		To 5/89
QTY	VALVE SPRING	PART NO.	SIZE	DESCRIPTION
12	Spring	FP-682064		Also available as Sealed Power No. VS-858; 2.3400" Free Height
6	Spring	FP-1825540		Exh.; DT466P Engs.
6	Spring	FP-677349		Int.; DT466P Engs.
QTY	VALVE MISC.	PART NO.	SIZE	DESCRIPTION
6	Rotocap Assy.	FP-1811581		To Ser. No. 594839; Also available as Sealed Power No. RC-150
12	Rotocap	FP-1824680		DT466P Engs.; From Ser. No. 956464; Valve stem seal incl.
12	Valve Rotator Seal	FP-1824683		DT466P Engs.; From Ser. No. 956464

CAMSHAFT GROUP

QTY	TIMING	PART NO.	SIZE	DESCRIPTION
1	Cam Gear	FP-675600		Also available as Sealed Power No. 221-3312; 66 Teeth
QTY	CAMSHAFT TIMING	PART NO.	SIZE	DESCRIPTION
1	Woodruff Key	FP-218211		Cam gear; 1/4" x 3/4"
QTY	CAMSHAFT/LIFTER	PART NO.	SIZE	DESCRIPTION
1	Prelube	55-400		4 oz. bottle; 1.5 oz. packet No. 55-403 also avail.
1	Prelube	55-400		4 oz. bottle; 1.5 oz. packet No. 55-403 also avail.

FUEL SYSTEM & PARTS

QTY	FUEL INJECTION	PART NO.	SIZE	DESCRIPTION
6	Injector Nozzle Seat Gasket	FP-675477		DT466P Engs.; .060" thick
6	Grommet	FP-682810		Injector dust seal; DT466P Engs.
6	Fuel Injector Sleeve	FP-675442		DT466P Engs.
QTY	TURBOCHARGER	PART NO.	SIZE	DESCRIPTION
1	Turbocharger Mounting Gasket	FP-1822120		DT466P Engs.

(continued on next page)

2 Multi-Purpose Engines Series 40 Eng. (7.6L) (cont.) 7.6L 466 OHV Turbo-Diesel L6 (12 Valve), 4.3005" Bore (International Eng.)				
COOLING SYSTEM				
QTY	WATER PUMP	PART NO.	SIZE	DESCRIPTION
1	Water Pump - Heavy Duty	FP-1817687		DT466P Engs.
ENGINE BLOCK & PARTS				
QTY	GASKETS	PART NO.	SIZE	DESCRIPTION
1	Chemicals	FP-1816593		Oil Pan; DT466P Engs.; For oil pan w/o mounting bars; RTV Sealant
QTY	GASKET SETS	PART NO.	SIZE	DESCRIPTION
1	In-Frame Gasket Set	FP-PGN466IF		Head set & bearing roll-in
1	In-Frame Gasket Set	PGN466-IF +		Head set & bearing roll-in; When depleted use FP-PGN466IF
1	Complete Overhaul Gasket Set	FP-PGN466C		
1	Complete Overhaul Gasket Set	PGN466C +		When depleted use FP-PGN466C
QTY	CAM BEARINGS	PART NO.	SIZE	DESCRIPTION
1	Cam Set	FP-680117	STD	DT466P Engs.; Also available as Sealed Power No. 1470M
CRANKSHAFT/OIL PUMP				
QTY	SEALS - FRONT CRANK	PART NO.	SIZE	DESCRIPTION
1	Oil Seal Kit	FP-690437		DT466P Engs.; Incl. seal & wear sleeve
QTY	SEALS - REAR CRANK	PART NO.	SIZE	DESCRIPTION
1	Oil Seal Kit	FP-1817867		
QTY	MAIN BEARINGS	PART NO.	SIZE	DESCRIPTION
6	Plain Main Brg.	FP-1822321	STD	Position 1-2-3-4-5-6; DT466P Engs.
6	Plain Main Brg.	FP-1822490	10	Position 1-2-3-4-5-6; DT466P Engs.
6	Plain Main Brg.	FP-1822491	20	Position 1-2-3-4-5-6; DT466P Engs.
6	Plain Main Brg.	FP-1822492	30	Position 1-2-3-4-5-6; DT466P Engs.
1	Flanged Main Brg.	FP-1822379	STD	Position 7; DT466P Engs.
1	Flanged Main Brg.	FP-1822494	10	Position 7; DT466P Engs.
1	Flanged Main Brg.	FP-1822495	20	Position 7; DT466P Engs.
1	Flanged Main Brg.	FP-1822496	30	Position 7; DT466P Engs.
CYLINDER COMPONENTS				
QTY	LINERS	PART NO.	SIZE	DESCRIPTION
6	Liner w/o Sealing Rings	FP-1815674		DT466P Engs.
6	Cylinder Kit Complete	FP-1824820	STD	DT466P (NGD) Engs.; From Ser. No. 888341; 2 Keystone rings; Barrel skirt; Bowl Dia. 2.580"
6	Cylinder Kit Complete	FP-1824823	STD	DT466P Engs.; From Ser. No. 888341 to 933833; 1 Keystone ring; Barrel skirt; Bowl Dia. 2.540"
6	Cylinder Kit Complete	FP-1822340	STD	DT466P Engs.; To Ser. No. 888340; 2 Keystone rings; Tapered skirt; Bowl Dia. 2.519"
6	Cyl. Liner Sealing Ring Kit	FP-1822322		DT466P Engs.
QTY	PISTONS	PART NO.	SIZE	DESCRIPTION
6	Piston Body w/o Pin	FP-1824810	STD	DT466P (NGD) Engs.; From Ser. No. 888341; 1 Keystone ring; Barrel skirt; Bowl Dia. 2.540"
6	Piston Body w/o Pin	FP-1823930	STD	DT466P (NGD) Engs.; From Ser. No. 888341; 2 Keystone rings; Barrel skirt; Bowl Dia. 2.580"
6	Piston Body w/o Pin	FP-1822097	STD	DT466P Engs.; To Ser. No. 888340; 2 Keystone rings; Tapered skirt; Bowl Dia. 2.519"
6	Piston Kit w/Pin & Retainers	FP-1824810WP		DT466P (NGD) Engs.; From Ser. No. 888341; 1 Keystone ring
6	Piston Kit w/Pin & Retainers	FP-1822097WP		DT466P Engs.; To Ser. No. 888340
6	Pin	FP-1818552		DT466P Engs.
12	Piston Pin Retainer	FP-1818702		DT466P Engs.
6	Pin Bushing	FP-1818598		DT466P Engs.
QTY	CONNECTING RODS & BRGS.	PART NO.	SIZE	DESCRIPTION
6	Rod Pair	FP-1822389	STD	DT466P Engs.
6	Rod Pair	FP-1822486	10	DT466P Engs.
6	Rod Pair	FP-1822487	20	DT466P Engs.
QTY	PISTON RINGS	PART NO.	SIZE	DESCRIPTION
6	Ring Set Single Cylinder	FP-1825461		DT466P Engs.; From Ser. No. 888341
6	Ring Set Single Cylinder	FP-1817247		DT466P Engs.; To Ser. No. 888340
KITS				
QTY	OVERHAUL KIT	PART NO.	SIZE	DESCRIPTION
1	In-Frame Overhaul Kit	FP-IFKDT466PNGD		From Ser. No. 850654 to 933833

8.2L Engine



Identifying the 8.2L

The options and equipment for 8.2L engines can be identified by the Option Label that includes the engine serial number and model number. Engines prior to serial number 8G27987 were built with standard equipment only. No optional equipment was offered and no model label was provided. Engines after serial number 8G27987 will have the Option Label located behind the water pump.

A typical Model Number would be RC 4087-7300. This Model Number is broken down below to demonstrate the identification on the engine.

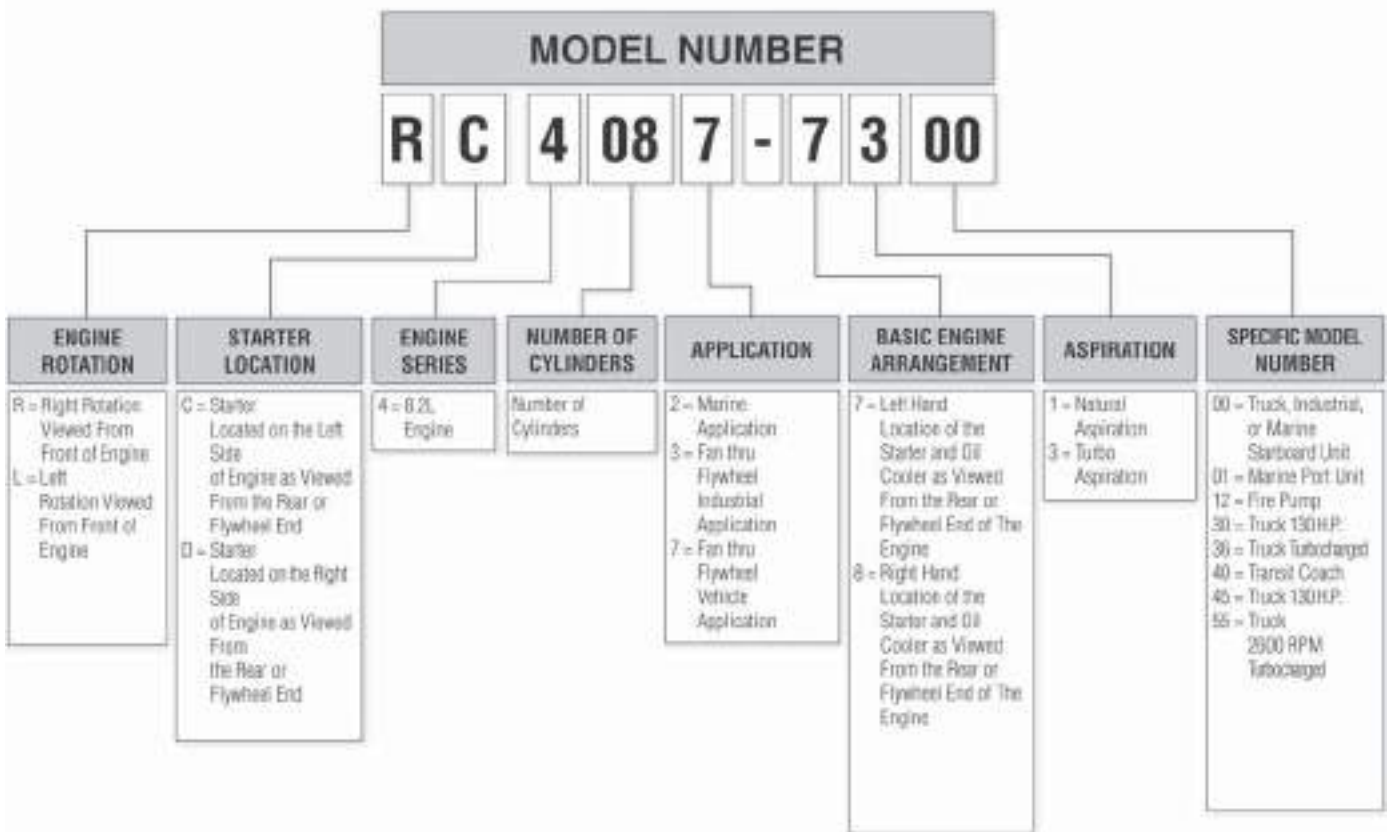

8.2L Specialty Gasket Sets

ENGINE	PART NO.	DESCRIPTION
8.2L	FP-8924126 10	Overhaul Gasket Set w/.010" O/S Cyl. Head Gaskets – No Valve Cover Gaskets
8.2L	FP-8924126C	Overhaul Gasket Set w/Front Seal & 11 Hole Valve Cover Gaskets – Engines w/o Breather
8.2L	FP-8924126-C 10	Overhaul Gasket Set w/.010" O/S Cyl. Head Gaskets, Front Seal & 11 Hole Valve Cover Gaskets – Engines w/o Breather
8.2L	FP-8924126CB	Overhaul Gasket Set w/Front Seal & 9 Hole Valve Cover Gaskets – Engines w/Breather
8.2L	FP-8924126-WS	Overhaul Gasket Set w/Bi-Directional Crankshaft Seals
8.2L	FP-8924127MV	Multiple Cyl. Head Gasket Set w/11 Hole Valve Cover Gaskets – Engines w/o Breather
8.2L	FP-8924127MVB	Multiple Cyl. Head Gasket Set w/9 Hole Valve Cover Gaskets – Engines w/Breather
8.2L	FP-8924127V	Single Cyl. Head Gasket Set w/11 Hole Valve Cover Gaskets – Engines w/o Breather
8.2L	FP-8924127VB	Single Cyl. Head Gasket Set w/9 Hole Valve Cover Gaskets – Engines w/Breather
8.2L	FP-8924127 10	Single Cyl. Head Gasket Set w/.010" O/S Cyl. Head Gaskets – No Valve Cover Gaskets
8.2L	PGE4126	Overhaul Gasket Set w/o Cylinder Head Gaskets
8.2L	PGE4126C 10	Overhaul Gasket Set w/.010" O/S Cyl. Head Gaskets, Crankshaft Seals – Engines w/o Breather
8.2L	PGE4127-IF	In-Frame Overhaul Gasket Set
8.2L	PGE4127-IF 10	In-Frame Overhaul Gasket Set w/.010" O/S Cyl. Head Gaskets

8.2L Engine



8.2L Naturally Aspirated Engine In-Frame Overhaul

KIT NUMBER	COMPONENT NO.	QTY.	PART SIZE	PART DESCRIPTION	PART APPLICATION
FP-8.2-NA	FP-8921605	8	Std.	Piston Body w/o Pin	18.8:1 C.R. – Grade A
	FP-8922234	8	Std.	Piston Body w/o Pin	18.8:1 C.R. – Grade B
	FP-8922236	8	Std.	Piston Body w/o Pin	18.8:1 C.R. – Grade C
	FP-8928520	8	Std.	Piston Body w/o Pin	18.8:1 C.R. – Grade D
	FP-8922451	8	.005"	Piston Body w/o Pin	18.8:1 C.R.
	FP-8922452	8	.010"	Piston Body w/o Pin	18.8:1 C.R.
	FP-8922453	8	.020"	Piston Body w/o Pin	18.8:1 C.R.
	FP-8925717	8		Piston Pin	
	FP-8922977	16		Piston Pin Retainer	
	FP-8921721	8	Std.	Single Cylinder Ring Set	
	FP-8923779	8	.005"	Single Cylinder Ring Set	
	FP-8923917	8	.010"	Single Cylinder Ring Set	
	FP-8923919	8	.020"	Single Cylinder Ring Set	
	FP-8921714	8	Std.	Rod Bearing Pair	
	FP-8924703	8	.25MM	Rod Bearing Pair	
	FP-5099M	1	Std.	Main Bearing Set	
	FP-5099M .25MM	1	.25MM	Main Bearing Set	
	FP-5099M .50MM	1	.50MM	Main Bearing Set	
	FP-8924127	1	Std.	Head Gasket Set	Includes Standard Head Gasket – No Valve Cover Gasket
	FP-8924127 10	1	.010"	Head Gasket Set	Includes .010" O/S Head Gasket – No Valve Cover Gasket
	FP-8920271	1		Valve Cover Gasket	Early Style w/11 mounting holes
	FP-8926675	1		Valve Cover Gasket	Late Style w/9 mounting holes
	FP-5149728	1		Oil Pan Gasket Set	

8.2L Naturally Aspirated Engine Complete Overhaul

KIT NUMBER	COMPONENT NO.	QTY.	PART SIZE	PART DESCRIPTION	PART APPLICATION
FP-8.2-NA-OH	FP-8921605	8	Std.	Piston Body w/o Pin	18.8:1 C.R. – Grade A
	FP-8922234	8	Std.	Piston Body w/o Pin	18.8:1 C.R. – Grade B
	FP-8922236	8	Std.	Piston Body w/o Pin	18.8:1 C.R. – Grade C
	FP-8928520	8	Std.	Piston Body w/o Pin	18.8:1 C.R. – Grade D
	FP-8922451	8	.005"	Piston Body w/o Pin	18.8:1 C.R.
	FP-8922452	8	.010"	Piston Body w/o Pin	18.8:1 C.R.
	FP-8922453	8	.020"	Piston Body w/o Pin	18.8:1 C.R.
	FP-8925717	8		Piston Pin	
	FP-8922977	16		Piston Pin Retainer	
	FP-8921721	8	Std.	Single Cylinder Ring Set	
	FP-8923779	8	.005"	Single Cylinder Ring Set	
	FP-8923917	8	.010"	Single Cylinder Ring Set	
	FP-8923919	8	.020"	Single Cylinder Ring Set	
	FP-8921714	8	Std.	Rod Bearing Pair	
	FP-8924703	8	.25MM	Rod Bearing Pair	
	FP-5099M	1	Std.	Main Bearing Set	
	FP-5099M .25MM	1	.25MM	Main Bearing Set	
	FP-5099M .50MM	1	.50MM	Main Bearing Set	
	FP-8924126	1	Std.	Complete Overhaul Gasket Set	Includes Standard Head Gasket – No Valve Cover Gasket
	FP-8924126 10	1	.010"	Complete Overhaul Gasket Set	Includes .010" O/S Head Gasket – No Valve Cover Gasket
	FP-8920271	1		Valve Cover Gasket	Early Style w/11 mounting holes
	FP-8926675	1		Valve Cover Gasket	Late Style w/9 mounting holes

8.2L Engine



8.2L Turbocharged Engine In-Frame Overhaul

KIT NUMBER	COMPONENT NO.	QTY.	PART SIZE	PART DESCRIPTION	PART APPLICATION
FP-8.2-T	FP-8925818	8	Std.	Piston Body w/o Pin	17.4:1 C.R. – Grade A
	FP-8925819	8	Std.	Piston Body w/o Pin	17.4:1 C.R. – Grade B
	FP-8925820	8	Std.	Piston Body w/o Pin	17.4:1 C.R. – Grade C
	FP-8928521	8	Std.	Piston Body w/o Pin	17.4:1 C.R. – Grade D
	FP-8925815	8	.005"	Piston Body w/o Pin	17.4:1 C.R.
	FP-8925816	8	.010"	Piston Body w/o Pin	17.4:1 C.R.
	FP-8925817	8	.020"	Piston Body w/o Pin	17.4:1 C.R.
	FP-8925717	8		Piston Pin	
	FP-8922977	16		Piston Pin Retainer	
	FP-8921722	8	Std.	Single Cylinder Ring Set	
	FP-8923780	8	.005"	Single Cylinder Ring Set	
	FP-8923918	8	.010"	Single Cylinder Ring Set	
	FP-8923920	8	.020"	Single Cylinder Ring Set	
	FP-8921714	8	Std.	Rod Bearing Pair	
	FP-8924703	8	.25MM	Rod Bearing Pair	
	FP-5099M	1	Std.	Main Bearing Set	
	FP-5099M .25MM	1	.25MM	Main Bearing Set	
	FP-5099M .50MM	1	.50MM	Main Bearing Set	
	FP-8924127	1	Std.	Head Gasket Set	Includes Standard Head Gasket – No Valve Cover Gasket
	FP-8924127 10	1	.010"	Head Gasket Set	Includes .010" O/S Head Gasket – No Valve Cover Gasket
	FP-8920271	1		Valve Cover Gasket	Early Style w/11 mounting holes
	FP-8926675	1		Valve Cover Gasket	Late Style w/9 mounting holes
	FP-5149728	1		Oil Pan Gasket Set	

8.2L Turbocharged Engine Complete Overhaul

KIT NUMBER	COMPONENT NO.	QTY.	PART SIZE	PART DESCRIPTION	PART APPLICATION
FP-8.2-T-OH	FP-8925818	8	Std.	Piston Body w/o Pin	17.4:1 C.R. – Grade A
	FP-8925819	8	Std.	Piston Body w/o Pin	17.4:1 C.R. – Grade B
	FP-8925820	8	Std.	Piston Body w/o Pin	17.4:1 C.R. – Grade C
	FP-8928521	8	Std.	Piston Body w/o Pin	17.4:1 C.R. – Grade D
	FP-8925815	8	.005"	Piston Body w/o Pin	17.4:1 C.R.
	FP-8925816	8	.010"	Piston Body w/o Pin	17.4:1 C.R.
	FP-8925817	8	.020"	Piston Body w/o Pin	17.4:1 C.R.
	FP-8925717	8		Piston Pin	
	FP-8922977	16		Piston Pin Retainer	
	FP-8921722	8	Std.	Single Cylinder Ring Set	
	FP-8923780	8	.005"	Single Cylinder Ring Set	
	FP-8923918	8	.010"	Single Cylinder Ring Set	
	FP-8923920	8	.020"	Single Cylinder Ring Set	
	FP-8921714	8	Std.	Rod Bearing Pair	
	FP-8924703	8	.25MM	Rod Bearing Pair	
	FP-5099M	1	Std.	Main Bearing Set	
	FP-5099M .25MM	1	.25MM	Main Bearing Set	
	FP-5099M .50MM	1	.50MM	Main Bearing Set	
	FP-8924126	1	Std.	Complete Overhaul Gasket Set	Includes Standard Head Gasket – No Valve Cover Gasket
	FP-8924126 10	1	.010"	Complete Overhaul Gasket Set	Includes .010" O/S Head Gasket – No Valve Cover Gasket
FP-8920271	1		Valve Cover Gasket	Early Style w/11 mounting holes	
FP-8926675	1		Valve Cover Gasket	Late Style w/9 mounting holes	

Multi-Purpose Engines 8.2, 8.2N Engs. (Fuel Pincher) 3
8.2L 500 OHV Diesel V8 (Fuel Pincher), 108mm Bore

CYL. HEAD & PARTS				
QTY	GASKETS	PART NO.	SIZE	DESCRIPTION
2	Valve Cover Gasket	FP-8920271		w/o Breather
2	Valve Cover Gasket	FP-8926675		w/Breather
2	Head Gasket	FP-8923848		
1	Head Set	FP-8924127		
1	Head Set	FP-892412710		Incl. .010" oversized cylinder head gskt.; Valve cover gskt. not incl.
1	Head Set	FP-8924127V		Incl. 11 hole valve cover gskts. for valve covers w/o breather
1	Head Set	FP-8924127VB		Incl. 9 hole valve cover gskts. for valve covers w/breather
1	Multiple Cyl. Head Gskt. Set	FP-8924127MV		Incl. 11 hole valve cover gskts. for valve covers w/o breather
1	Multiple Cyl. Head Gskt. Set	FP-8924127MVB		Incl. 9 hole valve cover gskts. for valve covers w/breather
1	Breather Seal Ring	FP-8921294		
QTY	HEAD BOLTS	PART NO.	SIZE	DESCRIPTION
10	Head Bolt	FP-23500463		M15 x 2.0 x 128MM; 12 Point head
10	Head Bolt	FP-23500462		M15 x 2.0 x 158MM; 12 Point head
2	Head Bolt Set	FP-2602522		Replacement recommended; 15MM bolts only
2	Head Bolt Set	260-2522 +		Replacement recommended; 15MM bolts only; When depleted use FP-2602522
20	Washer	FP-8921876		To Ser. No. 8G138422; Exc. Marine applications
QTY	VALVE	PART NO.	SIZE	DESCRIPTION
8	Intake	FP-8920119		
8	Exhaust	FP-8921347		
8	Exhaust Valve Kit	FP-23502067		Valve & valve keepers incl.
8	Intake Valve Kit	FP-23502068		Valve & valve keepers incl.
16	Valve Guide Cap	FP-5199914		Seal installer; Clear
32	Keeper	FP-23507238		1 groove; Square cut key groove
32	Keeper	VK-115R		1 groove; Square cut key groove; Hardened
32	Keeper, Bulk	VK-115B		1 groove; Square cut key groove; Carton of 1000
QTY	VALVE GUIDE	PART NO.	SIZE	DESCRIPTION
16	Guide	FP-VG5079T		Exh. & Int.; .3440" ID, 2.8750" O.A.L.
QTY	VALVE SPRING	PART NO.	SIZE	DESCRIPTION
16	Spring	FP-8927857		Exh. & Int.; Also available as Sealed Power No. VS-1645
QTY	PUSH RODS	PART NO.	SIZE	DESCRIPTION
8	Push Rod Spring	FP-8921253		
QTY	VALVE MISC.	PART NO.	SIZE	DESCRIPTION
16	Rotocap	FP-8922369		Also available as Sealed Power No. RC-155
2	Oil Filler Cap	FP-5108474		Twist Type
QTY	VALVE SEAL	PART NO.	SIZE	DESCRIPTION
16	Valve Stem Seal	FP-23500480		
QTY	ROCKER PARTS	PART NO.	SIZE	DESCRIPTION
8	Rocker Shaft	FP-8920478		Includes plug; Also available as Sealed Power No. RS-657
8	Expansion Plug	FP-5151272		Rocker shaft
8	Cam Follower Roller Set	FP-8923814		Injector; Incl. pin & roller
8	Cam Follower Roller Set	FP-8923813		Valve; Incl. pin & roller
ELECTRICAL				
QTY	ELECTRICAL	PART NO.	SIZE	DESCRIPTION
1	Starting Motor Gasket	FP-5130995		
INT & EXH MANIFOLDS				
QTY	INT. & EXH. MANIFOLDS	PART NO.	SIZE	DESCRIPTION
2	Exhaust Manifold Gasket	FP-8921817		
1	Cyl. Block Valley Cover Gskt.	FP-8920220		Front
1	Cyl. Block Valley Cover Gskt.	FP-8920246		Rear
2	Extruded Seal	FP-8920219		Side Valley Pan
3	Pipe Plug	FP-23511574		1/2" pipe thread; w/1" Square head
2	Pipe Plug	FP-8923847		1/4" x 18 NPTF; Square head
QTY	AIR INTAKE	PART NO.	SIZE	DESCRIPTION
2	Air Intake Housing Gasket	FP-8920247		
QTY	AIR CLEANER	PART NO.	SIZE	DESCRIPTION
1	Air Cleaner Adapter Screen	FP-8920732		Mounting adapter
1	Air Cleaner Adapter Screen	FP-8927214		Mounting adapter; Closed breather system
1	Pipe Plug	FP-5142549		Mounting adapter; 3/4" - 14 Square Head
2	Seal & Plate Assembly	FP-8921883		Mounting adapter

(continued on next page)

3 Multi-Purpose Engines 8.2, 8.2N Eng. (Fuel Pincher) (cont.) 8.2L 500 OHV Diesel V8 (Fuel Pincher), 108mm Bore

CAMSHAFT GROUP				
QTY	TIMING COVER	PART NO.	SIZE	DESCRIPTION
1	Crankshaft Front Cover Gasket	FP-8920273		
1	Crankshaft Front Cover Gasket	FP-8923090		Cover to oil pan
FUEL SYSTEM & PARTS				
QTY	FUEL INJECTION	PART NO.	SIZE	DESCRIPTION
8	Fuel Injector Seal Ring	FP-8920390		
8	Injector Hole Tube Kit	FP-8925981A		
8	Injector Hole Tube Kit	FP-5149724		Injector tube seal ring incl.
8	Fuel Injector	FP-5229850		4A53
8	Fuel Injector Repair Kit	FP-5229930		
4	Bracket	FP-8920350		Control tube
8	Fuel Injection Valve Cage	FP-5229726		Spring cage
8	Fuel Injection Spring Seat	FP-5228766		Valve spring seat
8	Fuel Injector Valve Spring	FP-5228596		
8	Fuel Injector Check Valve	FP-5228694		
8	Injector Plunger & Bushing	FP-5229840		4A53 & 4B55; Assembly
8	Fuel Injector Tip Kit	FP-5229727		4A53
8	Fuel Injector Tip Kit	FP-5229846		4C65
8	Nut	FP-5229720		Fuel injector valve
8	Fuel Injector Valve Kit	FP-5228769		
QTY	FUEL FILTERS & PUMP	PART NO.	SIZE	DESCRIPTION
1	Mechanical Fuel Pump	FP-5199735		Left hand; High output; w/.375" Gear
1	Mechanical Fuel Pump	FP-5199560		Left hand; Std. output; w/.250" Gear
1	Mechanical Fuel Pump	FP-5199561		Right hand
1	Mechanical Fuel Pump	FP-5199734		Right hand; High output
1	Fuel Pump Valve Plug Gasket	FP-5161003		
1	Fuel Pump Shaft & Gear	FP-5181747		Driven; .838" Length; Std. Output
1	Fuel Pump Valve	FP-5174973		
1	Fuel Pump Coupling	FP-5154216		
1	Fuel Pump Gear	FP-5174975		.294" Width; Std. Output
1	Fuel Pump Drive Shaft	FP-5178700		Drive; 3.09" Length
1	Fuel Pump Relief Valve Spring	FP-5184530		
1	Fuel Pump Repair Part	FP-5174971		Fuel pump valve; .500" x 20 plug
1	Fuel Pump Drive Adapter Gskt.	FP-5150193		Fuel pump to block
1	Oil Seal	FP-23512243		Fuel pump
1	Fuel Pump Repair Kit	FP-5149599		w/High output fuel pump; High output; Short Shaft
1	Fuel Pump Repair Kit	FP-5195078		w/Std. fuel pump; Std. output
2	Pipe Plug	FP-5121182		Fuel filter cover; 1/4" - 18; Hex head
2	Pipe Plug	FP-8923847		Fuel filter cover; 1/4" x 18 NPTF; Square head
2	Pipe Plug	FP-8924380		Fuel pump drain; 1/8" - 27
1	Plastic Cap	FP-5136240		Fuel pump drain; .250" Dia.
2	Plastic Cap	FP-5136241		Fuel pump drain; .780" Dia., 3/8" NPTF
1	Dowel Pin	FP-103709		Fuel pump valve spring; 5/32" x 1" straight
2	Dowel Pin	FP-141195		Fuel pump body; .250" x .625"
1	Ball Brg.	FP-147481		Drive gear; .125" Dia. Steel
1	Bushing	FP-5198558		Fuel pump cover; 3/8" x 1/4"
1	Bushing	FP-5198558		Fuel pump shaft; 3/8" x 1/4"
GOVERNOR				
QTY	GOVERNOR	PART NO.	SIZE	DESCRIPTION
1	Retaining Ring	FP-9411502		Governor weight shaft end brg.
1	Governor Spring	FP-5122165		Low speed; w/One Blue Stripe
1	Governor Spring	FP-5183704		Low speed; w/Two Yellow Stripes
1	Governor Low Speed Spring Cap	FP-5103975		
1	Screw	FP-5102270		Low speed spring adjusting; .250" - 28 x 1.00"
1	O-Ring	FP-5176557		Variable speed spring lever shaft packing; .477" ID x .113" Thick
2	Cylindrical Brg.	FP-148402		Variable speed spring lever shaft; .500" x .500" Dia.
4	Governor Valve Spring Shim	FP-5136590		Variable speed; .010"
2	Governor Valve Spring Shim	FP-5136591		Variable speed; .078"
1	Pin	FP-457008		Variable speed shaft pin; 3/16" x 1 1/2"
2	Governor Retainer	FP-5178581		Variable speed throttle shaft; Lower
2	Governor Retainer	FP-5144178		Variable speed throttle shaft; Upper
1	Ball Brg.	FP-9437108		Gov. Weight Riser Thrust Brg.; .354" Width
1	Ball Brg.	FP-23506244		Governor weight shaft end brg.
1	Ball Brg.	FP-9431894		Upper operating shaft
1	Governor Riser	FP-5117193		1.062" Length
1	Governor Spring Cover Gasket	FP-8922593		High speed
1	Nut	FP-5174286		Governor buffer screw; 3/8" - 24 UNF
1	Governor to Cyl. Block Gasket	FP-8920308		

(continued on next page)

Multi-Purpose Engines 8.2, 8.2N Engs. (Fuel Pincher) 3
8.2L 500 OHV Diesel V8 (Fuel Pincher), 108mm Bore (cont.)

GOVERNOR (cont.)

QTY	GOVERNOR (cont.)	PART NO.	SIZE	DESCRIPTION
1	Governor Gasket	FP-5180539		Variable speed cover; Copper material
1	Copper Washer	FP-5152148		Governor cover; 25/64" ID x 9/16" OD x 1/16" Thick; Copper
1	Copper Washer	FP-5152148		High speed spring adj. screw housing; 25/64" ID x 9/16" OD x 1/16" Thick; Copper
2	Washer	FP-5151487		Variable speed throttle shaft; 3/8" x 11/16" x .033"
1	Governor Seal Ring	FP-5101691		Variable speed throttle shaft; .362" x .113"
1	Solenoid Mounting Gasket	FP-8921033		Air shutoff mounting
1	Solenoid Plunger Assy. Gasket	FP-8927033		Air shutoff between plunger & solenoid
1	Governor Hole Gasket	FP-8920399		Control tube to cylinder head
1	Governor Cover Gasket	FP-8920290		Limiting speed
1	Retainer	FP-142583		Operating shaft lever spring; 13/64" Spring

COOLING SYSTEM

QTY	WATER PUMP	PART NO.	SIZE	DESCRIPTION
1	Water Pump - Heavy Duty	FP-8928672		Fresh water pump assy.; Thermostat housing not incl.
1	Water Pump Impeller	FP-8927727		Use w/Fresh water pump
1	Water Pump Impeller	FP-5193602		Use w/Raw water pump; Synthetic
1	Water Pump Repair/Rebuild Kit	FP-8928670		Fresh water pump; Incl. bearing, seal, impeller & hub
1	Water Pump Repair/Rebuild Kit	FP-8928671		Fresh water pump; Incl. bearing, seal, impeller, cover & seal ring
1	Water Pump Cover	FP-8923151		Fresh water pump
1	Water Pump Mech. Shaft Seal	FP-8927408		Fresh water pump
2	Fresh Water Outlet Elbow Gskt	FP-8920161		Right & left bank
1	Fresh Water Outlet Elbow Gskt	FP-8920083		Right bank
1	Fresh Water Pump Gasket	FP-8922132		Pump to front cover
1	Rect. or Square Seal	FP-8923152		Fresh water pump cover
1	Pipe Plug	FP-5115214		Water pump housing; 1/2" Square Head
2	Pipe Plug	FP-5142549		Water pump housing; 3/4" - 14 Square Head
1	Shaft & Bearing Assembly	FP-8920144		Fresh water pump
1	Water Pump Hub	FP-8922299		Driven hub

QTY	THERMOSTAT	PART NO.	SIZE	DESCRIPTION
2	Thermostat	FP-3046745		
1	Thermostat Gasket	FP-8924813		For dual thermostat applications

ENGINE BLOCK & PARTS

QTY	GASKETS	PART NO.	SIZE	DESCRIPTION
1	Flywheel Housing Gasket	FP-8920091		
1	Oil Pan Gasket Kit	FP-5149728		
1	Washer	FP-5177773		Oil filter bypass plug; 18MM x 1.5MM
1	Washer	FP-8922349		Oil drain plug

QTY	GASKET SETS	PART NO.	SIZE	DESCRIPTION
1	In-Frame Gasket Set	FP-PGE4127IF		In Frm.; Head gskts. will accomodate 15mm head bolts; Incl. four-piece oil pan gskt.; Premium valve stem seals incl.
1	In-Frame Gasket Set	FP-PGE4127IF10		In Frm.; Head gskts. will accomodate 15mm head bolts; Incl. four-piece oil pan gskt.; Premium valve stem seals incl.; Incl. .010" oversized cylinder head gskts.
1	In-Frame Gasket Set	PGE4127-IF +		In Frm.; Head gskts. will accomodate 15mm head bolts; Incl. four-piece oil pan gskt.; Premium valve stem seals incl.; When depleted use FP-PGE4127IF
1	In-Frame Gasket Set	PGE4127-IF 10 +		Incl. .010" oversized cylinder head gskts.; When depleted use FP-PGE4127IF10
1	Complete Overhaul Gasket Set	FP-8924126		Crankshaft seals & valve cover gskts. not incl.
1	Complete Overhaul Gasket Set	FP-8924126		Crankshaft seals & valve cover gskts. not incl.
1	Complete Overhaul Gasket Set	FP-8924126CB		Crankshaft seals not incl.; Incl. front seal & 9 hole valve cover gskt. for valve covers w/breather
1	Complete Overhaul Gasket Set	FP-PGE4126		Head gskts. not incl.
1	Complete Overhaul Gasket Set	PGE4126 +		Head gskts. not incl.; When depleted use FP-PGE4126
1	Complete Overhaul Gasket Set	FP-892412610		Incl. .010" oversized cylinder head gskt.; Crankshaft seals & valve cover gskts. not incl.
1	Complete Overhaul Gasket Set	FP-8924126C10		Incl. .010" oversized cylinder head gskt.; Rear crankshaft seals not incl.; Incl. front seal & 11 hole valve cover gskts. for valve covers w/o breather
1	Complete Overhaul Gasket Set	FP-PGE4126C10		Incl. .010" oversized cylinder head gskts., crankshaft seals, & valve cover gskts. for valve covers w/o breathers
1	Complete Overhaul Gasket Set	PGE4126C 10 +		Incl. .010" oversized cylinder head gskts., crankshaft seals, & valve cover gskts. for valve covers w/o breathers; When depleted use FP-PGE4126C10
1	Complete Overhaul Gasket Set	FP-8924126WS		Incl. bi-directional crank seals
1	Complete Overhaul Gasket Set	FP-8924126C		Rear crankshaft seals not incl.; Incl. front seal & 11 hole valve cover gskt. for valve covers w/o breather

(continued on next page)

3 Multi-Purpose Engines 8.2, 8.2N Eng. (Fuel Pincher) (cont.) 8.2L 500 OHV Diesel V8 (Fuel Pincher), 108mm Bore

ENGINE BLOCK & PARTS (cont.)				
QTY	CAM BEARINGS	PART NO.	SIZE	DESCRIPTION
1	Cam Set	FP-8922110	STD	
QTY	OIL COOLERS & FILTERS	PART NO.	SIZE	DESCRIPTION
1	Oil Cooler	FP-8547194		4 plate
1	O-Ring	FP-8920849		Adapter to block; .487" ID x .6875" OD
1	Rect. or Square Seal	FP-8920180		Adapter to block; 18.82MM ID x 3.175MM Thick
1	Copper Washer	FP-5152148		Adapter; 25/64" ID x 9/16" OD x 1/16" Thick; Copper
QTY	FREEZE PLUGS	PART NO.	SIZE	DESCRIPTION
2	Pipe Plug	FP-5115214		1/2" Square Head
1	Pipe Plug	FP-8924380		1/8" - 27
QTY	DIPSTICK	PART NO.	SIZE	DESCRIPTION
1	Dipstick	FP-8920462		478.0MM to top of cap
CRANKSHAFT/OIL PUMP				
QTY	SEALS - FRONT CRANK	PART NO.	SIZE	DESCRIPTION
1	Oil Seal	FP-8920200		Single lip; Also available as National No. 473476
1	Redi-Sleeve	99250		
1	Oil Seal	473476		
QTY	SEALS - REAR CRANK	PART NO.	SIZE	DESCRIPTION
1	Oil Seal	FP-8926761		Std.; Single lip; R.H. Rotation
1	Oil Seal	FP-8923654		Use w/FP-8923655; O.S.; Single lip; R.H. Rotation
1	Oil Seal	455956H		
1	Wear Sleeve	FP-8923655		Rear; Use w/FP-8923654
QTY	MAIN BEARINGS	PART NO.	SIZE	DESCRIPTION
1	Main Set	FP-5099M	STD	
1	Main Set	FP-5099M25MM	.25MM	
1	Main Set	FP-5099M50MM	.50MM	
4	Plain Main Brg.	FP-8921712	STD	Position 1-2-3-5
4	Plain Main Brg.	FP-8924704	.25MM	Position 1-2-3-5
1	Flanged Main Brg.	FP-8922948	STD	Position 4
1	Flanged Main Brg.	FP-8924705	.25MM	Position 4
10	Bolt	FP-8922200		Main bearing cap; M12 x 1.75 x 70.0MM
QTY	OIL PUMP	PART NO.	SIZE	DESCRIPTION
1	Bushing	FP-8922093		Oil pump; Unfinished
3	Bolt	FP-11504822		Oil filter adapter; M8 x 1.25 x 30MM
2	O-Ring	FP-8920849		Oil filter adapter; .487" ID x .6875" OD
1	Oil Pump Intake Gasket	FP-5126473		Oil pick up tube
4	Rect. or Square Seal	FP-8920180		Oil filter adapter; 18.82MM ID x 3.175MM Thick
1	Oil Pump Drive Bushing	FP-8927784		Oil pump; Finished
1	Gasket	FP-5575086		Oil pressure regulator plug
4	Pipe Plug	FP-5115214		1/2" Square Head
1	Oil Pressure Regulator Valve	FP-8926365		
CYLINDER COMPONENTS				
QTY	LINERS	PART NO.	SIZE	DESCRIPTION
8	Repair Sleeve	FP-8924716		
QTY	PISTONS	PART NO.	SIZE	DESCRIPTION
8	Piston Body w/o Pin	FP-8921605	STD	18.8:1 C.R.; Grade A; White dot OE identification
8	Piston Body w/o Pin	FP-8922234	STD	18.8:1 C.R.; Grade B; Black dot OE identification
8	Piston Body w/o Pin	FP-8922236	STD	18.8:1 C.R.; Grade C; Yellow dot OE identification
8	Piston Body w/o Pin	FP-8928520	STD	18.8:1 C.R.; Grade D; No dot OE identification
8	Piston Body w/o Pin	FP-8922452	10	18.8:1 C.R.; Grade E
8	Piston Body w/o Pin	FP-8922453	20	18.8:1 C.R.; Grade E
8	Piston Body w/o Pin	FP-892160530	30	18.8:1 C.R.; Grade E
8	Piston Kit w/Pin & Retainers	FP-PK8922452	10	
8	Piston Kit w/Pin & Retainers	FP-PK8921605	STD	Also available as Sealed Power No. 2666PN
8	Piston Kit w/Pin & Retainers	FP-PK8922453	20	Also available as Sealed Power No. 2666PN 20
8	Piston Kit w/Pin & Retainers	FP-PK892160530	30	Also available as Sealed Power No. 2666PN 30
8	Pin	FP-8925717		
16	Piston Pin Retainer	FP-8922977		
8	Pin Bushing	FP-8920078		
QTY	CONNECTING RODS & BRGS.	PART NO.	SIZE	DESCRIPTION
16	Con. Rod Bolt	FP-8920087		7/16" - 20 x 2.58"
8	Rod Pair	FP-8921714	STD	
8	Rod Pair	FP-8924703	.25MM	
8	Rod Pair	FP-892171420	.50MM	

(continued on next page)

Multi-Purpose Engines 8.2, 8.2N Engs. (Fuel Pincher) 3
8.2L 500 OHV Diesel V8 (Fuel Pincher), 108mm Bore (cont.)

CYLINDER COMPONENTS (cont.)

CONNECTING RODS & BRGS. (cont.)				
QTY		PART NO.	SIZE	DESCRIPTION
8	Rod Pair	FP-892171430	.75MM	
PISTON RINGS				
QTY		PART NO.	SIZE	DESCRIPTION
8	Ring Set Single Cylinder	FP-8921721	STD	2-2.50MM, 1-4.50MM
8	Ring Set Single Cylinder	FP-8923779	5	2-2.50MM, 1-4.50MM
8	Ring Set Single Cylinder	FP-8923917	10	2-2.50MM, 1-4.50MM
8	Ring Set Single Cylinder	FP-8923919	20	2-2.50MM, 1-4.50MM
8	Ring Set Single Cylinder	FP-892172130	30	2-2.50MM, 1-4.50MM
1	Premium Set	FP-8921721S	STD	2-2.50MM, 1-4.50MM
1	Premium Set	FP-8921721S30	30	2-2.50MM, 1-4.50MM
8	Premium Single Cylinder Set	WE-499KC +	Std-30	2-2.50MM, 1-4.50MM; When depleted use FP-8921721
KITS				
QTY	OVERHAUL KIT	PART NO.	SIZE	DESCRIPTION
1	Piston and Ring Kit	PK1-2666		
1	Piston and Ring Kit w/Bearing	PK2-2666		
1	In-Frame Overhaul Kit	FP-82NA		Pistons & main brgs. not incl.
1	Complete Overhaul Kit	FP-82NAOH		Incl. cam brg. set

Multi-Purpose Engines 8.2T Eng. (Fuel Pincher) 4
8.2L 500 OHV Turbo-Diesel V8 (Fuel Pincher), 108mm Bore

CYL. HEAD & PARTS

GASKETS				
QTY		PART NO.	SIZE	DESCRIPTION
2	Valve Cover Gasket	FP-8920271		w/o Breather
2	Valve Cover Gasket	FP-8926675		w/Breather
2	Head Gasket	FP-8923848		
1	Head Set	FP-8924127		
1	Head Set	FP-892412710		Incl. .010" oversized cylinder head gskt.; Valve cover gskt. not incl.
1	Head Set	FP-8924127V		Incl. 11 hole valve cover gskts. for valve covers w/o breather
1	Head Set	FP-8924127VB		Incl. 9 hole valve cover gskts. for valve covers w/breather
1	Multiple Cyl. Head Gskt. Set	FP-8924127MV		Incl. 11 hole valve cover gskts. for valve covers w/o breather
1	Multiple Cyl. Head Gskt. Set	FP-8924127MVB		Incl. 9 hole valve cover gskts. for valve covers w/breather
1	Breather Seal Ring	FP-8921294		
HEAD BOLTS				
QTY		PART NO.	SIZE	DESCRIPTION
10	Head Bolt	FP-23500463		M15 x 2.0 x 128MM; 12 Point head
10	Head Bolt	FP-23500462		M15 x 2.0 x 158MM; 12 Point head
2	Head Bolt Set	FP-2602522		Replacement recommended; 15MM bolts only
2	Head Bolt Set	260-2522 +		Replacement recommended; 15MM bolts only; When depleted use FP-2602522
20	Washer	FP-8921876		To Ser. No. 8G138422; Exc. Marine applications
MISCELLANEOUS				
QTY		PART NO.	SIZE	DESCRIPTION
2	Hose Clamp	FP-5186840		Breather pipe; 13/16" - 1 1/2" Clamping Range
VALVE				
QTY		PART NO.	SIZE	DESCRIPTION
8	Intake	FP-8920119		
8	Exhaust	FP-8921347		
8	Exhaust Valve Kit	FP-23502067		Valve & valve keepers incl.
8	Intake Valve Kit	FP-23502068		Valve & valve keepers incl.
16	Valve Guide Cap	FP-5199914		Seal installer; Clear
32	Keeper	FP-23507238		1 groove; Square cut key groove
32	Keeper	VK-115		1 groove; Square cut key groove
32	Keeper	VK-115R		1 groove; Square cut key groove; Hardened
32	Keeper, Bulk	VK-115B		1 groove; Square cut key groove; Carton of 1000
VALVE GUIDE				
QTY		PART NO.	SIZE	DESCRIPTION
16	Guide	FP-VG5079T		Exh. & Int.; .3440" ID, 2.8750" O.A.L.
16	Guide	VG-5079T		Exh. & Int.; .3440" ID, 2.8750" O.A.L.
VALVE SPRING				
QTY		PART NO.	SIZE	DESCRIPTION
16	Spring	FP-8927857		Exh. & Int.; Also available as Sealed Power No. VS-1645
PUSH RODS				
QTY		PART NO.	SIZE	DESCRIPTION
8	Push Rod Spring	FP-8921253		
VALVE MISC.				
QTY		PART NO.	SIZE	DESCRIPTION
16	Rotocap	FP-8922369		Also available as Sealed Power No. RC-155
2	Oil Filler Cap	FP-5108474		Twist Type

(continued on next page)

4 Multi-Purpose Engines 8.2T Eng. (Fuel Pincher)				
(cont.) 8.2L 500 OHV Turbo-Diesel V8 (Fuel Pincher), 108mm Bore				
CYL. HEAD & PARTS (cont.)				
QTY	VALVE SEAL	PART NO.	SIZE	DESCRIPTION
16	Valve Stem Seal	FP-23500480		
QTY	ROCKER PARTS	PART NO.	SIZE	DESCRIPTION
8	Rocker Shaft	FP-8920478		Includes plug; Also available as Sealed Power No. RS-657
8	Expansion Plug	FP-5151272		Rocker shaft
8	Cam Follower Roller Set	FP-8923814		Injector; Incl. pin & roller
8	Cam Follower Roller Set	FP-8923813		Valve; Incl. pin & roller
ELECTRICAL				
QTY	ELECTRICAL	PART NO.	SIZE	DESCRIPTION
1	Starting Motor Gasket	FP-5130995		
INT & EXH MANIFOLDS				
QTY	INT. & EXH. MANIFOLDS	PART NO.	SIZE	DESCRIPTION
2	Exhaust Manifold Gasket	FP-8921817		
1	Cyl. Block Valley Cover Gskt.	FP-8920220		Front
1	Cyl. Block Valley Cover Gskt.	FP-8920246		Rear
2	Extruded Seal	FP-8920219		Side Valley Pan
2	Pipe Plug	FP-23511574		Exh. outlet adapter; 1/2" pipe thread; w/1" Square head
2	Pipe Plug	FP-8923847		Exh. outlet adapter; 1/4" x 18 NPTF; Square head
QTY	AIR INTAKE	PART NO.	SIZE	DESCRIPTION
2	Air Intake Housing Gasket	FP-8920247		
QTY	AIR CLEANER	PART NO.	SIZE	DESCRIPTION
1	Air Cleaner Adapter Screen	FP-8920732		Mounting adapter
1	Pipe Plug	FP-5142549		Mounting adapter; 3/4" - 14 Square Head
2	Air Cleaner Mtg. Adapter Gskt	FP-5127247		
CAMSHAFT GROUP				
QTY	TIMING COVER	PART NO.	SIZE	DESCRIPTION
1	Crankshaft Front Cover Gasket	FP-8920273		
1	Crankshaft Front Cover Gasket	FP-8923090		Cover to oil pan
FUEL SYSTEM & PARTS				
QTY	FUEL INJECTION	PART NO.	SIZE	DESCRIPTION
8	Fuel Injector Seal Ring	FP-8920390		
8	Injector Hole Tube Kit	FP-8925981A		
8	Injector Hole Tube Kit	FP-5149724		Injector tube seal ring incl.
8	Fuel Injector	FP-5229850		4A53
8	Fuel Injector Repair Kit	FP-5229930		
4	Bracket	FP-8920350		Control tube
8	Fuel Injection Valve Cage	FP-5229726		Spring cage
8	Fuel Injection Spring Seat	FP-5228766		Valve spring seat
8	Fuel Injector Valve Spring	FP-5228596		
8	Fuel Injector Check Valve	FP-5228694		
8	Injector Plunger & Bushing	FP-5229840		4A53 & 4B55; Assembly
8	Fuel Injector Tip Kit	FP-5229727		4A53
8	Fuel Injector Tip Kit	FP-5229846		4C65
8	Nut	FP-5229720		Fuel injector valve
8	Fuel Injector Valve Kit	FP-5228769		
QTY	FUEL FILTERS & PUMP	PART NO.	SIZE	DESCRIPTION
1	Mechanical Fuel Pump	FP-5199735		Left hand; High output; w/.375" Gear
1	Mechanical Fuel Pump	FP-5199560		Left hand; Std. output; w/.250" Gear
1	Mechanical Fuel Pump	FP-5199561		Right hand
1	Mechanical Fuel Pump	FP-5199734		Right hand; High output
1	Fuel Pump Valve Plug Gasket	FP-5161003		
1	Fuel Pump Shaft & Gear	FP-5181747		Driven; .838" Length; Std. Output
1	Fuel Pump Valve	FP-5174973		
1	Fuel Pump Coupling	FP-5154216		
1	Fuel Pump Gear	FP-5174975		.294" Width; Std. Output
1	Fuel Pump Drive Shaft	FP-5178700		Drive; 3.09" Length
1	Fuel Pump Relief Valve Spring	FP-5184530		
1	Fuel Pump Repair Part	FP-5174971		Fuel pump valve; .500" x 20 plug
1	Fuel Pump Drive Adapter Gskt.	FP-5150193		Fuel pump to block
1	Oil Seal	FP-23512243		Fuel pump
1	Fuel Pump Repair Kit	FP-5149599		w/High output fuel pump; High output; Short Shaft
1	Fuel Pump Repair Kit	FP-5195078		w/Std. fuel pump; Std. output
2	Pipe Plug	FP-5121182		Fuel filter cover; 1/4" - 18; Hex head
2	Pipe Plug	FP-8923847		Fuel filter cover; 1/4" x 18 NPTF; Square head
2	Pipe Plug	FP-8924380		Fuel pump drain; 1/8" - 27

(continued on next page)

Multi-Purpose Engines 8.2T Eng. (Fuel Pincher) 4
8.2L 500 OHV Turbo-Diesel V8 (Fuel Pincher), 108mm Bore (cont.)

FUEL SYSTEM & PARTS (cont.)

QTY	FUEL FILTERS & PUMP (cont.)	PART NO.	SIZE	DESCRIPTION
1	Plastic Cap	FP-5136240		Fuel pump drain; .250" Dia.
2	Plastic Cap	FP-5136241		Fuel pump drain; .780" Dia., 3/8" NPTF
1	Dowel Pin	FP-103709		Fuel pump valve spring; 5/32" x 1" straight
2	Dowel Pin	FP-141195		Fuel pump body; .250" x .625"
1	Ball Brg.	FP-147481		Drive gear; .125" Dia. Steel
1	Bushing	FP-5198558		Fuel pump cover; 3/8" x 1/4"
1	Bushing	FP-5198558		Fuel pump shaft; 3/8" x 1/4"

QTY	TURBOCHARGER	PART NO.	SIZE	DESCRIPTION
1	Hose	FP-5162888		Air inlet connection; 3.50" I.D. x 2.750" Length
2	Hose Clamp	FP-9139809		Air outlet hose; 2 1/16" - 3"
1	Turbo Ring	FP-5198936		Intermediate housing
2	Turbo Bushing	FP-5149540		Rotor shaft
1	O-Ring	FP-8920203		Air inlet elbow
1	Sealing Ring	FP-8923184		Mounting hole cover

GOVERNOR

QTY	GOVERNOR	PART NO.	SIZE	DESCRIPTION
1	Retaining Ring	FP-9411502		Governor weight shaft end brg.
1	Governor Spring	FP-5122165		Low speed; w/One Blue Stripe
1	Governor Spring	FP-5183704		Low speed; w/Two Yellow Stripes
1	Governor Low Speed Spring Cap	FP-5103975		
1	Screw	FP-5102270		Low speed spring adjusting; .250" - 28 x 1.00"
1	O-Ring	FP-5176557		Variable speed spring lever shaft packing; .477" ID x .113" Thick
2	Cylindrical Brg.	FP-148402		Variable speed spring lever shaft; .500" x .500" Dia.
4	Governor Valve Spring Shim	FP-5136590		Variable speed; .010"
2	Governor Valve Spring Shim	FP-5136591		Variable speed; .078"
1	Pin	FP-457008		Variable speed shaft pin; 3/16" x 1 1/2"
2	Governor Retainer	FP-5178581		Variable speed throttle shaft; Lower
2	Governor Retainer	FP-5144178		Variable speed throttle shaft; Upper
1	Ball Brg.	FP-9437108		Gov. Weight Riser Thrust Brg.; .354" Width
1	Ball Brg.	FP-23506244		Governor weight shaft end brg.
1	Ball Brg.	FP-9431894		Upper operating shaft
1	Governor Riser	FP-5117193		1.062" Length
1	Governor Spring Cover Gasket	FP-8922593		High speed
1	Nut	FP-5174286		Governor buffer screw; 3/8" - 24 UNF
1	Governor to Cyl. Block Gasket	FP-8920308		
1	Governor Gasket	FP-5180539		Variable speed cover; Copper material
1	Copper Washer	FP-5152148		Governor cover; 25/64" ID x 9/16" OD x 1/16" Thick; Copper
1	Copper Washer	FP-5152148		High speed spring adj. screw housing; 25/64" ID x 9/16" OD x 1/16" Thick; Copper
2	Washer	FP-5151487		Variable speed throttle shaft; 3/8" x 11/16" x .033"
1	Governor Seal Ring	FP-5101691		Variable speed throttle shaft; .362" x .113"
1	Solenoid Mounting Gasket	FP-8921033		Air shutoff mounting
1	Solenoid Plunger Assy. Gasket	FP-8927033		Air shutoff between plunger & solenoid
1	Governor Hole Gasket	FP-8920399		Control tube to cylinder head
1	Governor Cover Gasket	FP-8920290		Limiting speed
1	Retainer	FP-142583		Operating shaft lever pin; 13/64" Spring

COOLING SYSTEM

QTY	WATER PUMP	PART NO.	SIZE	DESCRIPTION
1	Water Pump - Heavy Duty	FP-8928672		Fresh water pump assy.; Thermostat housing not incl.
1	Water Pump Impeller	FP-8927727		Use w/Fresh water pump
1	Water Pump Impeller	FP-5193602		Use w/Raw water pump; Synthetic
1	Water Pump Repair/Rebuild Kit	FP-8928670		Fresh water pump; Incl. bearing, seal, impeller & hub
1	Water Pump Repair/Rebuild Kit	FP-8928671		Fresh water pump; Incl. bearing, seal, impeller, cover & seal ring
1	Water Pump Cover	FP-8923151		Fresh water pump
1	Water Pump Mech. Shaft Seal	FP-8927408		Fresh water pump
2	Fresh Water Outlet Elbow Gskt	FP-8920161		Right & left bank
1	Fresh Water Outlet Elbow Gskt	FP-8920083		Right bank
1	Fresh Water Pump Gasket	FP-8922132		Pump to front cover
1	Rect. or Square Seal	FP-8923152		Fresh water pump cover
1	Pipe Plug	FP-5115214		Water pump housing; 1/2" Square Head
2	Pipe Plug	FP-5142549		Water pump housing; 3/4" - 14 Square Head
1	Shaft & Bearing Assembly	FP-8920144		Fresh water pump
1	Water Pump Hub	FP-8922299		Driven hub

QTY	THERMOSTAT	PART NO.	SIZE	DESCRIPTION
2	Thermostat	FP-3046745		
1	Thermostat Gasket	FP-8924813		For dual thermostat applications

(continued on next page)

4 Multi-Purpose Engines 8.2T Eng. (Fuel Pincher) (cont.) 8.2L 500 OHV Turbo-Diesel V8 (Fuel Pincher), 108mm Bore

ENGINE BLOCK & PARTS				
QTY	GASKETS	PART NO.	SIZE	DESCRIPTION
1	Flywheel Housing Gasket	FP-8920091		
1	Oil Pan Gasket Kit	FP-5149728		
1	Washer	FP-5177773		Oil filter bypass plug; 18MM x 1.5MM
1	Washer	FP-8922349		Oil drain plug
QTY	GASKET SETS	PART NO.	SIZE	DESCRIPTION
1	In-Frame Gasket Set	FP-PGE4127IF		In Frm.; Head gsks. will accomodate 15mm head bolts; Incl. four-piece oil pan gskt.; Premium valve stem seals incl.
1	In-Frame Gasket Set	FP-PGE4127IF10		In Frm.; Head gsks. will accomodate 15mm head bolts; Incl. four-piece oil pan gskt.; Premium valve stem seals incl.; Incl. .010" oversized cylinder head gsks.
1	In-Frame Gasket Set	PGE4127-IF +		In Frm.; Head gsks. will accomodate 15mm head bolts; Incl. four-piece oil pan gskt.; Premium valve stem seals incl.; When depleted use FP-PGE4127IF
1	In-Frame Gasket Set	PGE4127-IF +		In Frm.; Head gsks. will accomodate 15mm head bolts; Incl. four-piece oil pan gskt.; Premium valve stem seals incl.; When depleted use FP-PGE4127IF
1	In-Frame Gasket Set	PGE4127-IF 10 +		Incl. .010" oversized cylinder head gsks.; When depleted use FP-PGE4127IF10
1	Complete Overhaul Gasket Set	FP-8924126		Crankshaft seals & valve cover gsks. not incl.
1	Complete Overhaul Gasket Set	FP-8924126		Crankshaft seals & valve cover gsks. not incl.
1	Complete Overhaul Gasket Set	FP-8924126CB		Crankshaft seals not incl.; Incl. front seal & 9 hole valve cover gskt. for valve covers w/breather
1	Complete Overhaul Gasket Set	FP-PGE4126		Head gsks. not incl.
1	Complete Overhaul Gasket Set	PGE4126 +		Head gsks. not incl.; When depleted use FP-PGE4126
1	Complete Overhaul Gasket Set	FP-892412610		Incl. .010" oversized cylinder head gskt.; Crankshaft seals & valve cover gsks. not incl.
1	Complete Overhaul Gasket Set	FP-8924126C10		Incl. .010" oversized cylinder head gskt.; Rear crankshaft seals not incl.; Incl. front seal & 11 hole valve cover gsks. for valve covers w/o breather
1	Complete Overhaul Gasket Set	FP-PGE4126C10		Incl. .010" oversized cylinder head gsks., crankshaft seals, & valve cover gsks. for valve covers w/o breathers
1	Complete Overhaul Gasket Set	PGE4126C 10 +		Incl. .010" oversized cylinder head gsks., crankshaft seals, & valve cover gsks. for valve covers w/o breathers; When depleted use FP-PGE4126C10
1	Complete Overhaul Gasket Set	FP-8924126WS		Incl. bi-directional crank seals
1	Complete Overhaul Gasket Set	FP-8924126C		Rear crankshaft seals not incl.; Incl. front seal & 11 hole valve cover gskt. for valve covers w/o breather
QTY	CAM BEARINGS	PART NO.	SIZE	DESCRIPTION
1	Cam Set	FP-8922110	STD	
QTY	OIL COOLERS & FILTERS	PART NO.	SIZE	DESCRIPTION
1	Oil Cooler	FP-8547194		4 plate
1	O-Ring	FP-8920849		Adapter to block; .487" ID x .6875" OD
1	Rect. or Square Seal	FP-8920180		Adapter to block; 18.82MM ID x 3.175MM Thick
1	Copper Washer	FP-5152148		Adapter; 25/64" ID x 9/16" OD x 1/16" Thick; Copper
QTY	FREEZE PLUGS	PART NO.	SIZE	DESCRIPTION
2	Pipe Plug	FP-5115214		1/2" Square Head
1	Pipe Plug	FP-8924380		1/8" - 27
QTY	DIPSTICK	PART NO.	SIZE	DESCRIPTION
1	Dipstick	FP-8920462		478.0MM to top of cap
CRANKSHAFT/OIL PUMP				
QTY	SEALS - FRONT CRANK	PART NO.	SIZE	DESCRIPTION
1	Oil Seal	FP-8920200		Single lip; Also available as National No. 473476
1	Redi-Sleeve	99250		
1	Oil Seal	473476		
QTY	SEALS - REAR CRANK	PART NO.	SIZE	DESCRIPTION
1	Oil Seal	FP-8926761		Std.; Single lip; R.H. Rotation
1	Oil Seal	FP-8923654		Use w/FP-8923655; O.S.; Single lip; R.H. Rotation
1	Oil Seal	455956H		
1	Wear Sleeve	FP-8923655		Rear; Use w/FP-8923654
QTY	MAIN BEARINGS	PART NO.	SIZE	DESCRIPTION
1	Main Set	FP-5099M	STD	
1	Main Set	FP-5099M25MM	.25MM	
1	Main Set	FP-5099M50MM	.50MM	
4	Plain Main Brg.	FP-8921712	STD	Position 1-2-3-5
4	Plain Main Brg.	FP-8924704	.25MM	Position 1-2-3-5
1	Flanged Main Brg.	FP-8922948	STD	Position 4
1	Flanged Main Brg.	FP-8924705	.25MM	Position 4

(continued on next page)

Multi-Purpose Engines 8.2T Eng. (Fuel Pincher) 4
 8.2L 500 OHV Turbo-Diesel V8 (Fuel Pincher), 108mm Bore (cont.)

CRANKSHAFT/OIL PUMP (cont.)

QTY	MAIN BEARINGS (cont.)	PART NO.	SIZE	DESCRIPTION
10	Bolt	FP-8922200		Main bearing cap; M12 x 1.75 x 70.0MM
QTY	OIL PUMP	PART NO.	SIZE	DESCRIPTION
1	Bushing	FP-8922093		Oil pump; Unfinished
3	Bolt	FP-11504822		Oil filter adapter; M8 x 1.25 x 30MM
2	O-Ring	FP-8920849		Oil filter adapter; .487" ID x .6875" OD
1	Oil Pump Intake Gasket	FP-5126473		Oil pick up tube
4	Rect. or Square Seal	FP-8920180		Oil filter adapter; 18.82MM ID x 3.175MM Thick
1	Oil Pump Drive Bushing	FP-8927784		Oil pump; Finished
1	Gasket	FP-5575086		Oil pressure regulator plug
4	Pipe Plug	FP-5115214		Oil filter adapter; 1/2" Square Head
1	Oil Pressure Regulator Valve	FP-8926365		
1	Oil Pressure Relieve Plug	FP-8926364		

CYLINDER COMPONENTS

QTY	LINERS	PART NO.	SIZE	DESCRIPTION
8	Repair Sleeve	FP-8924716		
QTY	PISTONS	PART NO.	SIZE	DESCRIPTION
8	Piston Body w/o Pin	FP-8925818	STD	17.4:1 C.R.; Grade A; White dot OE identification
8	Piston Body w/o Pin	FP-8925819	STD	17.4:1 C.R.; Grade B; Black dot OE identification
8	Piston Body w/o Pin	FP-8925820	STD	17.4:1 C.R.; Grade C; Yellow dot OE identification
8	Piston Body w/o Pin	FP-8928521	STD	17.4:1 C.R.; Grade D; No dot OE identification
8	Piston Body w/o Pin	FP-8925816	10	17.4:1 C.R.; Grade E
8	Piston Body w/o Pin	FP-8925817	20	17.4:1 C.R.; Grade E
8	Piston Body w/o Pin	FP-892581830	30	17.4:1 C.R.; Grade E
8	Piston Kit w/Pin & Retainers	FP-PK8925818	STD	
8	Piston Kit w/Pin & Retainers	FP-PK8925816	10	
8	Piston Kit w/Pin & Retainers	FP-PK8925817	20	
8	Piston Kit w/Pin & Retainers	FP-PK892581830	30	
1	Piston Kit w/Ring Set	FP-PK12667		
1	Piston Kit w/Rings & Bearings	FP-PK22667		
8	Pin	FP-8925717		
16	Piston Pin Retainer	FP-8922977		
8	Pin Bushing	FP-8920078		

QTY	CONNECTING RODS & BRGS.	PART NO.	SIZE	DESCRIPTION
16	Con. Rod Bolt	FP-8920087		7/16" - 20 x 2.58"
8	Rod Pair	FP-8921714	STD	
8	Rod Pair	FP-8924703	.25MM	
8	Rod Pair	FP-892171420	.50MM	
8	Rod Pair	FP-892171430	.75MM	

QTY	PISTON RINGS	PART NO.	SIZE	DESCRIPTION
8	Ring Set Single Cylinder	FP-8923780	5	
8	Ring Set Single Cylinder	FP-8923918	10	
8	Ring Set Single Cylinder	FP-8923920	20	
8	Ring Set Single Cylinder	FP-8921722	STD	1-3.00MM, 1-2.50MM, 1-4.50MM
8	Ring Set Single Cylinder	FP-892172230	30	1-3.00MM, 1-2.50MM, 1-4.50MM
1	Premium Set	FP-8921722S30	30	1-3.00MM, 1-2.50MM, 1-4.50MM
1	Premium Set	FP-8921722S	STD	1-3.00MM, 1-2.50MM, 1-4.50MM; Also available as Sealed Power No. E-500KC
8	Premium Single Cylinder Set	WE-500KC Std-30		1-3.00MM, 1-2.50MM, 1-4.50MM

CLUTCH

QTY	CLUTCH	PART NO.	SIZE	DESCRIPTION
1	Ball Brg.	FP-23503709		

KITS

QTY	OVERHAUL KIT	PART NO.	SIZE	DESCRIPTION
1	Piston and Ring Kit	PK1-2667		
1	Piston and Ring Kit w/Bearing	PK2-2667		
1	Piston Kit w/Ring Set	FP-PK12667		
1	Piston Kit w/Rings & Bearings	FP-PK22667		
1	In-Frame Overhaul Kit	FP-82T		Pistons & main brgs. not incl.
1	Complete Overhaul Kit	FP-82TOH		Incl. cam brg. set

Identifying the Series 50

The Option Label, showing the option and model number, usually located on the left side of the valve cover, can identify the options and equipment for Series 50 engines. The engine serial number is stamped on the cylinder block below the manifolds. A typical engine serial number is 04R0000605.

A typical Model Number would be 6043GK32. This Model Number is broken down below to demonstrate the identification on the engine.

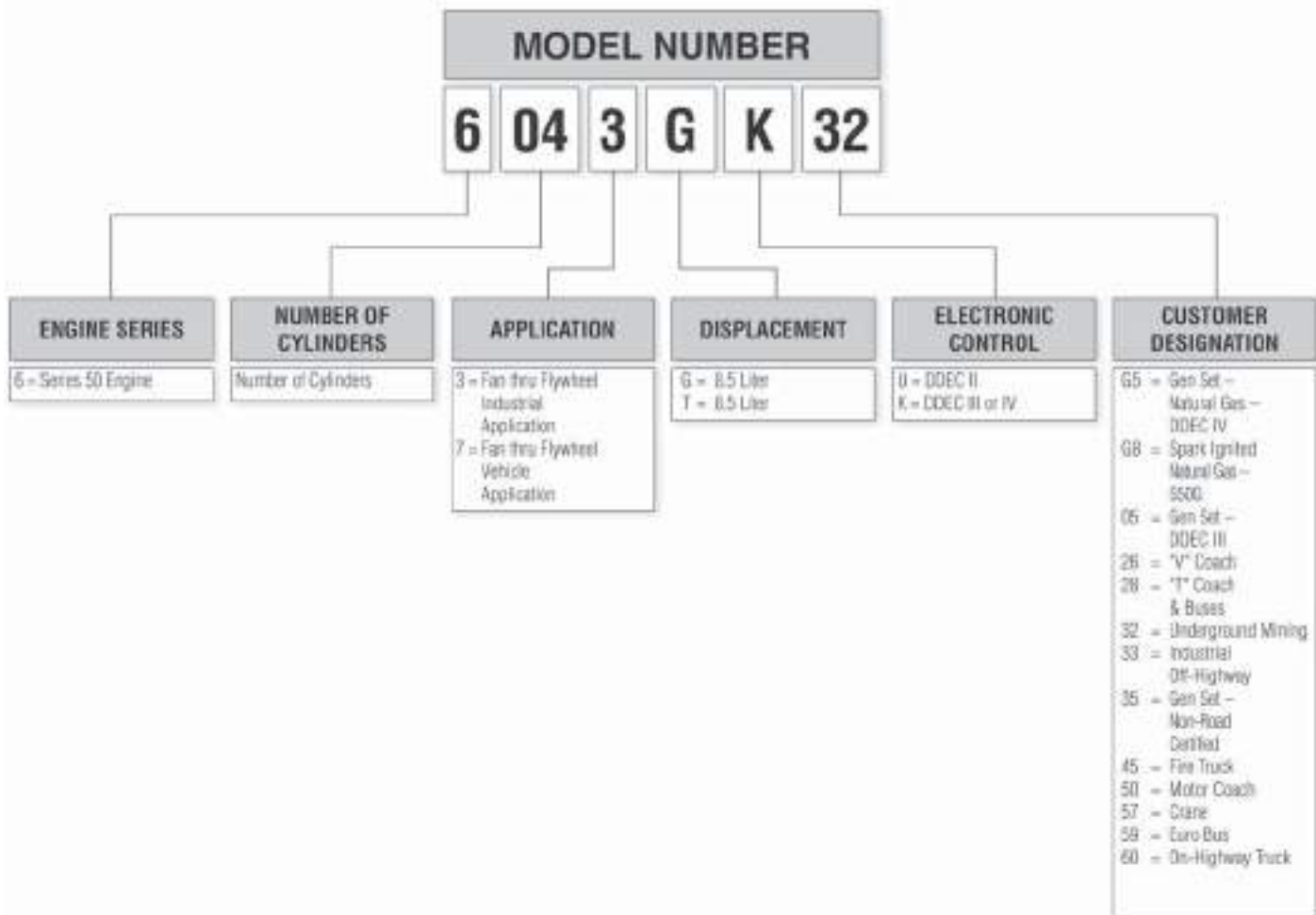

Series 50 In-Frame Overhaul - Crosshead Pistons

KIT NUMBER	COMPONENT NO.	QTY.	PART SIZE	PART DESCRIPTION	PART APPLICATION
FP-IFKS50TLC	FP-23532555	4		Cylinder Kit Complete	Engs. w/Top Liner Cooling (TLC); 2.50MM top ring; round piston design
	FP-23532556	4		Cylinder Kit Complete	Engs. w/Top Liner Cooling (TLC); 3.50MM top ring
	FP-23532557	4		Cylinder Kit Complete	Engs. w/Top Liner Cooling (TLC); 2.50MM top ring; oval piston design
	FP-23532558	4		Cylinder Kit Complete	Engs. w/Top Liner Cooling (TLC); 2.50MM top ring; Domed piston design
	FP-8929710	4	STD	Connecting Rod Bearing Pair	1.7100" or 43.430MM O.A.L.
	FP-8929711	4	.254MM	Connecting Rod Bearing Pair	1.7100" or 43.430MM O.A.L.
	FP-8929712	4	.508MM	Connecting Rod Bearing Pair	1.7100" or 43.430MM O.A.L.
	FP-8929713	4	.762MM	Connecting Rod Bearing Pair	1.7100" or 43.430MM O.A.L.
	FP-23515581	4	STD	Connecting Rod Bearing Pair	1.8670" or 47.430MM O.A.L.
	FP-23515582	4	.254MM	Connecting Rod Bearing Pair	1.8670" or 47.430MM O.A.L.
	FP-23515583	4	.508MM	Connecting Rod Bearing Pair	1.8670" or 47.430MM O.A.L.
	FP-23515584	4	.762MM	Connecting Rod Bearing Pair	1.8670" or 47.430MM O.A.L.
	FP-8929670A	4	STD	Main Bearing, Plain	
	FP-8929671A	4	.254MM	Main Bearing, Plain	
	FP-8929672A	4	.508MM	Main Bearing, Plain	
	FP-8929673A	4	.762MM	Main Bearing, Plain	
	FP-8929680	1	STD	Main Bearing, Flanged	
	FP-8929681	1	.254MM	Main Bearing, Flanged	
	FP-8929682	1	.508MM	Main Bearing, Flanged	
	FP-8929683	1	.762MM	Main Bearing, Flanged	
	FP-8929685	2	STD	Thrust Washer	
	FP-8929697	2	.127MM	Thrust Washer	
	FP-8929698	2	.254MM	Thrust Washer	
	FP-23532330	1		Head Gasket Set	
	FP-23511580	1		Oil Pan Gasket	

Series 50 In-Frame Overhaul - Articulated Pistons

KIT NUMBER	COMPONENT NO.	QTY.	PART SIZE	PART DESCRIPTION	PART APPLICATION
FP-IFK-S50SPREM	FP-23532554	4		Cylinder Kit Complete	Articulated piston design; 16.5:1 C.R.; Heavy pin; From Sept. 2002
	FP-23532561	4		Cylinder Kit Complete	Articulated piston design; 15.0:1 C.R.; Heavy pin; To Sept. 2002
	FP-23515581	4	STD	Connecting Rod Bearing Pair	1.8670" or 47.430MM O.A.L.
	FP-23515582	4	.254MM	Connecting Rod Bearing Pair	1.8670" or 47.430MM O.A.L.
	FP-23515583	4	.508MM	Connecting Rod Bearing Pair	1.8670" or 47.430MM O.A.L.
	FP-23515584	4	.762MM	Connecting Rod Bearing Pair	1.8670" or 47.430MM O.A.L.
	FP-23526142	4	STD	Connecting Rod Bearing Set	
	FP-8929670A	4	STD	Main Bearing, Plain	
	FP-8929671A	4	.254MM	Main Bearing, Plain	
	FP-8929672A	4	.508MM	Main Bearing, Plain	
	FP-8929673A	4	.762MM	Main Bearing, Plain	
	FP-8929680	1	STD	Main Bearing, Flanged	
	FP-8929681	1	.254MM	Main Bearing, Flanged	
	FP-8929682	1	.508MM	Main Bearing, Flanged	
	FP-8929683	1	.762MM	Main Bearing, Flanged	
	FP-8929085	2	STD	Thrust Washer	
	FP-8929697	2	.127MM	Thrust Washer	
	FP-8929698	2	.254MM	Thrust Washer	
	FP-8929690	5	STD	Camshaft Bearing	
	FP-23530768	26		Cylinder Head Bolt	
	FP-23532330	1		Head Gasket Set	
	FP-23511580	1		Oil Pan Gasket	

Multi-Purpose Engines Series 50 Eng. (8.5L) 5
8.5L 519 SOHC Turbo-Diesel L4 (16 Valve), 130mm Bore

CYL. HEAD & PARTS				
QTY	GASKETS	PART NO.	SIZE	DESCRIPTION
1	Valve Cover Gasket	FP-23511772		Intermediate to upper rocker cover gskt. Lower rocker gasket not included
1	Head Gasket	FP-23531306		
1	Head Set	FP-23532330		
1	Breather Seal Ring	FP-5103646		
QTY	HEAD BOLTS	PART NO.	SIZE	DESCRIPTION
26	Head Bolt	FP-23530768		Incl. (26) FP-23530768, (26) FP-8929328 Cylinder head bolt Splash Rail; .53" x .94" x .12"
1	Head Bolt Set	FP-HBS001		
26	Washer	FP-8929328		
1	Washer	FP-5132715		
QTY	MISCELLANEOUS	PART NO.	SIZE	DESCRIPTION
1	Pipe Plug	FP-8923847		1/4" x 18 NPTF; Square head
1	Pipe Plug	FP-8926993		1/4" X 18; Recessed socket head
2	Pipe Plug	FP-8923313		Cylinder head; 3/4"
6	Bolt	FP-11504822		Rocker cover mntg.; M8 x 1.25 x 30MM
QTY	MANIFOLD STUDS	PART NO.	SIZE	DESCRIPTION
4	Exhaust Manifold Stud	FP-23507438		Manifold to Turbo; M10 x 1.5 x 44.0
4	Exhaust Manifold Stud	FP-8929425		Manifold to Turbo; M10 x 1.5 x 50.0
QTY	FREEZE PLUGS	PART NO.	SIZE	DESCRIPTION
1	Pipe Plug	FP-8923847		1/4" x 18 NPTF; Square head
1	Pipe Plug	FP-8926993		1/4" X 18; Recessed socket head
2	Pipe Plug	FP-8923313		Cylinder head; 3/4"
QTY	VALVE	PART NO.	SIZE	DESCRIPTION
8	Intake	FP-8929589 +		30 deg. seat; 1.7320" Head Dia., .3421" Stem Dia., 8.4980" O.A.L.; When depleted use FP-23529629 30 deg. seat; 30 Deg. seat Identification H; When depleted use FP-23524521 Use w/FP23533552 Valve Guide; 0.026" Valve Lash; 30 Deg. seat; Pyromet 31, Chrome plated stem; 1.5530" Head Dia., .3430" Stem Dia., 8.4710" O.A.L. 0.020" Valve Lash; EMS-247 Material; Chrome plated stem Identification H; Incl. FP-23524521 valve, valve seal, keeper & rotocap Incl. FP-23529629 valve, valve seal, keeper & rotocap
8	Intake	FP-23529629		
8	Exhaust	FP-23506350 +		
8	Exhaust	FP-23529596		
8	Exhaust	FP-23524521		
8	Exhaust Valve Kit	FP-23507504		
8	Intake Valve Kit	FP-23501576		
32	Keeper	FP-8929573		
QTY	VALVE SEAT	PART NO.	SIZE	DESCRIPTION
8	Exh.	FP-8929126		Std. Depth; 6.261MM - 6.363MM thick; 1.6285" OD, 1.3591" ID, .2485" Depth
8	Exh.	FP-8929630		U/S Depth; 5.499MM - 5.601MM thick; 1.6285" OD, 1.3591" ID, .2185" Depth
8	Exh.	FP-8929629		U/S Depth; 5.753MM - 5.855MM thick; 1.6285" OD, 1.3591" ID, .2285" Depth
8	Exh.	FP-8929628		U/S Depth; 6.007MM - 6.109MM thick; 1.6285" OD, 1.3591" ID, .2385" Depth
8	Int.	FP-8929127		Std. Depth; 7.155MM - 7.251MM thick; 1.8195" OD, 1.5710" ID, .2837" Depth
8	Int.	FP-8929627		U/S Depth; 6.393MM - 6.495MM thick; 1.8195" OD, 1.5710" ID, .2537" Depth
8	Int.	FP-8929626		U/S Depth; 6.647MM - 6.749MM thick; 1.8195" OD, 1.5710" ID, .2637" Depth
8	Int.	FP-8929625		U/S Depth; 6.901MM - 7.003MM thick; 1.8195" OD, 1.5710" ID, .2737" Depth
QTY	VALVE GUIDE	PART NO.	SIZE	DESCRIPTION
16	Guide	FP-23533552		Exh. & Int.; From Ser. No. 4R37493; Powdered Metal replacement
16	Guide	FP-23518571		Exh. & Int.; To Ser. No. 4R37493; 14.30MM - 14.32MM Dia.
16	Guide	FP-23518572		Exh. & Int.; To Ser. No. 4R37493; 14.43MM - 14.45MM Dia.
QTY	VALVE SPRING	PART NO.	SIZE	DESCRIPTION
16	Spring	FP-8929415		Exh. & Int.; Yellow stripe
QTY	VALVE MISC.	PART NO.	SIZE	DESCRIPTION
16	Rotocap	FP-8929105		Use w/Two piece rocker cover Int. valve adjusting 4"
8	Isolator, Rocker Cover Bolt	FP-23517911		
8	Adj. Screw	FP-23520818		
1	Crankcase Breather	FP-5101760		
QTY	VALVE SEAL	PART NO.	SIZE	DESCRIPTION
16	Valve Stem Seal	FP-23523930		

(continued on next page)

5 Multi-Purpose Engines Series 50 Eng. (8.5L) (cont.) 8.5L 519 SOHC Turbo-Diesel L4 (16 Valve), 130mm Bore

CYL. HEAD & PARTS (cont.)				
QTY		PART NO.	SIZE	DESCRIPTION
ROCKER PARTS				
20	Nut	FP-23514371		Arm adj. screw; 3/8" - 24 UNF
2	O-Ring	FP-23521111		Rocker shaft seal
IGNITION				
QTY	IGNITION	PART NO.	SIZE	DESCRIPTION
4	Bolt	FP-11504822		ECM mounting plate; M8 x 1.25 x 30MM
8	Isolator Bushing	FP-23502879		ECM mounting; DDECII
8	Isolator Bushing	FP-23512307		ECM mounting; DDECIII
2	Rect. or Square Seal	FP-23504641		Fuel fitting block
ELECTRICAL				
QTY	ELECTRICAL	PART NO.	SIZE	DESCRIPTION
5	Bolt	FP-11504822		Tach drive cover; M8 x 1.25 x 30MM
1	Gasket	FP-8929130		Tach drive cover
1	Starting Motor Gasket	FP-5130995		Starter motor
INT & EXH MANIFOLDS				
QTY	INT. & EXH. MANIFOLDS	PART NO.	SIZE	DESCRIPTION
8	Bolt	FP-8929357		Manifold to head; M10 x 1.5 x 1.20
2	Exhaust Manifold Gasket	FP-23511666		
2	Air Intake Gasket	FP-23517875		
1	Pipe Plug	FP-8923313		Intake manifold; 3/4"
1	Pipe Plug	FP-8924517		Intake manifold; 3/8" x 18 square head
QTY	AIR INTAKE	PART NO.	SIZE	DESCRIPTION
1	O-Ring	FP-5182977		Sensor seal
1	Hose Clamp	FP-5137618		Int. manifold elbow
CAMSHAFT GROUP				
QTY	TIMING	PART NO.	SIZE	DESCRIPTION
1	Dowel Pin	FP-8929022		Gear case; 16MM; Diamond shape
1	Dowel Pin	FP-8929015		Gear case housing; 16MM; Circular shaped
1	Bushing	FP-8929108		Cam gear
1	Pipe Plug	FP-8924517		Gear case cover; 3/8" x 18 square head
1	Pipe Plug	FP-8924380		Gear case housing; 1/8" - 27
1	Copper Washer	FP-5155596		Gear case housing; 5/16"; Special copper washer
1	Bolt	FP-8929357		Gear case cover; M10 x 1.5 x 1.20
1	Rect. or Square Seal	FP-5141452		Gear case cover
QTY	CAMSHAFT/LIFTER	PART NO.	SIZE	DESCRIPTION
2	Bolt	FP-11504822		Balance shaft thrust plate; M8 x 1.25 x 30MM
1	Sealing Ring	FP-23521935		Thrust plate; Cylinder head
1	O-Ring	FP-23528491		Thrust plate; Gear housing
1	Oil Seal	FP-8929740		Cap bearing seal; .134" x .074" x .480"
2	Oil Seal	FP-23522975		Front cap seal
1	Oil Seal	FP-23521894		Thrust plate; Cylinder head
BALANCE SHAFT				
QTY	BALANCE SHAFT	PART NO.	SIZE	DESCRIPTION
4	Bolt	FP-11504822		M8 x 1.25 x 30MM
1	Dowel Pin	FP-8929022		Bal. shaft support; 16MM; Diamond shape
2	O-Ring	FP-23505892		Oil pump inlet
ACCESSORY DRIVE				
QTY	ACCESSORY DRIVE	PART NO.	SIZE	DESCRIPTION
1	Lock Ring	FP-23509204		Accessory drive
1	Lock Ring	FP-23511746		Accessory gear
1	Lock Ring	FP-8929062		Air compressor
1	Lock Ring	FP-23505643		Power steering pump
1	Ball Brg.	FP-23518178		Accessory drive
1	Ball Brg.	FP-23509203		Accessory gear shaft
1	Ball Brg.	FP-907394		Driven pulley
1	Ball Brg.	FP-23503704		Fan shaft inner
1	Ball Brg.	FP-23503535		Fan shaft outer
1	Cylindrical Brg.	FP-23511745		Accessory drive
2	Snap Ring	FP-8929064		Accessory drive; 3.121" OD
1	Retaining Ring	FP-8929216		Accessory drive; 1.618" OD
1	Retaining Ring	FP-8929063		Accessory drive; 3.734" OD
5	Bolt	FP-11504822		Assy. mounting; M8 x 1.25 x 30MM
16	Bolt	FP-11504822		Front cover; M8 x 1.25 x 30MM

(continued on next page)

Multi-Purpose Engines Series 50 Eng. (8.5L) 5
8.5L 519 SOHC Turbo-Diesel L4 (16 Valve), 130mm Bore (cont.)

ACCESSORY DRIVE (cont.)

QTY	ACCESSORY DRIVE (cont.)	PART NO.	SIZE	DESCRIPTION
1	O-Ring	FP-8929253		Acc. drive cover; .139" x 4.609" ID
1	Gasket	FP-8929130		Upper right rear & cam access cover
1	Gasket	FP-8929299		Acc. drive front
1	Oil Seal	FP-8929154		Oil accessory drive; Also available as National No. 484156V
1	Lock Nut	FP-11509584		Pulley
2	Power Steering Pump Gasket	FP-23516100		Power steering pump cover

AIR COMPRESSOR

QTY	AIR COMPRESSOR	PART NO.	SIZE	DESCRIPTION
1	Ball Brg.	FP-8929820		
1	Drive Coupling	FP-5141773		Air compressor drive
2	Lock Washer	FP-103320		Booster tube; 5/16"
1	Gasket	FP-8929299		Drive housing
1	Air Compressor Strainer Gskt.	FP-5110410		Booster tube
1	Accessory Drive Gasket	FP-23515145		

FUEL SYSTEM & PARTS

QTY	FUEL INJECTION	PART NO.	SIZE	DESCRIPTION
4	Fuel Injector Seal Ring	FP-5104701		Injector hole tube; Viton
2	Fuel Injector Seal Ring	FP-5234699		Lower
1	Fuel Injector Seal Ring	FP-5234702		Upper
4	Injector Hole Tube Kit	FP-23501580		
4	Adj. Screw	FP-23520820		Injector adjusting
4	Bolt	FP-8929393		Injector clamp

QTY	FUEL FILTERS & PUMP	PART NO.	SIZE	DESCRIPTION
1	Fuel Pump Coupling	FP-23505249		For high capacity fuel pump
1	Fuel Pump Coupling	FP-8929479		For std. capacity fuel pump
1	Fuel Pump Coupling	FP-8929787		15.875MM ID
1	Fuel Pump Drive	FP-23511964		For std. capacity fuel pump
1	Fuel Pump Hub	FP-8929480		12.70MM ID
1	Fuel Pump Gear	FP-23506546		Drive gear; .375
1	Fuel Pump Gear	FP-23511959		Driven gear; .275
1	Fuel Pump Drive Shaft	FP-23506545		Drive shaft
1	Fuel Pump Drive Shaft	FP-23506549		Driven shaft
1	Fuel Pump Check Valve	FP-8923528		Injector check valve
1	Fuel Pump Spacer	FP-23506560		Relief Valve
1	Sealing Ring	FP-23506556		Relief valve
4	Cylindrical Brg.	FP-8923526		Fuel pump shaft
5	Bolt	FP-11504822		Fuel pump drive assy.; M8 x 1.25 x 30MM
1	Fuel Pump Repair Part	FP-23506564		Relief valve shear pin
1	Fuel Pump Body Plug	FP-23506553		
4	Snap Ring	FP-8923522		Fuel pump drive gear
1	O-Ring	FP-8929253		Fuel cover; .139" x 4.609" ID
1	O-Ring	FP-23524657		Fuel/water separator
1	Fuel Pump Drive Adapter Gskt.	FP-5150193		
1	Fuel Pump Gasket	FP-23505248		Fuel pump mounting
2	Oil Seal	FP-23512243		Fuel pump

QTY	BREATHER	PART NO.	SIZE	DESCRIPTION
3	Hose Clamp	FP-5186840		Breather; 13/16" - 1 1/2" Clamping Range
1	Bolt	FP-11504822		Breather tube; M8 x 1.25 x 30MM

QTY	TURBOCHARGER	PART NO.	SIZE	DESCRIPTION
1	Turbocharger Exhaust Gasket	FP-8929529		Inlet connection
1	Turbocharger Oil Return Gskt.	FP-8929285		
1	Turbo Inlet Connector Gasket	FP-23512254		Adapter to turbo

GOVERNOR

QTY	GOVERNOR	PART NO.	SIZE	DESCRIPTION
1	Retaining Ring	FP-9411502		Mechanical governor weight

COOLING SYSTEM

QTY	WATER PUMP	PART NO.	SIZE	DESCRIPTION
1	Water Pump - Heavy Duty	FP-23526039		Hi-Flow w/heat sink rotor
1	Water Pump Shaft	FP-8929157		Front mounted pumps
1	Water Pump Shaft	FP-23505896		Gear case mounted pumps
1	Water Pump Impeller	FP-8929512		Use w/Front mounted pumps
1	Water Pump Impeller	FP-23517973		Use w/Gear case mounted pumps
1	Water Pump Repair/Rebuild Kit	FP-23509105		Incl. FP23505024 and FP23512048 plate seals.
1	Water Pump Cover	FP-8922383		Non-metallic; Non-Metallic

(continued on next page)

5 Multi-Purpose Engines Series 50 Eng. (8.5L) (cont.) 8.5L 519 SOHC Turbo-Diesel L4 (16 Valve), 130mm Bore

COOLING SYSTEM (cont.)				
QTY	DESCRIPTION	PART NO.	SIZE	DESCRIPTION
WATER PUMP (cont.)				
1	Water Pump Retainer Ring	FP-8929427		Bearing & seal
1	Water Pump Retainer Ring	FP-8922407		FWP cover
1	Ball Brg.	FP-8929422		Water pump shaft
1	Water Pump Gasket	FP-5178273		Pump body cover
1	Water Pump Seal Ring	FP-23520377		Water pump; Gear case mounted pumps
1	Oil Seal	FP-8929213		Fan spindle
1	Oil Seal	FP-8929134		Water pump; Lip type; Also available as National No. 4458V
1	O-Ring	FP-23512048		Water pump cover; Gear case mounted pumps; 4.77" OD
4	Bolt	FP-8921930		Water pump inlet cover; 1/4" - 20 x 3/4"
5	Bolt	FP-11504822		Fan mount support; M8 x 1.25 x 30MM
1	Retaining Ring	FP-8929216		Fan drive; 1.618" OD
1	Retaining Ring	FP-8929063		Fan drive; 3.734" OD
HOSES				
2	Silicone Hose	FP-8929875		Water bypass tube; 1.750" ID x 3.250" Length
THERMOSTAT				
1	Thermostat	FP-23503827		Type 481; 160 Deg.
1	Thermostat	FP-8929878		Types 358, 439, 448, 488, 507, 511, 518, 520; 190 Deg.
1	Thermostat	FP-23503825		Types 497, 516; 180 Deg.
1	Thermostat Kit	FP-23532436		Thermostat & seal incl.
2	Oil Seal	FP-5132155		
1	Plastic Cap	FP-5136240		Thermostat housing; .250" Dia.
ENGINE BLOCK & PARTS				
GASKETS				
1	Oil Pan Gasket	FP-23511580		
10	Oil Pan Isolator Bushing	FP-23517242		
8	Bolt	FP-11504571		Oil pan
1	Copper Washer	FP-23513842		Oil gauge adapter
1	Oil Seal	FP-8929740		Block to gear case; .134" x .074" x .480"
DOWEL PINS				
1	Dowel Pin	FP-8929015		16MM; Circular shaped
2	Dowel Pin	FP-8929022		16MM; Diamond shape
1	Dowel Pin	FP-8929152		20MM; Circular shape
CAM BEARINGS				
5	Cam Brg.	FP-8929690	STD	
5	Cam Brg.	FP-8929691	.254MM	
5	Cam Brg.	FP-8929692	.508MM	
5	Cam Brg.	FP-8929693	.762MM	
OIL COOLERS & FILTERS				
1	Oil Cooler Gasket Kit	FP-23537789		Incl. both New and Old design housing-to-core gaskets
1	O-Ring	FP-8929289		Oil cooler housing
1	Rect. or Square Seal	FP-23505902		Adapter to housing
2	Oil Cooler Seal Ring	FP-23508392		Filter adapter housing
1	Gasket	FP-23506247		Core housing
1	Pipe Plug	FP-8923847		Oil cooler adapter; 1/4" x 18 NPTF; Square head
5	Pipe Plug	FP-8923313		Oil cooler adapter; 3/4"
2	Pipe Plug	FP-23511574		Oil cooler housing; 1/2" pipe thread; w/1" Square head
FREEZE PLUGS				
3	Pipe Plug	FP-8924517		3/8" x 18 square head
DIPSTICK				
1	Dipstick Guide	FP-5151430		1.50" Length
MISCELLANEOUS				
1	Chain, Oil Filler Cap	FP-5121989		6.5" Length
1	Oil Filler Cap	FP-5117362		2.00" Dia.; Thermos Bottle Style
CRANKSHAFT/OIL PUMP				
CRANKSHAFT				
1	Vibration Damper	FP-23525990		13.5" Dia., One-piece
SEALS - FRONT CRANK				
1	Oil Seal Kit	FP-23518355		
SEALS - REAR CRANK				
1	Oil Seal Kit	FP-23513578		Double lip wrap around
1	Oil Seal Kit	FP-23516969		PTFE lip; Also available as National No. 5424
6	Washer	FP-5133981		Vibration damper; .122" Thick

(continued on next page)

Multi-Purpose Engines Series 50 Eng. (8.5L) 5
8.5L 519 SOHC Turbo-Diesel L4 (16 Valve), 130mm Bore (cont.)

CRANKSHAFT/OIL PUMP (cont.)

QTY	MAIN BEARINGS	PART NO.	SIZE	DESCRIPTION
5	Plain Main Brg.	FP-8929670A	STD	
5	Plain Main Brg.	FP-8929671A	.254MM	
5	Plain Main Brg.	FP-8929672A	.508MM	
5	Plain Main Brg.	FP-8929673A	.762MM	
1	Flanged Main Brg.	FP-8929680	STD	
1	Flanged Main Brg.	FP-8929681	.254MM	
1	Flanged Main Brg.	FP-8929682	.508MM	
1	Flanged Main Brg.	FP-8929683	.762MM	
1	Thrust Washer Set	FP-8929085S	STD	Position Upper
2	Thrust Washer	FP-8929085	STD	Position Upper
2	Thrust Washer	FP-8929697	.127MM	Position Upper; .127MM oversize
2	Thrust Washer	FP-8929698	.254MM	Position Upper; .254MM oversize

QTY	OIL PUMP	PART NO.	SIZE	DESCRIPTION
1	Lo Pressure Regulator Valve	FP-8922740		
1	Bushing	FP-5127978		Oil pump
1	Bushing	FP-23511370		Oil pump; 25MM Bore, 22.27MM Shaft, 26MM Length
1	Oil Pump Spring	FP-5126327		Outlet bypass valve; .790" Dia., 2.96" Length
2	Bolt	FP-11504822		Inlet tube; M8 x 1.25 x 30MM
4	Bolt	FP-11504822		Outlet pipe; M8 x 1.25 x 30MM
2	Bolt	FP-11504822		Pressure regulator; M8 x 1.25 x 30MM
2	Bolt	FP-11504822		Pressure relief vlv.; M8 x 1.25 x 30MM
1	Bolt	FP-11504822		Screen bracket; M8 x 1.25 x 30MM
2	O-Ring	FP-23505892		Inlet pump inlet
1	Oil Pump Intake Gasket	FP-8929344		Pump to block
1	Oil Pump Outlet Gasket	FP-8929347		
1	Rect. or Square Seal	FP-8929341		Oil filter
1	Rect. or Square Seal	FP-8929340		Oil filter bypass
1	Oil Inlet Elbow Gasket	FP-23505992		Inlet tube to pump
1	Lo Press. Reg. Body Gasket	FP-5117269		
1	Gasket	FP-8929302		Fill tube adapter
1	Pipe Plug	FP-23511574		Oil drain; 1/2" pipe thread; w/1" Square head
2	Pipe Plug	FP-8923313		Oil drain; 3/4"
2	Pipe Plug	FP-8923847		Oil pan plug; 1/4" x 18 NPTF; Square head
1	Oil Suction Tube Gasket	FP-23511656		Inlet tube to pump
2	Hose Clamp	FP-23505048		Oil filler tube

CYLINDER COMPONENTS

QTY	LINERS	PART NO.	SIZE	DESCRIPTION
4	Liner w/Sealing Rings	FP-23531249		FP-23534264 liner incl.
4	Cylinder Kit Complete	FP-23532561	STD	Articulated piston design; 15.0:1 C.R.; Heavy pin; To Sept. 2002
4	Cylinder Kit Complete	FP-23532554	STD	Articulated piston design; 16.5:1 C.R.; Heavy pin; From Sept. 2002
4	Cylinder Kit Complete	FP-23532558	STD	Engs. w/Top Liner Cooling (TLC); 2.50MM top ring; Domed piston design
4	Cylinder Kit Complete	FP-23532557	STD	Engs. w/Top Liner Cooling (TLC); 2.50MM top ring; Oval piston design
4	Cylinder Kit Complete	FP-23532555	STD	Engs. w/Top Liner Cooling (TLC); 2.50MM top ring; Round piston design
4	Cylinder Kit Complete	FP-23532556	STD	Engs. w/Top Liner Cooling (TLC); 3.50MM top ring
4	Sealing Ring, Liner	FP-8929013		Crevise seal
8	Sealing Ring, Liner	FP-8929176		D-ring seal
4	Flange Shim	FP-20044	31	.031" Thick
4	Flange Shim	FP-20045	62	.062" Thick
4	Cntr. Bore Insert	FP-23525500		
4	Lower Block Bore Sleeve	FP-20042		

QTY	PISTONS	PART NO.	SIZE	DESCRIPTION
4	Piston Kit w/Pin & Retainers	FP-23519646	STD	Engs. w/Top Liner Cooling (TLC) & 2.50MM top ring; Oval piston design
4	Piston Kit w/Pin & Retainers	FP-23519624	STD	Engs. w/Top Liner Cooling (TLC) & 2.50MM top ring; Round piston design
4	Piston Kit w/Pin & Retainers	FP-23524601	STD	Engs. w/2.50MM top ring
4	Piston Kit w/Pin & Retainers	FP-23519635	STD	Engs. w/3.50MM top ring
4	Piston Skirt	FP-23521802		Aluminum skirt for forged steel crown articulated piston
4	Piston Skirt	FP-23516681		Ductile iron for standard cross head piston
4	Pin	FP-8929087		
4	Pin	FP-23525168		Hollow pin w/0.866" (22MM) I.D.; Articulated piston; Heavy pin
8	Piston Pin Retainer	FP-23521781		Use w/Articulated pistons
8	Piston Pin Bolt	FP-8929337		
8	Piston Pin Bolt Spacer	FP-8929504		

(continued on next page)

5 Multi-Purpose Engines Series 50 Eng. (8.5L) (cont.) 8.5L 519 SOHC Turbo-Diesel L4 (16 Valve), 130mm Bore

CYLINDER COMPONENTS (cont.)						
QTY	PISTONS (cont.)	PART NO.	SIZE	DESCRIPTION		
4	Piston Cooling Nozzle	FP-23528493		Use w/Articulated pistons		
4	Bolt	FP-23506222		Use w/Articulated pistons; M8 - 1.25" x 20, 12 point		
4	Pin Bushing	FP-4774Y				
QTY	CONNECTING RODS & BRGS.	PART NO.	SIZE	DESCRIPTION		
8	Con. Rod Bolt	FP-8929355		M14 x 1.5" x 108		
8	Con. Rod Nut	FP-8929019		M14 x 1.5		
4	Rod Pair	FP-23526142	STD	Engs. w/Articulated pistons; Drilled upper & lower		
4	Rod Pair	FP-23527065 *	.254MM	Engs. w/Articulated pistons; Drilled upper & lower		
4	Rod Pair	FP-23527066 *	.508MM	Engs. w/Articulated pistons; Drilled upper & lower		
4	Rod Pair	FP-23527067 *	.762MM	Engs. w/Articulated pistons; Drilled upper & lower		
4	Rod Pair	FP-8929710	STD	O.A.L. 1.7100" or 43.430MM		
4	Rod Pair	FP-8929711	.254MM	O.A.L. 1.7100" or 43.430MM		
4	Rod Pair	FP-8929712	.508MM	O.A.L. 1.7100" or 43.430MM		
4	Rod Pair	FP-8929713	.762MM	O.A.L. 1.7100" or 43.430MM		
4	Rod Pair	FP-23515581	STD	O.A.L. 1.8670" or 47.430MM		
4	Rod Pair	FP-23515582	.254MM	O.A.L. 1.8670" or 47.430MM		
4	Rod Pair	FP-23515583	.508MM	O.A.L. 1.8670" or 47.430MM		
4	Rod Pair	FP-23515584	.762MM	O.A.L. 1.8670" or 47.430MM		
QTY	PISTON RINGS	PART NO.	SIZE	DESCRIPTION		
4	Ring Set Single Cylinder	FP-23503747		2.50MM top ring; Cross Head & Articulated pistons		
4	Ring Set Single Cylinder	FP-23505729		3.50MM top ring; Cross Head pistons only		
4	Compression Ring	FP-8929845		Intermediate		
4	Compression Ring	FP-8929844		Top; 2.50MM		
4	Compression Ring	FP-23504941		Top; 3.50MM		
4	Oil Ring	FP-23515500				
4	Oil Ring Expander	FP-23529379				
KITS						
RE-RING KIT YEARS	DESCRIPTION		QTY	PREMIUM KIT NO.	QTY	ECONOMY KIT NO.
	In-Frame Kit	Re-ring w/Mains	1	FP-S60IFKRR		----
	Overhaul Kit	Re-ring w/Mains	1	FP-S60OHRR		----
QTY	OVERHAUL KIT	PART NO.	SIZE	DESCRIPTION		
1	In-Frame Overhaul Kit	FP-IFKS50SPREM		Use w/Articulated pistons		
1	In-Frame Overhaul Kit	FP-IFKS50TLC		Use w/Cross Head pistons		

6 Multi-Purpose Engines Series 40 Eng. (8.7L) 8.7L 530 OHV Turbo-Diesel L6 (12 Valve), 4.587" Bore (International Eng.)

CYL. HEAD & PARTS				
QTY	GASKETS	PART NO.	SIZE	DESCRIPTION
1	Valve Cover Gasket	FP-1817510		
1	Head Gasket	FP-1817562		
QTY	VALVE	PART NO.	SIZE	DESCRIPTION
6	Intake	FP-1818580		I530 & I530P (NGD) Engs.
6	Exhaust	FP-1824838		I530 & I530P (NGD) Engs.; 5/16" valve stem
24	Keeper	FP-1810944		I530 & I530P (NGD) Engs.
QTY	VALVE SEAT	PART NO.	SIZE	DESCRIPTION
6	Exh.	FP-675450	STD	I.D. Top taper 1.524"; 1.6285" OD, 1.3480" ID, .3650" Depth
6	Int.	FP-675043	STD	I.D. Top taper 1.767"; 1.9990" OD, 1.7120" ID, .3860" Depth
QTY	VALVE GUIDE	PART NO.	SIZE	DESCRIPTION
12	Guide	FP-1820264		I530 & I530P (NGD) Engs.; .315" ID, .565" OD, 2.391" O.A.L.
QTY	VALVE SPRING	PART NO.	SIZE	DESCRIPTION
6	Spring	FP-677349		Int.
QTY	VALVE MISC.	PART NO.	SIZE	DESCRIPTION
6	Rotocap	FP-1824680		Exh.; I530E Engs.; Valve stem seal incl.
12	Valve Rotator Seal	FP-1824683		Exh. & Int.; I530E Engs.
CAMSHAFT GROUP				
QTY	CAMSHAFT TIMING	PART NO.	SIZE	DESCRIPTION
1	Woodruff Key	FP-218211		Cam gear; 1/4" x 3/4"
FUEL SYSTEM & PARTS				
QTY	FUEL INJECTION	PART NO.	SIZE	DESCRIPTION
6	Injector Nozzle Seat Gasket	FP-675477		.060" thick

(continued on next page)

Multi-Purpose Engines Series 40 Eng. (8.7L) 6
8.7L 530 OHV Turbo-Diesel L6 (12 Valve), 4.587" Bore (International Eng.) (cont.)

FUEL SYSTEM & PARTS (cont.)				
QTY	FUEL INJECTION (cont.)	PART NO.	SIZE	DESCRIPTION
6	Grommet	FP-682810		Injector dust cover
6	Fuel Injector Sleeve	FP-675442		
QTY	TURBOCHARGER	PART NO.	SIZE	DESCRIPTION
1	Turbocharger Oil Inlet Gasket	FP-253660		
1	Turbocharger Mounting Gasket	FP-1822120		
COOLING SYSTEM				
QTY	WATER PUMP	PART NO.	SIZE	DESCRIPTION
1	Water Pump - Heavy Duty	FP-1817687		
ENGINE BLOCK & PARTS				
QTY	GASKETS	PART NO.	SIZE	DESCRIPTION
1	Chemicals	FP-1816593		Oil Pan; RTV Sealant
1	Oil Seal Kit	FP-690437		Oil pump; Incl. seal & wear sleeve
QTY	CAM BEARINGS	PART NO.	SIZE	DESCRIPTION
1	Cam Set	FP-680117	STD	Also available as Sealed Power No. 1470M
CRANKSHAFT/OIL PUMP				
QTY	SEALS - FRONT CRANK	PART NO.	SIZE	DESCRIPTION
1	Oil Seal Kit	FP-690437		Incl. seal & wear sleeve
QTY	SEALS - REAR CRANK	PART NO.	SIZE	DESCRIPTION
1	Oil Seal Kit	FP-1817867		
QTY	MAIN BEARINGS	PART NO.	SIZE	DESCRIPTION
6	Plain Main Brg.	FP-1822321	STD	Position 1-2-3-4-5-6
6	Plain Main Brg.	FP-1822490	10	Position 1-2-3-4-5-6
6	Plain Main Brg.	FP-1822491	20	Position 1-2-3-4-5-6
6	Plain Main Brg.	FP-1822492	30	Position 1-2-3-4-5-6
1	Flanged Main Brg.	FP-1822379	STD	Position 7
1	Flanged Main Brg.	FP-1822494	10	Position 7
1	Flanged Main Brg.	FP-1822495	20	Position 7
1	Flanged Main Brg.	FP-1822496	30	Position 7
CYLINDER COMPONENTS				
QTY	LINERS	PART NO.	SIZE	DESCRIPTION
6	Cyl. Liner Sealing Ring Kit	FP-1822322		
6	Sealing Ring, Liner	FP-1817633		
6	Sealing Ring, Liner	FP-1842115		PTFE
6	Sealing Ring, Liner	FP-1817000 +		When depleted use FP-1842115
QTY	PISTONS	PART NO.	SIZE	DESCRIPTION
6	Pin	FP-1818552		
12	Piston Pin Retainer	FP-1818702		
6	Pin Bushing	FP-1818598		
QTY	CONNECTING RODS & BRGS.	PART NO.	SIZE	DESCRIPTION
6	Rod Pair	FP-1822389	STD	
6	Rod Pair	FP-1822486	10	
6	Rod Pair	FP-1822487	20	
QTY	PISTON RINGS	PART NO.	SIZE	DESCRIPTION
6	Ring Set Single Cylinder	FP-1825461		

Identifying the Series 60

The Option Label, showing the option and model number, usually located on the left side of the valve cover, can identify the options and equipment for Series 60 engines. The engine serial number is stamped on the cylinder block below the manifolds. A typical engine serial number is 06R00000000.

A typical Model Number would be 6067WK32. This Model Number is broken down below to demonstrate the identification on the engine.

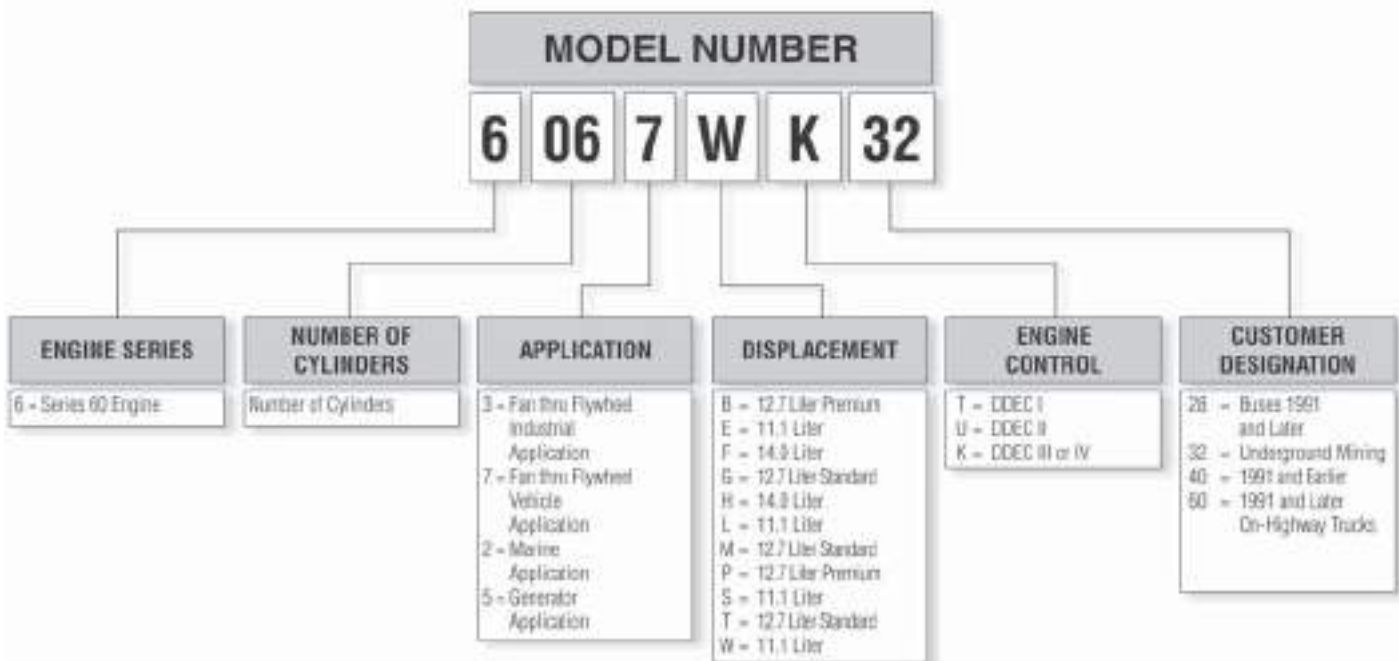

11.1L, 12.7L Series 60 In-Frame Overhaul

KIT NUMBER	COMPONENT NO.	QTY.	PART SIZE	PART DESCRIPTION	PART APPLICATION
FP-S60	FP-23519625*	6		Cylinder Kit Complete	Engs. w/Standard Liner; 2.50MM top ring; round piston design
	FP-23532590				
	FP-23519637*	6		Cylinder Kit Complete	Engs. w/Standard Liner; 3.50MM top ring
	FP-23532591				
	FP-23523951*	6		Cylinder Kit Complete	Engs. w/Top Liner Cooling (TLC); 2.50MM top ring; round piston design
	FP-23532555				
	FP-23523952*	6		Cylinder Kit Complete	Engs. w/Top Liner Cooling (TLC); 3.50MM top ring;
	FP-23532556				
	FP-23523954*	6		Cylinder Kit Complete	Engs. w/Top Liner Cooling (TLC); 2.50MM top ring; oval piston design
	FP-23532557				
	FP-8929710	6	Std.	Rod Bearing Pair	1.7100" or 43.430 O.A.L.
	FP-8929711	6	.254MM	Rod Bearing Pair	1.7100" or 43.430 O.A.L.
	FP-8929712	6	.508MM	Rod Bearing Pair	1.7100" or 43.430 O.A.L.
	FP-8929713	6	.762MM	Rod Bearing Pair	1.7100" or 43.430 O.A.L.
	FP-23515581	6	Std.	Rod Bearing Pair	1.8670" or 47.430MM O.A.L.
	FP-23515582	6	.254MM	Rod Bearing Pair	1.8670" or 47.430MM O.A.L.
	FP-23515583	6	.508MM	Rod Bearing Pair	1.8670" or 47.430MM O.A.L.
	FP-23515584	6	.762MM	Rod Bearing Pair	1.8670" or 47.430MM O.A.L.
	FP-8929670A	6	Std.	Main Bearing Plain	
	FP-8929671A	6	.254MM	Main Bearing Plain	
	FP-8929672A	6	.508MM	Main Bearing Plain	
	FP-8929673A	6	.762MM	Main Bearing Plain	
	FP-8929680	1	Std.	Main Bearing Flanged	
	FP-8929681	1	.254MM	Main Bearing Flanged	
	FP-8929682	1	.508MM	Main Bearing Flanged	
	FP-8929683	1	.762MM	Main Bearing Flanged	
	FP-8929085	2	Std.	Thrust Washer	
	FP-8929697	2	.127MM	Thrust Washer	
	FP-8929698	2	.254MM	Thrust Washer	
	FP-8929102	1		Oil Pan Gasket Set	Standard Oil Pan
	FP-23522279	1		Oil Pan Gasket Set	Use w/o Cord Modified Seal System
	FP-23532333	1		Head Gasket Set	

* When inventory depleted use new number in bold.

11.1L, 12.7L Series 60 Complete Overhaul

KIT NUMBER	COMPONENT NO.	QTY.	PART SIZE	PART DESCRIPTION	PART APPLICATION		
FP-S60-OH	FP-23519625*	6		Cylinder Kit Complete	Engs. w/Standard Liner; 2.50MM top ring; round piston design		
	FP-23532590						
	FP-23519637*					Cylinder Kit Complete	Engs. w/Standard Liner; 3.50MM top ring
	FP-23532591						
	FP-23523951*						
FP-23532555							
FP-23523952*		Cylinder Kit Complete	Engs. w/Top Liner Cooling (TLC); 3.50MM top ring;				
FP-23532556							
FP-23523954*				Cylinder Kit Complete	Engs. w/Top Liner Cooling (TLC); 2.50MM top ring; oval piston design		
FP-23532557							
FP-8929710	6					Std.	Rod Bearing Pair
FP-8929711	6	.254MM	Rod Bearing Pair			1.7100" or 43.430 O.A.L.	
FP-8929712	6	.508MM	Rod Bearing Pair			1.7100" or 43.430 O.A.L.	
FP-8929713	6	.762MM	Rod Bearing Pair	1.7100" or 43.430 O.A.L.			
FP-23515581	6	Std.	Rod Bearing Pair	1.8670" or 47.430MM O.A.L.			
FP-23515582	6	.254MM	Rod Bearing Pair	1.8670" or 47.430MM O.A.L.			
FP-23515583	6	.508MM	Rod Bearing Pair	1.8670" or 47.430MM O.A.L.			
FP-23515584	6	.762MM	Rod Bearing Pair	1.8670" or 47.430MM O.A.L.			
FP-8929670A	6	Std.	Main Bearing Plain				
FP-8929671A	6	.254MM	Main Bearing Plain				
FP-8929672A	6	.508MM	Main Bearing Plain				
FP-8929673A	6	.762MM	Main Bearing Plain				
FP-8929680	1	Std.	Main Bearing Flanged				
FP-8929681	1	.254MM	Main Bearing Flanged				
FP-8929682	1	.508MM	Main Bearing Flanged				
FP-8929683	1	.762MM	Main Bearing Flanged				
FP-8929085	2	Std.	Thrust Washer				
FP-8929697	2	.127MM	Thrust Washer				
FP-8929698	2	.254MM	Thrust Washer				
FP-23512691	1		Complete Gasket Set	Crankshaft seals not included			

*When inventory depleted use new number in bold.

Series 60 In-Frame Overhaul - Articulated Pistons

KIT NUMBER	COMPONENT NO.	QTY.	PART SIZE	PART DESCRIPTION	PART APPLICATION
FP-IFK-S60SPREM	FP-23532554	6		Cylinder Kit Complete	Articulated piston design; 16.5:1 C.R.; Heavy pin; From Sept. 2002
	FP-23532561	6		Cylinder Kit Complete	Articulated piston design; 15.0:1 C.R.; Heavy pin; To Sept. 2002
	FP-23532883	6	STD	Cylinder Kit Complete	Articulated piston design; 15.0:1 C.R.; Light pin; To Sept. 2002
	FP-23537594	6		Cylinder Kit Complete	Articulated piston design; 16.5:1 C.R.; Light pin; From Sept. 2002
	FP-23526142	6	STD	Connecting Rod Bearing Set	
	FP-8929670A	6	STD	Main Bearing, Plain	
	FP-8929671A	6	.254MM	Main Bearing, Plain	
	FP-8929672A	6	.508MM	Main Bearing, Plain	
	FP-8929673A	6	.762MM	Main Bearing, Plain	
	FP-8929680	1	STD	Main Bearing, Flanged	
	FP-8929681	1	.254MM	Main Bearing, Flanged	
	FP-8929682	1	.508MM	Main Bearing, Flanged	
	FP-8929683	1	.762MM	Main Bearing, Flanged	
	FP-8929085	2	STD	Thrust Washer	
	FP-8929697	2	.127MM	Thrust Washer	
	FP-8929698	2	.254MM	Thrust Washer	
	FP-8929690	7	STD	Camshaft Bearing	
	FP-23530768	38		Cylinder Head Bolt	
	FP-23532333	1		Head Gasket Set	
	FP-23522279	1		Oil Pan Gasket	Use for oil pan w/o cord modified seal system
	FP-8929102	1		Oil Pan Gasket	Standard oil pan
	FP-8929878	2		Thermostat	

Series 60 In-Frame Overhaul - Articulated Pistons

KIT NUMBER	COMPONENT NO.	QTY.	PART SIZE	PART DESCRIPTION	PART APPLICATION
FP-OH-S60SPREM	FP-23532554	6		Cylinder Kit Complete	Articulated piston design; 16.5:1 C.R.; Heavy pin; From Sept. 2002
	FP-23532561	6		Cylinder Kit Complete	Articulated piston design; 15.0:1 C.R.; Heavy pin; To Sept. 2002
	FP-23532883	6	STD	Cylinder Kit Complete	Articulated piston design; 15.0:1 C.R.; Light pin; To Sept. 2002
	FP-23537594	6		Cylinder Kit Complete	Articulated piston design; 16.5:1 C.R.; Light pin; From Sept. 2002
	FP-23526142	6	STD	Connecting Rod Bearing Set	
	FP-8929670A	6	STD	Main Bearing, Plain	
	FP-8929671A	6	.254MM	Main Bearing, Plain	
	FP-8929672A	6	.508MM	Main Bearing, Plain	
	FP-8929673A	6	.762MM	Main Bearing, Plain	
	FP-8929680	1	STD	Main Bearing, Flanged	
	FP-8929681	1	.254MM	Main Bearing, Flanged	
	FP-8929682	1	.508MM	Main Bearing, Flanged	
	FP-8929683	1	.762MM	Main Bearing, Flanged	
	FP-8929085	2	STD	Thrust Washer	
	FP-8929697	2	.127MM	Thrust Washer	
	FP-8929698	2	.254MM	Thrust Washer	
	FP-8929690	7	STD	Camshaft Bearing	
	FP-23530768	38		Cylinder Head Bolt	
	FP-23532332	1		Complete Overhaul Gasket Set	Does not contain oil pan gasket
	FP-23522279	1		Oil Pan Gasket	Use for oil pan w/o cord modified seal system
	FP-8929102	1		Oil Pan Gasket	Standard oil pan
	FP-8929878	2		Thermostat	

Multi-Purpose Engines Series 60 Eng. (11.1L) 7
11.1L 677 SOHC Turbo-Diesel L6 (24 Valve), 130mm Bore

CYL. HEAD & PARTS

QTY	GASKETS	PART NO.	SIZE	DESCRIPTION
1	Valve Cover Gasket	FP-23506153		Intermediate to upper rocker cover gskt.; 98.38" circumference; Diamond shaped 0.146" thick; For 3 piece cover; Use w/O.E. No. 23505973 rocker cover
1	Valve Cover Gasket	FP-23511992		Intermediate to upper rocker cover gskt.; 98.38" circumference; Diamond shaped 0.186" thick; For all 3 piece rocker covers Exc. O.E. No. 23505973
1	Valve Cover Gasket	FP-8929803		Lower to upper rocker cover gskt.; 106.68" circumference; Diamond shaped 0.146" thick; for 2 piece cover; Use w/O.E. No. 8929653 rocker cover
1	Valve Cover Gasket	FP-23511991		Lower to upper rocker cover gskt.; 106.68" circumference; Diamond shaped 0.186" thick; For 2 piece cover
1	Valve Cover Gasket	FP-23522269		New design rocker cover; Black polyacrylate
1	Valve Cover Gasket	FP-23516322		Standard rocker cover; Gray silicone
1	Head Gasket	FP-23530421		Blue Seal® Gasket Design
1	Head Gasket	FP-23538406		ML7™ head gasket design
1	Head Set	FP-23532333		Incl. Blue Seal® Gasket Design head gasket
1	Head Set	FP-23536442		Incl. ML7™ head gasket
1	Breather Seal Ring	FP-5103646		
QTY	HEAD BOLTS	PART NO.	SIZE	DESCRIPTION
38	Head Bolt	FP-23530768		
1	Head Bolt Set	FP-HBS002		Incl. (38) FP-23530768, (38) FP-8929328
38	Washer	FP-8929328		Cylinder head bolt
QTY	MISCELLANEOUS	PART NO.	SIZE	DESCRIPTION
2	Pipe Plug	FP-8923313		Cylinder head; 3/4"
8	Bolt	FP-11504822		Rocker cover mntg.; M8 x 1.25 x 30MM
QTY	MANIFOLD STUDS	PART NO.	SIZE	DESCRIPTION
4	Exhaust Manifold Stud	FP-23507438		Manifold to Turbo; M10 x 1.5 x 44.0
4	Exhaust Manifold Stud	FP-8929425		Manifold to Turbo; M10 x 1.5 x 50.0
QTY	FREEZE PLUGS	PART NO.	SIZE	DESCRIPTION
2	Pipe Plug	FP-8923313		Cylinder head; 3/4"
QTY	VALVE	PART NO.	SIZE	DESCRIPTION
12	Intake	FP-23529004 *		
12	Intake	FP-8929589 +		30 deg. seat; 1.7320" Head Dia., .3421" Stem Dia., 8.4980" O.A.L.; When depleted use FP-23529629
12	Intake	FP-23529629		30 deg. seat; 30 Deg. seat
12	Exhaust	FP-23524521		Engs. from 1991; EMS-247 Material; Chrome plated stem
12	Exhaust	FP-23529596		Engs. from 2002; 30 Deg. seat; Pyromet 31, Chrome plated stem; 1.5530" Head Dia., .3430" Stem Dia., 8.4710" O.A.L.
12	Exhaust	FP-23506350 +		Identification H; When depleted use FP-23524521
12	Exhaust	FP-23525179		Marine Engs. only; Pyromet 31, Stellite material; w/Seal groove; Chrome plated stem; 1.5580" Head Dia., .3420" Stem Dia., 8.5030" O.A.L.
12	Exhaust	FP-8929590		30 deg. seat; Identification U; Engs. to 1991; To Ser. No. 6R37024; 1.5760" Head Dia., .3421" Stem Dia., 8.4980" O.A.L.
12	Exhaust Valve Kit	FP-23507504		Identification H; Incl. FP-23524521 valve, valve seal, keeper & rotocap
12	Exhaust Valve Kit	FP-23501577		Identification U; Incl. valve, valve seal, keeper & rotocap
12	Intake Valve Kit	FP-23501576		Incl. FP-23529629 valve, valve seal, keeper & rotocap
48	Keeper	FP-8929573		
QTY	VALVE SEAT	PART NO.	SIZE	DESCRIPTION
12	Exh.	FP-8929126		Std. Depth; 6.261MM - 6.363MM thick; 1.6285" OD, 1.3591" ID, .2485" Depth
12	Exh.	FP-8929630		U/S Depth; 5.499MM - 5.601MM thick; 1.6285" OD, 1.3591" ID, .2185" Depth
12	Exh.	FP-8929629		U/S Depth; 5.753MM - 5.855MM thick; 1.6285" OD, 1.3591" ID, .2285" Depth
12	Exh.	FP-8929628		U/S Depth; 6.007MM - 6.109MM thick; 1.6285" OD, 1.3591" ID, .2385" Depth
12	Int.	FP-8929127		Std. Depth; 7.155MM - 7.251MM thick; 1.8195" OD, 1.5710" ID, .2837" Depth
12	Int.	FP-8929627		U/S Depth; 6.393MM - 6.495MM thick; 1.8195" OD, 1.5710" ID, .2537" Depth
12	Int.	FP-8929626		U/S Depth; 6.647MM - 6.749MM thick; 1.8195" OD, 1.5710" ID, .2637" Depth
12	Int.	FP-8929625		U/S Depth; 6.901MM - 7.003MM thick; 1.8195" OD, 1.5710" ID, .2737" Depth
QTY	VALVE GUIDE	PART NO.	SIZE	DESCRIPTION
24	Guide	FP-23533552		Exh. & Int.; Powdered Metal replacement

(continued on next page)

7 Multi-Purpose Engines Series 60 Eng. (11.1L) (cont.) 11.1L 677 SOHC Turbo-Diesel L6 (24 Valve), 130mm Bore

CYL. HEAD & PARTS (cont.)				
QTY	VALVE GUIDE (cont.)	PART NO.	SIZE	DESCRIPTION
24	Guide	FP-23518571		Exh. & Int.; 14.30MM - 14.32MM Dia.
24	Guide	FP-23518572		Exh. & Int.; 14.43MM - 14.45MM Dia.
QTY	VALVE SPRING	PART NO.	SIZE	DESCRIPTION
12	Spring	FP-23530359		Exh.; 3.1500" Free Height
24	Spring	FP-8929415		Exh. & Int.; Yellow stripe
QTY	VALVE MISC.	PART NO.	SIZE	DESCRIPTION
24	Rotocap	FP-8929105		
10	Isolator, Rocker Cover Bolt	FP-23517911		Use w/Two piece rocker cover
4	Isolator, Rocker Cover Bolt	FP-8929255		1.735" OD; One-piece rubber
4	Isolator, Rocker Cover Bolt	FP-23517912		1.756" OD; One-piece rubber with metal washer
12	Adj. Screw	FP-23520818		Int. valve adjusting
1	Crankcase Breather	FP-5101760		4"
QTY	VALVE SEAL	PART NO.	SIZE	DESCRIPTION
24	Valve Stem Seal	FP-23523930		
QTY	ROCKER PARTS	PART NO.	SIZE	DESCRIPTION
30	Nut	FP-23514371		Arm adj. screw; 3/8" - 24 UNF
12	Rocker Bushing	FP-8929059		Length 15MM
12	Rocker Bushing	FP-8929536		Length 20MM
30	Valve Button	FP-5138643		Arm adj. screw
IGNITION				
QTY	IGNITION	PART NO.	SIZE	DESCRIPTION
4	Bolt	FP-11504822		ECM mounting plate; M8 x 1.25 x 30MM
8	Isolator Bushing	FP-23502879		ECM mounting; DDECII
8	Isolator Bushing	FP-23512307		ECM mounting; DDECIII
ELECTRICAL				
QTY	ELECTRICAL	PART NO.	SIZE	DESCRIPTION
5	Bolt	FP-11504822		Tach drive cover; M8 x 1.25 x 30MM
1	Gasket	FP-8929130		Tach drive cover
INT & EXH MANIFOLDS				
QTY	INT. & EXH. MANIFOLDS	PART NO.	SIZE	DESCRIPTION
12	Bolt	FP-8929357		Manifold to head; M10 x 1.5 x 1.20
3	Exhaust Manifold Gasket	FP-23511666		
3	Air Intake Gasket	FP-23517875		
CAMSHAFT GROUP				
QTY	TIMING	PART NO.	SIZE	DESCRIPTION
2	Dowel Pin	FP-8929015		Gear case housing; 16MM; Circular shaped
1	Bushing	FP-8929108		Cam gear
1	Pipe Plug	FP-8924517		Gear case cover; 3/8" x 18 square head
QTY	CAMSHAFT/LIFTER	PART NO.	SIZE	DESCRIPTION
2	Bolt	FP-11504822		Balance shaft thrust plate; M8 x 1.25 x 30MM
1	Sealing Ring	FP-23521935		Thrust plate; Cylinder head
1	O-Ring	FP-23528491		Thrust plate; Gear housing
1	Oil Seal	FP-8929740		Cap bearing seal; .134" x .074" x .480"
2	Oil Seal	FP-23522975		Front cap seal
1	Oil Seal	FP-23521894		Thrust plate; Cylinder head
ACCESSORY DRIVE				
QTY	ACCESSORY DRIVE	PART NO.	SIZE	DESCRIPTION
1	Lock Ring	FP-23509204		Accessory drive
1	Lock Ring	FP-23511746		Accessory gear
1	Lock Ring	FP-8929062		Air compressor
1	Lock Ring	FP-23505643		Power steering pump
1	Ball Brg.	FP-23518178		Accessory drive
1	Ball Brg.	FP-23509203		Accessory gear shaft
1	Ball Brg.	FP-23503704		Fan shaft inner
1	Ball Brg.	FP-23503535		Fan shaft outer
1	Cylindrical Brg.	FP-23511745		Accessory drive
2	Snap Ring	FP-8929064		Accessory drive; 3.121" OD
1	Retaining Ring	FP-8929216		Accessory drive; 1.618" OD
1	Retaining Ring	FP-8929063		Accessory drive; 3.734" OD
1	O-Ring	FP-8929253		Acc. drive cover; .139" x 4.609" ID
1	Gasket	FP-8929130		Upper right rear & cam access cover
1	Gasket	FP-8929299		Acc. drive front

(continued on next page)

Multi-Purpose Engines Series 60 Eng. (11.1L) 7
11.1L 677 SOHC Turbo-Diesel L6 (24 Valve), 130mm Bore (cont.)

ACCESSORY DRIVE (cont.)				
QTY	ACCESSORY DRIVE (cont.)	PART NO.	SIZE	DESCRIPTION
1	Oil Seal	484156V		Viton®
1	Redi-Sleeve	99133		Use w/FP-8929154 seal
1	Oil Seal	FP-23511747		Accessory drive
1	Oil Seal	FP-8929154		Oil accessory drive; Also available as National No. 484156V
AIR COMPRESSOR				
QTY	AIR COMPRESSOR	PART NO.	SIZE	DESCRIPTION
1	Ball Brg.	FP-8929820		
1	Drive Coupling	FP-5141773		Air compressor drive
1	Gasket	FP-8929299		Drive housing
1	Accessory Drive Gasket	FP-23515145		
FUEL SYSTEM & PARTS				
QTY	FUEL INJECTION	PART NO.	SIZE	DESCRIPTION
6	Fuel Injector Seal Ring	FP-23515470		Injector hole tube
2	Fuel Injector Seal Ring	FP-5234699		Lower
1	Fuel Injector Seal Ring	FP-5234702		Upper
6	Injector Hole Tube Kit	FP-23501580		
6	Adj. Screw	FP-23520820		Injector adjusting
6	Bolt	FP-8929393		Injector clamp
QTY	FUEL FILTERS & PUMP	PART NO.	SIZE	DESCRIPTION
1	Fuel Pump Coupling	FP-23505249		For high capacity fuel pump
1	Fuel Pump Coupling	FP-8929479		For std. capacity fuel pump
1	Fuel Pump Coupling	FP-8929787		15.875MM ID
1	Fuel Pump Drive	FP-23511964		For std. capacity fuel pump
1	Fuel Pump Hub	FP-8929480		12.70MM ID
1	Fuel Pump Gear	FP-23506546		Drive gear; .375
1	Fuel Pump Gear	FP-23511959		Driven gear; .275
1	Fuel Pump Drive Shaft	FP-23506545		Drive shaft
1	Fuel Pump Drive Shaft	FP-23506549		Driven shaft
1	Fuel Pump Check Valve	FP-8923528		Injector check valve
1	Fuel Pump Spacer	FP-23506560		Relief Valve
1	Sealing Ring	FP-23506556		Relief valve
1	Cylindrical Brg.	FP-8923526		Fuel pump shaft
5	Bolt	FP-11504822		Fuel pump drive assy.; M8 x 1.25 x 30MM
1	Fuel Pump Repair Part	FP-23506564		Relief valve shear pin
1	Fuel Pump Body Plug	FP-23506553		
1	O-Ring	FP-8929253		Fuel cover; .139" x 4.609" ID
1	O-Ring	FP-23524657		Fuel/water separator
1	Fuel Pump Drive Adapter Gskt.	FP-5150193		
1	Fuel Pump Gasket	FP-23505248		Fuel pump mounting
QTY	TURBOCHARGER	PART NO.	SIZE	DESCRIPTION
1	Turbocharger Exhaust Gasket	FP-8929529		Inlet connection
1	Turbocharger Oil Return Gskt.	FP-8929285		
GOVERNOR				
QTY	GOVERNOR	PART NO.	SIZE	DESCRIPTION
1	Retaining Ring	FP-9411502		Mechanical governor weight
COOLING SYSTEM				
QTY	WATER PUMP	PART NO.	SIZE	DESCRIPTION
1	Water Pump - Heavy Duty	FP-23526039		Hi-Flow w/heat sink rotor
1	Water Pump Shaft	FP-8929157		Front mounted pumps
1	Water Pump Shaft	FP-23505896		Gear case mounted pumps
1	Water Pump Impeller	FP-8929512		Use w/Front mounted pumps
1	Water Pump Impeller	FP-23517973		Use w/Gear case mounted pumps
1	Water Pump Repair/Rebuild Kit	FP-23509105		Incl. FP23505024 and FP23512048 plate seals.
1	Water Pump Cover	FP-8922383		Non-metallic; Non-Metallic
1	Woodruff Key	FP-8929334		FWP shaft
1	Water Pump Retainer Ring	FP-8929427		Bearing & seal
1	Water Pump Retainer Ring	FP-8922407		FWP cover
1	Water Pump Mech. Shaft Seal	FP-23522433		Unitized seal
1	Ball Brg.	FP-8929422		Water pump shaft
1	Lock Nut	FP-11509584		Water pump
1	Water Pump Gasket	FP-23507073		
1	Water Pump Seal Ring	FP-8929158		Water pump; Front mounted pumps
1	Water Pump Seal Ring	FP-23520377		Water pump; Gear case mounted pumps
1	Water Pump Seal Ring	FP-8929510		Water pump cover; Front mounted pumps

(continued on next page)

7 Multi-Purpose Engines Series 60 Eng. (11.1L) (cont.) 11.1L 677 SOHC Turbo-Diesel L6 (24 Valve), 130mm Bore

COOLING SYSTEM (cont.)				
QTY	WATER PUMP (cont.)	PART NO.	SIZE	DESCRIPTION
1	Oil Seal	FP-5103951		Fan shaft
1	Oil Seal	FP-8929213		Fan spindle
1	Oil Seal	FP-8929134		Water pump; Lip type; Also available as National No. 4458V
1	Oil Seal	4458V		Viton®
1	O-Ring	FP-23512048		Water pump cover; Gear case mounted pumps; 4.77" OD
1	O-Ring	FP-23505024		Water pump cover; 4.218" OD
5	Bolt	FP-11504822		Fan mount support; M8 x 1.25 x 30MM
2	Bolt	FP-11504822		Water pump cover; M8 x 1.25 x 30MM
1	Retaining Ring	FP-8929216		Fan drive; 1.618" OD
1	Retaining Ring	FP-8929063		Fan drive; 3.734" OD
QTY	HOSES	PART NO.	SIZE	DESCRIPTION
2	Silicone Hose	FP-8929875		Water bypass tube; 1.750" ID x 3.250" Length
2	Silicone Hose	FP-23506325		Water pump to cooler
QTY	THERMOSTAT	PART NO.	SIZE	DESCRIPTION
1	Thermostat	FP-23503827		Type 481; 160 Deg.
1	Thermostat	FP-8929878		Types 358, 439, 448, 488, 507, 511, 518, 520; 190 Deg.
1	Thermostat	FP-23503825		Types 497, 516; 180 Deg.
1	Thermostat Kit	FP-23532436		Thermostat & seal incl.
2	Oil Seal	FP-5132155		
ENGINE BLOCK & PARTS				
QTY	GASKETS	PART NO.	SIZE	DESCRIPTION
1	Oil Pan Gasket	FP-8929102		Standard oil pan; Gray silicone
1	Oil Pan Gasket	FP-23522279		Use for oil pan w/o cord modified seal system
10	Oil Pan Isolator Bushing	FP-23517242		
10	Bolt	FP-11504571		Oil pan
1	Copper Washer	FP-23513842		Oil gauge adapter
1	Oil Seal	FP-8929740		Block to gear case; .134" x .074" x .480"
QTY	GASKET SETS	PART NO.	SIZE	DESCRIPTION
1	Complete Overhaul Gasket Set	FP-23532332		Incl. Blue Seal® Gasket Design head gasket
QTY	DOWEL PINS	PART NO.	SIZE	DESCRIPTION
1	Dowel Pin	FP-8929015		16MM; Circular shaped
2	Dowel Pin	FP-8929022		16MM; Diamond shape
1	Dowel Pin	FP-8929152		20MM; Circular shape
QTY	CAM BEARINGS	PART NO.	SIZE	DESCRIPTION
7	Cam Brg.	FP-8929690	STD	
7	Cam Brg.	FP-8929691	.254MM	
7	Cam Brg.	FP-8929692	.508MM	
7	Cam Brg.	FP-8929693	.762MM	
QTY	OIL COOLERS & FILTERS	PART NO.	SIZE	DESCRIPTION
1	Oil Cooler	FP-8547625		4 plate
1	Oil Cooler	FP-8547626		8 plate
6	Bolt	FP-11504822		Transfer cooler adapter housing; M8 x 1.25 x 30MM
1	Oil Cooler Gasket Kit	FP-23537789		Incl. both New and Old design housing-to-core gaskets
2	O-Ring	FP-8929289		Oil cooler housing
1	Oil Cooler Core Gasket	FP-8929348		Core housing; Old design
2	Rect. or Square Seal	FP-8929280		Oil cooler
2	Oil Cooler Seal Ring	FP-23508392		Filter adapter housing
1	Gasket	FP-23506247		Core housing; New design
QTY	FREEZE PLUGS	PART NO.	SIZE	DESCRIPTION
1	Pipe Plug	FP-8926993		1/4" X 18; Recessed socket head
1	Pipe Plug	FP-8923313		Block; 3/4"
QTY	MISCELLANEOUS	PART NO.	SIZE	DESCRIPTION
1	Chain, Oil Filler Cap	FP-5121989		6.5" Length
1	Oil Filler Cap	FP-5117362		2.00" Dia.; Thermos Bottle Style
CRANKSHAFT/OIL PUMP				
QTY	CRANKSHAFT	PART NO.	SIZE	DESCRIPTION
1	Crankshaft	FP-23515597		12 hole
QTY	SEALS - FRONT CRANK	PART NO.	SIZE	DESCRIPTION
1	Oil Seal Kit	FP-23518355		
QTY	SEALS - REAR CRANK	PART NO.	SIZE	DESCRIPTION
1	Oil Seal Kit	FP-23513578		Double lip wrap around
1	Oil Seal Kit	FP-23516969		PTFE lip; Also available as National No. 5424
1	Oil Seal Kit	5424		

(continued on next page)

Multi-Purpose Engines Series 60 Eng. (11.1L) 7
11.1L 677 SOHC Turbo-Diesel L6 (24 Valve), 130mm Bore (cont.)

CRANKSHAFT/OIL PUMP (cont.)

QTY	SEALS - REAR CRANK (cont.)	PART NO.	SIZE	DESCRIPTION
6	Washer	FP-5133981		Vibration damper; .122" Thick
QTY	MAIN BEARINGS	PART NO.	SIZE	DESCRIPTION
1	Main Set	FP-7363M	STD	
1	Main Set	FP-7363M254MM	.254MM	
1	Main Set	FP-7363M508MM	.508MM	
1	Main Set	FP-7363M762MM	.762MM	
1	Main Set	7363M + Std-10		When depleted use FP-7363M
6	Plain Main Brg.	FP-8929670A	STD	
6	Plain Main Brg.	FP-8929671A	.254MM	
6	Plain Main Brg.	FP-8929672A	.508MM	
6	Plain Main Brg.	FP-8929673A	.762MM	
1	Flanged Main Brg.	FP-8929680	STD	
1	Flanged Main Brg.	FP-8929681	.254MM	
1	Flanged Main Brg.	FP-8929682	.508MM	
1	Flanged Main Brg.	FP-8929683	.762MM	
1	Lower End Bearing Kit	FP-23531604		Incl. 1.7100" or 43.430MM O.A.L. rod bearings; Incl. Rod & Main bearings, Thrust Washers, Lower Gaskets, Exc. Oil Pan
1	Lower End Bearing Kit	FP-23531605		Incl. 1.8670" or 47.430MM O.A.L. rod bearings
1	Thrust Washer Set	FP-8929085S	STD	Position Upper
2	Thrust Washer	FP-8929085	STD	Position Upper
2	Thrust Washer	FP-8929697	.127MM	Position Upper; .127MM oversize
2	Thrust Washer	FP-8929698	.254MM	Position Upper; .254MM oversize
QTY	OIL PUMP	PART NO.	SIZE	DESCRIPTION
1	Lo Pressure Regulator Valve	FP-8922740		
1	Bushing	FP-5127978		Oil pump
1	Bushing	FP-23505879		Oil pump; 25MM Bore, 22.27MM Shaft, 11.5MM Length
1	Oil Pump Spring	FP-5126327		Outlet bypass valve; .790" Dia., 2.96" Length
1	Bolt	FP-11504822		Inlet tube; M8 x 1.25 x 30MM
4	Bolt	FP-11504822		Outlet pipe; M8 x 1.25 x 30MM
2	Bolt	FP-11504822		Pressure regulator; M8 x 1.25 x 30MM
2	Bolt	FP-11504822		Pressure relief vlv.; M8 x 1.25 x 30MM
1	Bolt	FP-11504822		Screen bracket; M8 x 1.25 x 30MM
1	Oil Pump Intake Gasket	FP-8929344		Pump to block
1	Oil Pump Outlet Gasket	FP-8929347		
1	Rect. or Square Seal	FP-8929341		Oil filter
1	Rect. or Square Seal	FP-8929340		Oil filter bypass
1	Oil Inlet Elbow Gasket	FP-23505992		Inlet tube to pump
1	Lo Press. Reg. Body Gasket	FP-5117269		
1	Gasket	FP-8929302		Fill tube adapter
1	Gasket	FP-8929302		Oil filter cover
1	Oil Filter Seal Ring	FP-8929342		Oil filter adapter
1	Pipe Plug	FP-23511574		Oil drain; 1/2" pipe thread; w/1" Square head
CYLINDER COMPONENTS				
QTY	LINERS	PART NO.	SIZE	DESCRIPTION
6	Liner w/o Sealing Rings	FP-23532361		Engs. w/Standard liner
6	Liner w/Sealing Rings	FP-23532468		FP-23532361 liner incl.
6	Liner w/Sealing Rings	FP-23531249		FP-23532468 liner incl.
6	Cylinder Kit Complete	FP-23532590	STD	Engs. w/Standard liner; 2.50MM top ring; Round piston design
6	Cylinder Kit Complete	FP-23532591	STD	Engs. w/Standard liner; 3.50MM top ring
6	Cylinder Kit Complete	FP-23519637	STD	Engs. w/Standard liner; 3.50MM top ring; When depleted use FP-23532591
6	Cylinder Kit Complete	FP-23532558	STD	Engs. w/Top Liner Cooling (TLC); 2.50MM top ring; Domed piston design
6	Cylinder Kit Complete	FP-23532557	STD	Engs. w/Top Liner Cooling (TLC); 2.50MM top ring; Oval piston design
6	Cylinder Kit Complete	FP-23532555	STD	Engs. w/Top Liner Cooling (TLC); 2.50MM top ring; Round piston design
6	Cylinder Kit Complete	FP-23532556	STD	Engs. w/Top Liner Cooling (TLC); 3.50MM top ring
6	Sealing Ring, Liner	FP-8929013		Crevice seal
12	Sealing Ring, Liner	FP-8929176		D-ring seal
6	Flange Shim	FP-20044	31	.031" Thick
6	Flange Shim	FP-20045	62	.062" Thick
6	Cntr. Bore Insert	FP-23525500		
6	Lower Block Bore Sleeve	FP-20042		
QTY	PISTONS	PART NO.	SIZE	DESCRIPTION
6	Piston Kit w/Pin & Retainers	FP-23524601	STD	Engs. w/Domed piston & 2.50MM top ring
6	Piston Kit w/Pin & Retainers	FP-23519646	STD	Engs. w/Top Liner Cooling (TLC) & 2.50MM top ring; Oval piston design

(continued on next page)

7 Multi-Purpose Engines Series 60 Eng. (11.1L) (cont.) 11.1L 677 SOHC Turbo-Diesel L6 (24 Valve), 130mm Bore

CYLINDER COMPONENTS (cont.)								
QTY	PISTONS (cont.)		PART NO.	SIZE	DESCRIPTION			
6	Piston Kit w/Pin & Retainers		FP-23519624	STD	Engs. w/Top Liner Cooling (TLC) & 2.50MM top ring; Round piston design			
6	Piston Kit w/Pin & Retainers		FP-23519635	STD	Engs. w/3.50MM top ring			
6	Piston Skirt		FP-23516681		Ductile iron for standard cross head piston			
6	Pin		FP-8929087					
12	Piston Pin Bolt		FP-8929337					
12	Piston Pin Bolt Spacer		FP-8929504					
6	Pin Bushing		FP-4774Y					
QTY	CONNECTING RODS & BRGS.		PART NO.	SIZE	DESCRIPTION			
12	Con. Rod Bolt		FP-8929355		M14 x 1.5" x 108			
12	Con. Rod Nut		FP-8929019		M14 x 1.5			
6	Rod Pair		FP-4770P		O.A.L. 1.710" or 43.430MM			
6	Rod Pair		4770P + Std-.25MM		O.A.L. 1.710" or 43.430MM; When depleted use FP-4770P			
6	Rod Pair		FP-8929710	STD	O.A.L. 1.7100" or 43.430MM			
6	Rod Pair		FP-8929711	.254MM	O.A.L. 1.7100" or 43.430MM			
6	Rod Pair		FP-8929712	.508MM	O.A.L. 1.7100" or 43.430MM			
6	Rod Pair		FP-8929713	.762MM	O.A.L. 1.7100" or 43.430MM			
6	Rod Pair		FP-23515581	STD	O.A.L. 1.8670" or 47.430MM			
6	Rod Pair		FP-23515582	.254MM	O.A.L. 1.8670" or 47.430MM			
6	Rod Pair		FP-23515583	.508MM	O.A.L. 1.8670" or 47.430MM			
6	Rod Pair		FP-23515584	.762MM	O.A.L. 1.8670" or 47.430MM			
QTY	PISTON RINGS		PART NO.	SIZE	DESCRIPTION			
6	Ring Set Single Cylinder		FP-23503747		2.50MM top ring			
6	Ring Set Single Cylinder		FP-23505729		3.50MM top ring			
6	Compression Ring		FP-8929845		Intermediate			
6	Compression Ring		FP-8929844		Top; 2.50MM			
6	Compression Ring		FP-23504941		Top; 3.50MM			
6	Oil Ring		FP-23515500					
6	Oil Ring Expander		FP-23529379					
CLUTCH								
QTY	CLUTCH		PART NO.	SIZE	DESCRIPTION			
1	Ball Brg.		FP-23503707		Clutch Pilot			
KITS								
RE-RING KIT					QTY	PREMIUM KIT NO.	QTY	ECONOMY KIT NO.
YEARS	DESCRIPTION							
	In-Frame Kit		Re-ring w/Mains		1	FP-S60IFKRR		----
	Overhaul Kit		Re-ring w/Mains		1	FP-S60OHRR		----
QTY	OVERHAUL KIT		PART NO.	SIZE	DESCRIPTION			
1	In-Frame Overhaul Kit		FP-S60					
1	In-Frame Overhaul Kit		FP-S60TLC					
1	Complete Overhaul Kit		FP-S60OH					
1	Complete Overhaul Kit		FP-S60TLCOH					
8 Multi-Purpose Engines Series 60 Eng. (12.7L) 12.7L 774 SOHC Turbo-Diesel L6 (24 Valve), 130mm Bore								
CYL. HEAD & PARTS								
QTY	GASKETS		PART NO.	SIZE	DESCRIPTION			
1	Valve Cover Gasket		FP-23506153		Intermediate to upper rocker cover gskt.; 98.38" circumference; Diamond shaped 0.146" thick; For 3 piece cover; Use w/O.E. No. 23505973 rocker cover			
1	Valve Cover Gasket		FP-23511992		Intermediate to upper rocker cover gskt.; 98.38" circumference; Diamond shaped 0.186" thick; For all 3 piece rocker covers Exc. O.E. No. 23505973			
1	Valve Cover Gasket		FP-8929803		Lower to upper rocker cover gskt.; 106.68" circumference; Diamond shaped 0.146" thick; for 2 piece cover; Use w/O.E. No. 8929653 rocker cover			
1	Valve Cover Gasket		FP-23511991		Lower to upper rocker cover gskt.; 106.68" circumference; Diamond shaped 0.186" thick; For 2 piece cover			
1	Valve Cover Gasket		FP-23522269		New design rocker cover; Black polyacrylate			
1	Valve Cover Gasket		FP-23516322		Standard rocker cover; Gray silicone			
1	Head Gasket		FP-23530421		Blue Seal® Gasket Design			
1	Head Gasket		FP-23538406		ML7™ head gasket design			
1	Head Set		FP-23532333		Incl. Blue Seal® Gasket Design head gasket			
1	Head Set		FP-23536442		Incl. ML7™ head gasket			

(continued on next page)

Multi-Purpose Engines Series 60 Eng. (12.7L) 8
12.7L 774 SOHC Turbo-Diesel L6 (24 Valve), 130mm Bore (cont.)

CYL. HEAD & PARTS (cont.)				
QTY	GASKETS (cont.)	PART NO.	SIZE	DESCRIPTION
1	Breather Seal Ring	FP-5103646		
QTY	HEAD BOLTS	PART NO.	SIZE	DESCRIPTION
38	Head Bolt	FP-23530768		
1	Head Bolt Set	FP-HBS002		Incl. (38) FP-23530768, (38) FP-8929328
38	Washer	FP-8929328		Cylinder head bolt
QTY	MISCELLANEOUS	PART NO.	SIZE	DESCRIPTION
2	Pipe Plug	FP-8923313		Cylinder head; 3/4"
8	Bolt	FP-11504822		Rocker cover mntg.; M8 x 1.25 x 30MM
QTY	MANIFOLD STUDS	PART NO.	SIZE	DESCRIPTION
4	Exhaust Manifold Stud	FP-23507438		Manifold to Turbo; M10 x 1.5 x 44.0
4	Exhaust Manifold Stud	FP-8929425		Manifold to Turbo; M10 x 1.5 x 50.0
QTY	FREEZE PLUGS	PART NO.	SIZE	DESCRIPTION
2	Pipe Plug	FP-8923313		Cylinder head; 3/4"
QTY	VALVE	PART NO.	SIZE	DESCRIPTION
12	Intake	FP-8929589 +		30 deg. seat; 1.7320" Head Dia., .3421" Stem Dia., 8.4980" O.A.L.; When depleted use FP-23529629
12	Intake	FP-23529629		30 deg. seat; 30 Deg. seat
12	Exhaust	FP-23524521		Engs. from 1991; EMS-247 Material; Chrome plated stem
12	Exhaust	FP-23529596		Engs. from 2002; 30 Deg. seat; Pyromet 31, Chrome plated stem; 1.5530" Head Dia., .3430" Stem Dia., 8.4710" O.A.L.
12	Exhaust	FP-23506350 +		Identification H; When depleted use FP-23524521
12	Exhaust	FP-23525179		Marine Engs. only; Pyromet 31, Stellite material; w/Seal groove; Chrome plated stem; 1.5580" Head Dia., .3420" Stem Dia., 8.5030" O.A.L.
12	Exhaust	FP-8929590		30 deg. seat; Identification U; Engs. to 1991; 1.5760" Head Dia., .3421" Stem Dia., 8.4980" O.A.L.
12	Exhaust Valve Kit	FP-23507504		Identification H; Incl. FP-23524521 valve, valve seal, keeper & rotocap
12	Exhaust Valve Kit	FP-23501577		Identification U; Incl. valve, valve seal, keeper & rotocap
12	Intake Valve Kit	FP-23501576		Incl. FP-23529629 valve, valve seal, keeper & rotocap
48	Keeper	FP-8929573		
QTY	VALVE SEAT	PART NO.	SIZE	DESCRIPTION
12	Exh.	FP-8929126		Std. Depth; 6.261MM - 6.363MM thick; 1.6285" OD, 1.3591" ID, .2485" Depth
12	Exh.	FP-8929630		U/S Depth; 5.499MM - 5.601MM thick; 1.6285" OD, 1.3591" ID, .2185" Depth
12	Exh.	FP-8929629		U/S Depth; 5.753MM - 5.855MM thick; 1.6285" OD, 1.3591" ID, .2285" Depth
12	Exh.	FP-8929628		U/S Depth; 6.007MM - 6.109MM thick; 1.6285" OD, 1.3591" ID, .2385" Depth
12	Int.	FP-8929127		Std. Depth; 7.155MM - 7.251MM thick; 1.8195" OD, 1.5710" ID, .2837" Depth
12	Int.	FP-8929627		U/S Depth; 6.393MM - 6.495MM thick; 1.8195" OD, 1.5710" ID, .2537" Depth
12	Int.	FP-8929626		U/S Depth; 6.647MM - 6.749MM thick; 1.8195" OD, 1.5710" ID, .2637" Depth
12	Int.	FP-8929625		U/S Depth; 6.901MM - 7.003MM thick; 1.8195" OD, 1.5710" ID, .2737" Depth
QTY	VALVE GUIDE	PART NO.	SIZE	DESCRIPTION
24	Guide	FP-23533552		Exh. & Int.; Powdered Metal replacement
24	Guide	FP-23518571		Exh. & Int.; 14.30MM - 14.32MM Dia.
24	Guide	FP-23518572		Exh. & Int.; 14.43MM - 14.45MM Dia.
QTY	VALVE SPRING	PART NO.	SIZE	DESCRIPTION
12	Spring	FP-23530359		Exh.; 3.1500" Free Height
24	Spring	FP-8929415		Exh. & Int.; Yellow stripe
QTY	VALVE MISC.	PART NO.	SIZE	DESCRIPTION
24	Rotocap	FP-8929105		Exh. & Int.
10	Isolator, Rocker Cover Bolt	FP-23517911		Use w/Two piece rocker cover
4	Isolator, Rocker Cover Bolt	FP-8929255		1.735" OD; One-piece rubber
4	Isolator, Rocker Cover Bolt	FP-23517912		1.756" OD; One-piece rubber with metal washer
12	Adj. Screw	FP-23520818		Int. valve adjusting
1	Crankcase Breather	FP-5101760		4"
QTY	VALVE SEAL	PART NO.	SIZE	DESCRIPTION
24	Valve Stem Seal	FP-23523930		
QTY	ROCKER PARTS	PART NO.	SIZE	DESCRIPTION
30	Nut	FP-23514371		Arm adj. screw; 3/8" - 24 UNF

(continued on next page)

8 Multi-Purpose Engines Series 60 Eng. (12.7L)				
(cont.) 12.7L 774 SOHC Turbo-Diesel L6 (24 Valve), 130mm Bore				
CYL. HEAD & PARTS (cont.)				
QTY	ROCKER PARTS (cont.)	PART NO.	SIZE	DESCRIPTION
30	Valve Button	FP-5138643		Arm adj. screw
IGNITION				
QTY	IGNITION	PART NO.	SIZE	DESCRIPTION
4	Bolt	FP-11504822		ECM mounting plate; M8 x 1.25 x 30MM
8	Isolator Bushing	FP-23502879		ECM mounting; DDECII
8	Isolator Bushing	FP-23512307		ECM mounting; DDECIII
ELECTRICAL				
QTY	ELECTRICAL	PART NO.	SIZE	DESCRIPTION
5	Bolt	FP-11504822		Tach drive cover; M8 x 1.25 x 30MM
1	Gasket	FP-8929130		Tach drive cover
INT & EXH MANIFOLDS				
QTY	INT. & EXH. MANIFOLDS	PART NO.	SIZE	DESCRIPTION
12	Bolt	FP-8929357		Manifold to head; M10 x 1.5 x 1.20
3	Exhaust Manifold Gasket	FP-23511666		
3	Air Intake Gasket	FP-23517875		
CAMSHAFT GROUP				
QTY	TIMING	PART NO.	SIZE	DESCRIPTION
2	Dowel Pin	FP-8929015		Gear case housing; 16MM; Circular shaped
1	Bushing	FP-8929108		Cam gear
1	Pipe Plug	FP-8924517		Gear case cover; 3/8" x 18 square head
QTY	CAMSHAFT/LIFTER	PART NO.	SIZE	DESCRIPTION
2	Bolt	FP-11504822		Balance shaft thrust plate; M8 x 1.25 x 30MM
1	Sealing Ring	FP-23521935		Thrust plate; Cylinder head
1	O-Ring	FP-23528491		Thrust plate; Gear housing
1	Oil Seal	FP-8929740		Cap bearing seal; .134" x .074" x .480"
2	Oil Seal	FP-23522975		Front cap seal
1	Oil Seal	FP-23521894		Thrust plate; Cylinder head
ACCESSORY DRIVE				
QTY	ACCESSORY DRIVE	PART NO.	SIZE	DESCRIPTION
1	Lock Ring	FP-23509204		Accessory drive
1	Lock Ring	FP-23511746		Accessory gear
1	Lock Ring	FP-8929062		Air compressor
1	Lock Ring	FP-23505643		Power steering pump
1	Ball Brg.	FP-23518178		Accessory drive
1	Ball Brg.	FP-23509203		Accessory gear shaft
1	Ball Brg.	FP-23503704		Fan shaft inner
1	Ball Brg.	FP-23503535		Fan shaft outer
1	Cylindrical Brg.	FP-23511745		Accessory drive
2	Snap Ring	FP-8929064		Accessory drive; 3.121" OD
1	Retaining Ring	FP-8929216		Accessory drive; 1.618" OD
1	Retaining Ring	FP-8929063		Accessory drive; 3.734" OD
1	O-Ring	FP-8929253		Acc. drive cover; .139" x 4.609" ID
1	Gasket	FP-8929130		Upper right rear & cam access cover
1	Gasket	FP-8929299		Acc. drive front
1	Oil Seal	484156V		Viton®
1	Redi-Sleeve	99133		Use w/FP-8929154 seal
1	Oil Seal	FP-23511747		Accessory drive
1	Oil Seal	FP-8929154		Oil accessory drive; Also available as National No. 484156V
AIR COMPRESSOR				
QTY	AIR COMPRESSOR	PART NO.	SIZE	DESCRIPTION
1	Ball Brg.	FP-8929820		
1	Drive Coupling	FP-5141773		Air compressor drive
1	Gasket	FP-8929299		Drive housing
1	Accessory Drive Gasket	FP-23515145		Air Compressor Mntg.
FUEL SYSTEM & PARTS				
QTY	FUEL INJECTION	PART NO.	SIZE	DESCRIPTION
6	Fuel Injector Seal Ring	FP-23515470		Injector hole tube
2	Fuel Injector Seal Ring	FP-5234699		Lower
1	Fuel Injector Seal Ring	FP-5234702		Upper
6	Injector Hole Tube Kit	FP-23501580		
6	Adj. Screw	FP-23520820		Injector adjusting

(continued on next page)

Multi-Purpose Engines Series 60 Eng. (12.7L) 8
12.7L 774 SOHC Turbo-Diesel L6 (24 Valve), 130mm Bore (cont.)

FUEL SYSTEM & PARTS (cont.)				
QTY		PART NO.	SIZE	DESCRIPTION
6	FUEL INJECTION (cont.) Bolt	FP-8929393		Injector clamp
QTY	FUEL FILTERS & PUMP	PART NO.	SIZE	DESCRIPTION
1	Fuel Pump Coupling	FP-23505249		For high capacity fuel pump
1	Fuel Pump Coupling	FP-8929479		For std. capacity fuel pump
1	Fuel Pump Coupling	FP-8929787		15.875MM ID
1	Fuel Pump Drive	FP-23511964		For std. capacity fuel pump
1	Fuel Pump Hub	FP-8929480		12.70MM ID
1	Fuel Pump Gear	FP-23506546		Drive gear; .375
1	Fuel Pump Gear	FP-23511959		Driven gear; .275
1	Fuel Pump Drive Shaft	FP-23506545		Drive shaft
1	Fuel Pump Drive Shaft	FP-23506549		Driven shaft
1	Fuel Pump Check Valve	FP-8923528		Injector check valve
1	Fuel Pump Spacer	FP-23506560		Relief Valve
1	Sealing Ring	FP-23506556		Relief valve
1	Cylindrical Brg.	FP-8923526		Fuel pump shaft
5	Bolt	FP-11504822		Fuel pump drive assy.; M8 x 1.25 x 30MM
1	Fuel Pump Repair Part	FP-23506564		Relief valve shear pin
1	Fuel Pump Body Plug	FP-23506553		
1	O-Ring	FP-8929253		Fuel cover; .139" x 4.609" ID
1	O-Ring	FP-23524657		Fuel/water separator
1	Fuel Pump Drive Adapter Gskt.	FP-5150193		
1	Fuel Pump Gasket	FP-23505248		Fuel pump mounting
QTY	TURBOCHARGER	PART NO.	SIZE	DESCRIPTION
1	Turbocharger Exhaust Gasket	FP-8929529		Inlet connection
1	Turbocharger Oil Return Gskt.	FP-8929285		
GOVERNOR				
QTY	GOVERNOR	PART NO.	SIZE	DESCRIPTION
1	Retaining Ring	FP-9411502		Mechanical governor weight
COOLING SYSTEM				
QTY	WATER PUMP	PART NO.	SIZE	DESCRIPTION
1	Water Pump - Heavy Duty	FP-23526039		Hi-Flow w/heat sink rotor
1	Water Pump Shaft	FP-8929157		Front mounted pumps
1	Water Pump Shaft	FP-23505896		Gear case mounted pumps
1	Water Pump Impeller	FP-8929512		Use w/Front mounted pumps
1	Water Pump Impeller	FP-23517973		Use w/Gear case mounted pumps
1	Water Pump Repair/Rebuild Kit	FP-23509105		Incl. FP23505024 and FP23512048 plate seals.
1	Water Pump Cover	FP-8922383		Non-metallic; Non-Metallic
1	Woodruff Key	FP-8929334		FWP shaft
1	Water Pump Retainer Ring	FP-8929427		Bearing & seal
1	Water Pump Retainer Ring	FP-8922407		FWP cover
1	Water Pump Mech. Shaft Seal	FP-23522433		Unitized seal
1	Ball Brg.	FP-8929422		Water pump shaft
1	Lock Nut	FP-11509584		Water pump
1	Water Pump Gasket	FP-23507073		
1	Water Pump Seal Ring	FP-8929158		Water pump; Front mounted pumps
1	Water Pump Seal Ring	FP-23520377		Water pump; Gear case mounted pumps
1	Water Pump Seal Ring	FP-8929510		Water pump cover; Front mounted pumps
1	Oil Seal	FP-5103951		Fan shaft
1	Oil Seal	FP-8929213		Fan spindle
1	Oil Seal	FP-8929134		Water pump; Lip type; Also available as National No. 4458V
1	Oil Seal	4458V		Viton®
1	O-Ring	FP-23512048		Water pump cover; Gear case mounted pumps; 4.77" OD
1	O-Ring	FP-23505024		Water pump cover; 4.218" OD
5	Bolt	FP-11504822		Fan mount support; M8 x 1.25 x 30MM
2	Bolt	FP-11504822		Water pump cover; M8 x 1.25 x 30MM
1	Retaining Ring	FP-8929216		Fan drive; 1.618" OD
1	Retaining Ring	FP-8929063		Fan drive; 3.734" OD
QTY	HOSES	PART NO.	SIZE	DESCRIPTION
2	Silicone Hose	FP-8929875		Water bypass tube; 1.750" ID x 3.250" Length
2	Silicone Hose	FP-23506325		Water pump to cooler
QTY	THERMOSTAT	PART NO.	SIZE	DESCRIPTION
1	Thermostat	FP-23503827		Type 481; 160 Deg.
1	Thermostat	FP-8929878		Types 358, 439, 448, 488, 507, 511, 518, 520; 190 Deg.
1	Thermostat	FP-23503825		Types 497, 516; 180 Deg.
1	Thermostat Kit	FP-23532436		Thermostat & seal incl.

(continued on next page)

8 Multi-Purpose Engines Series 60 Eng. (12.7L) (cont.) 12.7L 774 SOHC Turbo-Diesel L6 (24 Valve), 130mm Bore				
COOLING SYSTEM (cont.)				
QTY	THERMOSTAT (cont.)	PART NO.	SIZE	DESCRIPTION
2	Oil Seal	FP-5132155		
ENGINE BLOCK & PARTS				
QTY	GASKETS	PART NO.	SIZE	DESCRIPTION
1	Oil Pan Gasket	FP-8929102		Standard oil pan; Gray silicone
1	Oil Pan Gasket	FP-23522279		Use for oil pan w/o cord modified seal system
10	Oil Pan Isolator Bushing	FP-23517242		
10	Bolt	FP-11504571		Oil pan
1	Copper Washer	FP-23513842		Oil gauge adapter
1	Oil Seal	FP-8929740		Block to gear case; .134" x .074" x .480"
QTY	GASKET SETS	PART NO.	SIZE	DESCRIPTION
1	Complete Overhaul Gasket Set	FP-23532332		Incl. Blue Seal® Gasket Design head gasket
QTY	DOWEL PINS	PART NO.	SIZE	DESCRIPTION
1	Dowel Pin	FP-8929015		16MM; Circular shaped
2	Dowel Pin	FP-8929022		16MM; Diamond shape
1	Dowel Pin	FP-8929152		20MM; Circular shape
QTY	CAM BEARINGS	PART NO.	SIZE	DESCRIPTION
7	Cam Brg.	FP-8929690	STD	
7	Cam Brg.	FP-8929691	.254MM	
7	Cam Brg.	FP-8929692	.508MM	
7	Cam Brg.	FP-8929693	.762MM	
QTY	OIL COOLERS & FILTERS	PART NO.	SIZE	DESCRIPTION
1	Oil Cooler	FP-8547625		4 plate
1	Oil Cooler	FP-8547626		8 plate
6	Bolt	FP-11504822		Transfer cooler adapter housing; M8 x 1.25 x 30MM
1	Oil Cooler Gasket Kit	FP-23537789		Incl. both New and Old design housing-to-core gaskets
2	O-Ring	FP-8929289		Oil cooler housing
1	Oil Cooler Core Gasket	FP-8929348		
2	Rect. or Square Seal	FP-8929280		Oil cooler
2	Oil Cooler Seal Ring	FP-23508392		Filter adapter housing
1	Gasket	FP-23506247		Core housing
QTY	FREEZE PLUGS	PART NO.	SIZE	DESCRIPTION
1	Pipe Plug	FP-8926993		1/4" X 18; Recessed socket head
1	Pipe Plug	FP-8923313		Block; 3/4"
QTY	MISCELLANEOUS	PART NO.	SIZE	DESCRIPTION
1	Chain, Oil Filler Cap	FP-5121989		6.5" Length
1	Oil Filler Cap	FP-5117362		2.00" Dia.; Thermos Bottle Style
CRANKSHAFT/OIL PUMP				
QTY	CRANKSHAFT	PART NO.	SIZE	DESCRIPTION
1	Crankshaft	FP-23515599		6 or 12 Hole, Wide Bearing
1	Crankshaft	FP-8929239		6 Hole, Narrow Bearing
1	Vibration Damper	FP-23525990		13.5" Dia., One-piece
QTY	SEALS - FRONT CRANK	PART NO.	SIZE	DESCRIPTION
1	Oil Seal Kit	FP-23518355		
QTY	SEALS - REAR CRANK	PART NO.	SIZE	DESCRIPTION
1	Oil Seal Kit	FP-23513578		Double lip wrap around
1	Oil Seal Kit	FP-23516969		PTFE lip; Also available as National No. 5424
1	Oil Seal Kit	5424		
6	Washer	FP-5133981		Vibration damper; .122" Thick
QTY	MAIN BEARINGS	PART NO.	SIZE	DESCRIPTION
1	Main Set	FP-7363M	STD	
1	Main Set	FP-7363M254MM	.254MM	
1	Main Set	FP-7363M508MM	.508MM	
1	Main Set	FP-7363M762MM	.762MM	
1	Main Set	7363M + Std-10		When depleted use FP-7363M
6	Plain Main Brg.	FP-8929670A	STD	
6	Plain Main Brg.	FP-8929671A	.254MM	
6	Plain Main Brg.	FP-8929672A	.508MM	
6	Plain Main Brg.	FP-8929673A	.762MM	
1	Flanged Main Brg.	FP-8929680	STD	
1	Flanged Main Brg.	FP-8929681	.254MM	
1	Flanged Main Brg.	FP-8929682	.508MM	
1	Flanged Main Brg.	FP-8929683	.762MM	
1	Lower End Bearing Kit	FP-23531604		Incl. 1.7100" or 43.430MM O.A.L. rod bearings; Incl. Rod & Main bearings, Thrust Washers, Lower Gaskets, Exc. Oil Pan

(continued on next page)

Multi-Purpose Engines Series 60 Eng. (12.7L) 8
12.7L 774 SOHC Turbo-Diesel L6 (24 Valve), 130mm Bore (cont.)

CRANKSHAFT/OIL PUMP (cont.)

QTY	MAIN BEARINGS (cont.)	PART NO.	SIZE	DESCRIPTION
1	Lower End Bearing Kit	FP-23531605		Incl. 1.8670" or 47.430MM O.A.L. rod bearings
2	Thrust Washer	FP-8929697	.127MM	Position Upper; .127MM oversize
2	Thrust Washer	FP-8929698	.254MM	Position Upper; .254MM oversize
QTY	OIL PUMP	PART NO.	SIZE	DESCRIPTION
1	Lo Pressure Regulator Valve	FP-8922740		
1	Bushing	FP-5127978		Oil pump
1	Bushing	FP-23505879		Oil pump; 25MM Bore, 22.27MM Shaft, 11.5MM Length
1	Oil Pump Spring	FP-5126327		Outlet bypass valve; .790" Dia., 2.96" Length
1	Bolt	FP-11504822		Inlet tube; M8 x 1.25 x 30MM
4	Bolt	FP-11504822		Outlet pipe; M8 x 1.25 x 30MM
2	Bolt	FP-11504822		Pressure regulator; M8 x 1.25 x 30MM
2	Bolt	FP-11504822		Pressure relief vlv.; M8 x 1.25 x 30MM
1	Bolt	FP-11504822		Screen bracket; M8 x 1.25 x 30MM
1	Oil Pump Intake Gasket	FP-8929344		Pump to block
1	Oil Pump Outlet Gasket	FP-8929347		
1	Rect. or Square Seal	FP-5141452		Gear Case Cover
1	Rect. or Square Seal	FP-8929341		Oil filter
1	Rect. or Square Seal	FP-8929340		Oil filter bypass
1	Oil Inlet Elbow Gasket	FP-23505992		Inlet tube to pump
1	Lo Press. Reg. Body Gasket	FP-5117269		
1	Gasket	FP-8929302		Fill tube adapter
1	Gasket	FP-8929302		Oil filter cover
1	Oil Filter Seal Ring	FP-8929342		Oil filter adapter
1	Pipe Plug	FP-23511574		Oil drain; 1/2" pipe thread; w/1" Square head

CYLINDER COMPONENTS

QTY	LINERS	PART NO.	SIZE	DESCRIPTION
6	Liner w/o Sealing Rings	FP-23532361		Engs. w/Standard liner
6	Liner w/Sealing Rings	FP-23532468		FP-23532361 liner incl.
6	Liner w/Sealing Rings	FP-23531249		FP-23534264 liner incl.
6	Cylinder Kit Complete	FP-23532561	STD	Articulated piston design; 15.0:1 C.R.; Heavy pin; To Sept. 2002
6	Cylinder Kit Complete	FP-23532883	STD	Articulated piston design; 15.0:1 C.R.; Light pin; To Sept. 2002; 26MM Pin ID
6	Cylinder Kit Complete	FP-23532554	STD	Articulated piston design; 16.5:1 C.R.; Heavy pin; From Sept. 2002
6	Cylinder Kit Complete	FP-23537594	STD	Articulated piston design; 16.5:1 C.R.; Light pin; From Sept. 2002
6	Cylinder Kit Complete	FP-23532590	STD	Engs. w/Standard liner; 2.50MM top ring; Round piston design
6	Cylinder Kit Complete	FP-23532591	STD	Engs. w/Standard liner; 3.50MM top ring
6	Cylinder Kit Complete	FP-23519637	STD	Engs. w/Standard liner; 3.50MM top ring; When depleted use FP-23532591
6	Cylinder Kit Complete	FP-23532558	STD	Engs. w/Top Liner Cooling (TLC); 2.50MM top ring; Domed piston design
6	Cylinder Kit Complete	FP-23532557	STD	Engs. w/Top Liner Cooling (TLC); 2.50MM top ring; Oval piston design
6	Cylinder Kit Complete	FP-23532555	STD	Engs. w/Top Liner Cooling (TLC); 2.50MM top ring; Round piston design
6	Cylinder Kit Complete	FP-23532556	STD	Engs. w/Top Liner Cooling (TLC); 3.50MM top ring
6	Sealing Ring, Liner	FP-8929013		Crevice seal
12	Sealing Ring, Liner	FP-8929176		D-ring seal
6	Flange Shim	FP-20044	31	.031" Thick
6	Flange Shim	FP-20045	62	.062" Thick
6	Cntr. Bore Insert	FP-23525500		Upper bore repair bushing to repair block deck
6	Lower Block Bore Sleeve	FP-20042		

QTY	PISTONS	PART NO.	SIZE	DESCRIPTION
6	Piston Kit w/Pin & Retainers	FP-23524601	STD	Engs. w/Domed piston & 2.50MM top ring
6	Piston Kit w/Pin & Retainers	FP-23519646	STD	Engs. w/Top Liner Cooling (TLC) & 2.50MM top ring; Oval piston design
6	Piston Kit w/Pin & Retainers	FP-23519624	STD	Engs. w/Top Liner Cooling (TLC) & 2.50MM top ring; Round piston design
6	Piston Kit w/Pin & Retainers	FP-23519635	STD	Engs. w/3.50MM top ring
6	Piston Skirt	FP-23521802		Aluminum skirt for forged steel crown articulated piston
6	Piston Skirt	FP-23516681		Ductile iron for standard cross head piston
6	Pin	FP-23525168		Hollow pin w/0.866" (22MM) I.D.; Articulated piston; Heavy pin
6	Pin	FP-23521649		Hollow pin w/1.020" (26MM) I.D.; Articulated piston
6	Pin	FP-8929087		Use w/Cross Head pistons
12	Piston Pin Retainer	FP-23521781		Use w/Articulated pistons
12	Piston Pin Bolt	FP-8929337		
12	Piston Pin Bolt Spacer	FP-8929504		
6	Piston Cooling Nozzle	FP-23528493		Use w/Articulated pistons

(continued on next page)

8 Multi-Purpose Engines Series 60 Eng. (12.7L) (cont.) 12.7L 774 SOHC Turbo-Diesel L6 (24 Valve), 130mm Bore

CYLINDER COMPONENTS (cont.)							
QTY	PISTONS (cont.)		PART NO.	SIZE	DESCRIPTION		
6	Bolt		FP-23506222		Use w/Articulated pistons; M8 - 1.25" x 20, 12 point		
6	Pin Bushing		FP-4774Y				
QTY	CONNECTING RODS & BRGS.		PART NO.	SIZE	DESCRIPTION		
12	Con. Rod Bolt		FP-8929355		M14 x 1.5" x 108		
12	Con. Rod Nut		FP-8929019		M14 x 1.5		
6	Rod Pair		FP-23526142	STD	Engs. w/Articulated pistons; Drilled upper & lower		
6	Rod Pair		FP-23527065 *	.254MM	Engs. w/Articulated pistons; Drilled upper & lower		
6	Rod Pair		FP-23527066 *	.508MM	Engs. w/Articulated pistons; Drilled upper & lower		
6	Rod Pair		FP-23527067 *	.762MM	Engs. w/Articulated pistons; Drilled upper & lower		
6	Rod Pair		FP-4770P		O.A.L. 1.710" or 43.430MM		
6	Rod Pair		4770P + Std-.25MM		O.A.L. 1.710" or 43.430MM; When depleted use FP-4770P		
6	Rod Pair		FP-8929710	STD	O.A.L. 1.7100" or 43.430MM		
6	Rod Pair		FP-8929711	.254MM	O.A.L. 1.7100" or 43.430MM		
6	Rod Pair		FP-8929712	.508MM	O.A.L. 1.7100" or 43.430MM		
6	Rod Pair		FP-8929713	.762MM	O.A.L. 1.7100" or 43.430MM		
6	Rod Pair		FP-23515581	STD	O.A.L. 1.8670" or 47.430MM		
6	Rod Pair		FP-23515582	.254MM	O.A.L. 1.8670" or 47.430MM		
6	Rod Pair		FP-23515583	.508MM	O.A.L. 1.8670" or 47.430MM		
6	Rod Pair		FP-23515584	.762MM	O.A.L. 1.8670" or 47.430MM		
QTY	PISTON RINGS		PART NO.	SIZE	DESCRIPTION		
6	Ring Set Single Cylinder		FP-23503747		2.50MM top ring; Cross Head & Articulated pistons		
6	Ring Set Single Cylinder		FP-23505729		3.50MM top ring; Cross Head pistons only		
6	Compression Ring		FP-8929845		Intermediate		
6	Compression Ring		FP-8929844		Top; 2.50MM		
6	Compression Ring		FP-23504941		Top; 3.50MM		
6	Oil Ring		FP-23515500				
6	Oil Ring Expander		FP-23529379				
CLUTCH							
QTY	CLUTCH		PART NO.	SIZE	DESCRIPTION		
1	Ball Brg.		FP-23503707		Clutch Pilot		
KITS							
RE-RING KIT		RE-RING KIT		QTY	PREMIUM KIT NO.	QTY	ECONOMY KIT NO.
YEARS	DESCRIPTION						
	In-Frame Kit		Re-ring w/Mains		1	FP-S60IFKRR	----
	Overhaul Kit		Re-ring w/Mains		1	FP-S60OHRR	----
QTY	OVERHAUL KIT		PART NO.	SIZE	DESCRIPTION		
1	In-Frame Overhaul Kit		FP-IFKS60SPREM		Articulated pistons		
1	In-Frame Overhaul Kit		FP-S60		Cross Head pistons		
1	In-Frame Overhaul Kit		FP-S60TLC		Cross Head pistons		
1	Complete Overhaul Kit		FP-OHS60SPREM		Articulated pistons		
1	Complete Overhaul Kit		FP-S60OH		Cross Head pistons		
1	Complete Overhaul Kit		FP-S60TLCOH		Cross Head pistons		
9 Multi-Purpose Engines Series 60 Eng. (14.0L) 14.0L 858 SOHC Turbo-Diesel L6 (24 Valve), 133mm Bore							
CYL. HEAD & PARTS							
QTY	GASKETS		PART NO.	SIZE	DESCRIPTION		
1	Valve Cover Gasket		FP-23511991		Lower to upper rocker cover gskt.; 106.68" circumference; Diamond shaped 0.186" thick; For 2 piece cover		
1	Valve Cover Gasket		FP-23522269		New design rocker cover; Black polyacrylate		
1	Head Gasket		FP-23530421		Blue Seal® Gasket Design		
1	Head Gasket		FP-23538406		ML7™ head gasket design		
1	Head Set		FP-23532333		Incl. Blue Seal® Gasket Design head gasket		
1	Head Set		FP-23536442		Incl. ML7™ head gasket		
QTY	HEAD BOLTS		PART NO.	SIZE	DESCRIPTION		
38	Head Bolt		FP-23530768		Head bolt washers		
38	Washer		FP-8929328				
QTY	MISCELLANEOUS		PART NO.	SIZE	DESCRIPTION		
2	Pipe Plug		FP-8923313		Cylinder head; 3/4"		
8	Bolt		FP-11504822		Rocker cover mntg.; M8 x 1.25 x 30MM		
QTY	FREEZE PLUGS		PART NO.	SIZE	DESCRIPTION		
2	Pipe Plug		FP-8923313		Cylinder head; 3/4"		

(continued on next page)

Multi-Purpose Engines Series 60 Eng. (14.0L) 9
14.0L 858 SOHC Turbo-Diesel L6 (24 Valve), 133mm Bore (cont.)

CYL. HEAD & PARTS (cont.)				
QTY	VALVE	PART NO.	SIZE	DESCRIPTION
12	Intake	FP-23529629		Included in FP-23501576 kit; 30 Deg. seat
12	Exhaust	FP-23524521		Included in FP-23507504 kit; EMS-247 Material; Chrome plated stem
12	Exhaust	FP-23529596		Use w/Monotherm or Monosteel piston applications; 30 Deg. seat; Pyromet 31, Chrome plated stem; 1.5530" Head Dia., .3430" Stem Dia., 8.4710" O.A.L.
12	Exhaust Valve Kit	FP-23507504		Identification H; Incl. FP-23524521 valve, valve seal, keeper & rotocap
12	Intake Valve Kit	FP-23501576		Incl. FP-23529629 valve, valve seal, keeper & rotocap
48	Keeper	FP-8929573		Exh. & Int.
QTY	VALVE SEAT	PART NO.	SIZE	DESCRIPTION
12	Exh.	FP-8929126		Std. Depth; 6.261MM - 6.363MM thick; 1.6285" OD, 1.3591" ID, .2485" Depth
12	Exh.	FP-8929630		U/S Depth; 5.499MM - 5.601MM thick; 1.6285" OD, 1.3591" ID, .2185" Depth
12	Exh.	FP-8929629		U/S Depth; 5.753MM - 5.855MM thick; 1.6285" OD, 1.3591" ID, .2285" Depth
12	Exh.	FP-8929628		U/S Depth; 6.007MM - 6.109MM thick; 1.6285" OD, 1.3591" ID, .2385" Depth
12	Int.	FP-8929127		Std. Depth; 7.155MM - 7.251MM thick; 1.8195" OD, 1.5710" ID, .2837" Depth
12	Int.	FP-8929627		U/S Depth; 6.393MM - 6.495MM thick; 1.8195" OD, 1.5710" ID, .2537" Depth
12	Int.	FP-8929626		U/S Depth; 6.647MM - 6.749MM thick; 1.8195" OD, 1.5710" ID, .2637" Depth
12	Int.	FP-8929625		U/S Depth; 6.901MM - 7.003MM thick; 1.8195" OD, 1.5710" ID, .2737" Depth
QTY	VALVE GUIDE	PART NO.	SIZE	DESCRIPTION
24	Guide	FP-23518571		Exh.; 14.30MM - 14.32MM Dia.
24	Guide	FP-23518572		Exh.; 14.43MM - 14.45MM Dia.
24	Guide	FP-23533552		Exh. & Int.; Powdered Metal replacement
QTY	VALVE SPRING	PART NO.	SIZE	DESCRIPTION
24	Spring	FP-8929415		Exh. & Int.; Yellow stripe
24	Valve Spring Seat	FP-8929076		Exh. & Int.; .087" - .094" (2.20MM - 2.40MM) Thick
QTY	VALVE MISC.	PART NO.	SIZE	DESCRIPTION
24	Rotocap	FP-8929105		Exh. & Int.
12	Adj. Screw	FP-23520818		Int. valve adjusting
QTY	VALVE SEAL	PART NO.	SIZE	DESCRIPTION
24	Valve Stem Seal	FP-23523930		Exh. & Int.
QTY	ROCKER PARTS	PART NO.	SIZE	DESCRIPTION
2	Expansion Plug	FP-9421745		Rocker Arm Shaft Plug; 1/2" Dia.
30	Nut	FP-23514371		Arm adj. screw; 3/8" - 24 UNF
2	O-Ring	FP-23521111		Rocker Arm stud seal
1	Oil Seal	FP-8929740		Rocker Arm shaft seal; .134" x .074" x .480"
CAMSHAFT GROUP				
QTY	CAMSHAFT/LIFTER	PART NO.	SIZE	DESCRIPTION
3	Bolt	FP-11504822		Balance shaft thrust plate; M8 x 1.25 x 30MM
1	O-Ring	FP-23528491		Thrust plate; Gear housing; w/3-Bolt plate
1	Oil Seal	FP-8929740		Cap bearing seal; .134" x .074" x .480"
2	Oil Seal	FP-23522975		Front cap seal
1	Oil Seal	FP-23521894		Thrust plate; Cylinder head
ACCESSORY DRIVE				
QTY	ACCESSORY DRIVE	PART NO.	SIZE	DESCRIPTION
1	Gasket	FP-8929130		Upper right rear & cam access cover
1	Gasket	FP-8929299		Acc. drive front
FUEL SYSTEM & PARTS				
QTY	FUEL INJECTION	PART NO.	SIZE	DESCRIPTION
6	Bolt	FP-8929393		Injector clamp
ENGINE BLOCK & PARTS				
QTY	GASKETS	PART NO.	SIZE	DESCRIPTION
1	Oil Pan Gasket	FP-8929102		Standard oil pan; Gray silicone
1	Oil Pan Gasket	FP-23522279		Use for oil pan w/o cord modified seal system
10	Oil Pan Isolator Bushing	FP-23517242		
10	Bolt	FP-11504571		Oil pan

(continued on next page)

9 Multi-Purpose Engines Series 60 Eng. (14.0L) (cont.) 14.0L 858 SOHC Turbo-Diesel L6 (24 Valve), 133mm Bore				
ENGINE BLOCK & PARTS (cont.)				
QTY	GASKETS (cont.)	PART NO.	SIZE	DESCRIPTION
1	Copper Washer	FP-23513842		Oil gauge adapter
QTY	GASKET SETS	PART NO.	SIZE	DESCRIPTION
1	Complete Overhaul Gasket Set	FP-23532332		Incl. Blue Seal® Gasket Design head gasket
QTY	CAM BEARINGS	PART NO.	SIZE	DESCRIPTION
7	Cam Brg.	FP-8929690	STD	
7	Cam Brg.	FP-8929691	.254MM	
7	Cam Brg.	FP-8929692	.508MM	
7	Cam Brg.	FP-8929693	.762MM	
CRANKSHAFT/OIL PUMP				
QTY	CRANKSHAFT	PART NO.	SIZE	DESCRIPTION
1	Crankshaft	FP-23527225		12 Hole
1	Vibration Damper	FP-23525990		13.5" Dia., One-piece
QTY	SEALS - FRONT CRANK	PART NO.	SIZE	DESCRIPTION
1	Oil Seal Kit	FP-23518355		
QTY	SEALS - REAR CRANK	PART NO.	SIZE	DESCRIPTION
1	Oil Seal Kit	FP-23513578		Double lip wrap around
1	Oil Seal Kit	FP-23516969		PTFE lip; Also available as National No. 5424
QTY	MAIN BEARINGS	PART NO.	SIZE	DESCRIPTION
1	Main Set	FP-7363M	STD	
1	Main Set	FP-7363M254MM	.254MM	
1	Main Set	FP-7363M508MM	.508MM	
1	Main Set	FP-7363M762MM	.762MM	
6	Plain Main Brg.	FP-8929670A	STD	
6	Plain Main Brg.	FP-8929671A	.254MM	
6	Plain Main Brg.	FP-8929672A	.508MM	
6	Plain Main Brg.	FP-8929673A	.762MM	
7	Plain Main Brg.	FP-23533252	STD	Position Lower; Eng. w/machined notches in main bearing caps
7	Plain Main Brg.	FP-23533251	25MM	Position Lower; Eng. w/machined notches in main bearing caps
7	Plain Main Brg.	FP-23533250	50MM	Position Lower; Eng. w/machined notches in main bearing caps
6	Plain Main Brg.	FP-23533252	STD	Position Lower; Eng. w/o machined notches in main bearing caps
1	Plain Main Brg.	FP-23533263	STD	Position Lower; Eng. w/o machined notches in main bearing caps
6	Plain Main Brg.	FP-23533251	25MM	Position Lower; Eng. w/o machined notches in main bearing caps
1	Plain Main Brg.	FP-23533262	25MM	Position Lower; Eng. w/o machined notches in main bearing caps
6	Plain Main Brg.	FP-23533250	50MM	Position Lower; Eng. w/o machined notches in main bearing caps
1	Plain Main Brg.	FP-23533261	50MM	Position Lower; Eng. w/o machined notches in main bearing caps
7	Plain Main Brg.	FP-23533259	STD	Position Upper; Eng. w/machined notches in main bearing caps
7	Plain Main Brg.	FP-23533258	25MM	Position Upper; Eng. w/machined notches in main bearing caps
7	Plain Main Brg.	FP-23533257	50MM	Position Upper; Eng. w/machined notches in main bearing caps
1	Plain Main Brg.	FP-23532926	STD	Position Upper; Eng. w/o machined notches in main bearing caps
7	Plain Main Brg.	FP-23533259	STD	Position Upper; Eng. w/o machined notches in main bearing caps
1	Plain Main Brg.	FP-23533255	25MM	Position Upper; Eng. w/o machined notches in main bearing caps
7	Plain Main Brg.	FP-23533258	25MM	Position Upper; Eng. w/o machined notches in main bearing caps
1	Plain Main Brg.	FP-23533254	50MM	Position Upper; Eng. w/o machined notches in main bearing caps
7	Plain Main Brg.	FP-23533257	50MM	Position Upper; Eng. w/o machined notches in main bearing caps
1	Flanged Main Brg.	FP-8929680	STD	
1	Flanged Main Brg.	FP-8929681	.254MM	
1	Flanged Main Brg.	FP-8929682	.508MM	
1	Flanged Main Brg.	FP-8929683	.762MM	
1	Lower End Bearing Kit	FP-23535280		Eng. w/machined notches in main bearing caps
1	Thrust Washer Set	FP-8929085S	STD	Position Front & Rear; Eng. w/o machined notches in main bearing caps
2	Thrust Washer	FP-23530554	STD	Position Front; Eng. w/machined notches in main bearing caps
4	Thrust Washer	FP-8929085	STD	Position Front & Rear; Eng. w/o machined notches in main bearing caps
2	Thrust Washer	FP-23530555	STD	Position Rear; Eng. w/machined notches in main bearing caps

(continued on next page)

Multi-Purpose Engines Series 60 Eng. (14.0L) 9
14.0L 858 SOHC Turbo-Diesel L6 (24 Valve), 133mm Bore (cont.)

CRANKSHAFT/OIL PUMP (cont.)

QTY	MAIN BEARINGS (cont.)	PART NO.	SIZE	DESCRIPTION
2	Thrust Washer	FP-8929697	.127MM	Position Upper; .127MM oversize
2	Thrust Washer	FP-8929698	.254MM	Position Upper; .254MM oversize

QTY	OIL PUMP	PART NO.	SIZE	DESCRIPTION
1	Gasket	FP-8929302		Dipstick adapter

CYLINDER COMPONENTS

QTY	LINERS	PART NO.	SIZE	DESCRIPTION
6	Liner w/Sealing Rings	FP-23531250	STD	
6	Cylinder Kit Complete	FP-23530661 *	STD	15.0:1 C.R.
6	Cylinder Kit Complete	FP-23530665 *	STD	16.0:1 C.R., Cutback piston design
6	Cylinder Kit Complete	FP-23530663 *	STD	16.0:1 C.R., Oval piston design
6	Cylinder Kit Complete	FP-23533452 *	STD	16.0:1 C.R., 3.0MM Top Ring; Marine applications
6	Sealing Ring, Liner	FP-8929013		Crevice seal
12	Sealing Ring, Liner	FP-8929176		D-ring seal
6	Cntr. Bore Insert	FP-23525500		Upper bore repair bushing to repair block deck

QTY	PISTONS	PART NO.	SIZE	DESCRIPTION
12	Piston Pin Retainer	FP-23521781		Use w/Steel pistons
6	Piston Cooling Nozzle	FP-23528493		Use w/Articulated pistons
6	Bolt	FP-23506222		Cooling nozzle mount; M8 - 1.25" x 20, 12 point

QTY	CONNECTING RODS & BRGS.	PART NO.	SIZE	DESCRIPTION
12	Con. Rod Nut	FP-8929019		M14 x 1.5
6	Rod Pair	FP-23526141	STD	w/Articulated Pistons; Drilled upper & lower
6	Rod Pair	FP-23533567 *	.254MM	w/Articulated Pistons; Drilled upper & lower
6	Rod Pair	FP-23533568 *	.508MM	w/Articulated Pistons; Drilled upper & lower

QTY	PISTON RINGS	PART NO.	SIZE	DESCRIPTION
6	Ring Set Single Cylinder	FP-23533510 *		Use w/15.0:1 C.R. Pistons
6	Ring Set Single Cylinder	FP-23531252 *		Use w/16.0:1 C.R. Pistons
6	Ring Set Single Cylinder	FP-23525573 *		Use w/16.75:1 C.R. Pistons

Engine Kit Bill of Material

Qty.	Part No.	Description	Qty.	Part No.	Description	Qty.	Part No.	Description	Qty.	Part No.	Description
FP-IFKDT466			FP-IFKDT4664R (cont'd.)			FP-IFKS50TLC			FP-OHS60SPREM (cont'd.)		
(6)	FP-1817189	Cylinder Kit Complete	(6)	FP-1808059	Connecting Rod Bearing Pair	(1)	FP-23511580	Oil Pan Gasket	(1)	FP-8929102	Oil Pan Gasket
(6)	FP-1817645	Cylinder Kit Complete	(6)	FP-1808060	Connecting Rod Bearing Pair	(4)	FP-23532555	Cylinder Kit Complete	FP-PK12667		
(6)	FP-687432	Cylinder Kit Complete	(6)	FP-1808061	Connecting Rod Bearing Pair	(4)	FP-23532556	Cylinder Kit Complete	(1)	FP-8921722S	Premium Piston Ring Set
(6)	FP-1808059	Connecting Rod Bearing Pair	(6)	FP-1808062	Connecting Rod Bearing Pair	(4)	FP-23532558	Cylinder Kit Complete	(8)	FP-PK8925818	Piston Kit w/Pin & Retainers
(6)	FP-1808060	Connecting Rod Bearing Pair	(6)	FP-1808062	Connecting Rod Bearing Pair	(4)	FP-23515581	Connecting Rod Bearing Pair	FP-PK22667		
(6)	FP-1808061	Connecting Rod Bearing Pair	(6)	FP-681314	Connecting Rod Bearing Pair	(4)	FP-23515582	Connecting Rod Bearing Pair	(1)	FP-5099M	Main Bearing Set
(6)	FP-1808062	Connecting Rod Bearing Pair	(6)	FP-681315	Connecting Rod Bearing Pair	(4)	FP-23515583	Connecting Rod Bearing Pair	(1)	FP-8921722S	Premium Piston Ring Set
(6)	FP-681314	Connecting Rod Bearing Pair	(6)	FP-681316	Connecting Rod Bearing Pair	(4)	FP-23515584	Connecting Rod Bearing Pair	(8)	FP-PK8925818	Piston Kit w/Pin & Retainers
(6)	FP-681315	Connecting Rod Bearing Pair	(6)	FP-681316	Connecting Rod Bearing Pair	(4)	FP-8929710	Connecting Rod Bearing Pair	(8)	FP-8921714	Connecting Rod Bearing Pair
(6)	FP-681316	Connecting Rod Bearing Pair	(6)	FP-687382	Connecting Rod Bearing Pair	(4)	FP-8929711	Connecting Rod Bearing Pair	FP-S60		
(6)	FP-687382	Connecting Rod Bearing Pair	(1)	FP-1823843	Main Bearing Set	(4)	FP-8929712	Connecting Rod Bearing Pair	(1)	FP-23522279	Oil Pan Gasket
(1)	FP-1823843	Main Bearing Set	(1)	FP-1823844	Main Bearing Set	(4)	FP-8929712	Connecting Rod Bearing Pair	(1)	FP-8929102	Oil Pan Gasket
(1)	FP-1823844	Main Bearing Set	(1)	FP-1823845	Main Bearing Set	(4)	FP-8929713	Connecting Rod Bearing Pair	(6)	FP-23519637	Cylinder Kit Complete
(1)	FP-1823846	Main Bearing Set	(1)	FP-1823846	Main Bearing Set	(4)	FP-8929713	Connecting Rod Bearing Pair	(6)	FP-23532555	Cylinder Kit Complete
(1)	FP-1823847	Main Bearing Set	(1)	FP-1823847	Main Bearing Set	(1)	FP-8929680	Main Bearing, Flanged	(6)	FP-23532556	Cylinder Kit Complete
(1)	FP-1823848	Main Bearing Set	(1)	FP-1823848	Main Bearing Set	(1)	FP-8929681	Main Bearing, Flanged	(6)	FP-23532557	Cylinder Kit Complete
(1)	FP-1823849	Main Bearing Set	(1)	FP-1823849	Main Bearing Set	(1)	FP-8929682	Main Bearing, Flanged	(6)	FP-23532590	Cylinder Kit Complete
(1)	FP-1823850	Main Bearing Set	(1)	FP-1823850	Main Bearing Set	(1)	FP-8929683	Main Bearing, Flanged	(6)	FP-23532591	Cylinder Kit Complete
(1)	PGN466-IF	In-Frame Gasket Set	(1)	PGN466-IF	In-Frame Gasket Set	(4)	FP-8929670A	Main Bearing, Plain	(6)	FP-23515581	Connecting Rod Bearing Pair
FP-IFKDT466OH			FP-IFKDT4664ROH			FP-IFKS60SPREM			FP-S60IFKRR		
(6)	FP-1817189	Cylinder Kit Complete	(6)	FP-18103594R	Cylinder Kit Complete	(1)	FP-23522279	Oil Pan Gasket	(1)	FP-8929102	Oil Pan Gasket
(6)	FP-1817645	Cylinder Kit Complete	(6)	FP-1808059	Connecting Rod Bearing Pair	(1)	FP-8929102	Oil Pan Gasket	(6)	FP-8929712	Connecting Rod Bearing Pair
(6)	FP-687432	Cylinder Kit Complete	(6)	FP-1808060	Connecting Rod Bearing Pair	(6)	FP-23532554	Cylinder Kit Complete	(6)	FP-8929713	Connecting Rod Bearing Pair
(6)	FP-1808059	Connecting Rod Bearing Pair	(6)	FP-1808061	Connecting Rod Bearing Pair	(6)	FP-23532561	Cylinder Kit Complete	(1)	FP-8929680	Main Bearing, Flanged
(6)	FP-1808060	Connecting Rod Bearing Pair	(6)	FP-1808062	Connecting Rod Bearing Pair	(6)	FP-23532883	Cylinder Kit Complete	(1)	FP-8929681	Main Bearing, Flanged
(6)	FP-1808061	Connecting Rod Bearing Pair	(6)	FP-681314	Connecting Rod Bearing Pair	(7)	FP-23537594	Cylinder Kit Complete	(1)	FP-8929682	Main Bearing, Flanged
(6)	FP-1808062	Connecting Rod Bearing Pair	(6)	FP-681315	Connecting Rod Bearing Pair	(6)	FP-8929690	Camshaft Bearing	(1)	FP-8929683	Main Bearing, Flanged
(6)	FP-681314	Connecting Rod Bearing Pair	(6)	FP-681316	Connecting Rod Bearing Pair	(6)	FP-8929690	Connecting Rod Bearing Pair	(1)	FP-8929670A	Main Bearing, Plain
(6)	FP-681315	Connecting Rod Bearing Pair	(6)	FP-687382	Connecting Rod Bearing Pair	(1)	FP-8929680	Main Bearing, Flanged	(6)	FP-8929671A	Main Bearing, Plain
(6)	FP-681316	Connecting Rod Bearing Pair	(1)	FP-1823843	Main Bearing Set	(1)	FP-8929681	Main Bearing, Flanged	(6)	FP-8929672A	Main Bearing, Plain
(6)	FP-687382	Connecting Rod Bearing Pair	(1)	FP-1823844	Main Bearing Set	(1)	FP-8929682	Main Bearing, Flanged	(6)	FP-8929673A	Main Bearing, Plain
(1)	FP-1823843	Main Bearing Set	(1)	FP-1823845	Main Bearing Set	(1)	FP-8929683	Main Bearing, Flanged	(2)	FP-8929085	Thrust Washer
(1)	FP-1823844	Main Bearing Set	(1)	FP-1823846	Main Bearing Set	(1)	FP-8929670A	Main Bearing, Plain	(6)	FP-8929697	Thrust Washer
(1)	FP-1823845	Main Bearing Set	(1)	FP-1823847	Main Bearing Set	(6)	FP-8929671A	Main Bearing, Plain	(2)	FP-8929698	Thrust Washer
(1)	FP-1823846	Main Bearing Set	(1)	FP-1823848	Main Bearing Set	(6)	FP-8929672A	Main Bearing, Plain	(1)	FP-23532333	Head Gasket Set
(1)	FP-1823847	Main Bearing Set	(1)	FP-1823849	Main Bearing Set	(6)	FP-8929673A	Main Bearing, Plain	(6)	FP-23515582	Connecting Rod Bearing Pair
(1)	FP-1823848	Main Bearing Set	(1)	FP-1823850	Main Bearing Set	(2)	FP-8929085	Thrust Washer	(6)	FP-23515583	Connecting Rod Bearing Pair
(1)	FP-1823849	Main Bearing Set	(1)	PGN466C	Complete Overhaul Gasket Set	(2)	FP-8929697	Thrust Washer	(6)	FP-23515584	Connecting Rod Bearing Pair
(1)	FP-1823850	Main Bearing Set	FP-IFKS50SPREM			(2)	FP-8929698	Thrust Washer	(1)	FP-23532333	Head Gasket Set
(1)	PGN466C	Complete Overhaul Gasket Set	(1)	FP-23511580	Oil Pan Gasket	(1)	FP-23532333	Head Gasket Set	(6)	FP-23515581	Connecting Rod Bearing Pair
FP-IFKDT466PNGD			(4)	FP-23532554	Cylinder Kit Complete	(38)	FP-23530768	Cylinder Head Bolt	(6)	FP-23515582	Connecting Rod Bearing Pair
(6)	FP-1822340	Cylinder Kit Complete	(4)	FP-23532561	Cylinder Kit Complete	(2)	FP-8929878	Thermostat	(6)	FP-23515583	Connecting Rod Bearing Pair
(6)	FP-1824820	Cylinder Kit Complete	(5)	FP-8929690	Camshaft Bearing	FP-OHS60SPREM			(6)	FP-23515584	Connecting Rod Bearing Pair
(6)	FP-1822389	Connecting Rod Bearing Pair	(4)	FP-23515581	Connecting Rod Bearing Pair	(6)	FP-23532554	Cylinder Kit Complete	(1)	FP-23532333	Head Gasket Set
(6)	FP-1822486	Connecting Rod Bearing Pair	(4)	FP-23515582	Connecting Rod Bearing Pair	(6)	FP-23532561	Cylinder Kit Complete	(1)	FP-8929680	Main Bearing, Flanged
(6)	FP-1822487	Connecting Rod Bearing Pair	(4)	FP-23515583	Connecting Rod Bearing Pair	(6)	FP-23532883	Cylinder Kit Complete	(1)	FP-8929681	Main Bearing, Flanged
(1)	FP-1822379	Main Bearing, Flanged	(4)	FP-23515584	Connecting Rod Bearing Pair	(6)	FP-23537594	Cylinder Kit Complete	(1)	FP-8929682	Main Bearing, Flanged
(1)	FP-1822494	Main Bearing, Flanged	(4)	FP-23526142	Connecting Rod Bearing Pair	(6)	FP-23526142	Connecting Rod Bearing Pair	(1)	FP-8929683	Main Bearing, Flanged
(1)	FP-1822495	Main Bearing, Flanged	(4)	FP-8929680	Main Bearing, Flanged	(1)	FP-8929680	Main Bearing, Flanged	(1)	FP-8929670A	Main Bearing, Plain
(1)	FP-1822496	Main Bearing, Flanged	(1)	FP-8929681	Main Bearing, Flanged	(1)	FP-8929681	Main Bearing, Flanged	(6)	FP-8929671A	Main Bearing, Plain
(6)	FP-1822321	Main Bearing, Plain	(1)	FP-8929682	Main Bearing, Flanged	(6)	FP-8929682	Main Bearing, Flanged	(6)	FP-8929672A	Main Bearing, Plain
(6)	FP-1822490	Main Bearing, Plain	(4)	FP-8929683	Main Bearing, Flanged	(6)	FP-8929670A	Main Bearing, Plain	(6)	FP-8929673A	Main Bearing, Plain
(6)	FP-1822491	Main Bearing, Plain	(4)	FP-8929670A	Main Bearing, Plain	(6)	FP-8929671A	Main Bearing, Plain	(2)	FP-23521781	Piston Pin Retainer
(6)	FP-1822492	Main Bearing, Plain	(4)	FP-8929671A	Main Bearing, Plain	(6)	FP-8929672A	Main Bearing, Plain	(6)	FP-23521802	Piston Skirt
(1)	PGN466NGD-IF	In-Frame Gasket Set	(4)	FP-8929672A	Main Bearing, Plain	(2)	FP-8929673A	Main Bearing, Plain	(6)	FP-23503747	Ring Set, Single Cylinder
(1)	FP-1816722	Miscellaneous Gasket	(4)	FP-8929673A	Main Bearing, Plain	(2)	FP-8929085	Thrust Washer	(6)	FP-23531249	Liner w/Sealing Rings
FP-IFKDT4664R			(2)	FP-8929085	Thrust Washer	(2)	FP-8929697	Thrust Washer	(2)	FP-8929085	Thrust Washer
(6)	FP-18103594R	Cylinder Kit Complete	(2)	FP-8929697	Thrust Washer	(7)	FP-8929690	Camshaft Bearing	FP-S60OH		
(cont'd. next column)			(2)	FP-8929698	Thrust Washer	(1)	FP-23532332	Complete Overhaul Gasket Set	(6)	FP-23519637	Cylinder Kit Complete
FP-IFKDT4664R			(1)	FP-23532330	Head Gasket Set	(38)	FP-23530768	Cylinder Head Bolt	(6)	FP-23532555	Cylinder Kit Complete
(cont'd. next column)			(26)	FP-23530768	Cylinder Head Bolt	(2)	FP-8929878	Thermostat	(6)	FP-23532556	Cylinder Kit Complete
FP-IFKDT4664R			(cont'd. next column)			FP-OHS60SPREM			(6)	FP-23532557	Cylinder Kit Complete
(cont'd. next column)			(cont'd. next column)			(1)	FP-23522279	Oil Pan Gasket	(6)	FP-23532590	Cylinder Kit Complete
FP-IFKDT4664R			(cont'd. next column)			FP-OHS60SPREM			(cont'd. next page)		
(cont'd. next column)			(cont'd. next column)			FP-OHS60SPREM			(cont'd. next page)		

Engine Kit Bill of Material

Qty.	Part No.	Description	Qty.	Part No.	Description	Qty.	Part No.	Description	Qty.	Part No.	Description
FP-S60OH (cont'd.)			FP-S60TLC (cont'd.)			FP-82NAOH (cont'd.)			PK2-2666		
(6)	FP-23532591	Cylinder Kit Complete	(1)	FP-8929682	Main Bearing, Flanged	(8)	FP-8923779	Ring Set, Single Cylinder	(1)	FP-8921721S	Premium Piston Ring Set
(6)	FP-23515581	Connecting Rod Bearing Pair	(1)	FP-8929683	Main Bearing, Flanged	(8)	FP-8923917	Ring Set, Single Cylinder	(8)	FP-8921714	Connecting Rod Bearing Pair
(6)	FP-23515582	Connecting Rod Bearing Pair	(6)	FP-8929670A	Main Bearing, Plain	(8)	FP-8923919	Ring Set, Single Cylinder	(1)	FP-5099M	Main Bearing Set
(6)	FP-23515583	Connecting Rod Bearing Pair	(6)	FP-8929671A	Main Bearing, Plain	(8)	FP-8925717	Piston Pin	(8)	FP-PK8921605	Piston Kit w/Pin & Retainers
(6)	FP-23515584	Connecting Rod Bearing Pair	(6)	FP-8929672A	Main Bearing, Plain	(8)	FP-8921714	Connecting Rod Bearing Pair			
(6)	FP-8929710	Connecting Rod Bearing Pair	(6)	FP-8929673A	Main Bearing, Plain	(8)	FP-8924703	Connecting Rod Bearing Pair			
(6)	FP-8929711	Connecting Rod Bearing Pair	(2)	FP-8929085	Thrust Washer	(1)	FP-5099M	Main Bearing Set			
(6)	FP-8929712	Connecting Rod Bearing Pair	(2)	FP-8929697	Thrust Washer	(1)	FP-5099M25MM	Main Bearing Set			
(6)	FP-8929713	Connecting Rod Bearing Pair	(2)	FP-8929698	Thrust Washer	(1)	FP-5099M50MM	Main Bearing Set			
(1)	FP-8929680	Main Bearing, Flanged	(1)	FP-23532333	Head Gasket Set	(1)	FP-8924126	Complete Overhaul Gasket Set			
(1)	FP-8929681	Main Bearing, Flanged	FP-S60TLCOH			(1)	FP-892412610	Complete Overhaul Gasket Set			
(1)	FP-8929682	Main Bearing, Flanged	(6)	FP-23532555	Cylinder Kit Complete	(2)	FP-8920271	Valve Cover Gasket			
(1)	FP-8929683	Main Bearing, Flanged	(6)	FP-23532556	Cylinder Kit Complete	(2)	FP-8926675	Valve Cover Gasket			
(6)	FP-8929670A	Main Bearing, Plain	(6)	FP-23532557	Cylinder Kit Complete						
(6)	FP-8929671A	Main Bearing, Plain	(6)	FP-23532558	Cylinder Kit Complete						
(6)	FP-8929672A	Main Bearing, Plain	(6)	FP-23515581	Connecting Rod Bearing Pair						
(6)	FP-8929673A	Main Bearing, Plain	(6)	FP-23515582	Connecting Rod Bearing Pair						
(2)	FP-8929085	Thrust Washer	(6)	FP-23515583	Connecting Rod Bearing Pair						
(2)	FP-8929697	Thrust Washer	(6)	FP-23515584	Connecting Rod Bearing Pair						
(2)	FP-8929698	Thrust Washer	(6)	FP-8929710	Connecting Rod Bearing Pair						
(1)	FP-23532332	Complete Overhaul Gasket Set	(6)	FP-8929711	Connecting Rod Bearing Pair						
(1)	FP-23522279	Oil Pan Gasket	(6)	FP-8929712	Connecting Rod Bearing Pair						
(1)	FP-8929102	Oil Pan Gasket	(6)	FP-8929713	Connecting Rod Bearing Pair						
FP-S60OHRH			(1)	FP-8929680	Main Bearing, Flanged	FP-82T			PK2-2667		
(1)	FP-8929102	Oil Pan Gasket	(1)	FP-8929681	Main Bearing, Flanged	(1)	FP-5149728	Oil Pan Gasket Kit	(1)	FP-8921722S	Premium Piston Ring Set
(6)	FP-23515581	Connecting Rod Bearing Pair	(1)	FP-8929682	Main Bearing, Flanged	(8)	FP-8925816	Piston Body w/o Pin	(8)	FP-8921714	Connecting Rod Bearing Pair
(6)	FP-23515582	Connecting Rod Bearing Pair	(1)	FP-8929683	Main Bearing, Flanged	(8)	FP-8925817	Piston Body w/o Pin			
(6)	FP-23515583	Connecting Rod Bearing Pair	(6)	FP-8929670A	Main Bearing, Plain	(8)	FP-8925818	Piston Body w/o Pin			
(6)	FP-23515584	Connecting Rod Bearing Pair	(6)	FP-8929671A	Main Bearing, Plain	(8)	FP-8925819	Piston Body w/o Pin			
(1)	FP-8929680	Main Bearing, Flanged	(6)	FP-8929672A	Main Bearing, Plain	(8)	FP-8925820	Piston Body w/o Pin			
(1)	FP-8929681	Main Bearing, Flanged	(6)	FP-8929673A	Main Bearing, Plain	(8)	FP-8928521	Piston Body w/o Pin			
(1)	FP-8929682	Main Bearing, Flanged	(6)	FP-8929673A	Main Bearing, Plain	(8)	FP-8928521	Piston Body w/o Pin			
(1)	FP-8929683	Main Bearing, Flanged	(2)	FP-8929085	Thrust Washer	(8)	FP-8925717	Piston Pin			
(6)	FP-8929670A	Main Bearing, Plain	(2)	FP-8929697	Thrust Washer	(16)	FP-8922977	Piston Pin Retainer			
(6)	FP-8929671A	Main Bearing, Plain	(2)	FP-8929698	Thrust Washer	(8)	FP-8921722	Ring Set, Single Cylinder			
(6)	FP-8929672A	Main Bearing, Plain	(1)	FP-23532332	Complete Overhaul Gasket Set	(8)	FP-8921723	Ring Set, Single Cylinder			
(6)	FP-8929673A	Main Bearing, Plain	(1)	FP-23522279	Oil Pan Gasket	(8)	FP-8923780	Ring Set, Single Cylinder			
(1)	FP-23532332	Complete Overhaul Gasket Set	(1)	FP-8929102	Oil Pan Gasket	(8)	FP-8923918	Ring Set, Single Cylinder			
(2)	FP-23521781	Piston Pin Retainer	FP-82NA			(8)	FP-8923920	Ring Set, Single Cylinder			
(1)	FP-23521802	Piston Skirt	(1)	FP-5149728	Oil Pan Gasket Kit	(8)	FP-8923918	Ring Set, Single Cylinder			
(6)	FP-23503747	Ring Set, Single Cylinder	(8)	FP-8921605	Piston Body w/o Pin	(8)	FP-8924703	Connecting Rod Bearing Pair			
(6)	FP-23531249	Liner w/Sealing Rings	(8)	FP-8922234	Piston Body w/o Pin	(8)	FP-8924703	Connecting Rod Bearing Pair			
(2)	FP-8929085	Thrust Washer	(8)	FP-8922236	Piston Body w/o Pin	(16)	FP-8922977	Piston Pin Retainer			
(1)	55-403B	Prelube	(8)	FP-8922452	Piston Body w/o Pin	(8)	FP-8921722	Ring Set, Single Cylinder			
FP-S60TLC			(8)	FP-8922453	Piston Body w/o Pin	(8)	FP-89217230	Ring Set, Single Cylinder			
(1)	FP-23522279	Oil Pan Gasket	(8)	FP-8928520	Piston Body w/o Pin	(8)	FP-8923780	Ring Set, Single Cylinder			
(1)	FP-8929102	Oil Pan Gasket	(8)	FP-8925717	Piston Pin	(8)	FP-8923918	Ring Set, Single Cylinder			
(6)	FP-23532555	Cylinder Kit Complete	(16)	FP-8922977	Piston Pin Retainer	(8)	FP-8923920	Ring Set, Single Cylinder			
(6)	FP-23532556	Cylinder Kit Complete	(8)	FP-8921721	Ring Set, Single Cylinder	(8)	FP-8925717	Piston Pin			
(6)	FP-23532557	Cylinder Kit Complete	(8)	FP-8923779	Ring Set, Single Cylinder	(8)	FP-8921714	Connecting Rod Bearing Pair			
(6)	FP-23532558	Cylinder Kit Complete	(8)	FP-8923917	Ring Set, Single Cylinder	(8)	FP-8924703	Connecting Rod Bearing Pair			
(6)	FP-23515581	Connecting Rod Bearing Pair	(8)	FP-8923919	Ring Set, Single Cylinder	(1)	FP-5099M	Main Bearing Set			
(6)	FP-23515582	Connecting Rod Bearing Pair	(8)	FP-8921714	Connecting Rod Bearing Pair	(1)	FP-5099M25MM	Main Bearing Set			
(6)	FP-23515583	Connecting Rod Bearing Pair	(8)	FP-8924703	Connecting Rod Bearing Pair	(1)	FP-5099M50MM	Main Bearing Set			
(6)	FP-23515584	Connecting Rod Bearing Pair	(2)	FP-8924127	Head Gasket Set	(1)	FP-8924126	Complete Overhaul Gasket Set			
(6)	FP-8929710	Connecting Rod Bearing Pair	(2)	FP-892412710	Head Gasket Set	(1)	FP-892412610	Complete Overhaul Gasket Set			
(6)	FP-8929711	Connecting Rod Bearing Pair	(2)	FP-8920271	Valve Cover Gasket	(2)	FP-8920271	Valve Cover Gasket			
(6)	FP-8929712	Connecting Rod Bearing Pair	(2)	FP-8926675	Valve Cover Gasket						
(6)	FP-8929713	Connecting Rod Bearing Pair	FP-82NAOH			PK1-2666			PK1-2667		
(1)	FP-8929680	Main Bearing, Flanged	(8)	FP-8921605	Piston Body w/o Pin	(1)	FP-8921721S	Premium Piston Ring Set	(1)	FP-8921722S	Premium Piston Ring Set
(1)	FP-8929681	Main Bearing, Flanged	(8)	FP-8922234	Piston Body w/o Pin	(8)	FP-PK8921605	Piston Kit w/Pin & Retainers	(8)	FP-8921714	Connecting Rod Bearing Pair
(cont'd. next column)			(8)	FP-8922236	Piston Body w/o Pin				(8)	FP-8921714	Connecting Rod Bearing Pair
			(8)	FP-8922452	Piston Body w/o Pin	FP-82TOH			(1)	FP-5099M	Main Bearing Set
			(8)	FP-8922453	Piston Body w/o Pin	(8)	FP-8925816	Piston Body w/o Pin	(1)	FP-5099M25MM	Main Bearing Set
			(8)	FP-8922453	Piston Body w/o Pin	(8)	FP-8925818	Piston Body w/o Pin	(1)	FP-5099M50MM	Main Bearing Set
			(8)	FP-8928520	Piston Body w/o Pin	(8)	FP-8925819	Piston Body w/o Pin	(2)	FP-8924127	Head Gasket Set
			(16)	FP-8922977	Piston Pin Retainer	(8)	FP-8925820	Piston Body w/o Pin	(2)	FP-892412710	Head Gasket Set
			(8)	FP-8921721	Ring Set, Single Cylinder	(16)	FP-8922977	Piston Pin Retainer	(2)	FP-8920271	Valve Cover Gasket
			(8)	FP-8923779	Ring Set, Single Cylinder	(8)	FP-8921722	Ring Set, Single Cylinder	(2)	FP-8920271	Valve Cover Gasket
			(8)	FP-8923917	Ring Set, Single Cylinder	(8)	FP-89217230	Ring Set, Single Cylinder			
			(8)	FP-8923919	Ring Set, Single Cylinder	(8)	FP-8923780	Ring Set, Single Cylinder			
			(8)	FP-8921714	Connecting Rod Bearing Pair	(8)	FP-8923918	Ring Set, Single Cylinder			
			(8)	FP-8924703	Connecting Rod Bearing Pair	(8)	FP-8923920	Ring Set, Single Cylinder			
			(1)	FP-5099M	Main Bearing Set	(8)	FP-8925717	Piston Pin			
			(1)	FP-5099M25MM	Main Bearing Set	(8)	FP-8921714	Connecting Rod Bearing Pair			
			(1)	FP-5099M50MM	Main Bearing Set	(8)	FP-8924703	Connecting Rod Bearing Pair			
			(2)	FP-8924127	Head Gasket Set	(1)	FP-5099M	Main Bearing Set			
			(2)	FP-892412710	Head Gasket Set	(1)	FP-5099M25MM	Main Bearing Set			
			(2)	FP-8920271	Valve Cover Gasket	(1)	FP-5099M50MM	Main Bearing Set			
			(2)	FP-8926675	Valve Cover Gasket	(1)	FP-8924126	Complete Overhaul Gasket Set			
			(cont'd. next column)			PK1-2666			PK1-2667		
			(8)	FP-8921605	Piston Body w/o Pin	(1)	FP-8921721S	Premium Piston Ring Set	(1)	FP-8921722S	Premium Piston Ring Set
			(8)	FP-8922234	Piston Body w/o Pin	(8)	FP-PK8921605	Piston Kit w/Pin & Retainers	(8)	FP-8921714	Connecting Rod Bearing Pair
			(8)	FP-8922236	Piston Body w/o Pin	PK1-2667			(1)	FP-5099M	Main Bearing Set
			(8)	FP-8922452	Piston Body w/o Pin	(1)	FP-8921722S	Premium Piston Ring Set	(8)	FP-PK8925818	Piston Kit w/Pin & Retainers
			(8)	FP-8922453	Piston Body w/o Pin	(8)	FP-8921722S	Premium Piston Ring Set			
			(8)	FP-8928520	Piston Body w/o Pin						
			(16)	FP-8922977	Piston Pin Retainer						
			(8)	FP-8921721	Ring Set, Single Cylinder						

Numerical List

Part No.	Line No.	Part No.	Line No.	Part No.	Line No.
FP-HBS001	5	FP-1824810	2	FP-23515145	5, 7, 8
FP-HBS002	7, 8	FP-1824810WP	2	FP-23515470	7, 8
FP-IFKDT466	2	FP-1824820	2	FP-23515500	5, 7, 8
FP-IFKDT466OH	2	FP-1824823	2	FP-23515581	5, 7, 8
FP-IFKDT466PNGD	2	FP-1824838	1, 2, 6	FP-23515582	5, 7, 8
FP-IFKDT4664R	2	FP-1824842	2	FP-23515583	5, 7, 8
FP-IFKDT4664ROH	2	FP-1825461	2, 6	FP-23515584	5, 7, 8
FP-IFKS50SPREM	5	FP-1825540	2	FP-23515597	7
FP-IFKS50TLC	5	FP-1842115	1, 6	FP-23515599	8
FP-IFKS60SPREM	8	FP-20042	5, 7, 8	FP-23516100	5
FP-OHS60SPREM	8	FP-20044	5, 7, 8	FP-23516322	7, 8
FP-PGE4126*	3, 4	FP-20045	5, 7, 8	FP-23516681	5, 7, 8
FP-PGE4126C10*	3, 4	FP-218211	1, 2, 6	FP-23516969	5, 7-9
FP-PGE4127IF*	3, 4	FP-23500462	3, 4	FP-23517242	5, 7-9
FP-PGE4127IF10*	3, 4	FP-23500463	3, 4	FP-23517875	5, 7, 8
FP-PGN466C*	2	FP-23500480	3, 4	FP-23517911	5, 7, 8
FP-PGN466IF*	2	FP-23501576	5, 7-9	FP-23517912	7, 8
FP-PK12667*	4	FP-23501577	7, 8	FP-23517973	5, 7, 8
FP-PK22667*	4	FP-23501580	5, 7, 8	FP-23518178	5, 7, 8
FP-PK8921605	3	FP-23502067	3, 4	FP-23518355	5, 7-9
FP-PK892160530	3	FP-23502068	3, 4	FP-23518571	5, 7-9
FP-PK8922452	3	FP-23502879	5, 7, 8	FP-23518572	5, 7-9
FP-PK8922453	3	FP-23503535	5, 7, 8	FP-23519624	5, 7, 8
FP-PK8925816	4	FP-23503704	5, 7, 8	FP-23519635	5, 7, 8
FP-PK8925817	4	FP-23503707	7, 8	FP-23519637	7, 8
FP-PK8925818	4	FP-23503709	4	FP-23519646	5, 7, 8
FP-PK892581830	4	FP-23503747	5, 7, 8	FP-23520377	5, 7, 8
FP-S60	7, 8	FP-23503825	5, 7, 8	FP-23520818	5, 7-9
FP-S60IFKRR	5, 7, 8	FP-23503827	5, 7, 8	FP-23520820	5, 7, 8
FP-S60OH	7, 8	FP-23504641	5	FP-23521111	5, 9
FP-S60OHR	5, 7, 8	FP-23504941	5, 7, 8	FP-23521649	8
FP-S60TLC	7, 8	FP-23505024	7, 8	FP-23521781	5, 8, 9
FP-S60TLCOH	7, 8	FP-23505048	5	FP-23521802	5, 8
FP-VG5079T	3, 4	FP-23505248	5, 7, 8	FP-23521894	5, 7-9
FP-103320	5	FP-23505249	5, 7, 8	FP-23521935	5, 7, 8
FP-103709	3, 4	FP-23505643	5, 7, 8	FP-23522269	7-9
FP-11504571	5, 7-9	FP-23505729	5, 7, 8	FP-23522279	7-9
FP-11504822	3-5, 7-9	FP-23505879	7, 8	FP-23522433	7, 8
FP-11509584	5, 7, 8	FP-23505892	5	FP-23522975	5, 7-9
FP-141195	3, 4	FP-23505896	5, 7, 8	FP-23523930	5, 7-9
FP-142583	3, 4	FP-23505902	5	FP-23524521*	5, 7-9
FP-147481	3, 4	FP-23505992	5, 7, 8	FP-23524601	5, 7, 8
FP-148402	3, 4	FP-23506153	7, 8	FP-23524657	5, 7, 8
FP-1810944	1, 2, 6	FP-23506222	5, 8, 9	FP-23525168	5, 8
FP-1811581	2	FP-23506244	3, 4	FP-23525179*	7, 8
FP-1815264	2	FP-23506247	5, 7, 8	FP-23525500	5, 7-9
FP-1815674	1, 2	FP-23506325	7, 8	FP-23525573*	9
FP-1816569	1	FP-23506350+	5, 7, 8	FP-23525990	5, 8, 9
FP-1816593	1, 2, 6	FP-23506545	5, 7, 8	FP-23526039*	5, 7, 8
FP-1817000+	1, 6	FP-23506546	5, 7, 8	FP-23526141	9
FP-1817247	1, 2	FP-23506549	5, 7, 8	FP-23526142	5, 8
FP-1817510	1, 6	FP-23506553	5, 7, 8	FP-23527065*	5, 8
FP-1817562	1, 2, 6	FP-23506556	5, 7, 8	FP-23527066*	5, 8
FP-1817633	1, 6	FP-23506560	5, 7, 8	FP-23527067*	5, 8
FP-1817687	1, 2, 6	FP-23506564	5, 7, 8	FP-23527225*	9
FP-1817867	1, 2, 6	FP-23507073	7, 8	FP-23528491	5, 7-9
FP-1818552	1, 2, 6	FP-23507238	3, 4	FP-23528493	5, 8, 9
FP-1818580	1, 2, 6	FP-23507438	5, 7, 8	FP-23529004*	7
FP-1818598	1, 2, 6	FP-23507504	5, 7-9	FP-23529379	5, 7, 8
FP-1818702	1, 2, 6	FP-23508392	5, 7, 8	FP-23529596*	5, 7-9
FP-1820264	1, 2, 6	FP-23509105	5, 7, 8	FP-23529629*	5, 7-9
FP-1822097	2	FP-23509203	5, 7, 8	FP-23530359	7, 8
FP-1822097WP	2	FP-23509204	5, 7, 8	FP-23530421	7-9
FP-1822120	1, 2, 6	FP-23511370	5	FP-23530554*	9
FP-1822321	1, 2, 6	FP-23511574	3-5, 7, 8	FP-23530555*	9
FP-1822322	1, 2, 6	FP-23511580	5	FP-23530661*	9
FP-1822340	2	FP-23511656	5	FP-23530663*	9
FP-1822379	1, 2, 6	FP-23511666	5, 7, 8	FP-23530665*	9
FP-1822389	1, 2, 6	FP-23511745	5, 7, 8	FP-23530768	5, 7-9
FP-1822486	1, 2, 6	FP-23511746	5, 7, 8	FP-23531249	5, 7, 8
FP-1822487	1, 2, 6	FP-23511747	7, 8	FP-23531250*	9
FP-1822490	1, 2, 6	FP-23511772	5	FP-23531252*	9
FP-1822491	1, 2, 6	FP-23511959	5, 7, 8	FP-23531306	5
FP-1822492	1, 2, 6	FP-23511964	5, 7, 8	FP-23531604	7, 8
FP-1822494	1, 2, 6	FP-23511991	7-9	FP-23531605	7, 8
FP-1822495	1, 2, 6	FP-23511992	7, 8	FP-23532330	5
FP-1822496	1, 2, 6	FP-23512048	5, 7, 8	FP-23532332	7-9
FP-1823930	2	FP-23512243	3-5	FP-23532333	7-9
FP-1824642	2	FP-23512254	5	FP-23532361	7, 8
FP-1824644	2	FP-23512307	5, 7, 8	FP-23532436	5, 7, 8
FP-1824646	2	FP-23513578	5, 7-9	FP-23532468	7, 8
FP-1824680	2, 6	FP-23513842	5, 7-9	FP-23532554	5, 8
FP-1824683	2, 6	FP-23514371	5, 7-9	FP-23532555	5, 7, 8

Numerical List

Part No.	Line No.	Part No.	Line No.	Part No.	Line No.
FP-23532556	5, 7, 8	FP-5161003	3, 4	FP-8920308	3, 4
FP-23532557	5, 7, 8	FP-5162888	4	FP-8920350	3, 4
FP-23532558	5, 7, 8	FP-5174286	3, 4	FP-8920390	3, 4
FP-23532561	5, 8	FP-5174971	3, 4	FP-8920399	3, 4
FP-23532590	7, 8	FP-5174973	3, 4	FP-8920462	3, 4
FP-23532591	7, 8	FP-5174975	3, 4	FP-8920478	3, 4
FP-23532883	8	FP-5176557	3, 4	FP-8920732	3, 4
FP-23532926*	9	FP-5177773	3, 4	FP-8920849	3, 4
FP-23533250*	9	FP-5178273	5	FP-8921033	3, 4
FP-23533251*	9	FP-5178581	3, 4	FP-8921253	3, 4
FP-23533252*	9	FP-5178700	3, 4	FP-8921294	3, 4
FP-23533254*	9	FP-5180539	3, 4	FP-8921347	3, 4
FP-23533255*	9	FP-5181747	3, 4	FP-8921605	3
FP-23533257*	9	FP-5182977	5	FP-892160530	3
FP-23533258*	9	FP-5183704	3, 4	FP-8921712	3, 4
FP-23533259*	9	FP-5184530	3, 4	FP-8921714	3, 4
FP-23533261*	9	FP-5186840	4, 5	FP-892171420	3, 4
FP-23533262*	9	FP-5193602	3, 4	FP-892171430	3, 4
FP-23533263*	9	FP-5195078	3, 4	FP-8921721	3
FP-23533452*	9	FP-5198558	3, 4	FP-8921721S	3
FP-23533510*	9	FP-5198936	4	FP-8921721S30	3
FP-23533552*	5, 7-9	FP-5199560	3, 4	FP-892172130	3
FP-23533567*	9	FP-5199561	3, 4	FP-8921722	4
FP-23533568*	9	FP-5199734	3, 4	FP-8921722S	4
FP-23535280*	9	FP-5199735	3, 4	FP-8921722S30	4
FP-23536442*	7-9	FP-5199914	3, 4	FP-892172230	4
FP-23537594	8	FP-5228596	3, 4	FP-8921817	3, 4
FP-23537789*	5, 7, 8	FP-5228694	3, 4	FP-8921876	3, 4
FP-23538406*	7-9	FP-5228766	3, 4	FP-8921883	3
FP-253660	1, 6	FP-5228769	3, 4	FP-8921930	5
FP-2602522*	3, 4	FP-5229720	3, 4	FP-8922093	3, 4
FP-3046745	3, 4	FP-5229726	3, 4	FP-8922110	3, 4
FP-457008	3, 4	FP-5229727	3, 4	FP-8922132	3, 4
FP-4770P*	7, 8	FP-5229840	3, 4	FP-8922200	3, 4
FP-4774Y*	5, 7, 8	FP-5229846	3, 4	FP-8922234	3
FP-5099M	3, 4	FP-5229850	3, 4	FP-8922236	3
FP-5099M25MM	3, 4	FP-5229930	3, 4	FP-8922299	3, 4
FP-5099M50MM	3, 4	FP-5234699	5, 7, 8	FP-8922349	3, 4
FP-5101691	3, 4	FP-5234702	5, 7, 8	FP-8922369	3, 4
FP-5101760	5, 7, 8	FP-5575086	3, 4	FP-8922383	5, 7, 8
FP-5102270	3, 4	FP-671559	2	FP-8922407	5, 7, 8
FP-5103646	5, 7, 8	FP-671563	2	FP-8922452	3
FP-5103951	7, 8	FP-675043	1, 2, 6	FP-8922453	3
FP-5103975	3, 4	FP-675046	2	FP-8922593	3, 4
FP-5104701	5	FP-675439	2	FP-8922740	5, 7, 8
FP-5108474	3, 4	FP-675442	1, 2, 6	FP-8922948	3, 4
FP-5110410	5	FP-675450	1, 2, 6	FP-8922977	3, 4
FP-5115214	3, 4	FP-675477	1, 2, 6	FP-8923090	3, 4
FP-5117193	3, 4	FP-675600	2	FP-8923151	3, 4
FP-5117269	5, 7, 8	FP-676865	2	FP-8923152	3, 4
FP-5117362	5, 7, 8	FP-677349	1, 2, 6	FP-8923184	4
FP-5121182	3, 4	FP-680117	1, 2, 6	FP-8923313	5, 7-9
FP-5121989	5, 7, 8	FP-682064	2	FP-8923522	5
FP-5122165	3, 4	FP-682810	1, 2, 6	FP-8923526	5, 7, 8
FP-5126327	5, 7, 8	FP-690437	1, 2, 6	FP-8923528	5, 7, 8
FP-5126473	3, 4	FP-7363M	7-9	FP-8923654	3, 4
FP-5127247	4	FP-7363M254MM	7-9	FP-8923655	3, 4
FP-5127978	5, 7, 8	FP-7363M508MM	7-9	FP-8923779	3
FP-5130995	3-5	FP-7363M762MM	7-9	FP-8923780	4
FP-5132155	5, 7, 8	FP-82NA	3	FP-8923813	3, 4
FP-5132715	5	FP-82NAOH	3	FP-8923814	3, 4
FP-5133981	5, 7, 8	FP-82T	4	FP-8923847	3-5
FP-5136240	3-5	FP-82TOH	4	FP-8923848	3, 4
FP-5136241	3, 4	FP-8547194	3, 4	FP-8923917	3
FP-5136590	3, 4	FP-8547625	7, 8	FP-8923918	4
FP-5136591	3, 4	FP-8547626	7, 8	FP-8923919	3
FP-5137618	5	FP-8920078	3, 4	FP-8923920	4
FP-5138643	7, 8	FP-8920083	3, 4	FP-8924126	3, 4
FP-5141452	5, 8	FP-8920087	3, 4	FP-8924126C	3, 4
FP-5141773	5, 7, 8	FP-8920091	3, 4	FP-8924126CB	3, 4
FP-5142549	3, 4	FP-8920119	3, 4	FP-8924126C10	3, 4
FP-5144178	3, 4	FP-8920144	3, 4	FP-8924126WS	3, 4
FP-5149540	4	FP-8920161	3, 4	FP-892412610	3, 4
FP-5149599	3, 4	FP-8920180	3, 4	FP-8924127	3, 4
FP-5149724	3, 4	FP-8920200	3, 4	FP-8924127MV	3, 4
FP-5149728	3, 4	FP-8920203	4	FP-8924127MVB	3, 4
FP-5150193	3-5, 7, 8	FP-8920219	3, 4	FP-8924127V	3, 4
FP-5151272	3, 4	FP-8920220	3, 4	FP-8924127VB	3, 4
FP-5151430	5	FP-8920246	3, 4	FP-892412710	3, 4
FP-5151487	3, 4	FP-8920247	3, 4	FP-8924380	3-5
FP-5152148	3, 4	FP-8920271	3, 4	FP-8924517	5, 7, 8
FP-5154216	3, 4	FP-8920273	3, 4	FP-8924703	3, 4
FP-5155596	5	FP-8920290	3, 4	FP-8924704	3, 4

Numerical List

Part No.	Line No.	Part No.	Line No.	Part No.	Line No.
FP-8924705	3, 4	FP-8929536	7		
FP-8924716	3, 4	FP-8929573	5, 7-9		
FP-8924813	3, 4	FP-8929589+	5, 7, 8		
FP-8925717	3, 4	FP-8929590	7, 8		
FP-8925816	4	FP-8929625	5, 7-9		
FP-8925817	4	FP-8929626	5, 7-9		
FP-8925818	4	FP-8929627	5, 7-9		
FP-892581830	4	FP-8929628	5, 7-9		
FP-8925819	4	FP-8929629	5, 7-9		
FP-8925820	4	FP-8929630	5, 7-9		
FP-8925981A	3, 4	FP-8929670A	5, 7-9		
FP-8926364	4	FP-8929671A	5, 7-9		
FP-8926365	3, 4	FP-8929672A	5, 7-9		
FP-8926675	3, 4	FP-8929673A	5, 7-9		
FP-8926761	3, 4	FP-8929680	5, 7-9		
FP-8926993	5, 7, 8	FP-8929681	5, 7-9		
FP-8927033	3, 4	FP-8929682	5, 7-9		
FP-8927214	3	FP-8929683	5, 7-9		
FP-8927408	3, 4	FP-8929690	5, 7-9		
FP-8927727	3, 4	FP-8929691	5, 7-9		
FP-8927784	3, 4	FP-8929692	5, 7-9		
FP-8927857	3, 4	FP-8929693	5, 7-9		
FP-8928520	3	FP-8929697	5, 7-9		
FP-8928521	4	FP-8929698	5, 7-9		
FP-8928670	3, 4	FP-8929710	5, 7, 8		
FP-8928671	3, 4	FP-8929711	5, 7, 8		
FP-8928672	3, 4	FP-8929712	5, 7, 8		
FP-8929013	5, 7-9	FP-8929713	5, 7, 8		
FP-8929015	5, 7, 8	FP-8929740	5, 7-9		
FP-8929019	5, 7-9	FP-8929787	5, 7, 8		
FP-8929022	5, 7, 8	FP-8929803	7, 8		
FP-8929059	7	FP-8929820	5, 7, 8		
FP-8929062	5, 7, 8	FP-8929844	5, 7, 8		
FP-8929063	5, 7, 8	FP-8929845	5, 7, 8		
FP-8929064	5, 7, 8	FP-8929875	5, 7, 8		
FP-8929076*	9	FP-8929878	5, 7, 8		
FP-8929085	5, 7, 9	FP-907394	5		
FP-8929085S	5, 7, 9	FP-9139809	4		
FP-8929087	5, 7, 8	FP-9411502	3-5, 7, 8		
FP-8929102	7-9	FP-9421745	9		
FP-8929105	5, 7-9	FP-9431894	3, 4		
FP-8929108	5, 7, 8	FP-9437108	3, 4		
FP-8929126	5, 7-9	PGE4126+	3, 4		
FP-8929127	5, 7-9	PGE4126C 10+	3, 4		
FP-8929130	5, 7-9	PGE4127-IF+	3, 4		
FP-8929134	5, 7, 8	PGE4127-IF 10+	3, 4		
FP-8929152	5, 7, 8	PGN466C+	2		
FP-8929154	5, 7, 8	PGN466-IF+	2		
FP-8929157	5, 7, 8	PK1-2666	3		
FP-8929158	7, 8	PK1-2667	4		
FP-8929176	5, 7-9	PK2-2666	3		
FP-8929213	5, 7, 8	PK2-2667	4		
FP-8929216	5, 7, 8	VG-5079T	4		
FP-8929239*	8	VK-115	4		
FP-8929253	5, 7, 8	VK-115B	3, 4		
FP-8929255	7, 8	VK-115R	3, 4		
FP-8929280	7, 8	VK-138	2		
FP-8929285	5, 7, 8	WE-499KC+	3		
FP-8929289	5, 7, 8	WE-500KC	4		
FP-8929299	5, 7-9	260-2522+	3, 4		
FP-8929302	5, 7-9	4458V	7, 8		
FP-8929328	5, 7-9	455956H	3, 4		
FP-8929334	7, 8	473476	3, 4		
FP-8929337	5, 7, 8	4770P+	7, 8		
FP-8929340	5, 7, 8	484156V	7, 8		
FP-8929341	5, 7, 8	5424	7, 8		
FP-8929342	7, 8	7363M+	7, 8		
FP-8929344	5, 7, 8	99133	7, 8		
FP-8929347	5, 7, 8	99250	3, 4		
FP-8929348	7, 8				
FP-8929355	5, 7, 8				
FP-8929357	5, 7, 8				
FP-8929393	5, 7-9				
FP-8929415	5, 7-9				
FP-8929422	5, 7, 8				
FP-8929425	5, 7, 8				
FP-8929427	5, 7, 8				
FP-8929479	5, 7, 8				
FP-8929480	5, 7, 8				
FP-8929504	5, 7, 8				
FP-8929510	7, 8				
FP-8929512	5, 7, 8				
FP-8929529	5, 7, 8				

Decimal Equivalents

8THS.	16THS.	32NDS.	64THS.	DECIMALS	mm
			1/64015625	.396875
		1/32	3/64031250	.793750
	1/16		5/64046875	1.190625
		3/32	7/64062500	1.587500
			9/64078125	1.984375
1/8		5/32	11/64093750	2.381250
	3/16		13/64109375	2.778125
		7/32	15/64125000	3.175000
			17/64140625	3.571875
		9/64	19/64156250	3.968750
	5/16		21/64171875	4.365625
		11/32	23/64187500	4.762500
			25/64203125	5.159375
1/4		13/32	27/64218750	5.556250
			29/64234375	5.953125
		15/32	31/64250000	6.350000
	5/16		33/64265625	6.746875
		9/32	35/64281250	7.143750
			37/64296875	7.540625
		19/64	39/64312500	7.937500
			41/64328125	8.334375
		11/32	43/64343750	8.731250
3/8			45/64359375	9.128125
		13/32	47/64375000	9.525000
			49/64390625	9.921875
	7/16	17/32	51/64406250	10.318750
			53/64421875	10.715625
		15/32	55/64437500	11.112500
			57/64453125	11.509375
		9/16	59/64468750	11.906250
			61/64484375	12.303125
		19/32	63/64500000	12.700000
1/2515625	13.096875
		17/32531250	13.493750
				.546875	13.890625
	9/16	35/64562500	14.287500
				.578125	14.684375
		37/64593750	15.081250
				.609375	15.478125
5/8		39/64625000	15.875000
				.640625	16.271875
		21/32656250	16.668750
				.671875	17.065625
	11/16	43/64687500	17.462500
				.703125	17.859375
		45/64718750	18.256250
				.734375	18.653125
3/4		23/32750000	19.050000
				.765625	19.446875
		47/64781250	19.843750
				.796875	20.240625
		49/64812500	20.637500
	13/16	51/64828125	21.034375
				.843750	21.431250
		27/32859375	21.828125
				.875000	22.225000
7/8		55/64890625	22.621875
				.906250	23.018750
		29/32921875	23.415625
				.937500	23.812500
	15/16	59/64953125	24.209375
				.968750	24.606250
		61/64984375	25.003125
1		31/32		1.000000	25.003125

Inches to Millimeters

.001	0.0254mm
.002	0.0508mm
.003	0.0762mm
.004	0.1016mm
.005	0.1270mm
.006	0.1524mm
.007	0.1778mm
.008	0.2032mm
.009	0.2286mm
.010	0.2540mm
.020	0.5080mm
.030	0.7620mm
.040	1.0160mm
.050	1.2700mm
.060	1.5240mm
.070	1.7780mm
.080	2.0320mm
.090	2.2860mm
.100	2.5400mm

Millimeters to Inches

0.025mm000984
0.050mm001968
0.075mm002952
0.100mm003937
0.125mm004921
0.150mm005905
0.175mm006889
0.200mm007874
0.225mm008858
0.250mm009842
0.500mm019685
0.750mm029527
1.000mm039370
1.250mm049212
1.500mm059055
1.750mm068897
2.000mm078740
2.250mm088582
2.500mm098425

Conversion Formulae

28.349 gm./oz.
453.592 gm./lb.

16.387 cc/in.³
61.024 in.³/L

3.785 L/U.S. gal.
4.546 L/Imp. gal.
0.264 U.S. gal./L
0.220 Imp. gal./L