

**CALIFORNIA
Proposition 65 Warning**

Diesel engine exhaust and some of its constituents are known to the State of California to cause cancer, birth defects, and other reproductive harm.

To the Operator

This guide contains instructions on the safe operation and preventive maintenance of your Detroit Diesel Series 60® engine used in vehicle, or fire fighting apparatus applications. Maintenance instructions cover routine engine services such as lube oil and filter changes in enough detail to permit self-servicing, if desired.

The operator should become familiar with the contents of this guide before operating the engine or carrying out maintenance procedures.

Power-driven equipment is only as safe as the person operating the controls. You are urged, as the operator of this diesel engine, to keep fingers and clothing away from the revolving belts, drive shafts, pulleys, etc. on the engine installation.

Throughout this guide **CAUTIONS** regarding personal safety and **NOTICES** regarding engine performance or service life will appear. To avoid personal injury and ensure long engine service life, always heed these instructions.

Whenever possible, it will benefit you to rely on an *authorized* Detroit Diesel service outlet for all your service needs from maintenance to major parts replacement. Authorized service outlets worldwide stock factory-original parts and have the specialized equipment and experienced, trained personnel to provide prompt preventive maintenance and skilled engine repairs.

The information and specifications in this publication are based on the information in effect at the time of approval for printing. Contact an authorized Detroit Diesel service outlet for information on the latest revision. The right is reserved to make changes at any time without obligation.

The Series 60 engine is built in accordance with sound technological principles and based on state-of-the-art technology.

Despite this, the engine may constitute a risk of damage to property or injury to persons if it is not used for its intended purpose.

The engine should not be modified or converted in an incorrect manner or the safety instructions included in this manual disregarded.

NOTICE:

Coolant must be inhibited with the recommended SCAs (supplemental coolant additives) listed in the **How To** section of this engine operator's guide. In addition, the engine can be equipped with a coolant filter/inhibitor system as an installed option or as an after-sale item. **Failure to check and maintain SCA levels at required concentrations will result in severe damage (corrosion) to the engine cooling system and related components.**

WARRANTY

The applicable engine warranty is contained in the booklet "Warranty Information for Series 60 Engines," available from authorized Detroit Diesel service outlets.

Keep this Operator's Guide with the engine installation at all times. It contains important operating, maintenance, and safety instructions.

Trademark Information

DDC®, Detroit Diesel®, DDEC®, Series 60®, Optimized Idle®, Diagnostic Link®, reliabilt®, *POWER Trac*®, *POWER COOL*®, and *POWER GUARD*® are registered trademarks of Detroit Diesel Corporation. Delco Remy® is a registered trademark of Delco Remy America, Inc. Bosch® is a registered trademark of Robert Bosch Company N.A. Fuel Pro®, and Mega Filter® are registered trademarks of Davco Manufacturing, L.L.C. Nexiq™ is a trademark of Nexiq Technologies, Inc. PowerBand® is a registered trademark of Gates Rubber Company. Tectyl® is a registered trademark of Daubert Chemical Company, Inc. Biobor® is a registered trademark of United States Borax and Chemical Corporation. DuPont® is a registered trademark of E.I. DuPont de Nemours and Company, Inc. All other trademarks used are the property of their respective owners.

TABLE OF CONTENTS

| | |
|---|----|
| INTRODUCTION | 1 |
| NON-GENUINE AND REBUILT COMPONENT QUALITY ALERT .. | 1 |
| PERSONNEL REQUIREMENTS | 2 |
| ENGINE CONVERSIONS AND MODIFICATIONS | 2 |
| CAUTION SUMMARY | 3 |
| ENGINE OPERATION | 3 |
| PREVENTIVE MAINTENANCE | 5 |
| ELECTRICAL SYSTEM | 8 |
| COOLING SYSTEM | 8 |
| AIR INTAKE SYSTEM | 9 |
| FUEL SYSTEM | 9 |
| COMPRESSED AIR | 10 |
| STARTING AIDS | 11 |
| LUBRICATING OIL AND FILTERS | 12 |
| AFTERTREATMENT SYSTEM | 12 |
| ENGINE IDENTIFICATION | 14 |
| ENGINE COMPONENTS | 14 |
| ENGINE MODEL AND SERIAL NUMBER DESIGNATION | 16 |
| CERTIFICATION LABEL | 17 |
| OPERATING INSTRUCTIONS FOR STARTING THE ENGINE | 18 |
| FIRST TIME START PREPARATION | 18 |
| SYSTEM CHECKS | 18 |
| COOLING SYSTEM CHECKS | 18 |
| LUBRICATION SYSTEM CHECKS | 19 |
| CHECKING THE OIL LEVEL | 19 |
| EXTENDED STORAGE | 20 |
| FUEL SYSTEM CHECKS | 20 |
| ADDING FUEL | 21 |
| PRIMING THE FUEL SYSTEM | 21 |
| OTHER CHECKS | 22 |
| STARTING THE ENGINE FOR THE FIRST TIME | 22 |
| ELECTRIC STARTER | 24 |

TABLE OF CONTENTS

| | |
|---|-----------|
| RUNNING THE ENGINE | 24 |
| OIL PRESSURE | 24 |
| WARM-UP | 25 |
| INSPECTION | 25 |
| TRANSMISSION | 25 |
| FLUID LEAKS | 25 |
| CRANKCASE | 25 |
| TURBOCHARGER | 25 |
| AVOID UNNECESSARY IDLING | 25 |
| STOPPING THE ENGINE | 26 |
| EMERGENCY JUMP STARTING | 26 |
| ROUTINE ENGINE START | 27 |
| STARTING THE ENGINE-ROUTINE | 27 |
| CHECKING THE COOLANT LEVEL (COLD CHECK) | 28 |
| CHECKING THE COOLANT LEVEL (HOT CHECK) | 29 |
| MONITORING ENGINE OPERATION | 29 |
| BATTERY CHARGE | 29 |
| OIL PRESSURE | 30 |
| EXCESSIVE IDLING | 30 |
| CHANGING THE IDLE SPEED | 30 |
| SHUTTING DOWN THE ENGINE | 30 |
| SHUTTING DOWN AFTER HIGH LOAD OPERATION | 31 |
| EMERGENCY RUNNING MODE | 31 |
| STOP ENGINE OVERRIDE OPTION | 31 |
| COLD WEATHER OPERATION | 32 |
| WINTER FRONTS | 32 |
| DDEC VI SYSTEM | 33 |
| MOTOR CONTROL MODULE | 33 |
| COMMON POWERTRAIN CONTROLLER | 34 |
| DDEC FEATURES | 35 |
| CRUISE CONTROL | 35 |
| DATA RECORDING CAPABILITY | 37 |
| ENGINE BRAKES | 37 |
| ENGINE PROTECTION | 38 |
| CALIFORNIA ENGINE IDLE LIMITING | 38 |
| IDLE SHUTDOWN TIMER | 39 |
| DDEC VI OPERATION | 39 |
| STOP ENGINE OVERRIDE SWITCH | 40 |

| | |
|---|-----------|
| IMMEDIATE SPEED REDUCTION | 41 |
| RED STOP LAMP | 41 |
| DIAGNOSTIC TOOL | 41 |
| FLASHING MALFUNCTION CODES | 41 |
| ACTIVE CODES | 43 |
| INACTIVE CODES | 43 |
| DDEC VI ENGINE DRIVING TIPS | 44 |
| ACCELERATING THE VEHICLE | 44 |
| CRUISE CONTROL | 44 |
| ENGINE BRAKES AND CRUISE CONTROL | 46 |
| SHIFTING | 46 |
| IDLING | 47 |
| ENGINE BRAKE SYSTEM | 48 |
| DRIVER CONTROL SWITCHES | 48 |
| LOW/HIGH SWITCH | 48 |
| LOW/MED/HIGH SWITCH | 48 |
| CLUTCH PEDAL AND THROTTLE POSITION CONTROLS | 48 |
| ENGINE BRAKE OPERATION | 48 |
| ANTI-LOCK BRAKING SYSTEMS | 49 |
| DRIVING ON FLAT, DRY PAVEMENT | 50 |
| DESCENDING A LONG, STEEP GRADE | 50 |
| DRIVING ON WET OR SLIPPERY PAVEMENT | 52 |
| ENGINE SYSTEMS | 53 |
| FUEL SYSTEM | 53 |
| LUBRICATION SYSTEM | 53 |
| AIR SYSTEM | 53 |
| COOLING SYSTEM | 53 |
| ELECTRICAL SYSTEM | 53 |
| EXHAUST SYSTEM | 53 |
| EXHAUST GAS RECIRCULATION SYSTEM | 53 |
| AFTERTREATMENT SYSTEM | 54 |
| OPERATING REQUIREMENTS | 55 |
| MAINTENANCE | 55 |
| PARKED REGENERATION PROCEDURE | 56 |
| HAZARDOUS APPLICATIONS | 57 |
| DPF STATIONARY REGEN ONLY = 0-DISABLED | 58 |

TABLE OF CONTENTS

DPF STATIONARY REGEN ONLY = 1-ENABLED 58
SERVICE RECORD 58

DRIVER ACTIONS 59

INSTRUMENT PANEL LAMPS 61

MAINTENANCE 63

 SCHEDULED INTERVALS 63

 PREVENTIVE MAINTENANCE INTERVALS 73

 ITEM 1 – LUBRICATING OIL 73

 ITEM 2 – FUEL AND FUEL TANK 75

 ITEM 3 – FUEL LINES, FLEXIBLE HOSES 76

 LEAKS 76

 HOSES AND FITTINGS 76

 HOSE SERVICE LIFE 76

 ITEM 4 – COOLING SYSTEM 77

 COOLANT LEVEL 77

 COOLANT INHIBITORS 77

 COOLANT DRAIN INTERVAL 77

 ITEM 5 – TURBOCHARGER, AIR-TO-AIR CHARGE COOLER 79

 WASTEGATED TURBOCHARGERS 79

 ITEM 6 – BATTERY 79

 ITEM 7 – AFTERTREATMENT SYSTEM 80

 ITEM 8 – DRIVE BELTS 80

 V-BELTS 81

 2-GROOVE POWERBAND 82

 12-RIB POLY-V BELT 82

 BELT REPLACEMENT 82

 ITEM 9 – AIR COMPRESSOR 83

 ITEM 10 – AIR CLEANER 83

 AIR CLEANER REPLACEMENT 83

 ITEM 11 – LUBRICATING OIL FILTERS 83

 ITEM 12 – FUEL FILTERS 84

 FUEL PRO® 382 FILTERS 84

 SPIN-ON FILTERS 85

 ITEM 13 – WATER PUMP AND COOLANT INHIBITOR
ELEMENT 85

 WATER PUMP DRAIN HOLE 85

| | |
|--|----|
| COOLANT INHIBITOR ELEMENT | 85 |
| ITEM 14 – CRANKING MOTOR | 86 |
| ITEM 15 – AIR SYSTEM | 86 |
| ITEM 16 – EXHAUST SYSTEM | 86 |
| ITEM 17 – ENGINE (STEAM CLEAN) | 86 |
| ITEM 18 – RADIATOR | 86 |
| ITEM 19 – OIL PRESSURE | 87 |
| ITEM 20 – BATTERY-CHARGING ALTERNATOR | 87 |
| BOSCH® T1 ALTERNATOR SERVICE REQUIREMENTS | 88 |
| GENERAL SERVICE REQUIREMENTS – BOSCH® AND DELCO REMY® ALTERNATORS | 88 |
| ITEM 21 – ENGINE AND TRANSMISSION MOUNTS | 88 |
| ITEM 22 – CRANKCASE PRESSURE | 88 |
| ITEM 23 – FAN HUB | 88 |
| ITEM 24 – THERMOSTATS AND SEALS | 88 |
| ITEM 25 – CRANKCASE BREATHER | 89 |
| ITEM 26 – ENGINE TUNE-UP | 89 |
| ITEM 27 – VIBRATION DAMPER | 90 |
| HOW-TO SECTION | 91 |
| HOW TO SELECT LUBRICATING OIL | 91 |
| LUBRICANT REQUIREMENTS | 91 |
| COLD WEATHER STARTING | 91 |
| SYNTHETIC OILS | 92 |
| THE USE OF SUPPLEMENTAL ADDITIVES | 92 |
| WHEN TO CHANGE OIL | 92 |
| DISPOSING OF WASTE OIL | 93 |
| HOW TO REPLACE THE LUBE OIL FILTERS | 94 |
| REPLACE SPIN-ON TYPE OIL FILTER | 94 |
| HOW TO SELECT DIESEL FUEL | 95 |
| QUALITY | 96 |
| FUEL CONTAMINATION | 96 |
| BIODIESEL | 96 |
| PROHIBITED ADDITIVES | 97 |
| USED LUBRICATING OIL | 97 |
| FUEL ADDITIVES WITH SULFUR OR SULFATED ASH | 97 |
| GASOLINE | 97 |
| HOW TO REPLACE THE FUEL FILTERS | 98 |

TABLE OF CONTENTS

REPLACE SPIN-ON TYPE PRIMARY OR SECONDARY FUEL
FILTER ELEMENTS 98
REPLACE FUEL/WATER SEPARATOR ELEMENT 100
REPLACE FUEL PRO® 382/382E FUEL FILTER ELEMENT 100
ENGINE OUT OF FUEL — HOW TO RESTART 103
 ENGINES WITH SPIN-ON FILTERS 103
 ENGINES WITH FUEL PRO FILTERS 103
HOW TO CLEAN THE ENGINE 104
 HIGH-PRESSURE CLEANING EQUIPMENT 104
HOW TO CLEAN THE COOLING SYSTEM 105
 DEGREASING 105
HOW TO SELECT COOLANT 106
 DEFINITIONS 106
 APPROVED COOLANTS 107
 EG & WATER PLUS SCA INHIBITOR OR P G & WATER
 PLUS SCA INHIBITOR 108
 MIXING EG OR PG ANTIFREEZE AND WATER 109
 RECYCLED ANTIFREEZE 109
 EG/WATER + OAT INHIBITOR OR PG/WATER + OAT
 INHIBITOR 110
 WATER ONLY + SCA OR WATER ONLY + OAT INHIBITOR 110
 WATER REQUIREMENTS 111
 COOLANTS NOT RECOMMENDED 112
 ALL ANTIFREEZES AND COOLANTS CONTAINING
 PHOSPHATE 112
 AUTOMOTIVE TYPE COOLANTS 112
 METHYL ALCOHOL-BASED ANTIFREEZE 112
 GLYCOL-BASED COOLANTS FORMULATED FOR HVAC ... 112
 ADDITIVES NOT RECOMMENDED 112
 SOLUBLE OIL ADDITIVES 112
 CHROMATE ADDITIVES 112
 COOLANT INHIBITOR TEST INTERVALS 113
 SUPPLEMENTAL COOLANT ADDITIVES FOR FULLY
 FORMULATED COOLANT 113
 MAINTENANCE INTERVALS 114
 SCA TEST PROCEDURES 115
 COOLANT FILTERS (NON-OAT SYSTEMS) 116
 DROPOUT 117

| | |
|--|-----|
| COOLANT EXTENDER INHIBITOR ADDITIVE FOR "OAT" | |
| COOLANT | 117 |
| OAT COOLANT DRAIN INTERVAL | 118 |
| CHRONIC COOLANT SYSTEM PROBLEMS | 118 |
| DETROIT DIESEL COOLING SYSTEM MAINTENANCE PRODUCTS | 118 |
| POWER COOL SCAS | 118 |
| POWER COOL COOLANT FILTER ELEMENTS | 118 |
| POWER COOL CLEANERS | 119 |
| SUMMARY OF COOLANT RECOMMENDATIONS | 119 |
| COOLANT LIFE OF GLYCOL COOLANT | 120 |
| COOLANT LIFE OF OAT COOLANT | 120 |
| COOLANT LIFE OF OTHER COOLANTS | 120 |
| HOW TO DRAIN AND FLUSH THE COOLING SYSTEM | 121 |
| HOSES | 122 |
| WHEN TO SERVICE THE DRY TYPE AIR CLEANER | 122 |
| TROUBLESHOOTING | 123 |
| ABNORMAL COOLANT TEMPERATURE | 123 |
| HARD STARTING | 124 |
| AFTERTREATMENT SYSTEM | 125 |
| ABNORMAL ENGINE OPERATION | 126 |
| ABNORMAL OPERATING CONDITIONS | 127 |
| ENGINE STORAGE | 128 |
| PREPARING ENGINE FOR STORAGE | 128 |
| TEMPORARY STORAGE (30 DAYS OR LESS) | 128 |
| EXTENDED STORAGE (MORE THAN 30 DAYS) | 129 |
| PROCEDURE FOR RESTORING TO SERVICE AN ENGINE THAT HAS BEEN IN EXTENDED STORAGE | 132 |
| CUSTOMER ASSISTANCE | 134 |
| ROAD SERVICE IN THE U.S. OR CANADA | 136 |
| WORKING WITH DETROIT DIESEL SERVICE OUTLETS | 136 |
| STEP ONE | 137 |
| STEP TWO | 137 |
| STEP THREE | 137 |
| SPECIFICATIONS | 138 |
| FUEL AND LUBRICATING OIL REQUIREMENTS | 138 |

TABLE OF CONTENTS

OIL PAN CAPACITY 138
POWER COOL ENGINE PRODUCTS 138
 POWER COOL FULLY FORMULATED IEG COOLANT 138
 2000 SUPPLEMENTAL COOLANT ADDITIVE 139
 3000 SUPPLEMENTAL ADDITIVE FILTERS 139
 NEED RELEASE COOLANT FILTERS 140
 PLUS EXTENDED LIFE OAT COOLANT 140
 PLUS EXTENDER FOR POWER COOL PLUS OAT COOLANT 140
 COOLING SYSTEM CLEANERS 141
 COOLANT TESTING AND ANALYSIS PRODUCTS 141

INTRODUCTION

This guide is intended for use by the operator of a Detroit Diesel Series 60 engine used in the following applications:

- On-Highway Vehicles
- Fire Truck or Crash/Rescue Vehicles

Non-Genuine and Rebuilt Component Quality Alert

Electronic engine controls have been instrumental in aiding engine manufacturers in meeting the stringent emission requirements of the U.S. Environmental Protection Agency (U.S. EPA) and the California Air Resources Board (CARB) and also in meeting the ever-increasing performance demands of the customer.

Maintenance procedures must be followed in order to continue satisfactory performance and durability and to ensure coverage of the engine under the manufacturer's warranty. Many of these maintenance procedures also ensure that the engine continues to comply with applicable emissions standards. Proper maintenance procedures, using specific components engineered to comply with emissions regulations, may be performed by an authorized Detroit Diesel distributor or dealer, an independent outlet or the operator

or owner. The owner is responsible for determining the suitability of components to maintain emissions compliance during the engine's useful emission life.

Detroit Diesel cautions that the indiscriminate rebuilding of precision components, without the benefit of specifications, specialized equipment, and knowledge of the electronic operating system, will jeopardize performance or lead to more serious problems, and can take the engine outside of compliance with U.S. EPA or CARB emissions standards.

There are other components in an engine, such as turbocharger, camshaft, piston, etc., which are specifically designed and manufactured to exacting standards for emissions compliance. It is important that these components, if replaced, modified or substituted, can be verified to ensure that the engine remains in compliance with emissions standards. The use of inadequately engineered, manufactured or tested components in repair or rebuild of the engine may be in violation of the federal Clean Air Act and applicable U.S. EPA or CARB regulations.

Furthermore, modern engines exhibit operating parameters which require the use of proper fluids, such as fuel, coolant and lubricating oil, to maintain long engine life. The use of fluids that do not meet Detroit Diesel specifications may result in early wear out or engine failure.

Personnel Requirements

Work on the engine should be carried out only by skilled technicians who have been instructed in the specific skills necessary for the type of work being performed.

Engine Conversions and Modifications

The function and safety of the engine could be affected if unauthorized modifications are made to it. Detroit Diesel will not accept responsibility for any resulting damage.

Tampering with the fuel injection system and engine electronics could also affect the engine's power output or exhaust emission levels. Compliance with the manufacturer's settings and with statutory environmental protection regulations cannot then be guaranteed.

CAUTION SUMMARY

The following cautions must be observed by the operator of the vehicle or equipment in which this engine is installed and/or by those performing basic engine preventive maintenance. Failure to read and heed these cautions and exercise reasonable care for personal safety and the safety of others when operating the vehicle/equipment or performing basic engine preventive maintenance may result in personal injury and engine and/or vehicle/equipment damage.

Engine Operation

Observe the following cautions when operating the engine.

| |
|---|
|  WARNING: PERSONAL INJURY |
| <p>To avoid injury from loss of vehicle/vessel control, the operator of a DDEC equipped engine must not use or read any diagnostic tool while the vehicle/vessel is moving.</p> |

| |
|--|
|  WARNING: HOT EXHAUST |
| <p>During parked regeneration the exhaust gases will be extremely HOT and could cause a fire if directed at combustible materials. The vehicle must be parked outside.</p> |

| |
|--|
|  WARNING: PERSONAL INJURY |
| <p>To avoid injury from engine shutdown in an unsafe situation, ensure the operator knows how to override the stop engine condition on a DDEC-equipped unit.</p> |



WARNING:
PERSONAL INJURY

Diesel engine exhaust and some of its constituents are known to the State of California to cause cancer, birth defects, and other reproductive harm.

- Always start and operate an engine in a well ventilated area.
- If operating an engine in an enclosed area, vent the exhaust to the outside.
- Do not modify or tamper with the exhaust system or emission control system.



CAUTION:
LOSS OF VEHICLE CONTROL

To avoid injury from loss of vehicle control, do not activate the Engine Brake system under the following conditions:

- On wet or slippery pavement, unless the vehicle is equipped with ABS (anti-lock braking system) and you have had prior experience driving under these conditions.
- When driving without a trailer (bobtailing) or pulling an empty trailer.
- If the tractor drive wheels begin to lock or there is fishtail motion after the Engine Brake is activated, deactivate the brake system immediately if this occurs.



CAUTION:

LOSS OF VEHICLE CONTROL

To avoid injury from the loss of vehicle control, do not use cruise control under these conditions:

- When it is not possible to keep the vehicle at a constant speed (on winding roads, in heavy traffic, in traffic that varies in speed, etc.).
- On slippery roads (wet pavement, ice-or snow-covered roads, loose gravel, etc.).



WARNING:

PERSONAL INJURY

To avoid injury when working on or near an operating engine, wear protective clothing, eye protection, and hearing protection.



WARNING:

HOT OIL

To avoid injury from hot oil, do not operate the engine with the rocker cover(s) removed.

Preventive Maintenance

Observe the following cautions when performing preventative maintenance.



WARNING:

PERSONAL INJURY

To avoid injury when working near or on an operating engine, remove loose items of clothing and jewelry. Tie back or contain long hair that could be caught in any moving part causing injury.



WARNING:

FIRE

To avoid injury from fire, contain and eliminate leaks of flammable fluids as they occur. Failure to eliminate leaks could result in fire.

 **CAUTION:**

USED ENGINE OIL

To avoid injury to skin from contact with the contaminants in used engine oil, wear protective gloves and apron.

 **WARNING:**

PERSONAL INJURY

To avoid injury, use care when working around moving belts and rotating parts on the engine.

 **WARNING:**

PERSONAL INJURY

To avoid injury when using caustic cleaning agents, follow the chemical manufacturers usage, disposal, and safety instructions.

 **WARNING:**

FIRE

To avoid injury from combustion of heated lubricating-oil vapors, stop the engine immediately if an oil leak is detected.

 **WARNING:**

PERSONAL INJURY

To avoid injury from hot surfaces, wear protective gloves, or allow engine to cool before removing any component.

 **WARNING:**

PERSONAL INJURY

To avoid injury from contact with rotating parts when an engine is operating with the air inlet piping removed, install an air inlet screen shield over the turbocharger air inlet. The shield prevents contact with rotating parts.



WARNING:

HOT COOLANT

To avoid scalding from the expulsion of hot coolant, never remove the cooling system pressure cap while the engine is at operating temperature. Wear adequate protective clothing (face shield, rubber gloves, apron, and boots). Remove the cap slowly to relieve pressure.



WARNING:

PERSONAL INJURY

To avoid injury from rotating belts and fans, do not remove and discard safety guards.



WARNING:

PERSONAL INJURY

To avoid injury from slipping and falling, immediately clean up any spilled liquids.



WARNING:

FIRE

To avoid injury from fire, do not smoke or allow open flames when working on an operating engine.



WARNING:

FIRE

To avoid injury from fire from a buildup of volatile vapors, keep the engine area well ventilated during operation.

Electrical System

Observe the following cautions when jump starting an engine, charging a battery, or working with the vehicle/application electrical system.

 **WARNING:**
ELECTRICAL SHOCK

To avoid injury from electrical shock, do not touch battery terminals, alternator terminals, or wiring cables while the engine is operating.

 **WARNING:**

Battery Explosion and Acid Burn

To avoid injury from battery explosion or contact with battery acid, work in a well ventilated area, wear protective clothing, and avoid sparks or flames near the battery. If you come in contact with battery acid:

- Flush your skin with water.
- Apply baking soda or lime to help neutralize the acid.
- Flush your eyes with water.
- Get medical attention immediately.

 **WARNING:**
PERSONAL INJURY

To avoid injury from accidental engine startup while servicing the engine, disconnect/disable the starting system.

Cooling System

Observe the following cautions when servicing the cooling system.

 **WARNING:**
HOT COOLANT

To avoid scalding from the expulsion of hot coolant, never remove the cooling system pressure cap while the engine is at operating temperature. Wear adequate protective clothing (face shield, rubber gloves, apron, and boots). Remove the cap slowly to relieve pressure.



WARNING:
PERSONAL INJURY

To avoid injury from slipping and falling, immediately clean up any spilled liquids.

Air Intake System

Observe the following cautions when working on the air intake system.



WARNING:
PERSONAL INJURY

To avoid injury from hot surfaces, wear protective gloves, or allow engine to cool before removing any component.



WARNING:
PERSONAL INJURY

To avoid injury from contact with rotating parts when an engine is operating with the air inlet piping removed, install an air inlet screen shield over the turbocharger air inlet. The shield prevents contact with rotating parts.

Fuel System

Observe the following cautions when fueling the vehicle or working with the fuel system.



WARNING:
FIRE

To avoid injury from fire, keep all potential ignition sources away from diesel fuel, including open flames, sparks, and electrical resistance heating elements. Do not smoke when refueling.



WARNING:
FIRE

To avoid increased risk of a fuel fire, do not mix gasoline and diesel fuel.



WARNING:

FIRE

To avoid injury from fire caused by heated diesel-fuel vapors:

- Keep those people who are not directly involved in servicing away from the engine.
- Stop the engine immediately if a fuel leak is detected.
- Do not smoke or allow open flames when working on an operating engine.
- Wear adequate protective clothing (face shield, insulated gloves and apron, etc.).
- To prevent a buildup of potentially volatile vapors, keep the engine area well ventilated during operation.

Compressed Air

Observe the following cautions when using compressed air.



WARNING:

EYE INJURY

To avoid injury from flying debris when using compressed air, wear adequate eye protection (face shield or safety goggles) and do not exceed 276 kPa (40 psi) air pressure.

Starting Aids

Observe the following cautions when using starting aids.

| |
|---|
|  WARNING: FLAMES, EXPLOSION AND TOXICITY |
| <p>To avoid injury from flames, explosion, and toxicants when using ether, the following precautions must be taken:</p> <ul style="list-style-type: none"> □ Do not smoke when servicing ether system. □ Work in well ventilated area. □ Do not work near open flames, pilot flames (gas or oil heaters), or sparks. □ Do not weld or carry an open flame near the ether system if you smell ether or otherwise suspect a leak. |

| |
|--|
|  WARNING: FLAMES, EXPLOSION AND TOXICITY |
| <p>To avoid injury from flames, explosion, and toxicants when using ether, the following precautions must be taken:</p> <ul style="list-style-type: none"> □ Always wear goggles when testing. □ If fluid enters the eyes or if fumes irritate the eyes, wash eyes with large quantities of clean water for 15 minutes. A physician, preferably an eye specialist, should be contacted. □ Contents of cylinder are under pressure. Store cylinders in a cool dry area. Do not incinerate, puncture or attempt to remove cores from cylinders. |

Lubricating Oil and Filters

Observe the following cautions when replacing the engine lubricating oil and filters.



WARNING:

PERSONAL INJURY

To avoid injury from slipping and falling, immediately clean up any spilled liquids.



WARNING:

FIRE

To avoid injury from combustion of heated lubricating-oil vapors, stop the engine immediately if an oil leak is detected.



WARNING:

FIRE

To avoid injury from fire, do not smoke or allow open flames when working on an operating engine.



WARNING:

FIRE

To avoid injury from fire from a buildup of volatile vapors, keep the engine area well ventilated during operation.

Aftertreatment System

Observe the following cautions when servicing the Aftertreatment System (ATS). Be advised that these two labels are attached to the Aftertreatment Device (ATD).

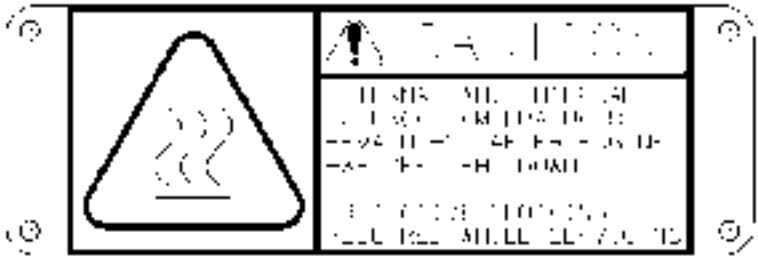

47195

Figure 1 Hot Surfaces External and Internal Caution

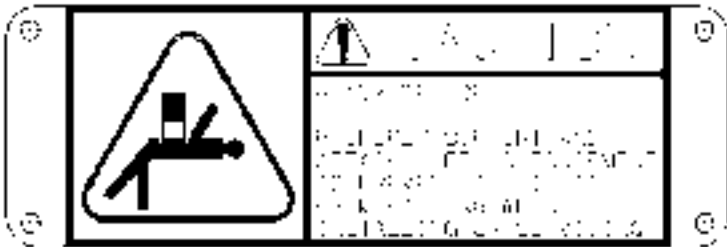

47197

Figure 2 Heavy Aftertreatment Device Caution

ENGINE IDENTIFICATION

The Series 60 engine has a certification label, model number and engine serial number for identification.

Engine Components

For a general view of the Series 60 engine, showing major components, see Figure 3 and Figure 4

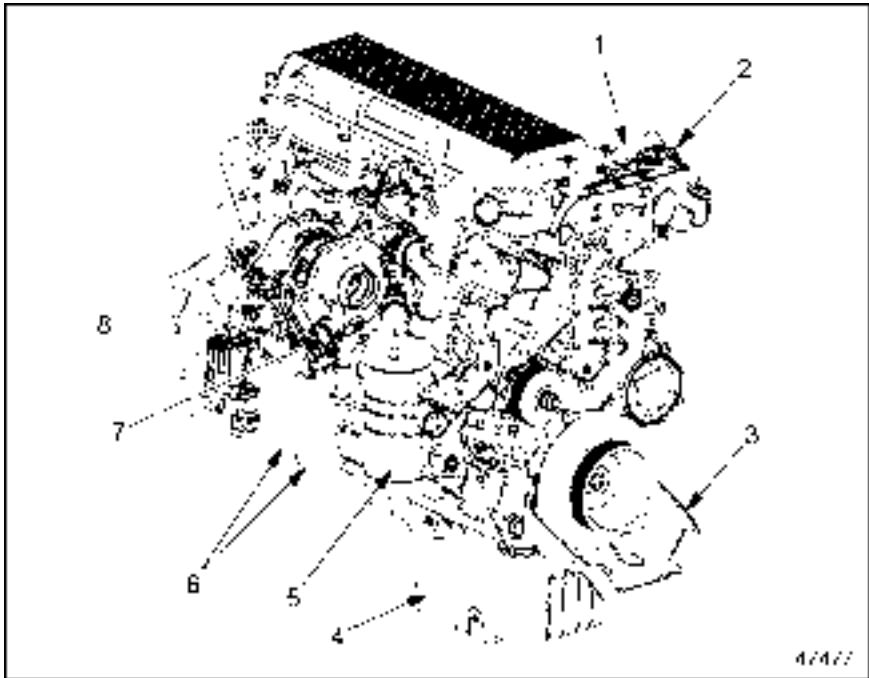

- | | |
|------------------------------------|-----------------|
| 1. Delivery Pipe | 5. EGR Cooler |
| 2. Delta P Sensor | 6. Oil Filters |
| 3. Engine Mounted Radiator Bracket | 7. Turbocharger |
| 4. Oil Pan | 8. Actuator |

Figure 3 Major Engine Components, Right Side

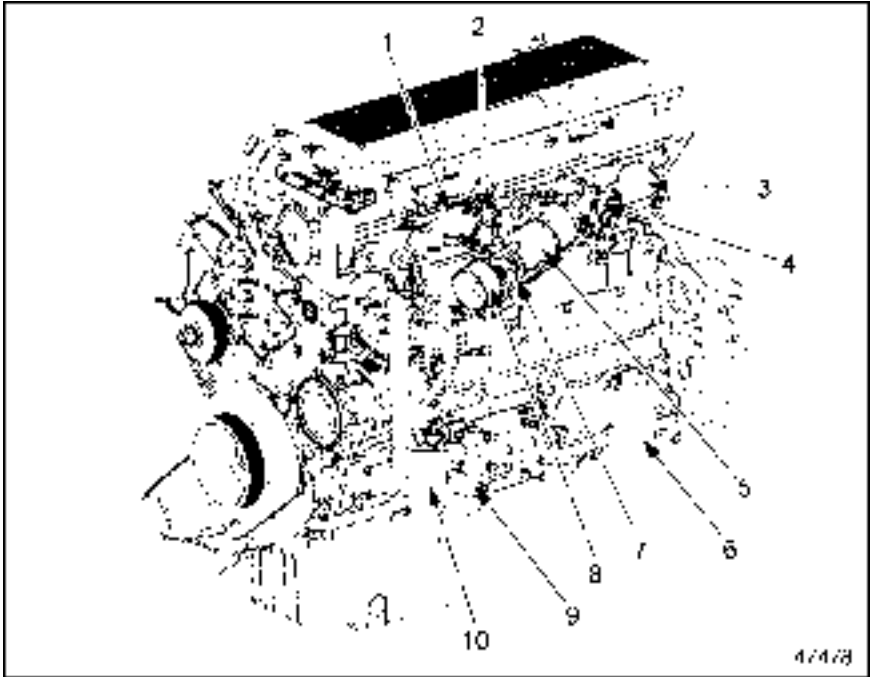

- | | |
|-------------------------|--|
| 1. Venturi | 6. Primary Fuel Filter/Water Separator |
| 2. EGR Valve | 7. Intake Throttle Valve |
| 3. Intake Manifold | 8. Adaptor |
| 4. Doser Block Assembly | 9. Motor Control Module (MCM) |
| 5. Mixer | 10. Secondary Fuel Filter |

Figure 4 Major Engine Components, Left Side

Engine Model And Serial Number Designation

The engine serial number and model number are laser etched on the cylinder block in the left side just

below the intake manifold and above the cast-in Detroit Diesel logo (as viewed from the flywheel end).

See Figure 5

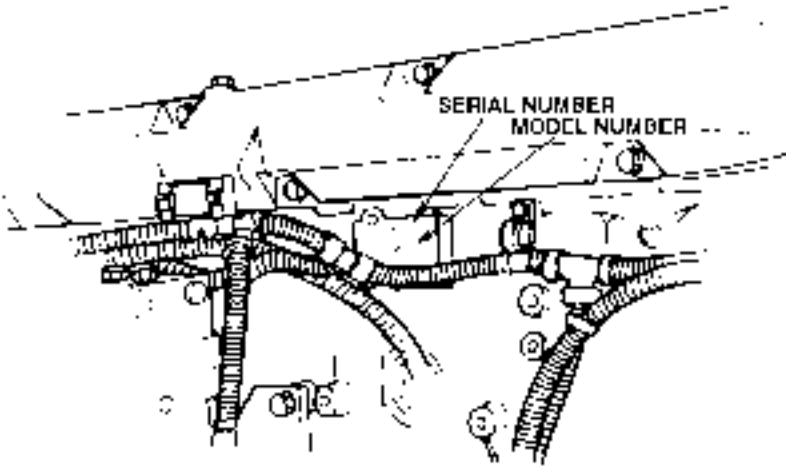
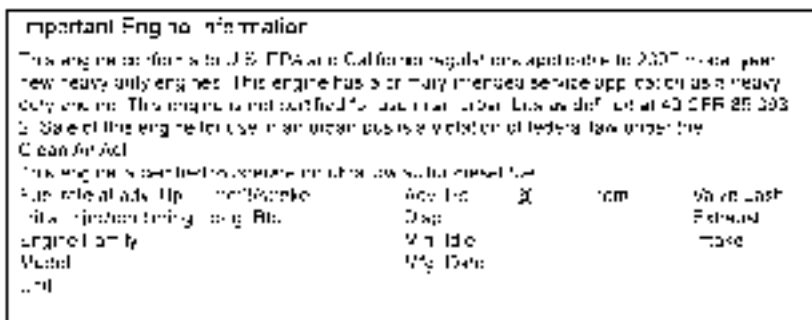

Figure 5 Location of Engine Serial and Model Numbers

Certification Label

If required, a certification label is attached to the valve rocker cover. This label certifies that the engine conforms to federal and certain state

emissions regulations for its particular application. It also gives the operating conditions under which certification was made. See Figure 6.



47716

Figure 6 Typical Engine Certification Label

OPERATING INSTRUCTIONS FOR STARTING THE ENGINE

Following are instructions for starting the engine.

First Time Start Preparation

When preparing to start a new or newly overhauled engine which has been in storage, perform all of the operations listed below. Also refer to the “ENGINE STORAGE” section. Failure to follow these instructions may result in serious engine damage.

Be sure you are familiar with all of the instruments, gauges and controls which are needed to operate the engine.

Note especially the location and function of the following:

- Oil pressure gauge
- Low oil pressure warning light
- Coolant temperature gauge
- High coolant temperature warning light
- Water in fuel warning light
- Air restriction indicator

Watch for any signs of engine problems when starting or driving. If the engine overheats, uses excessive fuel or lubricating oil, vibrates,

misfires, makes unusual noises, or shows an unusual loss of power, turn the engine off as soon as possible and determine the cause of the problem. Engine damage may be avoided by a quick response to early indications of problems.

When starting the engine in cold weather, refer to “How to Select Coolant” in the HOW-TO SECTION.

System Checks

Perform the following system checks before starting for the first time.

Cooling System Checks

Check the cooling system as follows:

1. Make sure all drain cocks in the cooling system are installed (drain cocks are often removed for shipping) and are closed tightly.
2. Remove the radiator pressure control cap and fill with genuine Detroit Diesel *POWER COOL*® antifreeze or an equivalent quality ethylene glycol or propylene glycol-base antifreeze solution in the required concentration. In extremely hot environments, **properly inhibited** water may be used in the summer. Keep the

coolant level at the bottom of the filler neck to allow for expansion of the coolant. For more detailed recommendations, refer to *How to Select Coolant* in the *HOW-TO SECTION*.

3. Entrapped air must be purged after filling the cooling system. To do this, allow the engine to warm up with the pressure cap removed. With the transmission in neutral, increase engine speed above 1,000 rpm and add coolant to the radiator as required.
4. Check to make sure the front of the radiator and air-to-air charge cooler (if equipped) are unblocked and free of debris.

Lubrication System Checks

The lubricating oil film on the rotating parts and bearings of a new or newly overhauled engine, or one which has been in storage for six months or more, may be insufficient when the engine is started for the first time.

NOTICE:

Insufficient lubrication at startup can cause serious damage to engine components.

To insure an immediate flow of oil to all bearing surfaces at initial engine startup, the engine lubrication

system should be charged with a commercially available pressure pre-lubricator. If this is impractical, rocker covers should be removed and clean lubricating oil should be poured over the rocker arms. The oil should be the same weight and viscosity as that used in the crankcase. After pre-lubricating, add additional oil to bring the level to the proper mark on the dipstick.

For lubricant recommendation, refer to *How to Select Lubricating Oil* in the *HOW-TO SECTION*.

Checking the Oil Level — Check the oil level as follows:

1. Check the oil level using the oil dipstick. The dipstick has an operating range identified by a crosshatch. If the oil meniscus is within this crosshatch range then the oil range is adequate for engine operation. (See Figure 7).

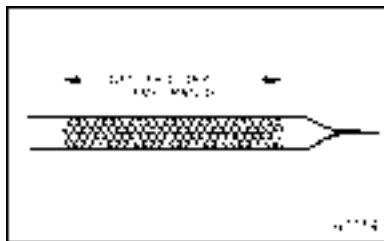

Figure 7 Check Lube Oil Level



WARNING:
PERSONAL INJURY

To avoid injury from slipping and falling, immediately clean up any spilled liquids.

2. If necessary, top off by filling engine oil through the oil fill cap to the satisfactory fill range on the oil dipstick. For detailed procedures, refer to the “MAINTENANCE” section. Do not overfill.

Extended Storage — An engine in storage for an extended period of time (over winter, for example) may accumulate water in the oil pan through normal condensation of moisture (always present in the air) on the cold, internal surfaces of the engine.

NOTICE:

Failure to eliminate water-diluted lubricating oil may lead to serious engine damage at startup.

Lube oil diluted by water cannot provide adequate bearing protection at engine startup. For this reason, Detroit Diesel recommends replacing the engine lubricating oil and filters after extended storage.

Fuel System Checks

Fill the tanks with the recommended fuel. Keeping tanks full reduces water condensation and helps keep fuel cool, which is important to engine performance. Full tanks also reduce the chance for microbe (black slime) growth. For fuel recommendations, refer to *How to Select Diesel Fuel* in the *HOW-TO SECTION* of this guide. Make sure the fuel shutoff valve (if used) is open.

NOTICE:

Prolonged use of the starting motor and engine fuel pump to prime the fuel system can result in damage to the starter, fuel pump and injectors.

This may cause erratic engine operation due to the amount of air in the lines and filters from the fuel supply tank to the cylinder head

NOTICE:

NEVER use a starting aid such as ether to run the engine until the fuel system is primed. Doing so will result in injector damage.

If an external starting aid is used, the heat generated by the external fuel source will cause the injector tips to be damaged when the fuel cools them. The injector plunger and bushing can be scored from running without lubrication.

NOTICE:

Engines equipped with starting devices dependent on compressed air or gas reservoirs should always be primed before initial startup. Otherwise, reserve pressure can be exhausted and injectors may be damaged from lack of lubrication and cooling.

To insure prompt starting and even running, the fuel system *must* be primed if air has entered the fuel system. Priming is done by connecting a manual or electric priming pump to the *secondary* fuel filter adaptor.

Authorized Detroit Diesel service outlets are properly equipped and have the trained technicians to perform this service.

Priming is not normally required if the filter elements are filled with clean fuel when installed and the manifolds are not drained of fuel.

If the engine is equipped with a fuel/water separator, drain off any water that has accumulated. Water in fuel can seriously affect engine

performance and may cause engine damage. Detroit Diesel recommends installation of a fuel/water separator wherever water contamination is a concern.

Adding Fuel — When adding fuel, pay attention to the following:

- Add winter or summer grade fuel according to the season of the year.
- Work in the cleanest conditions possible.
- Prevent water from entering the fuel tank.

For further information, refer to Diesel Fuels in the “HOW-TO SECTION” of this guide.

Priming the Fuel System —

Prime the fuel system as follows:

1. If equipped with a hand pump on the fuel filter or fuel/water separator, work the hand pump until resistance is felt.
2. Crank the engine for 30 seconds at a time, but no longer. Before cranking the engine again, wait at least two minutes. The engine should start within six 30-second attempts.

Other Checks

Make sure the transmission is filled to the proper level with the fluid recommended by the gear manufacturer. Do not overfill.



WARNING:

Battery Explosion and Acid Burn

To avoid injury from battery explosion or contact with battery acid, work in a well ventilated area, wear protective clothing, and avoid sparks or flames near the battery. If you come in contact with battery acid:

- Flush your skin with water.
- Apply baking soda or lime to help neutralize the acid.
- Flush your eyes with water.
- Get medical attention immediately.

Make sure cable connections to the storage batteries are clean and tight. Check the hydrometer “eye” of maintenance-free batteries for charge. See Figure 8.

If lead-acid or low-maintenance batteries are used, make sure battery electrolyte level is normal.

Use only batteries that have been correctly filled and serviced. To

provide corrosion protection, apply dielectric grease liberally to the terminal pads.

Check the turbocharger for signs of oil or exhaust leaks. Leaks should be corrected before starting the engine. Check engine mounting bolts for tightness. Bolts should be retightened, if necessary.

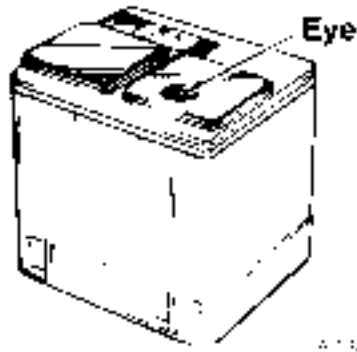

Figure 8 Maintenance-Free Battery “Eye”

Starting the Engine For The First Time

Before starting the engine the first time, perform the operations listed in the *System Checks* section.

NOTICE:

The turbocharger may be seriously damaged if the engine is cranked with the air shutdown in the *closed* position.

An emergency manual or automatic shutdown system, must be set in the *open* position before starting.



WARNING:
FLAMES, EXPLOSION AND TOXICITY

To avoid injury from flames, explosion, and toxicants when using ether, the following precautions must be taken:

- Do not smoke when servicing ether system.
- Work in well ventilated area.
- Do not work near open flames, pilot flames (gas or oil heaters), or sparks.
- Do not weld or carry an open flame near the ether system if you smell ether or otherwise suspect a leak.

The engine may require the use of a cold weather starting aid if the ambient temperature is below 40°F (4°C).

To start a Series 60 engine, make sure the transmission is in neutral and turn the ignition key on.

**WARNING:****ENGINE EXHAUST**

To avoid injury from inhaling engine exhaust, always operate the engine in a well-ventilated area. Engine exhaust is toxic.

**WARNING:****PERSONAL INJURY**

To avoid injury when working near or on an operating engine, remove loose items of clothing and jewelry. Tie back or contain long hair that could be caught in any moving part causing injury.

You will notice that both the Amber Warning Lamp and the Red Stop Lamp will come on. This is the result of the Detroit Diesel Electronic Control (DDEC®) computer diagnosing the system to ensure everything is functional, including the light bulbs for the warning lights. If everything is OK, both lights will go out in approximately five seconds.

Start the engine *after* the lights go out. If starting a vehicle, start the engine with foot *off* the foot pedal.

NOTICE:

If the warning lights stay on, or do not come on momentarily after turning on the ignition, contact the Detroit Diesel Customer Support Center at 313-592-5800. Operating the engine under these circumstances may result in engine damage.

Electric Starter — Start an engine equipped with an electric starting motor as follows:

NOTICE:

To prevent serious starting motor damage, do not press the starter switch again after the engine has started.

1. Chock the tires, place the transmission in neutral, and set the parking brake.
2. With foot OFF the foot pedal, turn on the ignition switch and start the engine
3. If the engine doesn't start after 20 seconds, stop. Try again after waiting about one minute.

NOTICE:

Do not rev the engine if the oil pressure gauge indicates no oil pressure. Shut down the engine within approximately ten seconds to avoid engine damage. Check to determine the cause of the problem.

4. Monitor the oil pressure gauge immediately after starting the engine.

NOTE:

Do not place the engine under full load until it reaches operating temperature.

Running the Engine

While the engine is operating, monitor the battery charge indicator light, the oil pressure and avoid excessive idling.

Oil Pressure

Observe the oil pressure gauge immediately after starting the engine. A good indicator that all moving parts are getting lubrication is when the oil pressure gauge registers pressure 35 kPa or 5 psi at idle speed.

If no pressure is indicated within 10 to 15 seconds, stop the engine and check the lubrication system.

The pressure should not drop below 193 kPa or 28 psi at 1800 rpm, and normal operating pressure should be higher. If oil pressure does not fall within these guidelines, it should be checked with a manual gage.



WARNING:

HOT OIL

To avoid injury from hot oil, do not operate the engine with the rocker cover(s) removed.

Warm-up

Run the engine at part throttle for about five minutes to allow it to warm up before applying a load.

Inspection

While the engine is idling, inspect the transmission, check for fluid leaks, check the crankcase and turbocharger.

Transmission — While the engine is idling, check the automatic transmission (if equipped) for proper oil level and add oil as required.

Fluid Leaks — Look for coolant, fuel or lubricating oil leaks. If any are found, shut down the engine immediately and have the leaks repaired after the engine has cooled.

Crankcase — If the engine oil was replaced, stop the engine after normal operating temperature has been reached. Allow the oil to drain back into the crankcase for about twenty minutes, then check the oil level. If necessary, add oil to bring the level to the proper mark on the dipstick. Use only the heavy-duty oils recommended. Refer to *How to Select Lubricating Oil* in this guide.

Turbocharger — Make a visual inspection of the turbocharger for oil leaks, exhaust leaks, excessive noise or vibration. Stop the engine immediately if a leak or unusual noise or vibration is noted. *Do not restart the engine until the cause of the concern has been investigated and corrected.* Authorized Detroit Diesel service outlets are properly equipped to perform this service.

Avoid Unnecessary Idling

Whenever possible, avoid unnecessary idling.

During long engine idling periods with the transmission in neutral, the engine coolant temperature may fall below the normal operating range.

The incomplete combustion of fuel in a cold engine will cause crankcase oil dilution, formation of lacquer or gummy deposits on the valves, pistons, and rings, and rapid accumulation of sludge in the engine. When prolonged idling is necessary, maintain at least 850 rpm spring/summer and 1200 rpm fall/winter.

Stopping the Engine

Stop an engine under normal operating conditions as follows:

1. Reduce engine speed to idle and put all shift levers in the neutral position.

NOTICE:

Do not stop a turbocharged engine immediately after a high-speed operation. Allow a sufficient cool-down period to prevent the turbo from continuing to turn without an oil supply to the bearings.

2. Allow the engine to run between idle and 1000 rpm with no load for four or five minutes. This allows the engine to cool and permits the turbocharger to slow down. After four or five minutes, shut down the engine.

Emergency Jump Starting

The DDEC VI system operates on 12 volts DC. If a DDEC VI engine with an electric starting motor requires emergency jump starting, *do not exceed 16 volts DC.*



WARNING:

BATTERY EXPLOSION

To avoid injury from battery explosion when jump starting the engine, do not attach the cable end to the negative terminal of the disabled battery.

NOTICE:

Jump starting with voltages greater than those indicated *or* reversing battery polarity may damage the Motor Control Module.

NOTICE:

Failure to connect jumper cables in the proper sequence can result in alternator and/or equipment damage.

Before attempting to jump start the engine, make sure the jumper cables are connected properly (positive to positive, negative to negative ground) and in the proper sequence (negative to negative ground *last*).

| |
|---|
|  WARNING: |
| Battery Explosion and Acid Burn |
| <p>To avoid injury from battery explosion or contact with battery acid, work in a well ventilated area, wear protective clothing, and avoid sparks or flames near the battery. If you come in contact with battery acid:</p> <ul style="list-style-type: none"> <input type="checkbox"/> Flush your skin with water. <input type="checkbox"/> Apply baking soda or lime to help neutralize the acid. <input type="checkbox"/> Flush your eyes with water. <input type="checkbox"/> Get medical attention immediately. |

Routine Engine Start

Following are procedures for a routine everyday engine start.

| |
|--|
|  WARNING: |
| ENGINE EXHAUST |
| <p>To avoid injury from inhaling engine exhaust, always operate the engine in a well-ventilated area. Engine exhaust is toxic.</p> |

| |
|---|
|  WARNING: |
| PERSONAL INJURY |
| <p>To avoid injury when working near or on an operating engine, remove loose items of clothing and jewelry. Tie back or contain long hair that could be caught in any moving part causing injury.</p> |

Starting the Engine-Routine

Before a routine start, refer to the *MAINTENANCE* section and see the daily checks for your engine.

Important: Before starting the engine, carefully read all operating instructions in this manual and do all the recommended pretrip inspections and daily maintenance. Check the engine oil and fuel levels, and drain contaminants from the fuel/water separator (optional).

NOTE:

If you drain the fuel/water separator completely, you may have to prime the fuel system.

NOTE:

As a safety function, the electronic engine control system may be wired to start the engine only if the transmission is in neutral. This is vehicle application specific.

1. Turn on the ignition switch.
2. With the accelerator pedal in the idle position, start the engine.
3. Check the engine for leaks.
 - [a] Check all hoses, hose clamps, and pipe unions on the engine for tightness. Shut down the engine and tighten them if necessary.
 - [b] Check the oil feed and return lines at the turbocharger for tightness. Shut down the engine and tighten them if necessary.

4. Shut down the engine.
5. Approximately five minutes after shutdown, check the engine oil level. If necessary, add oil up to the satisfactory fill range on the oil dipstick (see Figure 9). Do not overfill.

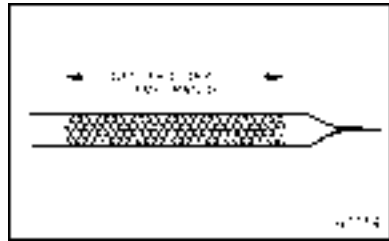

Figure 9 Oil Dipstick

6. Check all the mounting fasteners on the engine for tightness.

Checking the Coolant Level (Cold Check)

Check coolant level as follows:

1. Ensure that all coolant plugs in the bottom of the radiator and on the radiator outlet pipe are secure and tight.
2. Check the coolant level. The cooling system is correctly filled when the coolant is between the

maximum and minimum marks on the surge tank.

NOTE:

For more information, refer to the "MAINTENANCE" section.

Checking the Coolant Level (Hot Check)

Check the coolant levels as follows:

1. Allow the engine to run for approximately five minutes at a moderate speed.

| |
|---|
|  <p>WARNING: HOT COOLANT</p> |
| <p>To avoid scalding from the expulsion of hot coolant, never remove the cooling system pressure cap while the engine is at operating temperature. Wear adequate protective clothing (face shield, rubber gloves, apron, and boots). Remove the cap slowly to relieve pressure.</p> |

2. Then, with the coolant temperature above 50°C (122°F), recheck the coolant level.
3. Add more coolant if necessary. Open the heater valves before adding coolant.
4. Do not close the heater valves until the engine has been run

briefly and the coolant level again checked and corrected as necessary.

Monitoring Engine Operation

While the engine is operating, monitor the battery charge indicator light, the oil pressure and avoid excessive idling.

Battery Charge

The battery charge indicator light must go out once the engine starts. See Figure 10

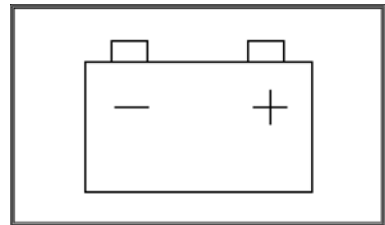

41737

Figure 10 Battery Charge Indicator Light

If the indicator light comes on while the engine is running, do the following:



WARNING:

FIRE

To avoid injury from fire, keep all potential ignition sources away from diesel fuel, including open flames, sparks, and electrical resistance heating elements. Do not smoke when refueling.

1. Shut down the engine.
2. Check the poly-V belt for tightness.
3. Charge or replace the batteries as needed.
4. If necessary, visit the nearest authorized dealer to have the alternator voltage and output checked. Do a load test on the batteries.

Oil Pressure

When the engine has reached its normal operating temperature, the engine oil pressure must not drop below the following values:

- 193 kPa (28 psi) at rated speed
- 35 kPa (5 psi) at idling speed

If oil pressure drops below these values, stop the engine and determine the cause.

Excessive Idling

Never allow the engine to idle for more than 30 minutes. Excessive idling can cause oil to leak from the turbocharger.

Changing the Idle Speed

The rpm range of the Series 60 engine is 600 to 850 rpm if the parameters in the Common Powertrain Controller (CPC) are set to the default range.

Change the idle speed as follows:

1. Turn the cruise control switch to the ON position.
2. To increase the idle speed, push the RSM/ACL switch until the idle is fast enough.
3. To decrease the idle speed, push the SET/CST switch until the idle is slow enough.

Shutting Down the Engine

If the engine has been running at full output or the coolant temperature has been high, allow the engine to idle for four or five minutes without load. Then turn off the ignition key switch.

If any of the following occur, shut down the engine immediately.

- The oil pressure swings back and forth or falls sharply.

- Engine power and rpm fall, even though the accelerator pedal remains steady.
- The exhaust pipe gives off heavy smoke.
- The coolant and/or oil temperature climb abnormally.
- Abnormal sounds suddenly occur in the engine or turbocharger.

Shutting Down After High Load Operation

After high load operation, do the following:

NOTICE:

An engine running at full output or with high coolant temperature after a high load operation, should idle for one or two minutes without load. Shutting down without idling may cause damage to the turbocharger.

Turn off the ignition switch and shut down the engine.

Emergency Running Mode

The engine is equipped with DDEC VI which monitors the engine as it is running.

As soon as a fault is detected, it is evaluated and one of the following measures is initiated.

NOTICE:

To prevent possible serious engine damage, have any faults corrected without delay by an authorized dealer.

- In conjunction with any dashboard or instrument panel display, the code for the electronic control unit reporting the fault can be read immediately on the display.
- If the fault is serious enough to impair normal operation, DDEC VI switches over to limp home mode. The limp home speed is dependent on MCM parameters and could be idle speed or 1000 rpm. This allows you to move the vehicle to a service location.

Stop Engine Override Option

The Stop Engine Override Option is used for a momentary override. The Motor Control Module (MCM) will record the number of times the override is activated after a fault occurs.

Momentary Override – A Stop Engine Override (SEO) switch is used to override the shutdown sequence (see Figure 11). This override resets the 60 second (30 seconds for oil pressure) shutdown timer, restoring power to the level when the Red Stop Lamp (RSL)/Stop Engine was illuminated. The switch must be recycled after five seconds to obtain a subsequent override.

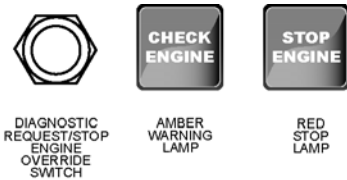

47471

Figure 11 SEO Switch and Warning Lamps

NOTE:

The operator has the responsibility to take action to avoid engine damage.

Cold Weather Operation

Special precautions must be taken during cold weather. To protect your engine, special cold weather handling is required for fuel, engine oil, coolant, and batteries. For detailed information, refer to the service manual.

Winter Fronts

A winter front may be used to improve cab heating while idling. At least 25% of the grill opening should remain open in sectioned stripes that run perpendicular to the charge air cooler tube flow direction. This assures even cooling across each tube and reduces header to tube stress and possible failure. Winter fronts should only be used when the ambient temperature remains below -12.2°C (10°F).

DDEC VI SYSTEM

Detroit Diesel Series 60 engines equipped with DDEC are identified by the letter “G” in the sixth position of the model number. Example: 6067HG6E. The Series 60 engine for 2007 is equipped with DDEC VI.

DDEC VI regulates the fuel injection quantity and timing using solenoid valves, allowing extremely low-emission operation. Besides the engine and its related sensors, the system has two control modules:

- The Motor Control Module (MCM)
- The Common Powertrain Controller (CPC) located under the right-hand dash panel

The two control units are connected by a proprietary datalink through which all necessary data and information can be exchanged.

The CPC broadcasts all information on the J1587 and J1939 datalinks, where it can be read by the diagnostic tool.

The MCM monitors both the engine and the datalink. When a malfunction or other problem is detected, the system selects an appropriate response; for example, the emergency running mode may be activated.

The Accelerator Pedal Assembly (AP) eliminates the need for any throttle linkage.

Motor Control Module

The MCM (see Figure 12) is typically located on the left-hand side of the engine.

The MCM processes the data received from the CPC, for example the position of the accelerator pedal, engine brake, etc.

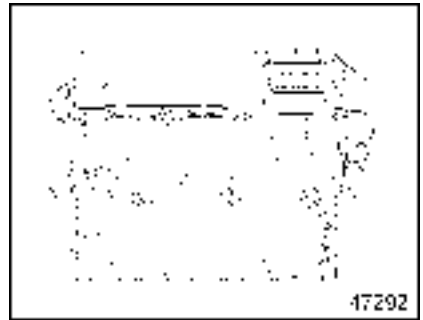

Figure 12 MCM

These data are evaluated together with the data from the sensors on the engine, such as coolant and fuel temperature and oil and charge pressure. The data is then compared to the characteristic maps or lines stored in the MCM.

From these data, quantity and timing of injection are calculated.

NOTE:

To obtain a replacement MCM, all the data given on the MCM label are required.

The MCM data label has the 10 digit engine serial number (see Figure 13).

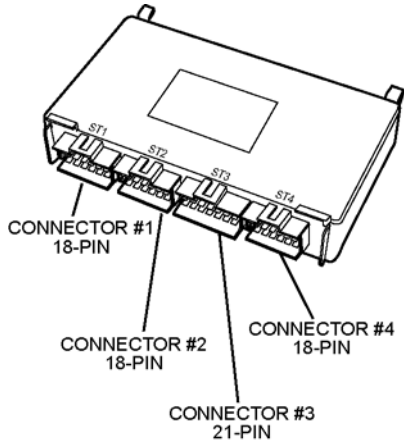

Figure 13 MCM Label

Common Powertrain Controller

The CPC communicates with any other MCM unit installed on the vehicle over the J1939 data link. See Figure 14.

Data for specific applications is stored in the CPC. These include idle speed, maximum running speed, and speed limitation.



47291

Figure 14 CPC

The CPC receives data from the following sources:

- The operator (accelerator pedal position, engine brake switch)
- Other electronic control units (for example, the anti-lock brake system)
- The MCM (oil pressure and coolant temperature)

From these data, instructions are computed for controlling the engine and transmitted to the CPC via the proprietary datalink.

DDEC Features

DDEC offers a variety of features and options designed to warn the operator of an engine malfunction.

Options can range from warning panel lights to automatic reduction in engine power followed by automatic engine shutdown.

DDEC has the ability to perform diagnostics for self-checks and continuous monitoring of other system components.

Depending on the application, DDEC can monitor oil temperature, coolant temperature, oil pressure, fuel pressure, coolant level and remote sensors (if used).

DDEC connects to the Amber Warning Lamp (AWL)/Check Engine and the Red Stop Lamp (RSL)/Stop Engine to provide a visual warning of a system malfunction.

Cruise Control

Cruise Control is available with any DDEC engine. Cruise Control will operate in either Engine or Vehicle Speed Mode and maintain a targeted speed (MPH or RPM) by increasing or decreasing fueling. The targeted speed can be selected and adjusted with dash-mounted switches. See Figure 15



47521

Figure 15 Typical Cruise Control Switches

Cruise Control may also be programmed to permit fast idle using the Cruise Control switches.

With the engine at normal idle, transmission in neutral and service brakes on, press the SPD CNTL Switch, and use the RSM/ACC Switch. The engine rpm should increase to a pre-defined speed. The engine rpm can be raised or lowered from this point using the SET/CST and RSM/ACC switches.

Cruise Control will maintain the set speed under normal road and load conditions.



CAUTION:

LOSS OF VEHICLE CONTROL

To avoid injury from the loss of vehicle control, do not use cruise control under these conditions:

- When it is not possible to keep the vehicle at a constant speed (on winding roads, in heavy traffic, in traffic that varies in speed, etc.).
- On slippery roads (wet pavement, ice-or snow-covered roads, loose gravel, etc.).

NOTICE:

When descending a hill with Cruise Control OFF, **do not** allow the engine to exceed 2,500 rpm. Failure to observe this can result in over speeding and serious engine damage.

It cannot limit vehicle speeds on down grades if available engine braking effort is exceeded, nor can it maintain speed on upgrades if power requirements exceed engine power capability.

Engine speed and power are varied under Cruise Control to maintain the

set vehicle speed. The vehicle speed must be above Min Cruise Set Speed and below Max Cruise Set Speed. It is recommended that Max Cruise Set Speed be set to the default to allow proper operation of other features such as Fuel Economy Incentive and PasSmart. The Vehicle Speed Limit should be used to limit vehicle throttle speed.

When the SPD CNTL is in the ON position, Cruise Control is engaged by momentarily contacting the SET/CST Switch. As a check after each engine start, DDEC looks for a one time activation of the clutch (if equipped) and service brake before DDEC allows Cruise Control to be enabled. The MCM must also recognize that the Cruise Enable Switch has changed. If the Cruise Enable Switch is off, it needs to be turned on. If the Cruise Enable Switch is on, it must be turned off then on for cruise to operate.

Holding the switch in the SET/CST position allows the vehicle to slow to a lower speed. Toggling the switch will result in a one mile-per-hour (1.6 kph) decrease in vehicle speed. If Cruise Control has been disabled, toggling the RSM/ACC Switch restores the vehicle to the previously set cruise speed.

Cruise Control can be overridden at any time with the throttle pedal if the vehicle is operating at less than the programmed Max Road Speed. Additionally, using either the brake or the clutch will disable Cruise Control.

Data Recording Capability

DDEC VI contains the ability to extract detailed data on the engine's use and performance using DDEC Reports software. This data, known as DDEC Data, is stored in the CPC and contains information on engine performance (such as fuel economy, idle time, time in top gear) and critical incidents (such as detailed diagnostic data records and hard braking events). DDEC Data can be downloaded using DDEC Reports software to produce reports.

DDEC Reports software is part of the Detroit Diesel Diagnostic Link® 7.0 (DDDL 7.0) software package. DDDL 7.0 requires at least a Pentium II computer with at least 256 MB of RAM.

Engine Brakes

Engine brakes are enabled by a dash-mounted On/Off switch with a separate intensity switch to select low, medium or high braking power.



CAUTION:

LOSS OF VEHICLE CONTROL

To avoid injury from loss of vehicle control, do not activate the Engine Brake system under the following conditions:

- **On wet or slippery pavement, unless the vehicle is equipped with ABS (anti-lock braking system) and you have had prior experience driving under these conditions.**
- **When driving without a trailer (bobtailing) or pulling an empty trailer.**
- **If the tractor drive wheels begin to lock or there is fishtail motion after the Engine Brake is activated, deactivate the brake system immediately if this occurs.**

The engine brakes will only operate when the Accelerator Pedal is fully released. Disengaging the clutch will prevent the engine brakes from operating.

Engine brakes will supply braking power even when in Cruise Control. The MCM will control the amount of engine braking with respect to the Cruise Control set speed. The maximum amount of braking (low, medium, high) is selected with the dash switches.

Engine Protection

The DDEC engine protection system monitors all engine sensors and electronic components, and recognizes system malfunctions. If a critical fault is detected, the AWL (Check Engine) and RSL (Stop Engine) illuminate. The malfunction codes are logged into the MCM's memory.

The standard parameters which are monitored for engine protection are: low coolant level, high coolant temperature, low oil pressure, and high oil temperature.

This system features a 30-second, stepped-power shutdown sequence or an immediate speed reduction without shutdown in the event a major engine malfunction occurs, such as low oil pressure, high oil or coolant temperature, or low coolant level.



WARNING: **PERSONAL INJURY**

To avoid injury from engine shutdown in an unsafe situation, ensure the operator knows how to override the stop engine condition on a DDEC-equipped unit.

NOTICE:

Engines equipped with the power-down/shutdown option have a system override button or switch to allow engine operation for a short period of time. Using the override button so the engine does not shutdown in 30 seconds but operates for an extended period may result in engine damage.

California Engine Idle Limiting

In order to meet the California Engine Idle Limiting Standard, an engine idle shutdown feature has been built into the DDEC VI Engine Control Strategy. When the California Engine Idle Limiting feature is enabled, the engine will generally shut down after five minutes of continuous idling when the transmission is in neutral or park and the parking brake is set or after fifteen minutes when the transmission is in neutral or park and the parking brake is not set.

Activating or momentarily changing the position of the service brake pedal, the clutch pedal, Stop Engine Override, the accelerator pedal, or park brake status during the final 30 seconds before a shutdown would otherwise occur will prevent the engine from shutting down and will reset the shutdown timer. After an automatic shutdown, the engine may be restarted and operated normally.

The automatic shutdown feature is generally disabled on engines certified by the US EPA for use outside California but is required to be enabled for all California certified engines with the exception of engines used in specific vehicle types which the state of California has determined to be exempt from the idle shutdown requirement. These include buses, school buses, recreational vehicles, medium duty vehicles, military tactical vehicles, and authorized emergency vehicles as they are defined by the state of California. Owners of these vehicle types that wish to have the shutdown feature disabled should consult with California authorities to determine if their vehicles qualify for the exemption.

Idle Shutdown Timer

This feature is an optional 1 – 100 minute idle shutdown system. Its purpose is to conserve fuel by eliminating excessive idling and

allowing a turbocharger cool-down period. To activate the shutdown, the transmission must be in neutral with the vehicle parking brakes set and the engine in idle or fast-idle mode.

DDEC VI Operation

NOTE:

This engine is equipped with DDEC software. This software generally assures optimal engine performance. The installation of software upgrades may cause minor changes in features and engine performance.

Since the DDEC system is electronic, a battery is required to operate the computer. The system operates at 12 volts. However, in the event of a power supply malfunction, the system will continue to operate at reduced voltage. When this occurs, the AWL (Check Engine) will come on. See Figure 16.

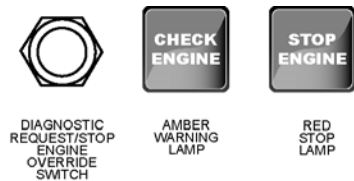

47471

Figure 16 Warning Lamps and SEO Switch

The engine will only operate at reduced rpm until the battery voltage reaches a point where the MCM will no longer function and the engine shuts down.

Should the AWL (Check Engine) come on for any reason, the vehicle can still be operated and the driver can proceed to the required destination. *This condition should be reported to an authorized Detroit Diesel distributor or dealer.*

NOTICE:

When the RSL (Stop Engine) comes on, the computer has detected a major malfunction in the engine that requires immediate attention. **It is the operator responsibility to shut down the engine to avoid serious damage.**

The engine can be configured to give a warning only, to ramp down (reduce power) or to shut down. Ramp down will reduce engine rpm to a pre-determined speed, but will not shut down the engine. With the 30-second shutdown option, the engine will begin a 30-second, stepped power-down sequence until it shuts down completely.

A "Stop Engine Override" can be procured in case the vehicle is to operate in a critical location.

Stop Engine Override Switch

This feature allows the operator to override the automatic stop engine sequence.

This is done by pressing the Stop Engine Override Switch every 15 to 20 seconds to prevent engine shutdown from occurring.

NOTE:

The Stop Engine Override Switch and the Diagnostic Request Switch are the same.

NOTE:

Holding down the Stop Engine Override Switch will not prevent the engine shutdown sequence. You must continue to reset the automatic shutdown system by pressing the Stop Engine Override Switch at intervals of approximately 15 to 20 seconds.

It takes 30 seconds from the time the automatic shutdown sequence begins until engine shutdown. Therefore, the operator *must* press the override switch just prior to engine shutdown and continue to do so until the vehicle can be brought to a stop in a safe location.

Immediate Speed Reduction

The immediate speed reduction option will bring engine rpm back to a predetermined speed, but will not shut down the engine.

The engine should not be restarted after it has been shut down by the engine protection system, unless the problem has been located and corrected.

Red Stop Lamp

The conditions that will cause the RSL (Stop Engine) to come on are:

- High coolant temperature
- Loss of coolant
- High oil temperature
- Low oil pressure
- Auxiliary shutdown

Whenever the AWL (Check Engine) or the RSL (Stop Engine) come on, the DDEC computer will determine where the problem is and will then store this information in its memory.

If the malfunction is intermittent, the lights will come on and go off as the computer senses the changing engine condition.

Diagnostic Tool

The diagnostic tool for DDEC VI is DDDL 7.0. DDDL 7.0 requires at

least a Pentium II computer with at least 256 MB of RAM.

Once the malfunction has been corrected, the DDEC system will return the engine to normal operation.

The temperature of air in the intake system is increased with the addition of an EGR. DDEC is programmed to reduce fueling (power) for a short time to reduce air and coolant temperatures when necessary.

DDEC will store an information code that this event occurred, but no corrective action is required as this action is designed to maintain operation without a noticeable affect on vehicle performance.

Flashing Malfunction Codes —

All malfunction codes are four digits. The malfunction code recorded in the computer memory will remain until it is erased by a technician.

The flashing malfunction code can also be obtained by the operator. To support flashing codes, a Stop Engine Override/Diagnostic Request Switch must be configured and the AWL (Check Engine) and RSL (Stop Engine) must be hard-wired. The CPC cannot flash these lamps if they are not hard-wired.

The flashing code feature may be activated by satisfying one of the following conditions:

- Engine speed is <100 rpm and the SEO switch is put in the ON position.
- Idle Governor is active and the SEO switch is put in the ON position.
- Vehicle speed is <3 mph and Park Brake is activated and the SEO switch is put in the ON position.

The flashing code feature is deactivated once the SEO switch is returned to the OFF position or the listed conditions are no longer satisfied.

Only one light will be flashing codes at any time. All codes will be flashed twice. The inter-digit pause is 1.5

seconds. The pause between codes is 3.5 seconds. The same 3.5 second pause occurs as the switch is made from RSL (Stop Engine) to AWL (Check Engine). See Figure 17.

When code flashing is initiated, the active codes will be flashed on the RSL (Stop Engine). Then the inactive codes will be flashed on the AWL (Check Engine). When all the inactive codes have been flashed, the process of flashing all the active codes followed by all the inactive codes will repeat until the conditions for code flashing are no longer satisfied.

If there are no active or inactive faults the number 3 is flashed once followed by an inter-code gap of 3 seconds.

RED - RSL

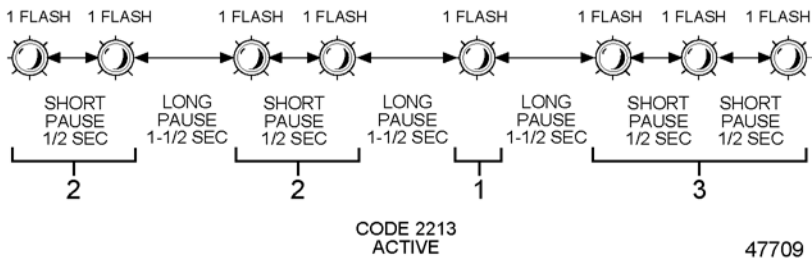

Figure 17 RSL (Stop Engine) Flashing Code Example

To Read Codes: Press and hold the SEO/Diagnostic Request Switch. Active codes will be flashed on the RSL (Stop Engine) first, followed by inactive codes being flashed on the AWL (Check Engine).

The codes will continue to flash and repeat as long as the Diagnostic Request Switch is held in the ON position. Both CPC and MCM faults are included.

Active Codes — The active codes will be flashed on the RSL (Stop Engine) in the order of most recent to least recent occurrence based on engine hours.

Inactive Codes — The inactive codes will be flashed on the AWL (Check Engine) in the order of most recent to least recent occurrence based on engine hours.

DDEC VI ENGINE DRIVING TIPS

Driving with an electronically controlled engine feels different from driving with a mechanically governed engine.

Accelerating the Vehicle

Engine response versus pedal movement may feel different from the mechanical-governed engine you were driving. The Accelerator Pedal (AP) was designed to communicate “percentage” foot pedal travel to the engine’s Motor Control Module (MCM). The engine will respond accordingly to the driver’s demand.

Another throttle or governor characteristic you may need time to get used to is the DDEC Limiting Speed Governor. This allows the driver to command total engine response between idle and rated speed, such as accelerating at half throttle – an advantage when driving under slippery conditions.

If you require wide-open throttle engine response, either accelerating or just plain pulling hard, the throttle AP will have to be held to the floor. To obtain 100% fueling at any speed, the AP will have to be maintained at the fully pressed position.

Cruise Control

For added driver convenience and comfort, DDEC VI also features a Cruise Control option that works just like the system in your car. It can be operated in any gear above 1000 rpm or road speed faster than 20 mph (32 kph), up to the rated engine speed. And it can be programmed to hold your road speed at or below the maximum vehicle speed. The switch to energize Cruise Control is usually mounted on the instrument panel. See Figure 18



47521

Figure 18 Typical Cruise Control Switches

Turn the switch ON to energize the system. Remember as a check after each engine start, DDEC VI looks for a one time activation of the clutch (if equipped) and service brake before DDEC VI allows Cruise Control to be enabled.

DDEC VI must also see or recognize that the Cruise Enable Switch has changed. If the Cruise Enable Switch is OFF it needs to be turned ON. If the Cruise Enable Switch is left in the ON position at key OFF, the switch must be cycled OFF then ON for DDEC VI to see a status change to allow Cruise Control activation. The status of DDEC VI inputs to activate Cruise Control at key ON is listed in Table 1.

Once Cruise Control is enabled and you reach your road speed, press the Set Switch to activate Cruise Control. The cruise light will come on. To increase road

speed in one mile-per-hour (1.6 kilometer-per-hour) increments, press the RSM/ACL Switch. To reduce road speed, press and hold the SET/CST Switch until the lower speed is reached.

Cruise Control is deactivated by slightly pressing the service brakes, clutch pedal, or trailer brake. The On/Off Switch will also deactivate Cruise Control.

Cruise Control will maintain vehicle speed even on up grades, unless power requirements demand a downshift. And, of course, Cruise Control does not limit your speed on down grades. Most likely, Cruise Control will feel stronger than driving with the foot pedal because of the instantaneous and wide-open throttle response. That's why Cruise Control use is not suggested during slippery driving conditions.

| Input | Status of Input at Key ON | Status of Input Before Cruise Control Activates |
|---|---------------------------|---|
| Service Brake Switch | ON | OFF |
| Clutch Release Switch (Manual Trans only) | ON | OFF |
| Cruise Control Enable Switch | OFF | ON |

Table 1 Input Status to Activate Cruise Control

Use Cruise Control after down shifting on a hill to pull the hill. Hitting the RSM/ACL Switch (not the Set Switch) will keep the truck accelerating in the lower gears up to the rated engine speed.

Cruise Control will disengage below 1000 rpm or 20 mph (32 kph) road speed. When using Cruise Control, if you want to pull the engine below 1000 rpm, remember to hold the throttle pedal to the floor to keep the engine pulling at wide-open throttle. The engine will pull to about 1050 rpm.

Remember: The electronic data programmed into the DDEC VI system will not allow you to hurt or overfuel the engine at low or “lug” engine speeds. There is enough oil pressure to withstand hard pulls at low engine speeds.

Engine Brakes and Cruise Control

If your engine is equipped with both Cruise Control and engine brake retarders, the engine retarders can operate automatically while you are in Cruise Control. If the Cruise Control/Engine Brake function is turned ON in the DDEC system programming, the engine retarders will come on “low” when your set road speed increases a few miles-per-hour (kilometers per hour)

above your cruise set speed. If your speed continues to increase, the DDEC system will increase the engine retarders' braking power progressively. When the vehicle returns to the set cruise speed, the engine retarders will turn off until you need them.

For safety reasons, don't use Cruise Control when it is not possible to keep the vehicle at constant speed due to:

- Winding roads
- Heavy traffic
- Slippery pavement
- Descending grades that call for engine brake assistance.

For an explanation of the engine brake retarder system and recommendations for proper operation, refer to ENGINE BRAKE SYSTEM.

Shifting

Depending on your transmission model, the gear split may vary from 500 to 300 rpm. The electronic governor provides almost no overrun capability; and, if the transmission is downshifted too early, you will experience a temporary loss of pulling power until the engine speed falls below rated speed.

In general, when using a 7- or 9-speed transmission, you should always downshift between 1250 and 1300 rpm. This is true even on steep grades with heavy loads. When using an 18-, 15- or 13-speed transmission, you will need to downshift at an rpm that allows “less than rated” rpm before throttle application in the next gear down. You may want to limit engine speed to 1900 rpm in all gears. The Series 60 provides horsepower through 2100 rpm, but fuel economy is not as efficient above 1800 rpm.

Low rpm operation should feel greatly enhanced due to the characteristics of the variable nozzle turbocharger. Engine response should be almost instantaneous below peak torque engine speeds. This should encourage progressive shifting especially during slow vehicle speed operation.

If you decide to drive at lower rpm's for improved fuel economy, don't let different engine noises throw you off guard. The Series 60 sounds quiet at 1400 rpm, almost as if it had quit pulling. If you had a boost gage to look at while driving, you would notice the turbocharger maintaining steady intake manifold pressure, even as rpm falls. Depending on the air intake arrangement, you may also experience a “chuffing” sound as the engine starts to pull hard at lower rpm's. This is caused by the velocity changes of the air flow within the air

intake plumbing. Electronic engines can actually deliver more fuel at lower engine speeds than at rated speed.

One difference you may notice with the EGR equipped engine is under hood noise. The gear train has been redesigned for quieter operation, and the EGR gas flow may be noticeable to the tuned attentive ear. The turbocharger operates at higher boost pressure forcing EGR gas flow through the EGR plumbing. In some situations the driver may believe he/she has experienced a charge air cooler system leak. Even connecting trailer light and air hoses, the driver may hear a different tone (exhaust and under hood with the engine idling.) If equipped with a turbo boost gage, the driver may occasionally note intake manifold pressure exceeds 35 psi.

Idling

The common belief that idling a diesel engine causes no engine damage is wrong. Idling produces sulfuric acid, which breaks down the oil and eats into bearings, rings, valve stems and engine surfaces. If you must idle the engine for cab heat or cooling, the *high idle* function of the Cruise Control switches should be used. An idle speed of 900 rpm should be enough to provide cab heat in above 32°F (0°C) ambients.

ENGINE BRAKE SYSTEM

Certain Series 60 vehicle engines are equipped with engine brakes, commonly referred to as *retarders*. Before operating the vehicle, you *must* familiarize yourself with the retarder system to obtain optimum benefit from it. Engine brake control systems may vary slightly, depending on the engine brake configuration and cab design. However, basic operator controls are similar for all models.

Driver Control Switches

Vehicles with manual transmissions allow the driver to turn the engine brake on and off and select a low, medium or high level of braking. Two types of switches are available.

Low/High Switch

The “Low” setting on this switch activates three (3) brake cylinders, supplying approximately 50% of normal engine braking horsepower. The “High” setting activates all six (6) cylinders, providing full engine braking horsepower.

Low/Med/High Switch

The “Low” setting on this switch activates two (2) brake cylinders, yielding about one-third engine braking horsepower. The “Medium” activates four (4) cylinders, supplying

about two-thirds engine braking horsepower. The “High” setting activates all six (6) cylinders, providing full engine braking horsepower.

Clutch Pedal and Throttle Position Controls

Engine brakes have two additional controls, one activated by the position of the clutch pedal and the other activated by the position of the throttle. These controls permit fully automatic operation of the engine braking system.

Engine Brake Operation

The engine brake retarder system depends on a full-pressure flow of warm engine lubricating oil for proper lubrication of moving parts and optimum performance. .

| NOTICE: |
|--|
| Always allow the engine to reach full normal operating temperature before activating the engine brake system to ensure positive engine brake engagement. |

**CAUTION:****LOSS OF VEHICLE CONTROL**

To avoid injury from loss of vehicle control, do not activate the Engine Brake system under the following conditions:

- **On wet or slippery pavement, unless the vehicle is equipped with ABS (anti-lock braking system) and you have had prior experience driving under these conditions.**
- **When driving without a trailer (bobtailing) or pulling an empty trailer.**
- **If the tractor drive wheels begin to lock or there is fishtail motion after the Engine Brake is activated, deactivate the brake system immediately if this occurs.**

Under normal driving conditions the engine brake system is left in the ON position. However, this should change if roads become wet or slippery.

After it is switched on, the engine brake system is automatically activated each time you remove your feet completely from the clutch pedal and throttle. The engine brake automatically deactivates itself when

you press the clutch pedal while shifting gears.

NOTICE:

Do not attempt to “double clutch” the transmission while the engine brake system is turned on. Shifting gears without pressing the clutch or using the engine brake to reduce engine rpm may result in serious powertrain damage.

NOTE:

Some systems may be programmed to activate themselves only when the brake pedal is pressed, so read your vehicle owner's manual thoroughly to find out if you have this option.

Anti-Lock Braking Systems

Vehicles equipped with ABS (anti-lock braking systems) have the ability to turn the engine brake retarder OFF if a wheel-slip condition is detected. The engine brake will automatically turn itself ON once the wheel slip is no longer detected.

The DDEC system will deactivate the engine brake system when the engine speed falls below 1000 rpm or when the vehicle slows down to a pre-set speed, depending on DDEC programming. This prevents stalling the engine. Engine brakes can also be used with vehicle Cruise Control TURNED ON.

Driving on Flat, Dry Pavement

Use the following guidelines when driving on flat, dry pavement:

1. If driving on flat, dry, open stretches with a light load and greater slowing power is not required, place the progressive braking switch in the LOW position.
2. If you find you are still using the service brakes, move the switch to a higher position until you do not need to use the service brakes to slow the vehicle down.
3. If you are carrying a heavier load and road traction is good, move the progressive braking switch to the "High" position.
4. Check your progressive braking switch often for proper position, since road conditions can change quickly. *Never skip a step when operating the progressive braking switch.* Always go from OFF

to LOW, and then to a higher position.

Descending a Long, Steep Grade

An explanation of "control speed" may be helpful in understanding how to use the engine brake system while descending a grade. *Control Speed* is the constant speed at which the forces pushing the vehicle forward on a grade are equal to the forces holding it back, without using the vehicle service brakes. In other words, *this is the speed the vehicle will maintain without using the service brakes or fueling.*

Use the following guidelines when descending a long, steep grade:

1. Before beginning the descent, determine if your engine brake system is operating properly by lifting your foot briefly off the throttle. You should feel the system activate.

**CAUTION:****BRAKE FADE**

To avoid injury, do not over apply the vehicle service brakes when descending a long, steep grade. Excessive use of the vehicle brakes will cause them to heat up, reducing their stopping ability. This condition, referred to as "brake fade", may result in loss of braking, which could lead to personal injury or vehicle/property damage or both.

2. Ensure the progressive braking switch is in the appropriate power position.

**WARNING:****PERSONAL INJURY**

Failure to keep the vehicle within safe control speed limits while descending a grade may result in loss of vehicle control, which could cause personal injury.

NOTICE:

Failure to keep the vehicle within safe control speed limits while descending a grade may result in vehicle or property damage or both.

3. Do not exceed the *safe control speed* of your vehicle. Example: You could descend a 6% grade, under control only at 10 mph (16 kph) without an engine brake, but at 25 mph (40 kph) with an engine brake. You could not descend that same hill at 50 mph (80 kph) and still expect to remain under control. Get to know how much slowing power your engine brake can provide. So get to know your engine brake system *before* climbing hills and do not exceed a safe control speed.
4. Check your progressive braking switch often for proper position, since road conditions can change quickly. *Never skip a step when operating the progressive braking switch.* Always go from OFF to LOW and then to a higher position when on slippery roads.

Driving on Wet or Slippery Pavement

Do not attempt to use the engine brake system on wet or slippery roads until you have some experience with it on dry pavement.



CAUTION:

LOSS OF VEHICLE CONTROL

To avoid injury from loss of vehicle control, do not activate the Engine Brake system under the following conditions:

- **On wet or slippery pavement, unless the vehicle is equipped with ABS (anti-lock braking system) and you have had prior experience driving under these conditions.**
- **When driving without a trailer (bobtailing) or pulling an empty trailer.**
- **If the tractor drive wheels begin to lock or there is fishtail motion after the Engine Brake is activated, deactivate the brake system immediately if this occurs.**

keep the trailer stretched out. Follow the manufacturer's recommended operating procedure when using your trailer brakes.

On wet or slippery pavement, start with the master switch in the OFF position and use the gear you would normally use under these conditions.

If the vehicle is maintaining traction, place the selective braking switch in the LOW position and turn ON the engine brake system. If the drive wheels are maintaining traction and you desire greater slowing power, move the braking switch to the next highest position.

However, if the tractor drive wheels begin to lock or there is a fishtail motion, *turn the engine brake system OFF immediately and do not activate it until road conditions improve.*

Check your progressive braking switch often for proper position, since road conditions can change quickly. Never skip a step when operating the progressive braking system. Always go from OFF to LOW and then to a higher position.

NOTE:

On single trailers or combinations, a light air application of the trailer brakes may be desirable to help

ENGINE SYSTEMS

The engine systems are the following:

allowable air restriction has been reached, or annually, whichever occurs first.

Fuel System

The fuel system consists of DDEC, fuel injectors, fuel manifolds (integral with the cylinder head), fuel pump, a cooling plate for the Motor Control Module (MCM), primary and secondary fuel filters, and the necessary connecting fuel lines.

Lubrication System

The lubricating oil system consists of an oil pump, oil cooler, two full-flow oil filters, bypass valves at the oil pump and oil filter adaptor, and oil pressure regulator valve in the cylinder block vertical oil gallery.

Air System

The outside air drawn into the engine passes through the air filter and is pulled into the turbocharger and compressed. It then moves to the air-to-air charge cooler (heat exchanger) and is cooled. Next it flows to the intake manifold and into the cylinders, where it mixes with atomized fuel from the injectors.

For optimum protection of the engine from dust and other airborne contaminants, service the dry type air cleaners used *when the maximum*

Cooling System

A radiator/thermo-modulated fan cooling system is used on Series 60 engines. This system has a centrifugal type fresh water pump to circulate coolant within the engine. Two full-blocking type thermostats located in a housing attached to the right side of the cylinder head control the flow of coolant.

Electrical System

The electrical system consists of a starting motor, starting switch, battery-charging alternator, storage batteries, and the necessary wiring.

Exhaust System

Hot exhaust gas flowing from the exhaust manifold into the exhaust riser is used to drive the turbocharger.

Exhaust Gas Recirculation System

The purpose of the Exhaust Gas Recirculation System (EGR) is to reduce engine exhaust gas emissions in accordance with EPA regulations.

AFTERTREATMENT SYSTEM

In order to meet current emissions regulations, the traditional muffler has been replaced by a new Aftertreatment Device (ATD). This device consists of a Diesel Oxidation Catalyst (DOC) and a Diesel Particulate Filter (DPF). Together these two components burn off collected particulate matter in a process called “regeneration.” The

key to successful regeneration is high exhaust temperature for an extended period of time. Without adequate temperatures for regeneration, the filter will continue to trap particulates and eventually plug. In order to avoid plugging, Detroit Diesel has designed an actively regenerated Aftertreatment System (ATS). See Figure 19.

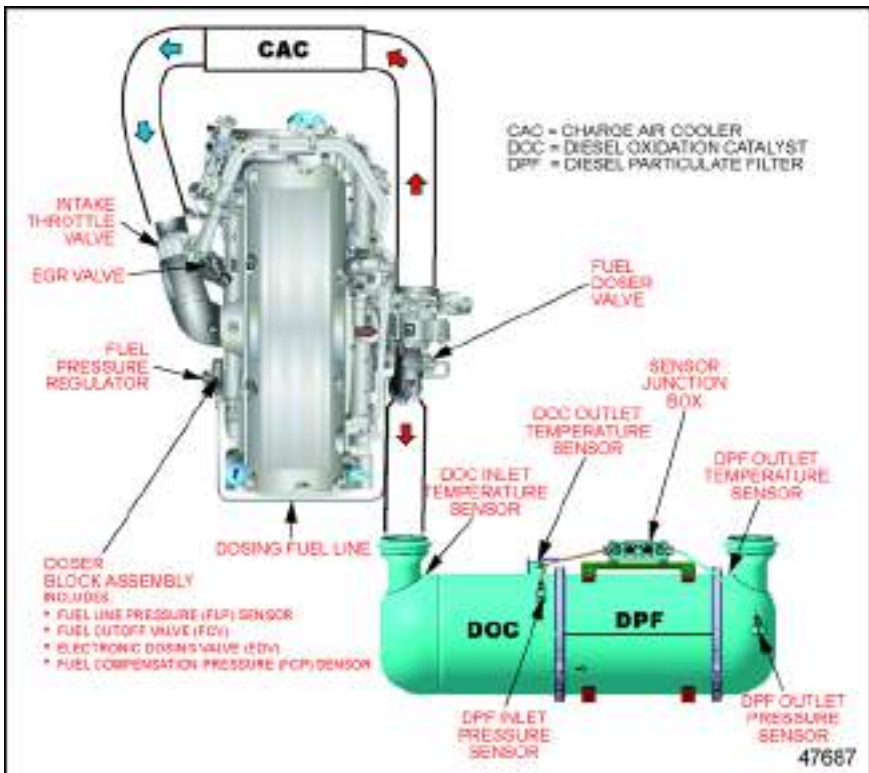

Figure 19 Aftertreatment System

Operating Requirements

Oxidation of the particulate matter is the key to filter performance. This requires that the catalyzing agent (platinum coated passages) are providing optimum enhancement to the oxidation process. The following requirements must be met, otherwise the ATD warranty may be compromised:

NOTICE:

Do not use kerosene or fuel blended with used lube oil.

- Use Ultra-Low Sulfur Fuel (ULSF) with 15 ppm (0.0015 wt%) sulfur content or less, based on ASTM D2622 test procedure
- Lube oil must have a sulfated ash level less than 1.0 wt %; currently referred to as CJ-4 oil.

NOTICE:

Not following the operating requirements may result in damage to the ATD or accelerated ash plugging of the diesel particulate filter.

Maintenance

A high amount of black smoke emitting from the vehicle or illumination of the Amber Warning Lamp or Red Stop Lamp are indications of a system problem. Should this occur, refer to the *Aftertreatment System Technician's Guide* (7SE63), or contact the Detroit Diesel Customer Support Center at 313-592-5800.

Illumination of the Diesel Particulate Filter (DPF) Regeneration Lamp indicates that a parked regeneration is required.

There is a need to periodically remove accumulated ash, derived from engine lube oil, from the filter. This ash does not oxidize in the filter during the regeneration process and must be removed through a cleaning procedure. All Detroit Diesel ATD equipped engines will illuminate a dashboard warning lamp indicating the need for ash cleaning. For information on this cleaning procedure, refer to the *Aftertreatment System Technician's Guide* (7SE63), or contact the Detroit Diesel Customer Support Center at 313-592-5800.

Parked Regeneration Procedure

Regeneration of the ATS is fundamental for the oxidation of soot. This process happens during the normal operation cycle of the vehicle; it can occur both passively and actively. Regardless of this, the operator will see no difference in vehicle performance or vehicle control. If the ATS is not capable of completing an over-the-road regeneration due to duty cycle constraints or other restrictions, a parked regeneration may need to occur.

The driver will be notified of the need for a DPF regeneration by illumination of the DPF Regeneration Lamp. Refer to section DRIVER ACTIONS .

NOTE:

If the DDEC VI electronics have not requested the initiation of a parked regeneration (the DPF Regeneration Lamp is not illuminated), the Regen request switch is disabled.

NOTE:

The driver **MUST** stay with the vehicle throughout the regeneration process.

NOTE:

Not all vehicles may be equipped with a Regen request switch due to application or user specification.

NOTE:

The procedure will take up to 40 minutes (depends on engine type and the amount of soot accumulated in the filter).

To initiate a parked regeneration, perform the following:

1. Keep engine at slow idle (cannot be in PTO mode).
2. Transmission is in neutral with parking brake ON.
3. Cycle the parking brake from OFF to ON.

NOTE:

Air tank pressure must be high enough for the parking brake switch to hold in the OFF position.

4. Press and release clutch pedal (if equipped with clutch pedal).
5. Cycle transmission to DRIVE and back to NEUTRAL (if not equipped with clutch pedal).
6. Hold DPF Switch in the ON position for five seconds and then release (engine speed will increase and DPF Lamp will go out).



The regeneration will take up to 40 minutes.

The regeneration is completed when the engine returns to low idle and the DPF Lamp remains off. The High Exhaust System Temperature (HEST) Lamp will remain on but the vehicle can be driven.

If the Parked Regeneration exits and the DPF Lamp remains on, repeat the procedure. If the second try also fails, contact the Detroit Diesel Customer Support Center at (313) 592-5800.

NOTE:

A Parked Regeneration will stop if the key is turned to the OFF position, the vehicle is put into gear, or the parking brake is released.

Hazardous Applications

The MCM should be configured to not allow automatically triggered over-the-road regenerations (DPF Manual Regen Only Enable = Enabled).

NOTE:

This is for hazardous applications only.

There are two CPC options:

- DPF Stationary Regen Only = 0-Disabled
- DPF Stationary Regen Only = 1-Enabled

DPF Stationary Regen Only = 0-Disabled — This option allows the DPF Regen Switch to request a parked regeneration if the parked regeneration entry conditions are met. This option also allows MCM-initiated over-the-road regenerations to occur.





DPF Stationary Regen Only = 1-Enabled — This option **only** allows a parked regeneration to occur by using the DPF Regeneration Switch. The MCM will be unable to initiate an active over-the-road regeneration when this option is enabled.

Service Record

It is mandatory that customers or distributors maintain a proper record of the particulate filter servicing and cleaning. This record is an agent to warranty considerations. The record must include information such as:

- Date of cleaning or replacement
- Vehicle mileage at the time of cleaning or replacement
- Particulate filter part number and serial number

DRIVER ACTIONS

| Name | Indicator Lamp | Description | Driver Action |
|---|---|---|--|
| High Exhaust System Temperature (HEST) Lamp |  | <p>SOLID: Exhaust is at high temperature and vehicle is at low speed or parked.</p> <p>FLASHING: A Parked Regeneration is in process and the system is not up to temperature.</p> | No change in driving style is required. |
| Malfunction Indicator Lamp (MIL) |  | Indicates a failure of an Emission Control Device. The MIL may illuminate at the same time as the Check Engine Lamp. | Vehicle can be driven to end of the shift. If the MIL remains on after three drive cycles, call for service. |
| DPF Regeneration Lamp |  | <p>SOLID: Indicates that a Regeneration may be needed.</p> <p>FLASHING: Indicates that a Regeneration is required as soon as possible.</p> | Perform a Parked Regeneration OR bring vehicle to highway speeds to allow for an Automatic Regeneration. |
| DPF Regeneration Lamp + Check Engine Lamp |  FLASHING +  | Indicates that a Parked Regeneration MUST be performed. | A Parked Regeneration must be performed. <u>ENGINE DERATE</u> |



| Name | Indicator Lamp | Description | Driver Action |
|---|---|---|---|
| DPF Regeneration Lamp + Check Engine Lamp + Red Stop Lamp (RSL) |  FLASHING +  +  | Indicates that a Parked Regeneration <u>MUST</u> be performed. | A Parked Regeneration must be performed. <u>ENGINE DERATE</u> |

Table 2 Driver Actions

INSTRUMENT PANEL LAMPS





| Lamp | Lamp Name | Description | Results |
|---|---|--|--|
|  | Amber Warning Lamp (AWL) | Indicates a fault with the engine controls. | Vehicle can be driven to end of shift. Call for service. |
|  | Red Stop Lamp (RSL) | Indicates a major engine fault that may result in engine damage. Engine derate and/or shutdown sequence will be initiated. | Move the vehicle to the nearest safe location and shutdown the engine. Call for service |
|  | DPF Regeneration Lamp | Solid yellow indicates a parked regeneration is required. Blinking yellow, derate, and/or shutdown are possible as soot load continues to increase. Lamp will shut off during parked regeneration. | <u>Lamp Solid</u> - parked regeneration required <u>Lamp Flashing</u> - parked regeneration required immediately. |
|  | High Exhaust System Temperature Lamp (HEST) | Indicates exhaust temperature is above a preset limit and the unit is operating at low vehicle speed. Lamp flashes once every ten seconds during a parked regen. Lamp is yellow. | Vehicle can be driven. |
|  | Malfunction Indicator Lamp (MIL) | Yellow lamp Indicates a failure of an Emission Control device. May illuminate at the same time as the Amber Warning Lamp | Vehicle can be driven to end of the shift. Call for service |

Table 3 Instrument Panel Lamps

The activation conditions are listed in Table 4.





| Lamp | Lamp Solid | Lamp Flashing |
|---|--|--|
|  | <ul style="list-style-type: none"> □ At the start of every ignition cycle (a bulb check). □ When an electronic system fault occurs (problem should be diagnosed as soon as possible). | <ul style="list-style-type: none"> □ Diagnostic Request Switch is used to activate the AWL to flash inactive codes. □ Last 90 seconds before idle shutdown if programmed for override. □ Idle shutdown or the Optimized Idle shutdown occurs. |
|  | <ul style="list-style-type: none"> □ At the start of every ignition cycle (a bulb check). □ A potential engine damaging fault is detected. | <ul style="list-style-type: none"> □ When Engine Protection Shutdown occurs. □ Diagnostic Request Switch is used to activate the RSL to flash active codes. |
|  | <ul style="list-style-type: none"> □ Parked regeneration is required. □ At the start of every ignition cycle (a bulb check). | When a parked regeneration is required immediately (If the lamp flashing is ignored, derate and/or shutdown could occur). |
|  | <ul style="list-style-type: none"> □ At the start of every ignition cycle (a bulb check). □ Vehicle speed is less than 5 mph and the DPF outlet temperature is greater than 977°F (525°C). | Flashes every 10 seconds during a parked regen |
|  | <ul style="list-style-type: none"> □ At the start of every ignition cycle (a bulb check). □ For any emission related fault (light out when the fault is inactive) | Never flashes |

Table 4 Lamp Activation Conditions

MAINTENANCE

The following is intended as a guide for establishing preventive maintenance intervals. The recommendations given should be followed as closely as possible to obtain long life and optimum performance from your engine. Maintenance intervals indicated are time (hours) of actual operation.

The intervals shown apply only to the maintenance functions described. These functions should be coordinated with other regularly scheduled maintenance.

Scheduled Intervals

A description of the maintenance to be performed for each item in the following tables can be found in the Preventive Maintenance Intervals section.

Recommended maintenance intervals for Series 60 on-highway truck and parlor coach engines are listed in Table 5, Table 6 and Table 7. Recommended maintenance intervals for Series 60 fire fighting, crash/rescue, and emergency vehicle engines are listed in Table 8, Table 9, and Table 10. Recommended maintenance intervals for Series 60 crane engines are listed in Table 11, Table 12, and Table 13.

NOTICE:

Failure to check and maintain SCA (supplemental coolant additive) levels at required concentrations will result in severe damage (corrosion) to the engine cooling system and related components. Coolant must be inhibited with the recommended SCAs listed in this guide. Refer to "How to Select Coolant". In addition, the engine can be equipped with a coolant filter/inhibitor system as an installed option or as an after-sale item.

| Item | Daily Checks | 7,500 Miles (12,000 Km) | 30,000 Miles (48,280 Km) |
|-----------------------------|--|-------------------------|--------------------------|
| 1. Lubricating Oil | I | | R |
| 2. Fuel Tank | I | | |
| 3. Fuel Lines & Flex Hoses | I | | |
| 4. Cooling System | I | | |
| 5. Turbocharger | I | | I |
| 6. Battery | | I | |
| 7. Aftertreatment Device | Inspect every 6 months or 15,000 miles (24,000 Km) | | |
| 8. Drive Belts | | I | |
| 9. Air Compressor | | I | |
| 10. Air Cleaner | | | I |
| 11. Lube Oil Filters | | | R |
| 12. Fuel Filters | | | R |
| 13. Coolant/Inhibitor Level | | | I |

All items are described in Preventive Maintenance Intervals.

I – Inspect, service, correct or replace as necessary.

R – Replace.

Table 5 On-Highway Truck and Parlor Coach Daily, 7,500 Mile, and 15,000 Mile Checks

| Months | 6 | 12 | 18 | 24 | 30 | 36 | 42 | 48 | 54 | 60 |
|------------------------------------|---|-----------|-----------|-----------|------------|------------|-------------|-------------|-------------|-------------|
| Miles/Km (X 1000) | 15/ 24 | 30/ 48 | 45/ 72 | 60/ 96 | 75/ 120 | 90/ 144 | 105/ 168 | 120/ 192 | 135/ 216 | 150/ 240 |
| Item | Procedure | | | | | | | | | |
| 1. Lubricating Oil | Replace every 30,000 miles (48,280 km). | | | | | | | | | |
| 2. Fuel Tank | | I | | I | | I | | I | | I |
| 4. Cooling System | | | | I | | | | I | | |
| 5. Turbocharger | I | I | I | I | I | I | I | I | I | I |
| 7. Aftertreatment Device | Inspect every 6 months or 15,000 miles (24,000 Km) Severe Duty: ash removal at 550,000 miles (893,185 Km) Short-Haul: ash removal at 550,000 miles (893,185 Km) Long-Haul: ash removal at 550,000 miles (893,185 Km) | | | | | | | | | |
| 8. Drive Belts | I | I | I | I | I | I | I | R | I | I |
| 9. Air Compressor | I | I | I | I | I | I | I | I | I | I |
| 11. Lube Oil Filter | Replace when lubricating oil is changed. | | | | | | | | | |
| 12. Fuel Filters | R | R | R | R | R | R | R | R | R | R |
| 13. Water Pump/ Inhibitor Level | I | I | I | I | I | I | I | I | I | I |
| 14. Cranking Motor | Follow manufacturer's recommendations. | | | | | | | | | |
| 15. Air System | I | I | I | I | I | I | I | I | I | I |
| 16. Exhaust System | I | I | I | I | I | I | I | I | I | I |

All items are described in Preventive Maintenance Intervals.

I – Inspect, service, correct or replace as necessary.

R – Replace.

Table 6 On-Highway Truck and Parlor Coach Regular Maintenance Intervals

| Months | 6 | 12 | 18 | 24 | 30 | 36 | 42 | 48 | 54 | 60 |
|-------------------------------------|--|-----------|-----------|-----------|------------|------------|-------------|-------------|-------------|-------------|
| Miles/Km (X 1000) | 15/ 24 | 30/ 48 | 45/ 72 | 60/ 96 | 75/ 120 | 90/ 144 | 105/ 168 | 120/ 192 | 135/ 216 | 150/ 240 |
| Item | Procedures | | | | | | | | | |
| 17. Engine (Steam Clean) | | | | I | | | | I | | |
| 18. Radiator & A/A Charge Cooler | | I | | I | | I | | I | | I |
| 19. Oil Pressure | | | | I | | | | I | | |
| 20. Battery Charging Alternator | I | I | I | I | I | I | I | I | I | I |
| 21. Engine & Transmission Mounts | | | | I | | | | I | | |
| 22. Crankcase Pressure | | | | I | | | | I | | |
| 23. Fan Hub | | | | | | | | I | | |
| 24. Thermostats & Seals | | | | | | | | I | | |
| 25. Crankcase Breather | | | | | | | | I | | |
| 26. Engine Tune-Up | | | | I | | | | | | |
| 27. Vibration Damper | Replace at major engine overhaul or earlier if dented or leaking. | | | | | | | | | |

All items are described in Preventive Maintenance Intervals.

I – Inspect, service, correct or replace as necessary.

R – Replace.

Table 7 On-Highway Truck and Parlor Coach Regular Maintenance Intervals (continued)

| Item | Daily Checks | 100 Hours or 3,000 Miles (4,800 Km) | 300 Hours or 6,000 Miles (9,600 Km) |
|---------------------------------|--|--------------------------------------|--------------------------------------|
| 1. Lubricating Oil | I | | R |
| 2. Fuel Tank | I | | |
| 3. Fuel Lines & Flexible Hoses | I | | |
| 4. Cooling System | I | | |
| 5. Turbocharger | I | | |
| 6. Battery | | I | |
| 7. Aftertreatment Device | Inspect every 6 months or 15,000 miles (24,000 Km) | | |
| 8. Drive Belts | | I | |
| 9. Air Compressor | | | I |
| 10. Air Cleaner | | | I |
| 11. Lube Oil Filter | | | R |
| 12. Fuel Filters | | | R |
| 13. Coolant/ Inhibitor Level | | | I |
| 18. Radiator | | | I |
| 20. Battery Charging Alternator | | | I |

All items are described in Preventive Maintenance Intervals.

I – Inspect, service, correct or replace as necessary.

R – Replace.

Table 8 Fire Fighting, Crash/Rescue and Emergency Vehicle Engine Daily, 100 Hour and 300 Hour Checks

| Hours | 300 | 600 | 900 | 1,200 | 1,500 |
|------------------------------------|--|-------------|-------------|-------------|-----------|
| Miles/Km (X 1000) | 6/ 9.6 | 12/ 19.6 | 18/ 28.8 | 24/ 38.4 | 30/ 48 |
| Item | Procedures | | | | |
| 1. Lubricating Oil | Change every 300 hours or 6,000 miles (1,600 km), whichever comes first. | | | | |
| 2. Fuel Tank | I | I | I | I | I |
| 4. Cooling System | | I | | I | |
| 5. Turbocharger | | | | | |
| 7. Aftertreatment Device | Inspect every 6 months or 15,000 miles (24,000 Km) Severe Duty: ash removal at 400,000 miles (643,720 Km) Short-Haul: ash removal at 500,000 miles (804,650 Km) Long-Haul: ash removal at 600,000 miles (965580 Km) | | | | |
| 9. Air Compressor | I | I | I | I | I |
| 11. Lube Oil Filters | Replace when lubricating oil is changed. | | | | |
| 12. Fuel Filters | R | R | R | R | R |
| 13. Water Pump/ Inhibitor Level | I | I | I | I | I |
| 14. Cranking Motor | Follow manufacturer's recommendations. | | | | |
| 15. Air System | I | I | I | I | I |
| 16. Exhaust System | I | I | I | I | I |

All items are described in Preventive Maintenance Intervals.

I – Inspect, service, correct or replace as necessary.

R – Replace.

Table 9 Fire Fighting, Crash/Rescue and Emergency Vehicle Engine Regular Maintenance Intervals

| Hours | 300 | 600 | 900 | 1,200 | 1,500 |
|----------------------------------|---|---------|---------|---------|-------|
| Miles/Km (X 1000) | 6/9.6 | 12/19.3 | 18/28.8 | 24/38.4 | 30/48 |
| Item | Procedures | | | | |
| 17. Engine (Steam Clean) | | | | | |
| 18. Radiator & A/A Charge Cooler | I | I | I | I | I |
| 19. Oil Pressure | | I | | I | |
| 20. Battery Charging Alternator | I | I | I | I | I |
| 21. Engine & Transmission Mounts | | I | | I | |
| 22. Crankcase Pressure | | I | | I | |
| 23. Fan Hub | | | | I | |
| 24. Thermostats & Seals | | | | | |
| 25. Crankcase Breather | | | | I | |
| 26. Engine Tune-Up | | | | | I |
| 27. Vibration Damper | Replace at major engine overhaul or earlier if dented or leaking. | | | | |

All items are described in Preventive Maintenance Intervals.

I – Inspect, service, correct or replace as necessary.

R – Replace.

Table 10 Fire Fighting, Crash/Rescue and Emergency Vehicle Engine Regular Maintenance Intervals (continued)

| Item | Daily Checks | 100 Hr or 3,000 Mi | 150 Hr or 4,500 Mi | 200 Hr or 6,000 Mi | 300 Hr or 9,000 Mi |
|---------------------------------|--------------|--------------------|--------------------|--------------------|--------------------|
| 1. Lubricating Oil | I | | | | |
| 2. Fuel Tank | I | | | | I |
| 3. Fuel Lines & Flexible Hoses | I | | | | |
| 4. Cooling System | I | | | | |
| 5. Turbocharger | I | | | | |
| 6. Battery | | I | | | |
| 7. Tachometer Drive | | | I | | |
| 8. Drive Belts | | I | | | |
| 9. Air Compressor | | | I | | |
| 10. Air Cleaner | | | I | | |
| 11. Lube Oil Filters | | — | | | |
| 12. Fuel Filters | | | R | | |
| 13. Coolant/ Inhibitor Level | | | | I | |
| 18. Radiator | | | | | I |
| 20. Battery Charging Alternator | | | | | I |

All items are described in Preventive Maintenance Intervals.

I – Inspect, service, correct or replace as necessary.

R – Replace.

Table 11 Crane Engine Daily, 100 Hour, 150 Hour, 200 Hour, and 300 Hour Checks

| Hours | 150 | 300 | 450 | 600 | 750 | 900 | 1050 | 1200 | 1350 | 1500 |
|--------------------------------------|--|--------------|---------------|-------------|-------------|-------------|---------------|-------------|---------------|-----------|
| Miles/Km (X 1000) | 4.5/ 7.2 | 9.0/ 14.4 | 13.5/ 21.6 | 18/ 28.8 | 22.5/ 36 | 27/ 43.2 | 31.5/ 50.4 | 36/ 57.6 | 40.5/ 64.6 | 45/ 72 |
| Item | Procedures | | | | | | | | | |
| 1. Lubricating Oil | Change lubricating oil every 250 hours or 1 year, whichever comes first. | | | | | | | | | |
| 2. Fuel Tank | | I | | I | | I | | I | | I |
| 4. Cooling System | | | | I | | | | I | | |
| 5. Turbocharger | I | I | I | I | I | I | I | I | I | I |
| 7. Tachometer Drive | I | I | I | I | I | I | I | I | I | I |
| 8. Drive Belts | I | I | I | I | I | I | I | R | I | I |
| 9. Air Compressor | I | I | I | I | I | I | I | I | I | I |
| 11. Lube Oil Filters | Replace when lubricating oil is changed. | | | | | | | | | |
| 12. Fuel Filters | R | R | R | R | R | R | R | R | R | R |
| 13. Coolant Pump/ Inhibitor Level | I | I | I | I | I | I | I | I | I | I |
| 14. Cranking Motor | Follow manufacturer's recommendations. | | | | | | | | | |
| 15. Air System | I | I | I | I | I | I | I | I | I | I |

All items are described in Preventive Maintenance Intervals.

I – Inspect, service, correct or replace as necessary.

R – Replace.

Table 12 Crane Regular Maintenance Intervals

| Hours | 150 | 300 | 450 | 600 | 750 | 900 | 1050 | 1200 | 1350 | 1500 |
|--|--|--------------|---------------|-------------|-------------|-------------|---------------|-------------|---------------|-----------|
| Miles/Km (X 1000) | 4.5/ 7.2 | 9.0/ 14.4 | 13.5/ 21.6 | 18/ 28.8 | 22.5/ 36 | 27/ 43.2 | 31.5/ 50.4 | 36/ 57.6 | 40.5/ 64.6 | 45/ 72 |
| Item | Procedures | | | | | | | | | |
| 16. Exhaust System | I | I | I | I | I | I | I | I | I | I |
| 17. Engine (Steam Clean) | | | | | | | | | | |
| 18. Radiator & A/A Charge Cooler | | I | | I | | I | | I | | I |
| 19. Oil Pressure | | | | I | | | | I | | |
| 20. Battery Charging Alternator | | I | | I | | I | | I | | I |
| 21. Engine & Transmission Mounts | | | | I | | | | I | | |
| 22. Crankcase Pressure | | | | I | | | | I | | |
| 23. Fan Hub | | | | | | | I | | | |
| 24. Thermostats & Seals | | | | | | | | | | |
| 25. Crankcase Breather | | | | | | | I | | | |
| 26. Engine Tune-Up | | | | | | | | | | I |
| 27. Vibration Damper | Replace at major engine overhaul or earlier if dented or leaking. | | | | | | | | | |

All items are described in Preventive Maintenance Intervals.

I – Inspect, service, correct or replace as necessary.

R – Replace.

Table 13 Crane Regular Maintenance Intervals (continued)

Preventive Maintenance Intervals

This section describes the items listed in the maintenance interval tables.

The “Daily” instructions apply to routine or daily starting of the engine. They do not apply to a new engine or one that has been operated for a considerable period of time.

For new or stored engines, refer to the *Series 60 Service Manual* (6SE483). Follow instructions in Section 13.1 under *Preparations for Starting the Engine the First Time*.

Preventive maintenance other than the “Daily” checks should be performed by authorized Detroit Diesel service outlets. These outlets have the trained personnel and special tools to properly perform all services.

Item 1 – Lubricating Oil

Check the oil level daily with the engine stopped. If the engine has just been stopped and is warm, wait approximately 20 minutes to allow the oil to drain back into the oil pan before checking. The dipstick has an operating range identified by a crosshatch. If the oil meniscus is within this crosshatch range then the oil range is adequate for engine operation.

Add the proper grade of oil to maintain the satisfactory range on the dipstick. See Figure 20.

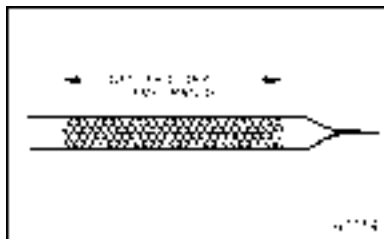

Figure 20 Check Oil Level Daily

NOTICE:

When adding lubricating oil, do not overfill. Oil may be blown out through the crankcase breather if the crankcase is overfilled.

All diesel engines are designed to use some oil, so the periodic addition of oil is normal. See Figure 21 to determine the degree of oil usage.

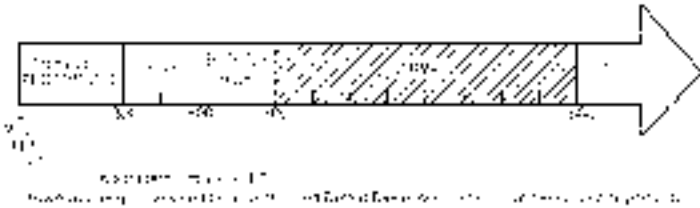

Figure 21 Engine Oil Consumption Guidelines

NOTICE:

If the oil level is constantly above normal and excess oil has not been added to the crankcase, consult with an authorized Detroit Diesel service outlet for the cause. Fuel or coolant dilution of lubricating oil can result in serious engine damage.

Before adding lubricating oil, refer to *How to Select Lubricating Oil* in this guide. Change lubricating oil and filters at the intervals listed in Table 14 when using fuel with a sulfur content of less than 0.05 mass percent. When using fuel with a higher sulfur content, refer to *When to Change Oil* in this guide.

| Service Application | Lube Oil and Filter Change Interval* |
|---|--|
| Highway Truck & Motor Coach | 30,000 Miles (48,280 Kilometers) — Long Haul |
| | 20,000 Miles (32,000 Kilometers) — Short Haul |
| | 15,000 Miles (24,000 Kilometers) — Severe |
| Fire Fighting, Crash/Rescue, & Emergency Vehicles | 6,000 Miles (9,600 Kilometers), 300 Hours or 1 Year, whichever comes first |

* Change both full-flow filters when lube oil is changed.

Table 14 Recommended Engine Oil Drain and Filter Change Intervals (Diesel Fuel Sulfur Content Less Than 0.05 Mass % (0.0015 wt%))

Item 2 – Fuel and Fuel Tank

Keep the fuel tank filled to reduce condensation. See Figure 22.



Figure 22 Filled Fuel Tank

Before adding fuel, refer to *How to Select Diesel Fuel* in the *HOW-TO SECTION* of this guide.

Refill the tank at the end of each day's operation to prevent condensation from contaminating the fuel.

Condensation formed in a partially filled tank promotes the growth of microorganisms that can clog fuel filters and restrict fuel flow.

To prevent microbe growth, add a biocide to the fuel tank or primary fuel supply. Water accumulation can be controlled by using additives containing methyl carbitol or butyl cellusolve. Follow manufacturer's usage, handling and safety precautions.



WARNING: **PERSONAL INJURY**

To avoid injury from improper use of chemicals, follow the chemical manufacturer's usage, handling, and disposal instructions. Observe all manufacturer's cautions.

NOTICE:

Never use galvanized steel fuel tanks, fittings, pipes or supply lines. The fuel reacts chemically with the zinc coating to form powdery flakes that can quickly clog the fuel filters and damage the fuel pump and injectors.

Open the drain at the bottom of the fuel tank every 30,000 miles (48,280 kilometers) to drain off any water and/or sediment.

Every 120,000 miles (192,000 kilometers) or 12 months tighten all fuel tank mountings and brackets. At the same time, check the seal in the fuel tank cap, the breather hole in the cap and the condition of the flexible fuel lines. Repair or replace the parts, as necessary.

Item 3 – Fuel Lines, Flexible Hoses

A pre-start inspection of hoses and fuel lines is recommended.

Leaks — Make a visual check for fuel leaks at all engine-mounted fuel lines and connections, and at the fuel tank suction and return lines. Since fuel tanks are susceptible to road hazards, leaks in this area may best be detected by checking for an accumulation of fuel under the tank.

| |
|---|
|  WARNING: FIRE |
| To avoid injury from fire, contain and eliminate leaks of flammable fluids as they occur. Failure to eliminate leaks could result in fire. |

Leaks are not only detrimental to machine operation, but they can also result in added expense caused by the need to replace lost fluids.

Hoses and Fittings — Check hoses daily as part of the pre-start inspection. Examine hoses for leaks, and check all fittings, clamps and ties carefully. Make sure hoses are not resting on or touching shafts, couplings, heated surfaces including exhaust manifolds, any sharp edges,

or other obviously hazardous areas. Since all machinery vibrates and moves to a certain extent, clamps and ties can fatigue with age. To ensure continued proper support, inspect fasteners frequently and tighten or replace them as necessary. If fittings have loosened or cracked or if hoses have ruptured or worn through, take corrective action immediately.

Hose Service Life — A hose has a finite service life. With this in mind, all hoses should be thoroughly inspected at least every 500 operating hours (1,000 hours for fire-resistant fuel and lubricating oil hoses) and/or annually. Look for cover damage and/or indications of twisted, worn, crimped, brittle, cracked or leaking lines. Hoses with their outer cover worn through or with damaged metal reinforcements should be considered unfit for further service.

All hoses in and out of machinery should be replaced during major overhaul and/or after a maximum of five (5) years of service.

NOTE:

Fire-resistant fuel and lube oil hose assemblies do not require automatic replacement after five years of service or at major overhaul, but should be inspected carefully before being put back into service.

Item 4 – Cooling System

The cooling system must be *full* for proper operation of the engine.

| |
|--|
|  WARNING: HOT COOLANT |
| <p>To avoid scalding from the expulsion of hot coolant, never remove the cooling system pressure cap while the engine is at operating temperature. Wear adequate protective clothing (face shield, rubber gloves, apron, and boots). Remove the cap slowly to relieve pressure.</p> |

Check the coolant level daily and maintain it near the bottom of the filler neck on the radiator. On some installations this is done by checking an overflow bottle or sight glass. Add coolant as required, but do not overfill. Before adding coolant, refer to *How to Select Coolant* in this guide.

Coolant Level — Make a daily visual check for cooling system leaks. Look for an accumulation of coolant when the engine is running and when it is stopped. Coolant leaks may be more apparent on a engine when it is cold.

Coolant Inhibitors — The inhibitors in antifreeze solutions *must* be replenished with a non-chromate corrosion inhibitor supplement when indicated by testing the coolant. Refer to *How to Select Coolant* in this guide for required test intervals and inhibitor levels.

| |
|--|
| NOTICE: |
| <p>Coolant <i>must</i> be inhibited with the recommended SCAs listed in this guide. Failure to check and maintain SCA levels at required concentrations will result in severe damage (corrosion) to the engine cooling system and related components.</p> |

The cooling system is protected by a supplemental coolant additive (SCA) element. In addition, the engine can be equipped with a coolant filter/inhibitor system as an installed option or as an after-sale item.

Coolant Drain Interval — A coolant system properly maintained and protected with supplemental coolant inhibitors can be operated up to the intervals listed. At these intervals the coolant *must* be drained and disposed of in an environmentally responsible manner according to state and/or federal (EPA) recommendations.

Detroit Diesel recommends replacing coolant at the intervals listed in Table 15.

| Coolant Type | Coolant Replacement Interval |
|---|---|
| A 50/50 mix of <i>POWER COOL</i> ® fully formulated, inhibited ethylene glycol antifreeze and water or a 50/50 mix of fully formulated, inhibited propylene glycol antifreeze and water | With proper maintenance ¹ coolant can be operated 2 years, 300,000 miles (480,000 km), or 4,000 hours, whichever comes first. At this time the cooling system must be completely drained and cleaned before refill. |
| A 50/50 mix of phosphate-free TMC RP-329 "Type A" (propylene glycol) antifreeze and water. | With proper maintenance ¹ coolant can be operated for the life of the engine until overhaul. ² For life to overhaul, pre-charged coolant in combination with a need-release filter <i>must</i> be used. At this time the cooling system must be completely drained and cleaned before refill. |
| A 50/50 mix of OAT (organic acid technology) coolant and water. | With proper maintenance coolant can be operated 4 years, 600,000 miles (960,000 km), or 10,000 operating hours, whichever comes first. ³ At this time the cooling system must be completely drained and cleaned before refill. |

¹ Proper maintenance involves periodic evaluation using PowerTrac® 3-Way Coolant Test Strips and the addition of required SCA, as indicated by the test strip.

² To verify coolant acceptability, submit a sample to Detroit Diesel for coolant analysis every 3 years, 300,000 miles (480,000 km) or 6,000 operating hours, whichever comes first. Submit sample using PowerTrac coolant analysis kit, part number 23516921 (IEG/IPG coolant) or 23523398 (organic coolant).

³ OAT coolants require the addition of an extender every 2 years, 300,000 miles (480,000 km), or 5,000 hours, whichever comes first. Use 1 pint to 20 gallons of OAT coolant.

Table 15 Coolant Drain Intervals

Item 5 – Turbocharger, Air-to-Air Charge Cooler

Visually inspect the turbocharger mountings, intake and exhaust ducting and connections for leaks daily.

| |
|---|
|  WARNING: PERSONAL INJURY |
| <p>To avoid injury from hot surfaces, wear protective gloves, or allow engine to cool before removing any component.</p> |

Check the lube oil inlet and outlet lines for leaks or restrictions to oil flow. Check for unusual noise or vibration and, if excessive, stop the engine and do not operate until the cause is determined.

Periodically inspect the air-to-air charge cooler (if used) for buildup of dirt, mud, etc. and wash off. Check the charge cooler, ductwork, and flexible connections for leaks and have repaired or replaced, as required.

Check turbocharger heat-insulating exhaust system blankets (if used) for damage on a daily basis. Torn, matted, crushed, oil-soaked or otherwise damaged insulation blankets *must* be replaced immediately.

Wastegated Turbochargers —

The turbocharger wastegate actuator

is factory-calibrated and is not adjustable. Check actuator operation at the intervals shown in the maintenance schedule.

| |
|--|
|  WARNING: EYE INJURY |
| <p>To avoid injury from flying debris when using compressed air, wear adequate eye protection (face shield or safety goggles) and do not exceed 276 kPa (40 psi) air pressure.</p> |

Item 6 – Battery

Check the hydrometer “eye” of maintenance-free batteries for charge. See Figure 23.

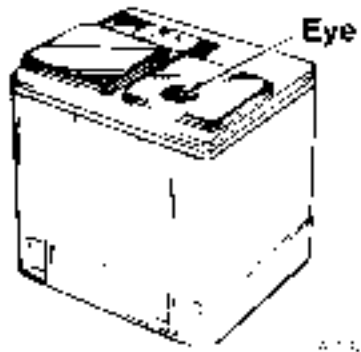

Figure 23 Maintenance-Free Battery “Eye”



WARNING:

PERSONAL INJURY

To avoid injury from accidental engine startup while servicing the engine, disconnect/disable the starting system.

If lead-acid or low-maintenance batteries are used, check the specific gravity of each cell every 150 operating hours. Check more frequently in warm weather due to the more rapid loss of water through evaporation.

Maintain the electrolyte level according to the battery manufacturer's recommendations, but *do not overfill*. Overfilling can cause poor battery performance or early failure.

Keep the terminal side of the battery clean. When necessary, wash with a solution of baking soda and water. Rinse with fresh water. Do not allow the soda solution to enter the cells.

Inspect the cables, clamps and hold-down brackets regularly. Clean and reapply a light coating of petroleum jelly when needed. Have corroded or damaged parts replaced.

If the engine is to be out of service for more than 30 days, remove the batteries and store in a cool, dry place. Keep batteries fully charged,

if possible. Replace any battery that fails to hold a charge.

Periodically check battery connections for corrosion and tightness. If necessary, remove connections and wire brush any corrosion from terminals and cable ends. Replace damaged wiring.

Item 7 – Aftertreatment System

There is a need to periodically remove accumulated ash, derived from engine lube oil, from the filter. This ash does not oxidize in the filter during the regeneration process and must be removed through a cleaning procedure. All Detroit Diesel ATD equipped engines will illuminate a dashboard warning lamp indicating the need for ash cleaning. Also inspect the ATD for wiring concerns (chaffing or melted) and loose connections.

Item 8 – Drive Belts

Belts should be neither too tight nor too loose. Belts that are too tight impose extra loads on the crankshaft, fan and/or alternator bearings, shortening both belt and bearing life. Excessively overtightened belts can result in crankshaft breakage. A loose belt will slip and may cause damage to accessory components.

| |
|---|
|  WARNING: PERSONAL INJURY |
| To avoid injury from rotating belts and fans, do not remove and discard safety guards. |

Use a belt tension gage, such as Kent-Moore® tool J 23586–B (V-belt), J 23600–B (poly-V belt), J 41251 (PowerBand® and 12-rib poly-V belt), or equivalent, when tensioning drive belts. Tension belts to the values listed in Table 16.

V-Belts — New standard V-belts will stretch after the first few hours

of operation. Tighten V-belts as listed in Table 16.

Run the engine for 10 to 15 minutes to seat the belts, then readjust tension. Check and retension belts after 1/2 hour and again after 8 hours or 250 miles (400 km) of operation. Thereafter, check the tension of the drive belts every 100 hours or 6,000 miles (10,000 km) and adjust, if necessary.

If a belt tension gage is not available, adjust the belt tension so that a firm push with the thumb, at a point midway between the two pulleys, will press the belt .50 in. – .75 in. (13 – 19 mm).

| Fan Drive | | |
|----------------------------------|---------------------------|-------------------|
| Single Belt | 2 or 3 Belts | |
| 80 – 100 lbs (356 – 445 N) | 60 – 80 lbs (267 – 356 N) | |
| Alternator Drive | | |
| Belt | New | Used |
| Two 1/2-in. V-Groove | 125 lbs (556 N) | 100 lbs (445 N) |
| 2-Groove PowerBand® | 200 lbs (890 N) | 150 lbs (667 N) |
| 12-Rib Poly-V (50 DN Alternator) | 350 lbs (1,557 N) | 250 lbs (1,112 N) |

Table 16 Drive Belt Tensioning

2-Groove PowerBand — A 8-rib belt is used with the 50 DN alternator for motorcoach applications. To provide proper running tension for the belt, current Series 60 engines use an auto belt tensioner, which requires no adjustment. See Figure 24.

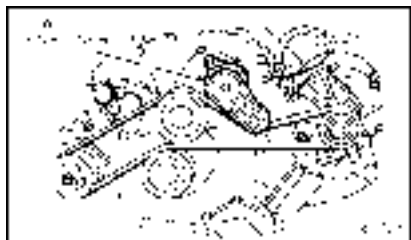

Figure 24 Auto Belt Tensioner Assembly with 50 DN Alternator

Tighten a new drive belt to 200 lbs (890 N), then run the engine for 10 minutes at 1200 rpm. Stop the engine and allow a 10 – 15 minute cool down period. Check tension. If less than 150 lbs (667 N), retension to 150 lbs (667 N). Following initial tensioning, measure belt tension every month or every 7,500 miles (12,000 km), whichever comes first. Retension belt to 150 lbs (667 N) at these intervals.

12-Rib Poly-V Belt — Tighten an 12-rib poly-V belt to 350 lbs (1,557 N), then run the engine at high idle for 30 minutes. Stop the engine and allow

a 10 – 15 minute cool down period. Check tension with tool J 41251-B or equivalent. If tension is 250 lbs (1,112 N) or more, no retensioning is required. If tension is less than 250 lbs (1,112 N), retension to 250 lbs (1,112 N). Measure belt tension every month or every 7,500 miles (12,000 km), whichever comes first. Retension to 250 lbs (1,112 N) as required.

Belt Replacement — Drive belts (V and poly-V) should be replaced every 2,000 hours or 100,000 miles (160,000 km).

Replace all belts in a set when one is worn. Single belts of similar size should not be used as a substitute for a matched belt set.

Premature belt wear can result because of belt length variation. All belts within a matched set are within .032 in. (0.8 mm) of their specified center distances.

When installing or adjusting an accessory drive belt, be sure the bolt at the accessory adjusting pivot point is properly tightened, as well as the bolt in the adjusting slot. In addition, check the torque on the alternator and bracket mounting bolts. Retighten as required.

Item 9 – Air Compressor

All air compressor intake parts should be removed and cleaned at 7,500 miles (12,000 km).

To clean either the hair type or the polyurethane type compressor air strainer element, saturate it and squeeze it in fuel oil or any other cleaning agent that is not detrimental to the element until it is dirt-free. Then saturate the element in lubricating oil and squeeze it dry before placing it back into the air strainer.

For air strainer replacement, contact the nearest servicing dealer. Replace hair type elements with the polyurethane type, if available.

The air compressor mounting bolts should be tightened every 12 months or 30,000 miles (48,280 km).

Item 10 – Air Cleaner

The air cleaner element should be inspected every 15,000 miles (24,000 km) or more often if the engine is operated under severe dust conditions.

Replace the element, if necessary. Check the gaskets for deterioration and replace, if necessary. If the dry type air cleaner is equipped with an aspirator, check for aspirator damage or clogging. Clean, repair or replace, as necessary.

NOTICE:

Do not allow the air inlet restriction to exceed 20 in. H₂O (5.0 kPa) under any engine operating conditions. A clogged air cleaner element will cause excessive intake restriction and reduced air supply to the engine resulting in increased fuel consumption, inefficient engine operation and reduced engine life.

Inspect the entire air system for leaks daily. Look especially for torn air inlet piping or boots and loose or damaged clamps. Have worn or damaged parts repaired or replaced, as required. Retighten loose connections.

Air Cleaner Replacement —

Dry type air cleaner elements should be replaced after one year of service or when the maximum allowable air intake restriction has been reached, whichever comes first. Refer to *When to Service the Dry Type Air Cleaner* in this guide for additional information.

Item 11 – Lubricating Oil Filters

Install new spin-on oil filters at a **maximum** of 30,000 miles (48,280 km). For city transit coach engines, install filters at a **maximum** of 6,000 miles (9,600 km).

Install the new filters, turning them until they contact the gasket fully with no side movement. Turn full-flow filters an additional 2/3 turn **by hand**, or as indicated on the filter. See Figure 25.

| |
|---|
|  WARNING: PERSONAL INJURY |
| To avoid injury from slipping and falling, immediately clean up any spilled liquids. |

Make a visual check of all lubricating oil lines for wear and/or chafing. If any indication of wear is evident, replace the oil lines and correct the cause.

Check for oil leaks after starting the engine.

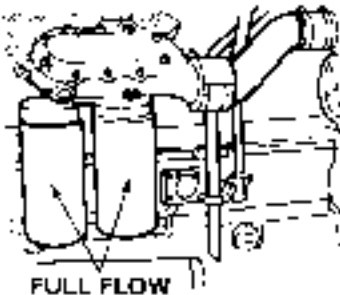

Figure 25 Lubricating Oil Filters

Item 12 – Fuel Filters

One method of determining when filters are plugged to the extent that they need replacing is based on the fuel pressure at the cylinder head fuel inlet fitting and the inlet restriction at the fuel pump.

In a clean system the maximum pump inlet restriction should not exceed 6 inches of mercury (20.3 kPa). In a dirty system it must not exceed 12 inches of mercury (41 kPa).

At normal operating speed and with the standard fuel pressure regulator, the fuel pressure is 55 – 70 psi (375 – 483 kPa).

Change the fuel filters whenever the inlet restriction at the pump reaches 12 inches of mercury (41 kPa) at normal operating speeds and whenever the fuel pressure at the inlet fitting falls to the minimum fuel pressure of 6 inches of mercury (20.3 kPa).

NOTE:

Filter change intervals may be shortened to conform with established preventive maintenance schedules, but should never be extended.

Fuel Pro® 382 Filters — Install new Fuel Pro® 382 primary fuel filter elements when the fuel level in the see-thru cover reaches the top of the element or after one year of service, whichever comes first.

Spin-On Filters — Install new spin-on primary and secondary fuel filter elements on vehicle engines every 15,000 miles (24,000 km) or every six months, whichever comes first. See Figure 26.

Replace spin-on filter elements immediately if plugging is indicated, regardless of mileage or hour intervals.

Item 13 – Water Pump and Coolant Inhibitor Element

Check the water pump and the coolant inhibitor element.

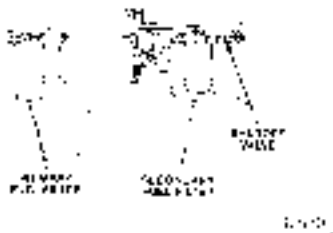

Figure 26 Spin-On Fuel Filter Locations

Water Pump Drain Hole — The water pump drain hole should be inspected every 6 months to make sure it is open. A small chemical build-up or streaking at the drain hole may occur. **This is not an indication of a defective water pump or seal.**

Remove the build-up with a mild detergent cleaner and a brush. If

coolant does not leak from the drain hole under normal conditions, do not replace the water pump.

Coolant Inhibitor Element — If the cooling system is protected by a supplemental coolant additive (SCA) element, the coolant must be tested at required intervals and the element replaced, if required. See Figure 27.

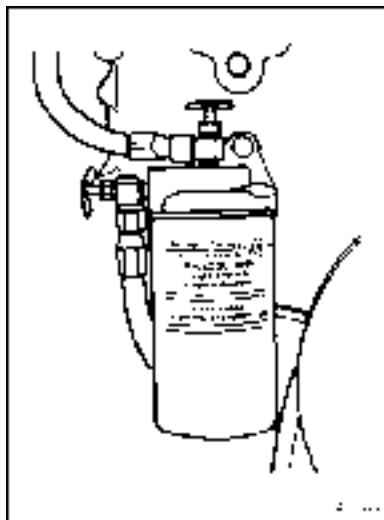

Figure 27 Coolant Inhibitor Element

Required test intervals are listed in Table 24.

For SCA test procedures refer to *How to Select Coolant* and *SCA Test Procedures* in this guide. Use the coolant filter element required. The valves mounted on the filter adaptor head *must* be opened after the element is replaced.

Item 14 – Cranking Motor

For cranking motor (starter) information, contact an authorized Delco Remy® or Bosch® service center, depending on manufacturer.

Item 15 – Air System

All the connections in the air system should be checked to make sure they are tight and leak free. Check all hoses and ducting for punctures, deterioration or other damage and replace, if necessary.

Item 16 – Exhaust System

Have the exhaust manifold retaining bolts and other connections checked for tightness. Have the exhaust pipe rain cap checked for proper operation, if so equipped.

Item 17 – Engine (Steam Clean)

Steam clean the engine and engine compartment every 60,000 miles (96,000 km) or 2,000 hours, whichever comes first.

NOTICE:

Do not apply steam or solvent directly to the battery-charging alternator, starting motor, DDEC components, sensors or other electrical components, as damage may result.

Item 18 – Radiator

The exterior of the radiator core should be inspected every 30,000 miles (48,280 km), 12 months, or 300 hours (industrial applications) and cleaned, if necessary.



WARNING:

EYE INJURY

To avoid injury from flying debris when using compressed air, wear adequate eye protection (face shield or safety goggles) and do not exceed 276 kPa (40 psi) air pressure.

Use a quality grease solvent, such as mineral spirits, and dry with compressed air. **Fuel oil, kerosene or gasoline should not be used.**

It may be necessary to clean the radiator more frequently if the engine is being operated in extremely dusty or dirty areas.

If the low coolant level sensor is installed in the top tank of the radiator, it should be tested for proper operation every 100,000 miles (160,000 km) or 12 months, whichever comes first. Authorized Detroit Diesel distributors are properly equipped to perform this service.

Item 19 – Oil Pressure

Under normal operation, oil pressure is noted each time the engine is started. In the event the equipment has warning lights rather than pressure indicators, the pressure should be checked and recorded every 60,000 miles (96,000 km).

Item 20 – Battery-Charging Alternator

Precautions must be taken when working on or around the alternator. The diodes and transistors in the alternator circuit are very sensitive and can be easily destroyed.

To avoid equipment damage, pay attention to the following:

| |
|--|
|  WARNING: Battery Explosion and Acid Burn |
| <p>To avoid injury from battery explosion or contact with battery acid, work in a well ventilated area, wear protective clothing, and avoid sparks or flames near the battery. If you come in contact with battery acid:</p> <ul style="list-style-type: none"> <input type="checkbox"/> Flush your skin with water. <input type="checkbox"/> Apply baking soda or lime to help neutralize the acid. <input type="checkbox"/> Flush your eyes with water. <input type="checkbox"/> Get medical attention immediately. |

- Avoid grounding the output terminal. Grounding an alternator's output wire or terminal (which is always "hot," regardless of whether or not the engine is running) and accidentally reversing the battery polarity will result in equipment damage.
- Do not reverse battery connections.
- Never disconnect the battery while the alternator is operating. Disconnecting the battery can result in damage to the battery diodes. In applications which have two (2) sets of batteries, switching from one set to the other while the engine is running

will momentarily disconnect the batteries.

- If a booster battery is to be used, batteries must be connected correctly (negative to negative, positive to positive).
- Never use a fast charger with the batteries connected or as a booster for battery output.

For information on the alternator assembly, contact an authorized Delco Remy® or Bosch® distributor, depending on manufacturer.

Bosch® T1 Alternator Service Requirements — The transistor regulator must be replaced every 100,000 miles (160,000 km) using kit part number 23524613 (includes regulator assembly and brushes). Front and rear bearings must be replaced every 200,000 miles (320,000 km) using kit 23524614 (includes bearings, seals and spacer ring). Authorized Bosch distributors have the parts, tools and trained personnel to perform these services.

General Service Requirements – Bosch® and Delco Remy® Alternators — Terminals should be checked for corrosion and loose connections and wiring inspected for damage and frayed insulation. Have wiring repaired or replaced, as required.

Check torque on alternator mounting bolts and bracketing every 15,000 miles (24,000 km). Retighten, if necessary.

Item 21 – Engine and Transmission Mounts

The engine and transmission mounting bolts and the condition of the mounting pads should be checked every 60,000 miles (96,000 km) or 600 hours. Tighten and/or repair as necessary.

Item 22 – Crankcase Pressure

The crankcase pressure should be checked and recorded every 60,000 miles (96,000 km) or 600 hours.

Item 23 – Fan Hub

If the fan bearing hub assembly has a grease fitting, use a hand grease gun to lubricate the bearings with one shot of quality lithium-base, multi-purpose grease every 100,000 miles (160,000 km).

Care should be taken not to overfill the bearing housing.

Item 24 – Thermostats and Seals

Replace the thermostats and seals every 240,000 miles (384,000 km) or 24 months, whichever comes first.

Item 25 – Crankcase Breather

The internally mounted (in the engine rocker cover) crankcase breather assembly (see Figure 28) *should be removed and the steel mesh pad washed in clean fuel oil every 250,000 miles (402,300 km).*



Figure 28 Internal Breather (in Rocker Cover)

Item 26 – Engine Tune-Up

There is no scheduled interval for performing an engine tune-up. However, the valve lash and injector heights *must* be measured and, if necessary, adjusted at the initial interval listed in Table 17.

Once the initial measurements/adjustments have been made, any adjustments beyond this point should be made only as required to maintain satisfactory engine performance.

| Engine Application | Measurement/Adjustment Period |
|--------------------|---|
| Vehicle Engines | 60,000 Miles (96,000 km) or 24 Months, whichever comes first |

Table 17 Initial Valve Lash and Injector Height Adjustment

Item 27 – Vibration Damper

The viscous vibration damper should be inspected periodically and replaced if dented or leaking. See Figure 29.

Heat from normal engine operation may, over a period of time, cause the fluid within the damper to break down and lose its dampening properties. For this reason the viscous vibration damper *must* be replaced at time of normal major engine overhaul, regardless of apparent condition.

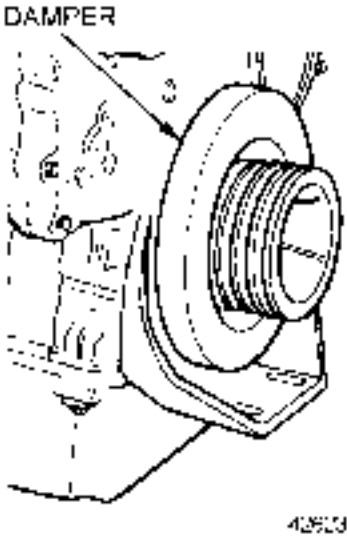

Figure 29 Viscous Vibration Damper

HOW-TO SECTION

This section covers Detroit Diesel's recommendations on how to select lubricating oil, diesel fuel, and coolant and includes basic engine maintenance procedures which can be performed by the operator.

NOTICE:

The manufacturer's warranty applicable to Series 60 engines provides in part that the provisions of such warranty shall not apply to any engine unit that has been subject to misuse, negligence or accident. Accordingly, malfunctions attributable to neglect or failure to follow the manufacturer's fuel or lubricating recommendations may not be within the coverage of the warranty.

How to Select Lubricating Oil

The selection of the proper lubricating oil is important to achieve the long and trouble-free service which Detroit Diesel engines are designed to provide. The proper lubricating oil for model year 2007 Series 60 engines is selected based on SAE viscosity grade and API (American Petroleum Institute) service designation. Only oils licensed to display the API symbol should be used. See Figure 30.

NOTICE:

Lubricating oil must have a sulfated ash level less than 1.0 wt %; currently referred to as CJ-4 oil.



47442

Figure 30 API Lubricant Symbol

Lubricant Requirements

API CJ-4 oils *must* be used in engines meeting January 2007, and later build, exhaust emission regulations.

Cold Weather Starting

At ambient temperatures below -20°C (-4°F) when sufficient starter speed cannot be achieved with SAE 15W-40 oils, the use of 5W-XX oils and 10W-XX oils (XX =30 or 40) is allowed to improve starting.

NOTICE:

Monograde oils should not be used in Series 60 engines, regardless of API service classification. Monograde oils gel at lower ambient temperatures, reducing lubricant flow, and do not provide adequate lubricity at higher engine operating temperatures resulting in severe engine damage.

The oils must be API CJ-4 that have demonstrated field performance in Detroit Diesel engines. These oils must possess a High Temperature / High Shear (HT/HS) of 3.7 minimum. For further information, refer to publication *Engine Requirements – Lubricating Oil, Fuel and Filters*, 7SE270, available from authorized Detroit Diesel distributors.

Synthetic Oils

Synthetic oils may be used in Detroit Diesel engines, provided they are API licensed and meet the performance and chemical requirements of non-synthetic oils outlined in this publication. Synthetic oils offer improved low-temperature flow properties and high-temperature oxidation resistance. However, they are generally more costly than non-synthetic oils.

Product information about synthetic oils should be reviewed carefully. Performance additive systems often respond differently in synthetic oils.

Their use does not permit extension of recommended oil drain intervals.

The Use of Supplemental Additives

Lubricants meeting the Detroit Diesel specifications outlined in this publication already contain a balanced additive treatment. Supplemental additives are generally not necessary and can even be harmful. These additives may be marketed as either oil treatments or engine treatments and are discouraged from use in Detroit Diesel engines.

Engine damage resulting from the use of such materials is not covered by your Detroit Diesel warranty.

Detroit Diesel will not provide statements beyond this publication relative to their use.

When to Change Oil

The length of time an engine may operate before an oil change depends upon the lubricant and fuel used, engine oil consumption, and the operating cycle.

**CAUTION:****USED ENGINE OIL**

To avoid injury to skin from contact with the contaminants in used engine oil, wear protective gloves and apron.

The maximum interval at which the engine may operate before the oil and filters must be changed is listed in Table 18.

Oil analysis may be used to determine whether this interval should be shortened, but it should not be used to lengthen the interval.

The use of fuels with sulfur content above 0.05 mass percent will require a shortening of drain intervals and/or the

use of a higher TBN oil. For detailed information refer to publication *Engine Requirements – Lubricating Oil, Fuel and Filters* (7SE270), available from authorized Detroit Diesel distributors.

Disposing of Waste Oil

Dispose of used lubricating oil and filters in an environmentally responsible manner, according to federal (EPA) and/or state recommendations. The disposal of waste oil may be best addressed by the engine oil supplier, who may accept responsibility for proper disposal of this material as part of the business of providing lubricant.

| Engine Application | Drain Interval |
|------------------------------------|--|
| Highway Truck & Motor Coach | 30,000 Miles (48,280 km) |
| Fire Truck or Crash/Rescue Vehicle | 6,000 Miles (9,600 km), 300 Hours or 1 Year, whichever comes first |

Table 18 Maximum Oil Drain and Filter Change Interval (Fuel Sulfur 15 ppm Weight Percent or Less)

How to Replace the Lube Oil Filters

Filters are an integral part of the lubricating oil system. Proper filter selection and maintenance are important to satisfactory engine performance and service life.

Filters should be used to maintain a clean system, not to clean up a contaminated system.

Replace Spin-On Type Oil Filter

Replace spin-on type filters (see Figure 31) as follows:

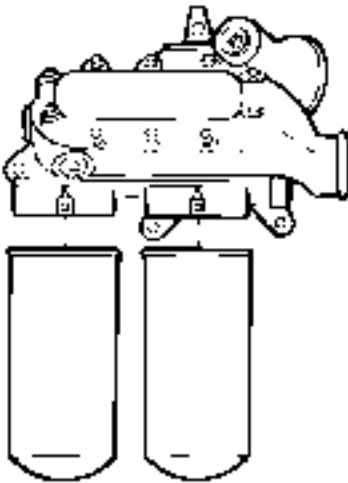

Figure 31 Spin-On Oil Filters



WARNING:

PERSONAL INJURY

To avoid injury from slipping and falling, immediately clean up any spilled liquids.

1. Place a suitable container under the engine oil pan, remove drain plug and drain the lubricating oil. Replace the drain plug and tighten securely.
2. Remove spin-on filters using tool J-29917 or equivalent and a 1/2-in. drive socket wrench and extension.
3. Dispose of used oil and filters in an environmentally responsible manner, according to federal (EPA) and/or state recommendations.
4. Clean the filter gasket-contact surface of the adaptor head with a clean, lint-free cloth.
5. Fill the new filters with clean lubricating oil and lightly coat the filter gaskets with the same oil.

NOTICE:

Overtightening the filter may crack or distort the filter adaptor.

6. Start the new filters on the adaptor head and tighten by hand until

the gaskets touch the mounting adaptor head. **Tighten filters an additional two-thirds turn by hand, or as indicated on the filter.**

7. Add oil as required to bring the level within the *satisfactory* range on the dipstick. See Figure 32.

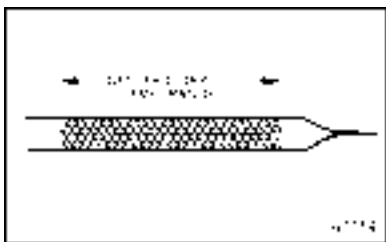



Figure 32 Check Oil Level

| |
|--|
|  WARNING: ENGINE EXHAUST |
| <p>To avoid injury from inhaling engine exhaust, always operate the engine in a well-ventilated area. Engine exhaust is toxic.</p> |

8. Start and run the engine for a short period and check for leaks. Then shut down the engine.
9. After any leaks have been corrected, stop the engine long enough for oil from various parts of the engine to drain back to the crankcase (approximately 20

minutes). Add oil as required to bring the level within the *satisfactory* range on the dipstick. See Figure 32.

NOTICE:

If the engine oil level is constantly above normal and excess lube oil has not been added to the crankcase, consult with an authorized Detroit Diesel service outlet for the cause. Fuel or coolant dilution of lube oil can result in serious engine damage.

How to Select Diesel Fuel

All 2007 diesel engines in 2007 are designed to operate on Ultra-Low Sulfur Diesel (ULSD) fuel, see Figure 33



Figure 33 ULSD Sticker

Quality

Fuel quality is an important factor in obtaining satisfactory engine performance, long engine life, and acceptable exhaust emission levels.

In general, fuels meeting the properties of ASTM designation D 975 (grades 1-D and 2-D) have provided satisfactory performance.

The fuels used must be clean, completely distilled, stable, and non-corrosive. For more information regarding the significance of these properties and selection of the proper fuel, refer to publication, *Engine Requirements – Lubricating Oil, Fuel and Filters* (7SE270), available from authorized Detroit Diesel distributors.

NOTICE:

Use only Ultra-Low Sulfur Diesel (ULSD) fuel (15 ppm sulfur content maximum), based on ASTM D2622 test procedure. Using fuel other than ULSD will damage the Aftertreatment Device.

Fuel Contamination

Generally, fuel contamination occurs as the result of improper fuel handling. The most common types of contamination are water, dirt, and microbial growth (“black slime”). The formation of varnishes and gums resulting from poor stability or

extended storage (“stale fuel”) also affects fuel quality. The best treatment for contamination is prevention by maintaining a clean storage system and choosing a reputable fuel supplier.

Supplemental additives are not recommended due to potential injector system or engine damage.

Our experience has been that such additives increase operating costs without providing benefit.

The use of supplemental fuel additives does not necessarily void the engine warranty. **However, repair expenses which result from fuel system or engine component malfunctions or damage attributed to their use will not be covered.**

These products should be accompanied by performance data supporting their merit. It is not the policy of Detroit Diesel to test, evaluate, approve or endorse such products.

Biodiesel — Biodiesel fuels meeting ASTM D 6751 specification, prior to blending can be mixed up to 5% maximum by volume in petroleum diesel fuel. Detroit Diesel highly recommends biodiesel fuels made from soybean or rapeseed oil through the proper transesterification reaction process. Other feedstock source of biodiesel fuels such as animal fat and used cooking oils are not

recommended by Detroit Diesel. The resulting mixture must meet ASTM D 975 specification. More information is available in the Detroit Diesel publication *Lubricating Oil, Fuel, and Filters* (7SE270).

Failures attributed to the use of biodiesel fuel will not be covered by Detroit Diesel product warranty. Also, any engine performance problem related to the use of biodiesel fuel would not be recognized nor considered Detroit Diesel's responsibility.

Prohibited Additives

The following fuel additives are not allowed and MUST NOT be mixed with diesel fuel:

Used Lubricating Oil — Do not use fuel blended with used lubricating oil. Detroit Diesel specifically prohibits the use of used lubricating oil in diesel fuel.

NOTICE:

Do not burn used lubricating oil in fuel. It will cause the diesel particulate filter to prematurely plug with ash.

Used lubricating oil contains combustion acids and particulate materials which can severely erode fuel injector components, resulting in

loss of power and increased exhaust emissions. In addition, the use of drained lubricating oil will increase maintenance requirements due to filter plugging and combustion deposits.

Fuel Additives with Sulfur or Sulfated Ash — Do not use non-approved fuel additives containing sulfur or sulfated ash.

Gasoline — The addition of gasoline to diesel fuel will create a serious fire hazard. The presence of gasoline in diesel fuel will reduce fuel cetane number and increase combustion temperatures.



WARNING:

FIRE

To avoid increased risk of a fuel fire, do not mix gasoline and diesel fuel.

Tanks which contain a mixture of gasoline and diesel fuel should be drained and cleaned as soon as possible.

Detroit Diesel will not be responsible for any detrimental effects it determines resulted from adding drained lubricating oil or gasoline to the diesel fuel.

How to Replace the Fuel Filters

Filters are an integral part of the fuel system. Proper filter selection and maintenance are important to satisfactory engine operation and service life. Filters should be used to maintain a clean system, not to clean up a contaminated system. Refer to the **Specifications** section of this guide for proper filter selection.

Spin-on type primary and secondary fuel filters are used on Series 60 engines.

The primary filter (marked "P") or combination filter and fuel/water separator removes large impurities from the fuel. The secondary filter (marked "S") removes the smaller particles.

The spin-on type filter consists of a shell, element and gasket unitized into a single cartridge and a filter adaptor which includes threaded inserts to accept the spin-on cartridges. See Figure 34.

An optional fuel/water separator may be installed in place of the standard primary filter.

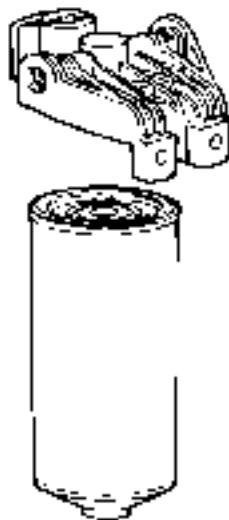

Figure 34 Typical Spin-On Type Fuel Filter

Replace Spin-On Type Primary or Secondary Fuel Filter Elements

Replace spin-on fuel filter elements as follows:

1. Shut down the engine and allow it to cool.
2. With the engine at ambient temperature and cool to the touch, place a suitable container under the filter.
3. If a fuel shutoff valve is installed on the discharge side of the secondary fuel filter, turn the

handle on the shutoff valve to the **closed** position (perpendicular to the valve).

8. Turn the handle on the shutoff valve to the **Open** position (in line with the valve).

NOTICE:

Have replacement filters filled with fuel and ready to install immediately. This prevents possible siphoning and fuel system aeration.

4. Using a suitable band type filter wrench, remove the primary and secondary fuel filters. Dispose of the filters in an environmentally responsible manner, according to federal (EPA) and/or state recommendations.
5. If not previously filled, fill new replacement filters with clean diesel fuel and coat the gaskets lightly with the fuel.
6. Thread the new filters onto the adaptor inserts until the gaskets make full contact with the adaptor head and no side movement is evident.

NOTICE:

Overtightening the filter may crack or distort the adaptors.

7. Tighten filters an additional one-half turn **by hand**, or as indicated on the filter.



WARNING:

ENGINE EXHAUST

To avoid injury from inhaling engine exhaust, always operate the engine in a well-ventilated area. Engine exhaust is toxic.

9. Start the engine and check for leaks. Shut down the engine. Correct any leaks with the engine off.

NOTICE:

Never use the starting motor and fuel pump to prime the fuel filters. Prolonged use of both to prime the fuel system can result in damage to the starter, fuel pump and injector.

If the engine fails to start after filter replacement, the fuel system will require priming with tool J 5956 (or equivalent). Authorized Detroit Diesel distributors are properly equipped to perform this service.

Replace Fuel/Water Separator Element

If an optional primary filter/water separator is installed, replace the element as follows:

1. Shut down the engine and allow it to cool.
2. With the engine at ambient temperature and cool to the touch, place a suitable container under the filter.
3. If a fuel shutoff valve is installed on the discharge side of the fuel/water separator, turn the handle on the shutoff valve to the **closed** position (perpendicular to the valve).
4. Drain off some fuel by opening the drain valve.
5. Using a strap wrench, remove the element and bowl together, then remove the bowl from the element. The filter and bowl have right-hand threads, so turn counter-clockwise to remove.
6. Clean the bowl and the O-ring seal.
7. Apply a light coating of clean fuel or grease to the O-ring seal, thread the bowl onto the new filter and tighten **by hand**.

NOTICE:

To avoid damaging the bowl or the filter, do not use tools when tightening.

8. Apply a light coating of clean fuel or grease to the new O-ring seal on the top of the filter. Thread the filter and bowl assembly onto the filter head and tighten **by hand** until snug.
9. To eliminate air from the filter, operate the primer pump on the filter head (if equipped) until the fuel purges at the filter assembly.
10. Start the engine and check for leaks. Shut down the engine. Correct any leaks with the engine off.

Replace Fuel Pro® 382/382E Fuel Filter Element

The Fuel Pro 382/383E diesel fuel filter system consists of a permanently mounted fuel processor, a replaceable filter element and sealing grommet assembly, a filter spring, a see-thru cover and seal, a cover collar, and a vent cap and seal. See Figure 35.

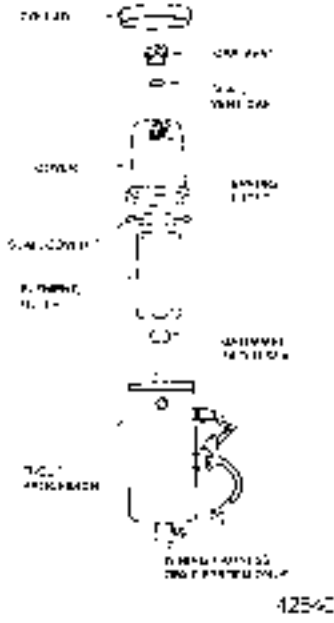

Figure 35 Fuel Pro 382E Fuel Processor Assembly

The system also includes a fuel heater element, thermostatic switch and wiring harness.

Replace the element as follows:

1. Shut down the engine and allow it to cool.
2. With the engine at ambient temperature and cool to the touch, place a suitable container under the filter.

3. A fuel shutoff valve may be installed on the discharge side of the fuel filter. If installed, turn the handle on the shutoff valve to the **closed** position (perpendicular to the valve).
4. Open the drain valve at the base of the fuel processor and drain the fuel until it is below the bottom of the filter in the see-thru cover. Close the drain valve. The fuel may be returned to the tank.
5. Using filter collar/vent cap wrench P/N: 38202 or equivalent, remove the collar by turning counter-clockwise. Remove the cover, filter spring and cover seal ring by lifting straight up and over the filter element.
6. Remove the element from the center stud (fuel outlet pipe) by pulling upward and twisting slightly.

NOTE:

Current filter elements include an integral sealing grommet. If a former element is replaced, make sure the separate sealing grommet is removed from the center stud before installing the new element.

7. Dispose of the used element and grommet in an environmentally responsible manner, according to federal (EPA) and/or state recommendations.

8. Check to make sure the sealing grommet is included in the base of the replacement filter element, then install the element onto the center stud by pushing down and twisting slightly.
9. Check to make sure the spring is installed at the top of the cover. If missing, this spring must be replaced to insure proper filter operation. Wipe the cover lip and cover seal clean.

NOTICE:

Do not use a wrench of any kind to tighten the collar. This may lead to overtightening, which can damage the collar and/or the cover.

10. After making sure the seal is properly positioned at the base of the cover, install the cover and collar onto the fuel processor. Tighten the collar **by hand** until secure.
11. Using filter collar/vent cap wrench 232002 or equivalent, remove the vent cap from the top of the cover by turning the cap counter-clockwise. Fill the cover full of clean fuel. After making sure the O-ring seal is installed on the vent cap, reinstall the cap and tighten **by hand**.

NOTICE:

To avoid cover or vent cap damage, do not use tools to tighten the vent cap.

12. Open the fuel shutoff valve (if installed) and start the engine. When the lubrication system reaches its normal operating pressure, increase engine speed to high idle for 2 to 3 minutes.

NOTICE:

Do not allow the fuel level in the see-thru cover to fall below the top of the collar, since this may lead to interruption of the fuel flow and engine stalling.

13. After the air is purged and with the engine still running, loosen the vent cap. The fuel level in the cover will start falling. When the fuel level falls to the top of the collar, tighten the vent cap quickly **by hand**.
14. Shut down the engine and tighten the collar again **by hand**. Restart the engine and check for leaks.

NOTE:

The filter cover will not fill completely during engine operation. It will gradually fill over time, and the fuel level will rise as the filter medium

becomes clogged. **The filter element does not require changing until the fuel level has risen to the top of the element, or after one year of service, whichever comes first.**

Engine Out of Fuel — How to Restart

When an engine has run out of fuel, there is a definite procedure to follow when restarting it.

NOTICE:

Never use the starting motor and fuel pump to prime the fuel filters. Prolonged use of the starting motor and fuel pump to prime the fuel system can result in damage to the starter, fuel pump and injectors.

Priming the engine with the starting motor and fuel pump causes erratic engine running due to the amount of air in the fuel lines and filters

Engines with Spin-On Filters

Use the following procedure for an engine with spin-on filters.

1. Fill the fuel tank with the recommended grade of fuel. If only partial filling is possible, add a minimum of 10 gallons (38 liters) of fuel to the tank.
2. Close the fuel shutoff valve (if installed) on the secondary filter

head and remove the spin-on fuel filters. Fill with clean fuel through the fuel inlet holes (the outer ring of small holes on the element) to insure the fuel is filtered.

3. Thread the elements onto the adaptor inserts until the gaskets make full contact with the adaptor head and no side movement is evident. Tighten filters an additional one-half turn **by hand**, or as indicated on the filter.
4. Open the fuel shutoff valve (if installed), start the engine and check for leaks. Shut down the engine before correcting leaks.

NOTE:

If the engine fails to start after replacement of fuel filters, the fuel system will require priming with tool J 5956 or equivalent. Authorized Detroit Diesel distributors are properly equipped to perform this service.

Engines with Fuel Pro Filters

Use the following procedure for an engine with Fuel Pro filters.

1. Remove the vent cap from the top of the filter by turning counter-clockwise. Fill the cover full of *clean* fuel.

NOTICE:

To avoid cover or vent dap damage, do not use tools to tighten the vent cap.

2. After making sure the O-ring seal is installed on the vent plug, reinstall the plug and tighten **by hand** only.

NOTICE:

Do not allow the fuel level in the see-thru cover to fall below the top of the collar, since this may lead to interruption of the fuel flow and engine stalling.

3. Start the engine and allow the lubrication system to reach its normal operating pressure, then increase engine speed to high idle for 2 to 3 minutes.
4. After the air is purged and with the engine still running, loosen the vent cap on the filter cover. The fuel level in the cover will start falling. When the fuel level falls to the top of the collar on the Fuel Pro cover, tighten the vent cap quickly **by hand**.

NOTE:

If the engine fails to start after replacement of fuel filters, the fuel system will require priming with tool

J 5956 or equivalent. Authorized Detroit Diesel distributors are properly equipped to perform this service.

How to Clean the Engine

Important: Observe all environmental protection regulations.

High-Pressure Cleaning Equipment

Information on suitable cleaning and protective products is available from any authorized dealer. Note the equipment manufacturer's operating instructions.

NOTICE:

To prevent damage to engine components, keep the water moving at all times while cleaning. Never direct water onto electrical components, plug connectors, seals or flexible hoses.



CAUTION:

To avoid injury, wear a face shield or goggles.

Comply with the minimum working distance between the high-pressure nozzle and the surface being cleaned:

- Approximately 28 inches (700 mm) for circular pattern jets
- Approximately 12 inches (300 mm) for 25-degree flat jets and dirt cutters

How to Clean the Cooling System

Important: Collect the used coolant, cleaning solutions, and washing liquids and dispose of them in an environmentally responsible manner.

Clean as follows:

| |
|--|
| NOTICE: |
| Clean at moderate pressures only to avoid damaging the radiator grille fins. |

| |
|--|
|  WARNING: EYE INJURY |
| To avoid injury from flying debris when using compressed air, wear adequate eye protection (face shield or safety goggles) and do not exceed 276 kPa (40 psi) air pressure. |

1. First remove debris (dust, insects, etc.) from the fins of the radiator grille.

2. Remove the debris by blowing them through with compressed air or spraying them out with water. Work from the rear of the radiator (in the opposite direction of the normal cooling air flow).
3. Drain the coolant when the engine is cold. For detailed procedures, see the vehicle/chassis maintenance manual. For types of coolant, refer to the “How to Select Coolant” section.
4. If the HVAC unit is connected to the cooling system, open the regulating valves all the way.

Degreasing

Degrease as follows:

1. Fill the cooling system with a 5% solution (1.6 ounces per quart of water—50 grams per liter) of a mildly alkaline cleaning agent, such as sodium carbonate.
2. Run the engine at moderate speed until the thermostat starts to open, at an operating temperature of approximately 80°C (176°F). Then run it for about five minutes longer. Shut down the engine and allow it to cool to approximately 50°C (112°F).



WARNING:
HOT COOLANT

To avoid scalding from the expulsion of hot coolant, never remove the cooling system pressure cap while the engine is at operating temperature. Wear adequate protective clothing (face shield, rubber gloves, apron, and boots). Remove the cap slowly to relieve pressure.

How to Select Coolant

This section covers selection of the required coolant for Series 60 engines.

Definitions

To help ensure complete understanding of the information, the definitions of the following terms are listed in Table 19.

3. Drain all the cleaning solution.
4. Flush the cleaning solution from the cooling system.
 - [a] Immediately after draining the cleaning solution, flush the system with clean water.
 - [b] Once the clean water has drained, fill the system again with clean water.
 - [c] Run the engine. Allow the engine to warm up to approximately 80°C (176°F), and then run it about five minutes longer.
 - [d] Drain the hot water.
5. Fill the cooling system with new coolant. For detailed procedures, see the vehicle/chassis maintenance manual. For types of coolant, refer to the “How to Select Coolant” section.

| Term | Definition |
|-----------------------------|---|
| Antifreeze | Ethylene glycol (EG) or propylene glycol (PG) containing a corrosion inhibitor package and which meets an appropriate heavy-duty specification (i.e., TMC RP-329 "Type A" for ethylene glycol or TMC RP-330 "Type A" for propylene glycol). |
| Coolant | The fluid mixture circulating in the engine cooling system, typically a mixture of 50% water and 50% antifreeze. |
| Drop-Out | Precipitated sludge or deposit formation on cooling system components. |
| Fully Formulated Antifreeze | Contains all the necessary inhibitors to protect a diesel engine, and does not, therefore, require a pre-charge of SCA before its first use. |
| Initial-Fill Coolant | The coolant that is used in a new or rebuilt engine, or any time the cooling system is emptied and then refilled with coolant. |
| OAT | Organic Acid Technology. An inhibitor system based on organic acid inhibitors, instead of traditional North American inhibitor formulations. |
| SCA | Supplemental Coolant Additive. SCAs are used in a preventive maintenance program to prevent corrosion, cavitation, and the formation of deposits. |

Table 19 Coolant Terms**Approved Coolants**

Required specifications for water, ethylene glycol, propylene glycol, inhibitor packages and inhibitor concentration are included in this section.

NOTICE:

To avoid engine damage from inadequate or over concentrated coolant, the required specifications must be adhered to before the coolant is replaced.

The approved and preferred coolants for Series 60 engines are listed in Table 20.

Once installed, these coolants should be maintained according to the procedures discussed under **Maintenance** in this section.

| Coolant Fill Option | Product |
|--|---|
| Ethylene Glycol & Water + Corrosion Inhibitors ¹ | DDC <i>Power Cool</i> |
| Commercial Equivalent of DDC <i>Power Cool</i> | Fully Formulated TMC RP-329 Type A Antifreeze & Water |
| Propylene Glycol & Water + Corrosion Inhibitors ¹ | DDC <i>Power Cool Plus</i> |
| Ethylene Glycol & Water + OAT Inhibitors | DDC <i>Power Cool Plus</i> |
| Water Only + Corrosion Inhibitors ² | Water + DDC <i>Power Cool</i> 3000 |
| Water Only + OAT Inhibitors ² | Water + DDC <i>Power Cool Plus</i> 6000 |

¹ Preferred Coolant

² Water-only coolant systems offer no freeze protection and should not be used where ambient temperatures can fall to 32° F (0° C).

Table 20 Initial Fill Coolant Options

EG & Water Plus SCA Inhibitor or P G & Water Plus SCA Inhibitor

— These products are available as fully formulated, phosphate-free, extended service interval (ESI) coolants. They are commercially available from Detroit Diesel (recommended) and other manufacturers as either a concentrated antifreeze or as a pre-mixed antifreeze. The pre-mixed antifreeze is ready for use, while the concentrated coolant must be mixed with water prior to use.

Detroit Diesel *Power Cool* engine coolant (P/N: 23512138) is the preferred ethylene glycol (EG)

coolant. If other commercial brands of ethylene glycol are used, they must be equivalent to the *Power Cool*. Detroit Diesel does not market a propylene glycol (PG) coolant. If a propylene glycol coolant is used, it must also meet the following requirements:

- Fully formulated ethylene glycol-based, low silicate antifreeze or coolant must meet TMC RP-329 “Type A” requirements.
- Fully formulated propylene glycol-based antifreeze or coolant

must meet TMC RP-330 “Type A” requirements.

Fully formulated antifreeze does not require a dosage of SCA prior to initial use.

Mixing EG or PG Antifreeze and Water — If a concentrated ethylene glycol (EG) or propylene glycol (PG) antifreeze is purchased, mix the antifreeze with water meeting the required quality standards listed in Table 23 and fill the cooling system.

If a pre-diluted, fully formulated coolant is purchased, fill the cooling system. For best overall performance, a coolant consisting of 50% concentration of antifreeze (50% antifreeze, 50% water) is *recommended*.

An antifreeze concentration over 67% (67% antifreeze, 33% water) is *not recommended* due to poor heat

transfer, reduced freeze protection (IEG only), and possible silicate dropout. An antifreeze concentration below 33% (33% antifreeze, 67% water) offers too little freeze and/or corrosion protection and is *not recommended*.

Always verify that the freeze point and nitrite concentration of the antifreeze/water mixture are correct by using a *POWER Trac*® 3-Way Coolant Test Strip. If chemical analysis is used, elements in the coolant must fall within the limits listed in Table 21.

Recycled Antifreeze — Antifreeze or coolant recycled by reverse osmosis, distillation, and ion exchange, properly re-inhibited to meet TMC RP-329 Type A or TMC RP-330 Type A requirements, has been demonstrated to provide service equivalent to virgin antifreeze.

| Fully Formulated Glycol Coolant Concentration Limits | |
|--|----------------|
| Boron | 125 – 500 PPM |
| Nitrite | 900 – 3200 PPM |
| Nitrate | 200 – 1000 PPM |
| Silicon | 50 – 250 PPM |
| Phosphorous | 0 PPM |
| pH | 8.0 – 11.0 |

Table 21 Fully Formulated Glycol Coolant Limits with TMC RP-329, TMC RP-330 Chemistry Type A (50/50 Coolant/Water Mixture)

Recycled antifreeze or coolants of these types are *preferred*. Other recycled coolants, especially coolants recycled through filtration processes, are *not recommended*.

EG/Water + OAT Inhibitor or PG/Water + OAT Inhibitor —

Ethylene glycol and propylene glycol are also available with a OAT corrosion package. These coolants require less maintenance over the useful life of the engine. OAT coolants, maintained as detailed in the **Maintenance** section of this guide, may be operated up to 4 years, 600,000 miles (960,000 km), or 10,000 operating hours, whichever comes first. Refer to *Coolant Inhibitor Test Intervals* in this guide. The cooling system should either be equipped with a blank coolant filter, or the coolant filter and piping may be omitted from the system.

OAT fully formulated antifreezes are available as concentrated and pre-mixed. Concentrated antifreezes should be mixed 50% (50% antifreeze, 50% water).

OAT coolants should not be mixed with conventional coolants. If they are mixed, no damage will result, but the long-life advantages of the OAT coolant will be lost. In this event, the coolant should be maintained as a fully formulated IEG coolant, not as

an OAT (Organic Acid Technology) coolant.

Detroit Diesel markets a OAT-inhibited ethylene glycol coolant, DDC *Power Cool Plus*, which contains all the required additives. If a non-DDC OAT antifreeze is used, it must conform to TMC 338 specification. *Do not add extender to new OAT antifreeze or coolant.*

Water Only + SCA or Water Only + OAT Inhibitor —

In warm climates a coolant based on water with corrosion inhibitors is approved for use. Water-only systems need to be treated with the proper dosage of corrosion inhibitors. Detroit Diesel-approved SCAs or OAT corrosion inhibitors *must* be added to the water to provide required corrosion and cavitation erosion protection. OAT inhibitors such as *Power Cool Plus 6000* are available for water-only systems. Inhibitor should be mixed at 7.5% – 10% by volume with water. For a list of *Power Cool* products, refer to section *SPECIFICATIONS* in this guide. Traditional SCA (*Power Cool 3000*) can also be used to protect the engine. *Power Cool 3000* concentration limits are listed in Table 22.

NOTE:

Do not use Power Trac 3-Way Test Strips to test OAT coolant.

| Power Cool 3000 Coolant Concentration Limits | |
|---|----------------|
| Boron | 125 – 500 PPM |
| Nitrite | 900 – 3200 PPM |
| Nitrate | 200 – 1000 PPM |
| Silicon | 50 – 250 PPM |
| Phosphorous | 0 PPM |
| pH | 8.0 – 11.0 |

Table 22 Power Cool 3000 Concentration Limits (5% Power Cool 3000/ 95% Water)

POWER COOL® 3000 SCA inhibitors should be mixed at 5% by volume with water. This is 1 quart per 5 gallons of water. These additions can be made by adding liquid SCAs available in a variety of sizes. Coolant filters are also available for different cooling system capacities. These filters release the proper amount of SCA at initial fill.

Water Requirements —

Distilled, reverse osmosis-purified,

or de-ionized water which eliminates the adverse effects of minerals in tap water is preferred.

High levels of dissolved chlorides, sulfates, magnesium, and calcium in some tap water causes scale deposits and/or corrosion resulting in water pump failures and poor heat transfer, leading to overheating. If tap water is used, the mineral content in the water must be below the maximum allowable limits listed in Table 23.

| | Maximum Allowable | |
|---|--------------------------|--------------------------|
| | Parts per Million | Grains per Gallon |
| Chlorides | 40 | 2.5 |
| Sulfates | 100 | 5.8 |
| Total Dissolved Solids | 340 | 20 |
| Total Hardness – Magnesium and Calcium | 170 | 10 |

Table 23 Satisfactory Water Limits – Make-Up Water Only

NOTICE:

Do not add additional SCA to new, fully formulated antifreeze or coolant. This can result in dropout and/or the formation of deposits.

Coolants Not Recommended

The following coolants are *not recommended* for use in Detroit Diesel engines.

All Antifreezes And Coolants Containing Phosphate — These coolants are not recommended. Drop out, overheating and water pump seal failures can result from the use of coolant or inhibitor packages based on phosphate.

Automotive Type Coolants — These coolants generally contain high levels of phosphate and silicate, offer no liner pitting protection, and are *not suitable* for use in Detroit Diesel engines.

Methyl Alcohol-Based Antifreeze — This must not be used because of its effect on the non-metallic components of the cooling system and its low boiling point.

Glycol-based Coolants Formulated For HVAC —

These coolants formulated for Heating/Ventilation/Air Conditioning (HVAC) should not be used. These coolants generally contain high levels of phosphates, which can deposit on hot internal engine surfaces and reduce heat transfer.

Additives Not Recommended

The following additives are *not recommended* for use in Series 60 engines.

Soluble Oil Additives — These additives are not approved for use in Detroit Diesel engine cooling systems. A small amount of oil adversely affects heat transfer. For example, a 1.25% concentration of soluble oil increases fire deck temperature 6%. A 2.50% concentration increases fire deck temperature 15%. The use of soluble oil additives may result in engine overheating and/or failure.

Chromate Additives — These additives are not approved for use in Detroit Diesel engine cooling systems. Chromate additives can form chromium hydroxide, commonly called “green slime.” This, in turn, can result in engine damage due to poor heat transfer. Cooling systems operated with chromium-inhibited coolant must be chemically cleaned

with *Power Cool* dry chemical cooling system cleaner/conditioner listed in Table 33 (or equivalent sulfamic acid/sodium carbonate cleaner) and flushed.

Coolant Inhibitor Test Intervals

The coolant inhibitor level should be checked at the intervals listed in Table 24.

| |
|--|
|  WARNING: HOT COOLANT |
| <p>To avoid scalding from the expulsion of hot coolant, never remove the cooling system pressure cap while the engine is at operating temperature. Wear adequate protective clothing (face shield, rubber gloves, apron, and boots). Remove the cap slowly to relieve pressure.</p> |

If topping off is needed, add coolant which is identical to the initial fill coolant.

| Service Application | Inhibitor Test Interval |
|--|---|
| On-Highway Trucks and Motor Coaches | 20,000 Miles (32,000 Kilometers) |
| Pick-Up and Delivery, Short Trip, and Emergency Vehicles | 6,000 Miles (9,600 Kilometers) or 3 Months, whichever comes first |

Table 24 Required Coolant Inhibitor Test Intervals

Supplemental Coolant Additives for Fully Formulated Coolant

— The concentrations of some inhibitors will gradually deplete during normal engine operation. SCAs replenish the protection for cooling system components. The coolant *must* be maintained with the proper concentration of SCA. Detroit Diesel *Power Cool* maintenance SCAs are recommended.

The proper application of SCA will provide:

- pH control.
- Restored inhibitor levels to prevent corrosion.
- Water softening to deter formation of mineral deposits.
- Cavitation protection to protect wet sleeve cylinder liners.

Maintenance Intervals — Check intervals listed in Table 25 with a the nitrite concentration at the regular *Power Trac* 3-Way Test Strip.

| Coolant | Interval ¹ | Action |
|---|--|--|
| Antifreeze / Water + SCA Inhibitor (DDC <i>Power Cool</i>) | 20,000 Miles (32,000 km) or 3 Months* | Test nitrite concentration with test strip. Add SCA or dilute coolant as needed. |
| | 300,000 Miles (480,000 km) | Drain and clean system. Refill with new coolant. |
| Ethylene Glycol / Water + SCA Inhibitor or Propylene Glycol / Water + SCA Inhibitor | 20,000 Miles (32,000 km) or 3 Months* | Test nitrite concentration with test strip. Add SCA or dilute coolant as needed. |
| | 300,000 Miles (480,000 km) | Drain and clean system. Refill with new coolant. |
| Ethylene Glycol / Water + OAT Inhibitor or Propylene Glycol / Water + OAT Inhibitor | Test at 1 Year. | — |
| | 300,000 Miles (480,000 km) or 2 Years* | Add <i>Power Cool</i> Plus Extender |
| | 600,000 Miles (960,000 km) | Drain and clean system. Replace with new coolant. |
| Water Only + SCA Inhibitor | 20,000 Miles (32,000 km) or 3 Months* | Test nitrite concentration with test strip. Add SCA or dilute coolant as needed. |
| | 300,000 Miles (480,000 km) | Drain and clean system. Replace with new coolant. |
| Water Only + OAT Coolant | 300,000 Miles (480,000 km) or 2 Years* | Add <i>Power Cool</i> Plus Extender |
| | 600,000 Miles (960,000 km) | Clean and drain. Replace with new coolant. |

¹ Maintenance interval based on application. Drain interval dependent on proper maintenance.

Table 25 Coolant Maintenance Intervals

Nitrite levels *must* be within the ranges listed in Table 21.

NOTICE:

Always maintain concentrations of SCA at recommended levels. Failure to properly maintain coolant with SCA can result in damage to the cooling system and its related components, over-concentration of SCA inhibitor can result in poor heat transfer and engine damage. *Do not use traditional SCAs with OAT coolant.*

Additional SCA *must* be added to the coolant when it becomes depleted, as indicated by a nitrite concentration of 900 PPM or less. *If the nitrite concentration is greater than 900 PPM, do not add additional SCA.* If the nitrite concentration is above 3200 PPM, the system is over-inhibited and should be partially drained and filled with a 50/50 mix of water and EG or PG.

In this case the EG or PG should contain no inhibitors and should conform to ASTM D4985. This will dilute the over-concentrated inhibitors.

NOTE:

In non-OAT systems, nitrite concentration of 5000 PPM or higher on a Series 60 engine suggests problematic additive over-concentration. This condition *must* be corrected by immediate draining and flushing of the cooling system. Refill the system with new fully formulated or pre-charged coolant. Check the nitrite concentration level at the next maintenance interval with a Power Trac 3-Way Test Strip.

SCA Test Procedures

Detroit Diesel Power Trac 3-Way Coolant Test Strips should be used to measure nitrite and glycol concentrations. Part numbers are listed in Table 34. Cavitation/corrosion is indicated on the strip by the level of nitrite concentration. Freeze/boil over protection is determined by glycol concentration.



WARNING:

HOT COOLANT

To avoid scalding from the expulsion of hot coolant, never remove the cooling system pressure cap while the engine is at operating temperature. Wear adequate protective clothing (face shield, rubber gloves, apron, and boots). Remove the cap slowly to relieve pressure.

For best results make the test while the coolant is between 50° – 140° F (10.0° – 60° C). Wait at least 60, but not longer than 75, seconds before reading the nitrite level. Use the test strips as follows:

1. Dip the strip into coolant for one second. Remove and shake briskly to eliminate excess fluid.
2. Immediately compare the pad end (% glycol) to the color chart on the container.
3. Sixty seconds (one minute) after dipping, compare the nitrite pad to the color chart.
4. Color change of the additive indicator (middle pad) indicates the presence of inhibitor that is not approved by Detroit Diesel.

Promptly replace and tighten the test strip container cap after each use.

Discard unused strips if they have turned light pink or tan.

A factory coolant analysis program is available through authorized Detroit Diesel service outlets. Part numbers are listed in Table 34 in the **Specifications** section. To verify coolant acceptability, submit a sample for coolant analysis every two (2) years, 300,000 miles (480,000 km), or 10,000 operating hours, whichever comes first.

Coolant Filters (Non-OAT Systems)

Spin-on coolant filters are available for Detroit Diesel engines. Membranes in the filters release SCAs before the coolant approaches a corrosive condition, protecting the engine from corrosion. The elements release the SCA charge as needed, as opposed to the maintenance SCA elements, which instantaneously release the SCA charge. Coolant filter elements should be replaced after one (1) year, 120,000 miles (192,000 km) or 2,000 operating hours, whichever comes first.

Dropout

Excessive amounts of some inhibitors in the coolant can cause a gel or crystalline deposit that reduces heat transfer and coolant flow. The deposit, called "dropout," takes the color of the coolant when wet, but appears as a white or gray powder when dry. It can pick up solid particles in the coolant and become gritty, causing excessive wear of water pump seals and other cooling system components.

| |
|--|
|  WARNING: PERSONAL INJURY |
| To avoid injury when using caustic cleaning agents, follow the chemical manufacturers usage, disposal, and safety instructions. |

The wet gel can be removed by using a non-acid (alkali) type heavy-duty cleaner, such as Detroit Diesel *Power Cool On-Line Cleaner* (sodium nitrite/sodium tetraborate). Part numbers are listed in Table 33.

NOTE:

If the gel is allowed to dry, it is necessary to disassemble the engine and clean it with a caustic solution or physically clean individual components.

Coolant Extender Inhibitor Additive for "OAT" Coolant

The inhibitors in OAT coolant must also be maintained, but less often than traditional SCA-type coolants. A portable test is available to test the levels of OAT inhibitors in coolant. Where this is not used, fleet testing has determined that a OAT coolant extender package should be added to the coolant at 300,000 miles (480,000 km), two (2) years, or 5,000 hours, whichever comes first. The proper maintenance dosages for all OAT coolants are listed in Table 25, reflecting 0.6% by volume extender. This dosage should be added to the water-only and the glycol systems at the same interval.

The proper application of extender to OAT coolant will provide:

- pH Control
- Restored inhibitor levels to prevent corrosion
- Cavitation protection to protect wet sleeve cylinder liners

NOTE:

Do not use traditional SCAs in OAT coolant, and do not use OAT extender in traditional coolant.

OAT Coolant Drain Interval —

A properly maintained OAT-inhibited coolant will last 600,000 miles (960,000 km), four (4) years, or 10,000 operating hours, whichever comes first. At this time the coolant should be drained, and the cooling system should be thoroughly cleaned, flushed, and filled with new, properly inhibited OAT coolant.

Chronic Coolant System Problems

The most commonly seen coolant system problems result from maintenance and formulation factors such as:

- Hard water
- Dilution of the coolant by the addition of untreated water
- Over dosage or under dosage of corrosion inhibitors
- Improper corrosion inhibitor (most often phosphated)
- Mixing SCAs
- Improper testing

Detroit Diesel Cooling System Maintenance Products

The following products are available to do maintenance on the cooling system.

Power Cool SCAs — *Power Cool*

SCAs are water-soluble chemical compounds. These products are available in coolant filter elements, liquid packages, and in fully formulated *Power Cool* antifreeze.

NOTE:

Power Cool 3000 liquid SCA is more compatible with hard water than Power Cool 2000 SCA.

Power Cool Coolant Filter Elements —

Power Cool coolant filter elements (spin-on canisters) are available in various sizes suitable for cooling systems of varying capacities. Selection of the proper element size is vital when pre-charging non-fully formulated coolant at initial fill and at maintenance intervals. **A fully formulated antifreeze must not have SCA added at initial fill. Do not use SCA-containing filters with OAT antifreeze or coolant.** The need for maintenance elements is determined by the results of the nitrite concentration test performed at each cooling system interval. *Do not automatically install maintenance elements at maintenance intervals, unless the nitrite concentration falls below 900 parts per million.*

Power Cool Cleaners — *Power Cool* Liquid On-Line Cleaner is used for light deposits. *Power Cool* Dry Chemical Cleaner/Conditioner is used for heavy deposits or scale.

Summary of Coolant Recommendations

 **WARNING:**
HOT COOLANT

To avoid scalding from the expulsion of hot coolant, never remove the cooling system pressure cap while the engine is at operating temperature. Wear adequate protective clothing (face shield, rubber gloves, apron, and boots). Remove the cap slowly to relieve pressure.

1. Always maintain the engine coolant to meet Detroit Diesel specifications.
2. Only use water that meets the specifications listed in Table 23. Distilled, de-mineralized (reverse osmosis) or de-ionized water is preferred.
3. The proper dosage of inhibitors *must* be included in the coolant at initial fill for all Detroit Diesel engines. This dosage is usually included in the fully formulated antifreeze used, or it may need to

be added if water alone or if less than 50% antifreeze is used. *The user is urged to refer to the full text of this section to determine the proper dosage.* Mixing of different manufacturers' technologies (brands) could cause cooling system problems.

4. Maintain the inhibitor at the prescribed concentration. Test the nitrite concentration by using a titration kit or Detroit Diesel Power Trac 3-Way Coolant Test Strips. Add SCA only if the nitrite concentration is below 900 PPM. *Do not use SCA in OAT coolant, and do not use Power Trac 3-Way Coolant Test Strips to test OAT coolant.*

NOTE:

If the nitrite concentration exceeds 3,200 PPM, the coolant must be drained and replaced with new coolant. A thorough cleaning of the cooling system may be required.

5. Do not use another manufacturer's test kit to measure the SCA concentration of Detroit Diesel maintenance products.
6. Pre-mix coolant makeup solutions to the proper concentration before adding to the cooling system.
7. Do not mix OAT and other coolants in the same engine.

8. Do not use automotive coolants.
9. Where antifreeze/boil over protection is required, use only antifreeze that meets TMC RP-329 "Type A" (EG) or TMC RP-330 "Type A" (PG) specifications. Always maintain coolant at the proper level.
10. Do not use the following in Detroit Diesel engine cooling systems:
 - Soluble oil
 - High silicate, automotive-type antifreeze
 - Chromate SCAs
 - Methoxy propanol-base coolant
 - Methyl alcohol-base coolant
 - Sealer additives or coolant containing sealer additives.
 - HVAC coolant
 - Phosphated coolants

Coolant life of Glycol Coolant —

A properly maintained cooling system, filled with phosphate-free coolant consisting of a 50/50 mix of antifreeze and water per TMC RP-329 "Type A" (EG) or TMC RP-330 "Type A" (PG) specifications can be operated to the limits recommended. The proper maintenance involves periodic evaluation using Power Trac

3-Way Coolant Test Strips and the addition of SCA as needed, indicated by the strip test. To verify coolant acceptability, submit a sample for coolant analysis every 300,000 miles (480,000 km), three (3) years, or 5,000 operating hours, whichever comes first. Submit the sample in a DDC Power Trac Coolant Test Bottle. Required part numbers are listed in Table 34.

Coolant Life of OAT Coolant —

A properly maintained OAT coolant may be operated 600,000 miles (960,000 km), four (4) years, or until overhaul, whichever comes first. At this time the system *must* be completely drained, thoroughly cleaned, and refilled. OAT Coolants require the addition of an extender at 300,000 miles (480,000 km), two (2) years, or 5,000 hours, whichever comes first. Use 1 pint of extender for every 20 gallons of coolant.

Coolant Life of Other Coolants —

Other properly maintained coolants may be operated up to 250,000 miles (480,000 km), two (2) years, or 4,000 operating hours, whichever comes first. At this time the system *must* be completely drained, thoroughly cleaned, and refilled.

How to Drain and Flush the Cooling System

Drain and flush the cooling system as follows:

| |
|--|
|  WARNING: HOT COOLANT |
| <p>To avoid scalding from the expulsion of hot coolant, never remove the cooling system pressure cap while the engine is at operating temperature. Wear adequate protective clothing (face shield, rubber gloves, apron, and boots). Remove the cap slowly to relieve pressure.</p> |

1. With the engine cool, drain the previous solution from the engine and radiator. Dispose of the coolant in an environmentally friendly manner, according to state and/or federal (EPA) recommendations.
2. Refill the cooling system with clean, soft water and a good cooling system cleaning compound, such as those listed in Table 33 in the **Specifications** section. If the engine is warm, fill slowly to prevent the rapid cooling and distortion of the metal castings.
3. Start the engine and operate it for fifteen minutes to circulate the solution thoroughly.
4. Stop the engine and allow it to cool.
5. With the engine cool, drain the cooling system completely.
6. Refill the cooling system with clean, soft water and operate it for fifteen minutes.
7. Stop the engine and allow it to cool.
8. With the engine cool, drain the cleaner residue from the cooling system.
9. Refill the system with the required coolant. Refer to section How to Select Coolant.
10. Entrapped air must be purged after filling the cooling system. To do this, allow the engine to warm up without the pressure cap installed. With the transmission in neutral, increase engine speed above 1000 RPM and add coolant as required. Install the pressure cap after the coolant level has stabilized at the bottom of the radiator filler neck.

NOTICE:

If the engine overheats and the coolant level is satisfactory, the cooling system may require cleaning with a descaling solvent and backflushing. Authorized Detroit Diesel service outlets are properly equipped to perform these services.

In addition to the cleaning procedure, other components of the cooling system should be checked periodically to keep the engine operating at peak efficiency.

Hoses

Cooling system hoses should be inspected and any hose that shows obvious signs of damage or feels abnormally soft or hard should be replaced. Damaged clamps should also be replaced. All external leaks should be corrected as soon as detected.

NOTE:

If Detroit Diesel **Power Cool** antifreeze/coolant (or equivalent fully formulated, precharged antifreeze is used, a precharge element is not required. Coolant inhibitor levels *must* be checked at the intervals listed in Table 24.

When to Service the Dry Type Air Cleaner

Replace dry type air cleaner elements when the maximum allowable air cleaner restriction (20 inches of water or 5.0 kPa) has been reached or annually, whichever comes first. Some air cleaners are equipped with a restriction indicator which aids in determining the servicing interval.

Cleaning and/or reusing dry paper type air cleaner elements is not recommended unless the cleaning method used removes clogging without damaging the element. Inspection and cleaning of elements *must* be done in accordance with the air cleaner manufacturer's recommendations, if any.

TROUBLESHOOTING

This section covers basic troubleshooting of engine operation or performance malfunctions and their probable causes. In addition to operating the engine carefully and

maintaining it properly make sure to correct any malfunction promptly.

Abnormal Coolant Temperature

| Abnormal Coolant Temperature Symptoms and Probable Causes | | |
|--|---------------------|---------------------|
| Probable Causes | Above Normal | Below Normal |
| Restricted cooling system passages | X | — |
| Restricted radiator core passages | X | — |
| Slipping fan drive belts | X | — |
| Faulty temperature-controlled fan | X | — |
| Obstruction in front of radiator or intercooler | X | |
| Low coolant level | X | — |
| Damaged hoses | X | — |
| Faulty thermostats | X | — |
| Faulty water pump | X | — |
| Faulty radiator pressure cap | X | — |
| Air in coolant | X | — |
| Thermostats not fully closed | — | X |
| Leakage around thermostat seals | — | X |
| Faulty temperature-controlled fan | — | X |

Hard Starting

| Hard Starting Symptoms and Probable Causes | | | |
|---|------------------------|--------------------|----------------------------------|
| Probable Causes | Engine Will Not Rotate | Low Cranking Speed | Engine Cranks But Will Not Start |
| Low Battery Voltage | X | X | — |
| Loose cranking motor connections | X | — | — |
| Faulty cranking motor | X | X | — |
| Faulty cranking motor switch | X | X | X |
| Internal seizure | X | — | — |
| Improper lube oil | — | X | — |
| Circuit breaker/electronic control malfunction | — | — | X |
| Fuse blown or missing | — | — | X |
| Insufficient Fuel Supply | | | |
| Air in fuel | — | — | X |
| Out of fuel | — | — | X |
| Loose fuel connections | — | — | X |
| Cracked fuel lines | — | — | X |
| Obstructed fuel filters/lines | — | — | X |
| Faulty fuel pump | — | — | X |
| Faulty injector operation | — | — | X |
| Restricted fuel fitting missing | — | — | X |
| DDEC Malfunction | — | — | X |
| Installation/operation of fuel check valve or shutoff valve | — | — | X |
| Low Compression | | | |
| Worn intake and exhaust valves | — | — | X |
| Worn piston rings/liners | — | — | X |

| Hard Starting Symptoms and Probable Causes | | | |
|---|-------------------------------|---------------------------|---|
| Probable Causes | Engine Will Not Rotate | Low Cranking Speed | Engine Cranks But Will Not Start |
| Leaking cylinder head gasket | — | — | X |
| Improper intake or exhaust valve adjustments | — | — | X |

Aftertreatment System

Engines that meet the EPA 2007 emissions standards are equipped with an Aftertreatment System that prevents 95% of the particulate matter (soot) from leaving the exhaust. This will eliminate the use of visible smoke diagnostics unless there is a system failure issue. White smoke or steam at start up or during cold weather operation is still a characteristic of engine operation. Abnormal amounts of black/blue smoke may merit further investigation.

Abnormal Engine Operation

| Abnormal Engine Operation Symptoms and Probable Causes | | | |
|---|---|------------------|-------------------|
| Probable Causes | Rough Running or Frequent Stalling | Low Power | Detonation |
| Misfiring cylinder | X | X | — |
| Insufficient fuel | X | X | — |
| High return fuel temperature | X | X | — |
| Low compression | X | X | — |
| DDEC malfunction | X | X | — |
| High air inlet restriction/exhaust back pressure | — | X | — |
| Engine application | — | X | — |
| High air inlet temperature | — | X | — |
| High altitude operation | — | X | — |
| Incorrect engine gear train timing | — | X | — |
| Low coolant temperature | — | — | X |
| Oil picked up by inlet airstream | — | — | X |
| Faulty injector operation | — | — | X |
| Incorrect injector height setting | — | X | X |

Abnormal Operating Conditions

| Abnormal Operating Condition Symptoms and Probable Causes | | |
|--|----------------------------------|-------------------------|
| Probable Causes | High Lube Oil Consumption | Low Oil Pressure |
| Loose connections | X | — |
| Cracked lines | X | — |
| Damaged gaskets or seal rings | X | — |
| * Lube oil loss at breather tube | X | — |
| * Lube oil loss at dipstick tube | X | — |
| Leaking oil cooler | X | — |
| Leaking valve stem seals | X | — |
| Worn/broken oil control rings | X | |
| Scored liner and/or piston | X | — |
| Excessive engine installation angle | X | — |
| Crankcase overfilled | X | — |
| Oil in air tanks (air compressor malfunction) | X | — |
| Plugged crankcase breather | X | — |
| Oil level low | — | X |
| Improper engine oil viscosity (fuel in the oil) | — | X |
| Faulty oil pressure regulator valve | — | X |
| Worn crankshaft, camshaft or connecting rod bearings | — | X |
| Missing cup plugs in rocker arm shafts | — | X |
| Faulty oil pressure relief valve | — | X |
| Air leaks in oil pump (suction side) | — | X |
| Worn or damaged oil pump | — | X |
| Faulty oil pressure gage | — | X |
| Faulty electrical components (for gage) | — | X |
| Plugged oil line or orifice | — | X |

* Indicates high crankcase pressure

ENGINE STORAGE

When an engine is to be stored or removed from operation for a period of time, special precautions should be taken to protect the interior and exterior of the engine, transmission and other parts from rust accumulation and corrosion. The parts requiring attention and the recommended preparations are given below.

Preparing Engine for Storage

It will be necessary to remove all rust or corrosion completely from any exposed part before applying rust preventive compound. Therefore, it is recommended that the engine be processed for storage as soon as possible after removal from operation.

The engine should be stored in a building that is dry and can be heated during the winter months. Moisture-absorbing chemicals are available commercially for use when excessive dampness prevails in the storage area.

Temporary Storage (30 Days or Less)

To protect the engine for a temporary period of time (30 days or less), follow this procedure:

1. With the engine at ambient temperature and cool to the touch, drain engine crankcase oil into a suitable container. Dispose of the oil in an environmentally friendly manner, according to state and/or federal (EPA) recommendations.
2. Fill the crankcase to the proper level with the recommended viscosity and grade of oil.
3. Fill the fuel tank with the recommended grade of fuel oil. Operate the engine for two (2) minutes at 1200 rpm and no load. **Do not drain the fuel system or the crankcase after this run.**
4. Check the air cleaner and service it, if necessary.
5. If freezing weather is expected during the storage period, check the antifreeze/coolant for required freeze and inhibitor protection. Add antifreeze solution to the cooling system in accordance with Detroit Diesel's

recommendations. Refer to *How to Select Coolant* in this guide.

NOTE:

If an antifreeze solution is not required during storage, flush the cooling system with a good soluble oil (3% – 5% by volume) rust inhibitor to prevent rusting of the outside diameter of the cylinder liners.

**WARNING:****EYE INJURY**

To avoid injury from flying debris when using compressed air, wear adequate eye protection (face shield or safety goggles) and do not exceed 276 kPa (40 psi) air pressure.

6. Clean the exterior of the engine (except electrical parts) with fuel oil and dry with compressed air.
7. Seal all engine openings. The material used must be waterproof, vaporproof and possess sufficient physical strength to resist puncture and damage from the expansion of entrapped air.

An engine prepared in this manner can be returned to service in a short time by removing the seals at the engine openings and by checking the engine coolant, fuel oil, lubricating oil and transmission oil levels.

Extended Storage (More than 30 Days)

To prepare an engine for extended storage (more than 30 days), follow this procedure:

1. Drain the cooling system and flush with clean, soft water. Refill with clean, soft water and add a rust inhibitor to the cooling system.
2. Circulate the coolant by operating the engine until normal operating temperature is reached.
3. Stop the engine.
4. With the engine at ambient temperature and cool to the touch, drain the engine crankcase oil into a suitable container. Remove the oil filters. Dispose of the oil and filters in an environmentally friendly manner, according to state and/or federal (EPA) recommendations. Replace the drain plug and tighten to 45 – 50 N·m (33 – 37 lb-ft) torque.
5. Install new lubricating oil filters. Fill the crankcase to the proper level with Tectyl® 930A preservative lubricating oil or an equivalent 30-weight preservative lubricating oil meeting Mil-L-21260C, Grade 2 Specification.
6. Drain the fuel tank. Refill with enough clean No. 1 diesel fuel to

permit the engine to operate for about ten (10) minutes. If draining the fuel tank is not convenient, use a separate, portable supply of recommended fuel.

NOTE:

If engines are stored where condensation of water in the fuel tank may be a problem, additives containing methyl carbitol or butyl cellusolve may be added to the fuel. Follow manufacturer's instructions for treatment. Where biological contamination of fuel may be a problem, add a biocide such as Biobor® JF (or equivalent) to the fuel. When using a biocide, follow the manufacturer's concentration recommendations and observe all cautions and warnings.

7. Drain the fuel system and remove the fuel filters. Dispose of used filters in an environmentally responsible manner, according to state and/or federal (EPA) recommendations. Fill the new filters with No. 1 diesel fuel or pure kerosene and install on the engine.
8. Operate the engine for five (5) minutes to circulate the clean fuel throughout the engine. Be sure the engine fuel system is full.
9. Stop the engine and allow to cool. Then disconnect the fuel

return line and the inlet line at the primary filter and securely plug both to retain the fuel in the engine.

10. **Transmission:** Follow the manufacturer's recommendations for prolonged storage.
11. **Power Take-Off:** If equipped, follow manufacturer's recommendations for prolonged storage.

NOTICE:

Failure to properly seal off the turbocharger air inlet and exhaust outlet openings before engine storage may permit air drafts to circulate through the turbocharger and rotate the turbine/compressor shaft without an adequate flow of lubricating oil to the center housing bearings resulting in severe bearing damage.

12. **Turbocharger:** Since turbocharger bearings are pressure lubricated through the external oil line leading from the oil filter adaptor while the engine is operating, no further attention is required. However, the turbocharger air inlet and turbine exhaust outlet connection should be sealed off with moisture-resistant tape.

13. Apply a non-friction rust preventive compound to all exposed engine parts. If convenient, apply the rust preventive compound to the engine flywheel. If not, disengage the clutch mechanism to prevent the clutch disc from sticking to the flywheel.

NOTE:

Do not apply oil, grease or any wax-base compound to the flywheel. The cast iron will absorb these substances, which can "sweat" out during operation and cause the clutch to slip.

14. Drain the engine cooling system. If the engine will be exposed to freezing temperatures, install genuine Detroit Diesel *Power Cool* antifreeze or an equivalent ethylene glycol-base or propylene glycol-base antifreeze solution that provides the required freeze, boil over and inhibitor protection. Refer to *How to Select Coolant* in this guide.
15. Drain the preservative oil from the engine crankcase. Reinstall and torque the 3/4" – 14 square, magnetic drain plug to 45 – 50 N·m (33 – 37 lb-ft).
16. Remove and clean the battery and battery cables with a baking soda-water solution and rinse with fresh water. Do not allow the soda solution to enter the battery. Add distilled water to the electrolyte (if necessary) and fully charge the battery. Store the battery in a cool (never below 0° C or 32° F) dry place. Keep the battery fully charged and check the level and specific gravity of the electrolyte regularly.
17. Insert heavy paper strips between the pulleys and drive belts to prevent sticking.
18. Seal all engine openings, including the exhaust outlet, with moisture-resistant tape. Use cardboard, plywood or metal covers where practical.
19. Clean and dry the exterior painted surfaces of the engine and spray with a suitable liquid automobile body wax, a synthetic resin varnish, or a rust preventive compound.
20. Protect the engine with a good weather-resistant tarpaulin and store it under cover, preferably in a dry building which can be heated during the winter months.

Outdoor storage of the engine is not recommended. If units must be kept out of doors, follow the preparation and storage instructions already given. Protect units with quality, weather-resistant tarpaulins (or other suitable covers) arranged to provide for air circulation.

NOTICE:

Do not use plastic sheeting for outdoor storage. Enough moisture can condense on the inside of the plastic to rust ferrous metal surfaces and pit aluminum surfaces. If a unit is stored outside for any extended period of time, severe corrosion damage can result.

NOTE:

Plastic is fine for indoor storage.

The stored engine should be inspected periodically. If there are any indications of rust or corrosion, corrective steps must be taken to prevent damage to the engine parts. Perform a complete inspection at the end of one year and apply additional treatment as required.

Procedure for Restoring to Service an Engine that Has Been in Extended Storage

If an engine has been in extended storage, prepare it for service as follows:

1. Remove the covers and tape from all the openings of the engine, fuel tank and electrical equipment. Do not overlook the exhaust outlet.
2. Remove the plugs from the inlet and outlet fuel lines and reconnect the lines to their proper positions.
3. Wash the exterior of the engine with fuel oil to remove the rust preventive. **Do not wash electrical components.**
4. Remove the rust preventive from the flywheel. Flush any soluble oil rust inhibitor (if used) in the cooling system.
5. Remove the paper strips from between the pulleys and drive belts.
6. Fill the crankcase to the proper level with the required grade of lubricating oil. Use a pressure lubricator to insure all bearings and rocker shafts are lubricated.
7. Fill the fuel tank with the required fuel.
8. Close all drain cocks and fill the engine cooling system with clean,

soft water and required inhibitors. If the engine is to be exposed to freezing temperatures, install genuine Detroit Diesel **Power Cool** antifreeze or an equivalent ethylene glycol-base or propylene glycol-base antifreeze solution which provides required freeze, boil over, and inhibitor protection. Refer to section How to Select Coolant.

9. Install and connect the battery. Make sure the average specific gravity of the battery is 1.260 or higher. Charge the battery, if necessary.
10. Service the air cleaner, if required.
11. **Transmission:** Follow the manufacturer's recommendations covering the return of the transmission to service.
12. **Power Take-Off:** If equipped, follow the manufacturer's recommendations covering the return of the power take-off to service.
13. **Turbocharger:** Remove the covers from the turbocharger air inlet and turbine outlet connections. Reconnect piping as required. Pre-lube the turbocharger center bearing housing. Refer to Lubrication System Checks in the *OPERATING INSTRUCTIONS*

FOR STARTING THE ENGINE section of this guide.



WARNING:

ENGINE EXHAUST

To avoid injury from inhaling engine exhaust, always operate the engine in a well-ventilated area. Engine exhaust is toxic.

14. After all preparations are completed, start the engine.

NOTE:

The small amount of rust preventive which remains in the fuel system will cause smoky exhaust for a few minutes.

NOTE:

Before subjecting the engine to a load or high speed, allow it to reach normal operating temperature.

15. Check for trouble codes.
 - [a] If there are no codes, perform a parked regeneration.
 - [b] If there are codes, repair what is necessary then perform a parked regeneration.

CUSTOMER ASSISTANCE

The satisfaction and goodwill of the owners of Detroit Diesel engines are of primary concern to Detroit Diesel and

its distributor/dealer organizations. See Figure 36 for Detroit Diesel NAFTA On-Highway service regions.



Figure 36 Detroit Diesel NAFTA On-Highway Service Regions

NAFTA ON-HIGHWAY SERVICE REGIONS

DETROIT DIESEL REGIONAL SALES OFFICES

NORTHEAST REGION

Detroit Diesel Corporation
Powder Mill Plaza, Suite 3A
51 Gibraltar Drive
Morris Plains, NJ 07950-1274
Phone: 973-492-6555
Fax: 973-267-5922

CENTRAL REGION

Detroit Diesel Corporation
9255 Indian Creek Parkway, Suite 850
Overland Park, KS 66210
Phone: 678-570-2389

SOUTHERN REGION

Detroit Diesel Corporation
3325 Paddocks Parkway, Suite 230
Suwanee, GA 30024
Phone: 678-341-6100
Fax: 678-341-6150

WESTERN REGION

Detroit Diesel Corporation
7700 Irvine Center, Suite 275
Irvine CA 92618
Phone: 949-753-7710
Fax: 949-753-7711

CANADA REGION

Detroit Diesel of Canada, Ltd.
150 Dufferin Ave., Suite 701
London ON N5A 5N6
Phone: 519-661-0149
Fax: 519-661-0171

DETROIT DIESEL REGIONAL SERVICE OFFICES

NORTH EASTERN REGION

Detroit Diesel Corporation
13400 Outer Drive West
Detroit, MI 48239-4001
Telephone: 313-592-5420
Fax: 311-592-5887

NORTH CENTRAL & WESTERN REGIONS

Detroit Diesel Corporation
7700 Irvine Center, Suite 275
Irvine CA 92618
Phone: 949-753-7710
Fax: 949-753-7711

SOUTHERN REGION

Detroit Diesel Corporation
3325 Paddocks Parkway, Suite 230
Suwanee, GA 30024
Phone: 678-341-6100
Fax: 678-341-6150

CANADA REGION

Detroit Diesel of Canada, Ltd.
150 Dufferin Ave., Suite 701
London ON N5A 5N6
Phone: 519-661-0149
Fax: 519-661-0171

MEXICO REGION

Detroit Diesel Allison de Mexico, S.A.
Av. Santa Rosa 58
Col. Ampliacion Norte
San Juan Ixtacala, Tlanepantla
C.P. 54160, Edo de Mexico
Phone: 525-333-1802
Fax: 525-333-1870

Road Service in the U.S. or Canada

If you require road service for any reason in the U.S. or Canada, you may call the **1-800-445-1980** customer assistance phone number. An operator will assist you in determining what type of service is required. Not all problems are engine related and not all problems are covered by engine or vehicle warranties. *YOU MAY BE RESPONSIBLE FOR REPAIR EXPENSES.*

Before calling Customer Assistance, please do the following:

- Check coolant level
- Check fuel level
- Check DDEC fuses
- Check for fuel leaks
- Make sure manual shutoff valve (if installed) on the fuel filter adaptor, fuel processor body or fuel supply line is open.
- Check the oil level on the dipstick.
- Check diagnostic codes.

If you call, have the following information available:

- Engine serial number
- Vehicle make and model
- Odometer mileage (kilometers) or hourmeter hours

- Vehicle owner/company name

Working with Detroit Diesel Service Outlets

As the owner of a Detroit Diesel product you have a complete network of Detroit Diesel service outlets in the U.S. and Canada, plus many outlets worldwide that are prepared to meet your parts and service needs:

- Service by trained personnel.
- Sales team to help determine your specific power requirements.
- In many areas, emergency service 24 hours a day.
- Complete parts support, including reliabilT® remanufactured components.
- Product information and literature.

We recognize however, that despite the best intentions of everyone concerned, misunderstandings may occur. Normally, any situation that arises in connection with the sale, operation or service of your product will be handled by the authorized service outlet in your area (in the U.S. and Canada, check the Yellow Pages or service locator at www.detroitdiesel.com for Detroit Diesel service outlet nearest you).

Detroit Diesel has established a three-step procedure that customers should follow when experiencing a problem with any Detroit Diesel Product or Part. Detroit Diesel fully realizes that ultimately the customer's concerns will be resolved at the Distributor/Dealer level and therefore encourages customers to follow the procedure outlined below:

Step One

Customers should discuss the problem with a member of management from the authorized service outlet. Frequently, complaints are the result of a breakdown in communication and can quickly be resolved by a member of management. If they have already discussed the problem with the Distributor or Dealer Sales or Service Manager, they should contact the General Manager.

Step Two

When it appears that the problem cannot readily be resolved at the Distributor/Dealer level without additional assistance, the Detroit Diesel Customer Support Center (CSC) should be contacted at 313-592-5800.

The information provided to the CSC will be forwarded to the appropriate Regional Product Support Manager. The customer will then be assisted

be a member of the Regional Product Support Managers staff, depending on the nature of his/her problem.

Prior to this contacting the CSC, the customer should have the following information available:

- Name and location of authorized service outlet
- Type, make and vehicle identification number of equipment
- Engine model and serial number
- Engine delivery date and accumulated miles/kilometers or hours of operation
- Nature of problem
- Chronological summary of engine's repair history

Step Three

If the customer is still not satisfied, he/she should present the entire matter in writing or by phone to:

Director of Technical Service or Manager, Service Operations BX5

Detroit Diesel Corporation
13400 Outer Drive, West
Detroit, Michigan 48239-4001
Phone: 313-592-5000
Fax: 313-592-5888

SPECIFICATIONS

This section lists the various *POWER COOL* engine products.

Center (313-592-5800) if you need this specific information.

Fuel and Lubricating Oil Filters

Consult with a Detroit Diesel Distributor to obtain the proper fuel filters and lubricating oil filters.

POWER COOL ENGINE PRODUCTS

Maintenance of the cooling system requires the chemical make-up of the system to be balanced.

OIL PAN CAPACITY

Engine oil capacity can vary, depending on the oil pan used and the engine application. Contact the Detroit Diesel Customer Support

POWER COOL Fully Formulated IEG Coolant

The part numbers and sizes of concentrated *POWER COOL* and pre-blended 50:50 *POWER COOL* are listed in Table 26.

| Coolant Type | Part Number | Description |
|----------------------|-------------|-----------------------------------|
| Concentrated | 23512138 | 1 Gallon Jug – 6 Per Case |
| | 23512139 | 55 Gallon Drum |
| | 23529295 | 330 Gallon Tote |
| | 23512140 | Bulk Delivery – 1,000 Gallon Min. |
| Pre-Blended 50:50 | 23528203 | 1 Gallon Jug – 6 Per Case |
| | 23518918 | 55 Gallon Drum |
| | 23528544 | 330 Gallon Tote |
| | 23513503 | Bulk Delivery – 1,000 Gallon Min. |

Table 26 *POWER COOL* Fully Formulated IEG Coolant

**POWER COOL 2000 and 3000
Supplemental Coolant Additive**

| Coolant Type | Part Number | Description |
|-----------------------------------|-------------|------------------------------|
| For <i>Power Cool</i> IEG Coolant | 23507858 | Pint Bottle – 12 Per case |
| | 23507859 | Half Gallon Jug – 6 Per Case |
| | 23507860 | 5 Gallon Pail |
| | 23507861 | 55 Gallon Drum |

Table 27 POWER COOL 2000 Supplemental Coolant Additive

| Coolant Type | Part Number | Description |
|-----------------------------------|-------------|------------------------------|
| For <i>POWER COOL</i> IEG Coolant | 23507854 | Pint Bottle – 12 Per Case |
| | 23507855 | Half Gallon Jug – 6 Per Case |
| | 23507856 | 5 Gallon Pail |
| | 23507857 | 55 Gallon Drum |

Table 28 POWER COOL 3000 Supplemental Coolant Additive

**POWER COOL 3000
Supplemental Additive Coolant
Filters**

| Coolant Type | Part Number | Description |
|-----------------------------------|-------------|-------------------------------|
| For <i>POWER COOL</i> IEG Coolant | 23507545 | 4 Ounce (1 Pint Equivalent) |
| | 23508425 | 8 Ounce (2 Pint Equivalent) |
| | 23508426 | 12 Ounce (3 Pint Equivalent) |
| | 23507189 | 16 Ounce (4 Pint Equivalent) |
| | 23508427 | 32 Ounce (8 Pint Equivalent) |
| | 23508428 | 53 Ounce (13 Pint Equivalent) |

Table 29 POWER COOL 3000 Supplemental Additive Coolant Filters

POWER COOL Supplemental Additive Need Release Coolant Filters

| Coolant Type | Part Number | Description |
|-----------------------------------|-------------|---------------------------|
| For <i>POWER COOL</i> IEG Coolant | NF2091 | For 0 – 8 Gallon Systems |
| | 23516489 | For 8 – 20 Gallon Systems |

Table 30 POWER COOL Supplemental Additive Need Release Coolant Filters

POWER COOL Plus Extended Life OAT Coolant

| Coolant Type | Part Number | Description |
|-------------------|-------------|-----------------------------------|
| Concentrated | 23519397 | 1 Gallon Jug – 6 Per Case |
| | 23519394 | 55 Gallon Drum |
| | 23519395 | Bulk Delivery – 1,000 Gallon Min. |
| Pre-Blended 50:50 | 23519396 | One Gallon Jug – 6 Per Case |
| | 23519398 | 55 Gallon Drum |
| | 23519399 | Bulk Delivery – 1,000 Gallon Min. |

Table 31 POWER COOL Plus Extended Life OAT Coolant

POWER COOL Plus Extender For Use With POWER COOL Plus OAT Coolant

| Coolant Type | Part Number | Description |
|----------------------------|-------------|---------------------------|
| For <i>Power Cool Plus</i> | 23519400 | Quart Bottle – 6 Per Case |

Table 32 POWER COOL Plus Extender for Use with POWER COOL Plus OAT Coolant

POWER COOL Cooling System Cleaners

| Coolant Type | Part Number | Description |
|-----------------|-------------|---------------------------------|
| On-Line Cleaner | 200164 | On-Half Gallon Jug – 6 Per Case |
| | 200105 | 5 Gallon Pail |
| | 200155 | 55 Gallon Drum |
| Twin Pack | 201549 | Twin Pack – 2 Per Case |

Table 33 POWER COOL Cooling System Cleaners

POWER TRAC Coolant Testing And Analysis Products

| Application | Part Number | Description |
|--|-------------|--|
| Indicates Nitrite, Molybdate & Glycol Levels | 23519401 | 3-Way Coolant Test Strips (Single Foil Packs) |
| Indicates Nitrite, Molybdate & Glycol Levels | 23519402 | 3-Way Coolant Test Strips (Bottle of 50) |
| Indicates Nitrite, Molybdate & Glycol Levels | 23522774 | 3-Way Coolant Test Strips (Bottle of 10) |
| Complete IEG/IPG Coolant Analysis | 23516921 | Coolant Analysis Bottle (Carton of 6) |
| Organic Coolant Analysis | 23523398 | Laboratory Coolant Analysis Bottle (Carton of 6) |

Table 34 Power Trac Coolant Testing and Analysis Products